

DATA SHEET



Three Phase Induction Motor - Squirrel Cage

Customer :								
Product line	: NEMA Premium Efficiency Three-Phase	Product code :	13923290					
		Catalog # :	02536ST3QIE284TSC-W2					
Frame	: 284/6TSC	Cooling method	: IC411 - TEFC					
Insulation class	: F	Mounting	: F-1					
Duty cycle	: Cont.(S1)	Rotation ¹	: Both (CW and CCW)					
Ambient temperature	: -20°C to +40°C	Starting method	: Direct On Line					
Altitude	: 1000 m.a.s.l.	Approx. weight ²	: 391 lb					
Protection degree	: IP55	Moment of inertia (J)	: 2.69 sq.ft.lb					
Design	: B							
Output [HP]	25	20	20	20	25	25	25	
Poles	2	2	2	2	2	2	2	
Frequency [Hz]	60	50	50	50	50	50	50	
Rated voltage [V]	460	380	400	415	380	400	415	
Rated current [A]	28.8	27.9	26.8	26.1	34.9	33.3	31.8	
L. R. Amperes [A]	181	173	185	193	171	183	191	
LRC [A]	6.3x(Code G)	6.2x(Code G)	6.9x(Code H)	7.4x(Code J)	4.9x(Code E)	5.5x(Code F)	6.0x(Code G)	
No load current [A]	8.00	8.00	8.50	9.00	8.00	8.50	9.00	
Rated speed [RPM]	3545	2945	2950	2955	2910	2930	2935	
Slip [%]	1.53	1.83	1.67	1.50	3.00	2.33	2.17	
Rated torque [ft.lb]	37.0	35.7	35.6	35.5	45.0	44.8	44.7	
Locked rotor torque [%]	200	200	229	240	160	180	190	
Breakdown torque [%]	250	240	280	300	200	220	240	
Service factor	1.25	1.00	1.00	1.00	1.00	1.00	1.00	
Temperature rise	80 K	80 K	80 K	80 K	105 K	105 K	105 K	
Locked rotor time	30s (cold) 17s (hot)	25s (cold) 14s (hot)	25s (cold) 14s (hot)	25s (cold) 14s (hot)	25s (cold) 14s (hot)	25s (cold) 14s (hot)	25s (cold) 14s (hot)	
Noise level ²	72.0 dB(A)	67.0 dB(A)	67.0 dB(A)	67.0 dB(A)	67.0 dB(A)	67.0 dB(A)	67.0 dB(A)	
Efficiency (%)	25%	90.8	89.0	89.4	88.9	91.5	91.5	90.8
	50%	91.0	90.2	90.3	89.8	91.0	91.0	91.0
	75%	91.7	90.7	91.1	91.1	90.2	91.0	91.0
	100%	91.7	91.9	91.9	91.9	89.5	90.2	91.0
Power Factor	25%	0.55	0.55	0.52	0.49	0.61	0.58	0.55
	50%	0.79	0.79	0.77	0.75	0.83	0.81	0.80
	75%	0.86	0.86	0.85	0.83	0.88	0.87	0.86
	100%	0.88	0.89	0.88	0.87	0.90	0.89	0.89
Bearing type	: Drive end : 6311 C3	Non drive end : 6211 C3	Foundation loads					
Sealing	: Inpro/Seal	Inpro/Seal	Max. traction	: 272 lb				
Lubrication interval	: 14000 h	17000 h	Max. compression	: 663 lb				
Lubricant amount	: 18 g	11 g						
Lubricant type	: Mobil Polyrex EM							
Notes								
This revision replaces and cancel the previous one, which must be eliminated. (1) Looking the motor from the shaft end. (2) Measured at 1m and with tolerance of +3dB(A). (3) Approximate weight subject to changes after manufacturing process. (4) At 100% of full load.				These are average values based on tests with sinusoidal power supply, subject to the tolerances stipulated in NEMA MG-1.				
Rev.	Changes Summary			Performed	Checked	Date		
Performed by								
Checked by					Page	Revision		
Date	14/04/2022				1 / 36			

TORQUE AND CURRENT VS SPEED CURVE

Three Phase Induction Motor - Squirrel Cage



Customer :

Product line : NEMA Premium Efficiency Three-Phase

Product code : 13923290

Catalog # : 02536ST3QIE284TSC-W2

TORQUE AND CURRENT VS SPEED CURVE

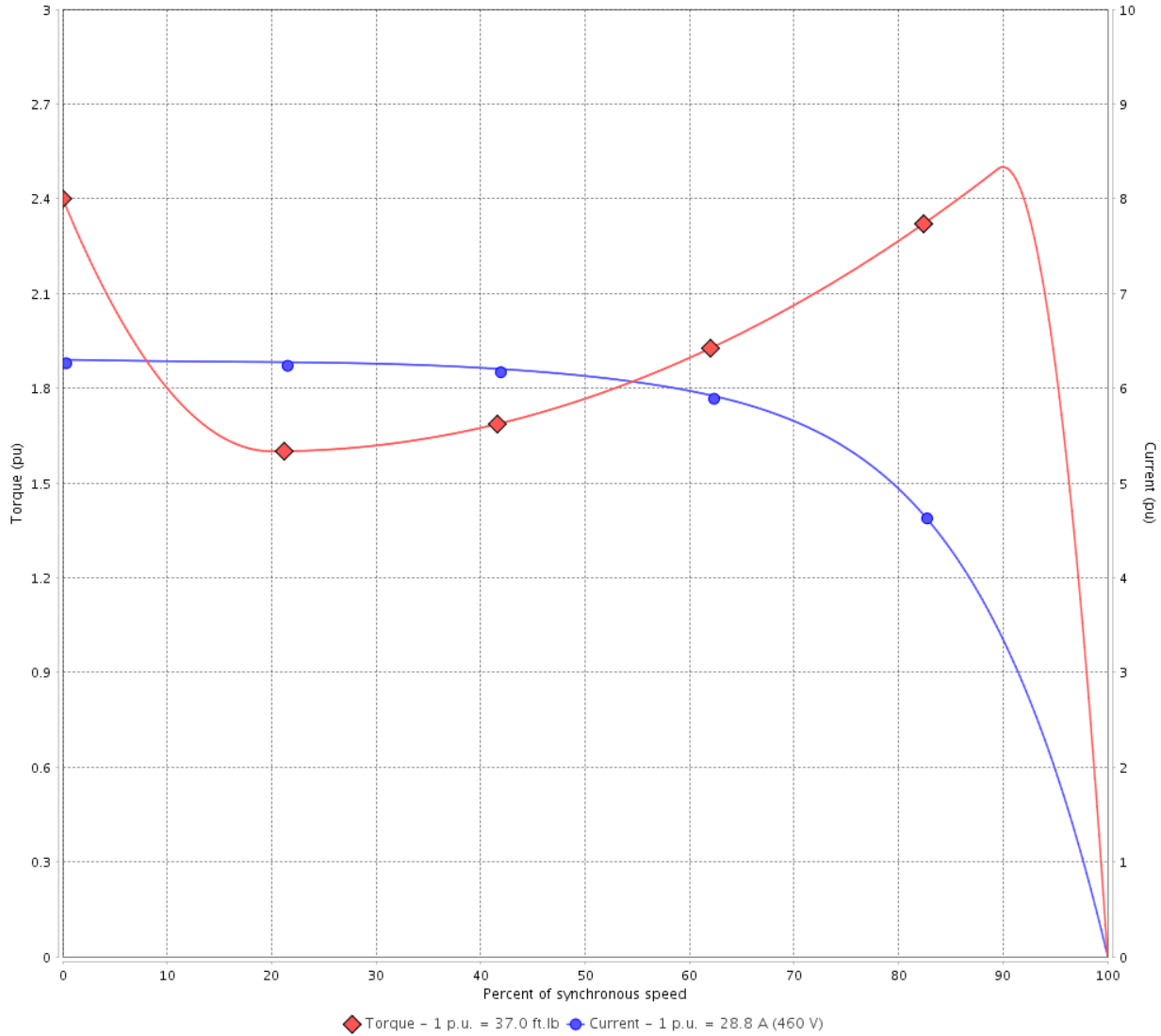

Performance : 460 V 60 Hz 2P

Rated current	: 28.8 A	Moment of inertia (J)	: 2.69 sq.ft.lb
LRC	: 6.3	Duty cycle	: Cont.(S1)
Rated torque	: 37.0 ft.lb	Insulation class	: F
Locked rotor torque	: 200 %	Service factor	: 1.25
Breakdown torque	: 250 %	Temperature rise	: 80 K
Rated speed	: 3545 rpm	Design	: B

Locked rotor time : 30s (cold) 17s (hot)

Rev.	Changes Summary	Performed	Checked	Date
Performed by			Page	Revision
Checked by				
Date	14/04/2022			
			2 / 36	

TORQUE AND CURRENT VS SPEED CURVE



Three Phase Induction Motor - Squirrel Cage

Customer :

Product line : NEMA Premium Efficiency Three-Phase

Product code : 13923290

Catalog # : 02536ST3QIE284TSC-W2

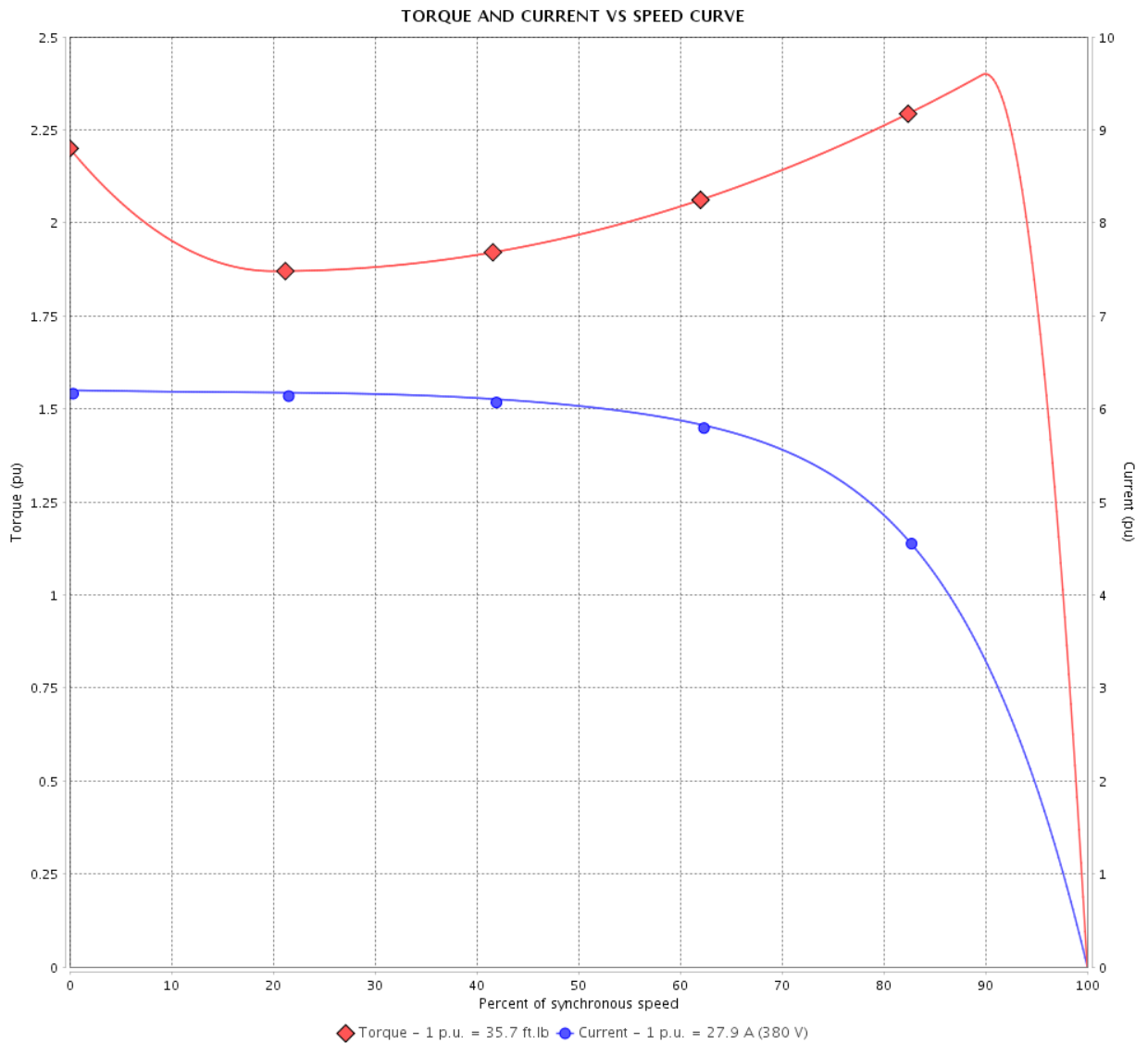

Performance : 380 V 50 Hz 2P IE3

Rated current	: 27.9 A	Moment of inertia (J)	: 2.69 sq.ft.lb
LRC	: 6.2	Duty cycle	: Cont.(S1)
Rated torque	: 35.7 ft.lb	Insulation class	: F
Locked rotor torque	: 200 %	Service factor	: 1.00
Breakdown torque	: 240 %	Temperature rise	: 80 K
Rated speed	: 2945 rpm	Design	: B

Locked rotor time : 25s (cold) 14s (hot)

Rev.	Changes Summary	Performed	Checked	Date
Performed by			Page	Revision
Checked by			3 / 36	
Date	14/04/2022			

TORQUE AND CURRENT VS SPEED CURVE

Three Phase Induction Motor - Squirrel Cage



Customer :

Product line : NEMA Premium Efficiency Three-Phase

Product code : 13923290

Catalog # : 02536ST3QIE284TSC-W2

TORQUE AND CURRENT VS SPEED CURVE

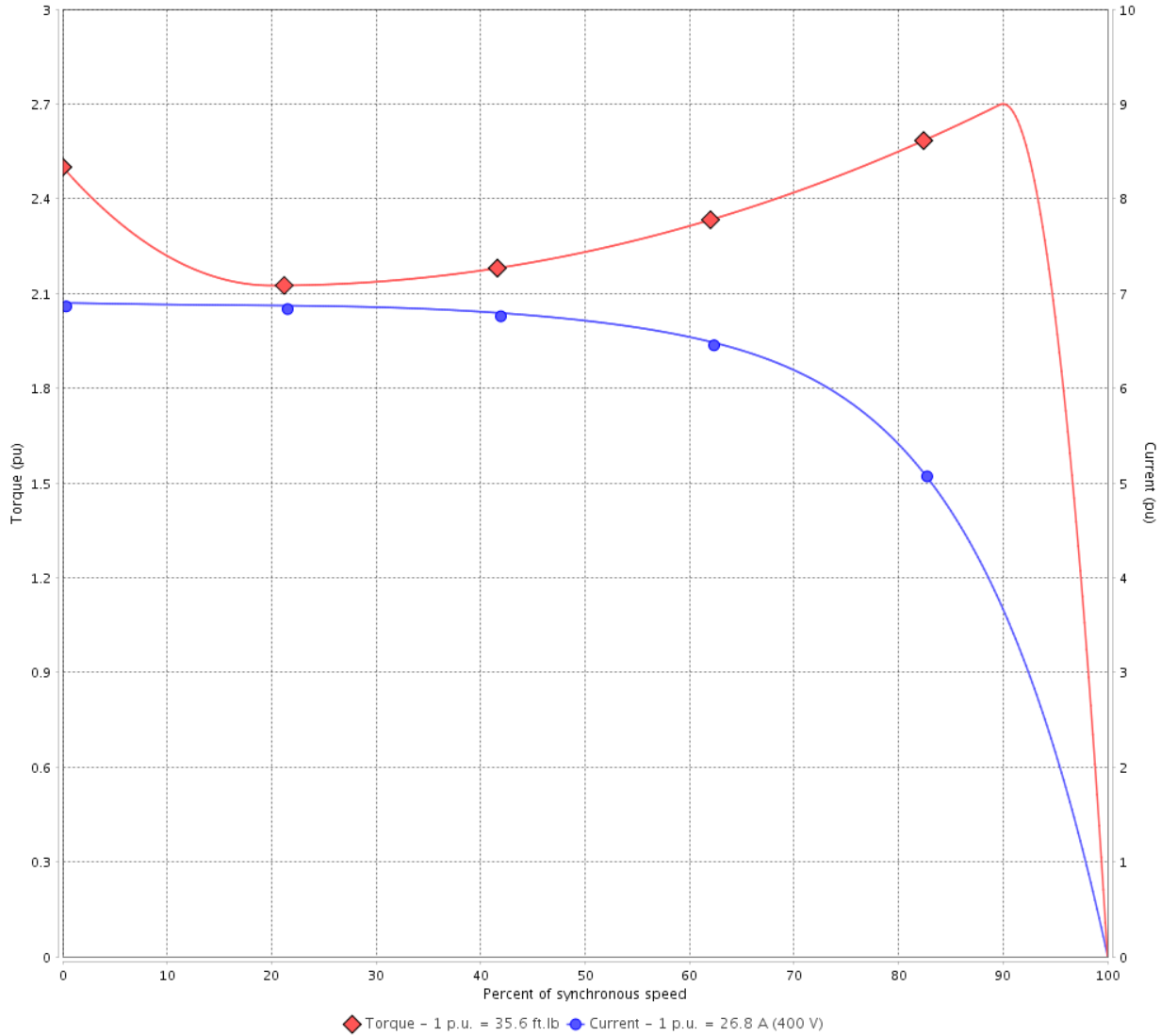

Performance : 400 V 50 Hz 2P IE3

Rated current	: 26.8 A	Moment of inertia (J)	: 2.69 sq.ft.lb
LRC	: 6.9	Duty cycle	: Cont.(S1)
Rated torque	: 35.6 ft.lb	Insulation class	: F
Locked rotor torque	: 229 %	Service factor	: 1.00
Breakdown torque	: 280 %	Temperature rise	: 80 K
Rated speed	: 2950 rpm	Design	: B

Locked rotor time : 25s (cold) 14s (hot)

Rev.	Changes Summary	Performed	Checked	Date
Performed by			Page 4 / 36	Revision
Checked by				
Date	14/04/2022			

TORQUE AND CURRENT VS SPEED CURVE



Three Phase Induction Motor - Squirrel Cage

Customer :

Product line : NEMA Premium Efficiency Three-Phase

Product code : 13923290

Catalog # : 02536ST3QIE284TSC-W2

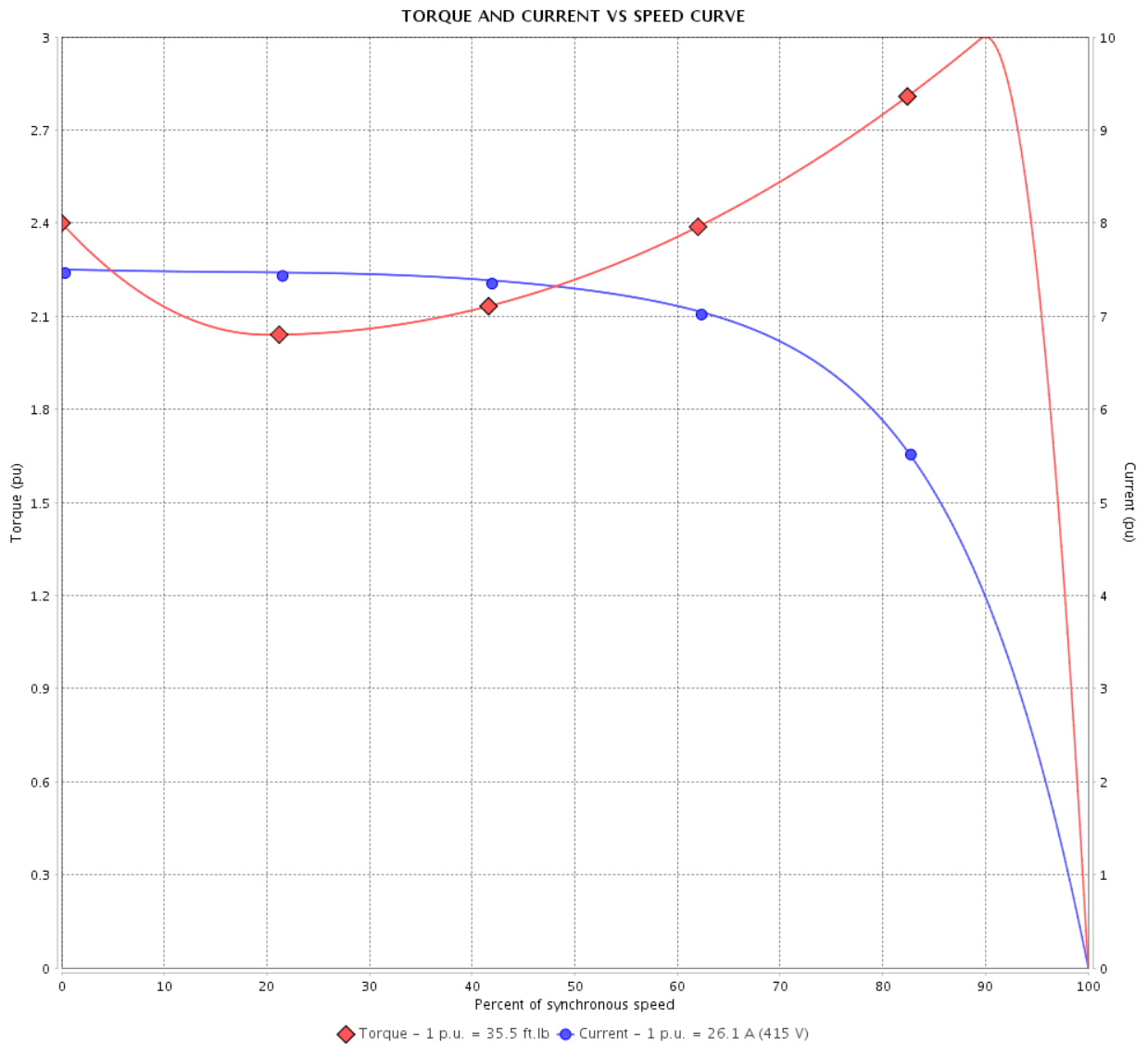

Performance : 415 V 50 Hz 2P IE3

Rated current	: 26.1 A	Moment of inertia (J)	: 2.69 sq.ft.lb
LRC	: 7.4	Duty cycle	: Cont.(S1)
Rated torque	: 35.5 ft.lb	Insulation class	: F
Locked rotor torque	: 240 %	Service factor	: 1.00
Breakdown torque	: 300 %	Temperature rise	: 80 K
Rated speed	: 2955 rpm	Design	: B

Locked rotor time : 25s (cold) 14s (hot)

Rev.	Changes Summary	Performed	Checked	Date
Performed by			Page 5 / 36	Revision
Checked by				
Date	14/04/2022			

TORQUE AND CURRENT VS SPEED CURVE

Three Phase Induction Motor - Squirrel Cage



Customer :

Product line : NEMA Premium Efficiency Three-Phase

Product code : 13923290

Catalog # : 02536ST3QIE284TSC-W2

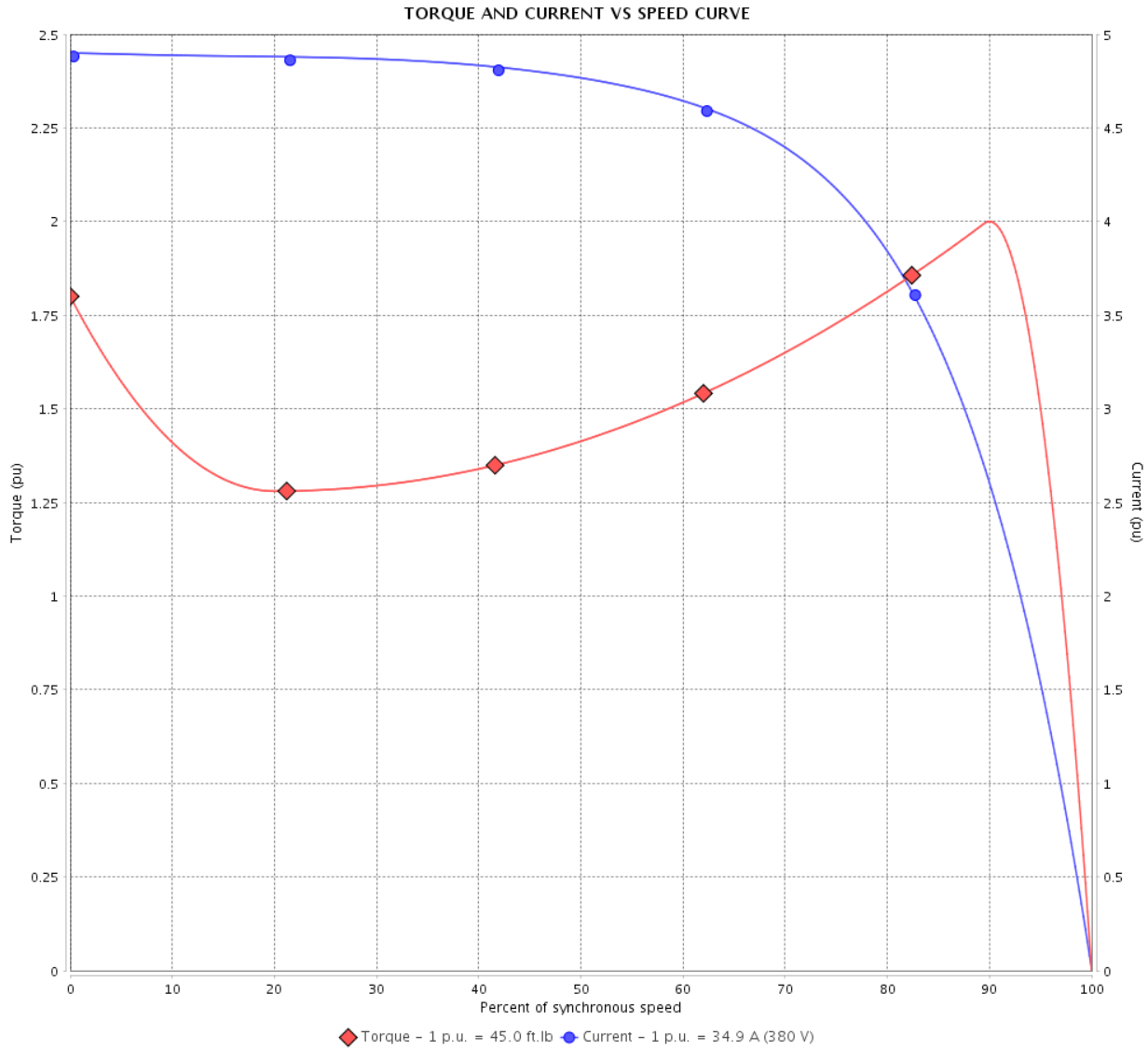

Performance : 380 V 50 Hz 2P IE1

Rated current	: 34.9 A	Moment of inertia (J)	: 2.69 sq.ft.lb
LRC	: 4.9	Duty cycle	: Cont.(S1)
Rated torque	: 45.0 ft.lb	Insulation class	: F
Locked rotor torque	: 160 %	Service factor	: 1.00
Breakdown torque	: 200 %	Temperature rise	: 105 K
Rated speed	: 2910 rpm	Design	: B

Locked rotor time : 25s (cold) 14s (hot)

Rev.	Changes Summary	Performed	Checked	Date
Performed by			Page 6 / 36	Revision
Checked by				
Date	14/04/2022			

TORQUE AND CURRENT VS SPEED CURVE



Three Phase Induction Motor - Squirrel Cage

Customer :

Product line : NEMA Premium Efficiency Three-Phase

Product code : 13923290

Catalog # : 02536ST3QIE284TSC-W2

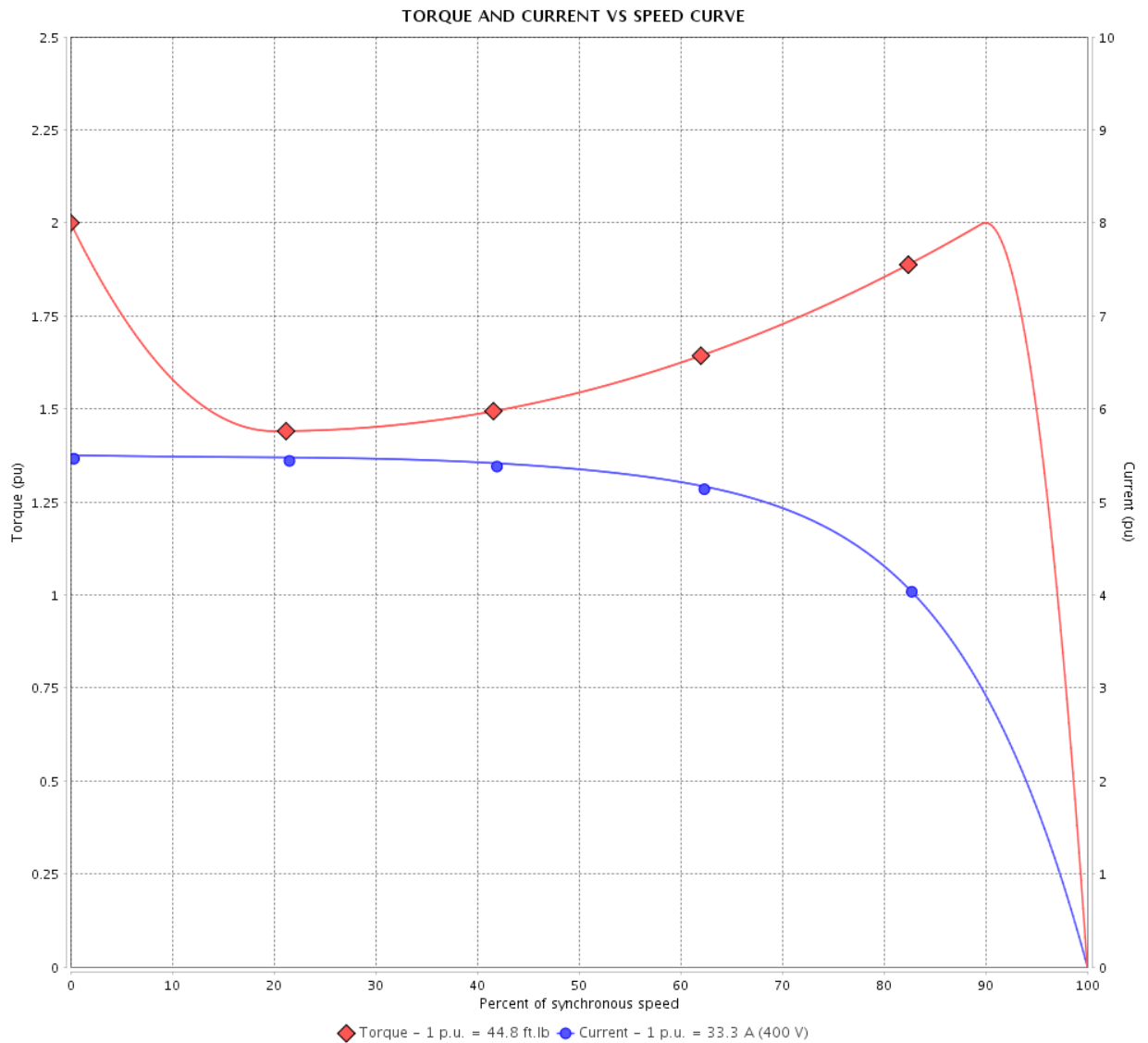

Performance : 400 V 50 Hz 2P IE1

Rated current	: 33.3 A	Moment of inertia (J)	: 2.69 sq.ft.lb
LRC	: 5.5	Duty cycle	: Cont.(S1)
Rated torque	: 44.8 ft.lb	Insulation class	: F
Locked rotor torque	: 180 %	Service factor	: 1.00
Breakdown torque	: 220 %	Temperature rise	: 105 K
Rated speed	: 2930 rpm	Design	: B

Locked rotor time : 25s (cold) 14s (hot)

Rev.	Changes Summary	Performed	Checked	Date
Performed by			Page 7 / 36	Revision
Checked by				
Date	14/04/2022			

TORQUE AND CURRENT VS SPEED CURVE

Three Phase Induction Motor - Squirrel Cage



Customer :

Product line : NEMA Premium Efficiency Three-Phase

Product code : 13923290

Catalog # : 02536ST3QIE284TSC-W2

TORQUE AND CURRENT VS SPEED CURVE

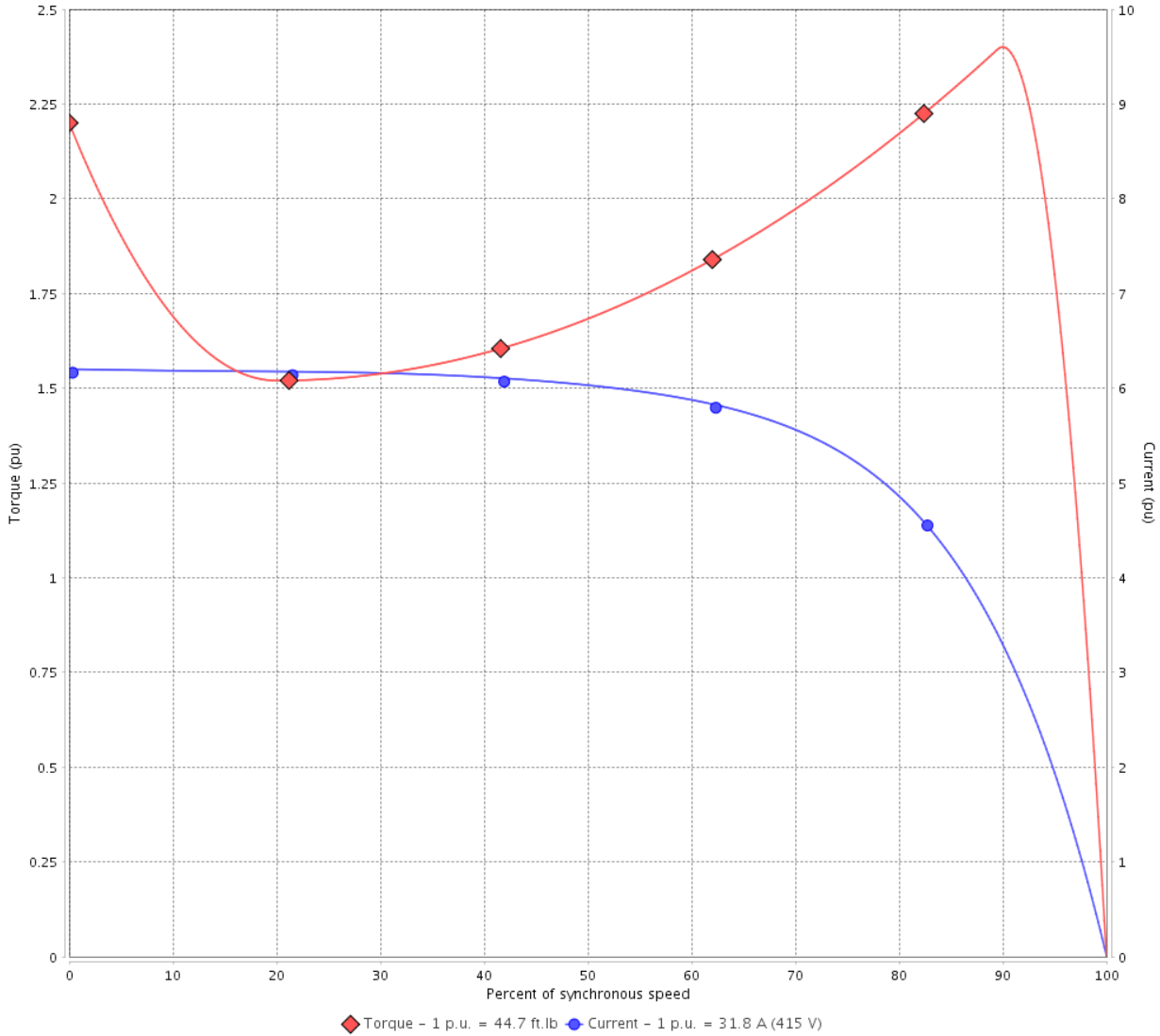

Performance : 415 V 50 Hz 2P IE2

Rated current	: 31.8 A	Moment of inertia (J)	: 2.69 sq.ft.lb
LRC	: 6.0	Duty cycle	: Cont.(S1)
Rated torque	: 44.7 ft.lb	Insulation class	: F
Locked rotor torque	: 190 %	Service factor	: 1.00
Breakdown torque	: 240 %	Temperature rise	: 105 K
Rated speed	: 2935 rpm	Design	: B

Locked rotor time : 25s (cold) 14s (hot)

Rev.	Changes Summary	Performed	Checked	Date
Performed by			Page 8 / 36	Revision
Checked by				
Date	14/04/2022			

LOAD PERFORMANCE CURVE

Three Phase Induction Motor - Squirrel Cage



Customer :

Product line : NEMA Premium Efficiency Three-Phase

Product code : 13923290

Catalog # : 02536ST3QIE284TSC-W2

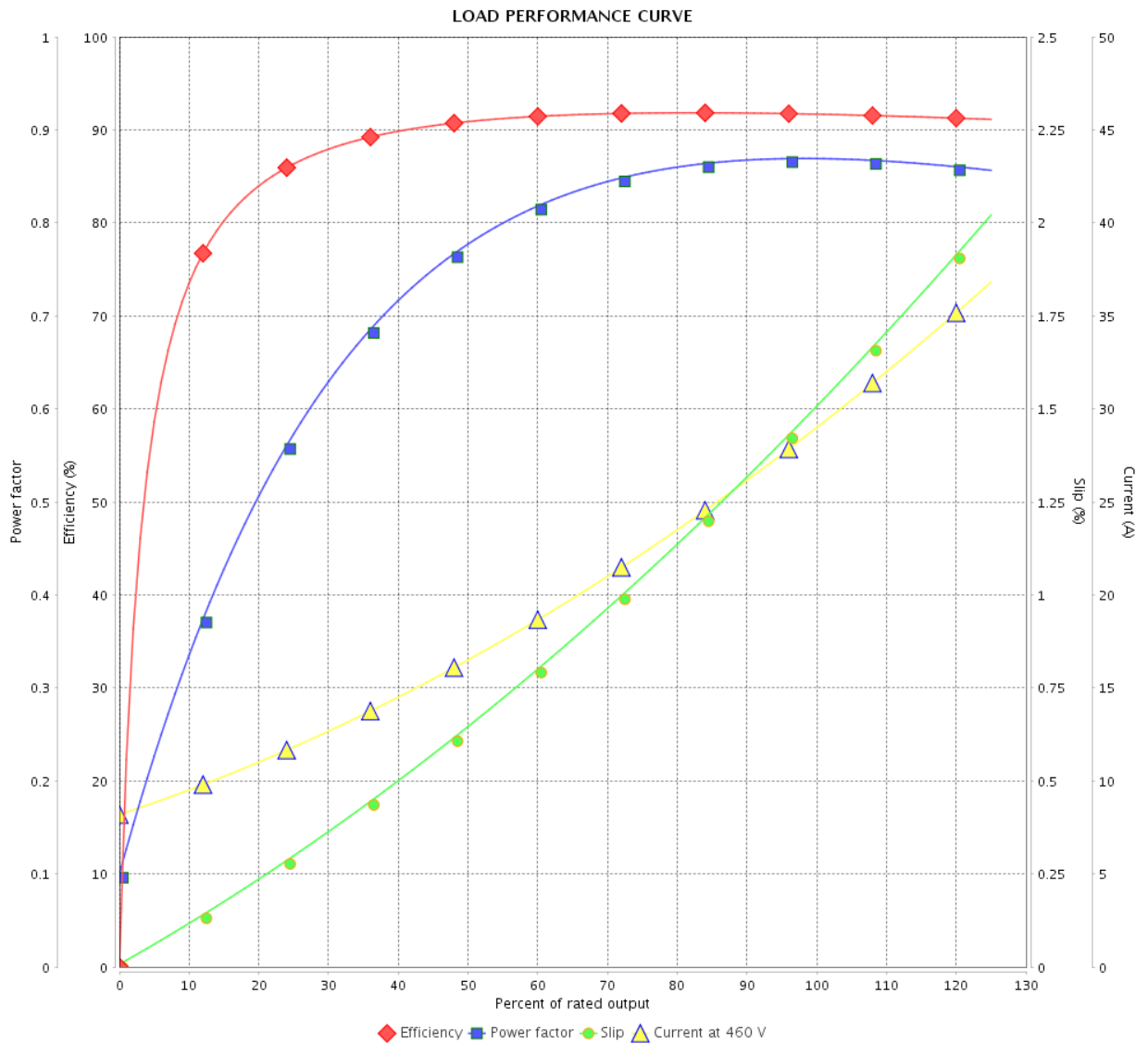

Performance : 460 V 60 Hz 2P

Rated current : 28.8 A
 LRC : 6.3
 Rated torque : 37.0 ft.lb
 Locked rotor torque : 200 %
 Breakdown torque : 250 %
 Rated speed : 3545 rpm

Moment of inertia (J) : 2.69 sq.ft.lb
 Duty cycle : Cont.(S1)
 Insulation class : F
 Service factor : 1.25
 Temperature rise : 80 K
 Design : B

Rev.	Changes Summary	Performed	Checked	Date
Performed by		Page		Revision
Checked by		9 / 36		
Date		14/04/2022		

LOAD PERFORMANCE CURVE

Three Phase Induction Motor - Squirrel Cage



Customer :

Product line : NEMA Premium Efficiency Three-Phase

Product code : 13923290

Catalog # : 02536ST3QIE284TSC-W2

LOAD PERFORMANCE CURVE

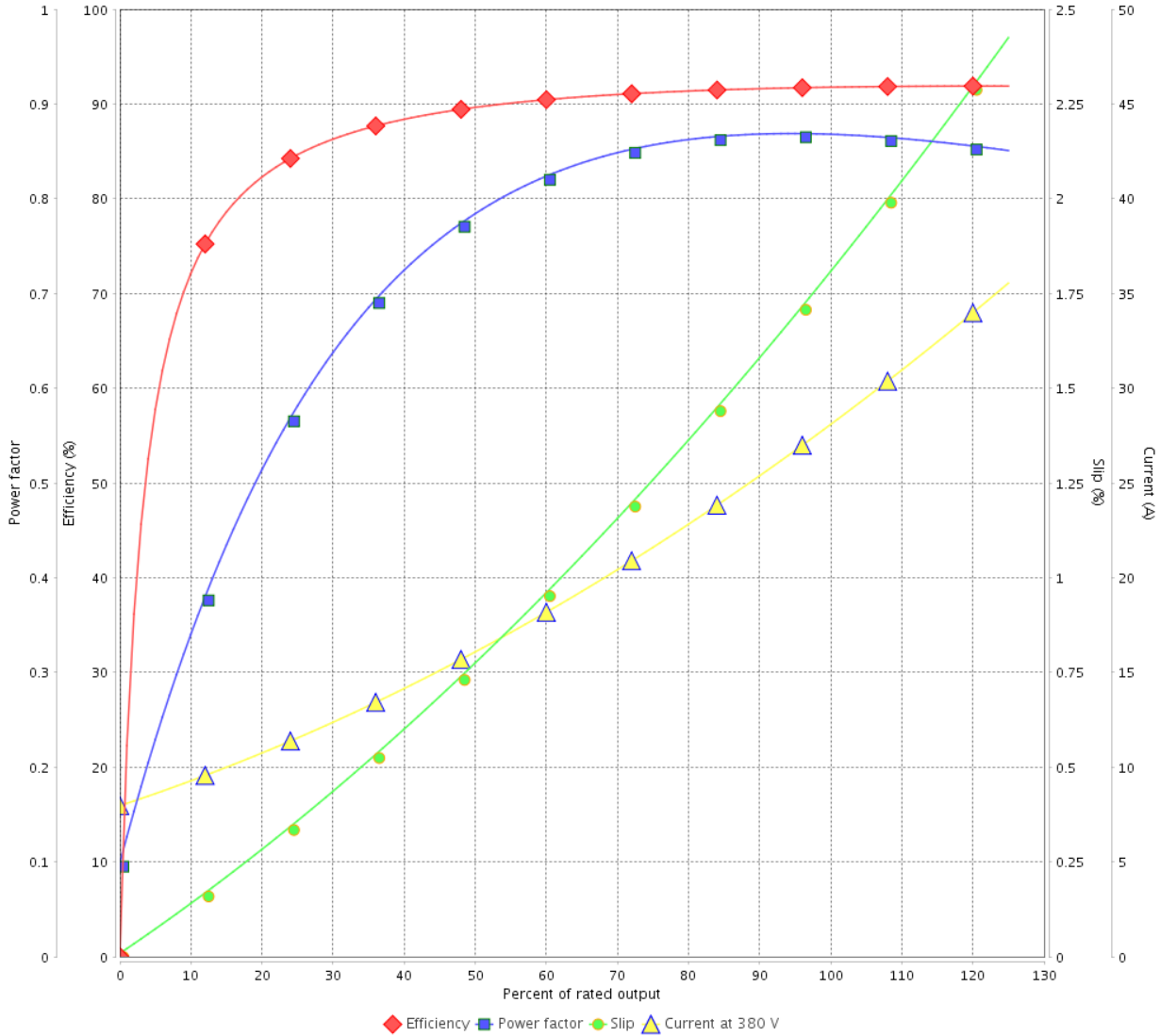

Performance : 380 V 50 Hz 2P IE3

Rated current : 27.9 A
 LRC : 6.2
 Rated torque : 35.7 ft.lb
 Locked rotor torque : 200 %
 Breakdown torque : 240 %
 Rated speed : 2945 rpm

Moment of inertia (J) : 2.69 sq.ft.lb
 Duty cycle : Cont.(S1)
 Insulation class : F
 Service factor : 1.00
 Temperature rise : 80 K
 Design : B

Rev.	Changes Summary	Performed	Checked	Date
Performed by			Page	Revision
Checked by			10 / 36	
Date	14/04/2022			

LOAD PERFORMANCE CURVE

Three Phase Induction Motor - Squirrel Cage



Customer :

Product line : NEMA Premium Efficiency Three-Phase

Product code : 13923290

Catalog # : 02536ST3QIE284TSC-W2

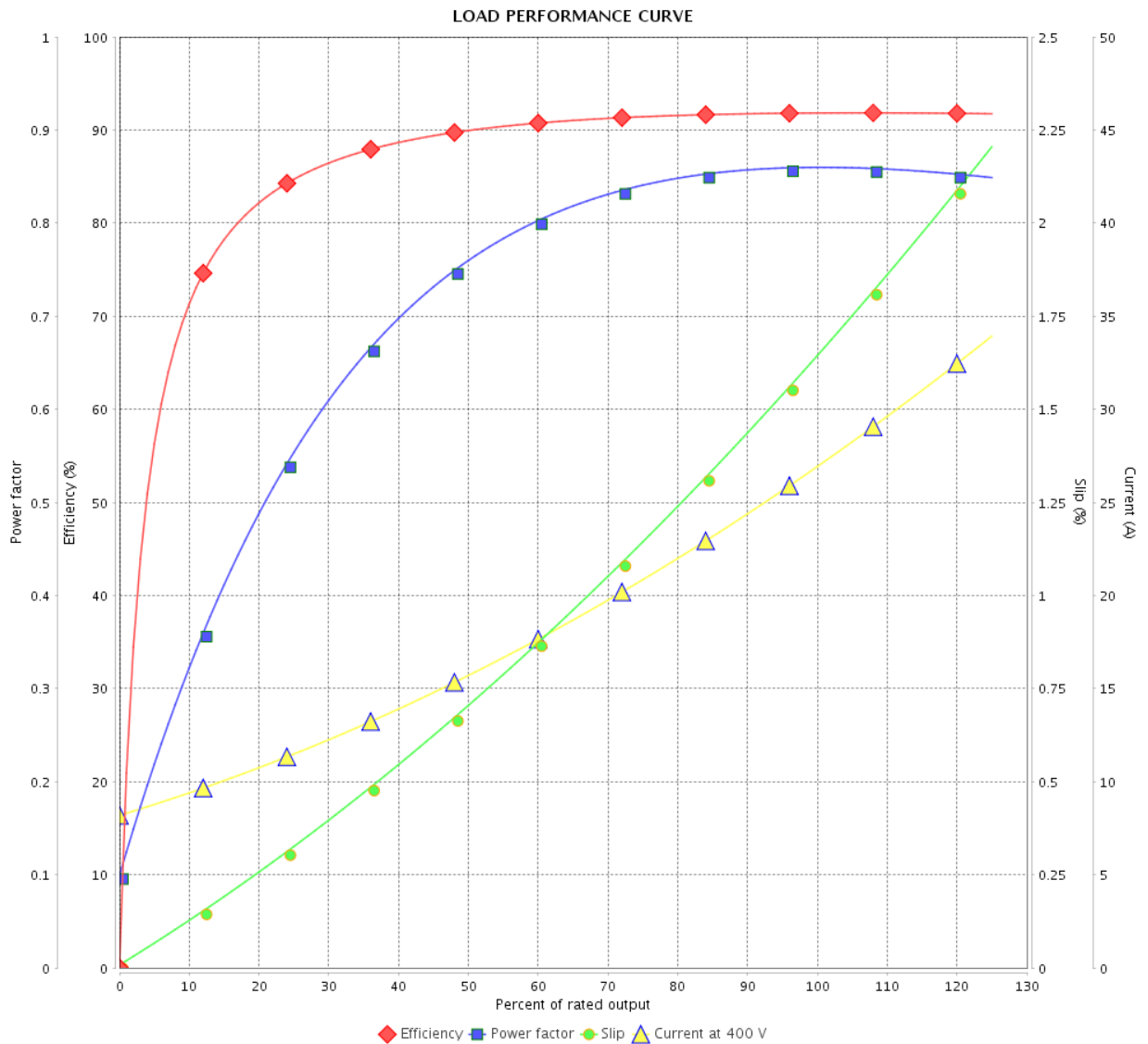

Performance : 400 V 50 Hz 2P IE3

Rated current : 26.8 A
 LRC : 6.9
 Rated torque : 35.6 ft.lb
 Locked rotor torque : 229 %
 Breakdown torque : 280 %
 Rated speed : 2950 rpm

Moment of inertia (J) : 2.69 sq.ft.lb
 Duty cycle : Cont.(S1)
 Insulation class : F
 Service factor : 1.00
 Temperature rise : 80 K
 Design : B

Rev.	Changes Summary	Performed	Checked	Date
Performed by		Page		Revision
Checked by		11 / 36		
Date		14/04/2022		

LOAD PERFORMANCE CURVE

Three Phase Induction Motor - Squirrel Cage



Customer :

Product line : NEMA Premium Efficiency Three-Phase

Product code : 13923290

Catalog # : 02536ST3QIE284TSC-W2

LOAD PERFORMANCE CURVE

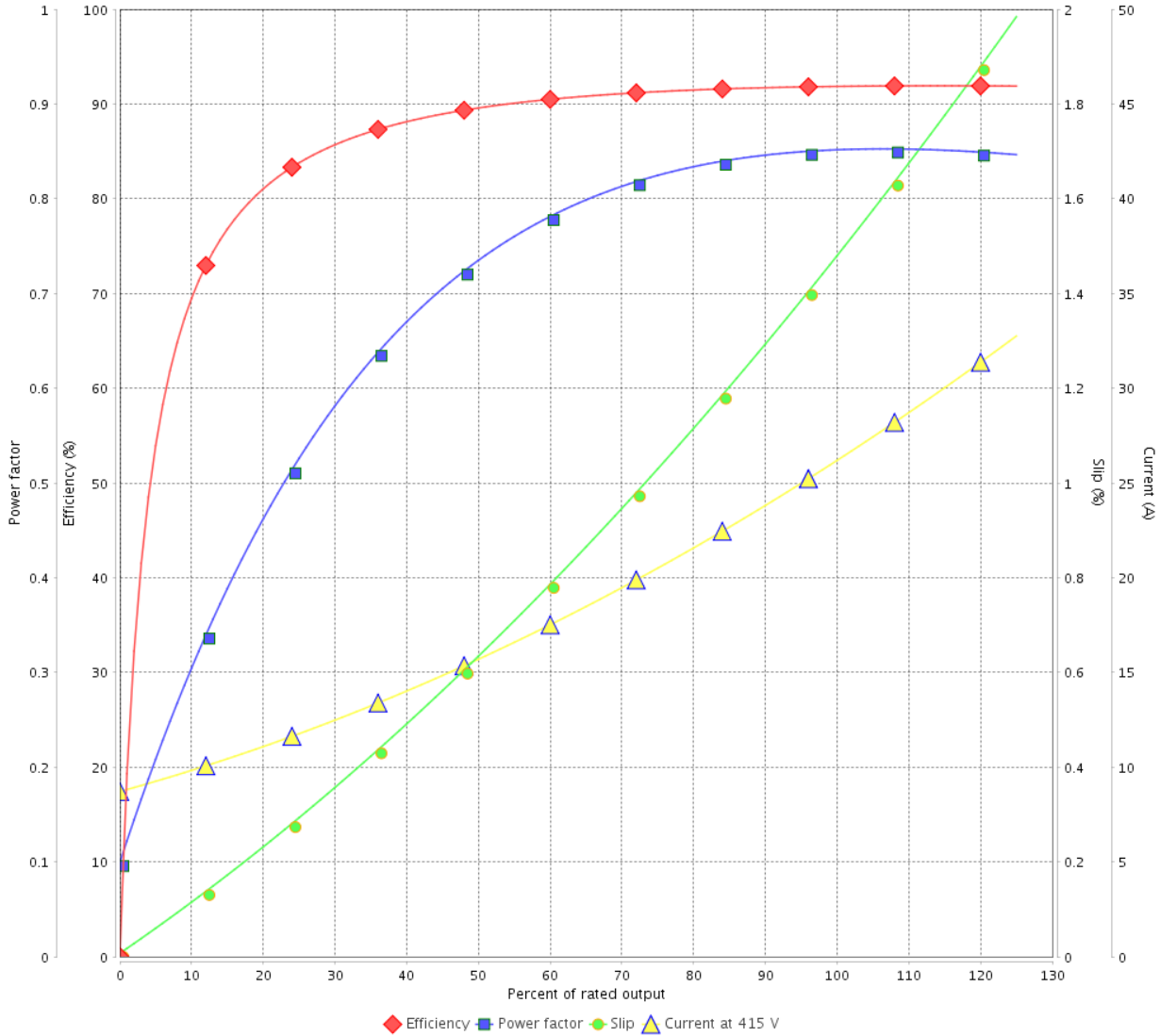

Performance : 415 V 50 Hz 2P IE3

Rated current : 26.1 A
 LRC : 7.4
 Rated torque : 35.5 ft.lb
 Locked rotor torque : 240 %
 Breakdown torque : 300 %
 Rated speed : 2955 rpm

Moment of inertia (J) : 2.69 sq.ft.lb
 Duty cycle : Cont.(S1)
 Insulation class : F
 Service factor : 1.00
 Temperature rise : 80 K
 Design : B

Rev.	Changes Summary	Performed	Checked	Date
Performed by			Page 12 / 36	Revision
Checked by				
Date	14/04/2022			

LOAD PERFORMANCE CURVE

Three Phase Induction Motor - Squirrel Cage



Customer : _____

Product line : NEMA Premium Efficiency Three-Phase

Product code : 13923290

Catalog # : 02536ST3QIE284TSC-W2

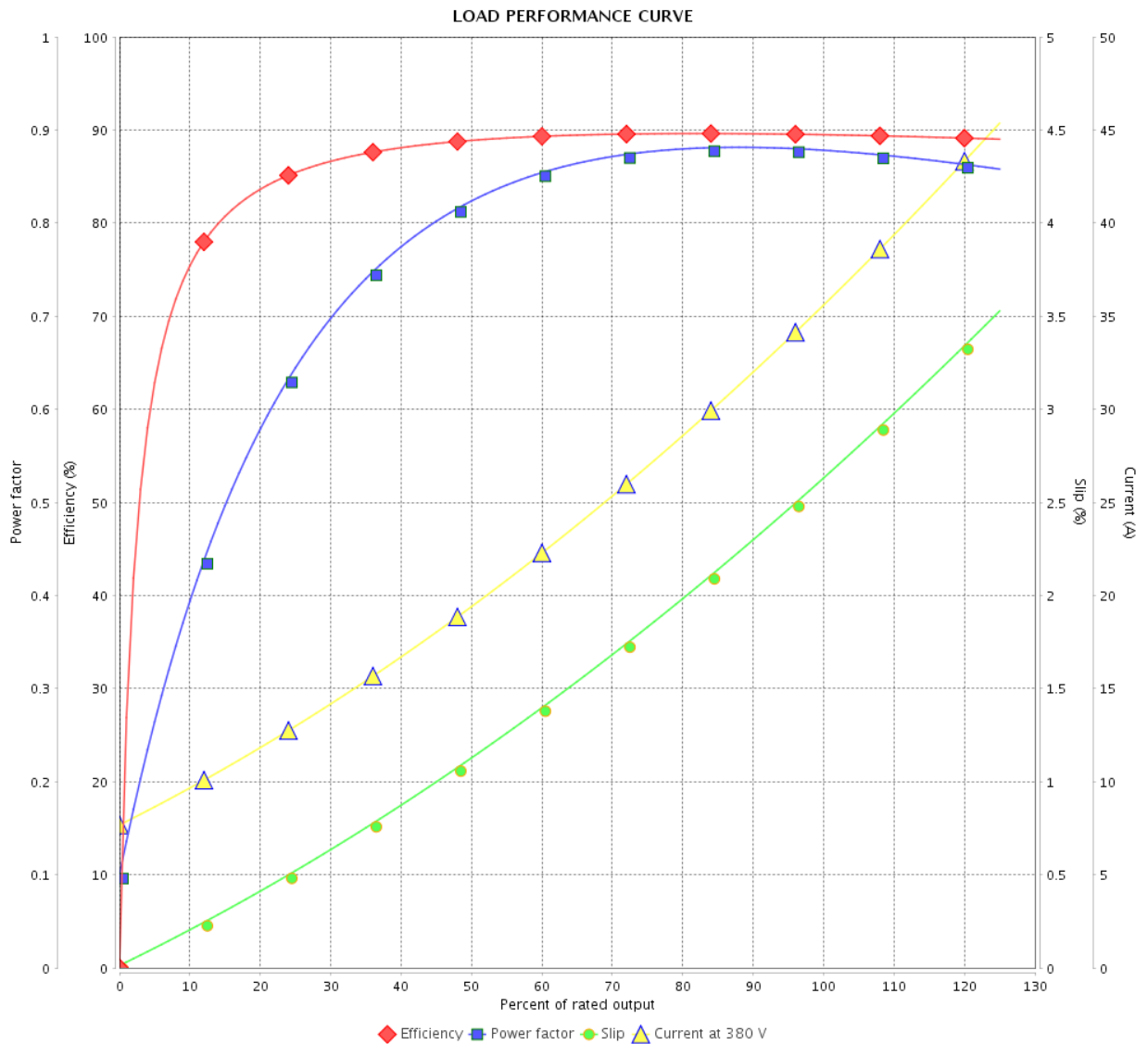

Performance : 380 V 50 Hz 2P IE1

Rated current : 34.9 A
 LRC : 4.9
 Rated torque : 45.0 ft.lb
 Locked rotor torque : 160 %
 Breakdown torque : 200 %
 Rated speed : 2910 rpm

Moment of inertia (J) : 2.69 sq.ft.lb
 Duty cycle : Cont.(S1)
 Insulation class : F
 Service factor : 1.00
 Temperature rise : 105 K
 Design : B

Rev.	Changes Summary	Performed	Checked	Date
Performed by		Page		Revision
Checked by		13 / 36		
Date		14/04/2022		

LOAD PERFORMANCE CURVE

Three Phase Induction Motor - Squirrel Cage



Customer :

Product line : NEMA Premium Efficiency Three-Phase

Product code : 13923290

Catalog # : 02536ST3QIE284TSC-W2

LOAD PERFORMANCE CURVE

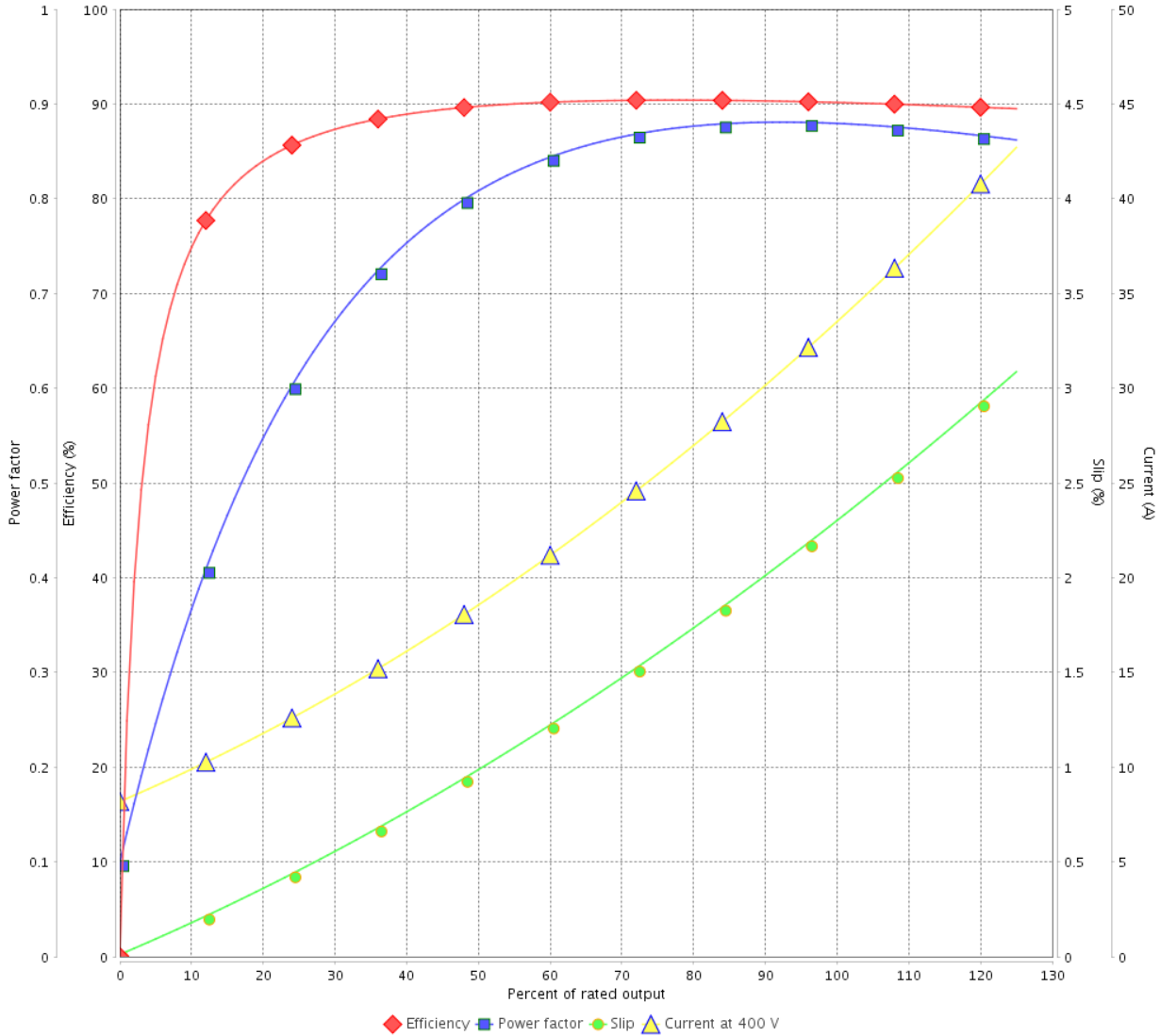

Performance : 400 V 50 Hz 2P IE1

Rated current : 33.3 A
 LRC : 5.5
 Rated torque : 44.8 ft.lb
 Locked rotor torque : 180 %
 Breakdown torque : 220 %
 Rated speed : 2930 rpm

Moment of inertia (J) : 2.69 sq.ft.lb
 Duty cycle : Cont.(S1)
 Insulation class : F
 Service factor : 1.00
 Temperature rise : 105 K
 Design : B

Rev.	Changes Summary	Performed	Checked	Date
Performed by			Page 14 / 36	Revision
Checked by				
Date	14/04/2022			

LOAD PERFORMANCE CURVE

Three Phase Induction Motor - Squirrel Cage



Customer : _____

Product line : NEMA Premium Efficiency Three-Phase

Product code : 13923290

Catalog # : 02536ST3QIE284TSC-W2

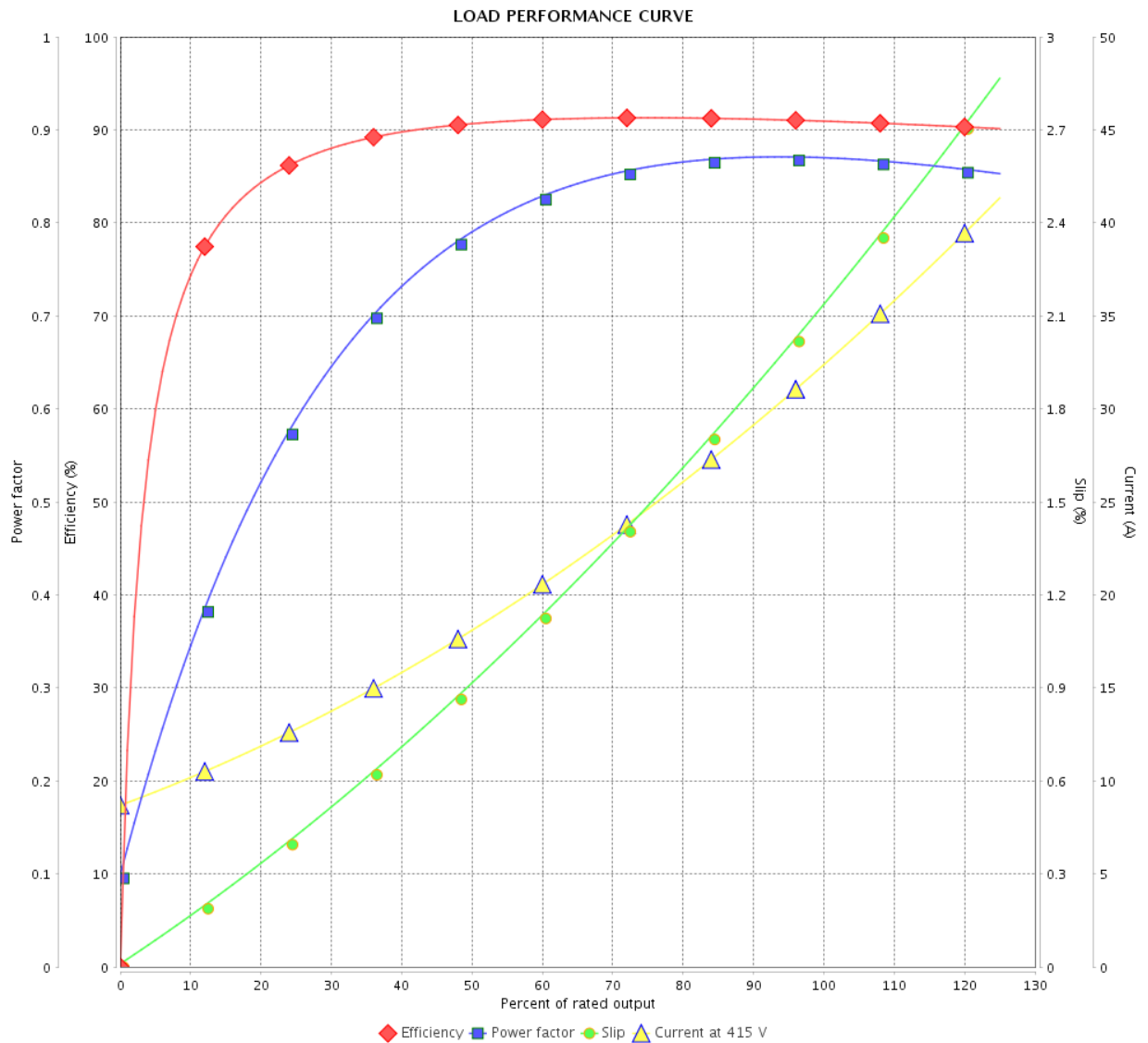

Performance : 415 V 50 Hz 2P IE2

Rated current : 31.8 A
 LRC : 6.0
 Rated torque : 44.7 ft.lb
 Locked rotor torque : 190 %
 Breakdown torque : 240 %
 Rated speed : 2935 rpm

Moment of inertia (J) : 2.69 sq.ft.lb
 Duty cycle : Cont.(S1)
 Insulation class : F
 Service factor : 1.00
 Temperature rise : 105 K
 Design : B

Rev.	Changes Summary	Performed	Checked	Date
Performed by		Page		Revision
Checked by		15 / 36		
Date		14/04/2022		

THERMAL LIMIT CURVE



Three Phase Induction Motor - Squirrel Cage

Customer :

Product line : NEMA Premium Efficiency Three-Phase

Product code : 13923290

Catalog # : 02536ST3QIE284TSC-W2

Performance : 460 V 60 Hz 2P

Rated current	: 28.8 A	Moment of inertia (J)	: 2.69 sq.ft.lb
LRC	: 6.3	Duty cycle	: Cont.(S1)
Rated torque	: 37.0 ft.lb	Insulation class	: F
Locked rotor torque	: 200 %	Service factor	: 1.25
Breakdown torque	: 250 %	Temperature rise	: 80 K
Rated speed	: 3545 rpm	Design	: B

Heating constant

Cooling constant

Rev.	Changes Summary	Performed	Checked	Date
Performed by				
Checked by			Page	Revision
Date	14/04/2022		16 / 36	

THERMAL LIMIT CURVE

Three Phase Induction Motor - Squirrel Cage



Customer : _____

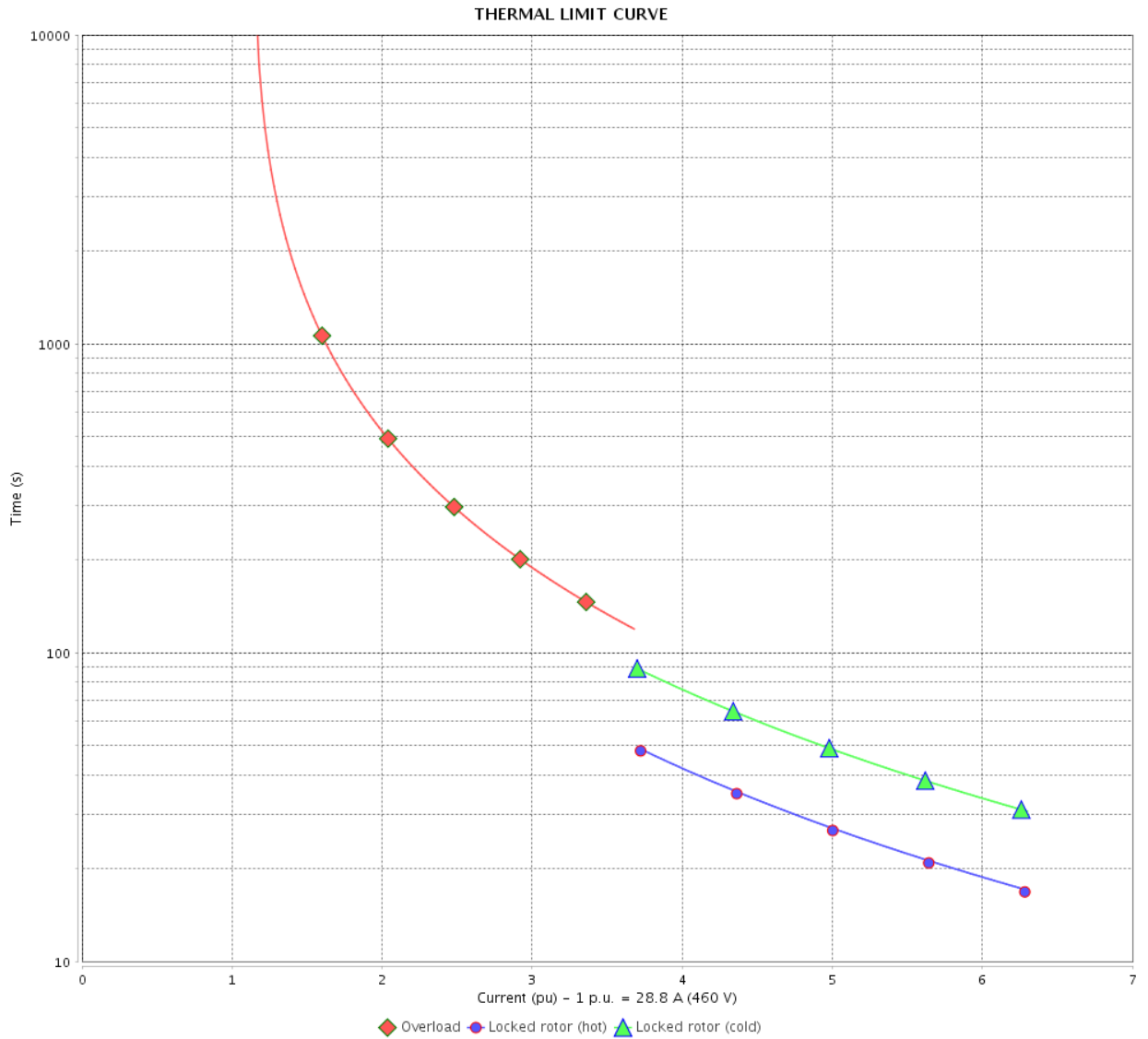

Rev.	Changes Summary	Performed	Checked	Date
Performed by		Page		Revision
Checked by		17 / 36		
Date		14/04/2022		

THERMAL LIMIT CURVE

Three Phase Induction Motor - Squirrel Cage



Customer :

Product line : NEMA Premium Efficiency Three-Phase
Product code : 13923290
Catalog # : 02536ST3QIE284TSC-W2

Performance : 380 V 50 Hz 2P IE3

Rated current	: 27.9 A	Moment of inertia (J)	: 2.69 sq.ft.lb
LRC	: 6.2	Duty cycle	: Cont.(S1)
Rated torque	: 35.7 ft.lb	Insulation class	: F
Locked rotor torque	: 200 %	Service factor	: 1.00
Breakdown torque	: 240 %	Temperature rise	: 80 K
Rated speed	: 2945 rpm	Design	: B

Heating constant

Cooling constant

Rev.	Changes Summary	Performed	Checked	Date
Performed by				
Checked by			Page	Revision
Date	14/04/2022		18 / 36	

THERMAL LIMIT CURVE

Three Phase Induction Motor - Squirrel Cage



Customer : _____

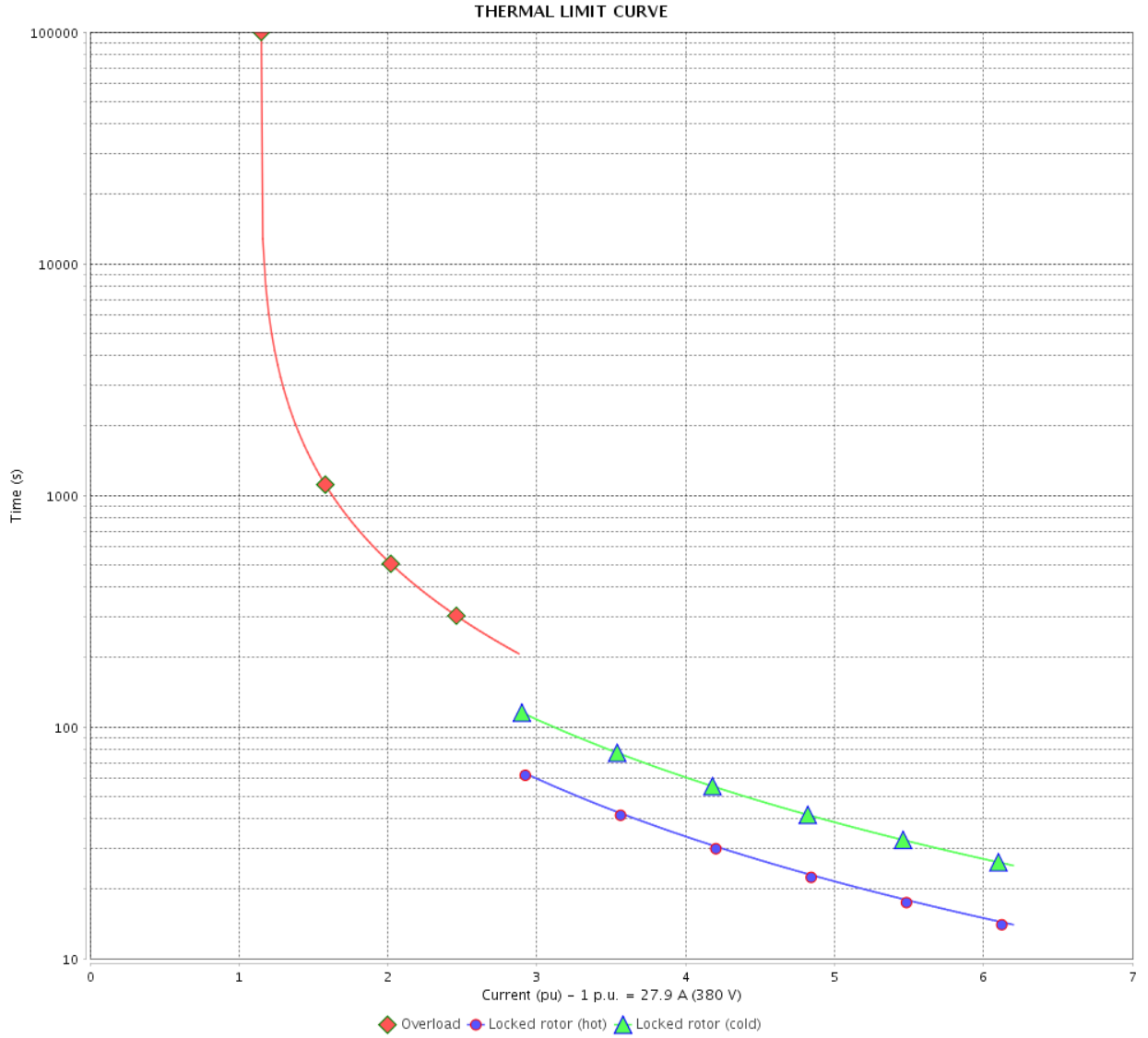

Rev.	Changes Summary	Performed	Checked	Date
Performed by		Page		Revision
Checked by		19 / 36		
Date		14/04/2022		

THERMAL LIMIT CURVE



Three Phase Induction Motor - Squirrel Cage

Customer :

Product line : NEMA Premium Efficiency Three-Phase
Product code : 13923290
Catalog # : 02536ST3QIE284TSC-W2

Performance : 400 V 50 Hz 2P IE3

Rated current	: 26.8 A	Moment of inertia (J)	: 2.69 sq.ft.lb
LRC	: 6.9	Duty cycle	: Cont.(S1)
Rated torque	: 35.6 ft.lb	Insulation class	: F
Locked rotor torque	: 229 %	Service factor	: 1.00
Breakdown torque	: 280 %	Temperature rise	: 80 K
Rated speed	: 2950 rpm	Design	: B

Heating constant

Cooling constant

Rev.	Changes Summary	Performed	Checked	Date
Performed by				
Checked by			Page	Revision
Date	14/04/2022		20 / 36	

THERMAL LIMIT CURVE

Three Phase Induction Motor - Squirrel Cage



Customer : _____

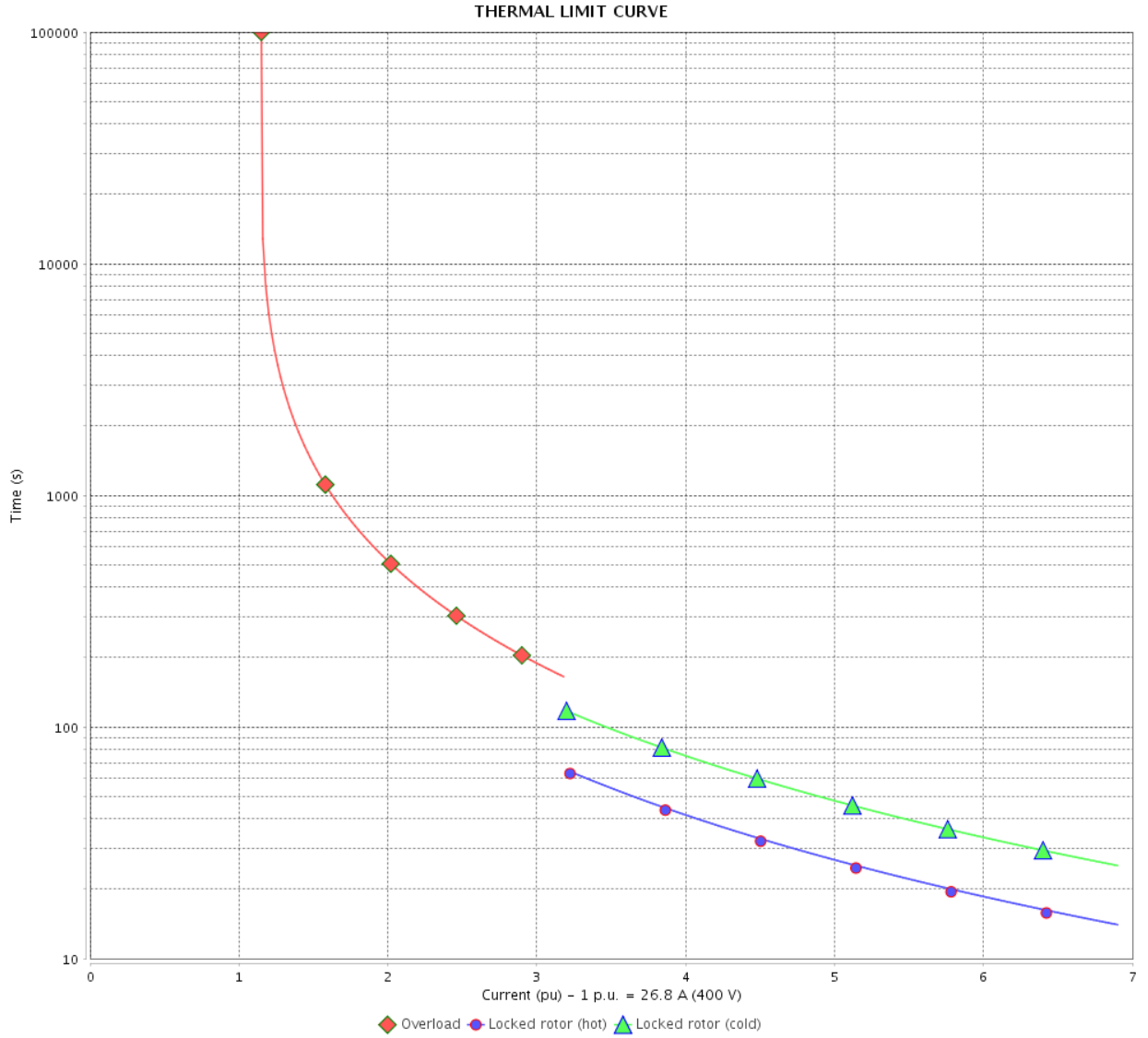

Rev.	Changes Summary	Performed	Checked	Date
Performed by		Page 21 / 36		Revision
Checked by				
Date				

THERMAL LIMIT CURVE

Three Phase Induction Motor - Squirrel Cage



Customer :

Product line : NEMA Premium Efficiency Three-Phase
Product code : 13923290
Catalog # : 02536ST3QIE284TSC-W2

Performance : 415 V 50 Hz 2P IE3

Rated current	: 26.1 A	Moment of inertia (J)	: 2.69 sq.ft.lb
LRC	: 7.4	Duty cycle	: Cont.(S1)
Rated torque	: 35.5 ft.lb	Insulation class	: F
Locked rotor torque	: 240 %	Service factor	: 1.00
Breakdown torque	: 300 %	Temperature rise	: 80 K
Rated speed	: 2955 rpm	Design	: B

Heating constant

Cooling constant

Rev.	Changes Summary	Performed	Checked	Date
Performed by				
Checked by			Page	Revision
Date	14/04/2022		22 / 36	

THERMAL LIMIT CURVE

Three Phase Induction Motor - Squirrel Cage



Customer : _____

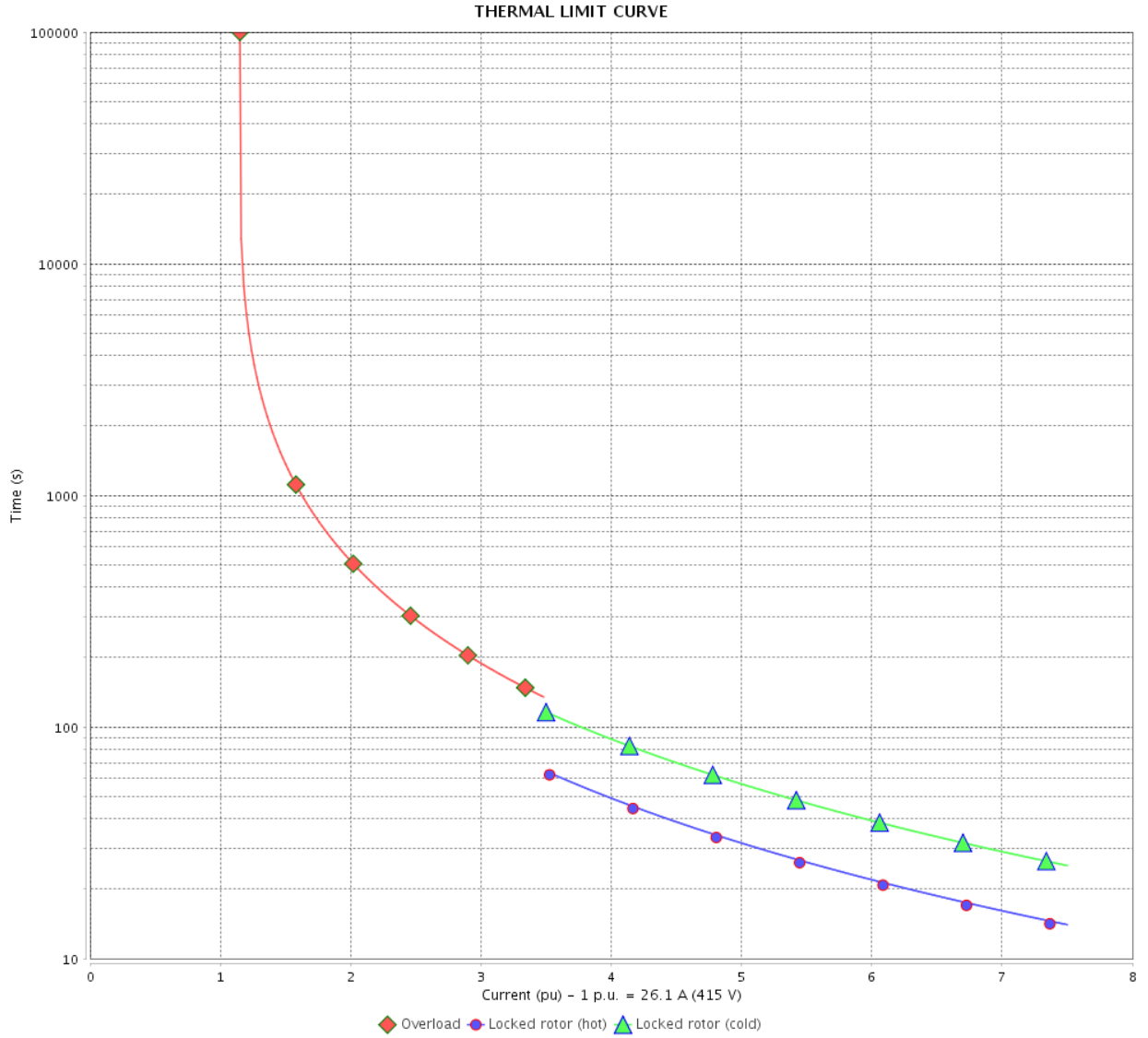

Rev.	Changes Summary	Performed	Checked	Date
Performed by		Page 23 / 36		Revision
Checked by				
Date				

THERMAL LIMIT CURVE



Three Phase Induction Motor - Squirrel Cage

Customer :

Product line : NEMA Premium Efficiency Three-Phase
Product code : 13923290
Catalog # : 02536ST3QIE284TSC-W2

Performance : 380 V 50 Hz 2P IE1

Rated current	: 34.9 A	Moment of inertia (J)	: 2.69 sq.ft.lb
LRC	: 4.9	Duty cycle	: Cont.(S1)
Rated torque	: 45.0 ft.lb	Insulation class	: F
Locked rotor torque	: 160 %	Service factor	: 1.00
Breakdown torque	: 200 %	Temperature rise	: 105 K
Rated speed	: 2910 rpm	Design	: B

Heating constant

Cooling constant

Rev.	Changes Summary	Performed	Checked	Date
Performed by				
Checked by			Page	Revision
Date	14/04/2022		24 / 36	

THERMAL LIMIT CURVE

Three Phase Induction Motor - Squirrel Cage



Customer : _____

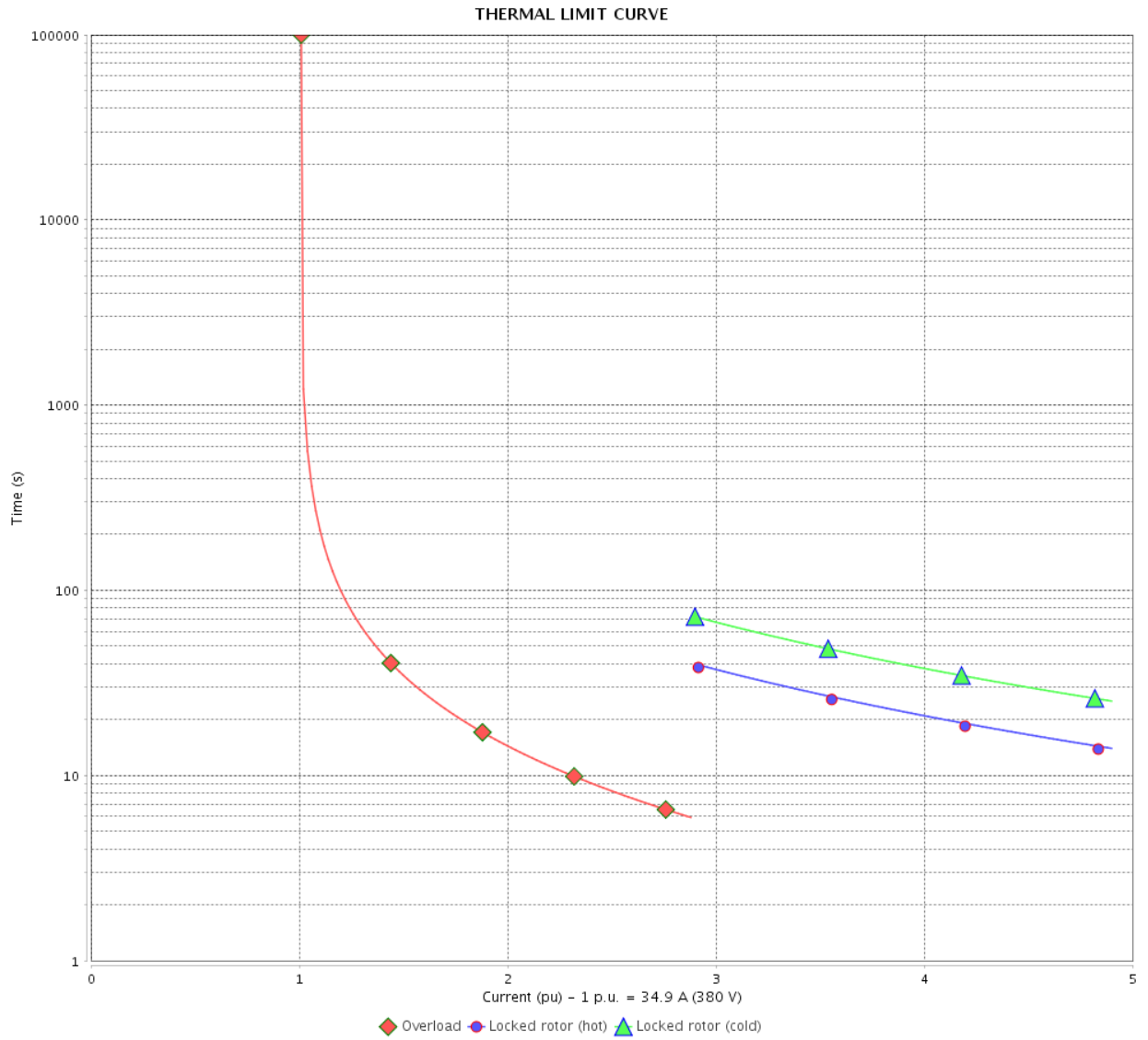

Rev.	Changes Summary	Performed	Checked	Date
Performed by		Page 25 / 36		Revision
Checked by				
Date				

THERMAL LIMIT CURVE

Three Phase Induction Motor - Squirrel Cage



Customer :

Product line : NEMA Premium Efficiency Three-Phase
Product code : 13923290
Catalog # : 02536ST3QIE284TSC-W2

Performance : 400 V 50 Hz 2P IE1

Rated current	: 33.3 A	Moment of inertia (J)	: 2.69 sq.ft.lb
LRC	: 5.5	Duty cycle	: Cont.(S1)
Rated torque	: 44.8 ft.lb	Insulation class	: F
Locked rotor torque	: 180 %	Service factor	: 1.00
Breakdown torque	: 220 %	Temperature rise	: 105 K
Rated speed	: 2930 rpm	Design	: B

Heating constant

Cooling constant

Rev.	Changes Summary	Performed	Checked	Date
Performed by				
Checked by			Page	Revision
Date	14/04/2022		26 / 36	

THERMAL LIMIT CURVE

Three Phase Induction Motor - Squirrel Cage



Customer : _____

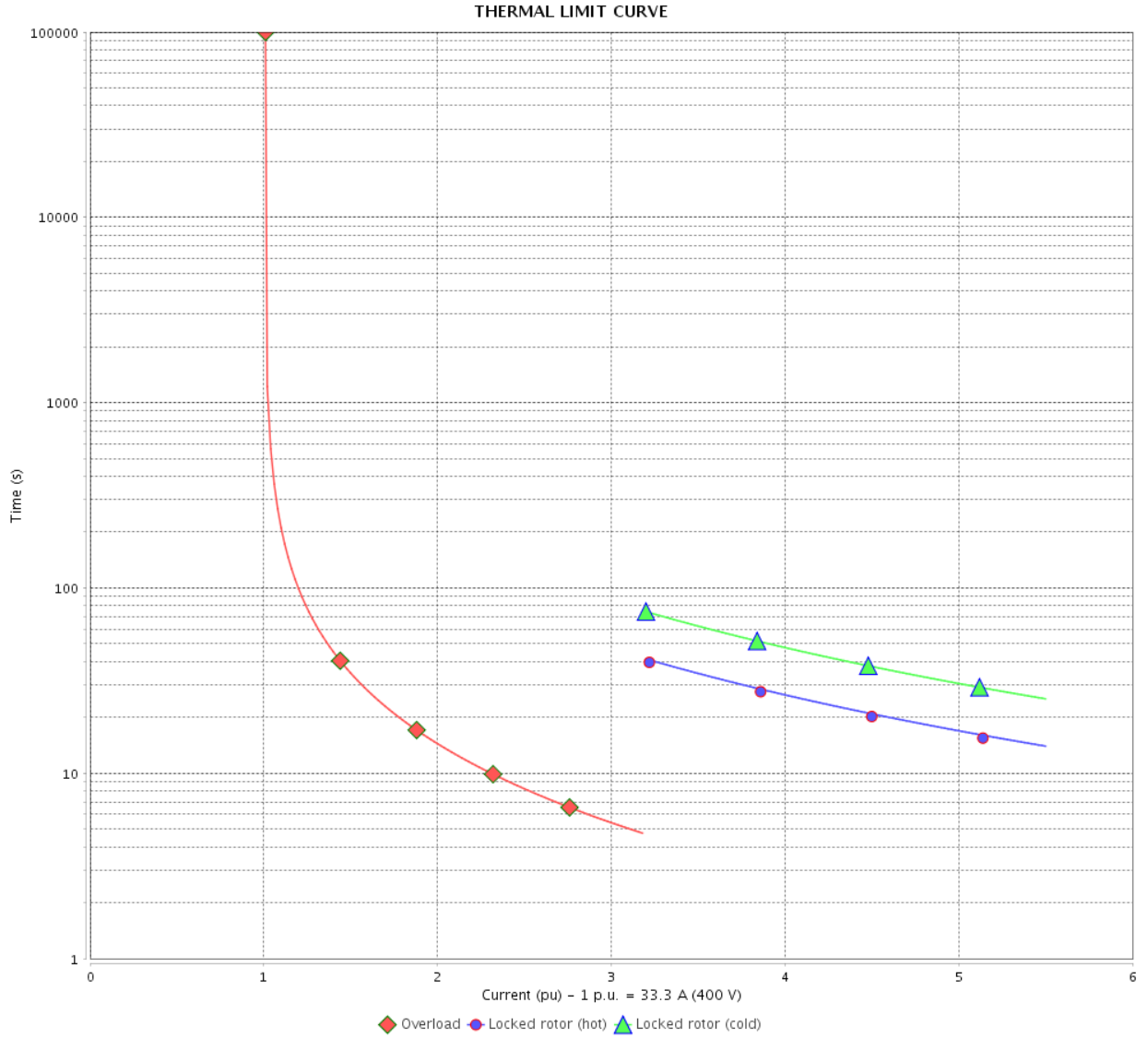

Rev.	Changes Summary	Performed	Checked	Date
Performed by		Page 27 / 36		Revision
Checked by				
Date				

THERMAL LIMIT CURVE



Three Phase Induction Motor - Squirrel Cage

Customer :

Product line : NEMA Premium Efficiency Three-Phase

Product code : 13923290

Catalog # : 02536ST3QIE284TSC-W2

Performance : 415 V 50 Hz 2P IE2

Rated current	: 31.8 A	Moment of inertia (J)	: 2.69 sq.ft.lb
LRC	: 6.0	Duty cycle	: Cont.(S1)
Rated torque	: 44.7 ft.lb	Insulation class	: F
Locked rotor torque	: 190 %	Service factor	: 1.00
Breakdown torque	: 240 %	Temperature rise	: 105 K
Rated speed	: 2935 rpm	Design	: B

Heating constant

Cooling constant

Rev.	Changes Summary	Performed	Checked	Date
Performed by				
Checked by			Page	Revision
Date	14/04/2022		28 / 36	

THERMAL LIMIT CURVE

Three Phase Induction Motor - Squirrel Cage



Customer : _____

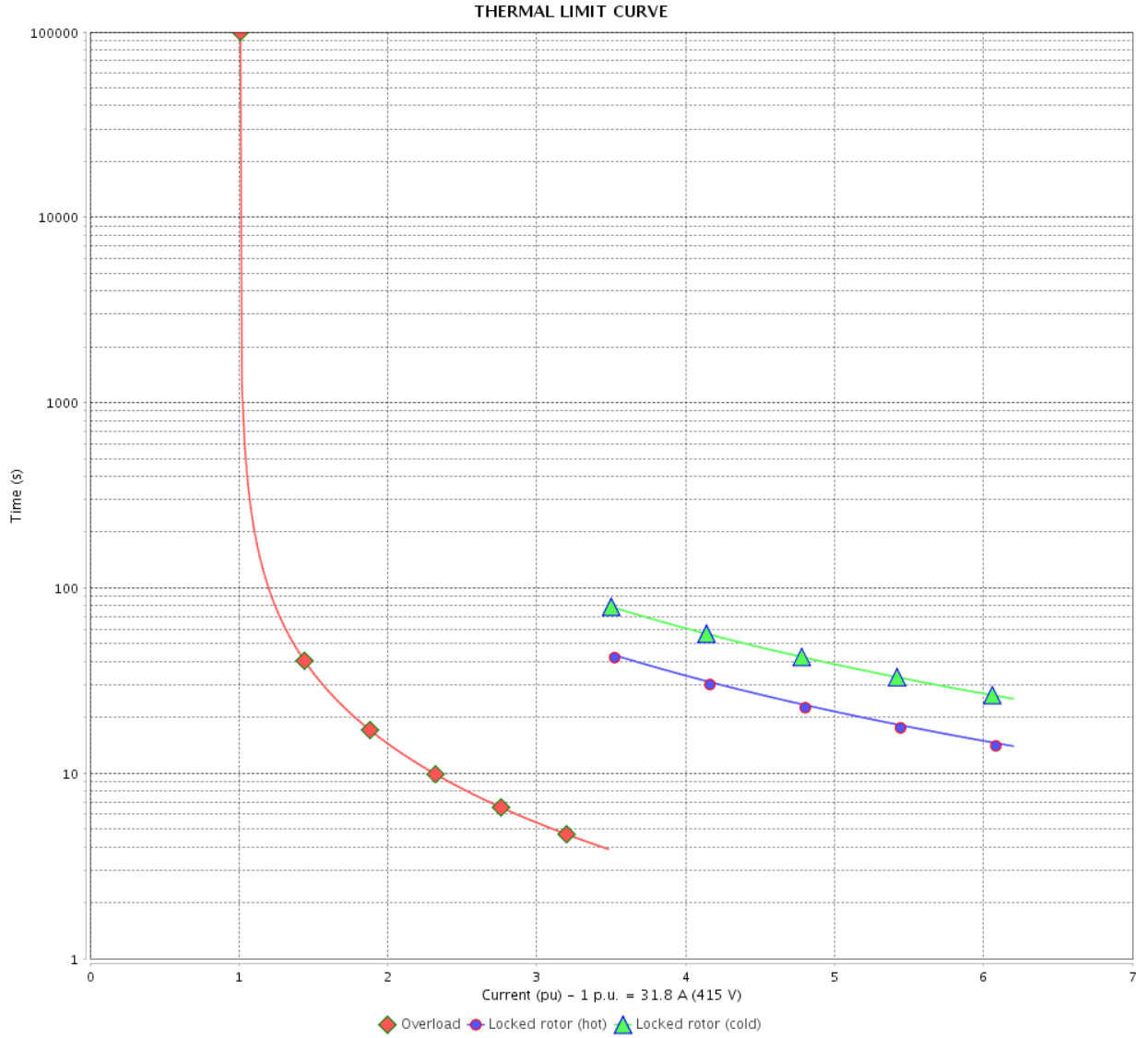

Rev.	Changes Summary	Performed	Checked	Date
Performed by		Page		Revision
Checked by		29 / 36		
Date		14/04/2022		

VFD OPERATION CURVE

Three Phase Induction Motor - Squirrel Cage



Customer :

Product line : NEMA Premium Efficiency Three-Phase

Product code : 13923290

Catalog # : 02536ST3QIE284TSC-W2

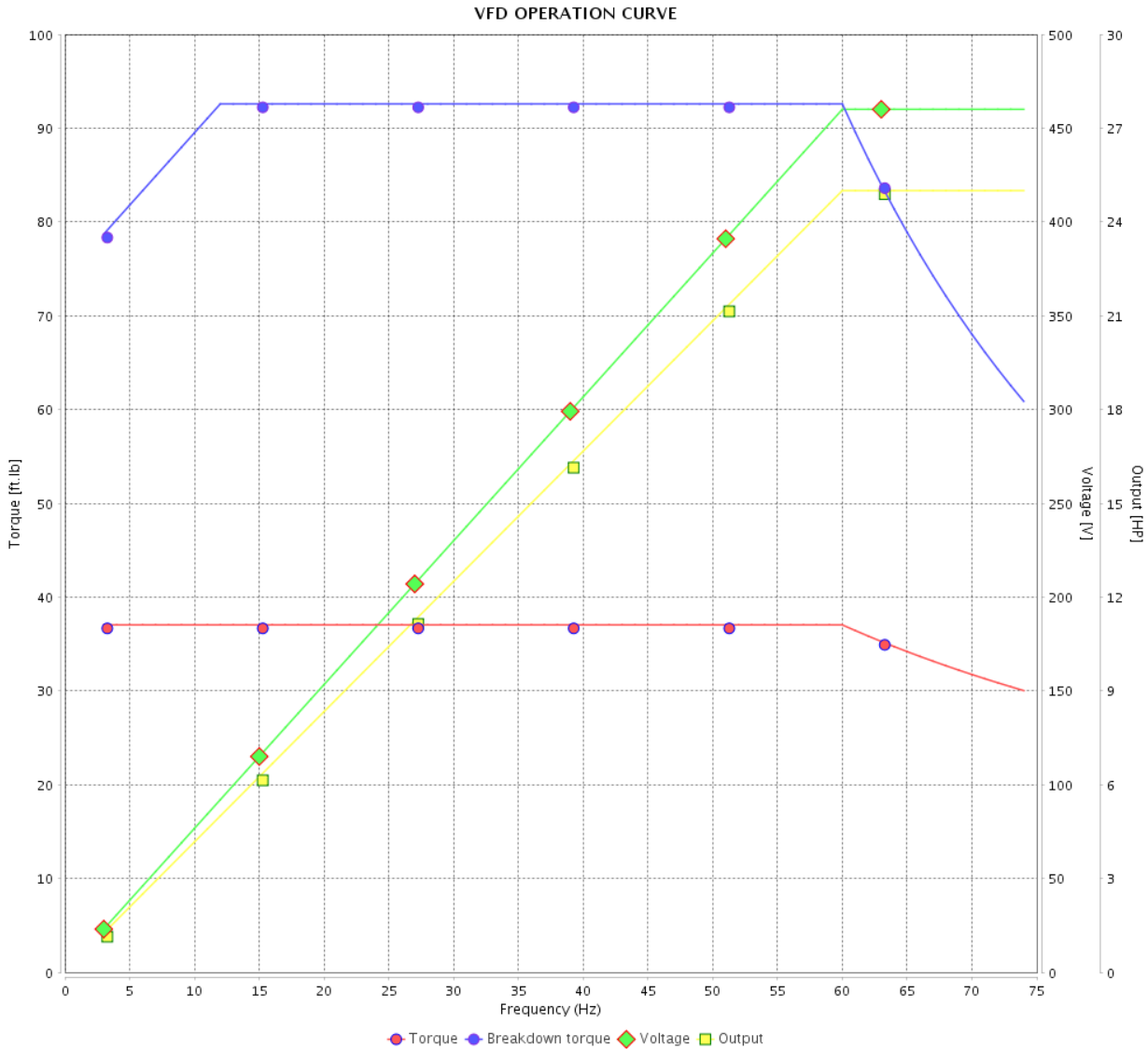

Performance : 460 V 60 Hz 2P

Rated current : 28.8 A
 LRC : 6.3
 Rated torque : 37.0 ft.lb
 Locked rotor torque : 200 %
 Breakdown torque : 250 %
 Rated speed : 3545 rpm

Moment of inertia (J) : 2.69 sq.ft.lb
 Duty cycle : Cont.(S1)
 Insulation class : F
 Service factor : 1.25
 Temperature rise : 80 K
 Design : B

Rev.	Changes Summary	Performed	Checked	Date
Performed by			Page 30 / 36	Revision
Checked by				
Date	14/04/2022			

VFD OPERATION CURVE

Three Phase Induction Motor - Squirrel Cage



Customer : _____

Product line : NEMA Premium Efficiency Three-Phase

Product code : 13923290

Catalog # : 02536ST3QIE284TSC-W2

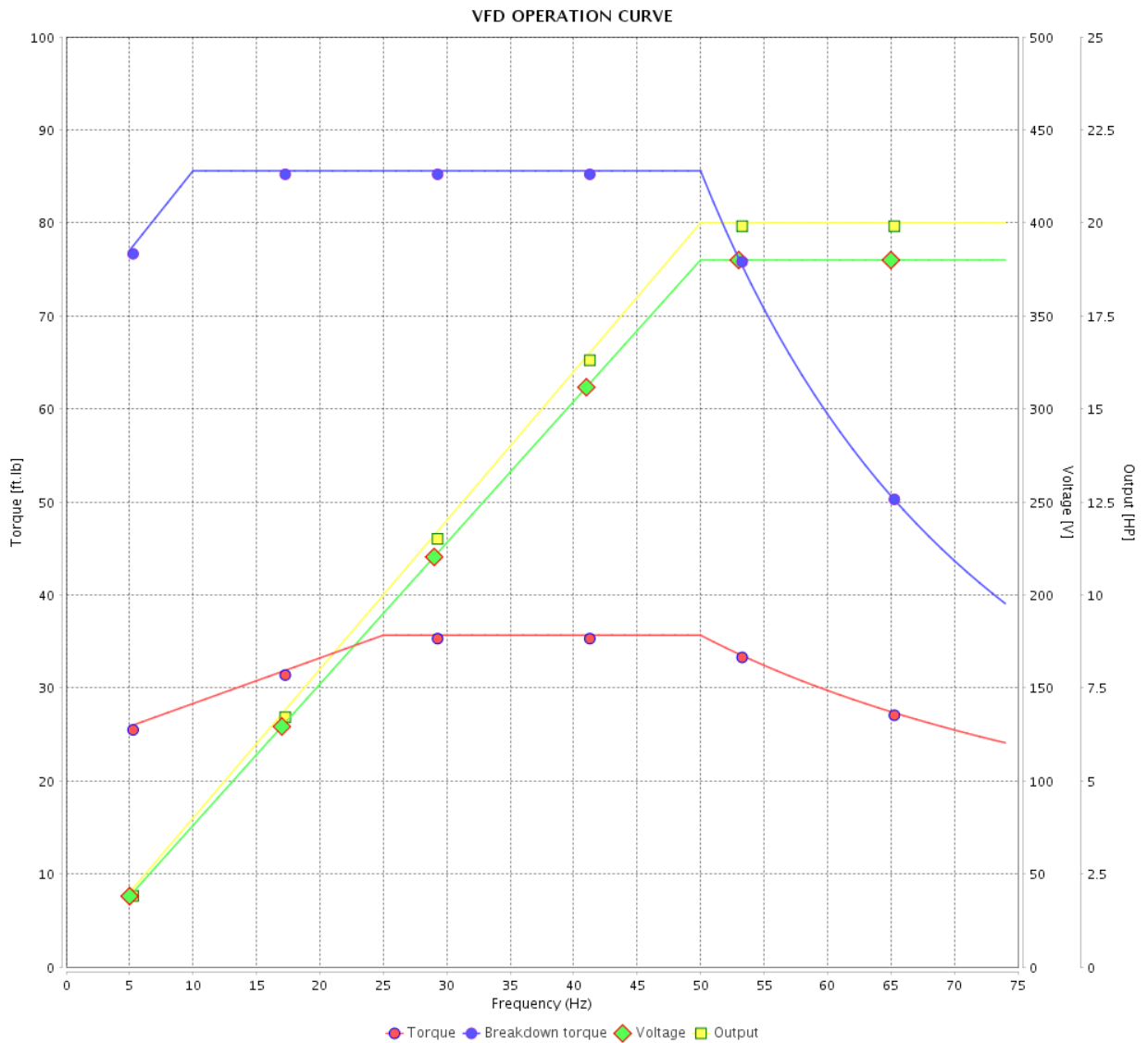

Performance : 380 V 50 Hz 2P IE3

Rated current : 27.9 A
 LRC : 6.2
 Rated torque : 35.7 ft.lb
 Locked rotor torque : 200 %
 Breakdown torque : 240 %
 Rated speed : 2945 rpm

Moment of inertia (J) : 2.69 sq.ft.lb
 Duty cycle : Cont.(S1)
 Insulation class : F
 Service factor : 1.00
 Temperature rise : 80 K
 Design : B

Rev.	Changes Summary	Performed	Checked	Date
Performed by		Page		Revision
Checked by		31 / 36		
Date		14/04/2022		

VFD OPERATION CURVE

Three Phase Induction Motor - Squirrel Cage



Customer : _____

Product line : NEMA Premium Efficiency Three-Phase

Product code : 13923290

Catalog # : 02536ST3QIE284TSC-W2

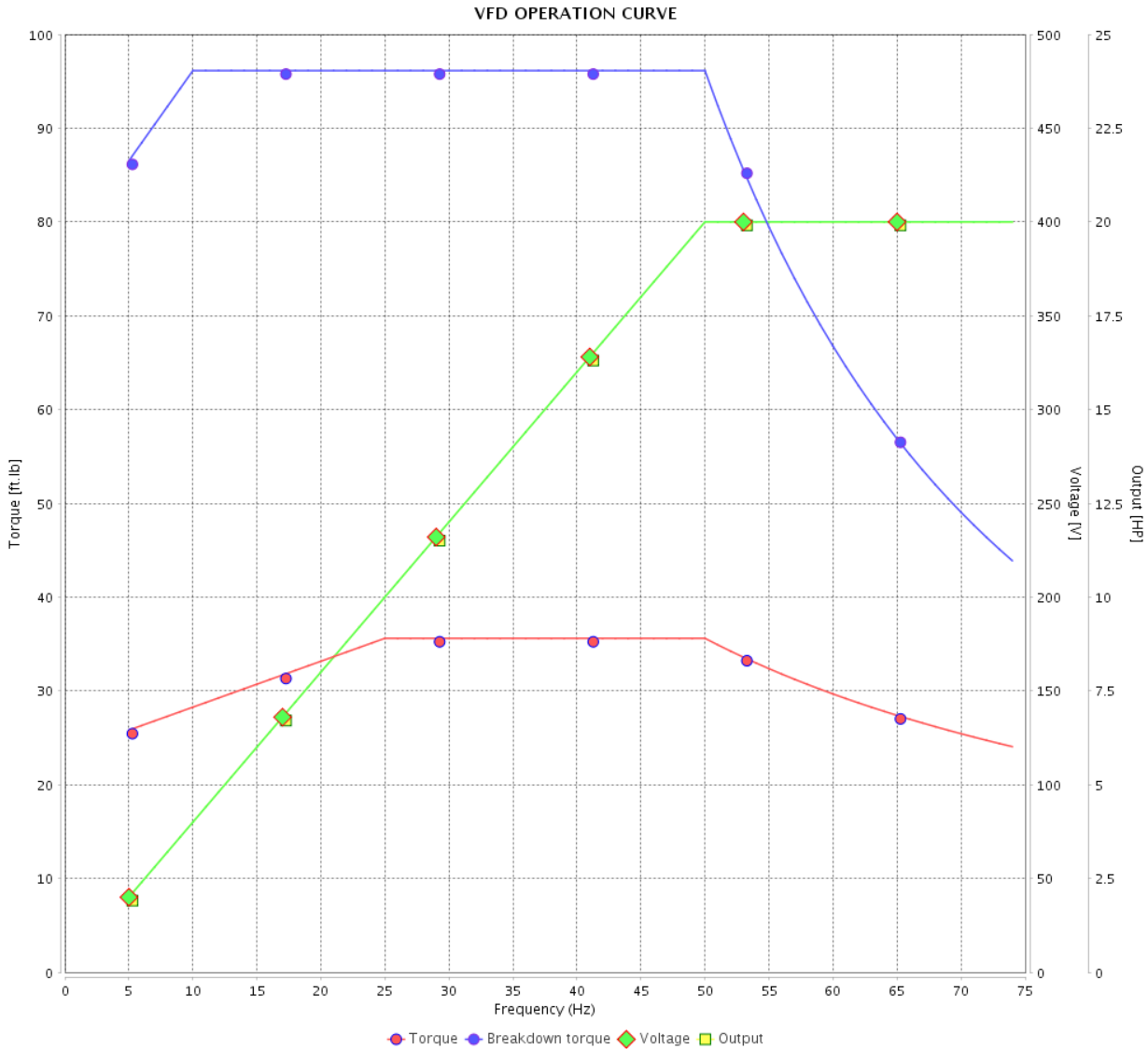

Performance : 400 V 50 Hz 2P IE3

Rated current	: 26.8 A	Moment of inertia (J)	: 2.69 sq.ft.lb
LRC	: 6.9	Duty cycle	: Cont.(S1)
Rated torque	: 35.6 ft.lb	Insulation class	: F
Locked rotor torque	: 229 %	Service factor	: 1.00
Breakdown torque	: 280 %	Temperature rise	: 80 K
Rated speed	: 2950 rpm	Design	: B

Rev.	Changes Summary	Performed	Checked	Date
Performed by			Page 32 / 36	Revision
Checked by				
Date	14/04/2022			

VFD OPERATION CURVE

Three Phase Induction Motor - Squirrel Cage



Customer :

Product line : NEMA Premium Efficiency Three-Phase

Product code : 13923290

Catalog # : 02536ST3QIE284TSC-W2

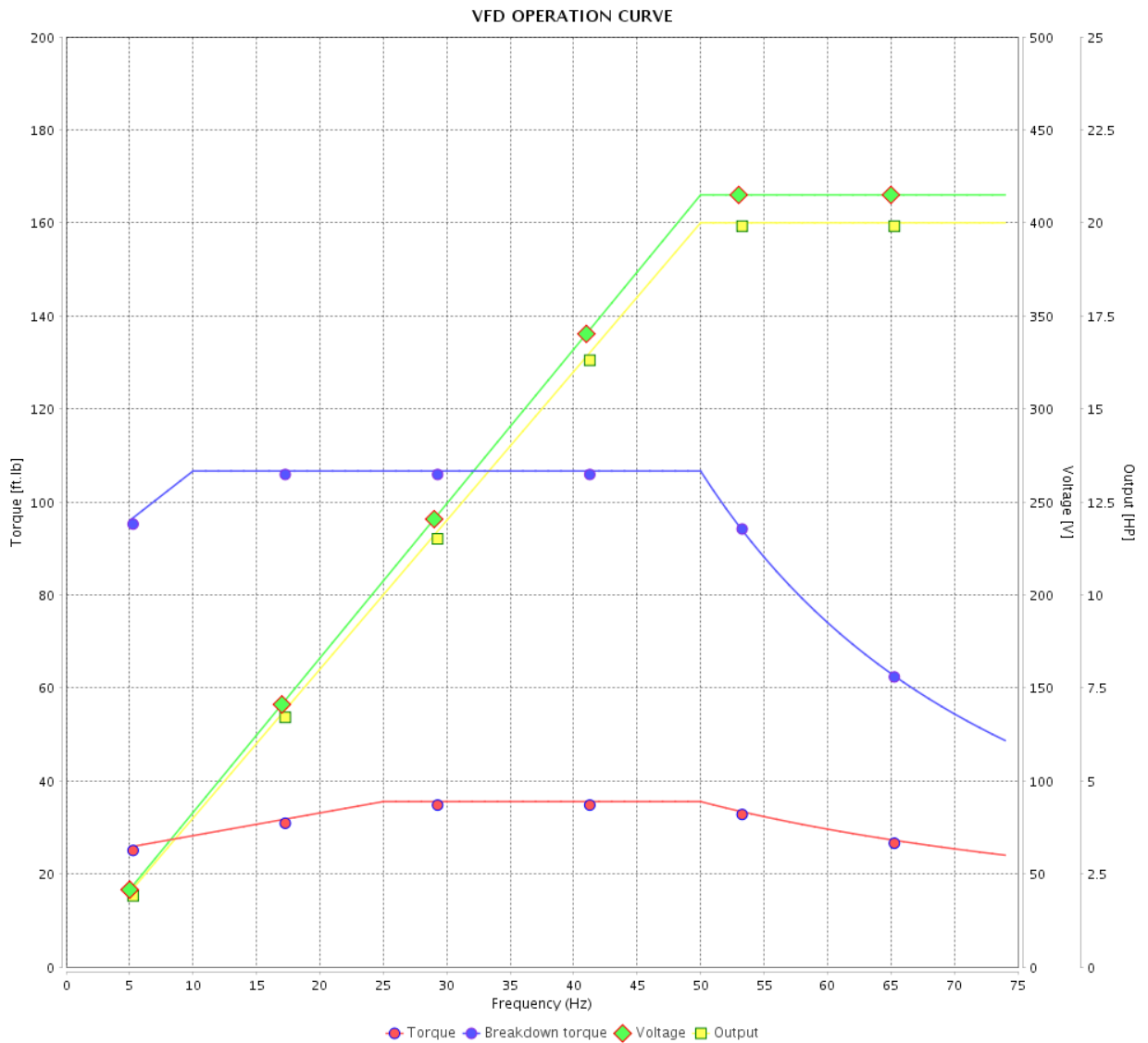

Performance : 415 V 50 Hz 2P IE3

Rated current : 26.1 A
 LRC : 7.4
 Rated torque : 35.5 ft.lb
 Locked rotor torque : 240 %
 Breakdown torque : 300 %
 Rated speed : 2955 rpm

Moment of inertia (J) : 2.69 sq.ft.lb
 Duty cycle : Cont.(S1)
 Insulation class : F
 Service factor : 1.00
 Temperature rise : 80 K
 Design : B

Rev.	Changes Summary	Performed	Checked	Date
Performed by		Page		Revision
Checked by		33 / 36		
Date		14/04/2022		

VFD OPERATION CURVE

Three Phase Induction Motor - Squirrel Cage



Customer :

Product line : NEMA Premium Efficiency Three-Phase

Product code : 13923290

Catalog # : 02536ST3QIE284TSC-W2

VFD OPERATION CURVE

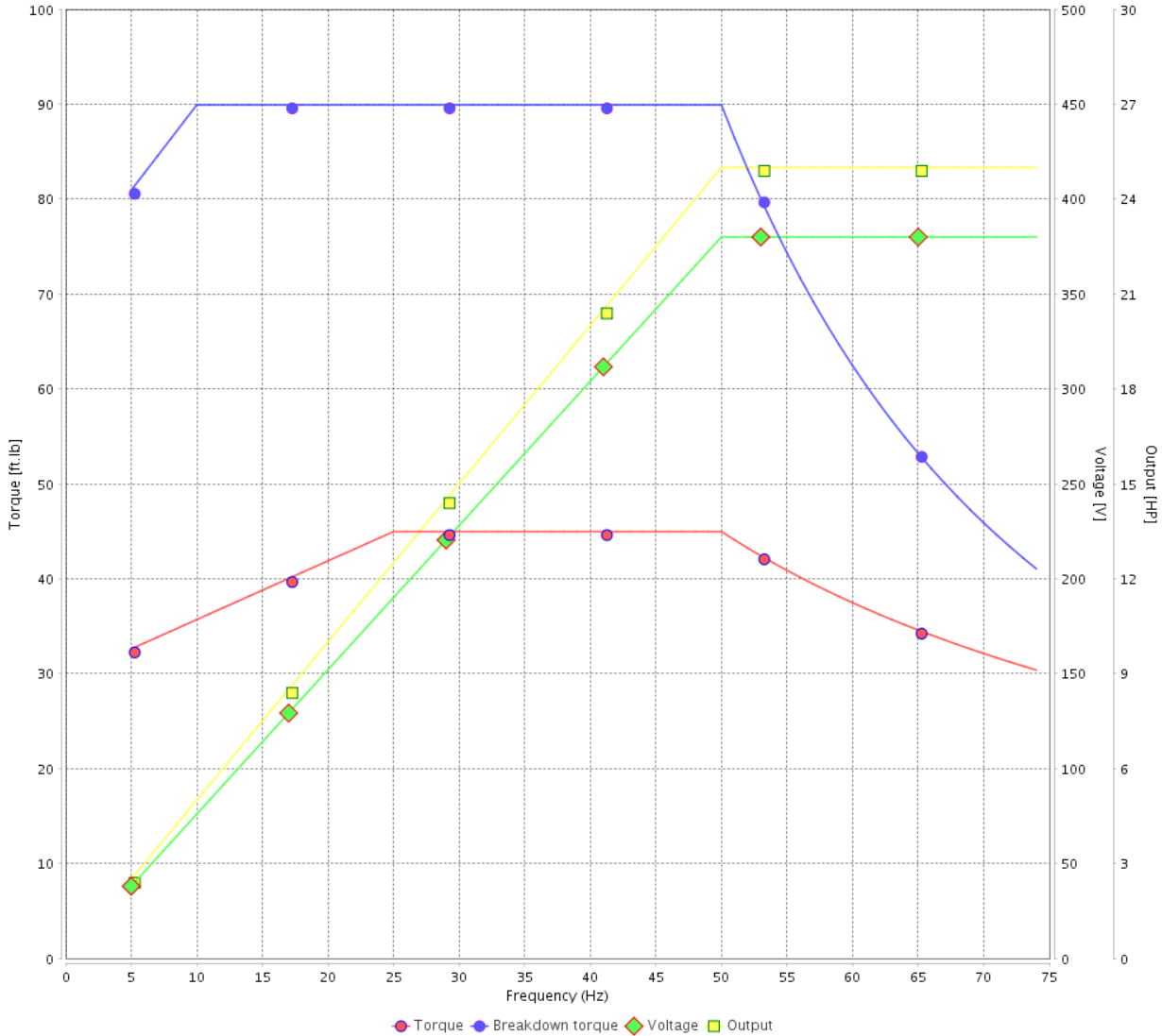

Performance : 380 V 50 Hz 2P IE1

Rated current : 34.9 A
 LRC : 4.9
 Rated torque : 45.0 ft.lb
 Locked rotor torque : 160 %
 Breakdown torque : 200 %
 Rated speed : 2910 rpm

Moment of inertia (J) : 2.69 sq.ft.lb
 Duty cycle : Cont.(S1)
 Insulation class : F
 Service factor : 1.00
 Temperature rise : 105 K
 Design : B

Rev.	Changes Summary	Performed	Checked	Date
Performed by			Page 34 / 36	Revision
Checked by				
Date	14/04/2022			

VFD OPERATION CURVE

Three Phase Induction Motor - Squirrel Cage



Customer : _____

Product line : NEMA Premium Efficiency Three-Phase

Product code : 13923290

Catalog # : 02536ST3QIE284TSC-W2

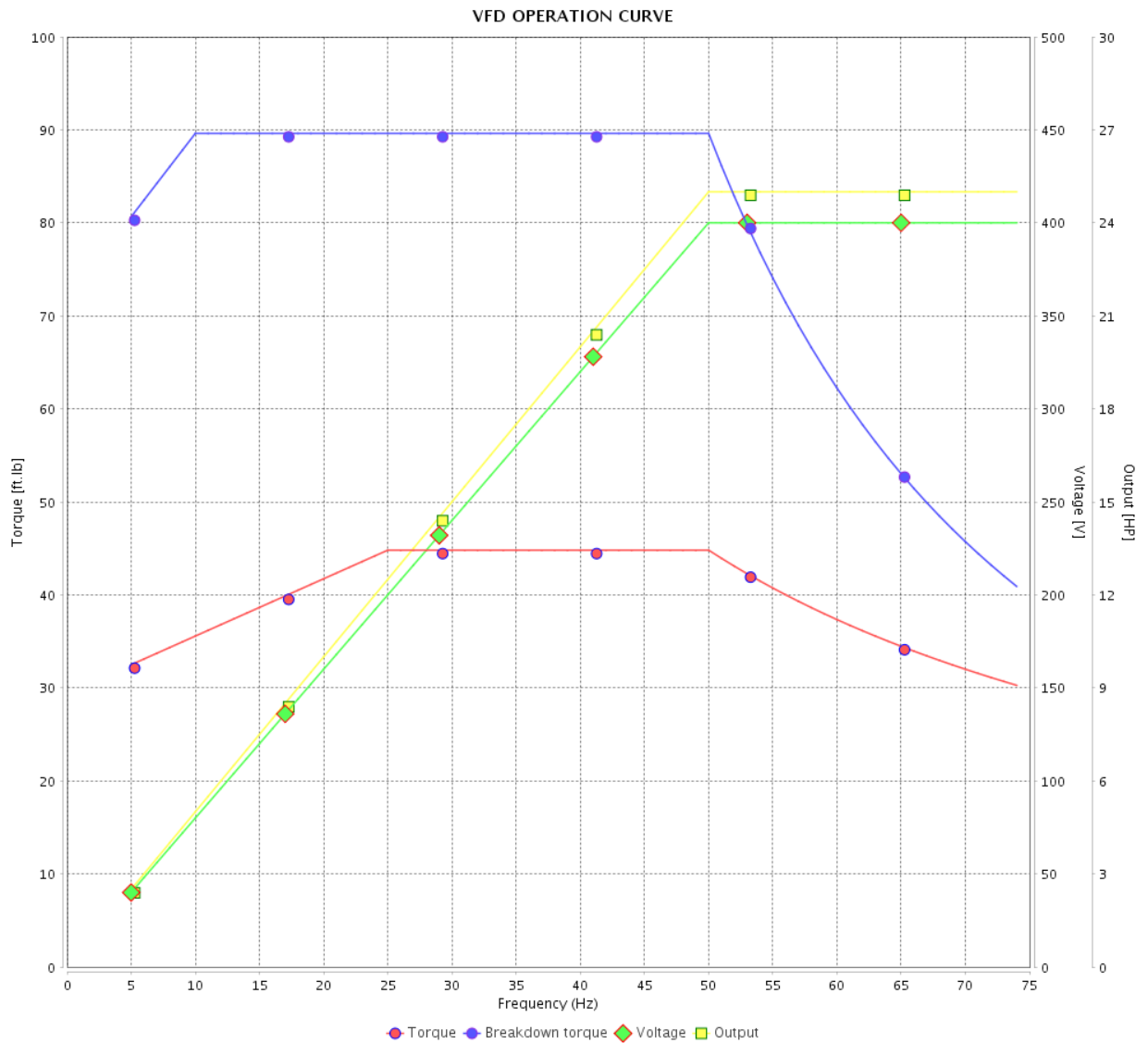

Performance : 400 V 50 Hz 2P IE1

Rated current : 33.3 A
 LRC : 5.5
 Rated torque : 44.8 ft.lb
 Locked rotor torque : 180 %
 Breakdown torque : 220 %
 Rated speed : 2930 rpm

Moment of inertia (J) : 2.69 sq.ft.lb
 Duty cycle : Cont.(S1)
 Insulation class : F
 Service factor : 1.00
 Temperature rise : 105 K
 Design : B

Rev.	Changes Summary	Performed	Checked	Date
Performed by		Page		Revision
Checked by		35 / 36		
Date		14/04/2022		

VFD OPERATION CURVE

Three Phase Induction Motor - Squirrel Cage



Customer :

Product line : NEMA Premium Efficiency Three-Phase

Product code : 13923290

Catalog # : 02536ST3QIE284TSC-W2

VFD OPERATION CURVE

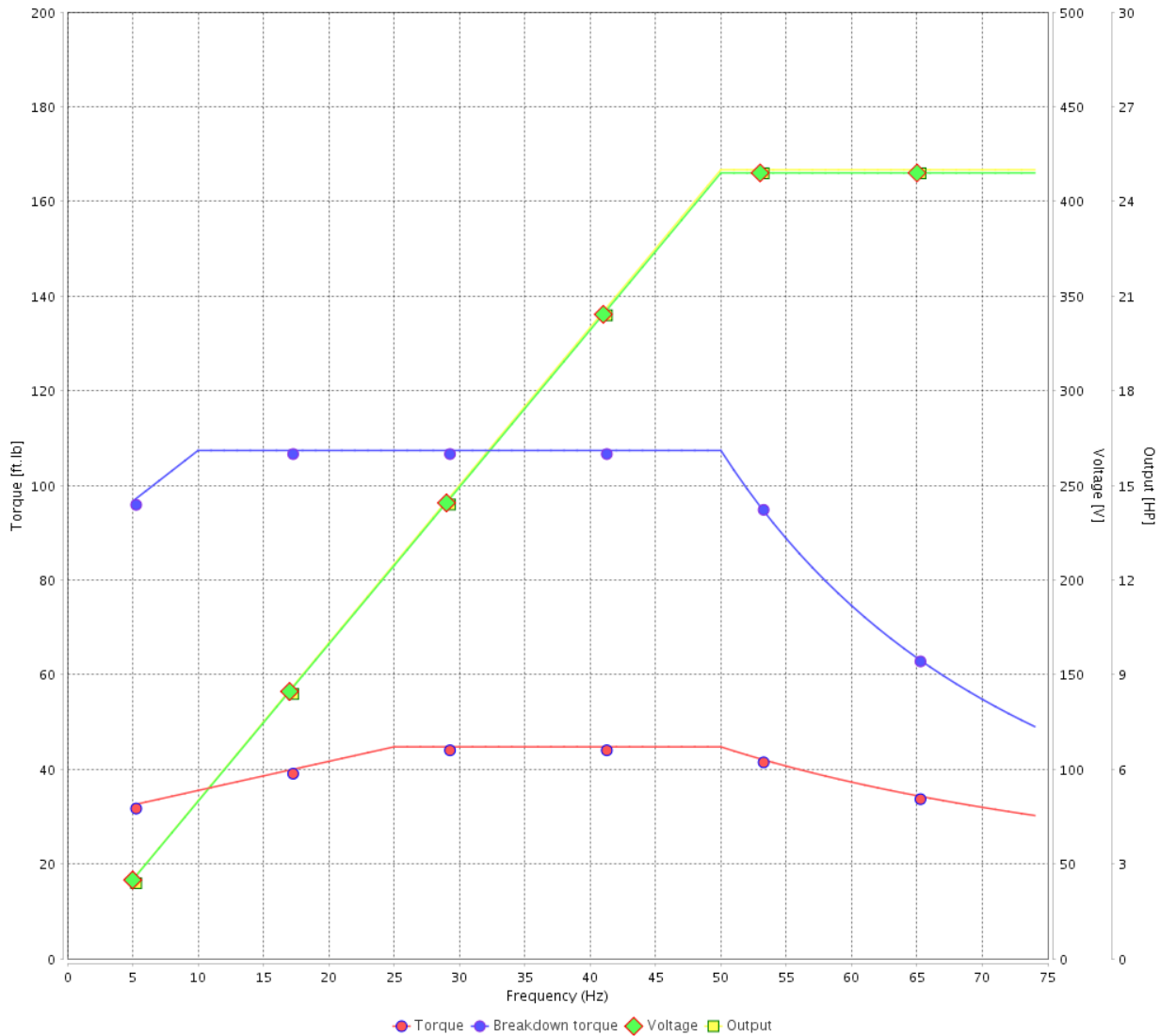

Performance : 415 V 50 Hz 2P IE2

Rated current : 31.8 A
 LRC : 6.0
 Rated torque : 44.7 ft.lb
 Locked rotor torque : 190 %
 Breakdown torque : 240 %
 Rated speed : 2935 rpm

Moment of inertia (J) : 2.69 sq.ft.lb
 Duty cycle : Cont.(S1)
 Insulation class : F
 Service factor : 1.00
 Temperature rise : 105 K
 Design : B

Rev.	Changes Summary	Performed	Checked	Date
Performed by			Page 36 / 36	Revision
Checked by				
Date	14/04/2022			

1 2 3 4 5 6

A

B

C

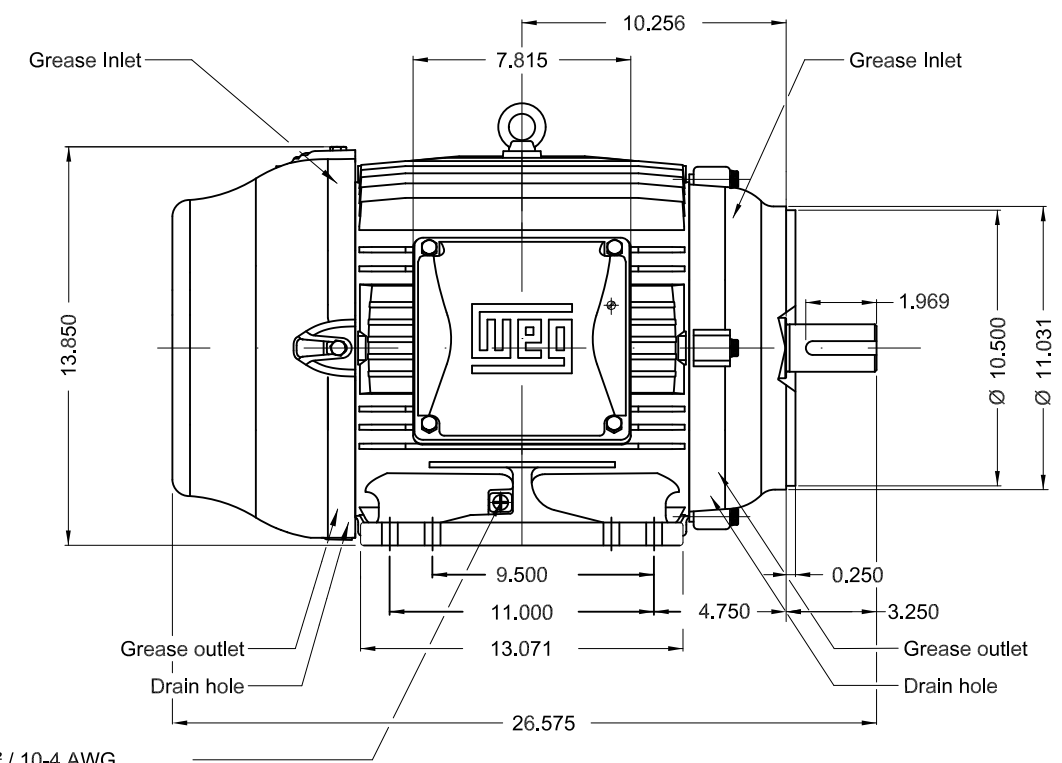
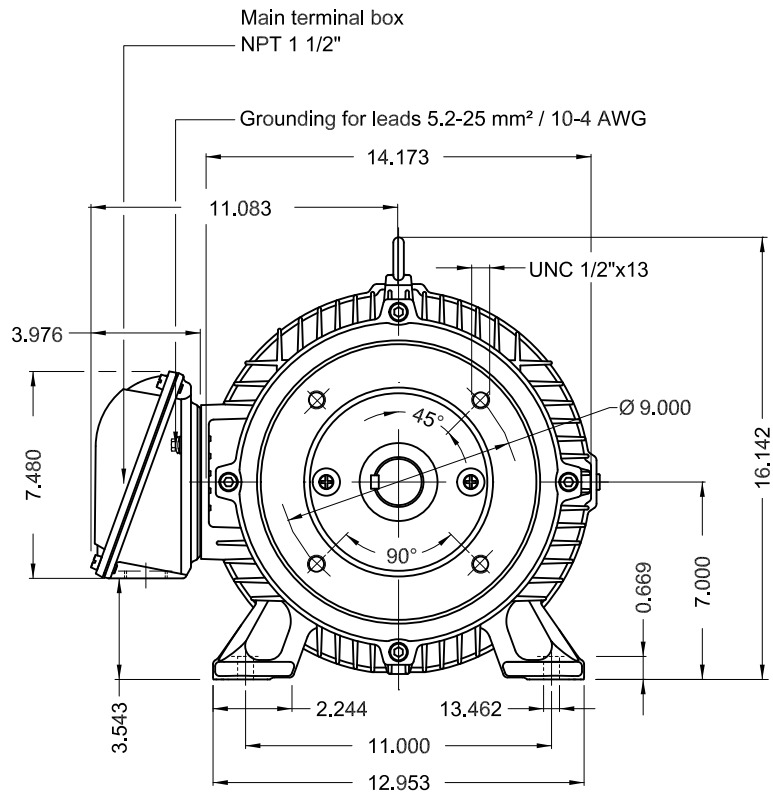

Grounding for leads 5.2-25 mm² / 10-4 AWG

D

E

Without vertical jackscrews
Color RAL 5009
Painting plan 202E
Mounting NEMA F-1
Mounting B34R(D)

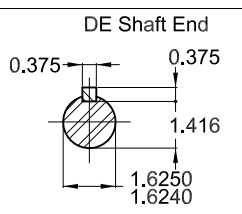

25 HP 02 Poles 60 Hz A

ECM	LOC	SUMMARY OF MODIFICATIONS	EXECUTED	CHECKED	RELEASED	DATE	VER
EXECUTED	PIRWBUSER	THREE PH. MOTOR IEEE 841 W22 PREM. EFF.					
CHECKED		FRAME 284/6TSC IP55 TEFC					
RELEASED							
REL DT.	WMO	Jaragua do Sul	Product Engineering	SHEET	1 / 1		

PREVIEW
WDD





NEMA
Premium
W22



FOR SAFE AREA
Mod.TE1BFOXON
CC029A



Class I, Div 2, Gr A, B, C and D - T3
Class I, Zone 2, IIC - T3
Class II, Div 2, Gr F and G - T4
For use on PWM: Gr. A, B, C, D and F,
VT 1000:1, CT 20:1, 1.00SF - T3A

MODEL 02536ST3QIE284TSC-W2



Inverter Duty Motor
Severe Duty

MADE IN BRAZIL
13923290

PH3 60Hz Fr. 284/6TSC 1000m.a.s.l. IP55 TEFC 419lb

V 460

A 29.1

HP 25

kW 18.5

SF 1.25

SFA 36.4

RPM 3545

PF 0.87

AMB 40°C

INS cl. F DT80K

NEMA NOM EFF 91.7%

DUTY CONT.

DES B Code G

GUARANT. EFF 90.2%

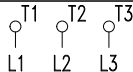

460V



→ 6311-C3 (18g) 55BC03X30

→ 6211-C3 (11g) 55BC02X30



MOBIL POLYREX EM (14000h)

