

DATA SHEET



Three Phase Induction Motor - Squirrel Cage

Customer							
Product line		: NEMA Premium Efficiency Three-Phase		Product code :		12039624	
				Catalog # :		03012ST3QIE326TC-W22	
Frame		: 324/6TC		Cooling method		: IC411 - TEFC	
Insulation class		: F		Mounting		: F-1	
Duty cycle		: Cont.(S1)		Rotation ¹		: Both (CW and CCW)	
Ambient temperature		: -20°C to +40°C		Starting method		: Direct On Line	
Altitude		: 1000 m.a.s.l.		Approx. weight ²		: 612 lb	
Protection degree		: IP55		Moment of inertia (J)		: 13.2 sq.ft.lb	
Design		: B					
Output [HP]	30	25	25	25	30	30	30
Poles	6	6	6	6	6	6	6
Frequency [Hz]	60	50	50	50	50	50	50
Rated voltage [V]	460	380	400	415	380	400	415
Rated current [A]	36.2	36.9	36.2	35.4	43.7	41.7	40.7
L. R. Amperes [A]	224	214	228	237	214	225	236
LRC [A]	6.2x(Code G)	5.8x(Code G)	6.3x(Code H)	6.7x(Code H)	4.9x(Code E)	5.4x(Code F)	5.8x(Code G)
No load current [A]	14.5	14.0	15.0	16.0	14.0	15.0	16.0
Rated speed [RPM]	1180	975	980	980	970	975	980
Slip [%]	1.67	2.50	2.00	2.00	3.00	2.50	2.00
Rated torque [ft.lb]	134	135	134	134	162	162	161
Locked rotor torque [%]	220	190	220	240	160	180	200
Breakdown torque [%]	240	229	260	280	200	220	240
Service factor	1.25	1.00	1.15	1.15	1.00	1.15	1.15
Temperature rise	80 K	80 K	80 K	80 K	80 K	80 K	80 K
Locked rotor time	37s (cold)	27s (cold)	27s (cold)	27s (cold)	27s (cold)	27s (cold)	27s (cold)
	21s (hot)	15s (hot)	15s (hot)	15s (hot)	15s (hot)	15s (hot)	15s (hot)
Noise level ²	62.0 dB(A)	60.0 dB(A)	60.0 dB(A)	60.0 dB(A)	60.0 dB(A)	60.0 dB(A)	60.0 dB(A)
Efficiency (%)	25%	91.5	91.2	91.2	90.4	92.1	91.3
	50%	91.7	91.3	91.3	90.7	91.7	91.0
	75%	93.0	91.8	92.2	91.9	91.7	92.4
	100%	93.0	91.7	92.1	92.0	91.0	91.7
Power Factor	25%	0.42	0.41	0.39	0.36	0.48	0.41
	50%	0.65	0.64	0.61	0.58	0.71	0.65
	75%	0.77	0.76	0.74	0.71	0.81	0.76
	100%	0.82	0.83	0.80	0.79	0.84	0.82
Bearing type		Drive end	Non drive end	Foundation loads			
Sealing		Inpro/Seal	Inpro/Seal	Max. traction		: 1175 lb	
Lubrication interval		20000 h	20000 h	Max. compression		: 1787 lb	
Lubricant amount		21 g	13 g				
Lubricant type		Mobil Polyrex EM					
Notes							
This revision replaces and cancel the previous one, which must be eliminated. (1) Looking the motor from the shaft end. (2) Measured at 1m and with tolerance of +3dB(A). (3) Approximate weight subject to changes after manufacturing process. (4) At 100% of full load.				These are average values based on tests with sinusoidal power supply, subject to the tolerances stipulated in NEMA MG-1.			
Rev.	Changes Summary			Performed	Checked	Date	
Performed by							
Checked by					Page	Revision	
Date	14/04/2022				1 / 36		

TORQUE AND CURRENT VS SPEED CURVE

Three Phase Induction Motor - Squirrel Cage



Customer :

Product line : NEMA Premium Efficiency Three-Phase

Product code : 12039624

Catalog # : 03012ST3QIE326TC-W22

TORQUE AND CURRENT VS SPEED CURVE

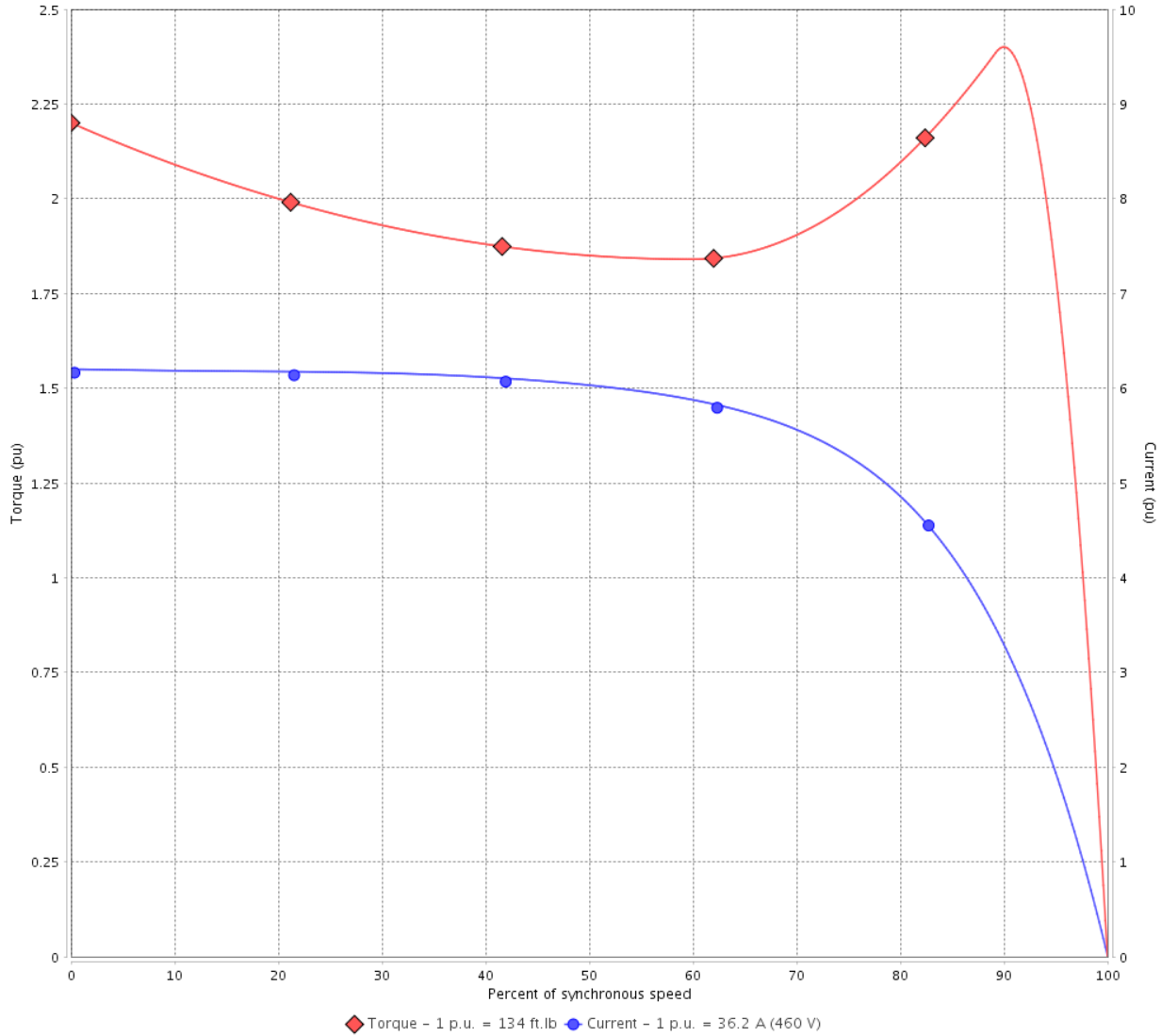

Performance : 460 V 60 Hz 6P

Rated current	: 36.2 A	Moment of inertia (J)	: 13.2 sq.ft.lb
LRC	: 6.2	Duty cycle	: Cont.(S1)
Rated torque	: 134 ft.lb	Insulation class	: F
Locked rotor torque	: 220 %	Service factor	: 1.25
Breakdown torque	: 240 %	Temperature rise	: 80 K
Rated speed	: 1180 rpm	Design	: B

Locked rotor time : 37s (cold) 21s (hot)

Rev.	Changes Summary	Performed	Checked	Date
Performed by			Page 2 / 36	Revision
Checked by				
Date	14/04/2022			

TORQUE AND CURRENT VS SPEED CURVE



Three Phase Induction Motor - Squirrel Cage

Customer :

Product line : NEMA Premium Efficiency Three-Phase

Product code : 12039624

Catalog # : 03012ST3QIE326TC-W22

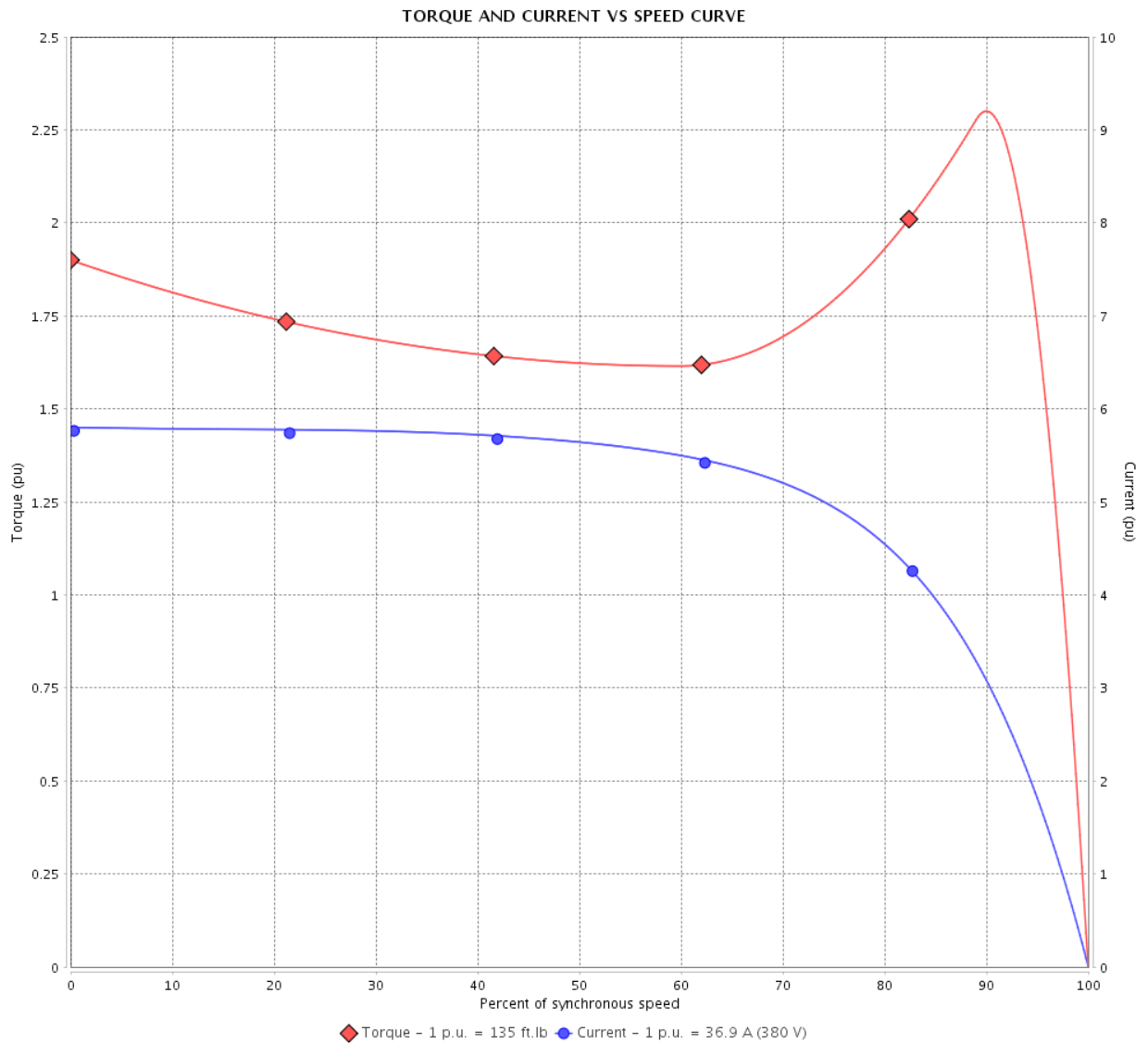

Performance : 380 V 50 Hz 6P IE3

Rated current	: 36.9 A	Moment of inertia (J)	: 13.2 sq.ft.lb
LRC	: 5.8	Duty cycle	: Cont.(S1)
Rated torque	: 135 ft.lb	Insulation class	: F
Locked rotor torque	: 190 %	Service factor	: 1.00
Breakdown torque	: 229 %	Temperature rise	: 80 K
Rated speed	: 975 rpm	Design	: B

Locked rotor time : 27s (cold) 15s (hot)

Rev.	Changes Summary	Performed	Checked	Date
Performed by			Page 3 / 36	Revision
Checked by				
Date	14/04/2022			

TORQUE AND CURRENT VS SPEED CURVE

Three Phase Induction Motor - Squirrel Cage



Customer :

Product line : NEMA Premium Efficiency Three-Phase

Product code : 12039624

Catalog # : 03012ST3QIE326TC-W22

TORQUE AND CURRENT VS SPEED CURVE

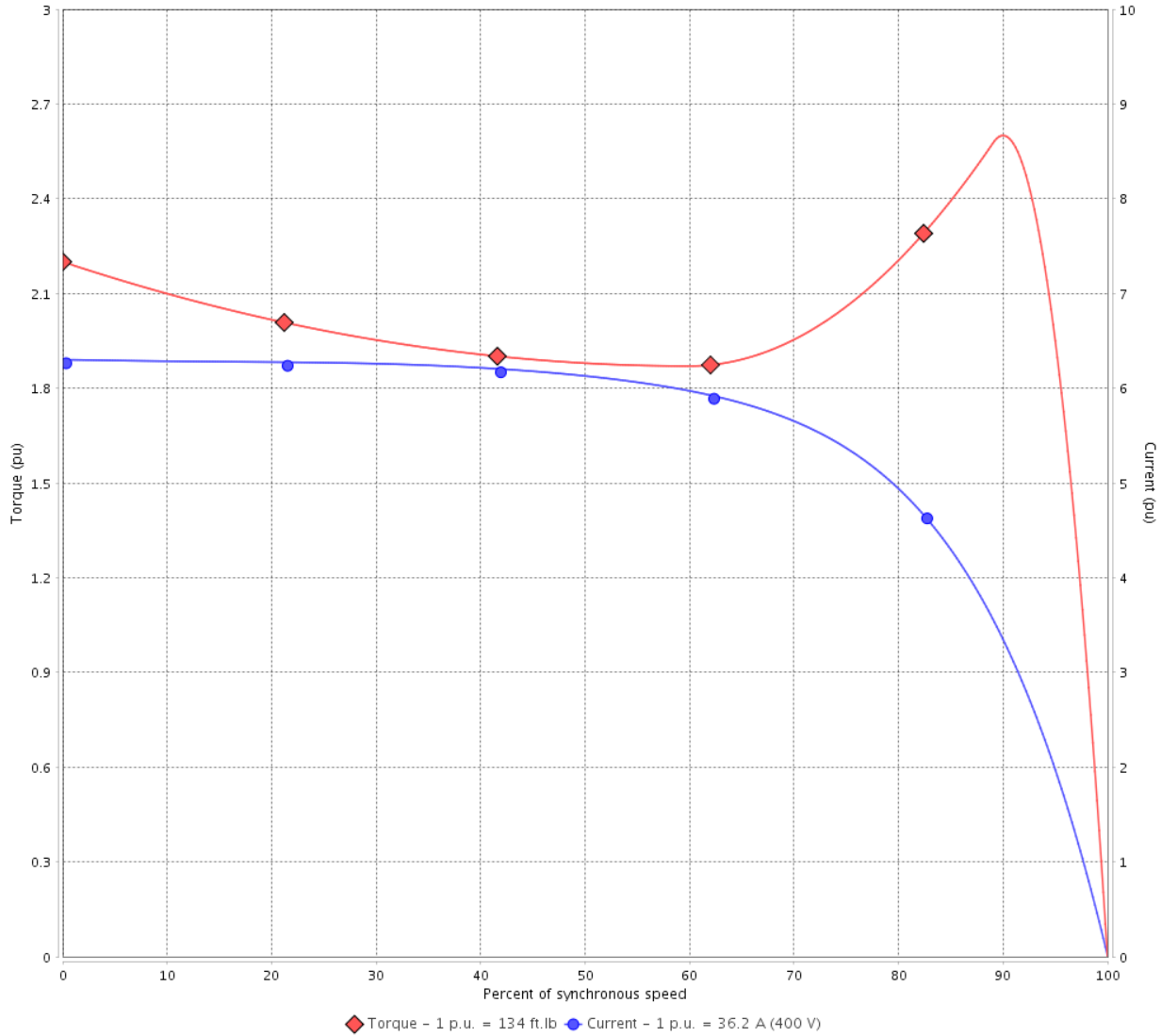

Performance : 400 V 50 Hz 6P IE3

Rated current	: 36.2 A	Moment of inertia (J)	: 13.2 sq.ft.lb
LRC	: 6.3	Duty cycle	: Cont.(S1)
Rated torque	: 134 ft.lb	Insulation class	: F
Locked rotor torque	: 220 %	Service factor	: 1.15
Breakdown torque	: 260 %	Temperature rise	: 80 K
Rated speed	: 980 rpm	Design	: B

Locked rotor time : 27s (cold) 15s (hot)

Rev.	Changes Summary	Performed	Checked	Date
Performed by			Page 4 / 36	Revision
Checked by				
Date	14/04/2022			

TORQUE AND CURRENT VS SPEED CURVE



Three Phase Induction Motor - Squirrel Cage

Customer :

Product line : NEMA Premium Efficiency Three-Phase

Product code : 12039624

Catalog # : 03012ST3QIE326TC-W22

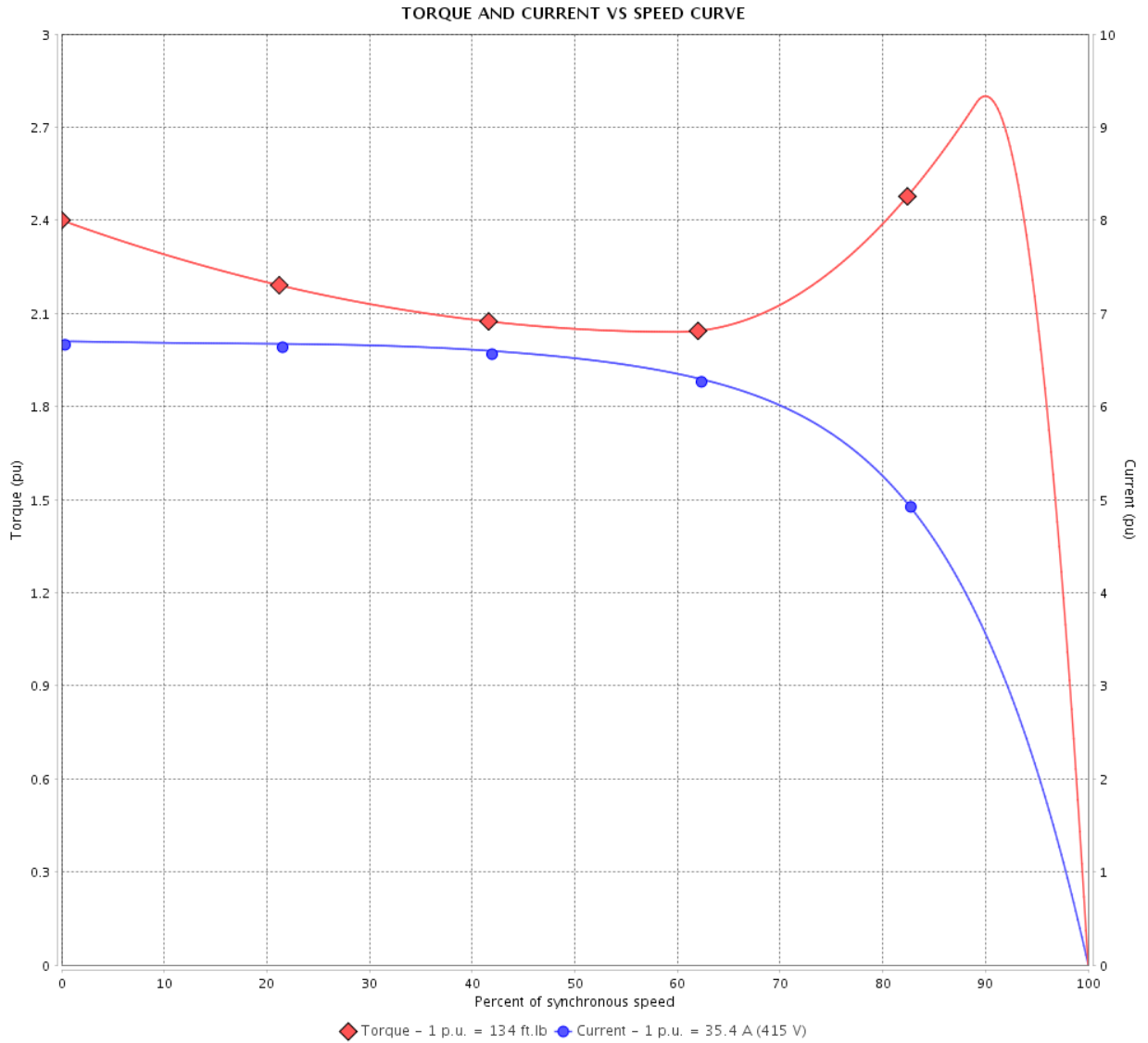

Performance : 415 V 50 Hz 6P IE3

Rated current	: 35.4 A	Moment of inertia (J)	: 13.2 sq.ft.lb
LRC	: 6.7	Duty cycle	: Cont.(S1)
Rated torque	: 134 ft.lb	Insulation class	: F
Locked rotor torque	: 240 %	Service factor	: 1.15
Breakdown torque	: 280 %	Temperature rise	: 80 K
Rated speed	: 980 rpm	Design	: B

Locked rotor time : 27s (cold) 15s (hot)

Rev.	Changes Summary	Performed	Checked	Date
Performed by			Page 5 / 36	Revision
Checked by				
Date	14/04/2022			

TORQUE AND CURRENT VS SPEED CURVE

Three Phase Induction Motor - Squirrel Cage



Customer :

Product line : NEMA Premium Efficiency Three-Phase

Product code : 12039624

Catalog # : 03012ST3QIE326TC-W22

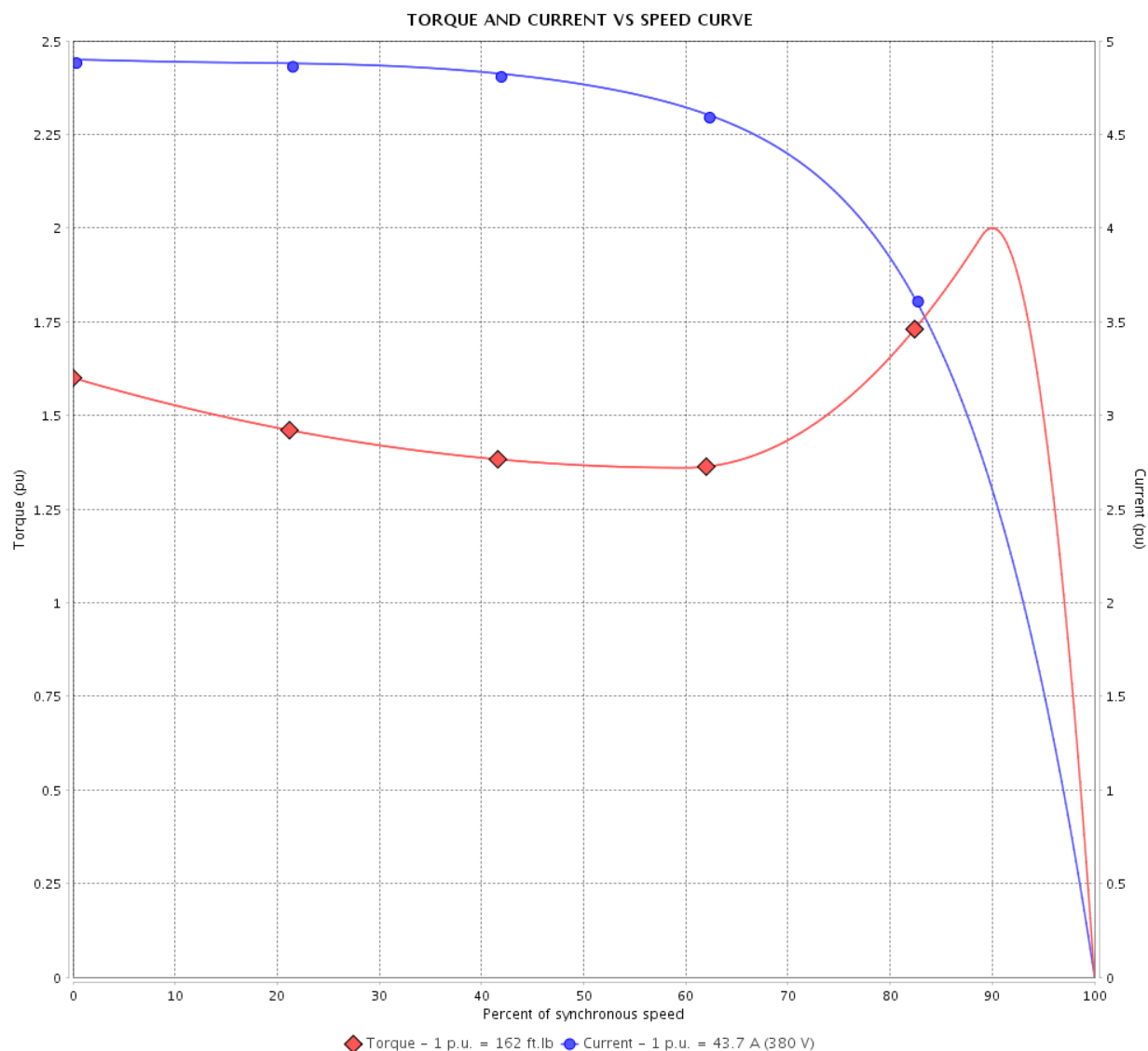

Performance : 380 V 50 Hz 6P IE2

Rated current	: 43.7 A	Moment of inertia (J)	: 13.2 sq.ft.lb
LRC	: 4.9	Duty cycle	: Cont.(S1)
Rated torque	: 162 ft.lb	Insulation class	: F
Locked rotor torque	: 160 %	Service factor	: 1.00
Breakdown torque	: 200 %	Temperature rise	: 80 K
Rated speed	: 970 rpm	Design	: B

Locked rotor time : 27s (cold) 15s (hot)

Rev.	Changes Summary	Performed	Checked	Date
Performed by			Page 6 / 36	Revision
Checked by				
Date	14/04/2022			

TORQUE AND CURRENT VS SPEED CURVE



Three Phase Induction Motor - Squirrel Cage

Customer :

Product line : NEMA Premium Efficiency Three-Phase

Product code : 12039624

Catalog # : 03012ST3QIE326TC-W22

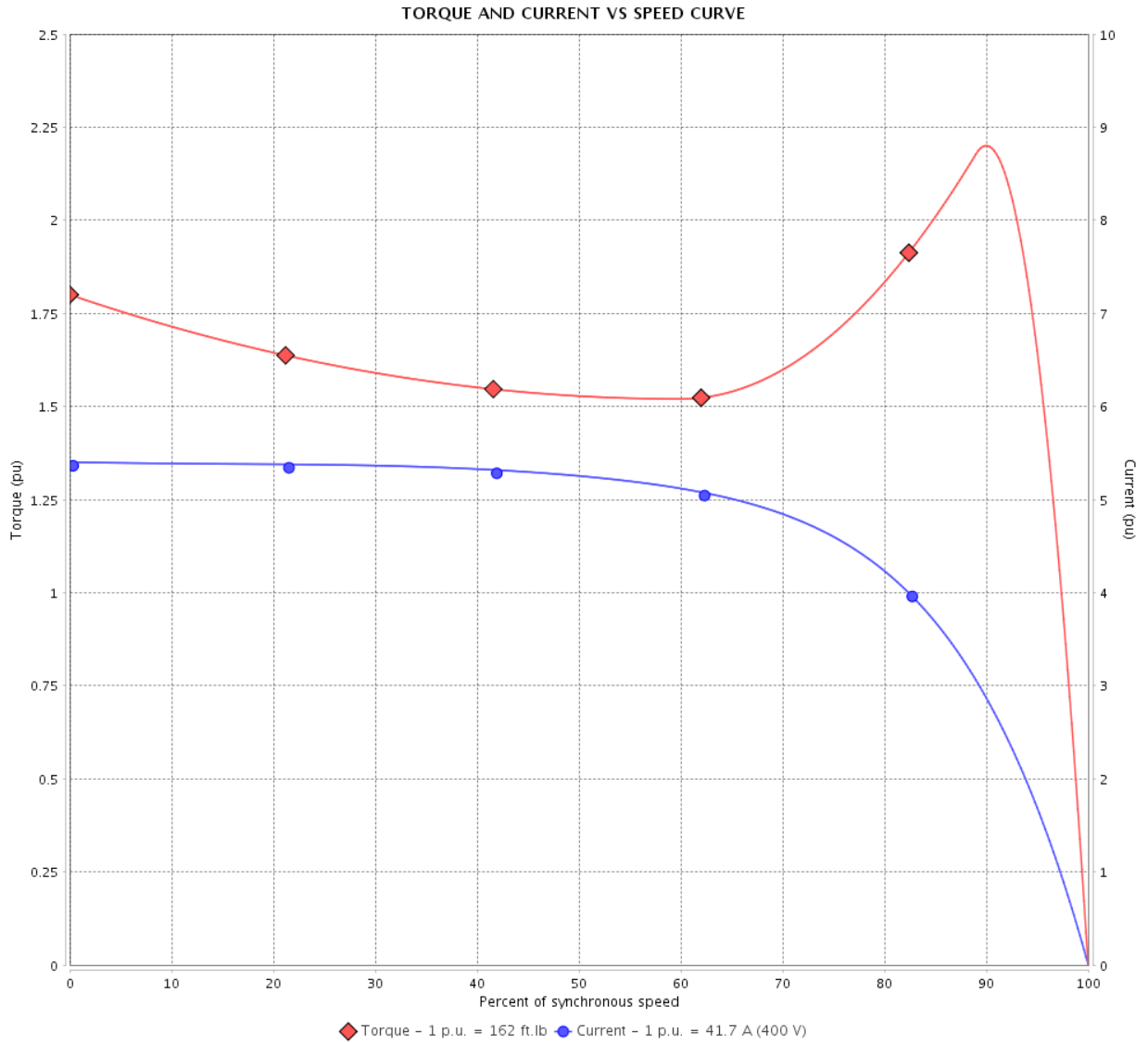

Performance : 400 V 50 Hz 6P IE2

Rated current	: 41.7 A	Moment of inertia (J)	: 13.2 sq.ft.lb
LRC	: 5.4	Duty cycle	: Cont.(S1)
Rated torque	: 162 ft.lb	Insulation class	: F
Locked rotor torque	: 180 %	Service factor	: 1.15
Breakdown torque	: 220 %	Temperature rise	: 80 K
Rated speed	: 975 rpm	Design	: B

Locked rotor time : 27s (cold) 15s (hot)

Rev.	Changes Summary	Performed	Checked	Date
Performed by			Page 7 / 36	Revision
Checked by				
Date	14/04/2022			

TORQUE AND CURRENT VS SPEED CURVE

Three Phase Induction Motor - Squirrel Cage



Customer :

Product line : NEMA Premium Efficiency Three-Phase

Product code : 12039624

Catalog # : 03012ST3QIE326TC-W22

TORQUE AND CURRENT VS SPEED CURVE

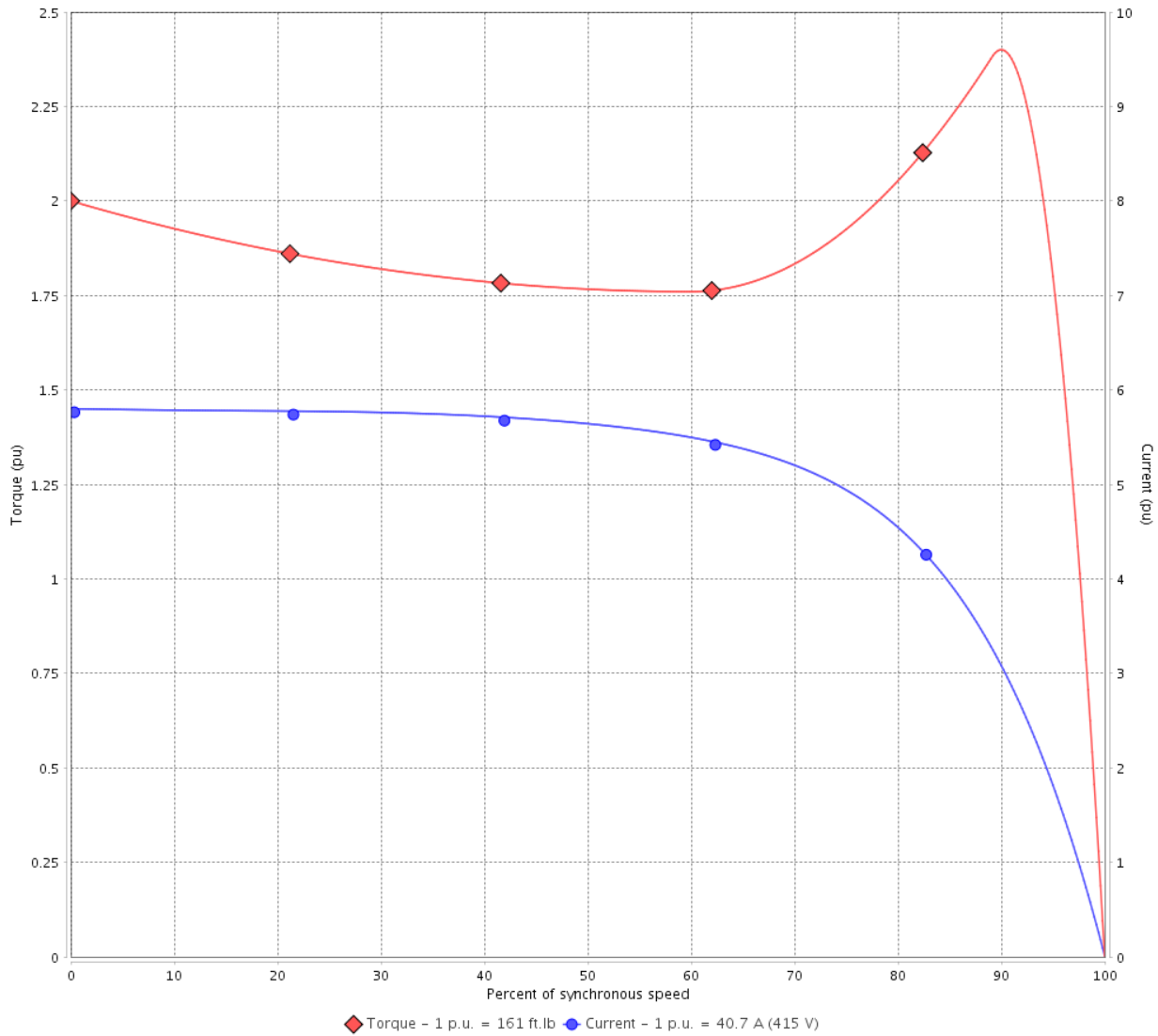

Performance : 415 V 50 Hz 6P IE2

Rated current	: 40.7 A	Moment of inertia (J)	: 13.2 sq.ft.lb
LRC	: 5.8	Duty cycle	: Cont.(S1)
Rated torque	: 161 ft.lb	Insulation class	: F
Locked rotor torque	: 200 %	Service factor	: 1.15
Breakdown torque	: 240 %	Temperature rise	: 80 K
Rated speed	: 980 rpm	Design	: B

Locked rotor time : 27s (cold) 15s (hot)

Rev.	Changes Summary	Performed	Checked	Date
Performed by			Page 8 / 36	Revision
Checked by				
Date	14/04/2022			

LOAD PERFORMANCE CURVE

Three Phase Induction Motor - Squirrel Cage



Customer : _____

Product line : NEMA Premium Efficiency Three-Phase

Product code : 12039624

Catalog # : 03012ST3QIE326TC-W22

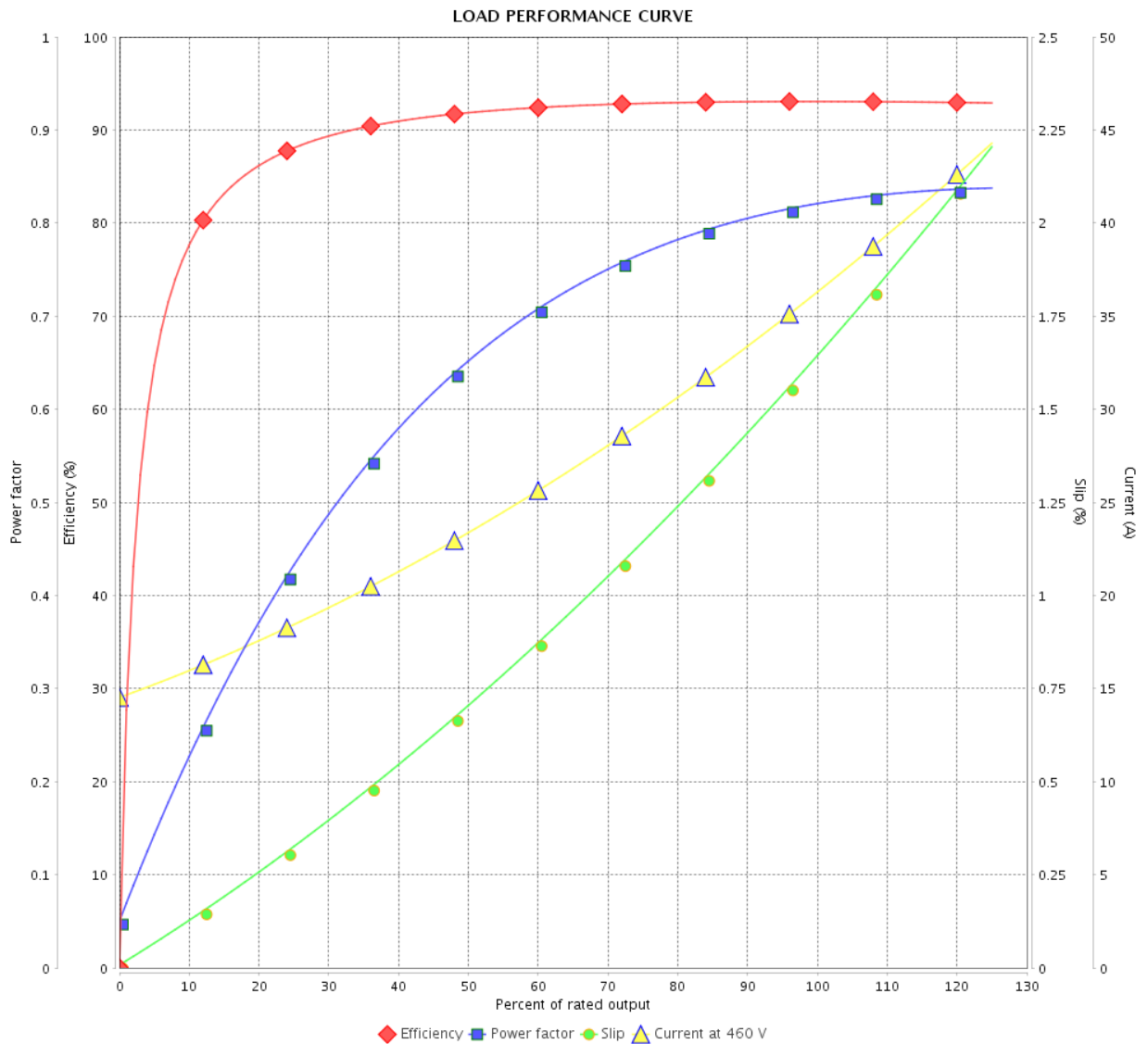

Performance : 460 V 60 Hz 6P

Rated current : 36.2 A
 LRC : 6.2
 Rated torque : 134 ft.lb
 Locked rotor torque : 220 %
 Breakdown torque : 240 %
 Rated speed : 1180 rpm

Moment of inertia (J) : 13.2 sq.ft.lb
 Duty cycle : Cont.(S1)
 Insulation class : F
 Service factor : 1.25
 Temperature rise : 80 K
 Design : B

Rev.	Changes Summary	Performed	Checked	Date
Performed by			Page	Revision
Checked by				
Date				

LOAD PERFORMANCE CURVE

Three Phase Induction Motor - Squirrel Cage



Customer :

Product line : NEMA Premium Efficiency Three-Phase

Product code : 12039624

Catalog # : 03012ST3QIE326TC-W22

LOAD PERFORMANCE CURVE

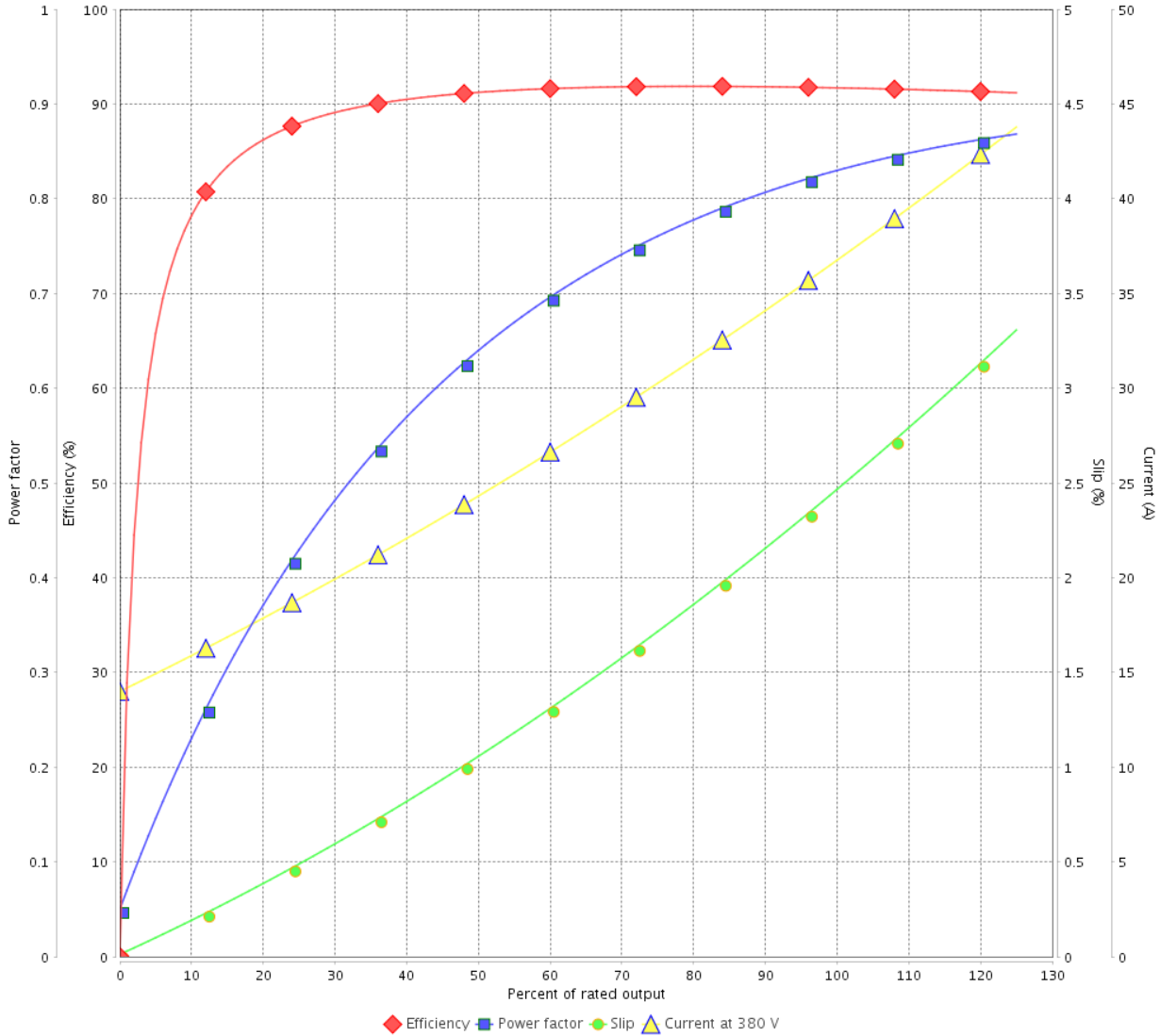

Performance : 380 V 50 Hz 6P IE3

Rated current : 36.9 A
 LRC : 5.8
 Rated torque : 135 ft.lb
 Locked rotor torque : 190 %
 Breakdown torque : 229 %
 Rated speed : 975 rpm

Moment of inertia (J) : 13.2 sq.ft.lb
 Duty cycle : Cont.(S1)
 Insulation class : F
 Service factor : 1.00
 Temperature rise : 80 K
 Design : B

Rev.	Changes Summary	Performed	Checked	Date
Performed by		Page		Revision
Checked by		10 / 36		
Date	14/04/2022			

LOAD PERFORMANCE CURVE

Three Phase Induction Motor - Squirrel Cage



Customer : _____

Product line : NEMA Premium Efficiency Three-Phase

Product code : 12039624

Catalog # : 03012ST3QIE326TC-W22

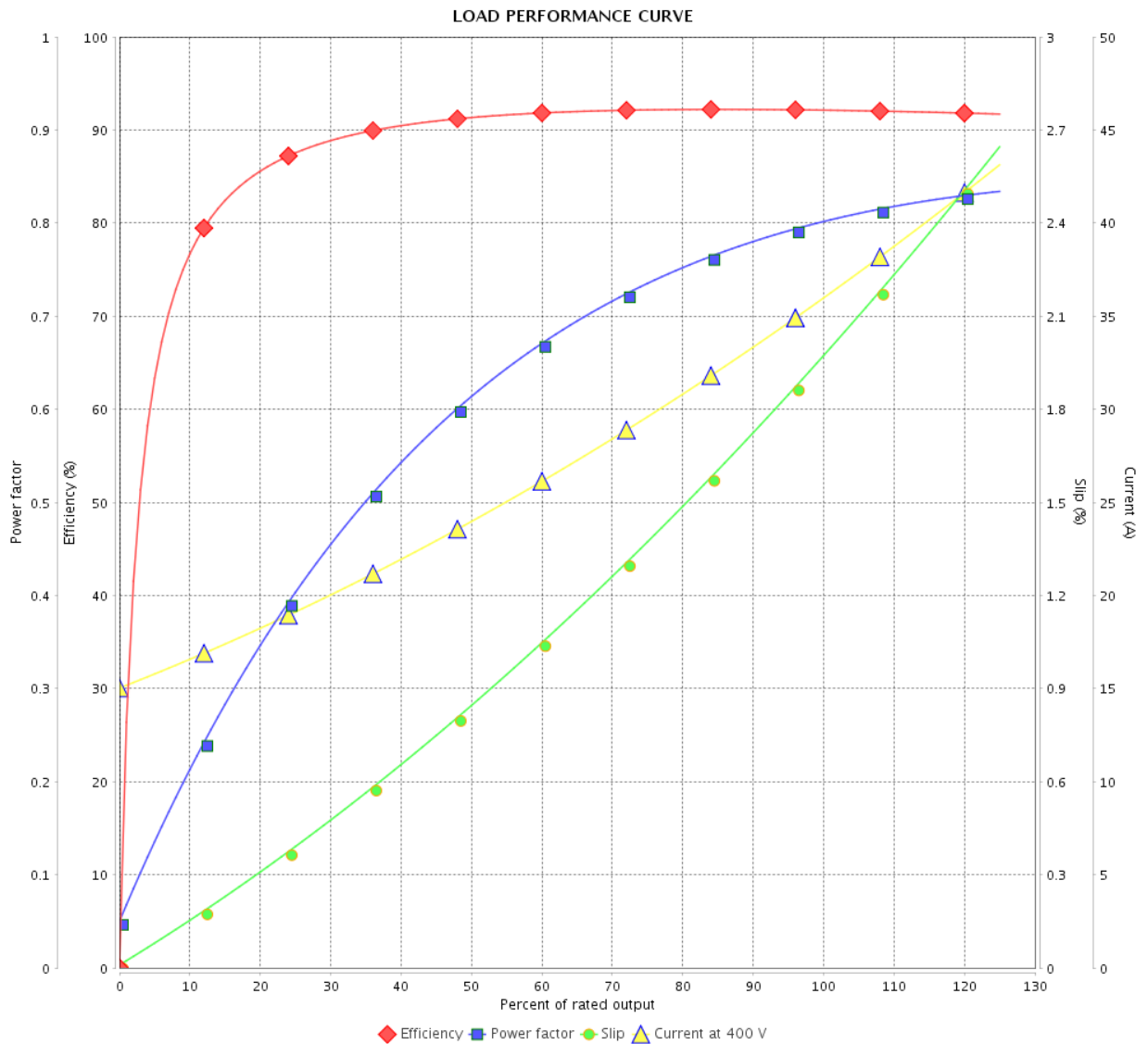

Performance : 400 V 50 Hz 6P IE3

Rated current : 36.2 A
 LRC : 6.3
 Rated torque : 134 ft.lb
 Locked rotor torque : 220 %
 Breakdown torque : 260 %
 Rated speed : 980 rpm

Moment of inertia (J) : 13.2 sq.ft.lb
 Duty cycle : Cont.(S1)
 Insulation class : F
 Service factor : 1.15
 Temperature rise : 80 K
 Design : B

Rev.	Changes Summary	Performed	Checked	Date
Performed by		Page		Revision
Checked by		11 / 36		
Date		14/04/2022		

LOAD PERFORMANCE CURVE

Three Phase Induction Motor - Squirrel Cage



Customer :

Product line : NEMA Premium Efficiency Three-Phase

Product code : 12039624

Catalog # : 03012ST3QIE326TC-W22

LOAD PERFORMANCE CURVE

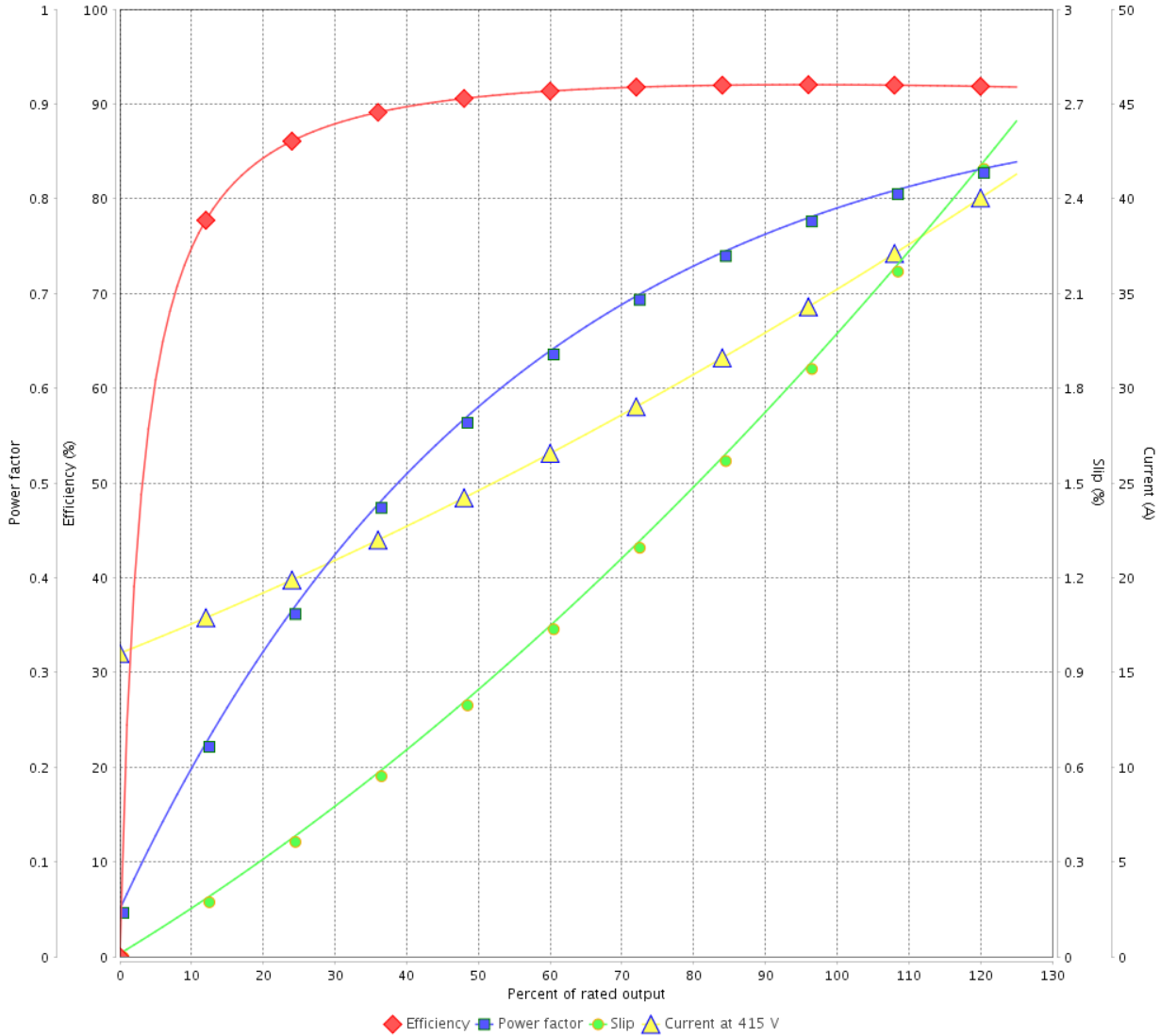

Performance : 415 V 50 Hz 6P IE3

Rated current : 35.4 A
 LRC : 6.7
 Rated torque : 134 ft.lb
 Locked rotor torque : 240 %
 Breakdown torque : 280 %
 Rated speed : 980 rpm

Moment of inertia (J) : 13.2 sq.ft.lb
 Duty cycle : Cont.(S1)
 Insulation class : F
 Service factor : 1.15
 Temperature rise : 80 K
 Design : B

Rev.	Changes Summary	Performed	Checked	Date
Performed by			Page 12 / 36	Revision
Checked by				
Date	14/04/2022			

LOAD PERFORMANCE CURVE

Three Phase Induction Motor - Squirrel Cage



Customer : _____

Product line : NEMA Premium Efficiency Three-Phase

Product code : 12039624

Catalog # : 03012ST3QIE326TC-W22

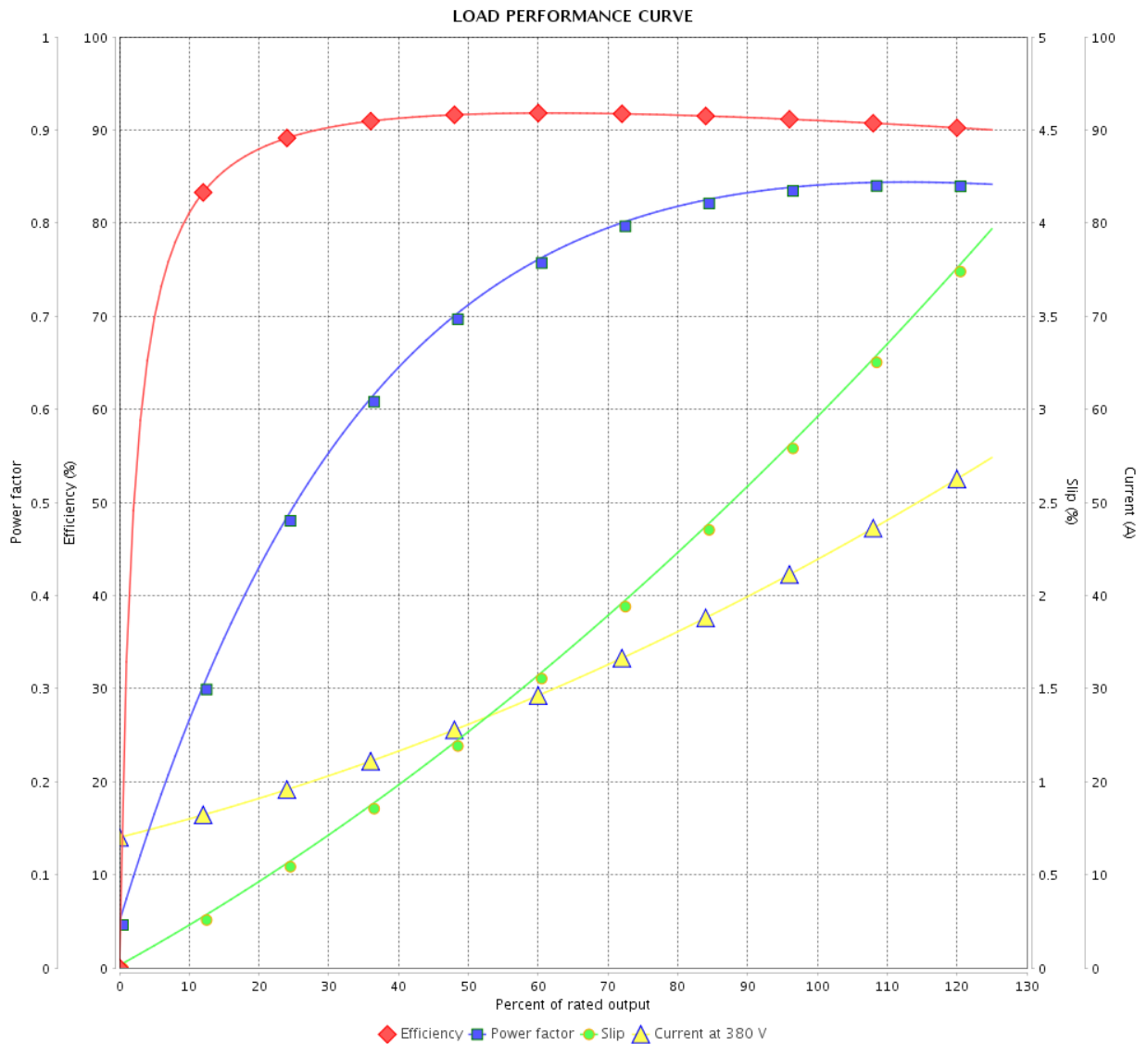

Performance : 380 V 50 Hz 6P IE2

Rated current : 43.7 A
 LRC : 4.9
 Rated torque : 162 ft.lb
 Locked rotor torque : 160 %
 Breakdown torque : 200 %
 Rated speed : 970 rpm

Moment of inertia (J) : 13.2 sq.ft.lb
 Duty cycle : Cont.(S1)
 Insulation class : F
 Service factor : 1.00
 Temperature rise : 80 K
 Design : B

Rev.	Changes Summary	Performed	Checked	Date
Performed by		Page		Revision
Checked by		13 / 36		
Date		14/04/2022		

LOAD PERFORMANCE CURVE

Three Phase Induction Motor - Squirrel Cage



Customer : _____

Product line : NEMA Premium Efficiency Three-Phase

Product code : 12039624

Catalog # : 03012ST3QIE326TC-W22

LOAD PERFORMANCE CURVE

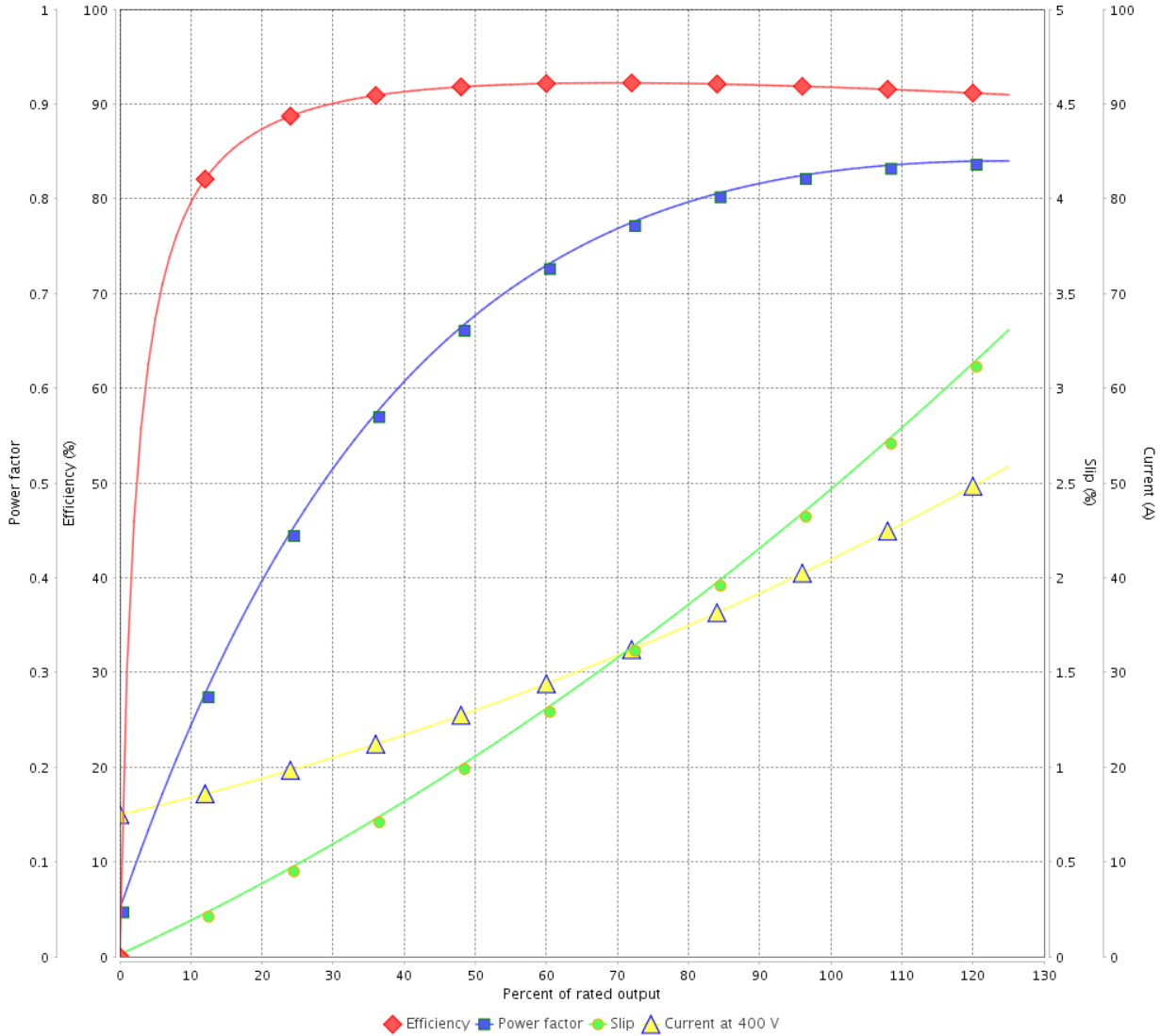

Performance : 400 V 50 Hz 6P IE2

Rated current : 41.7 A
 LRC : 5.4
 Rated torque : 162 ft.lb
 Locked rotor torque : 180 %
 Breakdown torque : 220 %
 Rated speed : 975 rpm

Moment of inertia (J) : 13.2 sq.ft.lb
 Duty cycle : Cont.(S1)
 Insulation class : F
 Service factor : 1.15
 Temperature rise : 80 K
 Design : B

Rev.	Changes Summary	Performed	Checked	Date
Performed by			Page 14 / 36	Revision
Checked by				
Date	14/04/2022			

LOAD PERFORMANCE CURVE

Three Phase Induction Motor - Squirrel Cage



Customer :

Product line : NEMA Premium Efficiency Three-Phase

Product code : 12039624

Catalog # : 03012ST3QIE326TC-W22

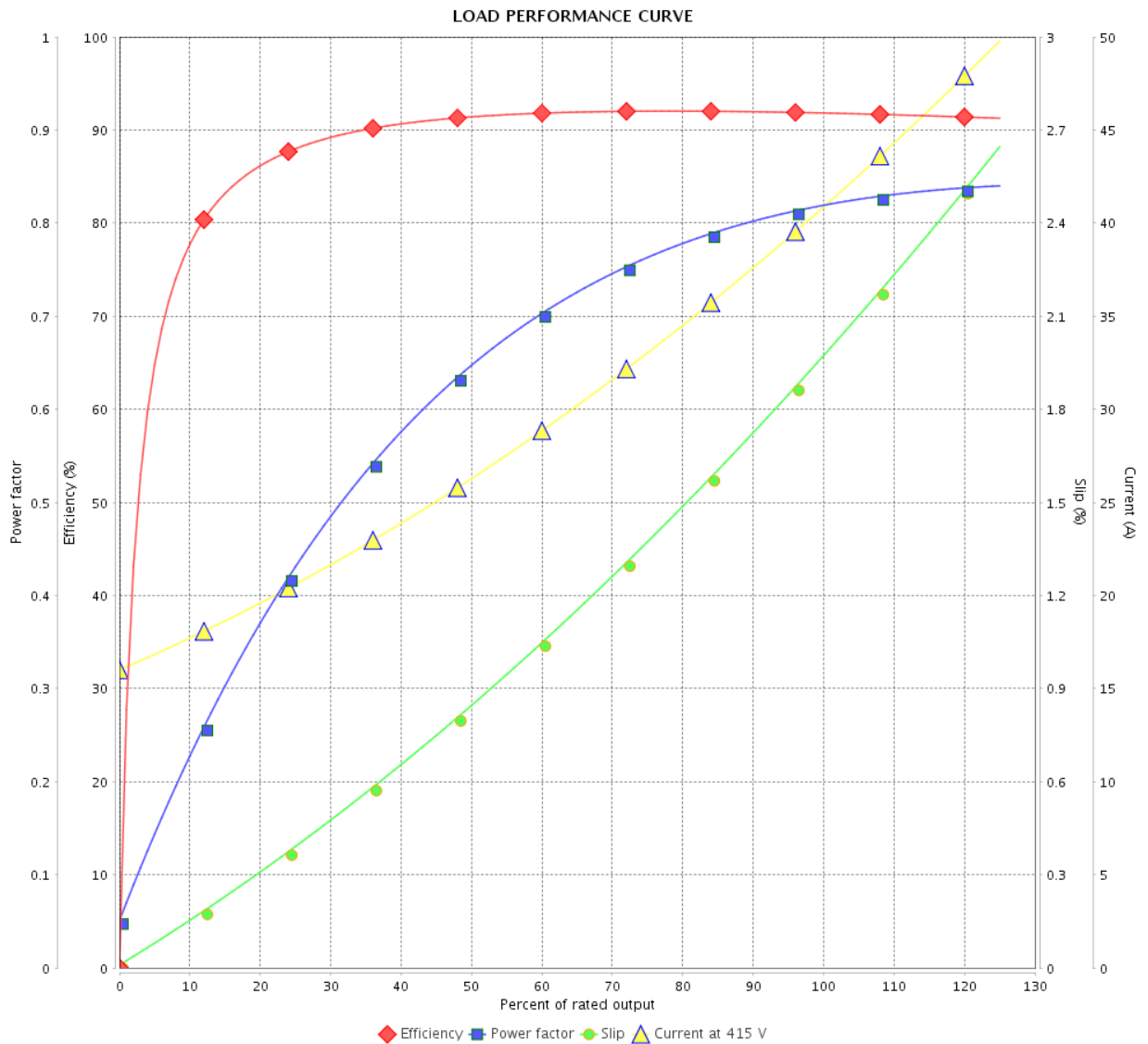

Performance : 415 V 50 Hz 6P IE2

Rated current : 40.7 A
 LRC : 5.8
 Rated torque : 161 ft.lb
 Locked rotor torque : 200 %
 Breakdown torque : 240 %
 Rated speed : 980 rpm

Moment of inertia (J) : 13.2 sq.ft.lb
 Duty cycle : Cont.(S1)
 Insulation class : F
 Service factor : 1.15
 Temperature rise : 80 K
 Design : B

Rev.	Changes Summary	Performed	Checked	Date
Performed by		Page		Revision
Checked by		15 / 36		
Date		14/04/2022		

THERMAL LIMIT CURVE



Three Phase Induction Motor - Squirrel Cage

Customer :

Product line : NEMA Premium Efficiency Three-Phase
Product code : 12039624
Catalog # : 03012ST3QIE326TC-W22

Performance : 460 V 60 Hz 6P

Rated current	: 36.2 A	Moment of inertia (J)	: 13.2 sq.ft.lb
LRC	: 6.2	Duty cycle	: Cont.(S1)
Rated torque	: 134 ft.lb	Insulation class	: F
Locked rotor torque	: 220 %	Service factor	: 1.25
Breakdown torque	: 240 %	Temperature rise	: 80 K
Rated speed	: 1180 rpm	Design	: B

Heating constant

Cooling constant

Rev.	Changes Summary	Performed	Checked	Date
Performed by				
Checked by			Page	Revision
Date	14/04/2022		16 / 36	

THERMAL LIMIT CURVE

Three Phase Induction Motor - Squirrel Cage



Customer : _____

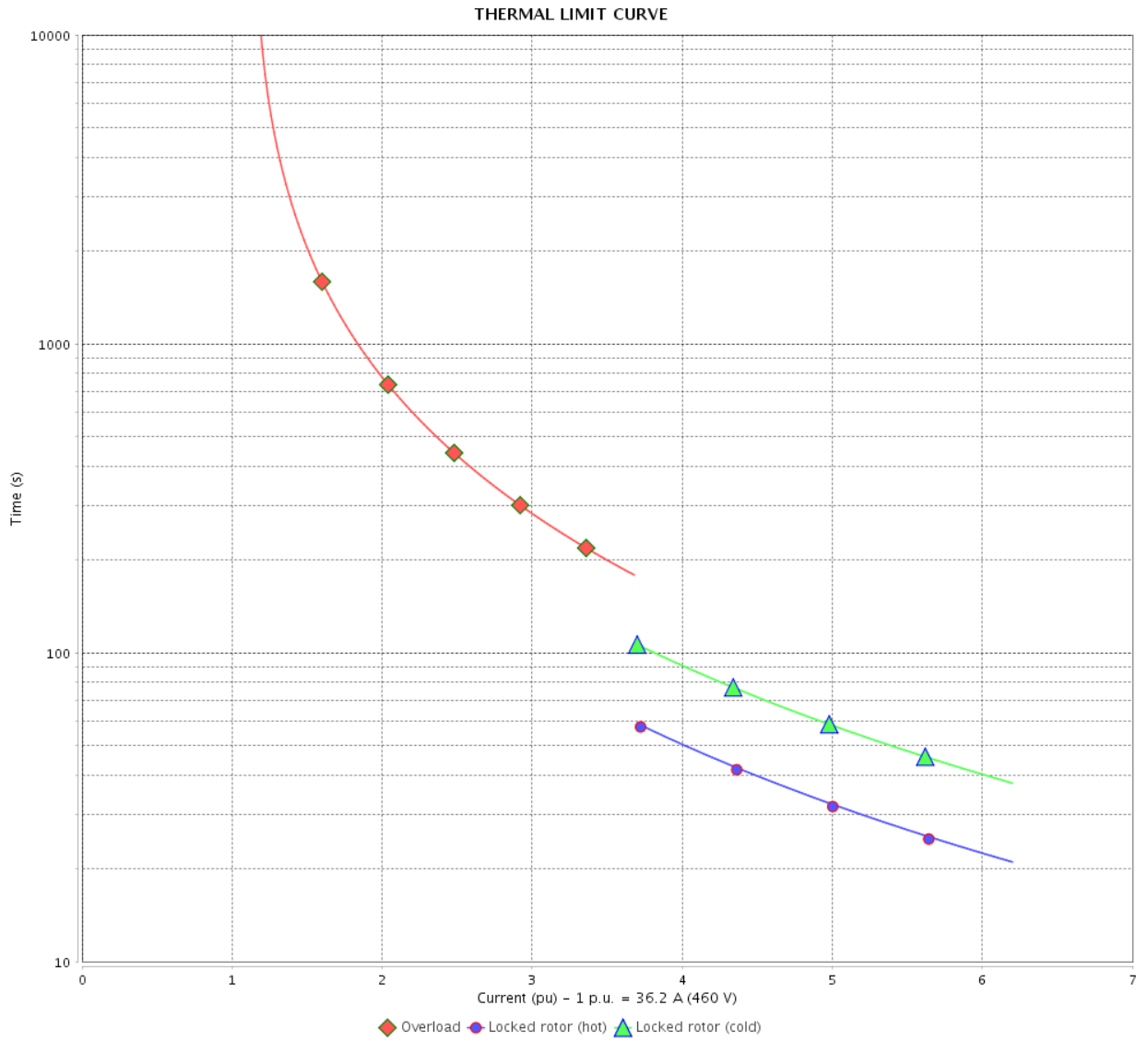

Rev.	Changes Summary	Performed	Checked	Date
Performed by		Page		Revision
Checked by		17 / 36		
Date		14/04/2022		

THERMAL LIMIT CURVE



Three Phase Induction Motor - Squirrel Cage

Customer :

Product line : NEMA Premium Efficiency Three-Phase

Product code : 12039624

Catalog # : 03012ST3QIE326TC-W22

Performance : 380 V 50 Hz 6P IE3

Rated current	: 36.9 A	Moment of inertia (J)	: 13.2 sq.ft.lb
LRC	: 5.8	Duty cycle	: Cont.(S1)
Rated torque	: 135 ft.lb	Insulation class	: F
Locked rotor torque	: 190 %	Service factor	: 1.00
Breakdown torque	: 229 %	Temperature rise	: 80 K
Rated speed	: 975 rpm	Design	: B

Heating constant

Cooling constant

Rev.	Changes Summary	Performed	Checked	Date
Performed by				
Checked by			Page	Revision
Date	14/04/2022		18 / 36	

THERMAL LIMIT CURVE

Three Phase Induction Motor - Squirrel Cage



Customer : _____

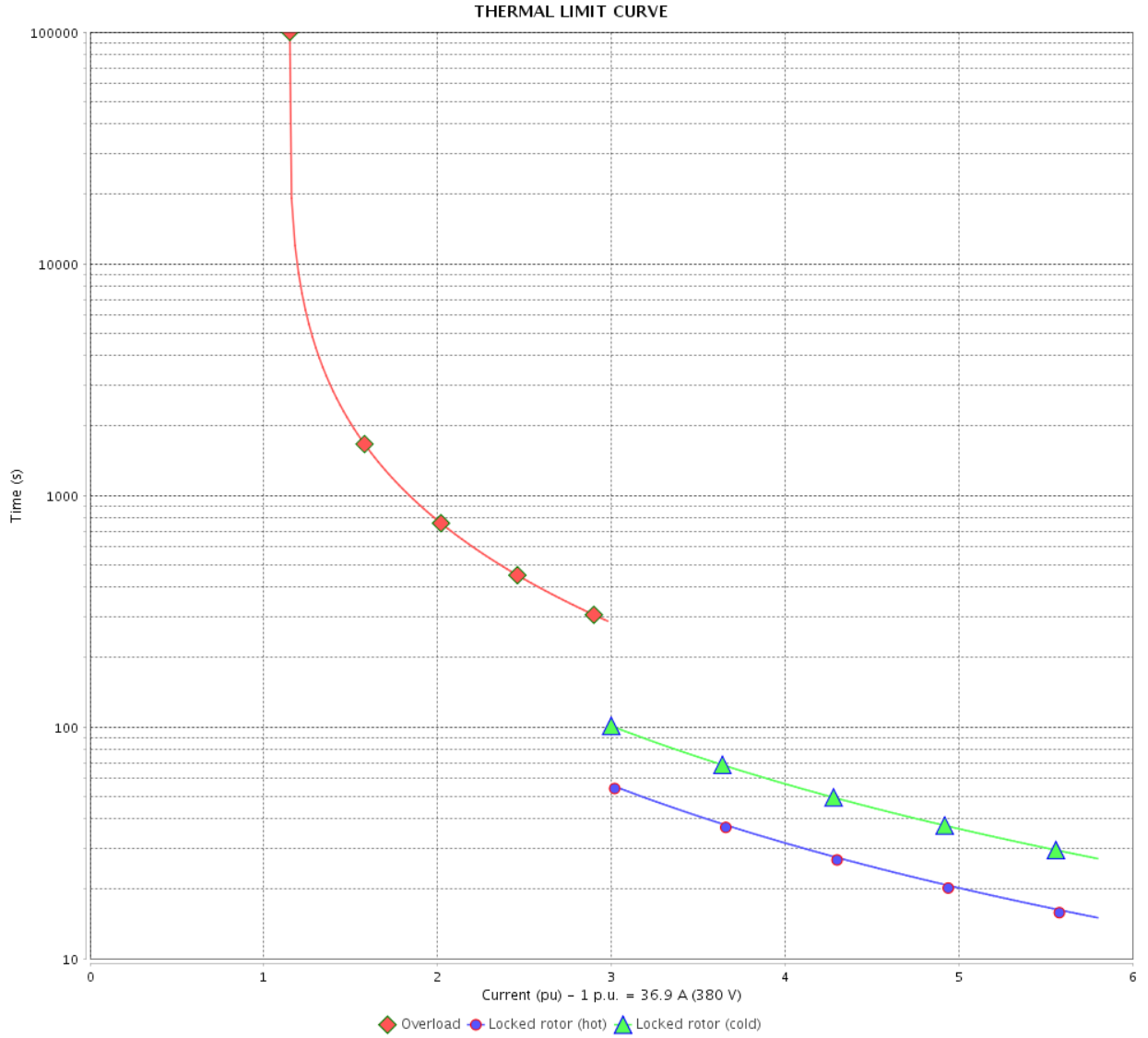

Rev.	Changes Summary	Performed	Checked	Date
Performed by		Page 19 / 36		Revision
Checked by				
Date				

THERMAL LIMIT CURVE

Three Phase Induction Motor - Squirrel Cage



Customer :

Product line : NEMA Premium Efficiency Three-Phase
Product code : 12039624
Catalog # : 03012ST3QIE326TC-W22

Performance : 400 V 50 Hz 6P IE3

Rated current	: 36.2 A	Moment of inertia (J)	: 13.2 sq.ft.lb
LRC	: 6.3	Duty cycle	: Cont.(S1)
Rated torque	: 134 ft.lb	Insulation class	: F
Locked rotor torque	: 220 %	Service factor	: 1.15
Breakdown torque	: 260 %	Temperature rise	: 80 K
Rated speed	: 980 rpm	Design	: B

Heating constant

Cooling constant

Rev.	Changes Summary	Performed	Checked	Date
Performed by				
Checked by			Page	Revision
Date	14/04/2022		20 / 36	

THERMAL LIMIT CURVE

Three Phase Induction Motor - Squirrel Cage



Customer : _____

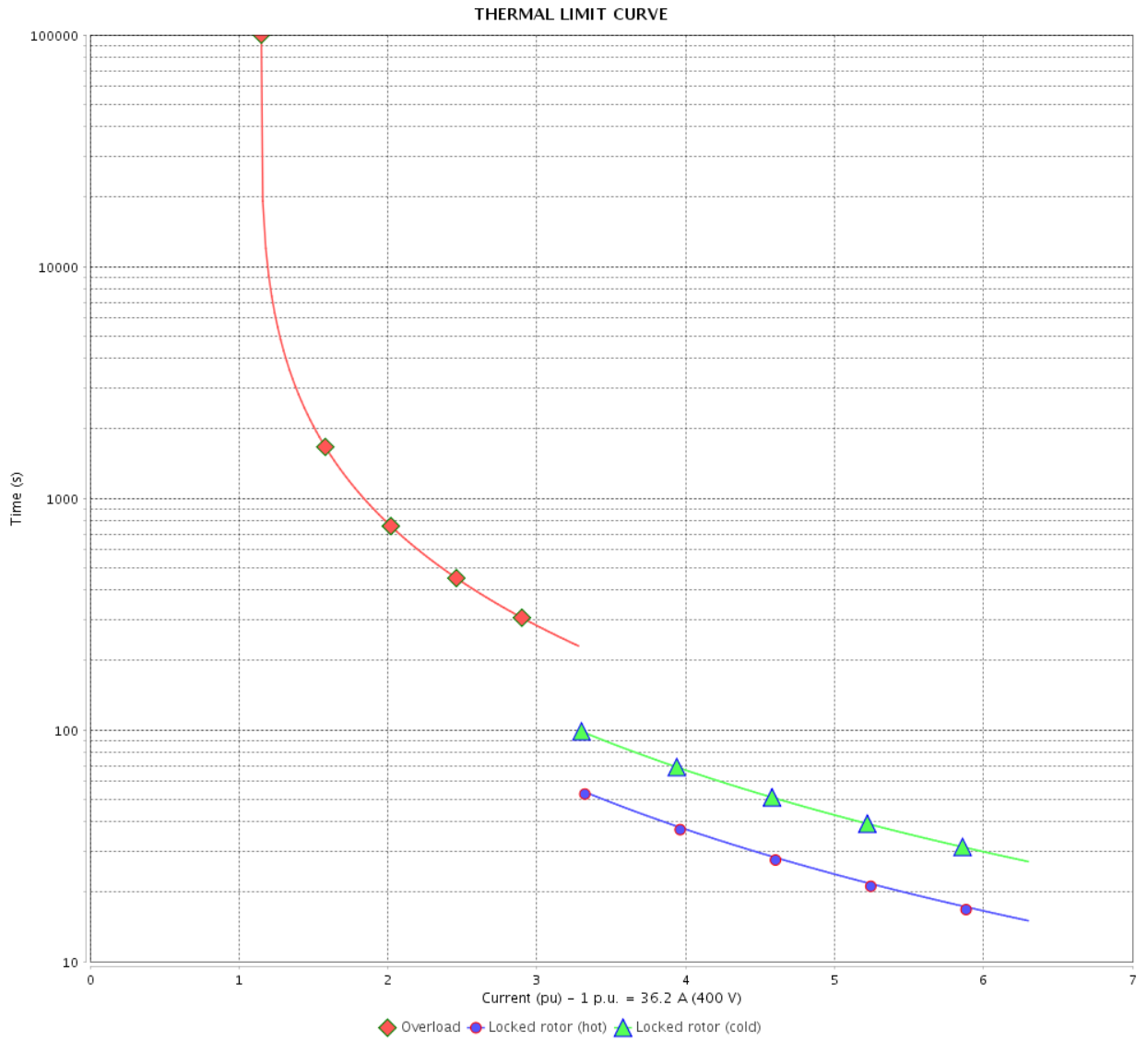

Rev.	Changes Summary	Performed	Checked	Date
Performed by		Page		Revision
Checked by		21 / 36		
Date		14/04/2022		

THERMAL LIMIT CURVE

Three Phase Induction Motor - Squirrel Cage



Customer :

Product line : NEMA Premium Efficiency Three-Phase
Product code : 12039624
Catalog # : 03012ST3QIE326TC-W22

Performance : 415 V 50 Hz 6P IE3

Rated current	: 35.4 A	Moment of inertia (J)	: 13.2 sq.ft.lb
LRC	: 6.7	Duty cycle	: Cont.(S1)
Rated torque	: 134 ft.lb	Insulation class	: F
Locked rotor torque	: 240 %	Service factor	: 1.15
Breakdown torque	: 280 %	Temperature rise	: 80 K
Rated speed	: 980 rpm	Design	: B

Heating constant

Cooling constant

Rev.	Changes Summary	Performed	Checked	Date
Performed by				
Checked by			Page	Revision
Date	14/04/2022		22 / 36	

THERMAL LIMIT CURVE

Three Phase Induction Motor - Squirrel Cage



Customer : _____

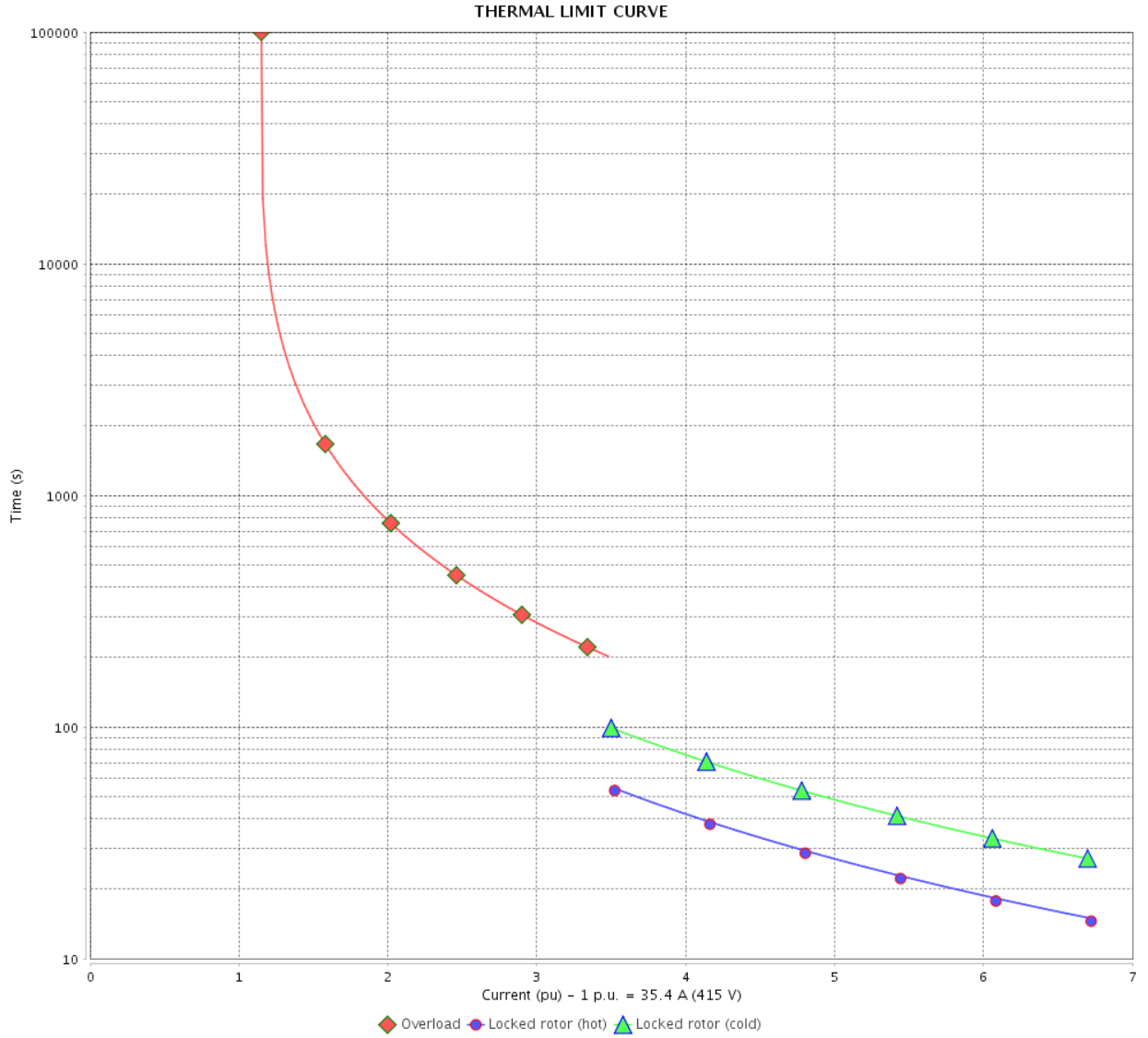

Rev.	Changes Summary	Performed	Checked	Date
Performed by		Page 23 / 36		Revision
Checked by				
Date				

THERMAL LIMIT CURVE

Three Phase Induction Motor - Squirrel Cage



Customer :

Product line : NEMA Premium Efficiency Three-Phase
Product code : 12039624
Catalog # : 03012ST3QIE326TC-W22

Performance : 380 V 50 Hz 6P IE2

Rated current	: 43.7 A	Moment of inertia (J)	: 13.2 sq.ft.lb
LRC	: 4.9	Duty cycle	: Cont.(S1)
Rated torque	: 162 ft.lb	Insulation class	: F
Locked rotor torque	: 160 %	Service factor	: 1.00
Breakdown torque	: 200 %	Temperature rise	: 80 K
Rated speed	: 970 rpm	Design	: B

Heating constant

Cooling constant

Rev.	Changes Summary	Performed	Checked	Date
Performed by				
Checked by			Page	Revision
Date	14/04/2022		24 / 36	

THERMAL LIMIT CURVE

Three Phase Induction Motor - Squirrel Cage



Customer : _____

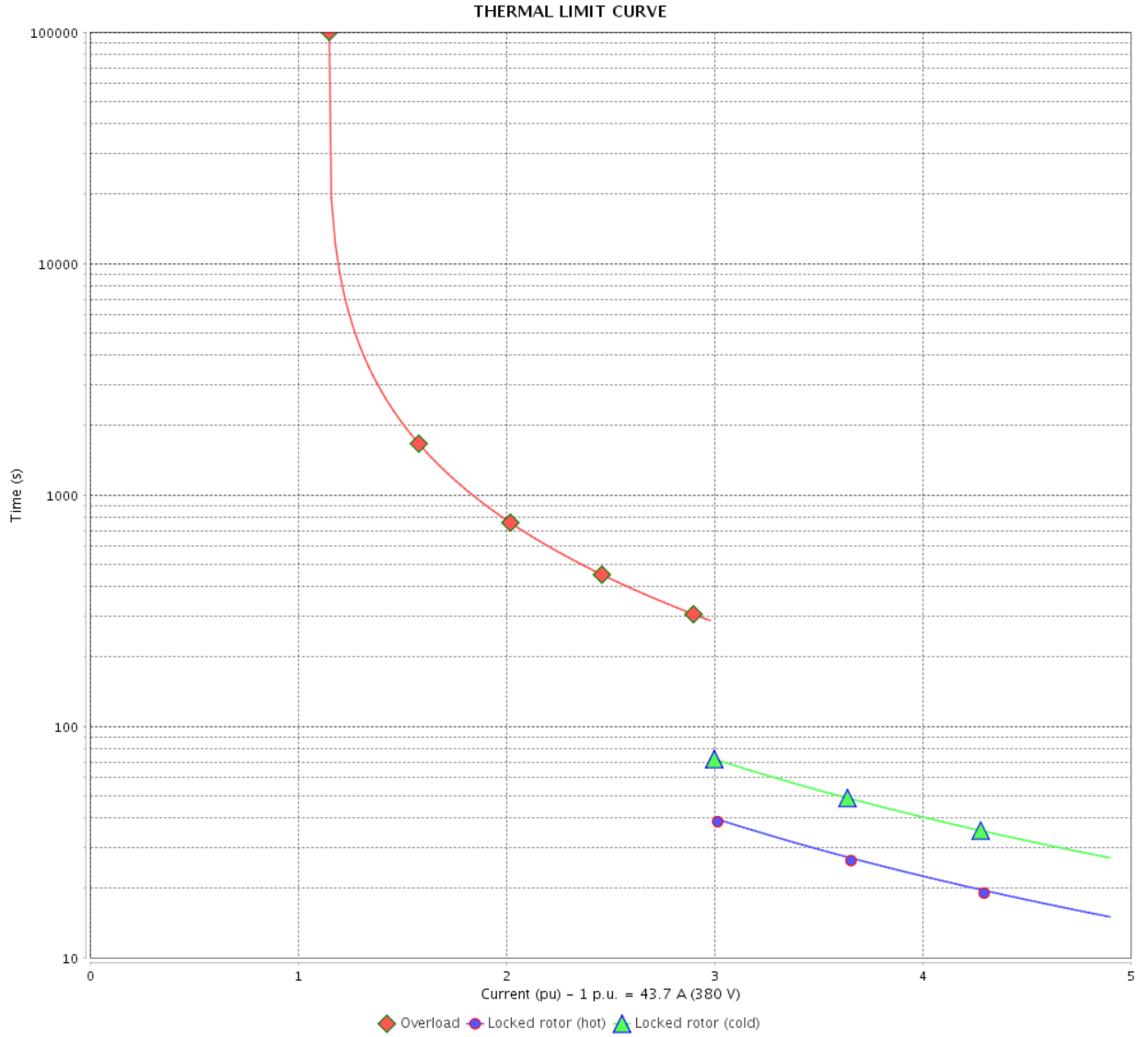

Rev.	Changes Summary	Performed	Checked	Date
Performed by				
Checked by				
Date				
			Page	Revision
			25 / 36	

THERMAL LIMIT CURVE



Three Phase Induction Motor - Squirrel Cage

Customer :

Product line : NEMA Premium Efficiency Three-Phase
Product code : 12039624
Catalog # : 03012ST3QIE326TC-W22

Performance : 400 V 50 Hz 6P IE2

Rated current	: 41.7 A	Moment of inertia (J)	: 13.2 sq.ft.lb
LRC	: 5.4	Duty cycle	: Cont.(S1)
Rated torque	: 162 ft.lb	Insulation class	: F
Locked rotor torque	: 180 %	Service factor	: 1.15
Breakdown torque	: 220 %	Temperature rise	: 80 K
Rated speed	: 975 rpm	Design	: B

Heating constant

Cooling constant

Rev.	Changes Summary	Performed	Checked	Date
Performed by				
Checked by			Page	Revision
Date	14/04/2022		26 / 36	

THERMAL LIMIT CURVE

Three Phase Induction Motor - Squirrel Cage



Customer : _____

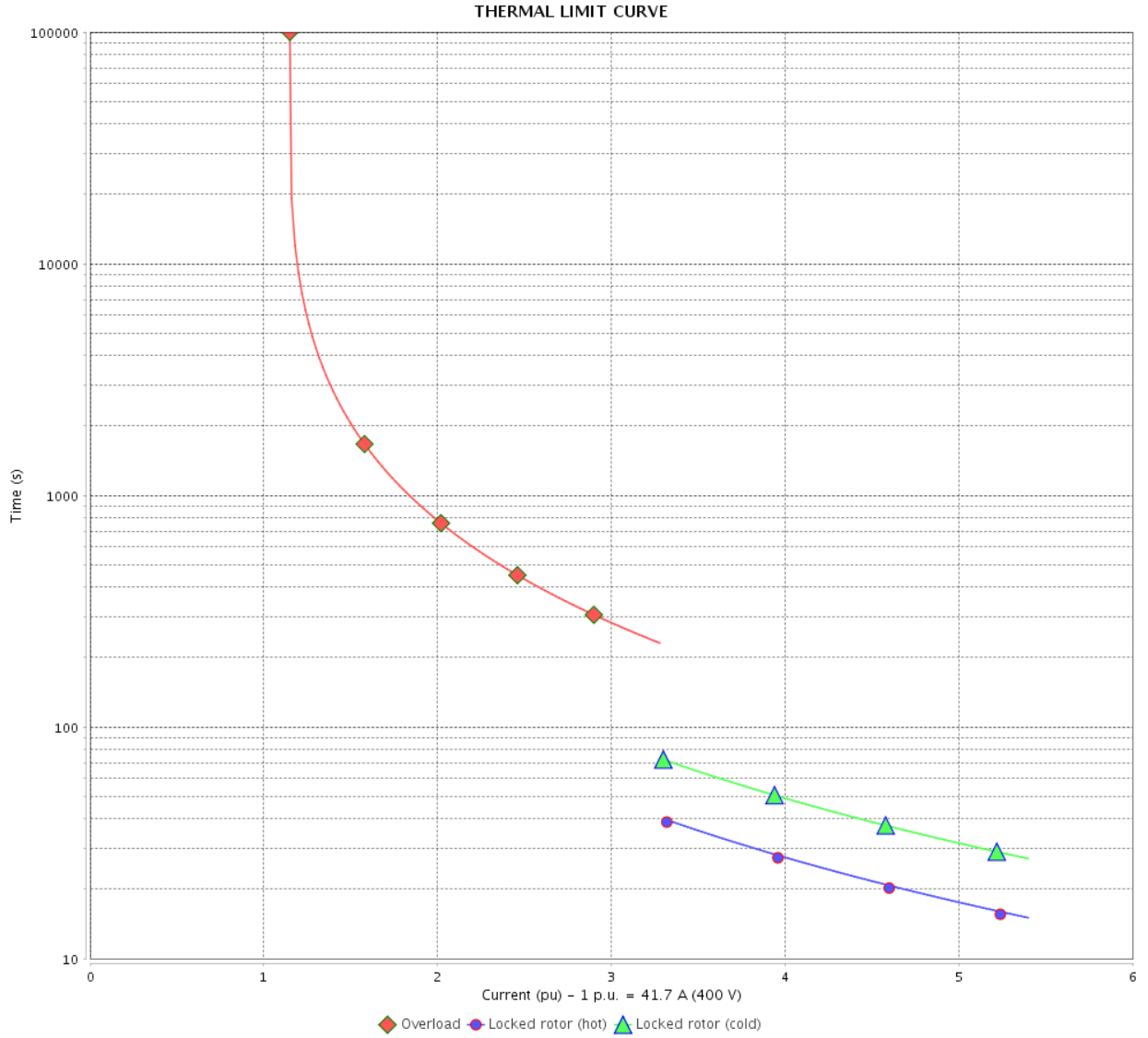

Rev.	Changes Summary	Performed	Checked	Date
Performed by		Page		Revision
Checked by		27 / 36		
Date		14/04/2022		

THERMAL LIMIT CURVE

Three Phase Induction Motor - Squirrel Cage



Customer :

Product line : NEMA Premium Efficiency Three-Phase
Product code : 12039624
Catalog # : 03012ST3QIE326TC-W22

Performance : 415 V 50 Hz 6P IE2

Rated current	: 40.7 A	Moment of inertia (J)	: 13.2 sq.ft.lb
LRC	: 5.8	Duty cycle	: Cont.(S1)
Rated torque	: 161 ft.lb	Insulation class	: F
Locked rotor torque	: 200 %	Service factor	: 1.15
Breakdown torque	: 240 %	Temperature rise	: 80 K
Rated speed	: 980 rpm	Design	: B

Heating constant

Cooling constant

Rev.	Changes Summary	Performed	Checked	Date
Performed by				
Checked by			Page	Revision
Date	14/04/2022		28 / 36	

THERMAL LIMIT CURVE

Three Phase Induction Motor - Squirrel Cage



Customer : _____

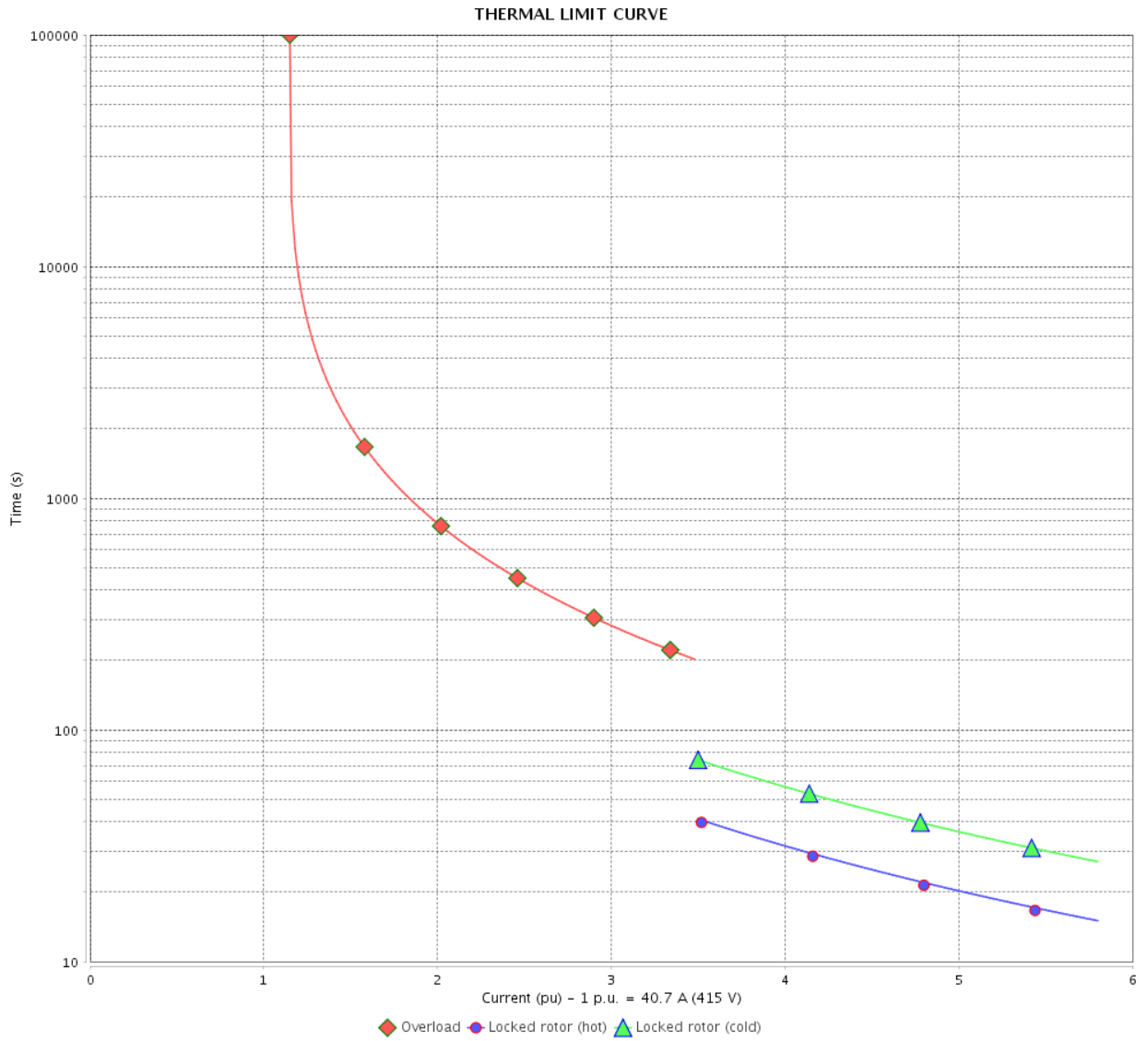

Rev.	Changes Summary	Performed	Checked	Date
Performed by				
Checked by				
Date				
			Page	Revision
			29 / 36	

VFD OPERATION CURVE

Three Phase Induction Motor - Squirrel Cage



Customer :

Product line : NEMA Premium Efficiency Three-Phase

Product code : 12039624

Catalog # : 03012ST3QIE326TC-W22

VFD OPERATION CURVE

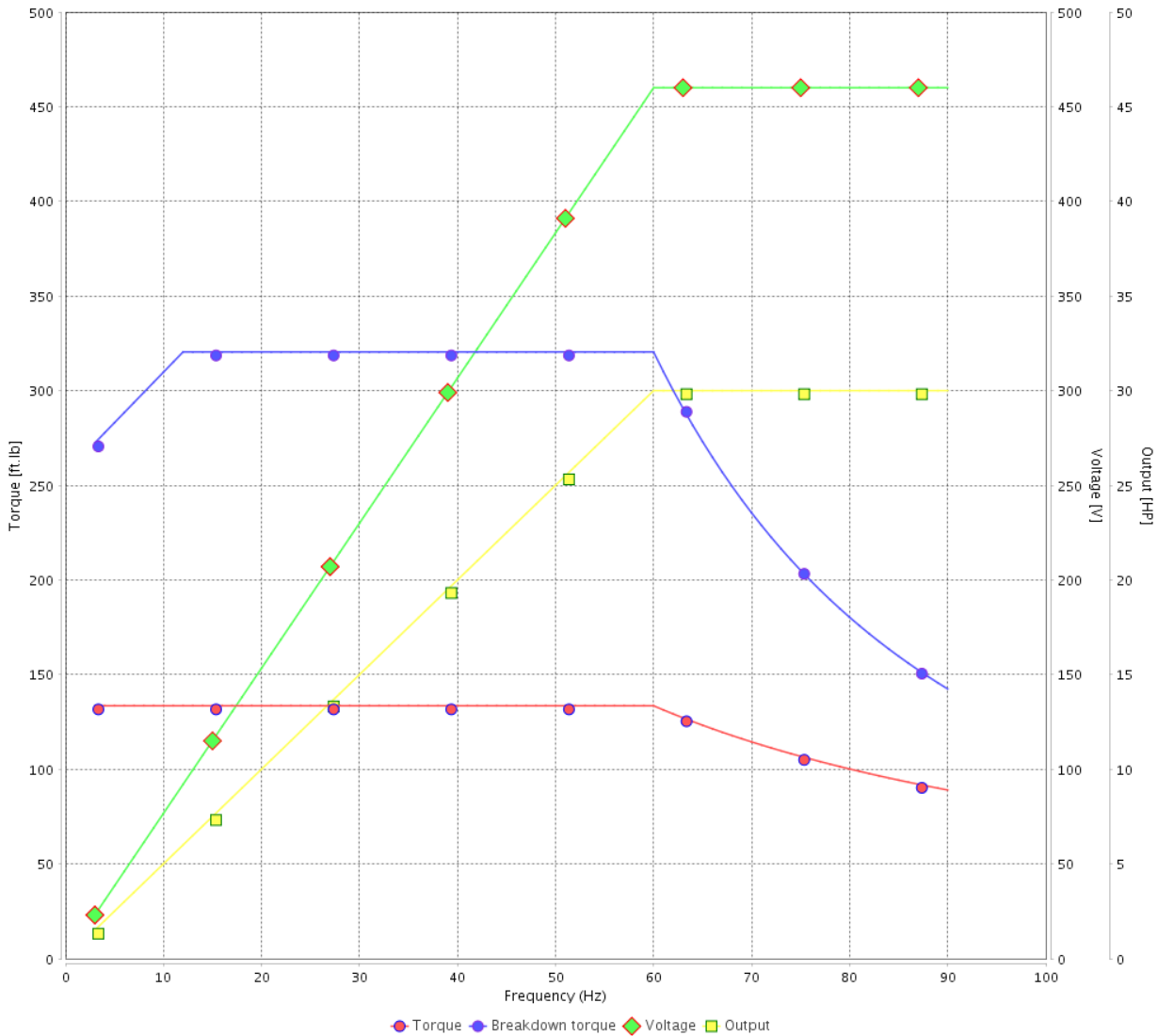

Performance : 460 V 60 Hz 6P

Rated current	: 36.2 A	Moment of inertia (J)	: 13.2 sq.ft.lb
LRC	: 6.2	Duty cycle	: Cont.(S1)
Rated torque	: 134 ft.lb	Insulation class	: F
Locked rotor torque	: 220 %	Service factor	: 1.25
Breakdown torque	: 240 %	Temperature rise	: 80 K
Rated speed	: 1180 rpm	Design	: B

Rev.	Changes Summary	Performed	Checked	Date
Performed by			Page 30 / 36	Revision
Checked by				
Date	14/04/2022			

VFD OPERATION CURVE

Three Phase Induction Motor - Squirrel Cage



Customer : _____

Product line : NEMA Premium Efficiency Three-Phase

Product code : 12039624

Catalog # : 03012ST3QIE326TC-W22

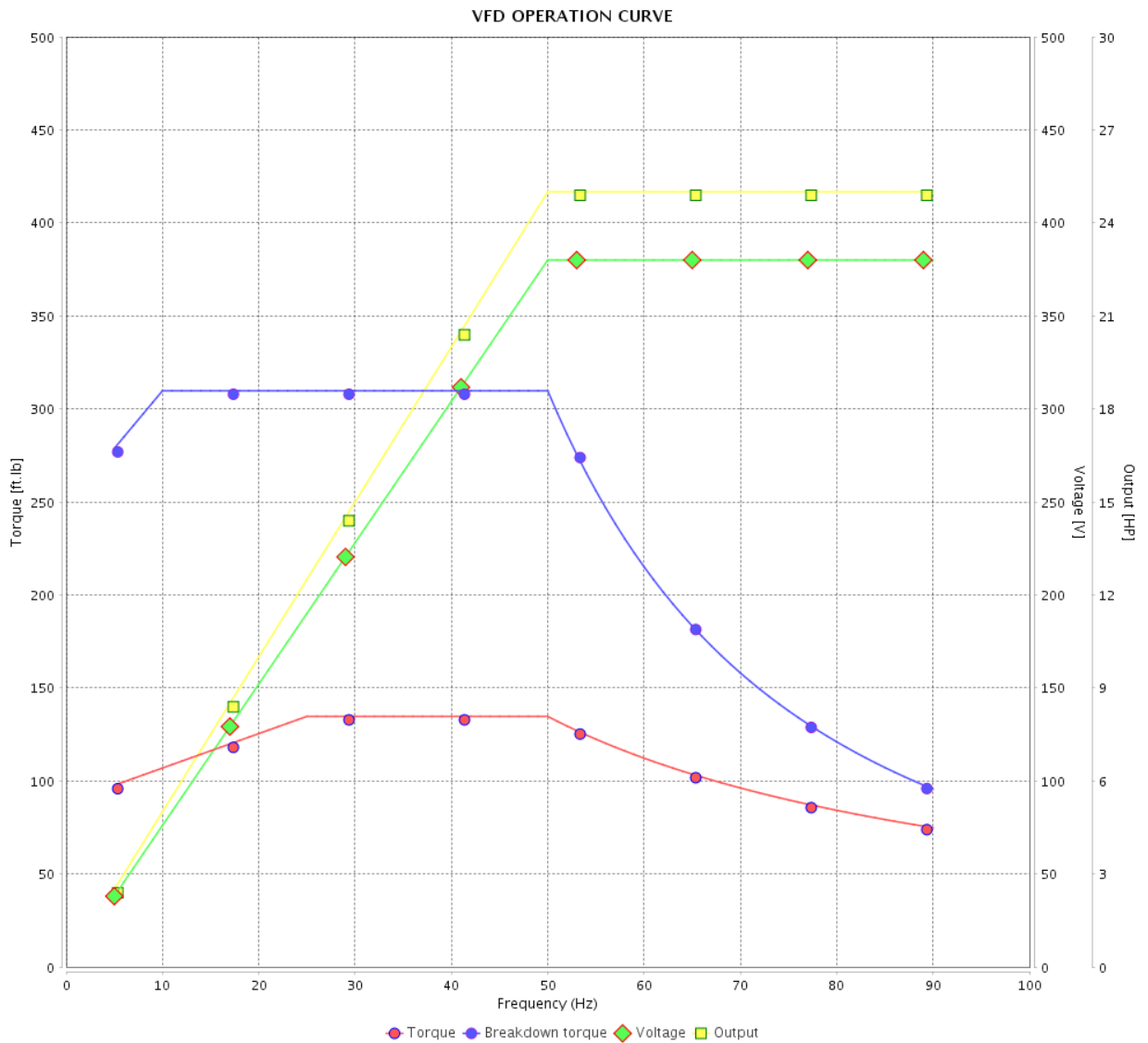

Performance : 380 V 50 Hz 6P IE3

Rated current : 36.9 A
 LRC : 5.8
 Rated torque : 135 ft.lb
 Locked rotor torque : 190 %
 Breakdown torque : 229 %
 Rated speed : 975 rpm

Moment of inertia (J) : 13.2 sq.ft.lb
 Duty cycle : Cont.(S1)
 Insulation class : F
 Service factor : 1.00
 Temperature rise : 80 K
 Design : B

Rev.	Changes Summary	Performed	Checked	Date
Performed by		Page		Revision
Checked by		31 / 36		
Date		14/04/2022		

VFD OPERATION CURVE

Three Phase Induction Motor - Squirrel Cage



Customer : _____

Product line : NEMA Premium Efficiency Three-Phase

Product code : 12039624

Catalog # : 03012ST3QIE326TC-W22

VFD OPERATION CURVE

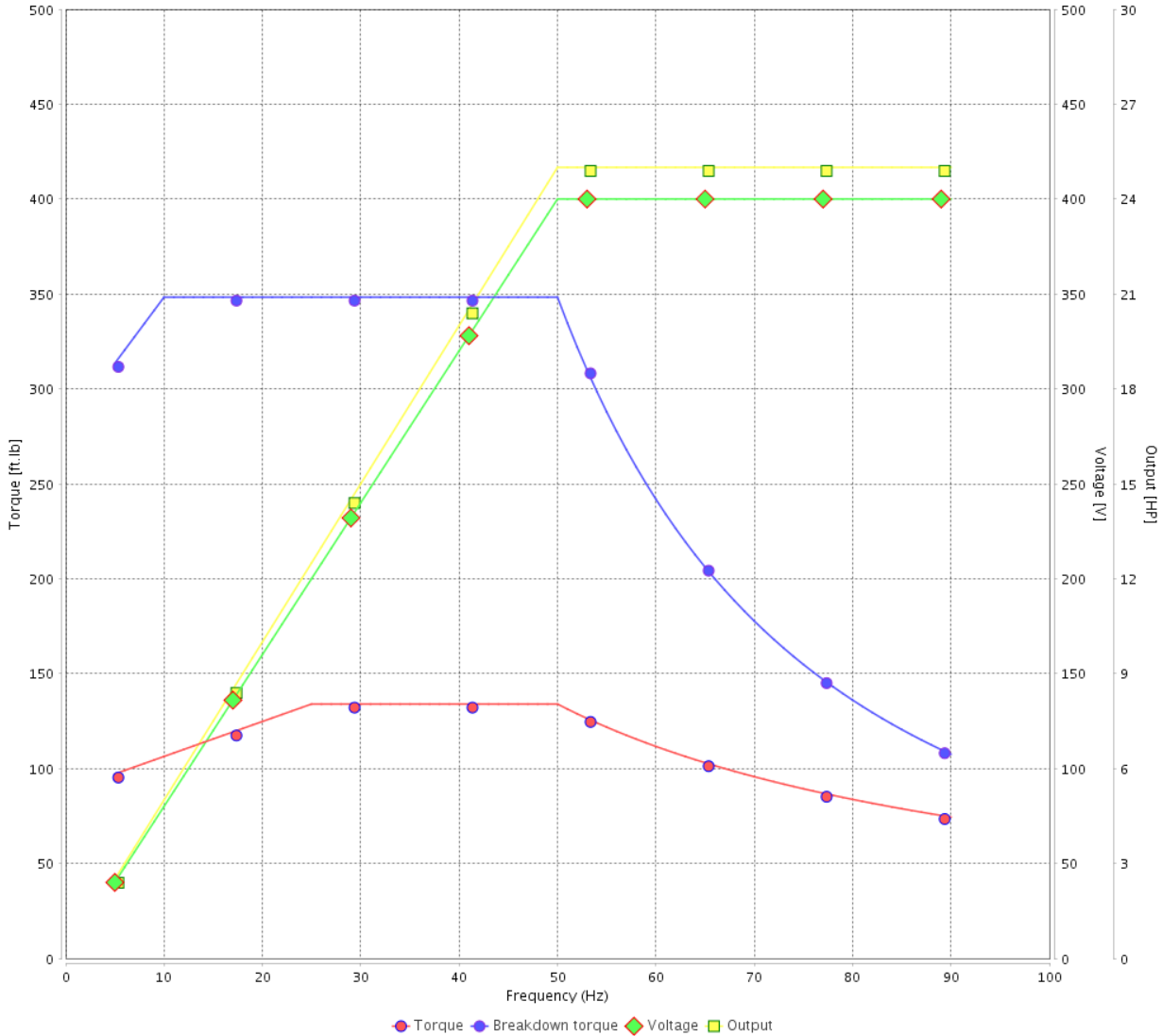

Performance : 400 V 50 Hz 6P IE3

Rated current : 36.2 A
 LRC : 6.3
 Rated torque : 134 ft.lb
 Locked rotor torque : 220 %
 Breakdown torque : 260 %
 Rated speed : 980 rpm

Moment of inertia (J) : 13.2 sq.ft.lb
 Duty cycle : Cont.(S1)
 Insulation class : F
 Service factor : 1.15
 Temperature rise : 80 K
 Design : B

Rev.	Changes Summary	Performed	Checked	Date
Performed by			Page 32 / 36	Revision
Checked by				
Date	14/04/2022			

VFD OPERATION CURVE

Three Phase Induction Motor - Squirrel Cage



Customer : _____

Product line : NEMA Premium Efficiency Three-Phase

Product code : 12039624

Catalog # : 03012ST3QIE326TC-W22

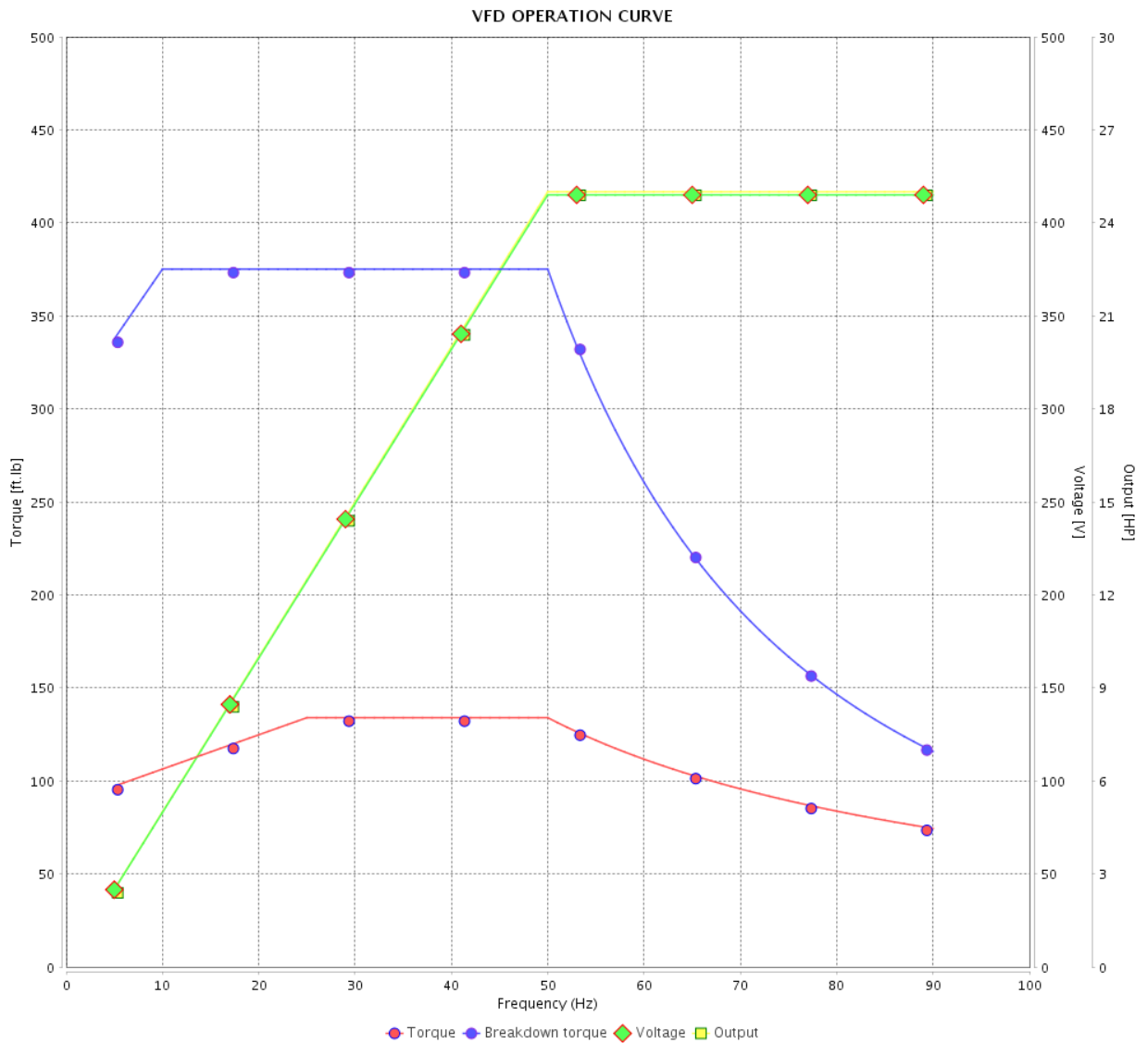

Performance : 415 V 50 Hz 6P IE3

Rated current : 35.4 A
 LRC : 6.7
 Rated torque : 134 ft.lb
 Locked rotor torque : 240 %
 Breakdown torque : 280 %
 Rated speed : 980 rpm

Moment of inertia (J) : 13.2 sq.ft.lb
 Duty cycle : Cont.(S1)
 Insulation class : F
 Service factor : 1.15
 Temperature rise : 80 K
 Design : B

Rev.	Changes Summary	Performed	Checked	Date
Performed by				Page 33 / 36
Checked by				
Date	14/04/2022			
				Revision

VFD OPERATION CURVE

Three Phase Induction Motor - Squirrel Cage



Customer :

Product line : NEMA Premium Efficiency Three-Phase

Product code : 12039624

Catalog # : 03012ST3QIE326TC-W22

VFD OPERATION CURVE

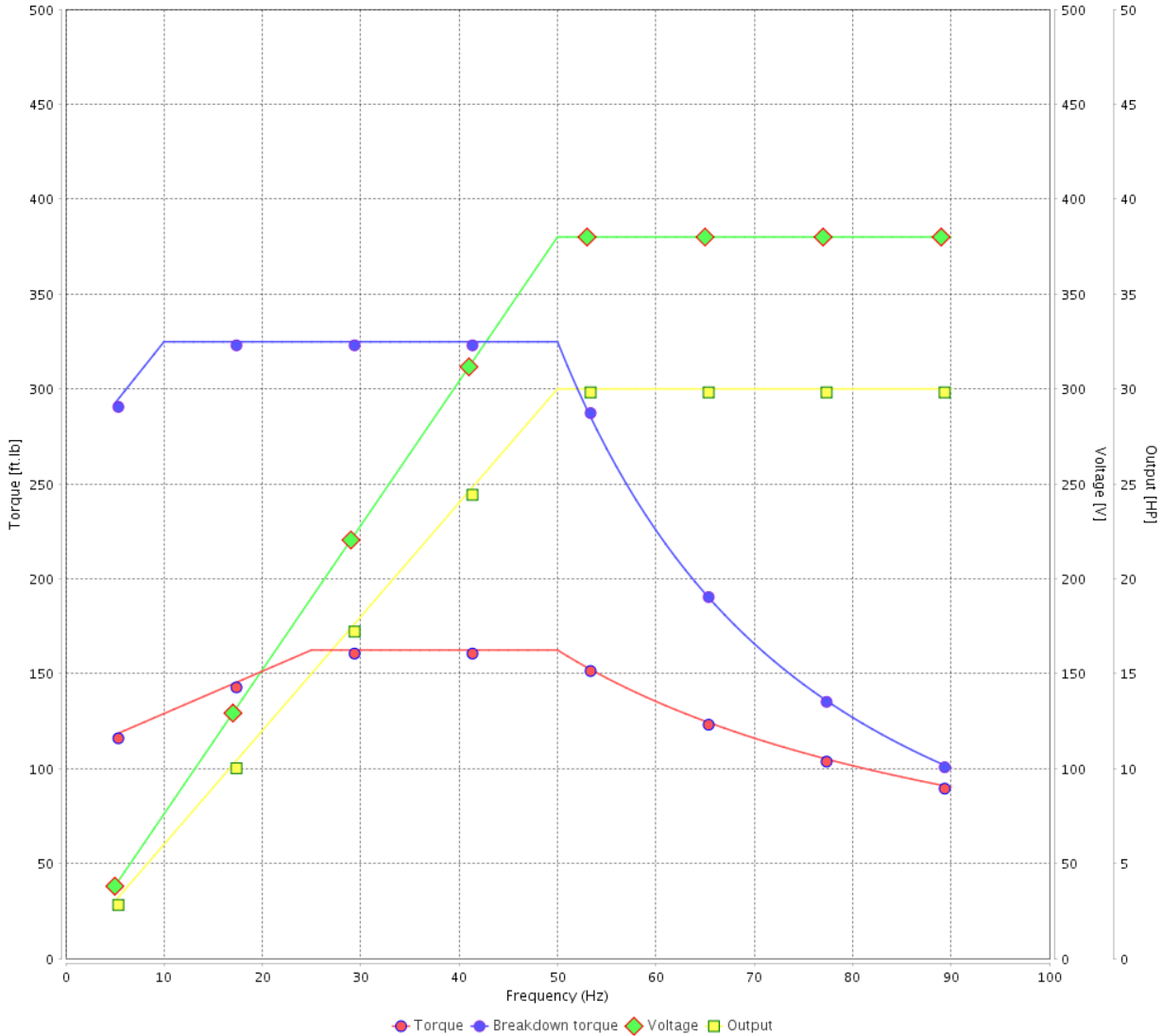

Performance : 380 V 50 Hz 6P IE2

Rated current : 43.7 A
 LRC : 4.9
 Rated torque : 162 ft.lb
 Locked rotor torque : 160 %
 Breakdown torque : 200 %
 Rated speed : 970 rpm

Moment of inertia (J) : 13.2 sq.ft.lb
 Duty cycle : Cont.(S1)
 Insulation class : F
 Service factor : 1.00
 Temperature rise : 80 K
 Design : B

Rev.	Changes Summary	Performed	Checked	Date
Performed by			Page 34 / 36	Revision
Checked by				
Date	14/04/2022			

VFD OPERATION CURVE

Three Phase Induction Motor - Squirrel Cage



Customer :

Product line : NEMA Premium Efficiency Three-Phase

Product code : 12039624

Catalog # : 03012ST3QIE326TC-W22

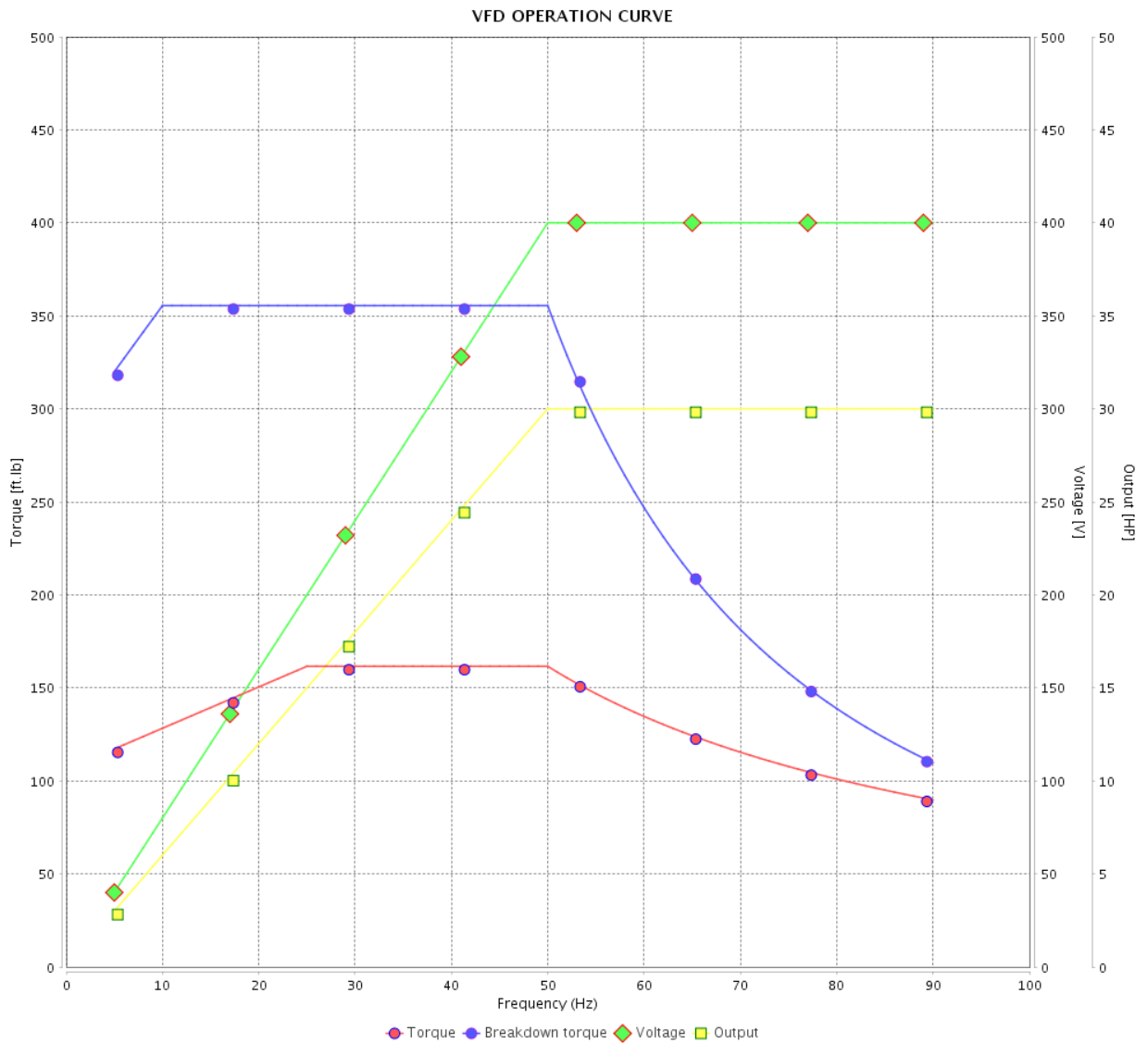

Performance : 400 V 50 Hz 6P IE2

Rated current : 41.7 A
 LRC : 5.4
 Rated torque : 162 ft.lb
 Locked rotor torque : 180 %
 Breakdown torque : 220 %
 Rated speed : 975 rpm

Moment of inertia (J) : 13.2 sq.ft.lb
 Duty cycle : Cont.(S1)
 Insulation class : F
 Service factor : 1.15
 Temperature rise : 80 K
 Design : B

Rev.	Changes Summary	Performed	Checked	Date
Performed by		Page		Revision
Checked by		35 / 36		
Date	14/04/2022			

VFD OPERATION CURVE

Three Phase Induction Motor - Squirrel Cage



Customer : _____

Product line : NEMA Premium Efficiency Three-Phase

Product code : 12039624

Catalog # : 03012ST3QIE326TC-W22

VFD OPERATION CURVE

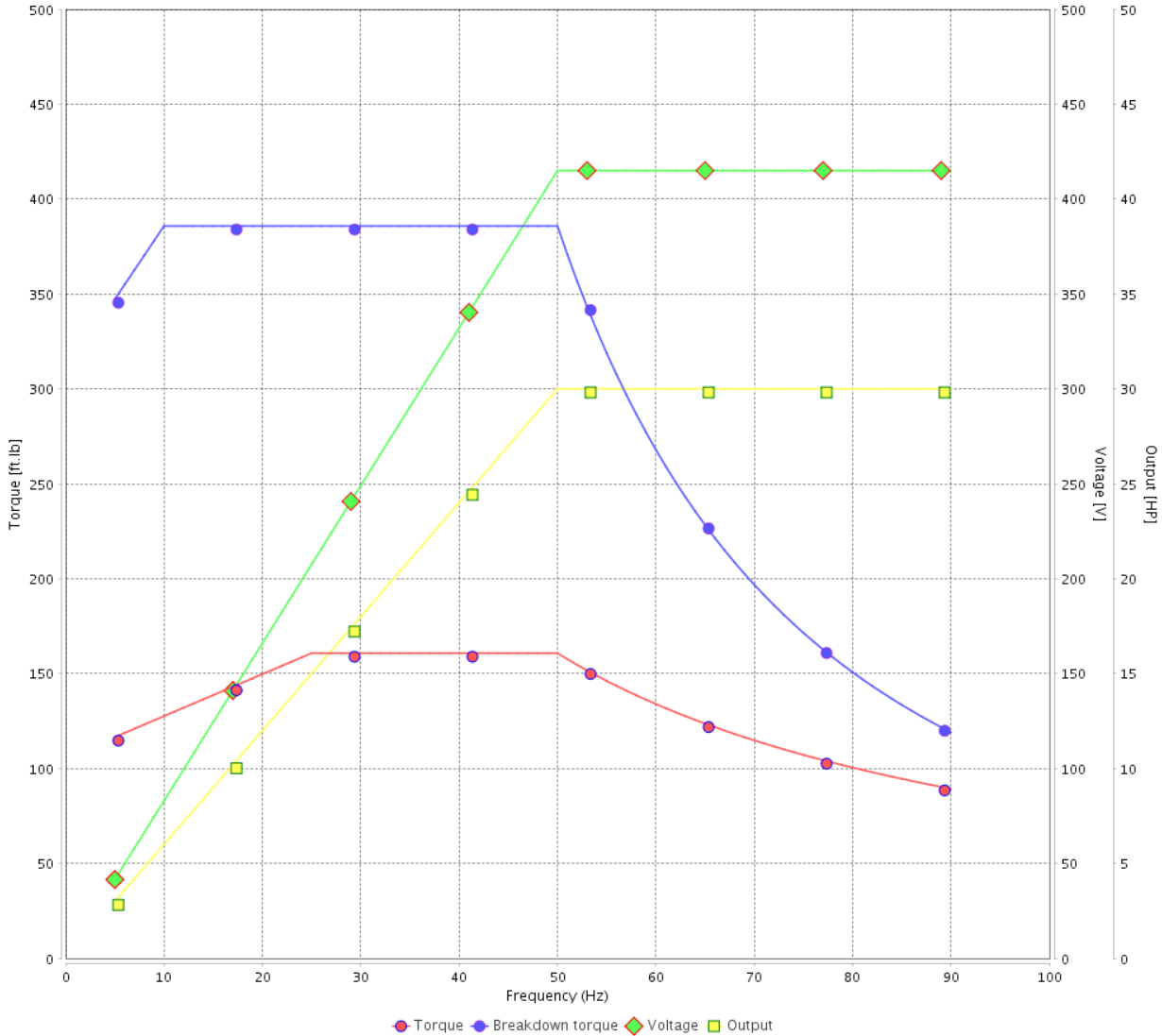

Performance : 415 V 50 Hz 6P IE2

Rated current	: 40.7 A	Moment of inertia (J)	: 13.2 sq.ft.lb
LRC	: 5.8	Duty cycle	: Cont.(S1)
Rated torque	: 161 ft.lb	Insulation class	: F
Locked rotor torque	: 200 %	Service factor	: 1.15
Breakdown torque	: 240 %	Temperature rise	: 80 K
Rated speed	: 980 rpm	Design	: B

Rev.	Changes Summary	Performed	Checked	Date
Performed by			Page 36 / 36	Revision
Checked by				
Date	14/04/2022			

1 2 3 4 5 6

A

B

C

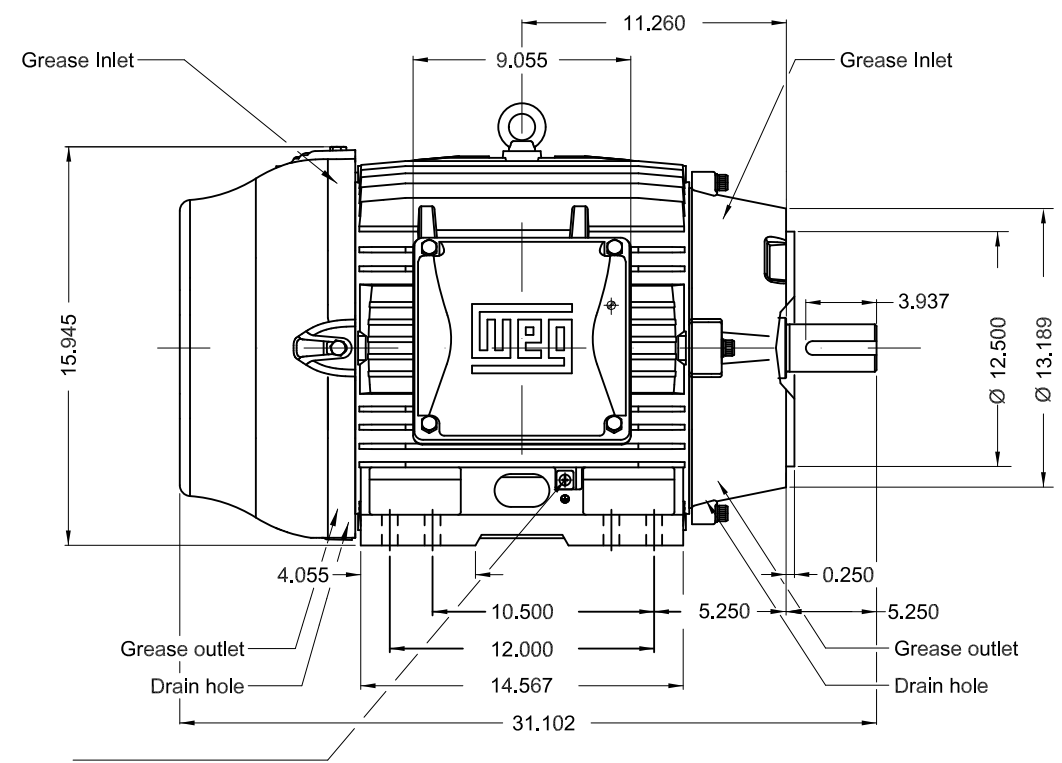
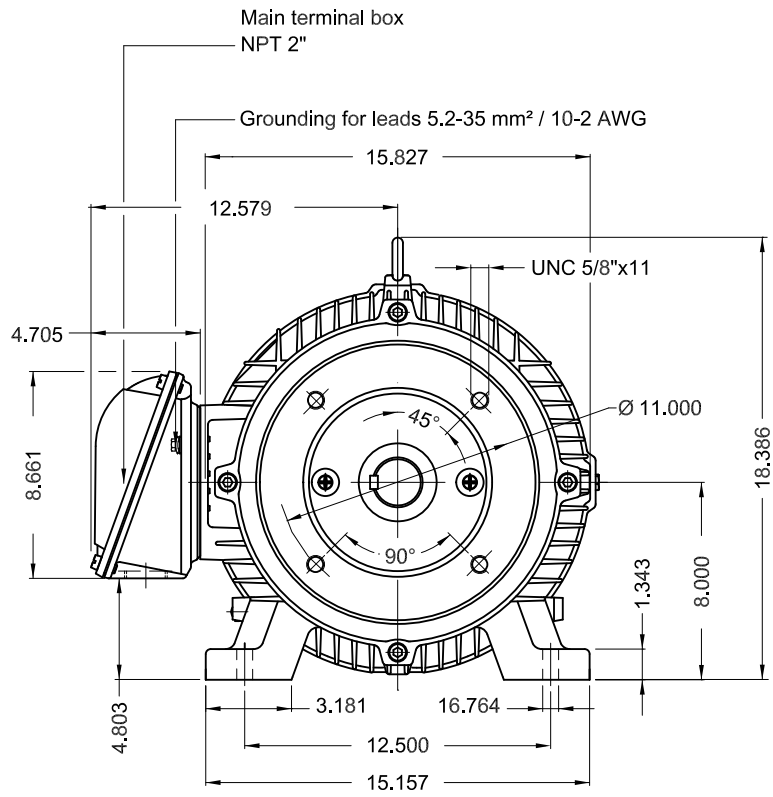

Grounding for leads 5.2-35 mm² / 10-2 AWG

D

E

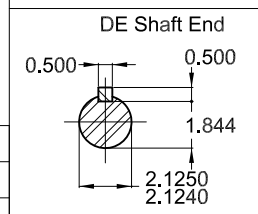

Color RAL 5009
Painting plan 202E
Mounting B34R(D)

30 HP 06 Poles 60 Hz A

ECM	LOC	SUMMARY OF MODIFICATIONS	EXECUTED	CHECKED	RELEASED	DATE	VER
EXECUTED	PIRWBUSER	THREE PH. MOTOR IEEE 841 W22 PREM. EFF.					
CHECKED		FRAME 324/6TC IP55 TEFC					
RELEASED							
REL DT.	WMO	Jaragua do Sul	Product Engineering	SHEET	1 / 1		

PREVIEW
WDD





NEMA
Premium
W22



FOR SAFE AREA
Mod.TE1BFOXON
CC029A



Class I, Div 2, Gr A, B, C and D - T3
Class I, Zone 2, IIC - T3
Class II, Div 2, Gr F and G - T4
For use on PWM: Gr. A, B, C, D and F,
VT 1000:1, CT 20:1, 1.00SF - T3A

MODEL 03012ST3QIE326TC-W22



Inverter Duty Motor
Severe Duty

MADE IN BRAZIL
12039624

PH3 60Hz Fr. 324/6TC 1000m.a.s.l. IP55 TEFC 613lb

V 460

A 36.2

HP 30

kW 22

SF 1.25

SFA 45.3

RPM 1180

PF 0.82

AMB 40°C

INS cl. F DT80K

NEMA NOM EFF 93.0%

DUTY CONT.

DES B Code G

GUARANT. EFF 91.7%

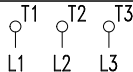

460V



→ 6312-C3 (21g) 60BC03X30

→ 6212-C3 (13g) 60BC02X30



MOBIL POLYREX EM (20000h)

