

DATA SHEET



Three Phase Induction Motor - Squirrel Cage

Customer :								
Product line	: NEMA Premium Efficiency Three-Phase	Product code :	11457167					
		Catalog # :	03018ET3E286TS-W22					
Frame	: 284/6TS	Cooling method	: IC411 - TEFC					
Insulation class	: F	Mounting	: F-1					
Duty cycle	: Cont.(S1)	Rotation ¹	: Both (CW and CCW)					
Ambient temperature	: -20°C to +40°C	Starting method	: Direct On Line					
Altitude	: 1000 m.a.s.l.	Approx. weight ²	: 465 lb					
Protection degree	: IP55	Moment of inertia (J)	: 5.85 sq.ft.lb					
Design	: B							
Output [HP]	30	25	25	25	30	30	30	
Poles	4	4	4	4	4	4	4	
Frequency [Hz]	60	50	50	50	50	50	50	
Rated voltage [V]	230/460	380	400	415	380	400	415	
Rated current [A]	70.2/35.1	35.7	34.3	33.9	43.1	41.1	39.7	
L. R. Amperes [A]	428/214	214	230	237	216	230	238	
LRC [A]	6.1x(Code G)	6.0x(Code G)	6.7x(Code H)	7.0x(Code H)	5.0x(Code E)	5.6x(Code F)	6.0x(Code G)	
No load current [A]	26.0/13.0	12.9	13.8	14.5	12.9	13.8	14.5	
Rated speed [RPM]	1765	1460	1465	1470	1445	1455	1460	
Slip [%]	1.94	2.67	2.33	2.00	3.67	3.00	2.67	
Rated torque [ft.lb]	89.3	89.9	89.6	89.3	109	108	108	
Locked rotor torque [%]	240	200	229	260	170	190	220	
Breakdown torque [%]	240	229	260	280	190	220	240	
Service factor	1.25	1.00	1.00	1.00	1.00	1.00	1.00	
Temperature rise	80 K	80 K	80 K	80 K	105 K	105 K	105 K	
Locked rotor time	36s (cold) 20s (hot)	27s (cold) 15s (hot)	27s (cold) 15s (hot)	27s (cold) 15s (hot)	27s (cold) 15s (hot)	27s (cold) 15s (hot)	27s (cold) 15s (hot)	
Noise level ²	63.0 dB(A)	61.0 dB(A)	61.0 dB(A)	61.0 dB(A)	61.0 dB(A)	61.0 dB(A)	61.0 dB(A)	
Efficiency (%)	25%	92.3	91.8	92.0	91.3	89.7	90.2	91.0
	50%	93.0	92.1	92.1	91.6	90.0	90.5	91.2
	75%	93.0	92.5	92.8	92.5	90.2	91.0	91.7
	100%	93.6	92.6	92.7	92.6	90.2	91.0	91.7
Power Factor	25%	0.46	0.46	0.43	0.40	0.52	0.49	0.46
	50%	0.70	0.70	0.67	0.64	0.76	0.73	0.70
	75%	0.80	0.81	0.79	0.76	0.83	0.82	0.80
	100%	0.84	0.85	0.84	0.82	0.86	0.85	0.84
Bearing type	: Drive end : 6311 C3	Non drive end : 6211 C3	Foundation loads					
Sealing	: V'Ring	V'Ring	Max. traction	: 897 lb				
Lubrication interval	: 20000 h	20000 h	Max. compression	: 1362 lb				
Lubricant amount	: 18 g	11 g						
Lubricant type	: Mobil Polyrex EM							
Notes								
USABLE @208V 77.6A SF 1.15 SFA 89.3A								
This revision replaces and cancel the previous one, which must be eliminated. (1) Looking the motor from the shaft end. (2) Measured at 1m and with tolerance of +3dB(A). (3) Approximate weight subject to changes after manufacturing process. (4) At 100% of full load.				These are average values based on tests with sinusoidal power supply, subject to the tolerances stipulated in NEMA MG-1.				
Rev.	Changes Summary			Performed	Checked	Date		
Performed by								
Checked by					Page	Revision		
Date	14/04/2022				1 / 36			

TORQUE AND CURRENT VS SPEED CURVE

Three Phase Induction Motor - Squirrel Cage



Customer :

Product line : NEMA Premium Efficiency Three-Phase

Product code : 11457167

Catalog # : 03018ET3E286TS-W22

TORQUE AND CURRENT VS SPEED CURVE

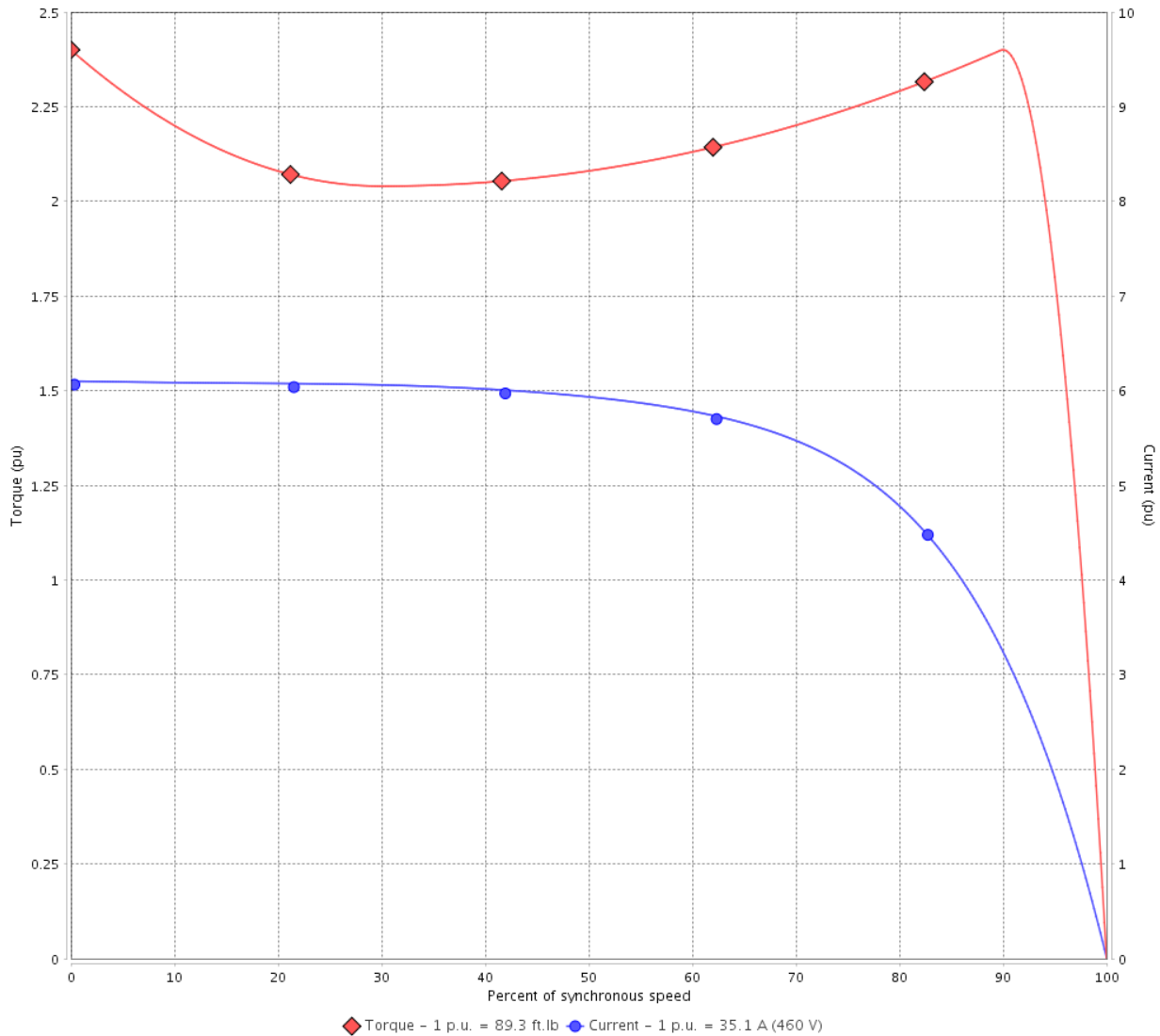

Performance : 230/460 V 60 Hz 4P

Rated current	: 70.2/35.1 A	Moment of inertia (J)	: 5.85 sq.ft.lb
LRC	: 6.1	Duty cycle	: Cont.(S1)
Rated torque	: 89.3 ft.lb	Insulation class	: F
Locked rotor torque	: 240 %	Service factor	: 1.25
Breakdown torque	: 240 %	Temperature rise	: 80 K
Rated speed	: 1765 rpm	Design	: B

Locked rotor time : 36s (cold) 20s (hot)

Rev.	Changes Summary	Performed	Checked	Date
Performed by			Page 2 / 36	Revision
Checked by				
Date	14/04/2022			

TORQUE AND CURRENT VS SPEED CURVE



Three Phase Induction Motor - Squirrel Cage

Customer :

Product line : NEMA Premium Efficiency Three-Phase

Product code : 11457167

Catalog # : 03018ET3E286TS-W22

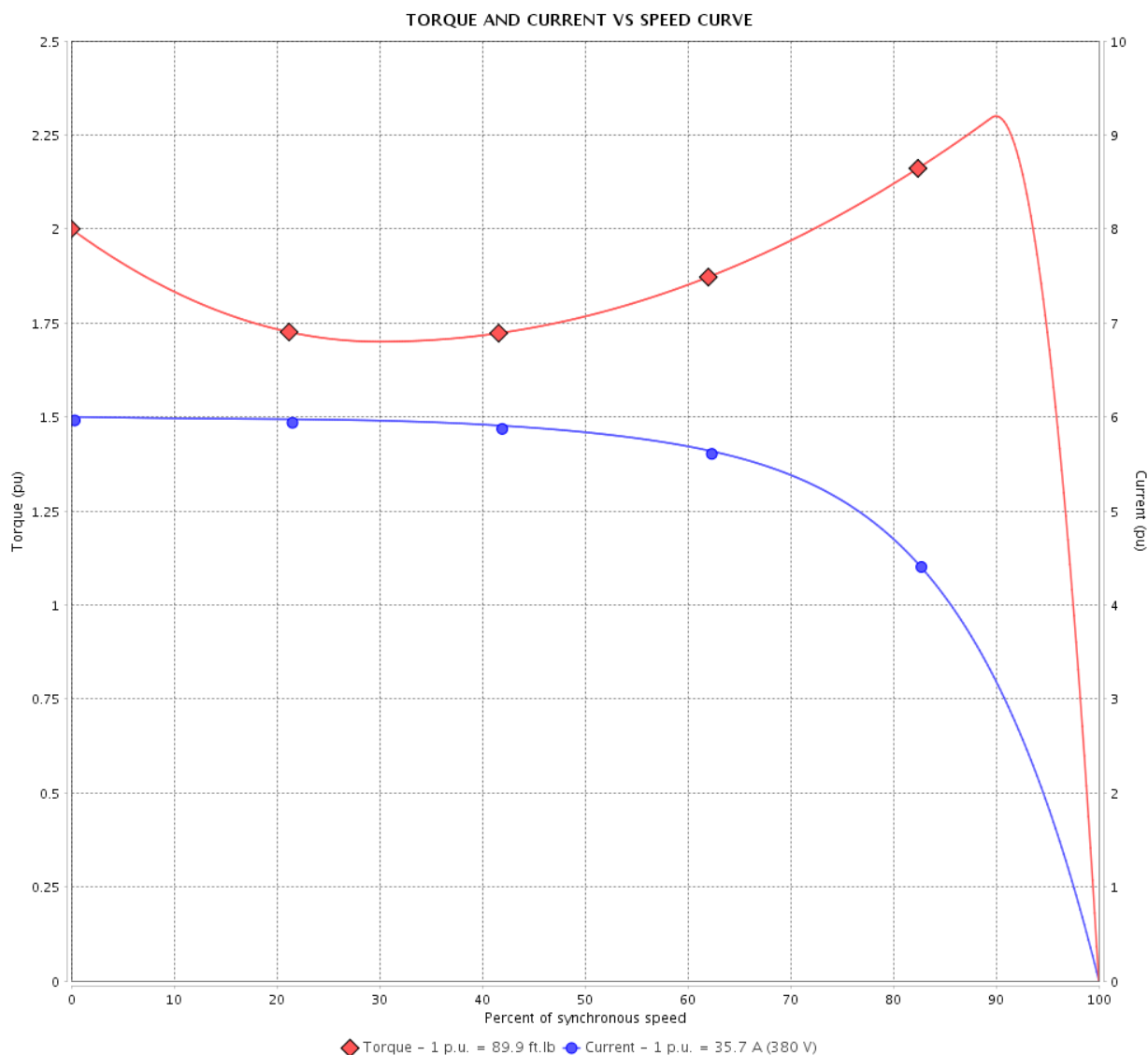

Performance : 380 V 50 Hz 4P IE3

Rated current	: 35.7 A	Moment of inertia (J)	: 5.85 sq.ft.lb
LRC	: 6.0	Duty cycle	: Cont.(S1)
Rated torque	: 89.9 ft.lb	Insulation class	: F
Locked rotor torque	: 200 %	Service factor	: 1.00
Breakdown torque	: 229 %	Temperature rise	: 80 K
Rated speed	: 1460 rpm	Design	: B

Locked rotor time : 27s (cold) 15s (hot)

Rev.	Changes Summary	Performed	Checked	Date
Performed by			Page 3 / 36	Revision
Checked by				
Date	14/04/2022			

TORQUE AND CURRENT VS SPEED CURVE

Three Phase Induction Motor - Squirrel Cage



Customer :

Product line : NEMA Premium Efficiency Three-Phase

Product code : 11457167

Catalog # : 03018ET3E286TS-W22

TORQUE AND CURRENT VS SPEED CURVE

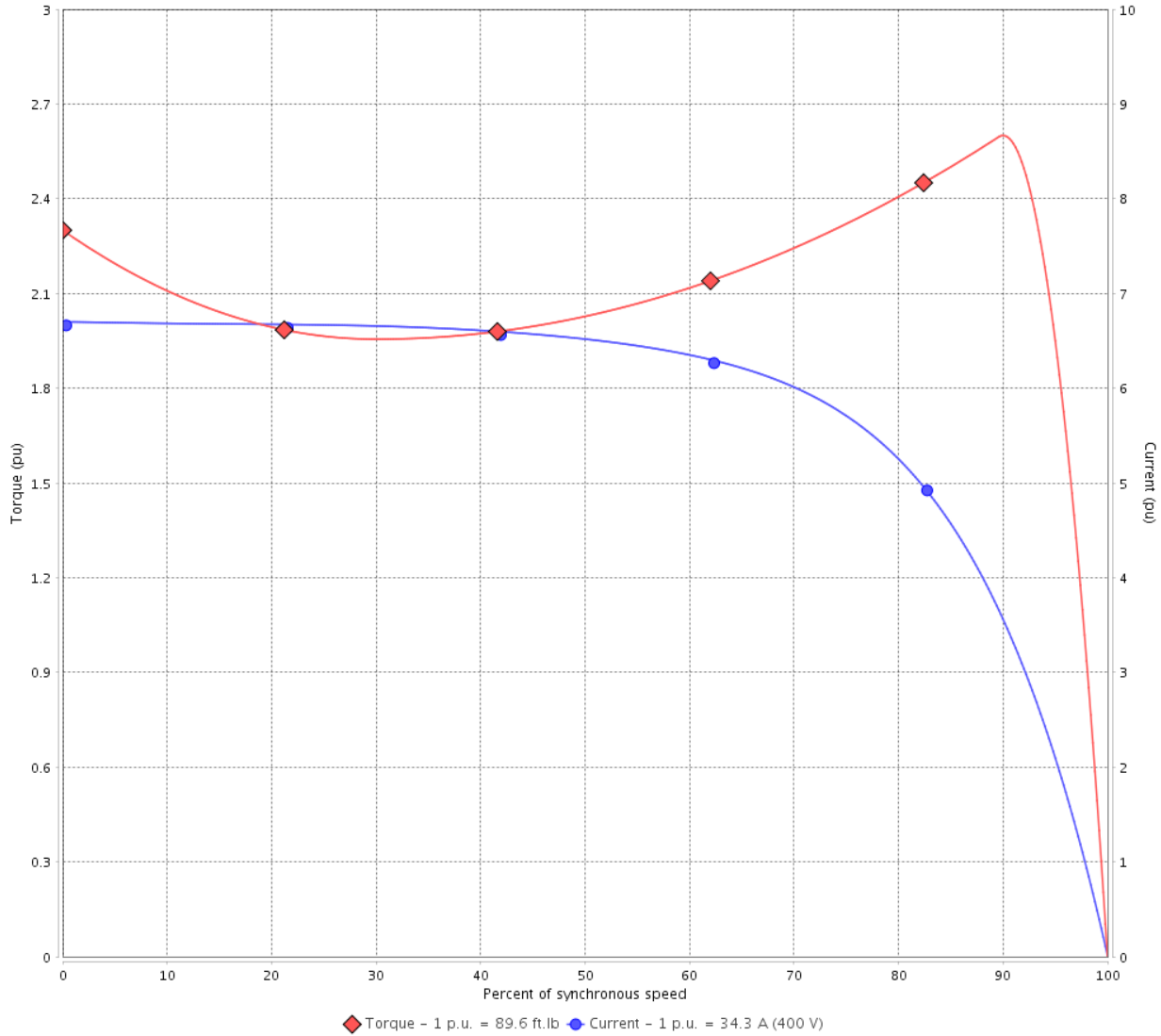

Performance : 400 V 50 Hz 4P IE3

Rated current	: 34.3 A	Moment of inertia (J)	: 5.85 sq.ft.lb
LRC	: 6.7	Duty cycle	: Cont.(S1)
Rated torque	: 89.6 ft.lb	Insulation class	: F
Locked rotor torque	: 229 %	Service factor	: 1.00
Breakdown torque	: 260 %	Temperature rise	: 80 K
Rated speed	: 1465 rpm	Design	: B

Locked rotor time : 27s (cold) 15s (hot)

Rev.	Changes Summary	Performed	Checked	Date
Performed by			Page 4 / 36	Revision
Checked by				
Date	14/04/2022			

TORQUE AND CURRENT VS SPEED CURVE



Three Phase Induction Motor - Squirrel Cage

Customer :

Product line : NEMA Premium Efficiency Three-Phase

Product code : 11457167

Catalog # : 03018ET3E286TS-W22

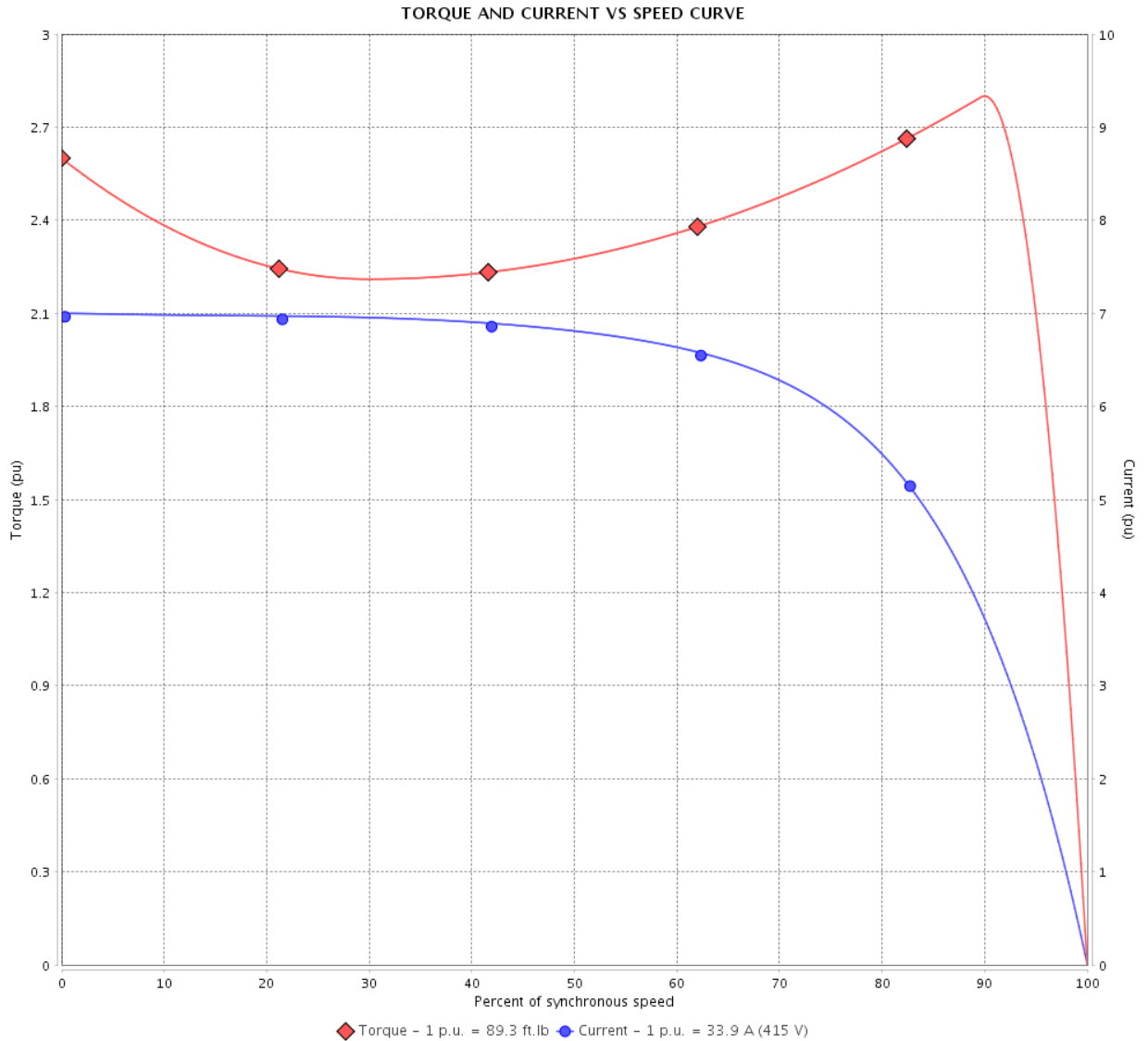

Performance : 415 V 50 Hz 4P IE3

Rated current	: 33.9 A	Moment of inertia (J)	: 5.85 sq.ft.lb
LRC	: 7.0	Duty cycle	: Cont.(S1)
Rated torque	: 89.3 ft.lb	Insulation class	: F
Locked rotor torque	: 260 %	Service factor	: 1.00
Breakdown torque	: 280 %	Temperature rise	: 80 K
Rated speed	: 1470 rpm	Design	: B

Locked rotor time : 27s (cold) 15s (hot)

Rev.	Changes Summary	Performed	Checked	Date
Performed by			Page 5 / 36	Revision
Checked by				
Date	14/04/2022			

TORQUE AND CURRENT VS SPEED CURVE

Three Phase Induction Motor - Squirrel Cage



Customer :

Product line : NEMA Premium Efficiency Three-Phase

Product code : 11457167

Catalog # : 03018ET3E286TS-W22

TORQUE AND CURRENT VS SPEED CURVE

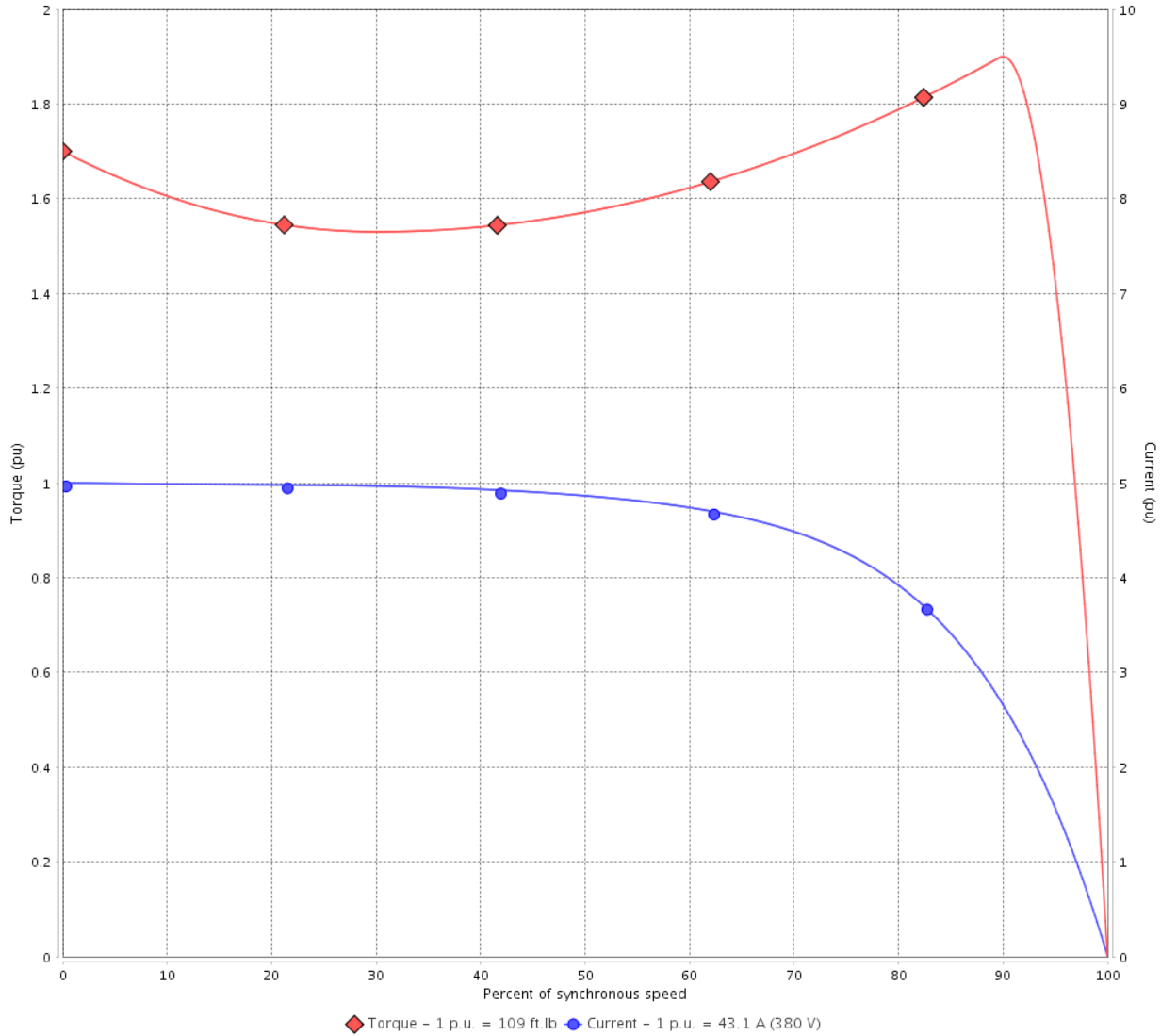

Performance : 380 V 50 Hz 4P IE1

Rated current	: 43.1 A	Moment of inertia (J)	: 5.85 sq.ft.lb
LRC	: 5.0	Duty cycle	: Cont.(S1)
Rated torque	: 109 ft.lb	Insulation class	: F
Locked rotor torque	: 170 %	Service factor	: 1.00
Breakdown torque	: 190 %	Temperature rise	: 105 K
Rated speed	: 1445 rpm	Design	: B

Locked rotor time : 27s (cold) 15s (hot)

Rev.	Changes Summary	Performed	Checked	Date
Performed by			Page 6 / 36	Revision
Checked by				
Date	14/04/2022			

TORQUE AND CURRENT VS SPEED CURVE



Three Phase Induction Motor - Squirrel Cage

Customer :

Product line : NEMA Premium Efficiency Three-Phase

Product code : 11457167

Catalog # : 03018ET3E286TS-W22

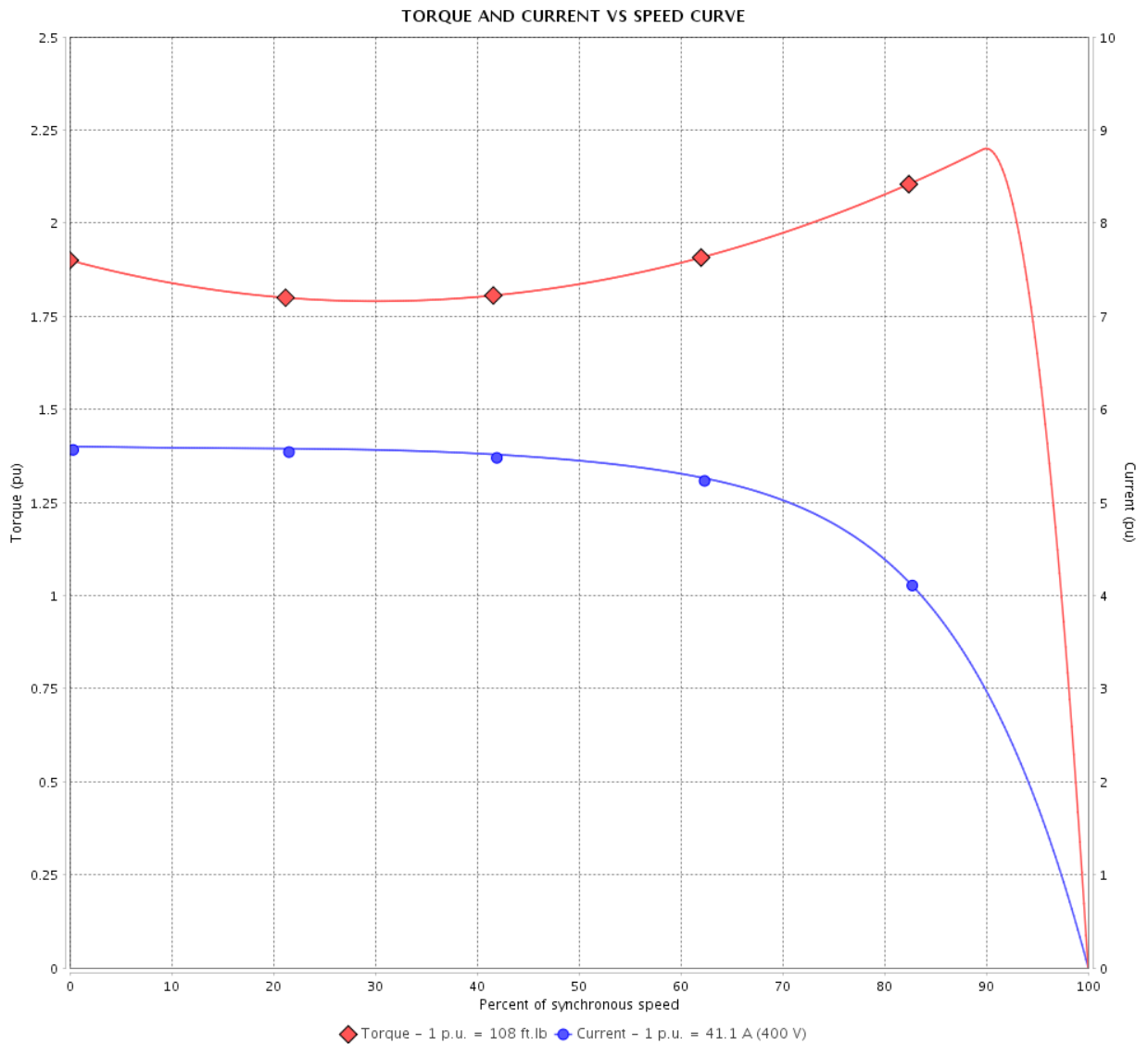

Performance : 400 V 50 Hz 4P IE1

Rated current	: 41.1 A	Moment of inertia (J)	: 5.85 sq.ft.lb
LRC	: 5.6	Duty cycle	: Cont.(S1)
Rated torque	: 108 ft.lb	Insulation class	: F
Locked rotor torque	: 190 %	Service factor	: 1.00
Breakdown torque	: 220 %	Temperature rise	: 105 K
Rated speed	: 1455 rpm	Design	: B

Locked rotor time : 27s (cold) 15s (hot)

Rev.	Changes Summary	Performed	Checked	Date
Performed by			Page 7 / 36	Revision
Checked by				
Date	14/04/2022			

TORQUE AND CURRENT VS SPEED CURVE

Three Phase Induction Motor - Squirrel Cage



Customer :

Product line : NEMA Premium Efficiency Three-Phase

Product code : 11457167

Catalog # : 03018ET3E286TS-W22

TORQUE AND CURRENT VS SPEED CURVE

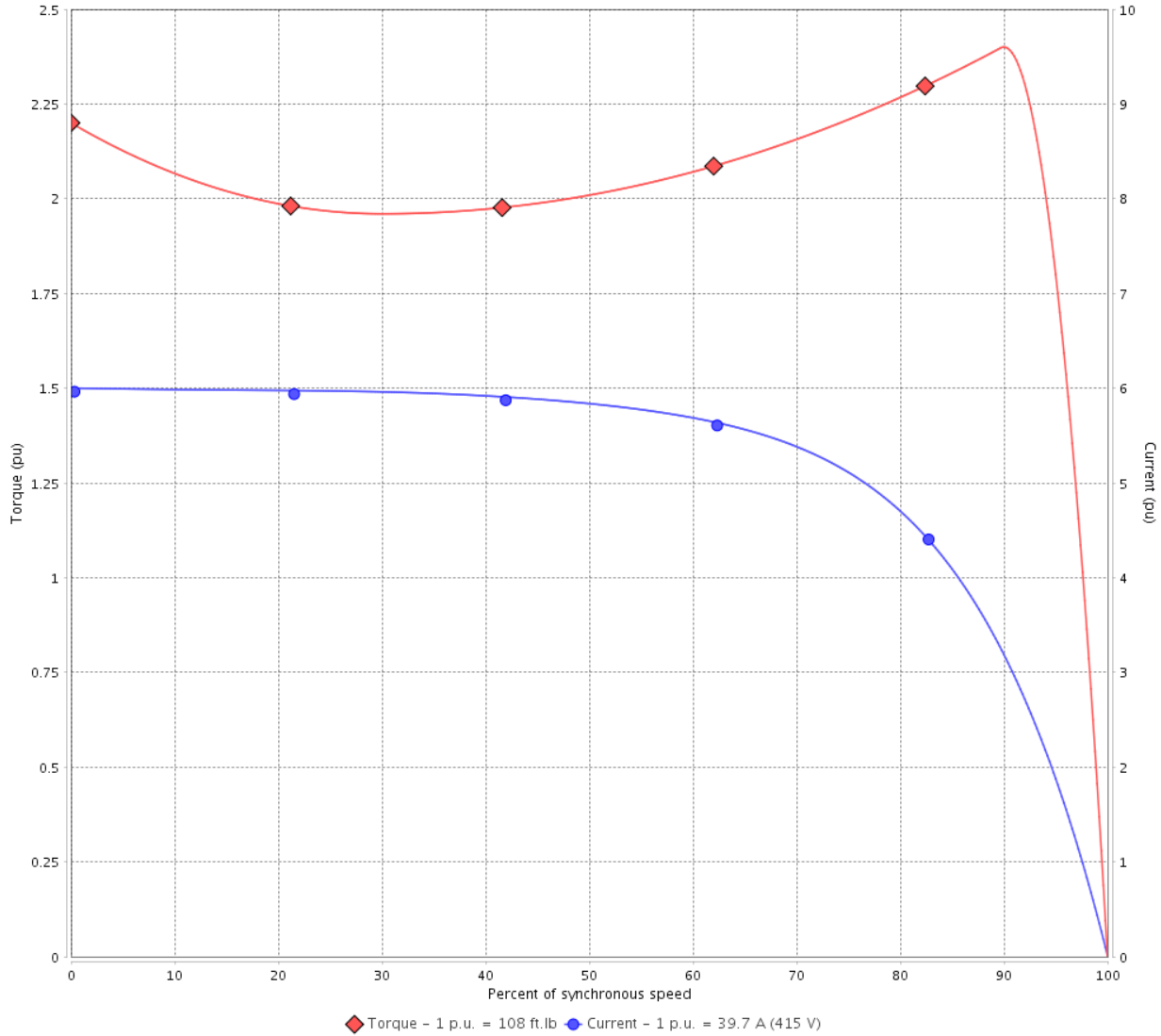

Performance : 415 V 50 Hz 4P IE2

Rated current	: 39.7 A	Moment of inertia (J)	: 5.85 sq.ft.lb
LRC	: 6.0	Duty cycle	: Cont.(S1)
Rated torque	: 108 ft.lb	Insulation class	: F
Locked rotor torque	: 220 %	Service factor	: 1.00
Breakdown torque	: 240 %	Temperature rise	: 105 K
Rated speed	: 1460 rpm	Design	: B

Locked rotor time : 27s (cold) 15s (hot)

Rev.	Changes Summary	Performed	Checked	Date
Performed by			Page 8 / 36	Revision
Checked by				
Date	14/04/2022			

LOAD PERFORMANCE CURVE

Three Phase Induction Motor - Squirrel Cage



Customer :

Product line : NEMA Premium Efficiency Three-Phase

Product code : 11457167

Catalog # : 03018ET3E286TS-W22

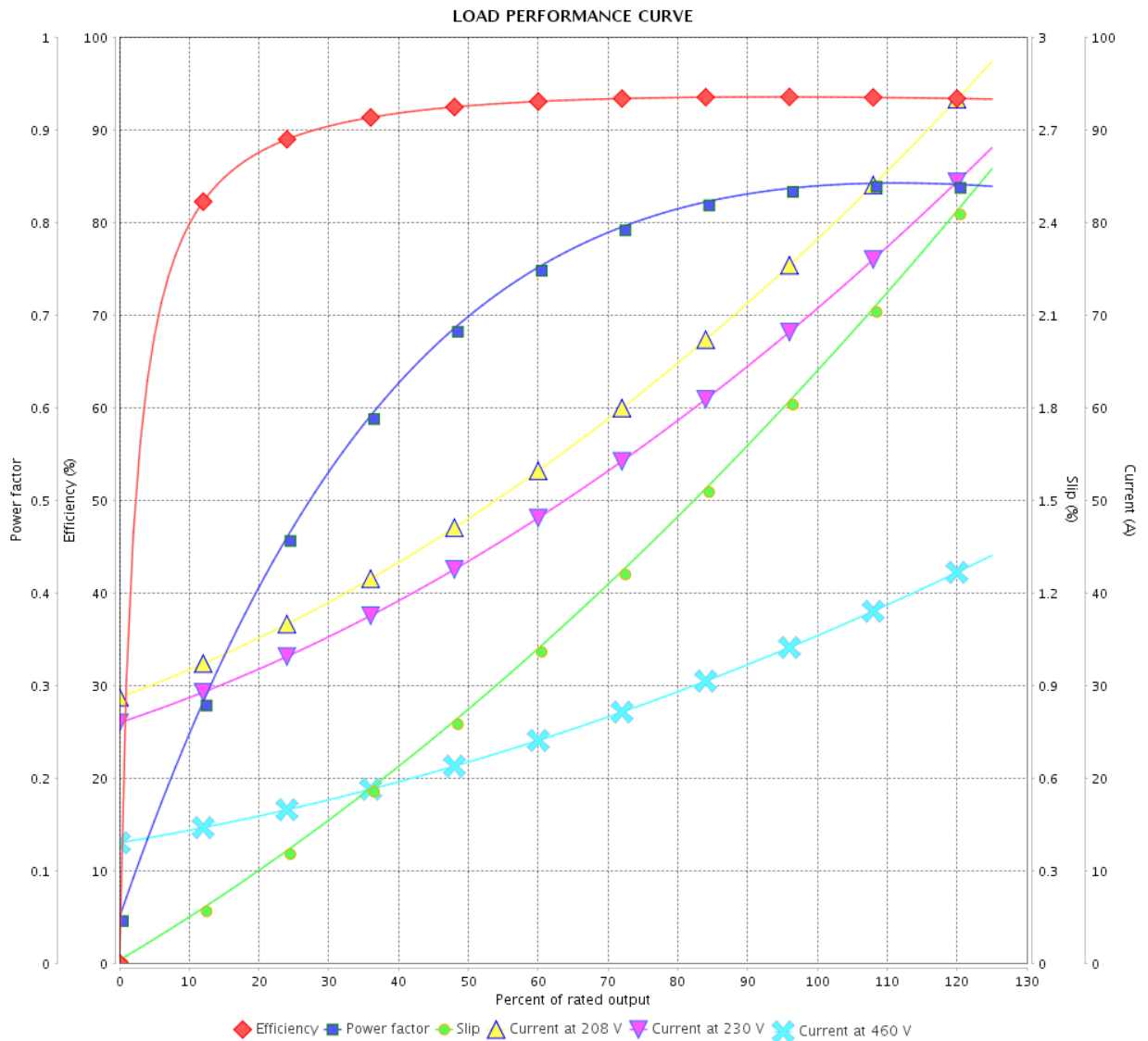

Performance : 230/460 V 60 Hz 4P

Rated current : 70.2/35.1 A
 LRC : 6.1
 Rated torque : 89.3 ft.lb
 Locked rotor torque : 240 %
 Breakdown torque : 240 %
 Rated speed : 1765 rpm

Moment of inertia (J) : 5.85 sq.ft.lb
 Duty cycle : Cont.(S1)
 Insulation class : F
 Service factor : 1.25
 Temperature rise : 80 K
 Design : B

Rev.	Changes Summary	Performed	Checked	Date
Performed by			Page	Revision
Checked by				
Date				

LOAD PERFORMANCE CURVE

Three Phase Induction Motor - Squirrel Cage



Customer :

Product line : NEMA Premium Efficiency Three-Phase

Product code : 11457167

Catalog # : 03018ET3E286TS-W22

LOAD PERFORMANCE CURVE

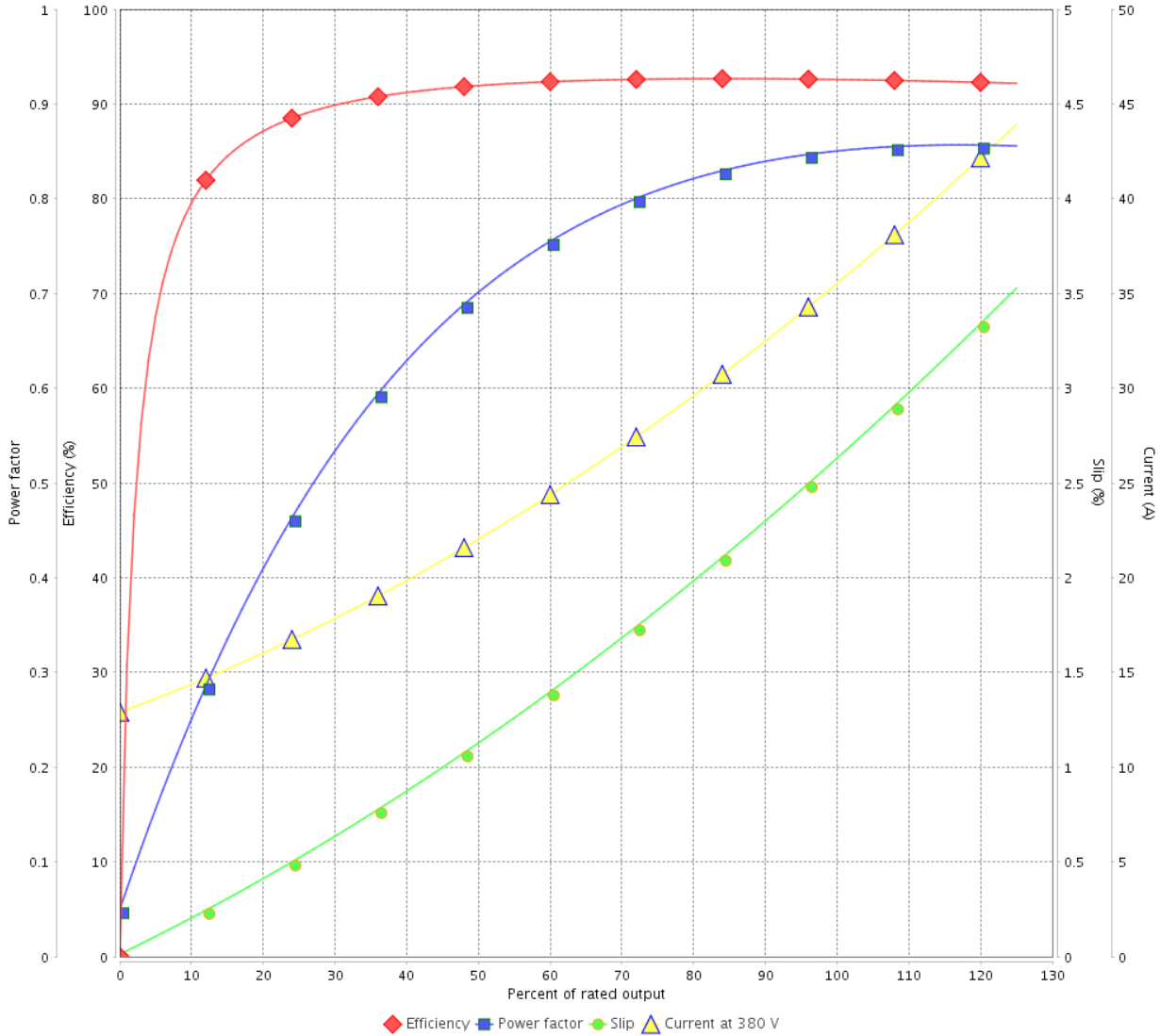

Performance : 380 V 50 Hz 4P IE3

Rated current : 35.7 A
 LRC : 6.0
 Rated torque : 89.9 ft.lb
 Locked rotor torque : 200 %
 Breakdown torque : 229 %
 Rated speed : 1460 rpm

Moment of inertia (J) : 5.85 sq.ft.lb
 Duty cycle : Cont.(S1)
 Insulation class : F
 Service factor : 1.00
 Temperature rise : 80 K
 Design : B

Rev.	Changes Summary	Performed	Checked	Date
Performed by			Page 10 / 36	Revision
Checked by				
Date	14/04/2022			

LOAD PERFORMANCE CURVE

Three Phase Induction Motor - Squirrel Cage



Customer :

Product line : NEMA Premium Efficiency Three-Phase

Product code : 11457167

Catalog # : 03018ET3E286TS-W22

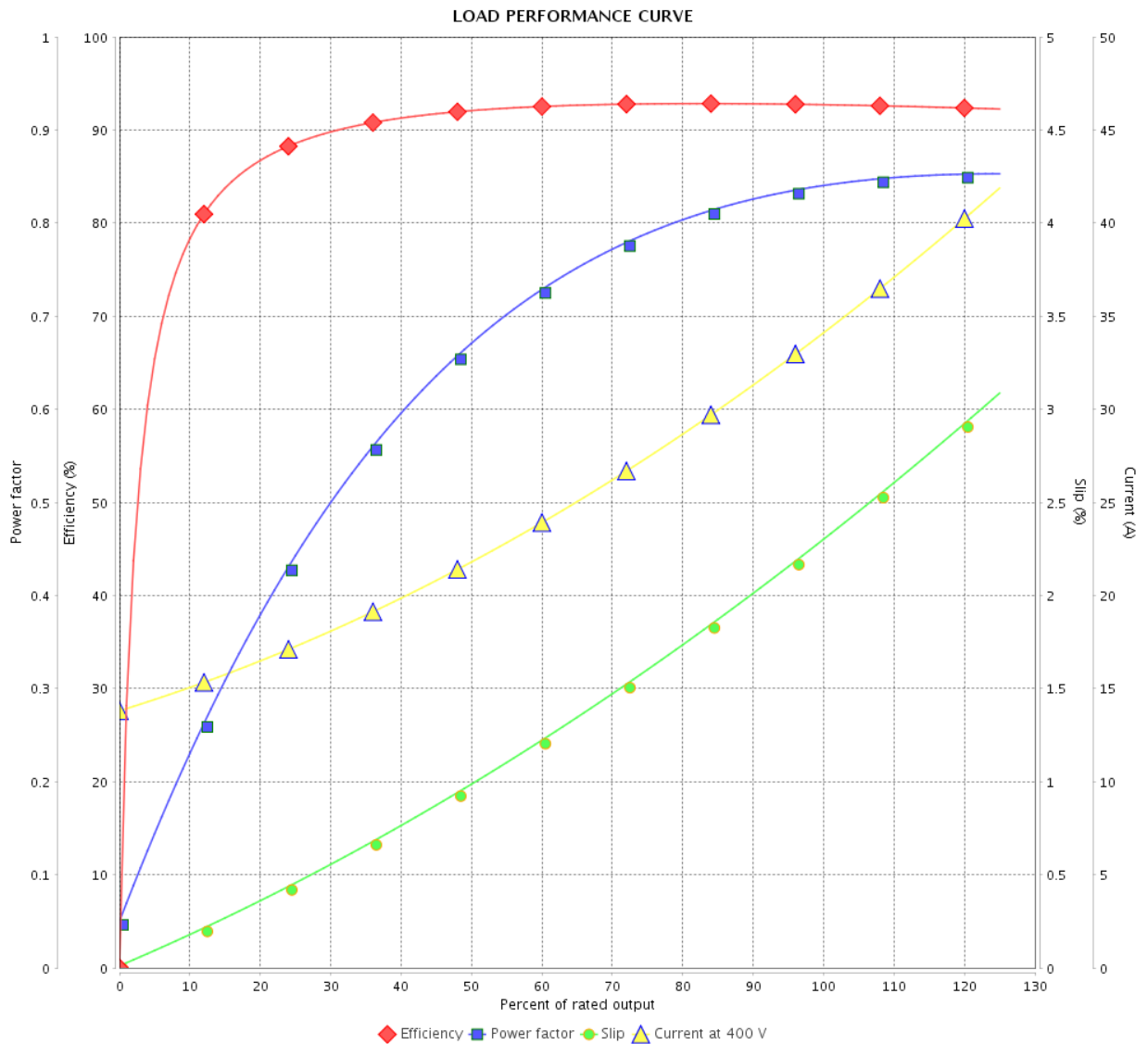

Performance : 400 V 50 Hz 4P IE3

Rated current : 34.3 A
 LRC : 6.7
 Rated torque : 89.6 ft.lb
 Locked rotor torque : 229 %
 Breakdown torque : 260 %
 Rated speed : 1465 rpm

Moment of inertia (J) : 5.85 sq.ft.lb
 Duty cycle : Cont.(S1)
 Insulation class : F
 Service factor : 1.00
 Temperature rise : 80 K
 Design : B

Rev.	Changes Summary	Performed	Checked	Date
Performed by			Page	Revision
Checked by			11 / 36	
Date	14/04/2022			

LOAD PERFORMANCE CURVE

Three Phase Induction Motor - Squirrel Cage



Customer :

Product line : NEMA Premium Efficiency Three-Phase

Product code : 11457167

Catalog # : 03018ET3E286TS-W22

LOAD PERFORMANCE CURVE

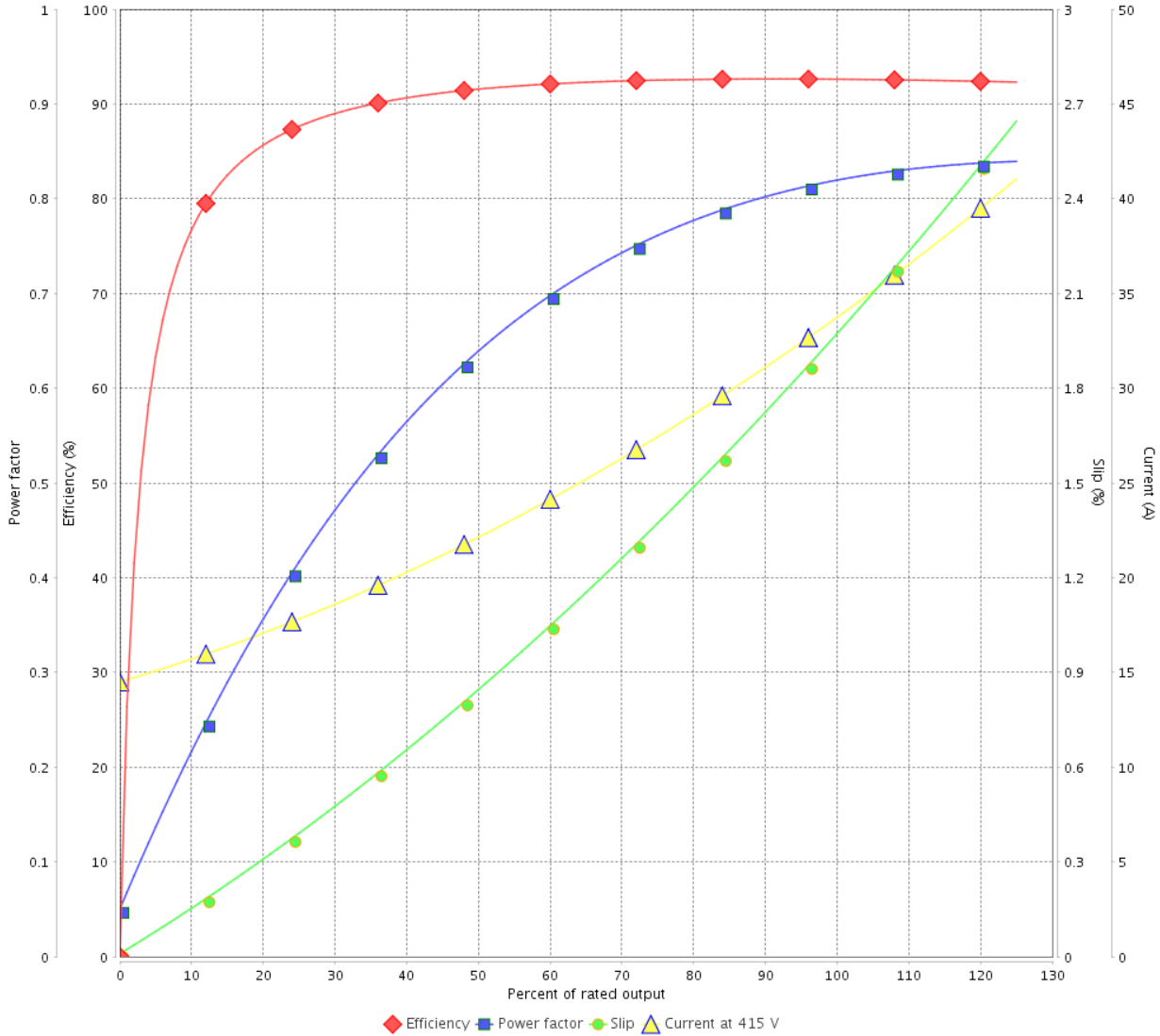

Performance : 415 V 50 Hz 4P IE3

Rated current	: 33.9 A	Moment of inertia (J)	: 5.85 sq.ft.lb
LRC	: 7.0	Duty cycle	: Cont.(S1)
Rated torque	: 89.3 ft.lb	Insulation class	: F
Locked rotor torque	: 260 %	Service factor	: 1.00
Breakdown torque	: 280 %	Temperature rise	: 80 K
Rated speed	: 1470 rpm	Design	: B

Rev.	Changes Summary	Performed	Checked	Date
Performed by			Page	Revision
Checked by			12 / 36	
Date	14/04/2022			

LOAD PERFORMANCE CURVE

Three Phase Induction Motor - Squirrel Cage



Customer : _____

Product line : NEMA Premium Efficiency Three-Phase

Product code : 11457167

Catalog # : 03018ET3E286TS-W22

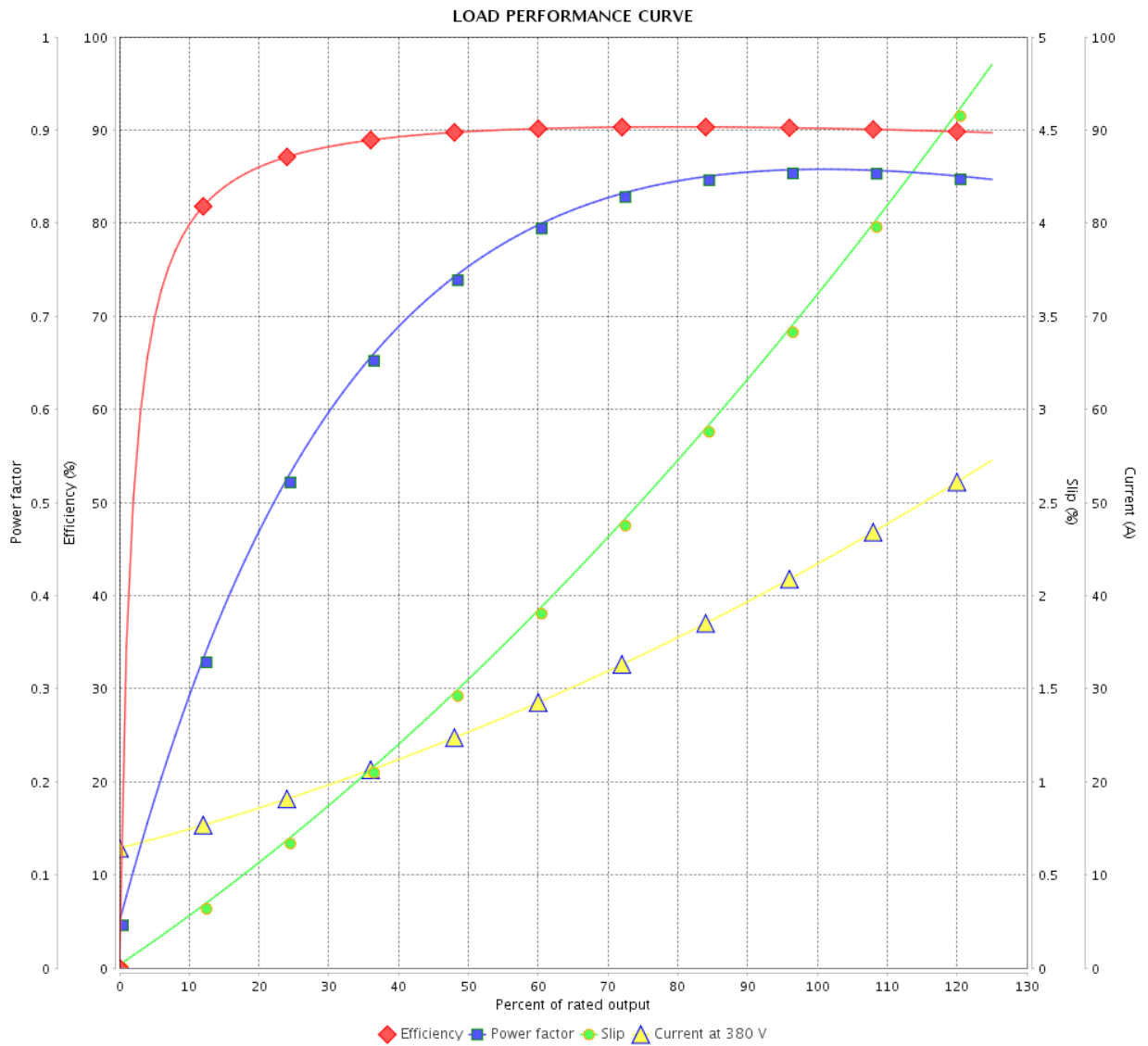

Performance : 380 V 50 Hz 4P IE1

Rated current : 43.1 A
 LRC : 5.0
 Rated torque : 109 ft.lb
 Locked rotor torque : 170 %
 Breakdown torque : 190 %
 Rated speed : 1445 rpm

Moment of inertia (J) : 5.85 sq.ft.lb
 Duty cycle : Cont.(S1)
 Insulation class : F
 Service factor : 1.00
 Temperature rise : 105 K
 Design : B

Rev.	Changes Summary	Performed	Checked	Date
Performed by			Page	Revision
Checked by				
Date				
			13 / 36	

LOAD PERFORMANCE CURVE

Three Phase Induction Motor - Squirrel Cage



Customer :

Product line : NEMA Premium Efficiency Three-Phase

Product code : 11457167

Catalog # : 03018ET3E286TS-W22

LOAD PERFORMANCE CURVE

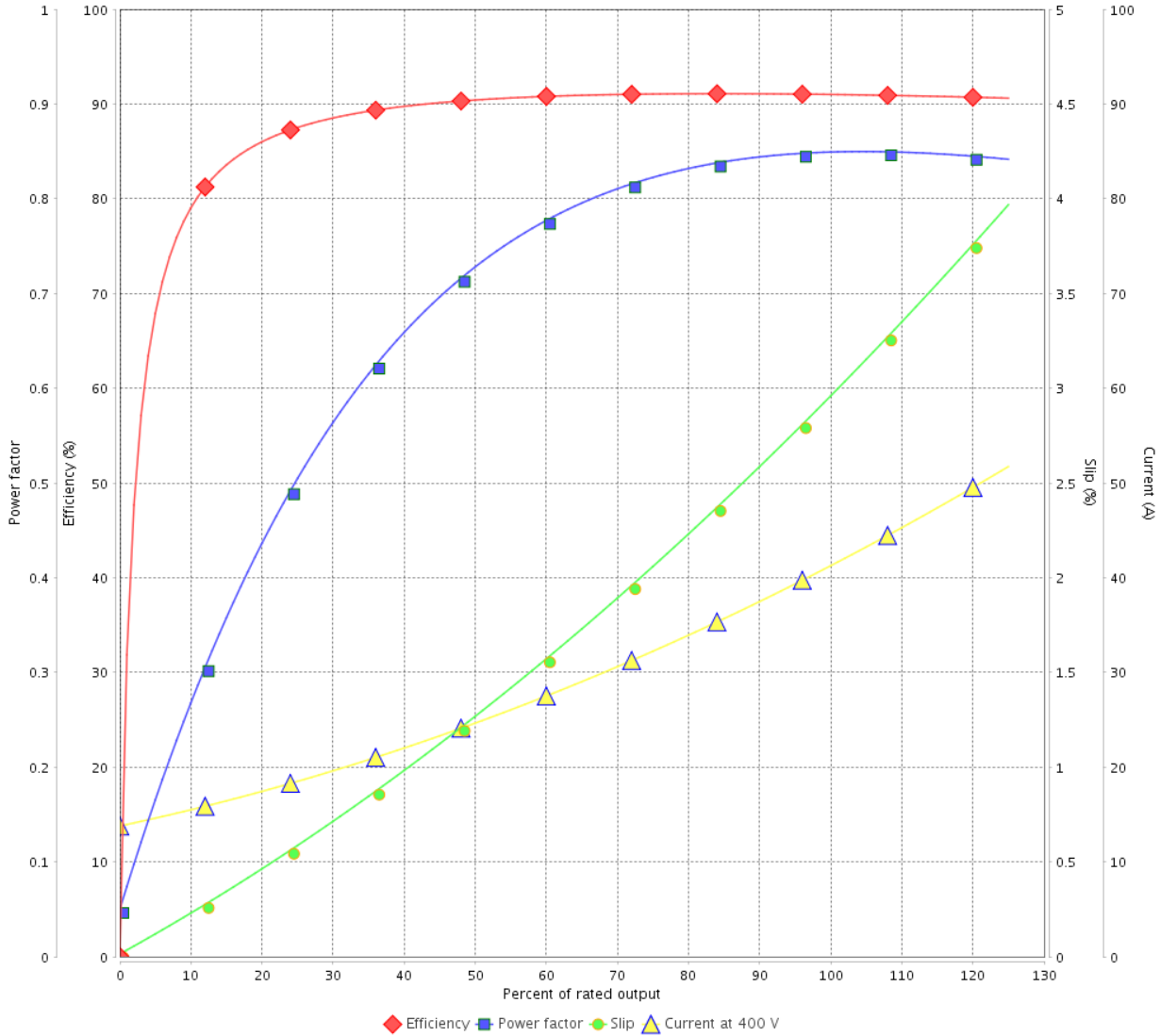

Performance : 400 V 50 Hz 4P IE1

Rated current	: 41.1 A	Moment of inertia (J)	: 5.85 sq.ft.lb
LRC	: 5.6	Duty cycle	: Cont.(S1)
Rated torque	: 108 ft.lb	Insulation class	: F
Locked rotor torque	: 190 %	Service factor	: 1.00
Breakdown torque	: 220 %	Temperature rise	: 105 K
Rated speed	: 1455 rpm	Design	: B

Rev.	Changes Summary	Performed	Checked	Date
Performed by			Page 14 / 36	Revision
Checked by				
Date	14/04/2022			

LOAD PERFORMANCE CURVE

Three Phase Induction Motor - Squirrel Cage



Customer :

Product line : NEMA Premium Efficiency Three-Phase

Product code : 11457167

Catalog # : 03018ET3E286TS-W22

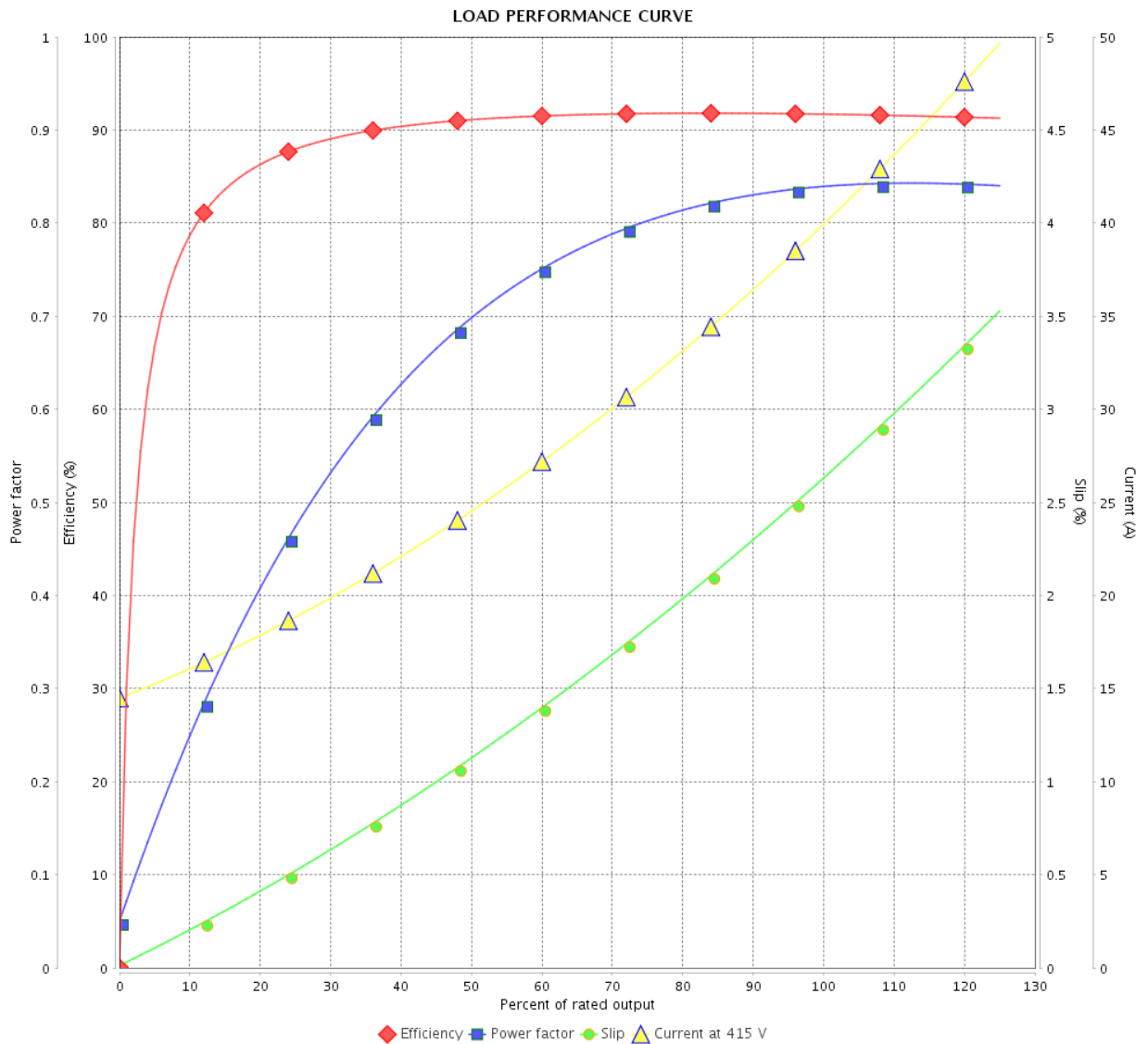

Performance : 415 V 50 Hz 4P IE2

Rated current : 39.7 A
 LRC : 6.0
 Rated torque : 108 ft.lb
 Locked rotor torque : 220 %
 Breakdown torque : 240 %
 Rated speed : 1460 rpm

Moment of inertia (J) : 5.85 sq.ft.lb
 Duty cycle : Cont.(S1)
 Insulation class : F
 Service factor : 1.00
 Temperature rise : 105 K
 Design : B

Rev.	Changes Summary	Performed	Checked	Date
Performed by			Page	Revision
Checked by				
Date				
			15 / 36	

THERMAL LIMIT CURVE



Three Phase Induction Motor - Squirrel Cage

Customer :

Product line : NEMA Premium Efficiency Three-Phase
Product code : 11457167
Catalog # : 03018ET3E286TS-W22

Performance : 230/460 V 60 Hz 4P

Rated current	: 70.2/35.1 A	Moment of inertia (J)	: 5.85 sq.ft.lb
LRC	: 6.1	Duty cycle	: Cont.(S1)
Rated torque	: 89.3 ft.lb	Insulation class	: F
Locked rotor torque	: 240 %	Service factor	: 1.25
Breakdown torque	: 240 %	Temperature rise	: 80 K
Rated speed	: 1765 rpm	Design	: B

Heating constant

Cooling constant

Rev.	Changes Summary	Performed	Checked	Date
Performed by				
Checked by			Page	Revision
Date	14/04/2022		16 / 36	

THERMAL LIMIT CURVE

Three Phase Induction Motor - Squirrel Cage



Customer : _____

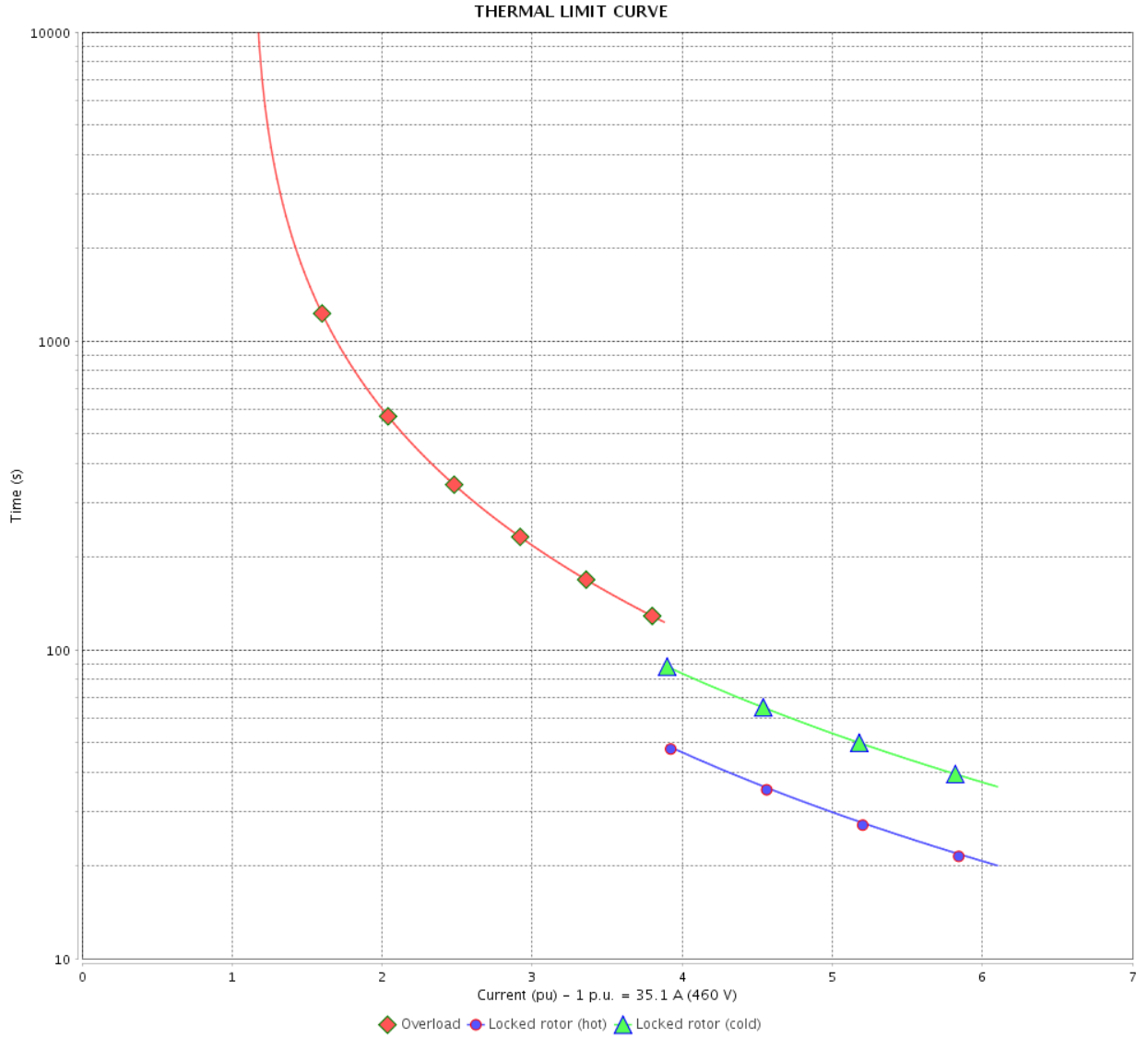

Rev.	Changes Summary	Performed	Checked	Date
Performed by		Page 17 / 36		Revision
Checked by				
Date				

THERMAL LIMIT CURVE



Three Phase Induction Motor - Squirrel Cage

Customer :

Product line : NEMA Premium Efficiency Three-Phase
Product code : 11457167
Catalog # : 03018ET3E286TS-W22

Performance : 380 V 50 Hz 4P IE3

Rated current	: 35.7 A	Moment of inertia (J)	: 5.85 sq.ft.lb
LRC	: 6.0	Duty cycle	: Cont.(S1)
Rated torque	: 89.9 ft.lb	Insulation class	: F
Locked rotor torque	: 200 %	Service factor	: 1.00
Breakdown torque	: 229 %	Temperature rise	: 80 K
Rated speed	: 1460 rpm	Design	: B

Heating constant

Cooling constant

Rev.	Changes Summary	Performed	Checked	Date
Performed by				
Checked by			Page	Revision
Date	14/04/2022		18 / 36	

THERMAL LIMIT CURVE

Three Phase Induction Motor - Squirrel Cage



Customer : _____

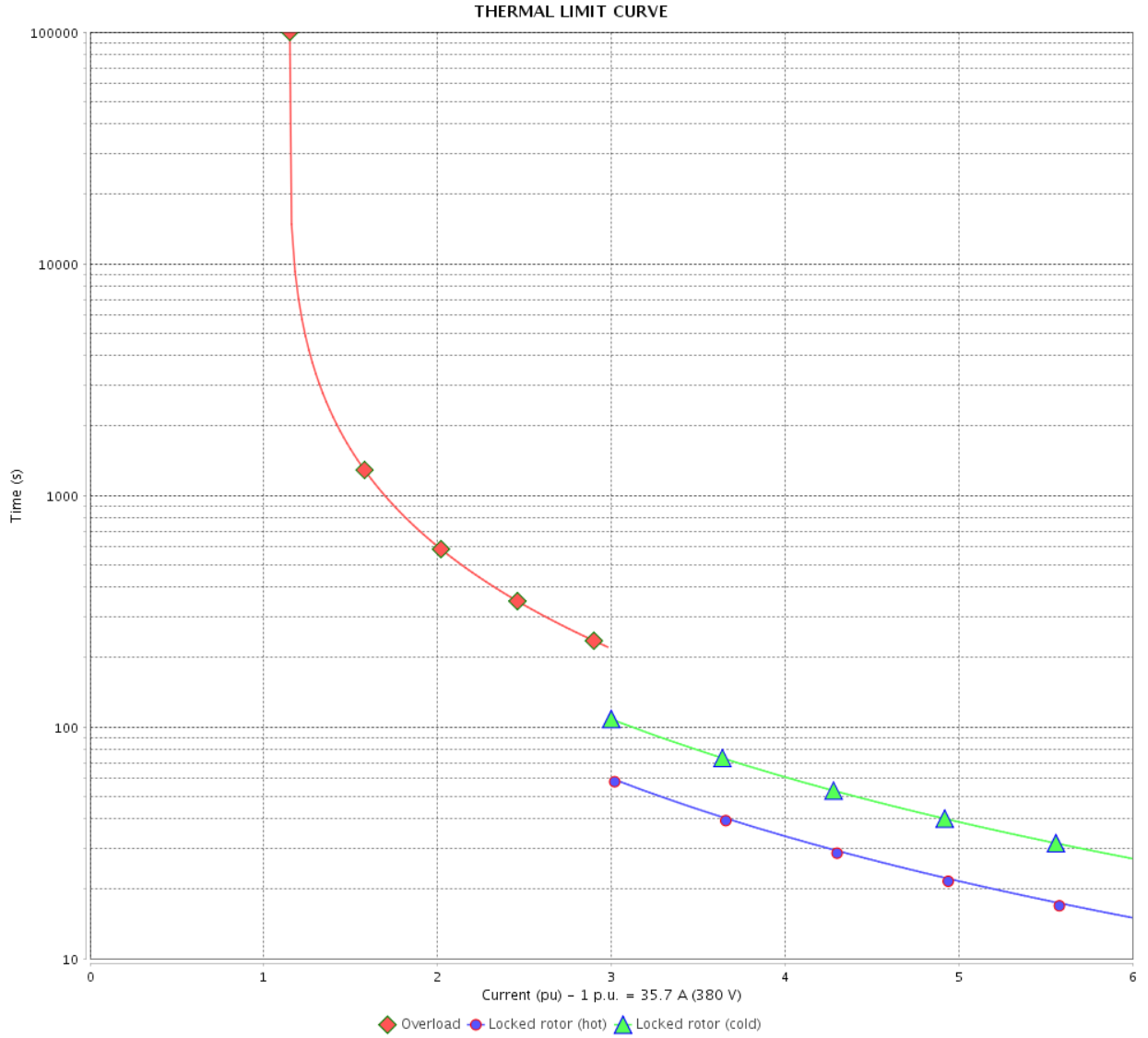

Rev.	Changes Summary	Performed	Checked	Date
Performed by		Page 19 / 36		Revision
Checked by				
Date				

THERMAL LIMIT CURVE



Three Phase Induction Motor - Squirrel Cage

Customer :

Product line : NEMA Premium Efficiency Three-Phase
Product code : 11457167
Catalog # : 03018ET3E286TS-W22

Performance : 400 V 50 Hz 4P IE3

Rated current	: 34.3 A	Moment of inertia (J)	: 5.85 sq.ft.lb
LRC	: 6.7	Duty cycle	: Cont.(S1)
Rated torque	: 89.6 ft.lb	Insulation class	: F
Locked rotor torque	: 229 %	Service factor	: 1.00
Breakdown torque	: 260 %	Temperature rise	: 80 K
Rated speed	: 1465 rpm	Design	: B

Heating constant

Cooling constant

Rev.	Changes Summary	Performed	Checked	Date
Performed by				
Checked by			Page	Revision
Date	14/04/2022		20 / 36	

THERMAL LIMIT CURVE

Three Phase Induction Motor - Squirrel Cage



Customer : _____

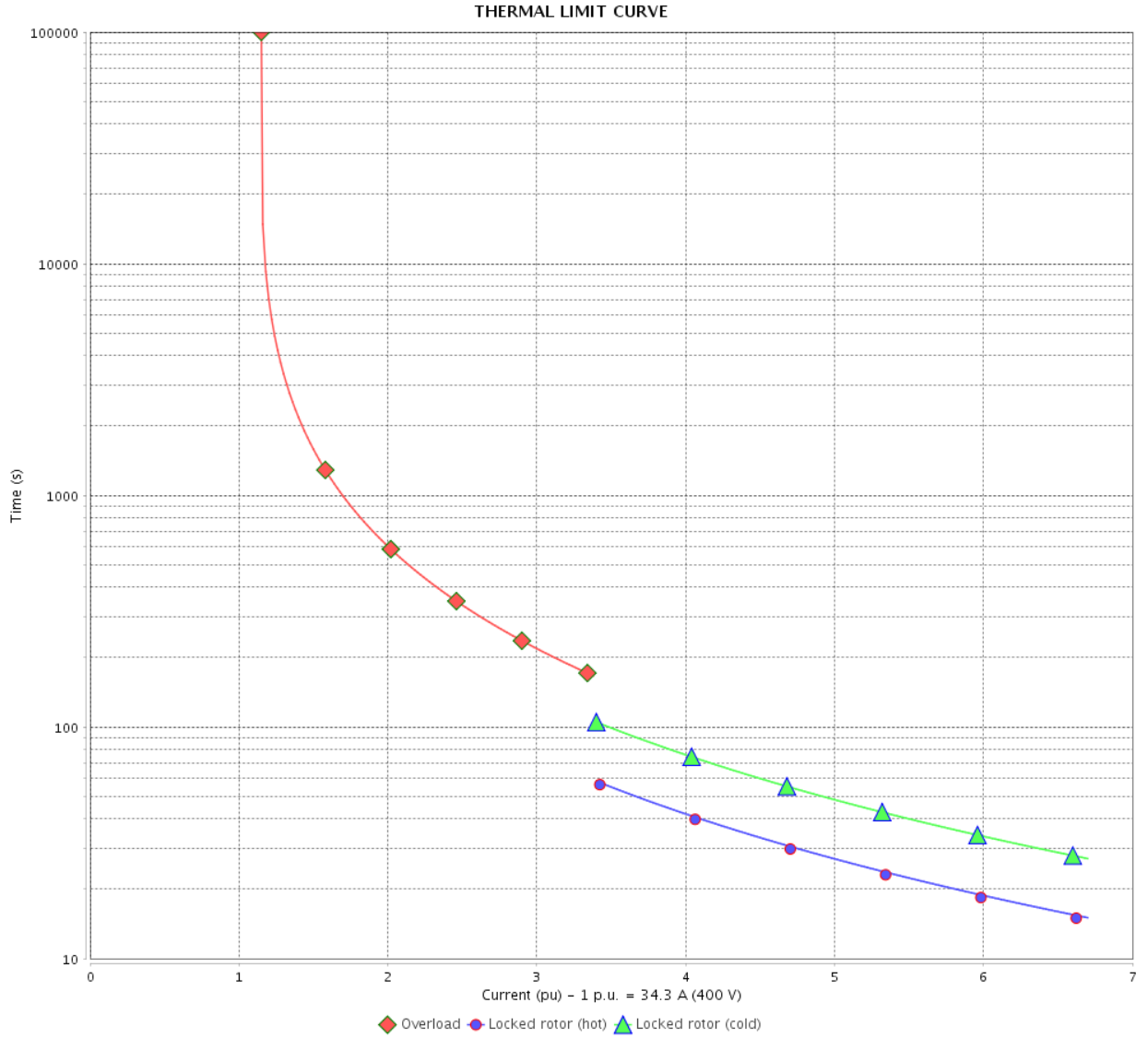

Rev.	Changes Summary	Performed	Checked	Date
Performed by		Page		Revision
Checked by		21 / 36		
Date		14/04/2022		

THERMAL LIMIT CURVE



Three Phase Induction Motor - Squirrel Cage

Customer :

Product line : NEMA Premium Efficiency Three-Phase

Product code : 11457167

Catalog # : 03018ET3E286TS-W22

Performance : 415 V 50 Hz 4P IE3

Rated current	: 33.9 A	Moment of inertia (J)	: 5.85 sq.ft.lb
LRC	: 7.0	Duty cycle	: Cont.(S1)
Rated torque	: 89.3 ft.lb	Insulation class	: F
Locked rotor torque	: 260 %	Service factor	: 1.00
Breakdown torque	: 280 %	Temperature rise	: 80 K
Rated speed	: 1470 rpm	Design	: B

Heating constant

Cooling constant

Rev.	Changes Summary	Performed	Checked	Date
Performed by				
Checked by			Page	Revision
Date	14/04/2022		22 / 36	

THERMAL LIMIT CURVE

Three Phase Induction Motor - Squirrel Cage



Customer : _____

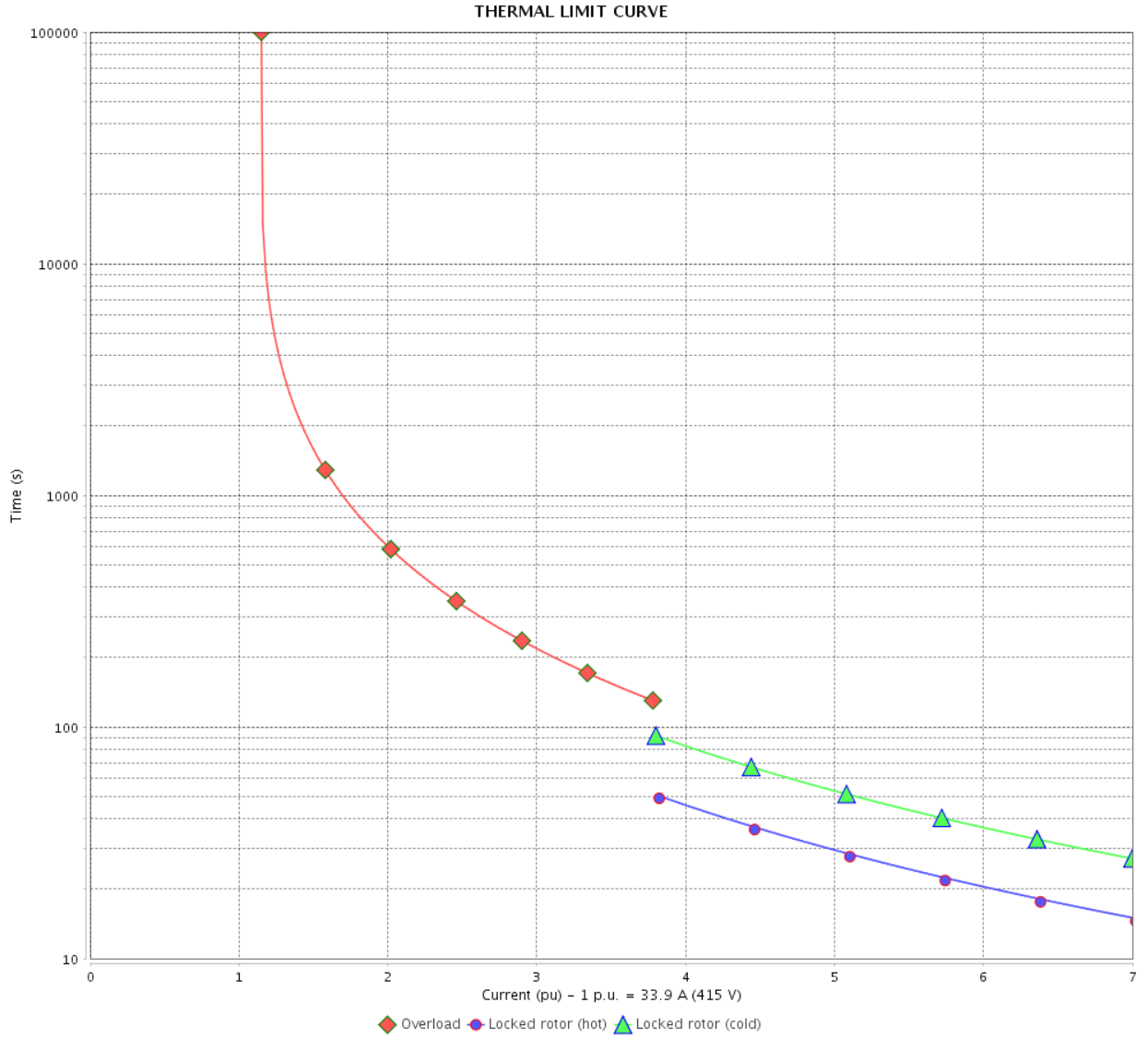

Rev.	Changes Summary	Performed	Checked	Date
Performed by		Page 23 / 36		Revision
Checked by				
Date				

THERMAL LIMIT CURVE

Three Phase Induction Motor - Squirrel Cage



Customer :

Product line : NEMA Premium Efficiency Three-Phase

Product code : 11457167

Catalog # : 03018ET3E286TS-W22

Performance : 380 V 50 Hz 4P IE1

Rated current	: 43.1 A	Moment of inertia (J)	: 5.85 sq.ft.lb
LRC	: 5.0	Duty cycle	: Cont.(S1)
Rated torque	: 109 ft.lb	Insulation class	: F
Locked rotor torque	: 170 %	Service factor	: 1.00
Breakdown torque	: 190 %	Temperature rise	: 105 K
Rated speed	: 1445 rpm	Design	: B

Heating constant

Cooling constant

Rev.	Changes Summary	Performed	Checked	Date
Performed by				
Checked by			Page	Revision
Date	14/04/2022		24 / 36	

THERMAL LIMIT CURVE

Three Phase Induction Motor - Squirrel Cage



Customer : _____

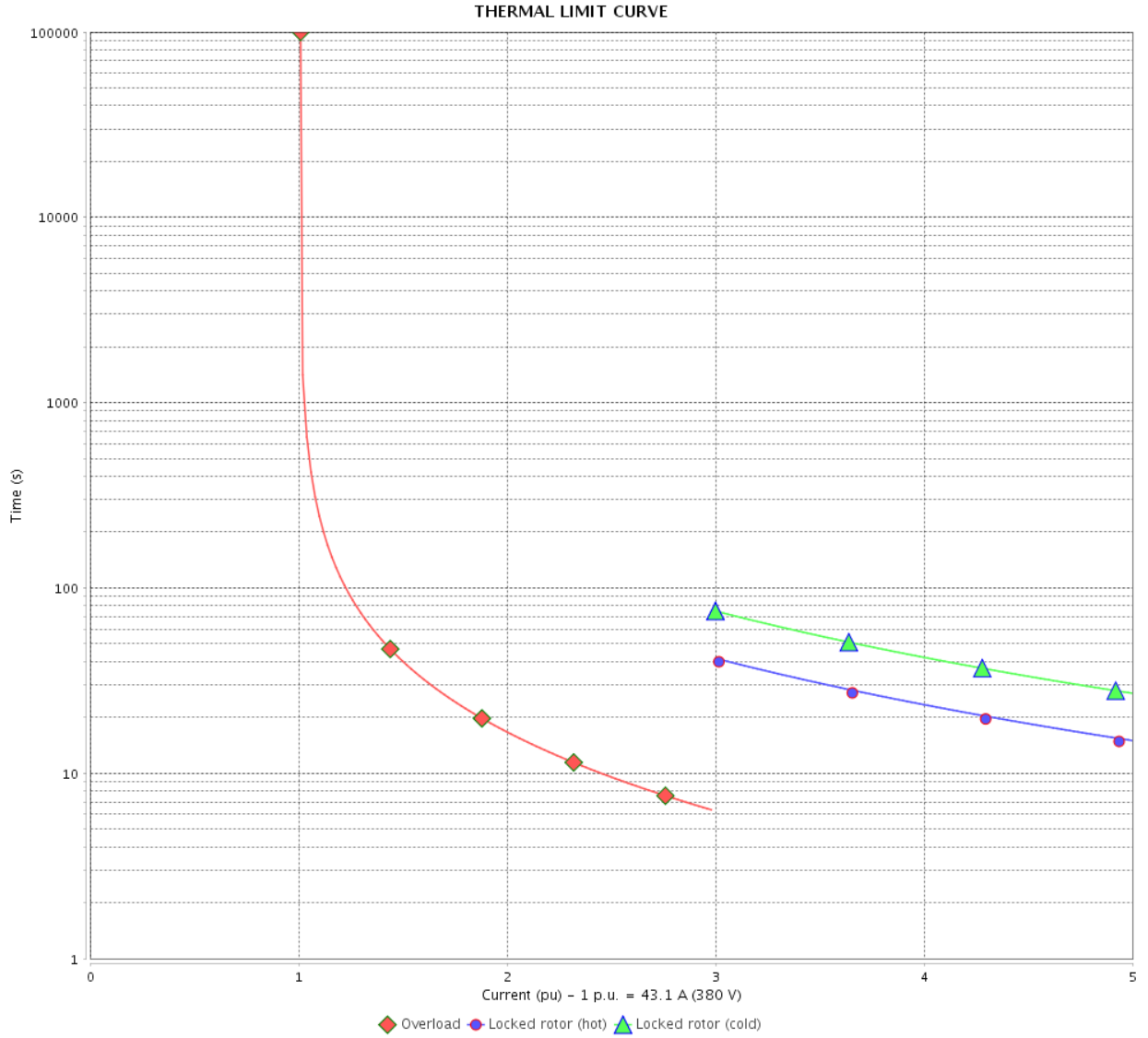

Rev.	Changes Summary	Performed	Checked	Date
Performed by				
Checked by				
Date				
			Page	Revision
			25 / 36	

THERMAL LIMIT CURVE

Three Phase Induction Motor - Squirrel Cage



Customer :

Product line : NEMA Premium Efficiency Three-Phase
Product code : 11457167
Catalog # : 03018ET3E286TS-W22

Performance : 400 V 50 Hz 4P IE1

Rated current	: 41.1 A	Moment of inertia (J)	: 5.85 sq.ft.lb
LRC	: 5.6	Duty cycle	: Cont.(S1)
Rated torque	: 108 ft.lb	Insulation class	: F
Locked rotor torque	: 190 %	Service factor	: 1.00
Breakdown torque	: 220 %	Temperature rise	: 105 K
Rated speed	: 1455 rpm	Design	: B

Heating constant

Cooling constant

Rev.	Changes Summary	Performed	Checked	Date
Performed by				
Checked by			Page	Revision
Date	14/04/2022		26 / 36	

THERMAL LIMIT CURVE

Three Phase Induction Motor - Squirrel Cage



Customer : _____

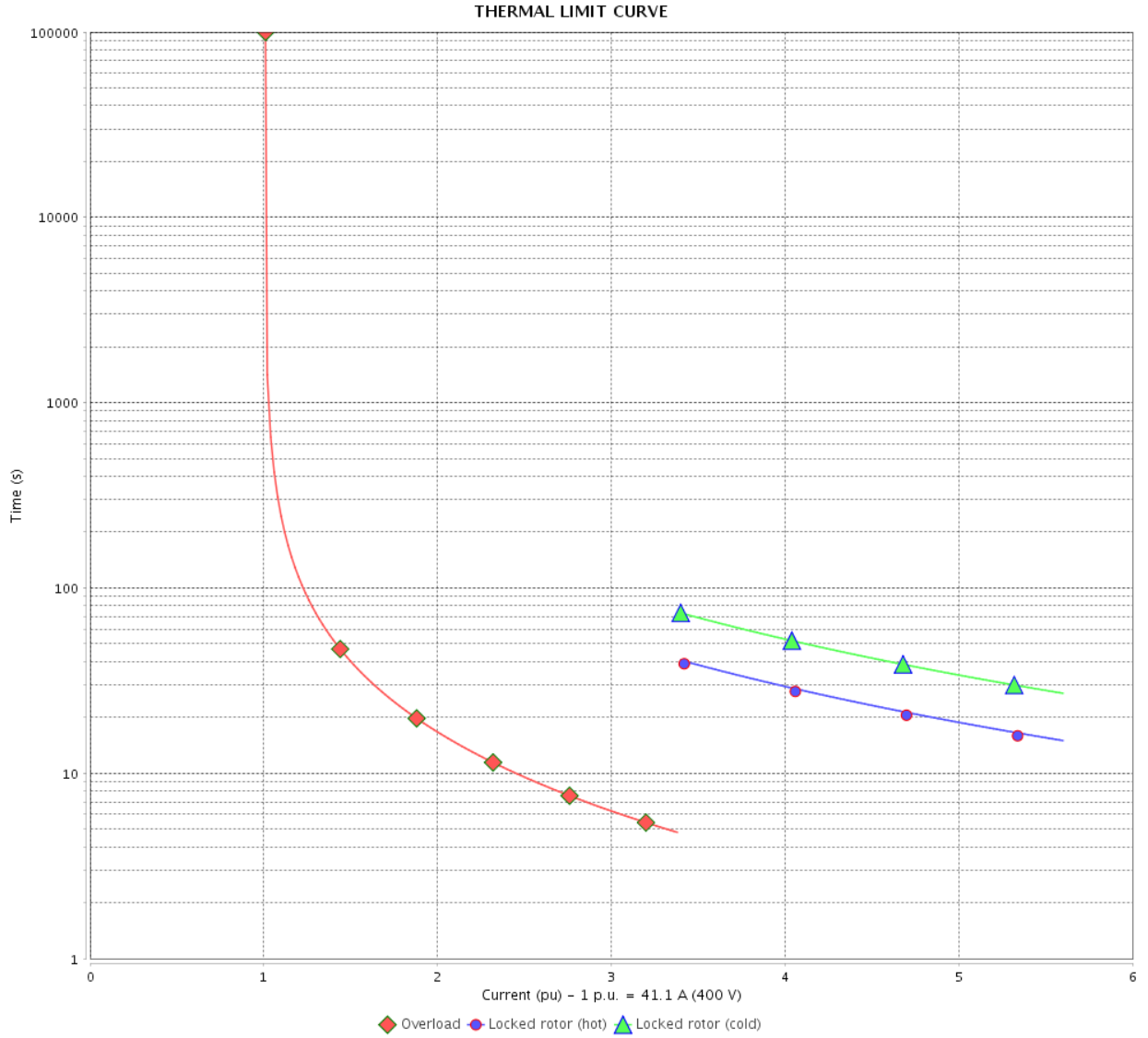

Rev.	Changes Summary	Performed	Checked	Date
Performed by				
Checked by				
Date				
			Page	Revision
			27 / 36	

THERMAL LIMIT CURVE



Three Phase Induction Motor - Squirrel Cage

Customer :

Product line : NEMA Premium Efficiency Three-Phase
 Product code : 11457167
 Catalog # : 03018ET3E286TS-W22

Performance : 415 V 50 Hz 4P IE2

Rated current : 39.7 A	Moment of inertia (J) : 5.85 sq.ft.lb
LRC : 6.0	Duty cycle : Cont.(S1)
Rated torque : 108 ft.lb	Insulation class : F
Locked rotor torque : 220 %	Service factor : 1.00
Breakdown torque : 240 %	Temperature rise : 105 K
Rated speed : 1460 rpm	Design : B

Heating constant

Cooling constant

Rev.	Changes Summary	Performed	Checked	Date
Performed by			Page 28 / 36	Revision
Checked by				
Date	14/04/2022			

THERMAL LIMIT CURVE

Three Phase Induction Motor - Squirrel Cage



Customer : _____

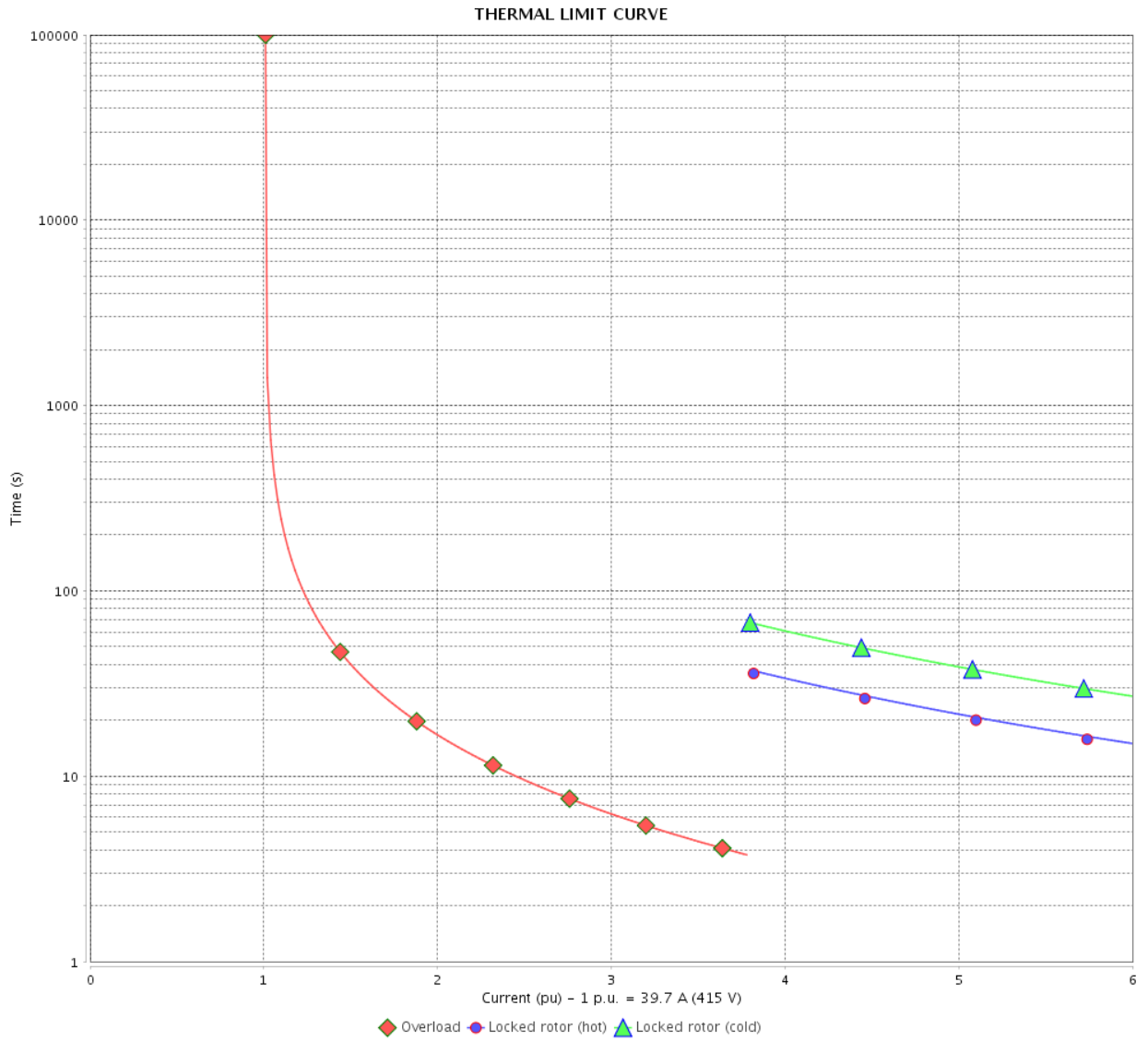

Rev.	Changes Summary	Performed	Checked	Date
Performed by				
Checked by				
Date				
			Page	Revision
			29 / 36	

VFD OPERATION CURVE

Three Phase Induction Motor - Squirrel Cage



Customer :

Product line : NEMA Premium Efficiency Three-Phase

Product code : 11457167

Catalog # : 03018ET3E286TS-W22

VFD OPERATION CURVE

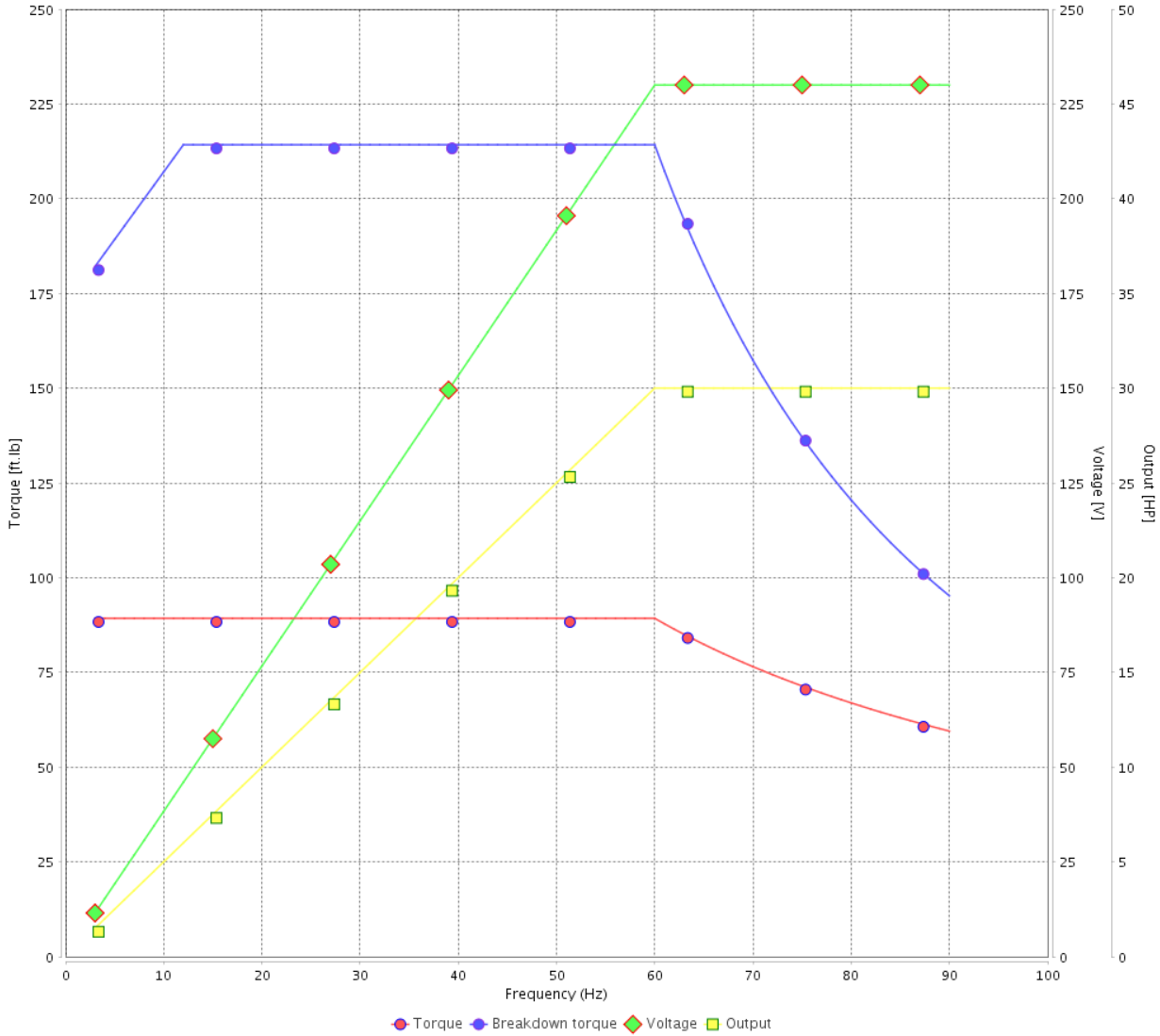

Performance : 230/460 V 60 Hz 4P

Rated current : 70.2/35.1 A
 LRC : 6.1
 Rated torque : 89.3 ft.lb
 Locked rotor torque : 240 %
 Breakdown torque : 240 %
 Rated speed : 1765 rpm

Moment of inertia (J) : 5.85 sq.ft.lb
 Duty cycle : Cont.(S1)
 Insulation class : F
 Service factor : 1.25
 Temperature rise : 80 K
 Design : B

Rev.	Changes Summary	Performed	Checked	Date
Performed by			Page 30 / 36	Revision
Checked by				
Date	14/04/2022			

VFD OPERATION CURVE

Three Phase Induction Motor - Squirrel Cage



Customer : _____

Product line : NEMA Premium Efficiency Three-Phase

Product code : 11457167

Catalog # : 03018ET3E286TS-W22

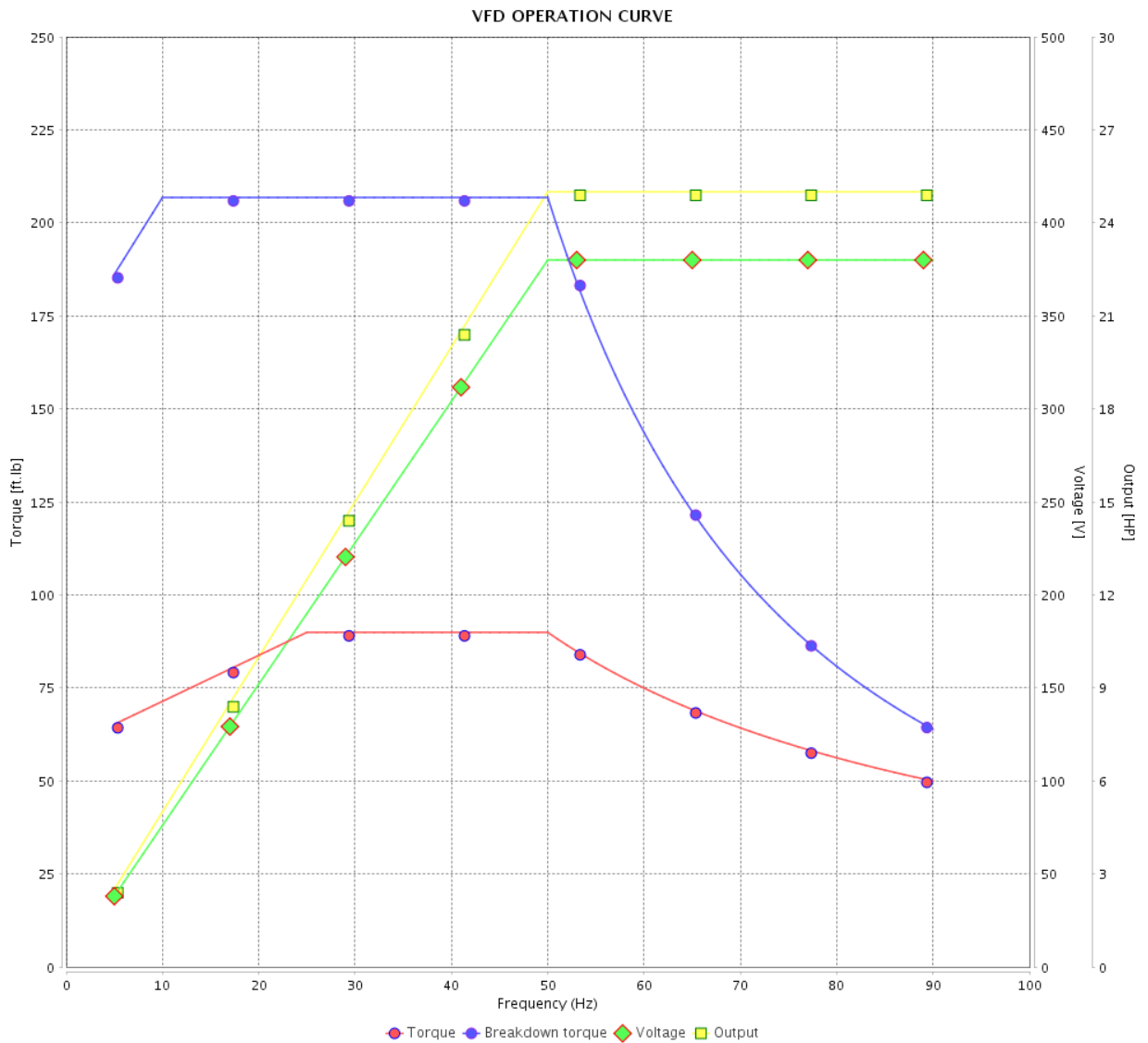

Performance : 380 V 50 Hz 4P IE3

Rated current : 35.7 A
 LRC : 6.0
 Rated torque : 89.9 ft.lb
 Locked rotor torque : 200 %
 Breakdown torque : 229 %
 Rated speed : 1460 rpm

Moment of inertia (J) : 5.85 sq.ft.lb
 Duty cycle : Cont.(S1)
 Insulation class : F
 Service factor : 1.00
 Temperature rise : 80 K
 Design : B

Rev.	Changes Summary	Performed	Checked	Date
Performed by			Page	Revision
Checked by			31 / 36	
Date	14/04/2022			

VFD OPERATION CURVE

Three Phase Induction Motor - Squirrel Cage



Customer :

Product line : NEMA Premium Efficiency Three-Phase

Product code : 11457167

Catalog # : 03018ET3E286TS-W22

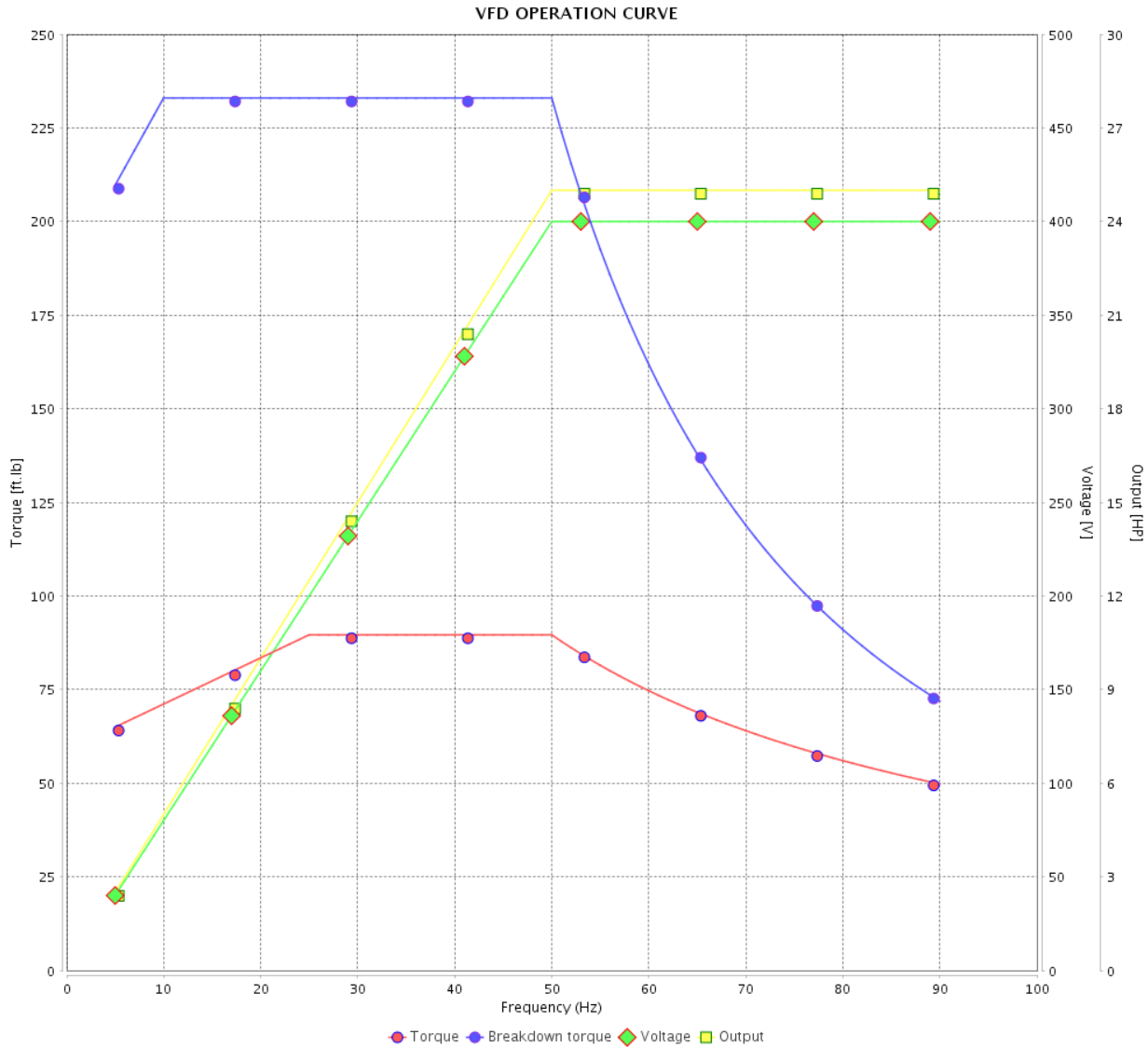

Performance : 400 V 50 Hz 4P IE3

Rated current : 34.3 A
 LRC : 6.7
 Rated torque : 89.6 ft.lb
 Locked rotor torque : 229 %
 Breakdown torque : 260 %
 Rated speed : 1465 rpm

Moment of inertia (J) : 5.85 sq.ft.lb
 Duty cycle : Cont.(S1)
 Insulation class : F
 Service factor : 1.00
 Temperature rise : 80 K
 Design : B

Rev.	Changes Summary	Performed	Checked	Date
Performed by			Page 32 / 36	Revision
Checked by				
Date	14/04/2022			

VFD OPERATION CURVE

Three Phase Induction Motor - Squirrel Cage



Customer :

Product line : NEMA Premium Efficiency Three-Phase

Product code : 11457167

Catalog # : 03018ET3E286TS-W22

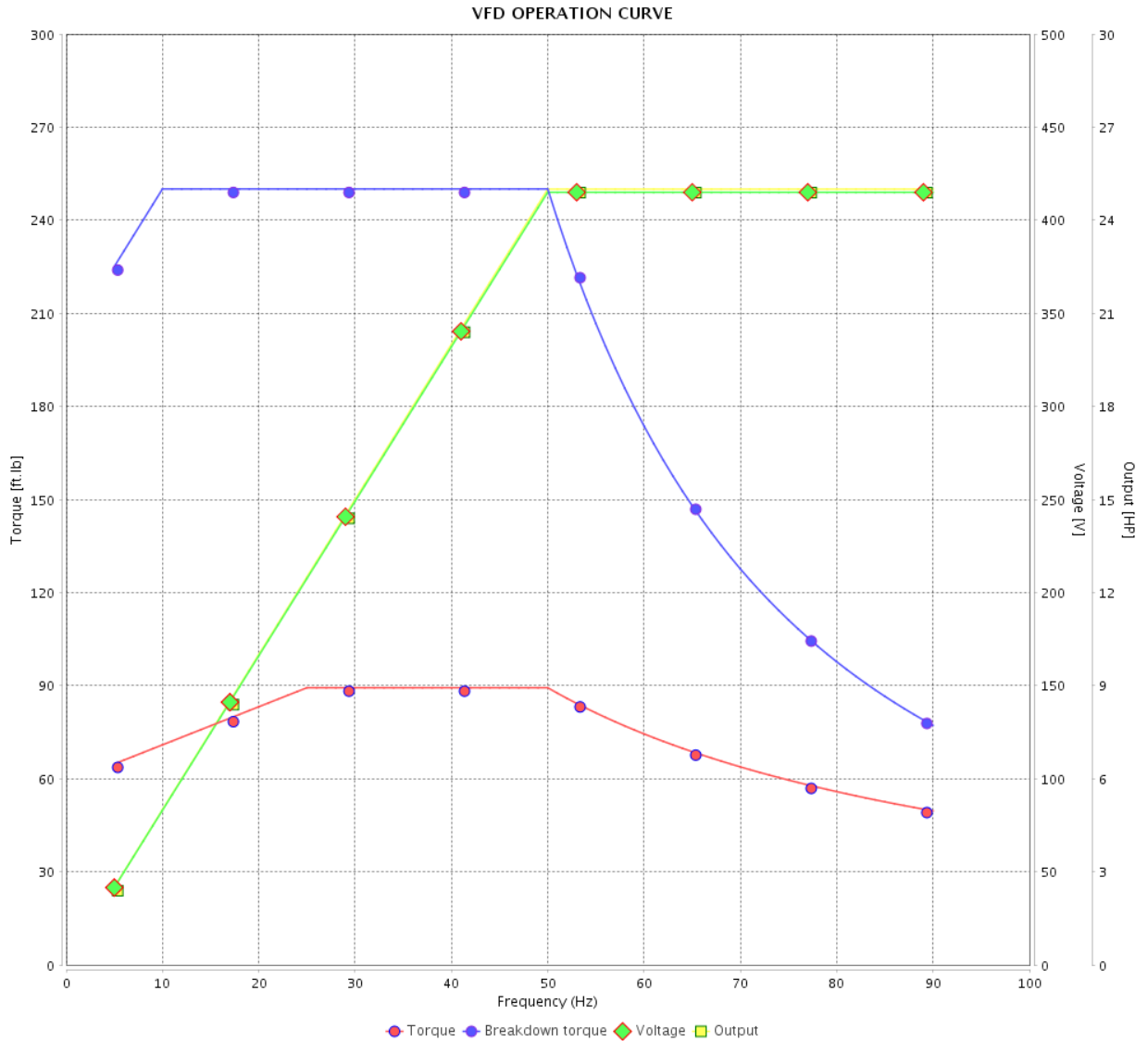

Performance : 415 V 50 Hz 4P IE3

Rated current : 33.9 A
 LRC : 7.0
 Rated torque : 89.3 ft.lb
 Locked rotor torque : 260 %
 Breakdown torque : 280 %
 Rated speed : 1470 rpm

Moment of inertia (J) : 5.85 sq.ft.lb
 Duty cycle : Cont.(S1)
 Insulation class : F
 Service factor : 1.00
 Temperature rise : 80 K
 Design : B

Rev.	Changes Summary	Performed	Checked	Date
Performed by			Page 33 / 36	Revision
Checked by				
Date	14/04/2022			

VFD OPERATION CURVE

Three Phase Induction Motor - Squirrel Cage



Customer :

Product line : NEMA Premium Efficiency Three-Phase

Product code : 11457167

Catalog # : 03018ET3E286TS-W22

VFD OPERATION CURVE

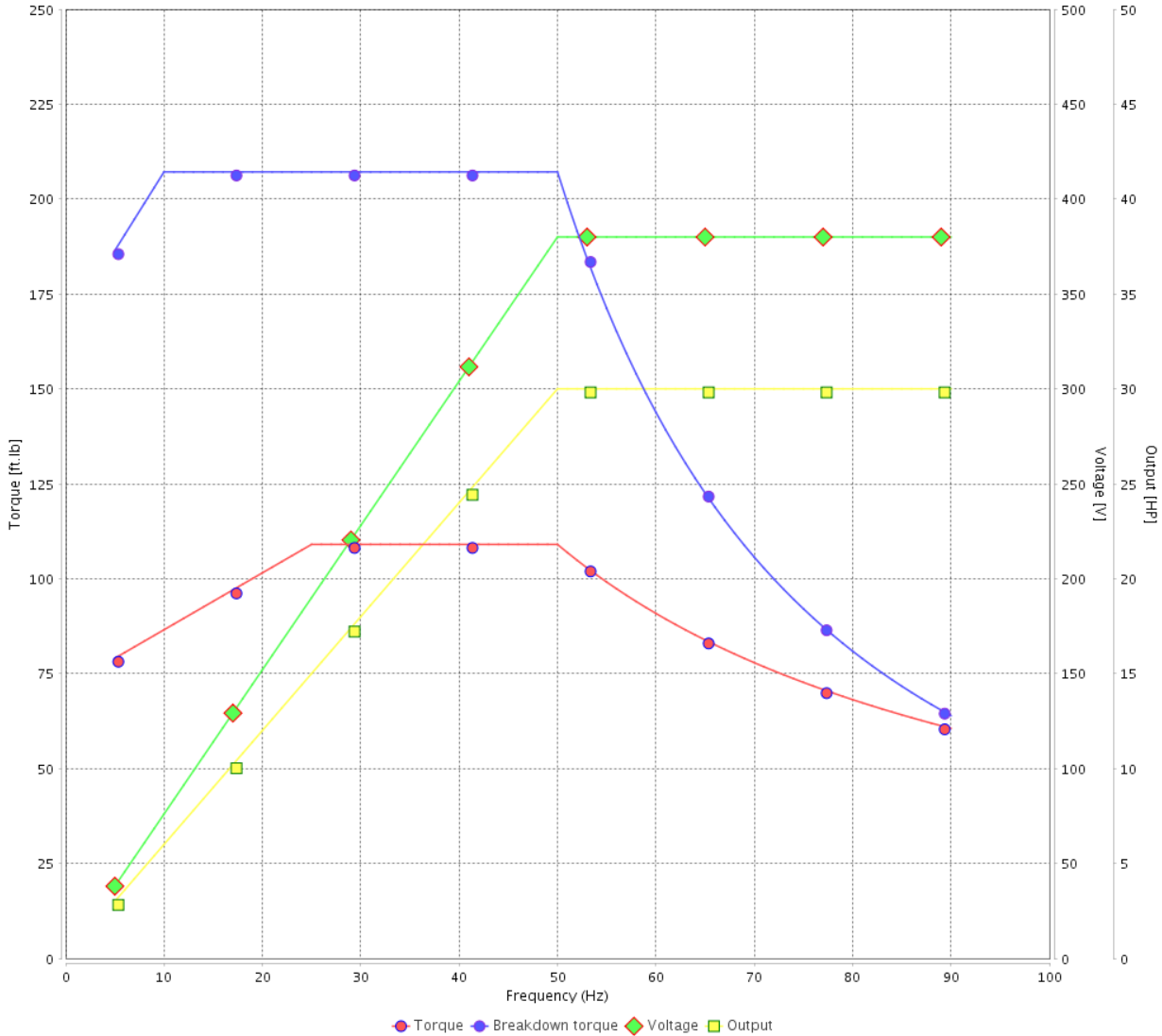

Performance : 380 V 50 Hz 4P IE1

Rated current	: 43.1 A	Moment of inertia (J)	: 5.85 sq.ft.lb
LRC	: 5.0	Duty cycle	: Cont.(S1)
Rated torque	: 109 ft.lb	Insulation class	: F
Locked rotor torque	: 170 %	Service factor	: 1.00
Breakdown torque	: 190 %	Temperature rise	: 105 K
Rated speed	: 1445 rpm	Design	: B

Rev.	Changes Summary	Performed	Checked	Date
Performed by			Page 34 / 36	Revision
Checked by				
Date	14/04/2022			

VFD OPERATION CURVE

Three Phase Induction Motor - Squirrel Cage



Customer :

Product line : NEMA Premium Efficiency Three-Phase

Product code : 11457167

Catalog # : 03018ET3E286TS-W22

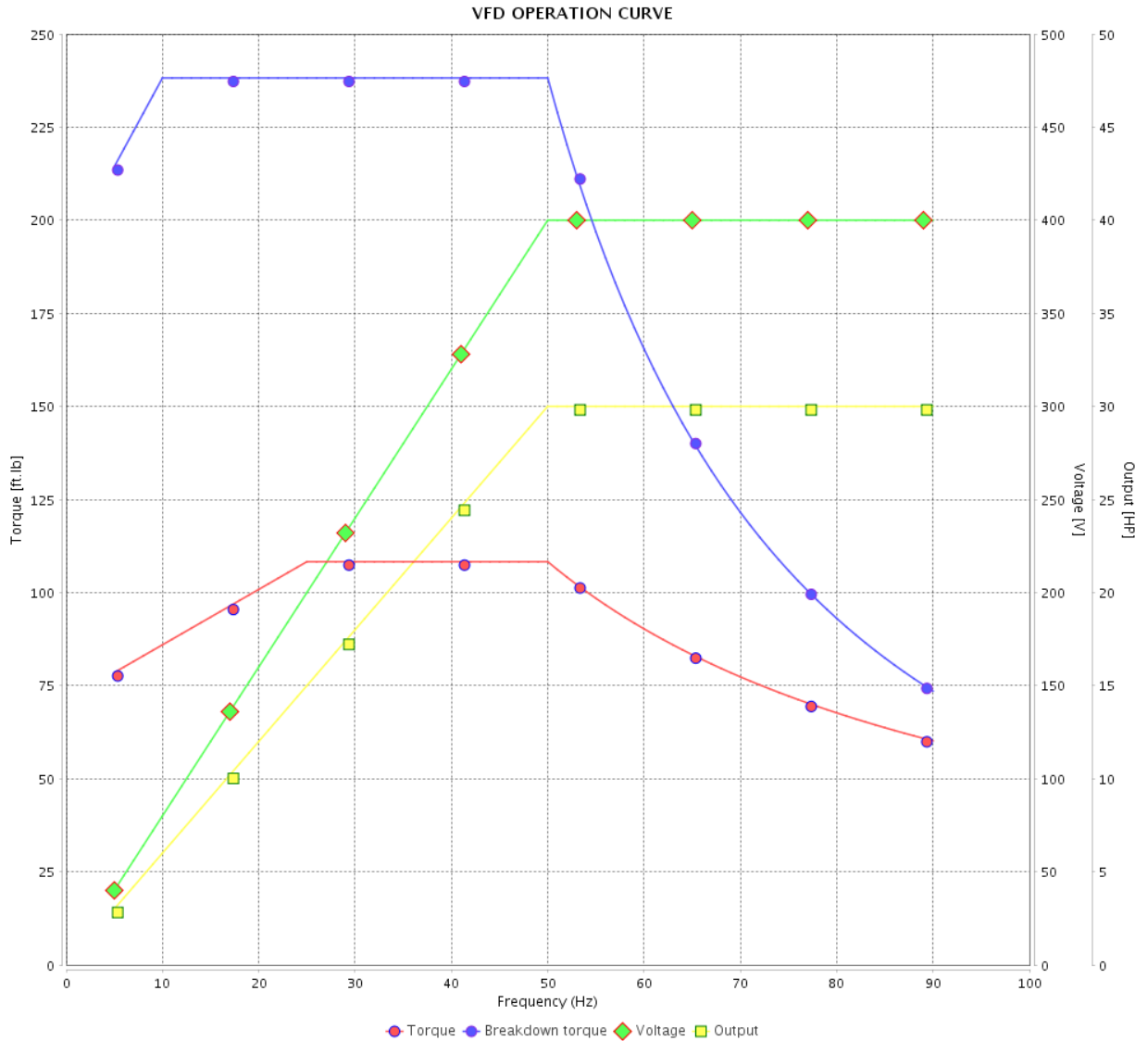

Performance : 400 V 50 Hz 4P IE1

Rated current : 41.1 A
 LRC : 5.6
 Rated torque : 108 ft.lb
 Locked rotor torque : 190 %
 Breakdown torque : 220 %
 Rated speed : 1455 rpm

Moment of inertia (J) : 5.85 sq.ft.lb
 Duty cycle : Cont.(S1)
 Insulation class : F
 Service factor : 1.00
 Temperature rise : 105 K
 Design : B

Rev.	Changes Summary	Performed	Checked	Date
Performed by			Page 35 / 36	Revision
Checked by				
Date	14/04/2022			

VFD OPERATION CURVE

Three Phase Induction Motor - Squirrel Cage



Customer :

Product line : NEMA Premium Efficiency Three-Phase

Product code : 11457167

Catalog # : 03018ET3E286TS-W22

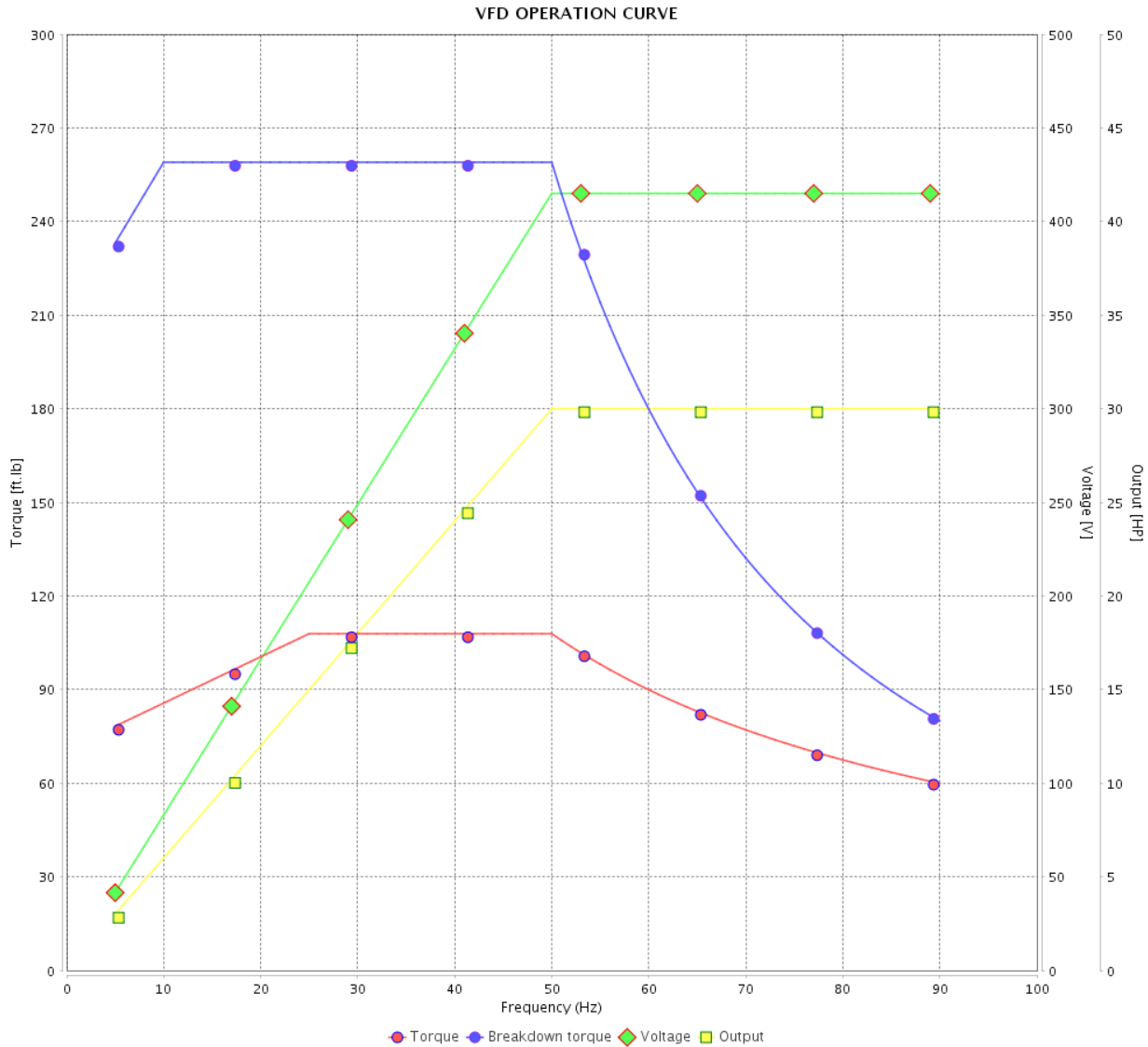

Performance : 415 V 50 Hz 4P IE2

Rated current	: 39.7 A	Moment of inertia (J)	: 5.85 sq.ft.lb
LRC	: 6.0	Duty cycle	: Cont.(S1)
Rated torque	: 108 ft.lb	Insulation class	: F
Locked rotor torque	: 220 %	Service factor	: 1.00
Breakdown torque	: 240 %	Temperature rise	: 105 K
Rated speed	: 1460 rpm	Design	: B

Rev.	Changes Summary	Performed	Checked	Date
Performed by			Page 36 / 36	Revision
Checked by				
Date	14/04/2022			

1 2 3 4 5 6

A

B

C

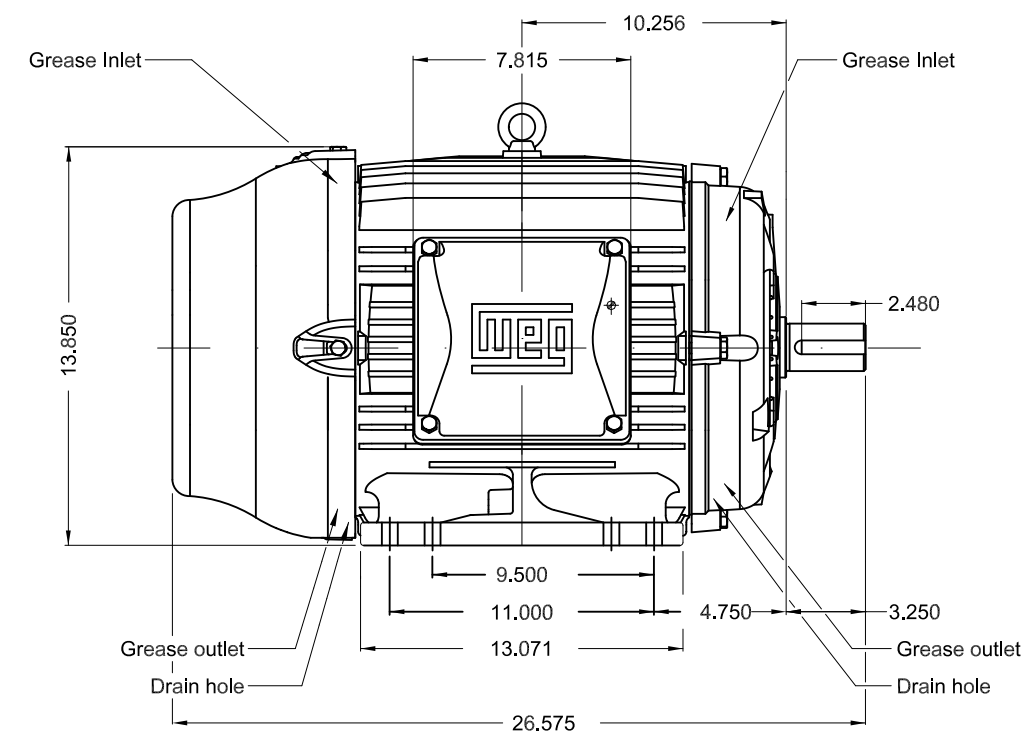
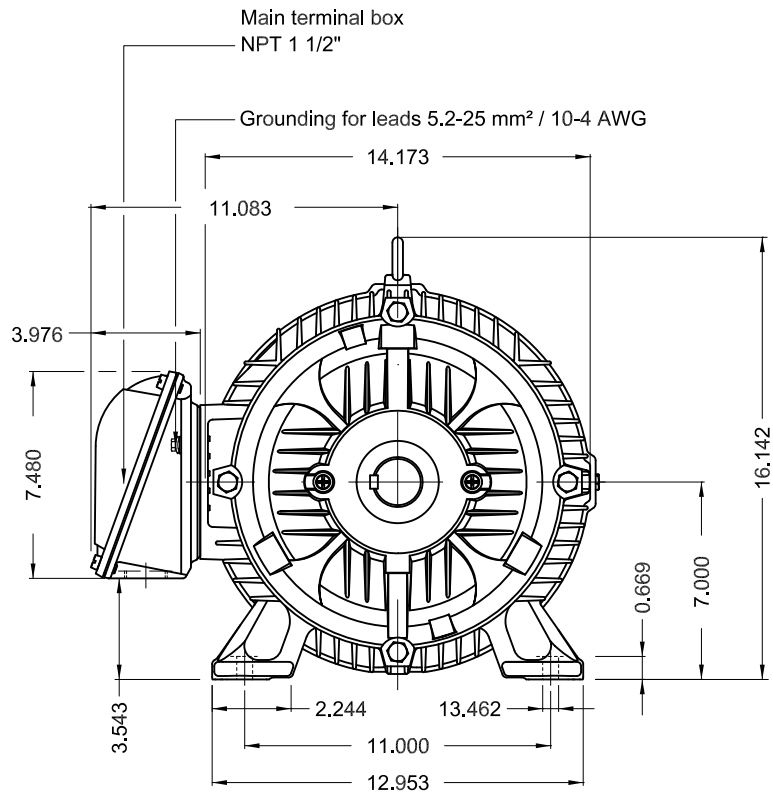

D

E

TS shaft end
 Color RAL 5009
 Painting plan 203A
 Mounting B3R(D)

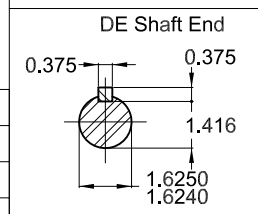

30 HP 04 Poles 60 Hz A

ECM	LOC	SUMMARY OF MODIFICATIONS	EXECUTED	CHECKED	RELEASED	DATE	VER
EXECUTED	PIRWBUSER	THREE PH. MOTOR W22 PREM. EFF. FRAME 284/6TS IP55 TEFC					
CHECKED							
RELEASED							
REL DT.	WMO	Jaragua do Sul	Product Engineering	SHEET	1 / 1		

PREVIEW
 WDD



Dimensions in inches XME A3



FOR SAFE AREA
Mod.TE1BFOXON
CC029A



For use on 60Hz
Class I, Div 2, Gr A, B, C and D - T3
Class I, Zone 2, IIC - T3
Class II, Div 2, Gr F and G - T4
For use on PWM: Gr. A, B, C, D and F,
VT 1000:1, CT 20:1, 1.00SF - T3A

MODEL 03018ET3E286TS-W22

Inverter Duty Motor
Severe Duty

PH3 60Hz Fr. 284/6TS 1000m.a.s.l. IP55 TEFC 466lb

V 230/460

A 70.2/35.1

HP 30

kW 22

SF 1.25

SFA 87.8/43.9

RPM 1765

PF 0.84

AMB 40°C

INS cl. F DT80K

NEMA NOM EFF 93.6%

DUTY CONT.

DES B Code G

USABLE @208V 77.6A SF 1.15 SFA 89.2

30HP 22kW 50Hz 380V 43.1A 1445RPM SF 1.00 EFF 90.2% (IE1)

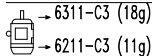
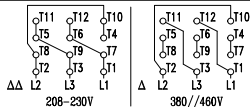

MOBIL POLYREX EM (20000h)

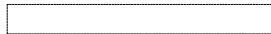

MADE IN MEXICO
11457167