

DATA SHEET

Three Phase Induction Motor - Squirrel Cage



Customer :					
Product line	: W40 NEMA Premium Efficiency Three-Phase	Product code :	14495708		
		Catalog # :	03018OT3E286TC-W40		
Frame	: 284/6TC	Cooling method	: IC01 - ODP		
Insulation class	: F	Mounting	: F-1		
Duty cycle	: Cont.(S1)	Rotation ¹	: Both (CW and CCW)		
Ambient temperature	: -20°C to +40°C	Starting method	: Direct On Line		
Altitude	: 1000 m.a.s.l.	Approx. weight ²	: 405 lb		
Protection degree	: IP23	Moment of inertia (J)	: 4.52 sq.ft.lb		
Design	: B				
Output [HP]	30	25	25	25	
Poles	4	4	4	4	
Frequency [Hz]	60	50	50	50	
Rated voltage [V]	230/460	380	400	415	
Rated current [A]	69.8/34.9	35.7	34.7	34.3	
L. R. Amperes [A]	461/230	246	250	244	
LRC [A]	6.6x(Code G)	6.9x(Code H)	7.2x(Code H)	7.1x(Code H)	
No load current [A]	27.0/13.5	13.0	14.0	14.5	
Rated speed [RPM]	1765	1465	1470	1470	
Slip [%]	1.94	2.33	2.00	2.00	
Rated torque [ft.lb]	89.0	89.3	89.3	89.0	
Locked rotor torque [%]	280	229	260	280	
Breakdown torque [%]	270	240	270	300	
Service factor	1.25	1.00	1.00	1.00	
Temperature rise	80 K	80 K	80 K	80 K	
Locked rotor time	32s (cold) 18s (hot)	28s (cold) 16s (hot)	30s (cold) 17s (hot)	30s (cold) 17s (hot)	
Noise level ²	64.0 dB(A)				
Efficiency (%)	25%	93.4	92.0	92.0	92.0
	50%	93.6	92.2	92.2	92.2
	75%	94.1	92.6	92.6	92.6
	100%	94.1	92.6	92.6	92.6
Power Factor	25%	0.45	0.46	0.42	0.39
	50%	0.70	0.70	0.66	0.63
	75%	0.80	0.80	0.78	0.75
	100%	0.84	0.85	0.83	0.81
Bearing type	: Drive end : 6311 Z C3	Non drive end : 6211 Z C3	Foundation loads		
Sealing	: Without	Without	Max. traction		
	Bearing Seal	Bearing Seal	Max. compression		
Lubrication interval	: 20000 h	20000 h			
Lubricant amount	: 18 g	11 g			
Lubricant type	: Mobil Polyrex EM				
Notes					
USABLE @208V 77.2A SF 1.15 SFA 88.8A					
This revision replaces and cancel the previous one, which must be eliminated. (1) Looking the motor from the shaft end. (2) Measured at 1m and with tolerance of +3dB(A). (3) Approximate weight subject to changes after manufacturing process. (4) At 100% of full load.			These are average values based on tests with sinusoidal power supply, subject to the tolerances stipulated in NEMA MG-1.		
Rev.	Changes Summary		Performed	Checked	Date
Performed by					
Checked by				Page	Revision
Date	14/04/2022			1 / 21	

TORQUE AND CURRENT VS SPEED CURVE

Three Phase Induction Motor - Squirrel Cage



Customer :

Product line : W40 NEMA Premium Efficiency
Three-Phase

Product code : 14495708

Catalog # : 03018OT3E286TC-W40

TORQUE AND CURRENT VS SPEED CURVE

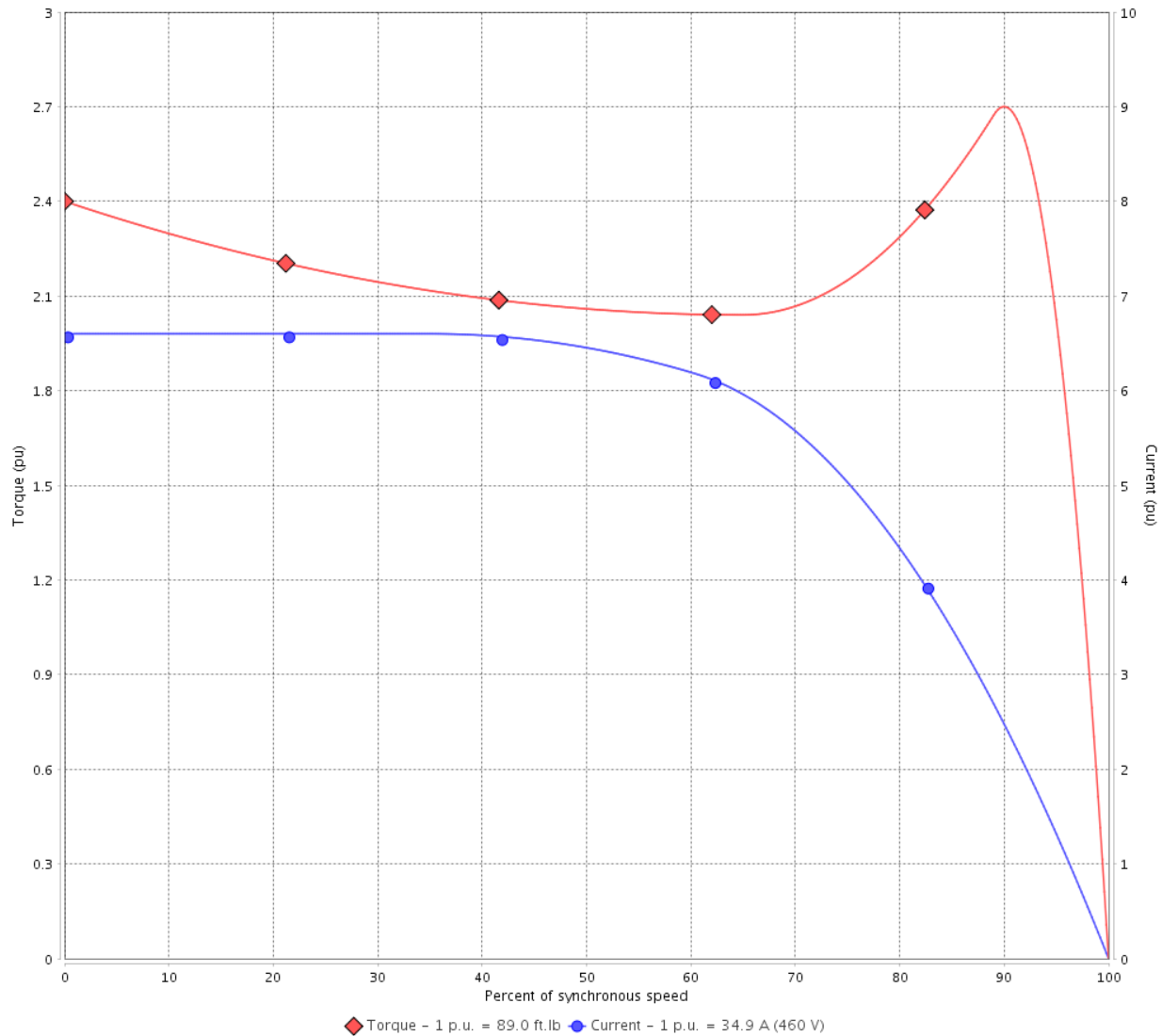

Performance : 230/460 V 60 Hz 4P

Rated current	: 69.8/34.9 A	Moment of inertia (J)	: 4.52 sq.ft.lb
LRC	: 6.6	Duty cycle	: Cont.(S1)
Rated torque	: 89.0 ft.lb	Insulation class	: F
Locked rotor torque	: 280 %	Service factor	: 1.25
Breakdown torque	: 270 %	Temperature rise	: 80 K
Rated speed	: 1765 rpm	Design	: B

Locked rotor time : 32s (cold) 18s (hot)

Rev.	Changes Summary	Performed	Checked	Date
Performed by			Page 2 / 21	Revision
Checked by				
Date	14/04/2022			

TORQUE AND CURRENT VS SPEED CURVE



Three Phase Induction Motor - Squirrel Cage

Customer :

Product line : W40 NEMA Premium Efficiency Three-Phase

Product code : 14495708

Catalog # : 03018OT3E286TC-W40

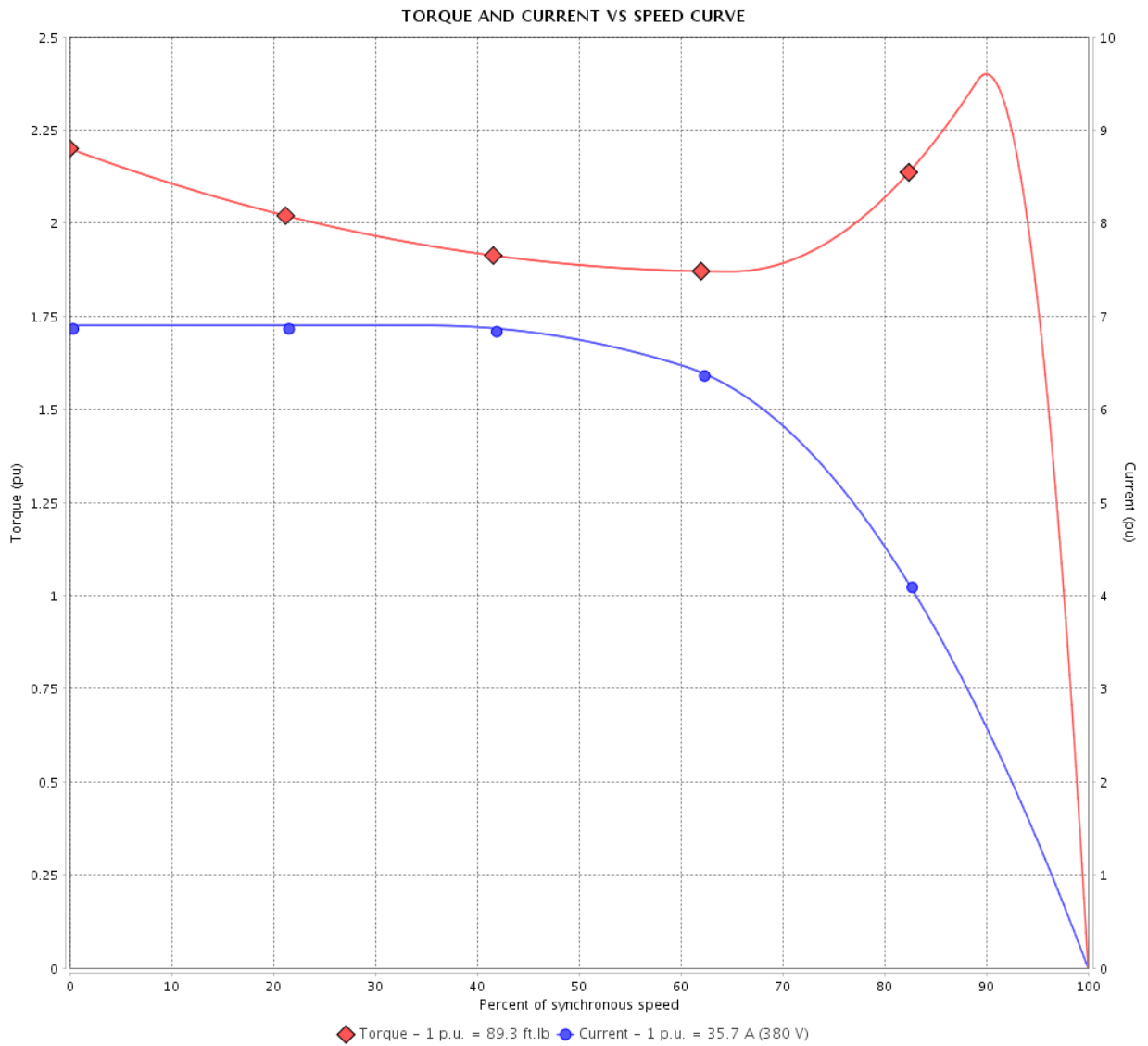

Performance : 380 V 50 Hz 4P IE3

Rated current : 35.7 A
 LRC : 6.9
 Rated torque : 89.3 ft.lb
 Locked rotor torque : 229 %
 Breakdown torque : 240 %
 Rated speed : 1465 rpm

Moment of inertia (J) : 4.52 sq.ft.lb
 Duty cycle : Cont.(S1)
 Insulation class : F
 Service factor : 1.00
 Temperature rise : 80 K
 Design : B

Locked rotor time : 28s (cold) 16s (hot)

Rev.	Changes Summary	Performed	Checked	Date
Performed by			Page 3 / 21	Revision
Checked by				
Date	14/04/2022			

TORQUE AND CURRENT VS SPEED CURVE

Three Phase Induction Motor - Squirrel Cage



Customer :

Product line : W40 NEMA Premium Efficiency
Three-Phase

Product code : 14495708

Catalog # : 03018OT3E286TC-W40

TORQUE AND CURRENT VS SPEED CURVE

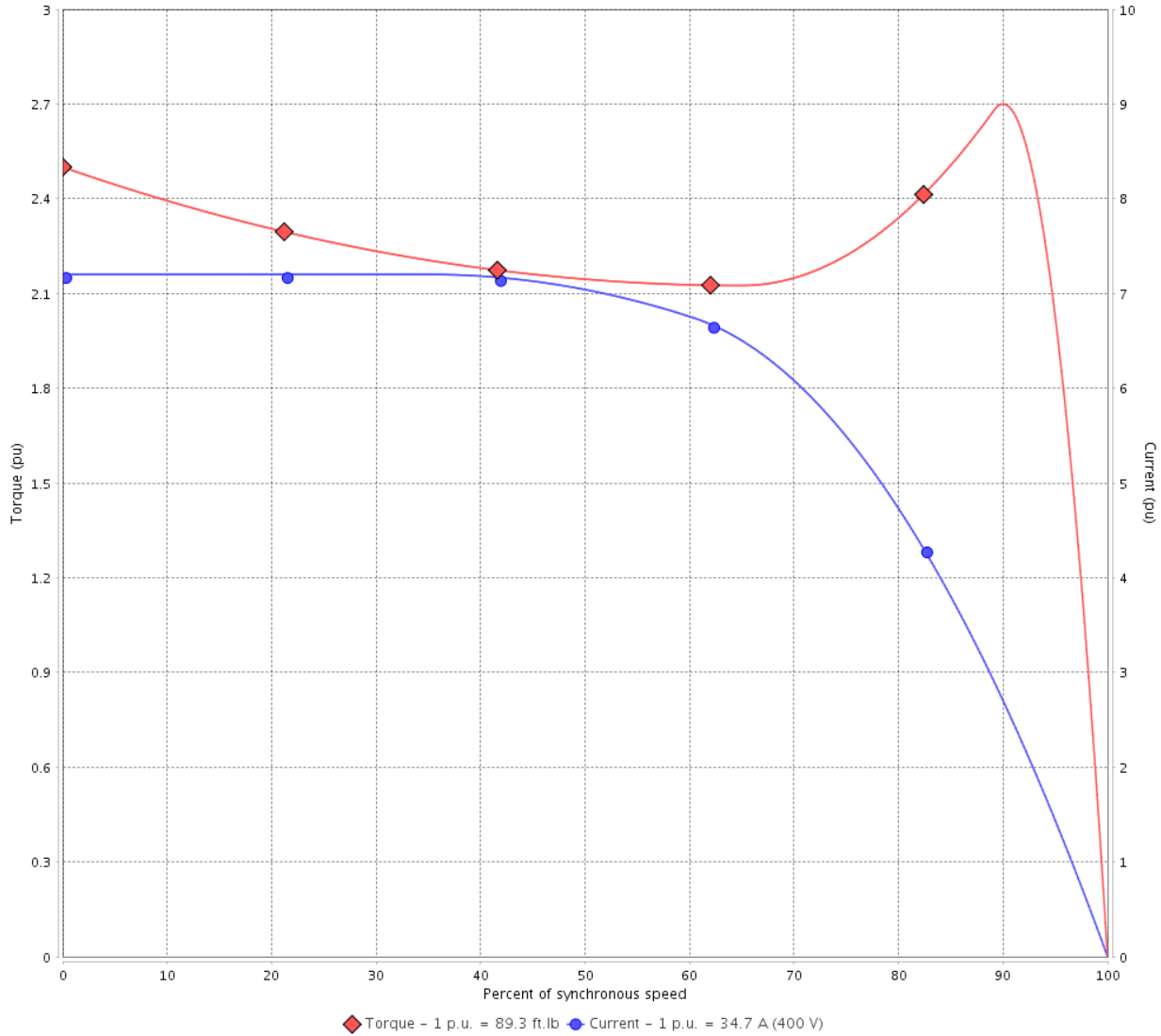

Performance : 400 V 50 Hz 4P IE3

Rated current	: 34.7 A	Moment of inertia (J)	: 4.52 sq.ft.lb
LRC	: 7.2	Duty cycle	: Cont.(S1)
Rated torque	: 89.3 ft.lb	Insulation class	: F
Locked rotor torque	: 260 %	Service factor	: 1.00
Breakdown torque	: 270 %	Temperature rise	: 80 K
Rated speed	: 1470 rpm	Design	: B

Locked rotor time : 30s (cold) 17s (hot)

Rev.	Changes Summary	Performed	Checked	Date
Performed by			Page 4 / 21	Revision
Checked by				
Date	14/04/2022			

TORQUE AND CURRENT VS SPEED CURVE



Three Phase Induction Motor - Squirrel Cage

Customer :

Product line : W40 NEMA Premium Efficiency
Three-Phase

Product code : 14495708

Catalog # : 03018OT3E286TC-W40

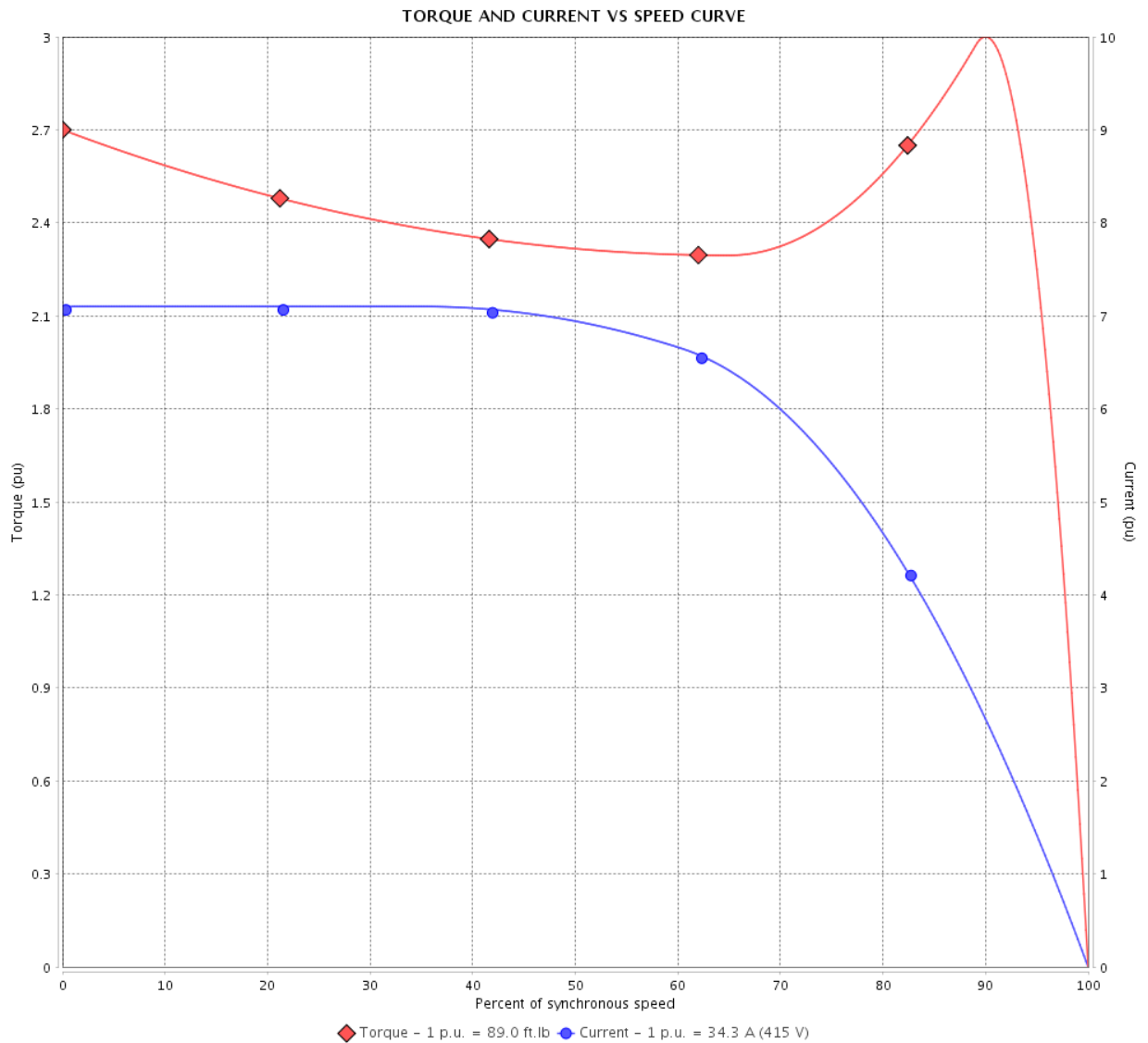

Performance : 415 V 50 Hz 4P IE3

Rated current	: 34.3 A	Moment of inertia (J)	: 4.52 sq.ft.lb
LRC	: 7.1	Duty cycle	: Cont.(S1)
Rated torque	: 89.0 ft.lb	Insulation class	: F
Locked rotor torque	: 280 %	Service factor	: 1.00
Breakdown torque	: 300 %	Temperature rise	: 80 K
Rated speed	: 1470 rpm	Design	: B

Locked rotor time : 30s (cold) 17s (hot)

Rev.	Changes Summary	Performed	Checked	Date
Performed by			Page 5 / 21	Revision
Checked by				
Date	14/04/2022			

LOAD PERFORMANCE CURVE

Three Phase Induction Motor - Squirrel Cage



Customer :

Product line : W40 NEMA Premium Efficiency Three-Phase

Product code : 14495708

Catalog # : 03018OT3E286TC-W40

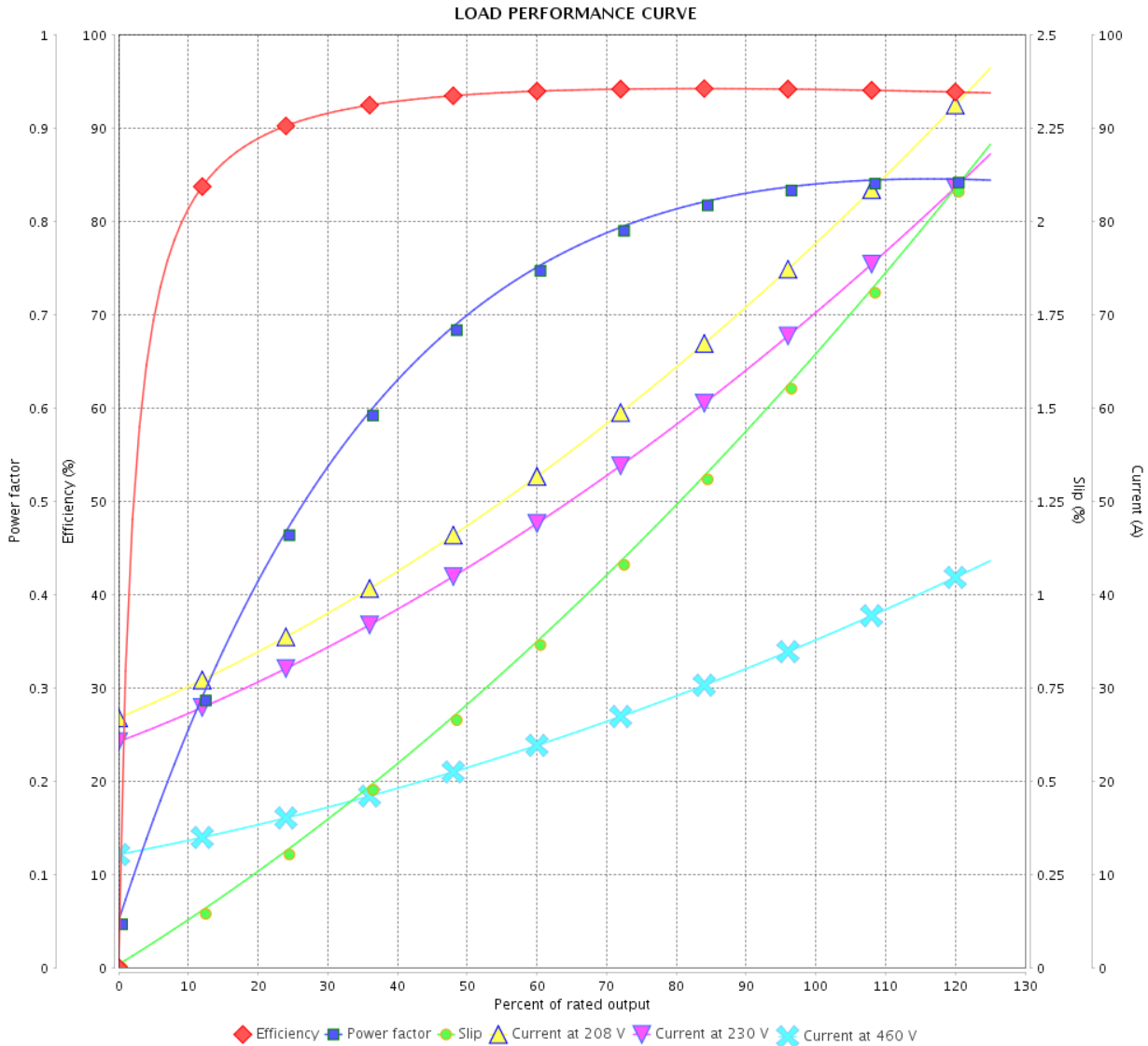

Performance : 230/460 V 60 Hz 4P

Rated current : 69.8/34.9 A
 LRC : 6.6
 Rated torque : 89.0 ft.lb
 Locked rotor torque : 280 %
 Breakdown torque : 270 %
 Rated speed : 1765 rpm

Moment of inertia (J) : 4.52 sq.ft.lb
 Duty cycle : Cont.(S1)
 Insulation class : F
 Service factor : 1.25
 Temperature rise : 80 K
 Design : B

Rev.	Changes Summary	Performed	Checked	Date
Performed by			Page 6 / 21	Revision
Checked by				
Date	14/04/2022			

LOAD PERFORMANCE CURVE

Three Phase Induction Motor - Squirrel Cage



Customer :

Product line : W40 NEMA Premium Efficiency Three-Phase

Product code : 14495708

Catalog # : 03018OT3E286TC-W40

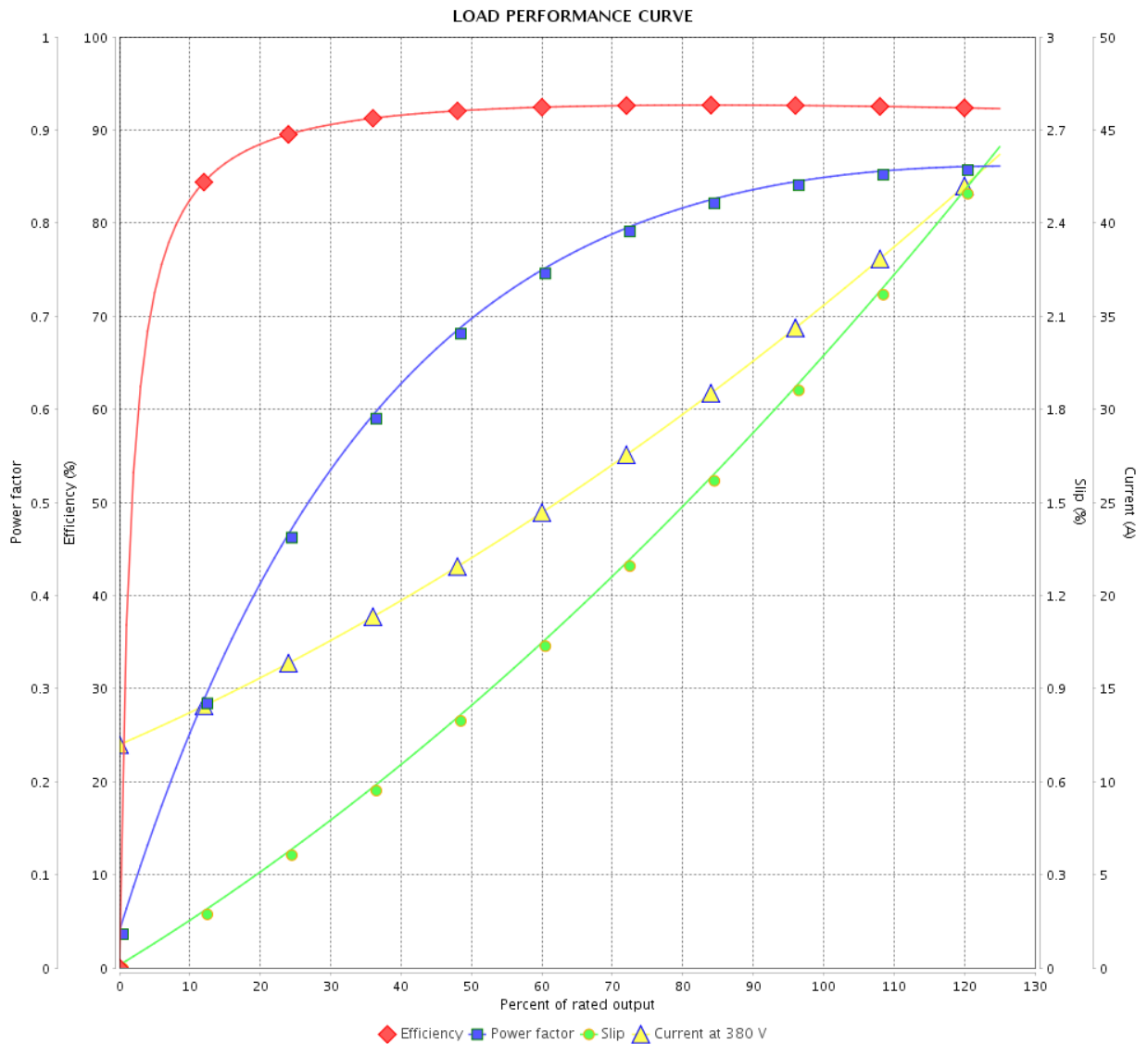

Performance : 380 V 50 Hz 4P IE3

Rated current : 35.7 A
 LRC : 6.9
 Rated torque : 89.3 ft.lb
 Locked rotor torque : 229 %
 Breakdown torque : 240 %
 Rated speed : 1465 rpm

Moment of inertia (J) : 4.52 sq.ft.lb
 Duty cycle : Cont.(S1)
 Insulation class : F
 Service factor : 1.00
 Temperature rise : 80 K
 Design : B

Rev.	Changes Summary	Performed	Checked	Date
Performed by			Page	Revision
Checked by				
Date				
			7 / 21	

LOAD PERFORMANCE CURVE

Three Phase Induction Motor - Squirrel Cage



Customer :

Product line : W40 NEMA Premium Efficiency Three-Phase

Product code : 14495708

Catalog # : 03018OT3E286TC-W40

LOAD PERFORMANCE CURVE

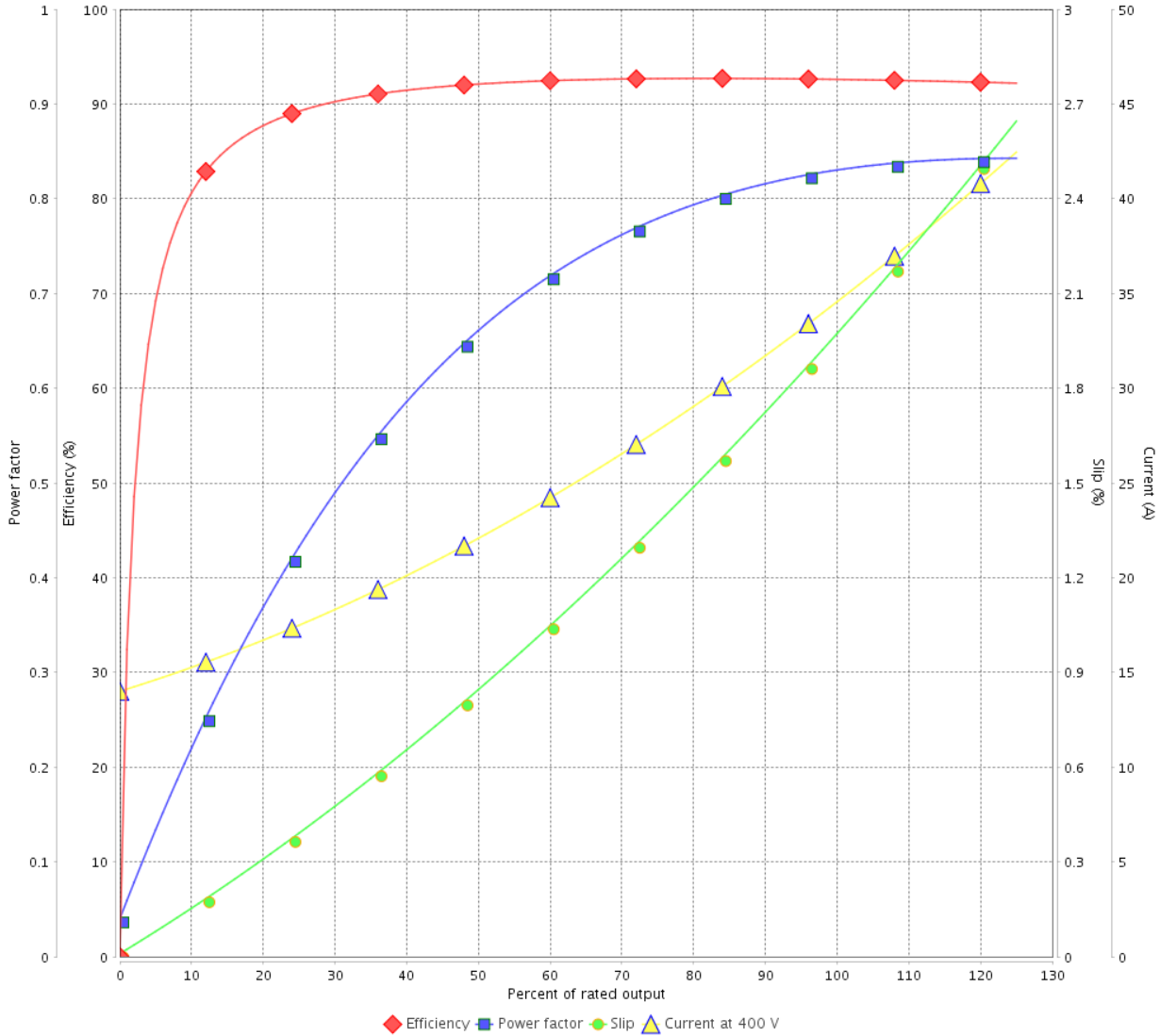

Performance : 400 V 50 Hz 4P IE3

Rated current : 34.7 A
 LRC : 7.2
 Rated torque : 89.3 ft.lb
 Locked rotor torque : 260 %
 Breakdown torque : 270 %
 Rated speed : 1470 rpm

Moment of inertia (J) : 4.52 sq.ft.lb
 Duty cycle : Cont.(S1)
 Insulation class : F
 Service factor : 1.00
 Temperature rise : 80 K
 Design : B

Rev.	Changes Summary	Performed	Checked	Date
Performed by			Page	Revision
Checked by			8 / 21	
Date	14/04/2022			

LOAD PERFORMANCE CURVE

Three Phase Induction Motor - Squirrel Cage



Customer :

Product line : W40 NEMA Premium Efficiency Three-Phase

Product code : 14495708

Catalog # : 03018OT3E286TC-W40

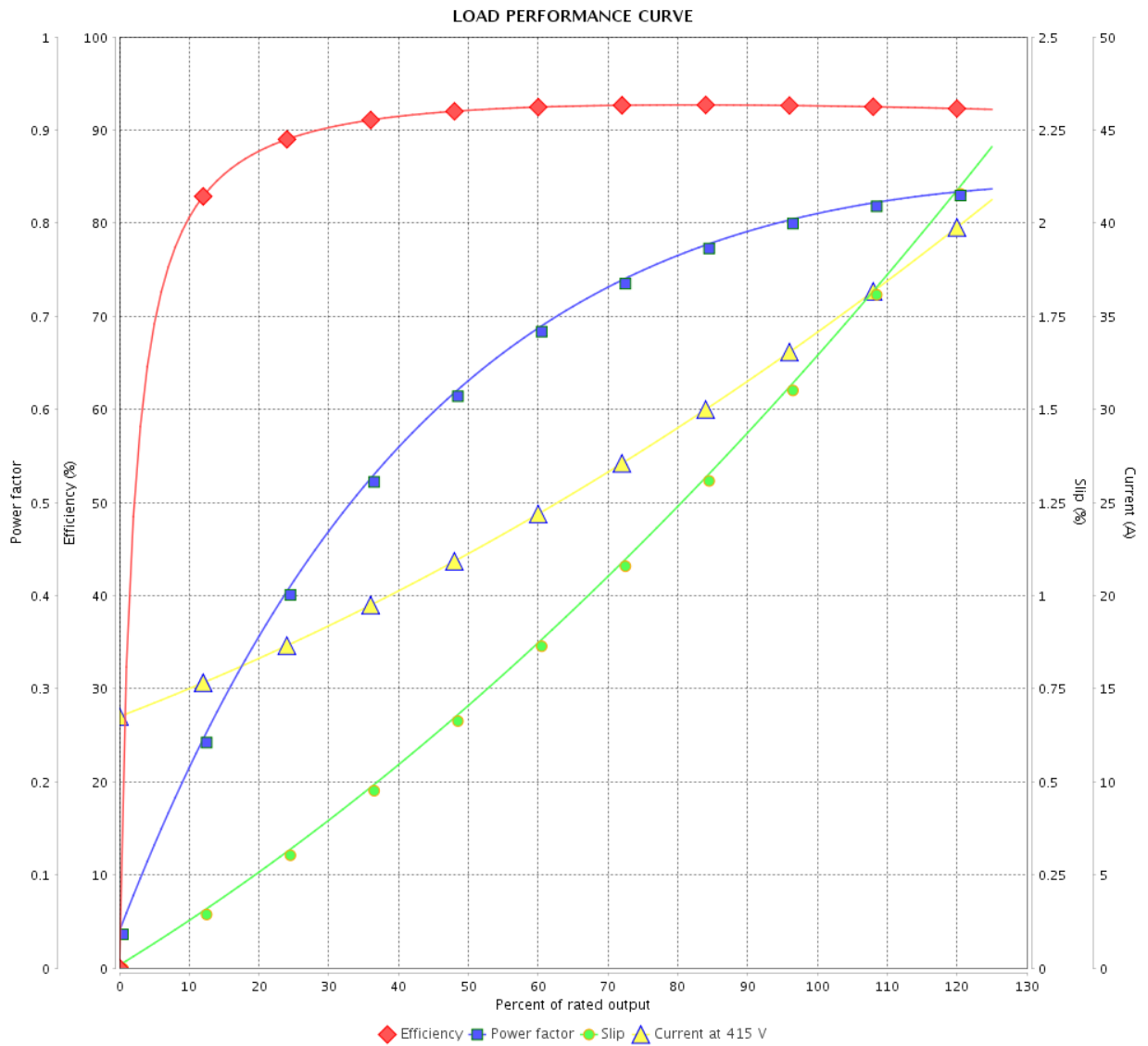

Performance : 415 V 50 Hz 4P IE3

Rated current : 34.3 A
 LRC : 7.1
 Rated torque : 89.0 ft.lb
 Locked rotor torque : 280 %
 Breakdown torque : 300 %
 Rated speed : 1470 rpm

Moment of inertia (J) : 4.52 sq.ft.lb
 Duty cycle : Cont.(S1)
 Insulation class : F
 Service factor : 1.00
 Temperature rise : 80 K
 Design : B

Rev.	Changes Summary	Performed	Checked	Date
Performed by		Page		Revision
Checked by		9 / 21		
Date		14/04/2022		

THERMAL LIMIT CURVE



Three Phase Induction Motor - Squirrel Cage

Customer :

Product line : W40 NEMA Premium Efficiency
Three-Phase

Product code : 14495708

Catalog # : 03018OT3E286TC-W40

Performance : 230/460 V 60 Hz 4P

Rated current : 69.8/34.9 A
LRC : 6.6
Rated torque : 89.0 ft.lb
Locked rotor torque : 280 %
Breakdown torque : 270 %
Rated speed : 1765 rpm

Moment of inertia (J) : 4.52 sq.ft.lb
Duty cycle : Cont.(S1)
Insulation class : F
Service factor : 1.25
Temperature rise : 80 K
Design : B

Heating constant

Cooling constant

Rev.	Changes Summary	Performed	Checked	Date
Performed by				
Checked by			Page	Revision
Date	14/04/2022		10 / 21	

THERMAL LIMIT CURVE

Three Phase Induction Motor - Squirrel Cage



Customer : _____

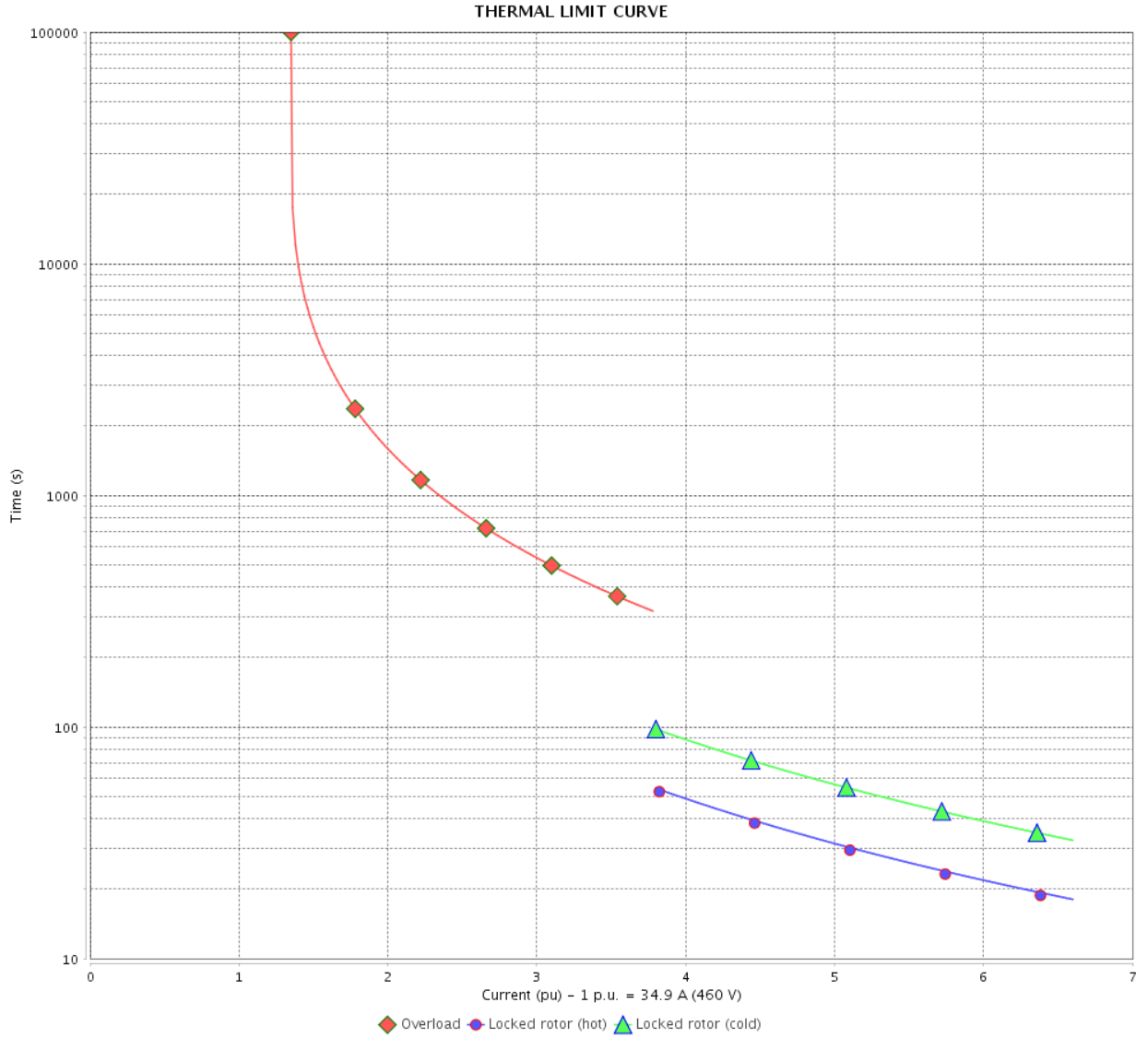

Rev.	Changes Summary	Performed	Checked	Date
Performed by		Page		Revision
Checked by		11 / 21		
Date		14/04/2022		

THERMAL LIMIT CURVE

Three Phase Induction Motor - Squirrel Cage



Customer :

Product line : W40 NEMA Premium Efficiency
Three-Phase

Product code : 14495708

Catalog # : 03018OT3E286TC-W40

Performance : 380 V 50 Hz 4P IE3

Rated current	: 35.7 A	Moment of inertia (J)	: 4.52 sq.ft.lb
LRC	: 6.9	Duty cycle	: Cont.(S1)
Rated torque	: 89.3 ft.lb	Insulation class	: F
Locked rotor torque	: 229 %	Service factor	: 1.00
Breakdown torque	: 240 %	Temperature rise	: 80 K
Rated speed	: 1465 rpm	Design	: B

Heating constant

Cooling constant

Rev.	Changes Summary	Performed	Checked	Date
Performed by				
Checked by			Page	Revision
Date	14/04/2022		12 / 21	

THERMAL LIMIT CURVE

Three Phase Induction Motor - Squirrel Cage



Customer : _____

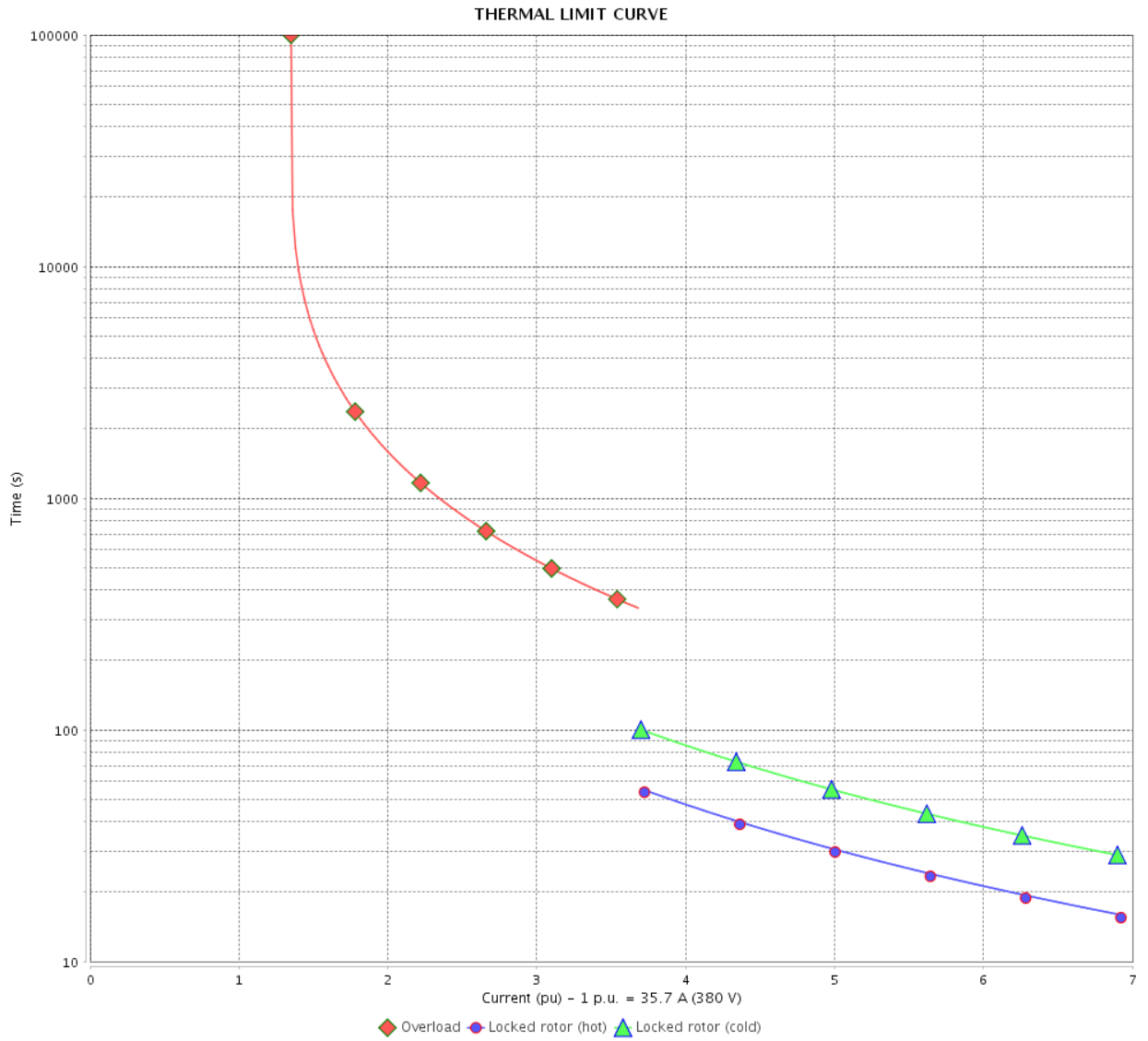

Rev.	Changes Summary	Performed	Checked	Date
Performed by		Page		Revision
Checked by		13 / 21		
Date		14/04/2022		

THERMAL LIMIT CURVE



Three Phase Induction Motor - Squirrel Cage

Customer :

Product line : W40 NEMA Premium Efficiency
Three-Phase

Product code : 14495708

Catalog # : 03018OT3E286TC-W40

Performance : 400 V 50 Hz 4P IE3

Rated current : 34.7 A
LRC : 7.2
Rated torque : 89.3 ft.lb
Locked rotor torque : 260 %
Breakdown torque : 270 %
Rated speed : 1470 rpm

Moment of inertia (J) : 4.52 sq.ft.lb
Duty cycle : Cont.(S1)
Insulation class : F
Service factor : 1.00
Temperature rise : 80 K
Design : B

Heating constant

Cooling constant

Rev.	Changes Summary	Performed	Checked	Date
Performed by				
Checked by			Page	Revision
Date	14/04/2022		14 / 21	

THERMAL LIMIT CURVE

Three Phase Induction Motor - Squirrel Cage



Customer : _____

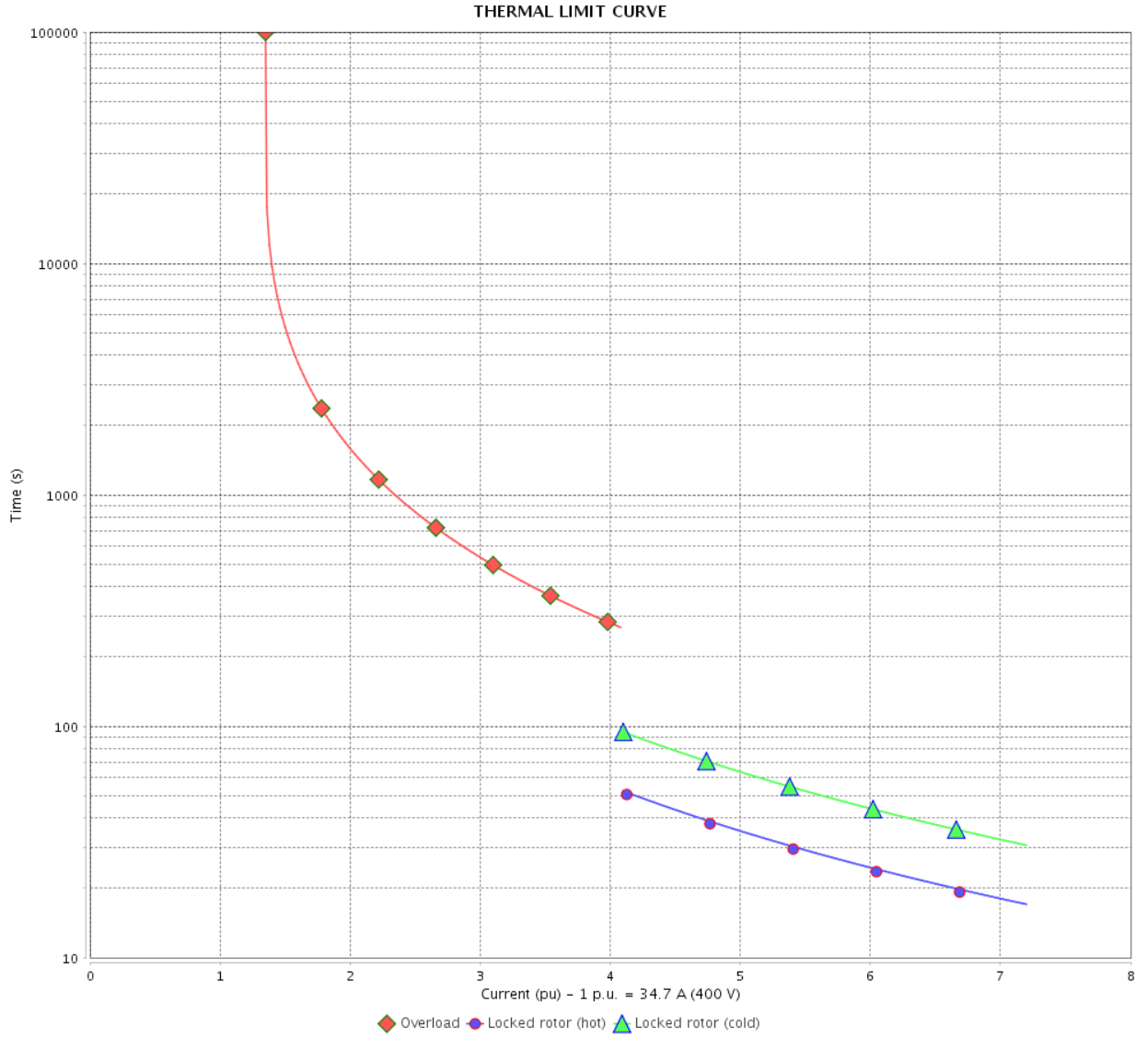

Rev.	Changes Summary	Performed	Checked	Date
Performed by		Page 15 / 21		Revision
Checked by				
Date				

THERMAL LIMIT CURVE

Three Phase Induction Motor - Squirrel Cage



Customer :

Product line : W40 NEMA Premium Efficiency
Three-Phase

Product code : 14495708

Catalog # : 03018OT3E286TC-W40

Performance : 415 V 50 Hz 4P IE3

Rated current	: 34.3 A	Moment of inertia (J)	: 4.52 sq.ft.lb
LRC	: 7.1	Duty cycle	: Cont.(S1)
Rated torque	: 89.0 ft.lb	Insulation class	: F
Locked rotor torque	: 280 %	Service factor	: 1.00
Breakdown torque	: 300 %	Temperature rise	: 80 K
Rated speed	: 1470 rpm	Design	: B

Heating constant

Cooling constant

Rev.	Changes Summary	Performed	Checked	Date
Performed by				
Checked by			Page	Revision
Date	14/04/2022		16 / 21	

THERMAL LIMIT CURVE

Three Phase Induction Motor - Squirrel Cage



Customer : _____

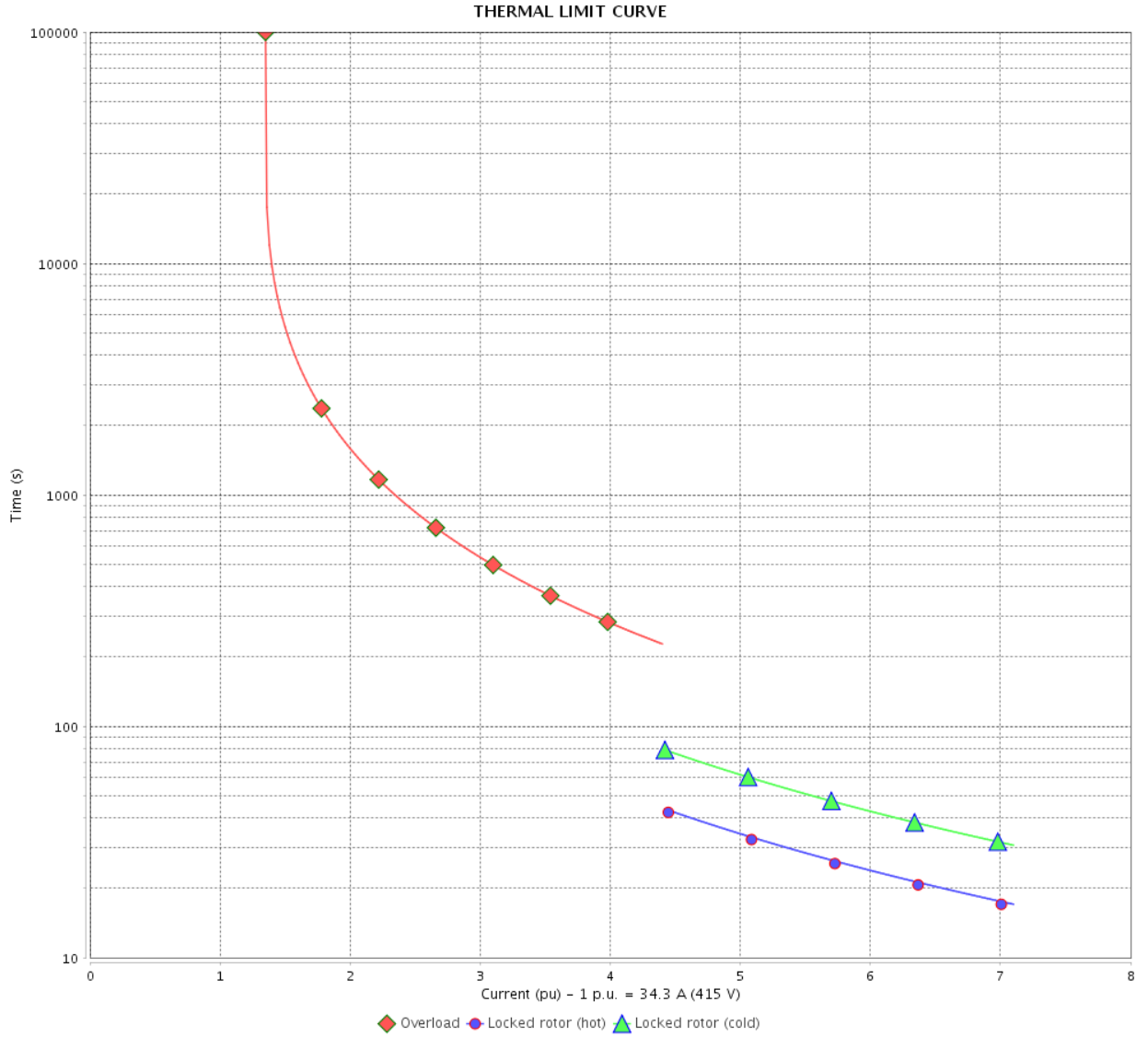

Rev.	Changes Summary	Performed	Checked	Date
Performed by		Page		Revision
Checked by		17 / 21		
Date		14/04/2022		

VFD OPERATION CURVE

Three Phase Induction Motor - Squirrel Cage



Customer : _____

Product line : W40 NEMA Premium Efficiency Three-Phase

Product code : 14495708

Catalog # : 03018OT3E286TC-W40

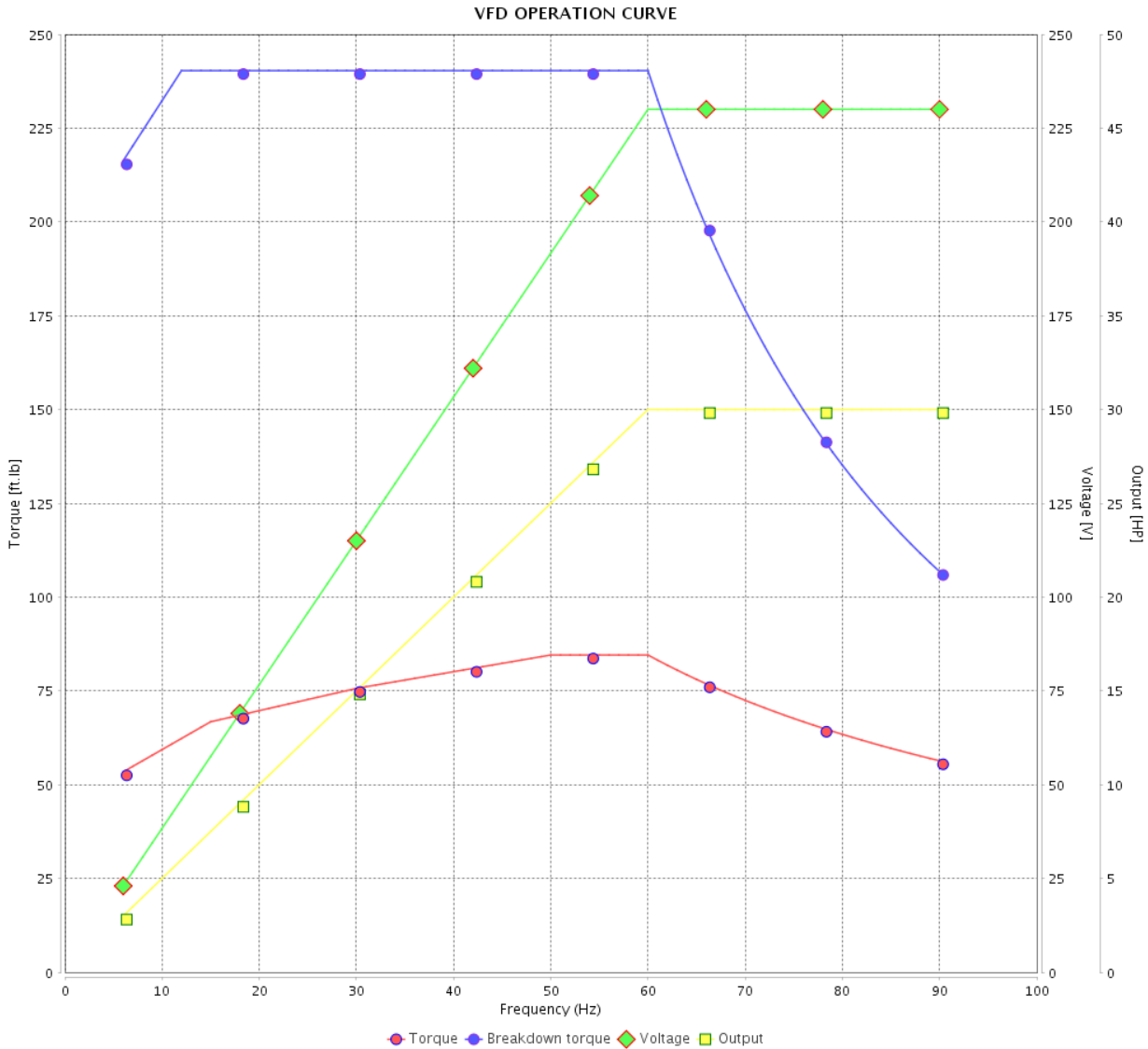

Performance : 230/460 V 60 Hz 4P

Rated current : 69.8/34.9 A
 LRC : 6.6
 Rated torque : 89.0 ft.lb
 Locked rotor torque : 280 %
 Breakdown torque : 270 %
 Rated speed : 1765 rpm

Moment of inertia (J) : 4.52 sq.ft.lb
 Duty cycle : Cont.(S1)
 Insulation class : F
 Service factor : 1.25
 Temperature rise : 80 K
 Design : B

Rev.	Changes Summary	Performed	Checked	Date
Performed by			Page 18 / 21	Revision
Checked by				
Date	14/04/2022			

VFD OPERATION CURVE

Three Phase Induction Motor - Squirrel Cage



Customer :

Product line : W40 NEMA Premium Efficiency
Three-Phase

Product code : 14495708

Catalog # : 03018OT3E286TC-W40

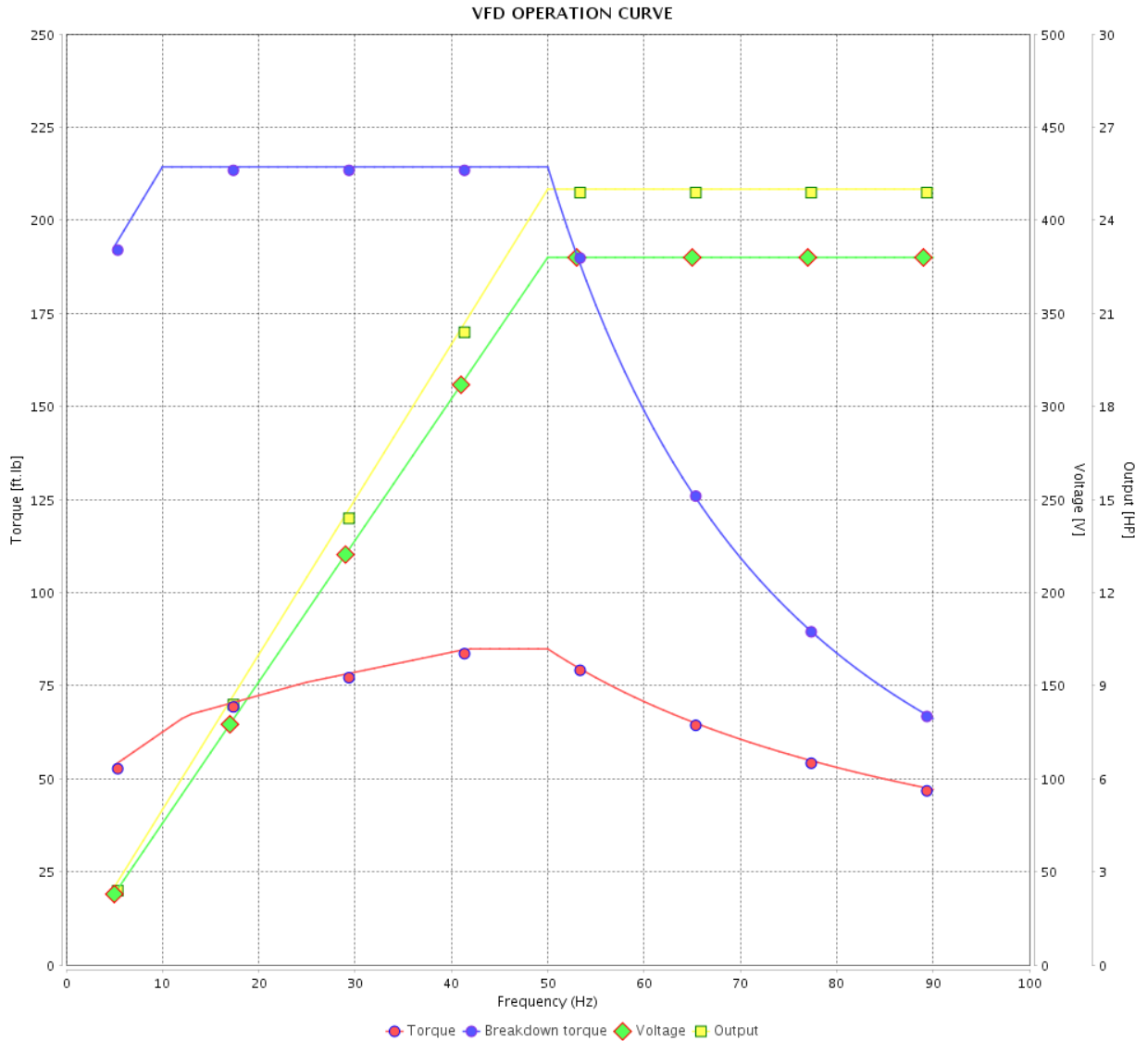

Performance : 380 V 50 Hz 4P IE3

Rated current : 35.7 A
LRC : 6.9
Rated torque : 89.3 ft.lb
Locked rotor torque : 229 %
Breakdown torque : 240 %
Rated speed : 1465 rpm

Moment of inertia (J) : 4.52 sq.ft.lb
Duty cycle : Cont.(S1)
Insulation class : F
Service factor : 1.00
Temperature rise : 80 K
Design : B

Rev.	Changes Summary	Performed	Checked	Date
Performed by			Page	Revision
Checked by			19 / 21	
Date	14/04/2022			

VFD OPERATION CURVE

Three Phase Induction Motor - Squirrel Cage



Customer :

Product line : W40 NEMA Premium Efficiency Three-Phase

Product code : 14495708

Catalog # : 03018OT3E286TC-W40

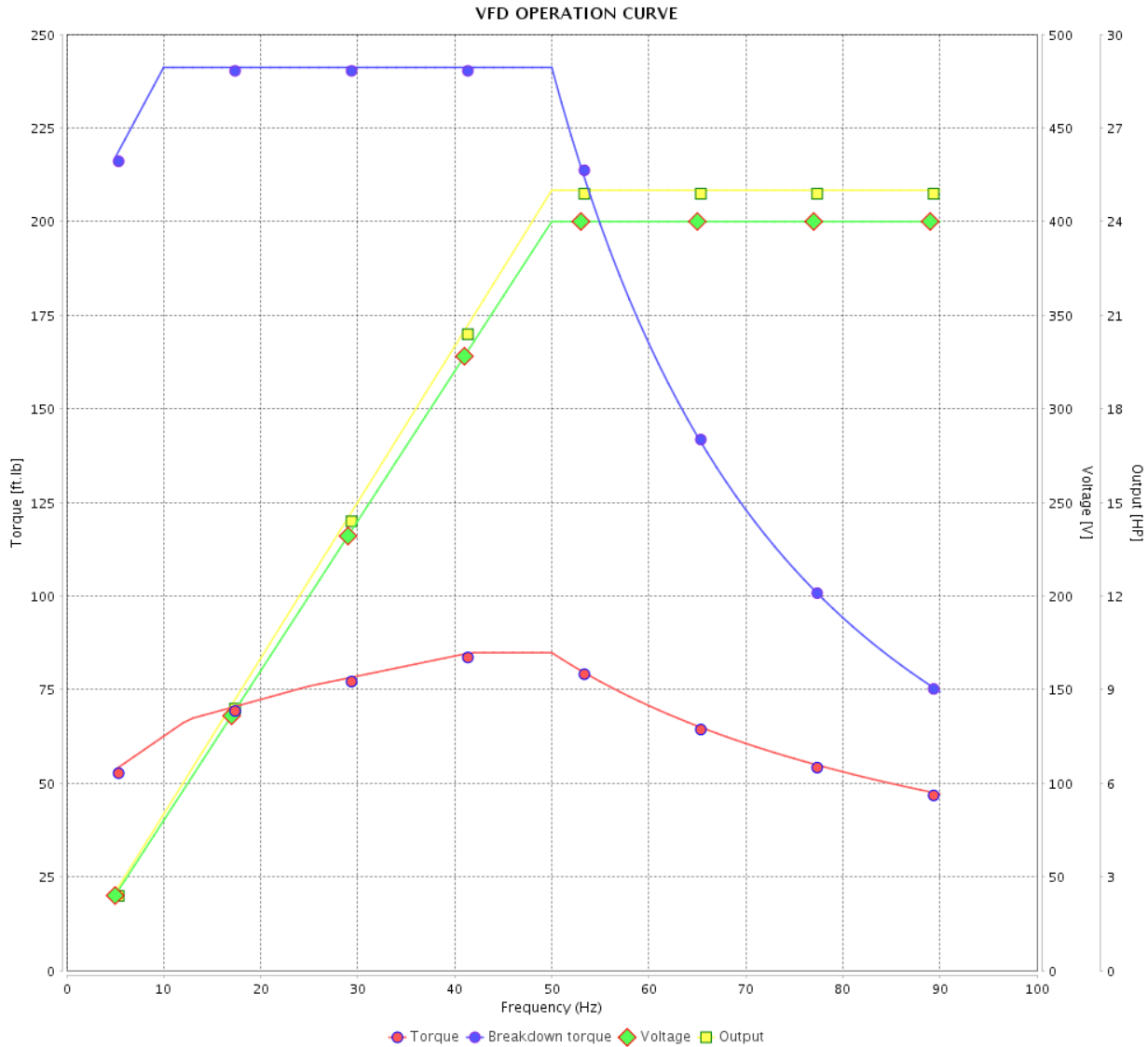

Performance : 400 V 50 Hz 4P IE3

Rated current	: 34.7 A	Moment of inertia (J)	: 4.52 sq.ft.lb
LRC	: 7.2	Duty cycle	: Cont.(S1)
Rated torque	: 89.3 ft.lb	Insulation class	: F
Locked rotor torque	: 260 %	Service factor	: 1.00
Breakdown torque	: 270 %	Temperature rise	: 80 K
Rated speed	: 1470 rpm	Design	: B

Rev.	Changes Summary	Performed	Checked	Date
Performed by			Page 20 / 21	Revision
Checked by				
Date	14/04/2022			

VFD OPERATION CURVE

Three Phase Induction Motor - Squirrel Cage



Customer :

Product line : W40 NEMA Premium Efficiency
Three-Phase

Product code : 14495708

Catalog # : 03018OT3E286TC-W40

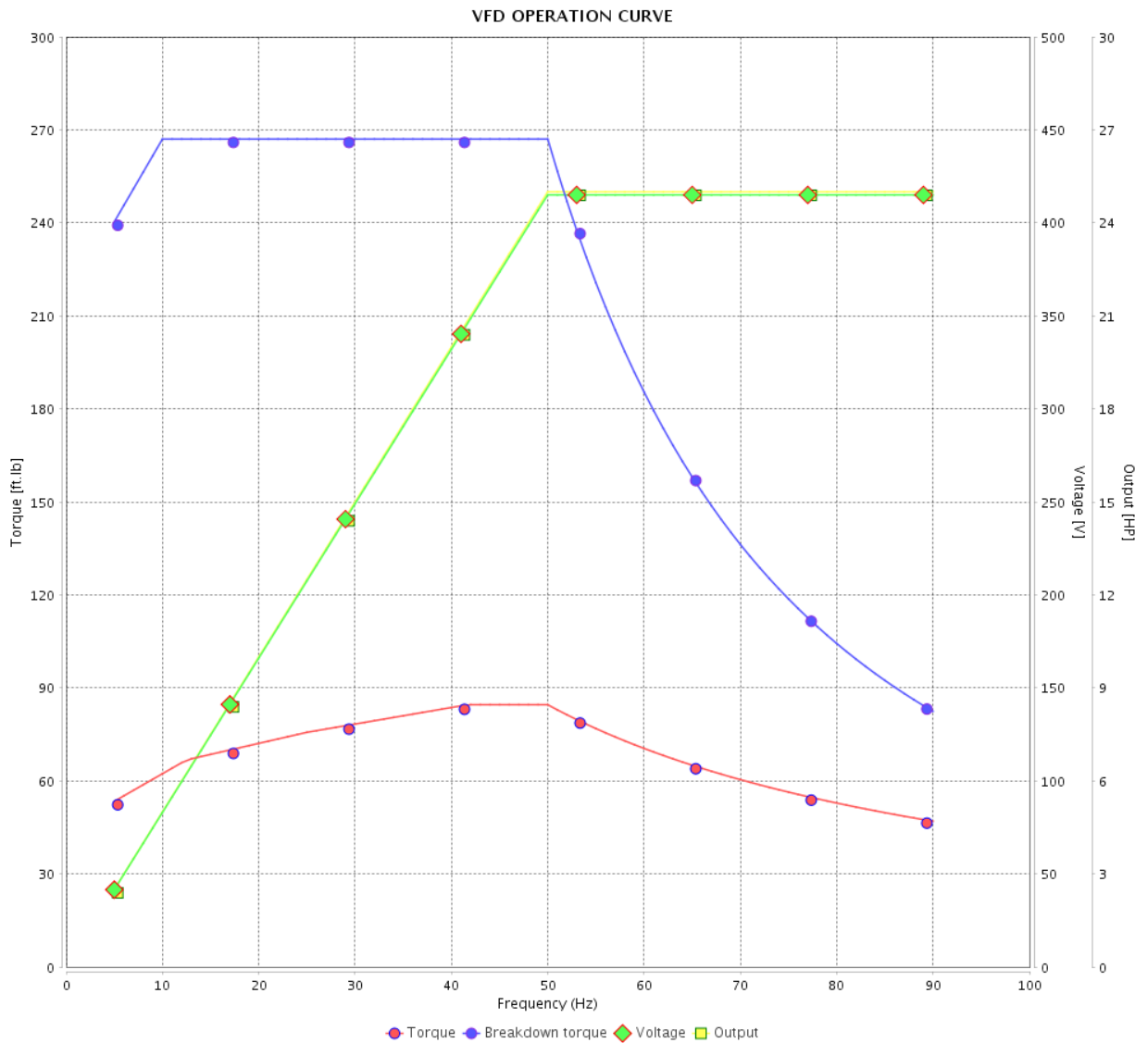

Performance : 415 V 50 Hz 4P IE3

Rated current : 34.3 A
 LRC : 7.1
 Rated torque : 89.0 ft.lb
 Locked rotor torque : 280 %
 Breakdown torque : 300 %
 Rated speed : 1470 rpm

Moment of inertia (J) : 4.52 sq.ft.lb
 Duty cycle : Cont.(S1)
 Insulation class : F
 Service factor : 1.00
 Temperature rise : 80 K
 Design : B

Rev.	Changes Summary	Performed	Checked	Date
Performed by			Page	Revision
Checked by				
Date				

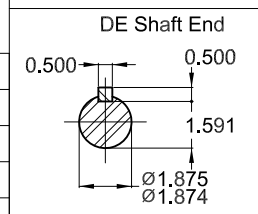
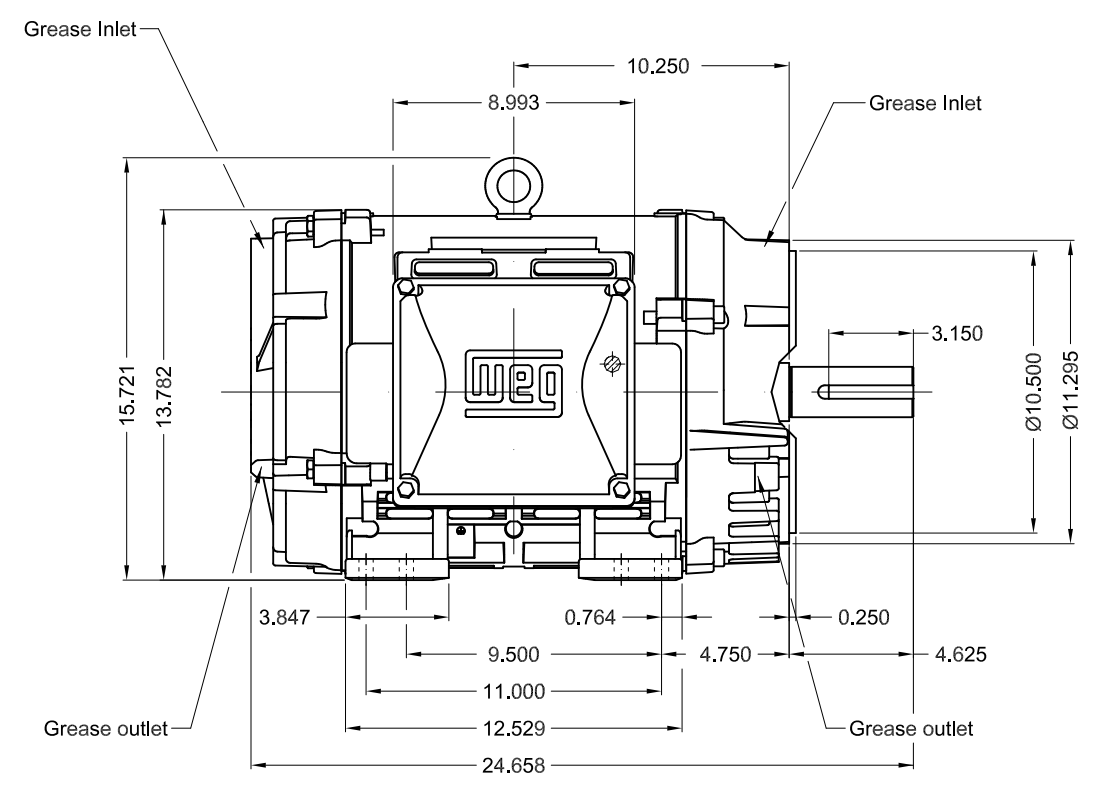
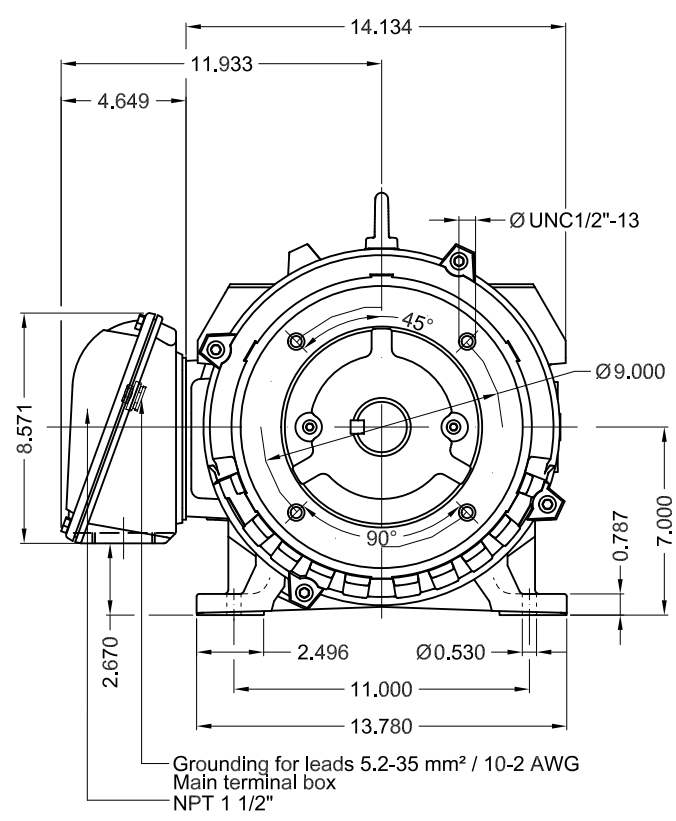

Bearing cap
Color RAL 5009
Painting plan 203A
Mounting NEMA F-1
Mounting B34R(D)

30 HP 04 Poles 60 Hz A

1:7

ECM	LOC	SUMMARY OF MODIFICATIONS	EXECUTED	CHECKED	RELEASED	DATE	VER
EXECUTED	PIRWUSER	THREE PH. MOTOR W40 PREM. EFF.					
CHECKED		FRAME 284/6TC IP23 ODP					
RELEASED							
REL DT.		WMO Jaragua do Sul	Product Engineering	SHEET	1 / 1		

PREVIEW
WDD



WEG **W40 NEMA**
CC029A Premium
Inverter Duty Motor



IEC 60034-1
 MOD.T01#FOXON



For 60Hz use on PWM, VT 1000:1, CT 3:1, 1.0SF

MODEL 030180T3E286TC-W40
 MADE IN BRAZIL
 14495708

PH 3	FR 284/6TC	HP(kW) 30.0(22.0)	Hz 60
V 230/460	A 69.8/34.9	RPM 1770	DES B
NEMA NOM EFF 94.1 %	INS. CL. F Δ T 80 K	IP23	
ENCL ODP	DUTY CONT.	AMB. 40°C	
CODE G	PF 0.84	SF 1.25	SFA 87.3/43.6
USABLE @208V 77.2 A	SF 1.15	SFA 88.8	
25HP 18.5kW 50Hz 380V 35.7A 1470RPM SF1.00 EFF 92.6% (IE3)	ALT 1000 m.a.s.l.	401 Lbs	

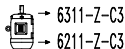
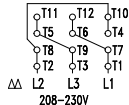

MOBIL POLYREX EM
 18 g 20000 h