

# DATA SHEET



## Three Phase Induction Motor - Squirrel Cage

Customer :							
Product line	: NEMA Premium Efficiency Three-Phase	Product code :	11413120				
		Catalog # :	03036ET3E286TS-W22				
Frame	: 284/6TS	Cooling method	: IC411 - TEFC				
Insulation class	: F	Mounting	: F-1				
Duty cycle	: Cont.(S1)	Rotation <sup>1</sup>	: Both (CW and CCW)				
Ambient temperature	: -20°C to +40°C	Starting method	: Direct On Line				
Altitude	: 1000 m.a.s.l.	Approx. weight <sup>2</sup>	: 415 lb				
Protection degree	: IP55	Moment of inertia (J)	: 3.37 sq.ft.lb				
Design	: B						
Output [HP]	30	25	25	25	30	30	30
Poles	2	2	2	2	2	2	2
Frequency [Hz]	60	50	50	50	50	50	50
Rated voltage [V]	230/460	380	400	415	380	400	415
Rated current [A]	67.6/33.8	34.2	32.5	31.3	42.0	39.6	37.8
L. R. Amperes [A]	426/213	202	218	225	206	218	227
LRC [A]	6.3x(Code G)	5.9x(Code F)	6.7x(Code G)	7.2x(Code H)	4.9x(Code E)	5.5x(Code F)	6.0x(Code F)
No load current [A]	16.0/8.00	7.50	8.00	8.50	7.50	8.00	8.50
Rated speed [RPM]	3535	2930	2940	2950	2895	2910	2925
Slip [%]	1.81	2.33	2.00	1.67	3.50	3.00	2.50
Rated torque [ft.lb]	44.6	44.8	44.7	44.5	54.4	54.1	53.9
Locked rotor torque [%]	200	190	220	229	160	180	190
Breakdown torque [%]	250	229	270	290	190	220	240
Service factor	1.25	1.00	1.00	1.00	1.00	1.00	1.00
Temperature rise	80 K	80 K	80 K	80 K	105 K	105 K	105 K
Locked rotor time	27s (cold) 15s (hot)	21s (cold) 12s (hot)	21s (cold) 12s (hot)	21s (cold) 12s (hot)	21s (cold) 12s (hot)	21s (cold) 12s (hot)	21s (cold) 12s (hot)
Noise level <sup>2</sup>	72.0 dB(A)	67.0 dB(A)	67.0 dB(A)	67.0 dB(A)	67.0 dB(A)	67.0 dB(A)	67.0 dB(A)
Efficiency (%)	25%						
	50%	91.7	91.0	91.1	91.2	91.7	91.7
	75%	91.7	91.5	91.5	91.8	90.2	91.0
	100%	91.7	92.4	92.4	92.4	89.5	90.2
Power Factor	25%						
	50%	0.82	0.80	0.79	0.77	0.85	0.84
	75%	0.87	0.87	0.87	0.86	0.88	0.88
	100%	0.89	0.89	0.89	0.89	0.89	0.89
Bearing type	: Drive end 6311 C3	: Non drive end 6211 C3	Foundation loads				
Sealing	: V'Ring	: V'Ring	Max. traction	: 356 lb			
Lubrication interval	: 14000 h	: 17000 h	Max. compression	: 771 lb			
Lubricant amount	: 18 g	: 11 g					
Lubricant type	: Mobil Polyrex EM						
Notes USABLE @208V 76.7A SF 1.10 SFA 84.4A							
This revision replaces and cancel the previous one, which must be eliminated. (1) Looking the motor from the shaft end. (2) Measured at 1m and with tolerance of +3dB(A). (3) Approximate weight subject to changes after manufacturing process. (4) At 100% of full load.				These are average values based on tests with sinusoidal power supply, subject to the tolerances stipulated in NEMA MG-1.			
Rev.	Changes Summary			Performed	Checked	Date	
Performed by							
Checked by					Page	Revision	
Date	14/04/2022				1 / 36		

# TORQUE AND CURRENT VS SPEED CURVE

## Three Phase Induction Motor - Squirrel Cage



Customer :

Product line : NEMA Premium Efficiency Three-Phase

Product code : 11413120

Catalog # : 03036ET3E286TS-W22

TORQUE AND CURRENT VS SPEED CURVE

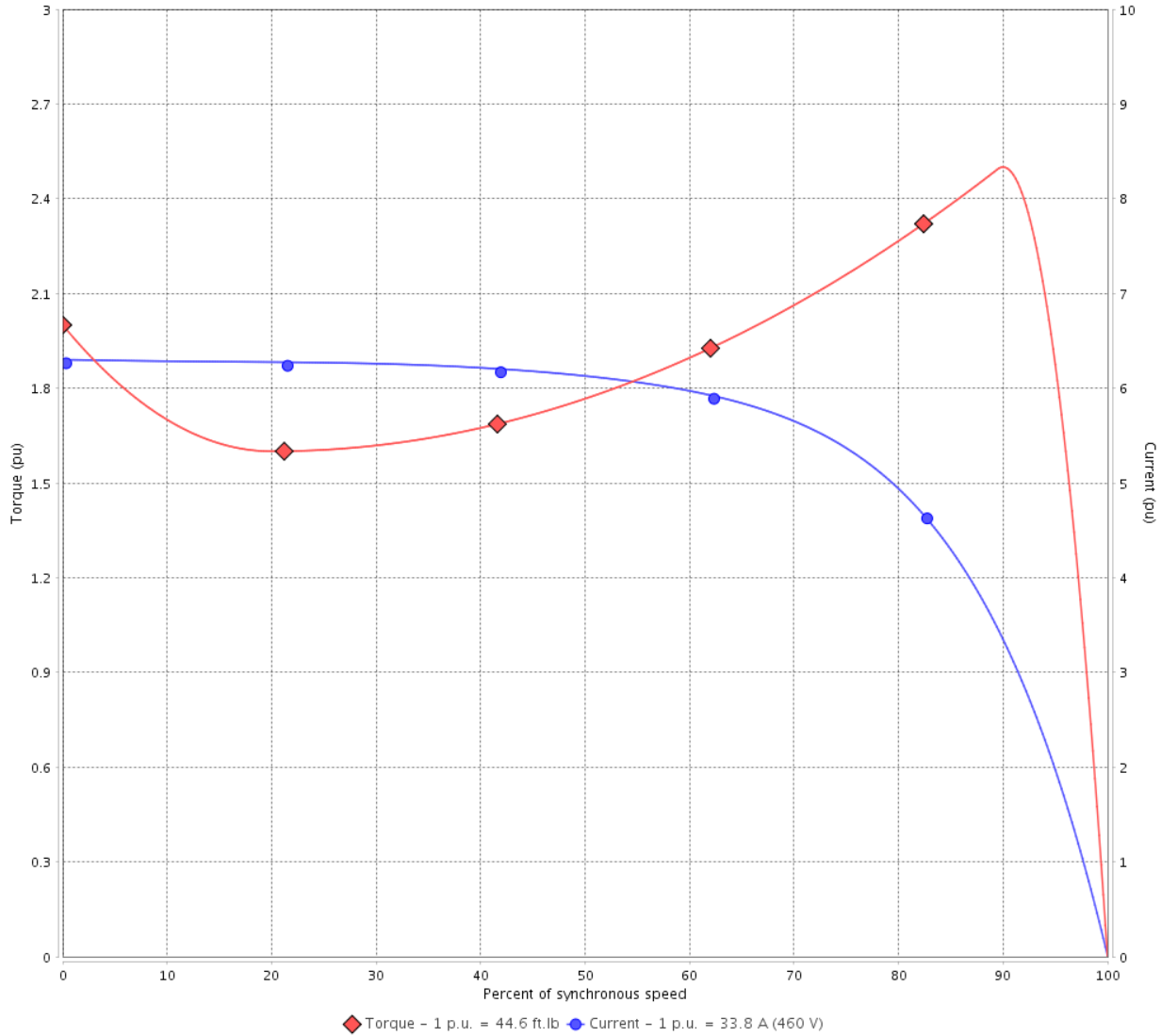

Performance : 230/460 V 60 Hz 2P

Rated current	: 67.6/33.8 A	Moment of inertia (J)	: 3.37 sq.ft.lb
LRC	: 6.3	Duty cycle	: Cont.(S1)
Rated torque	: 44.6 ft.lb	Insulation class	: F
Locked rotor torque	: 200 %	Service factor	: 1.25
Breakdown torque	: 250 %	Temperature rise	: 80 K
Rated speed	: 3535 rpm	Design	: B

Locked rotor time : 27s (cold) 15s (hot)

Rev.	Changes Summary	Performed	Checked	Date
Performed by			Page 2 / 36	Revision
Checked by				
Date	14/04/2022			

# TORQUE AND CURRENT VS SPEED CURVE



## Three Phase Induction Motor - Squirrel Cage

Customer :

Product line : NEMA Premium Efficiency Three-Phase

Product code : 11413120

Catalog # : 03036ET3E286TS-W22

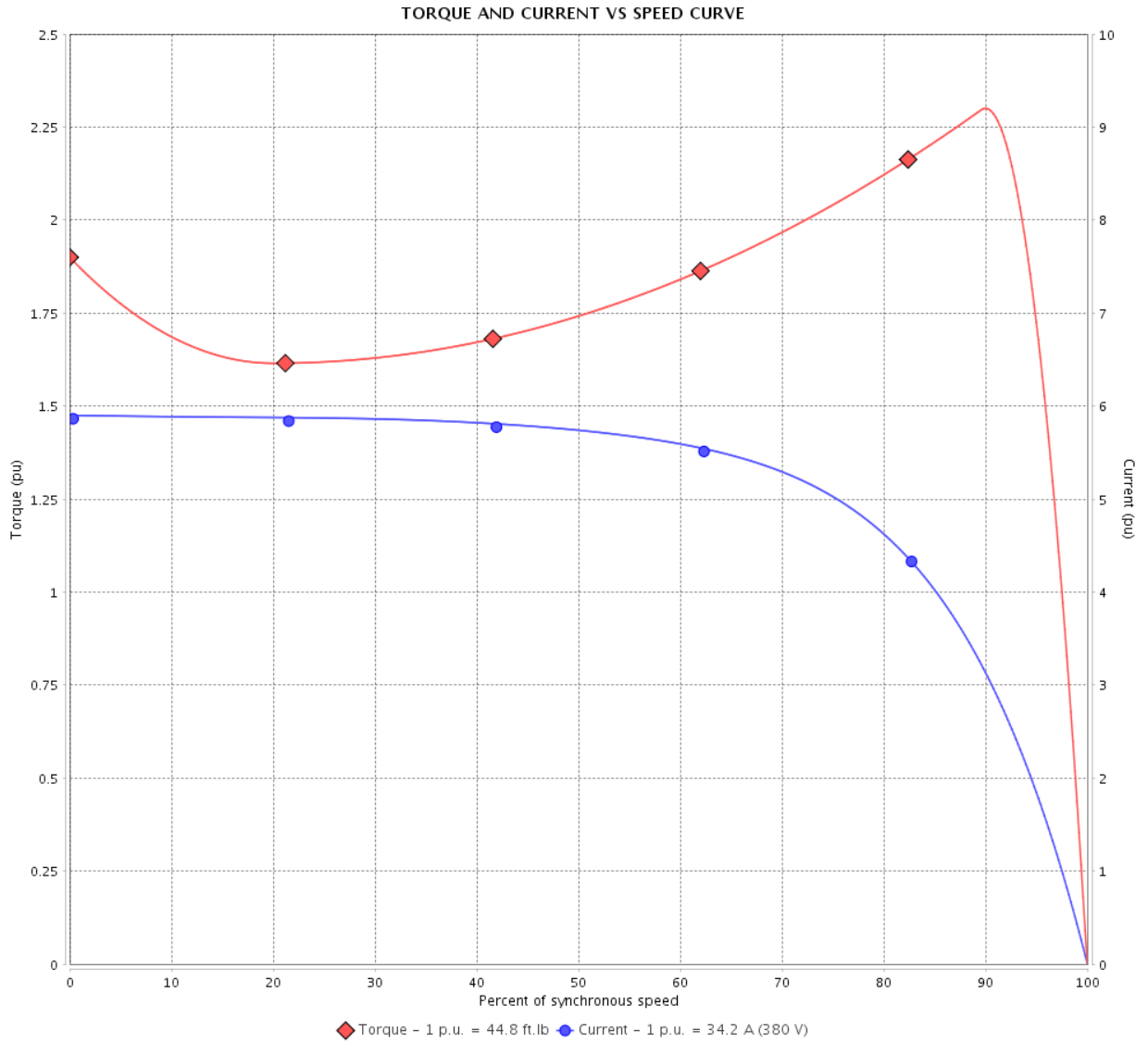

Performance : 380 V 50 Hz 2P IE3

Rated current : 34.2 A  
 LRC : 5.9  
 Rated torque : 44.8 ft.lb  
 Locked rotor torque : 190 %  
 Breakdown torque : 229 %  
 Rated speed : 2930 rpm

Moment of inertia (J) : 3.37 sq.ft.lb  
 Duty cycle : Cont.(S1)  
 Insulation class : F  
 Service factor : 1.00  
 Temperature rise : 80 K  
 Design : B

Locked rotor time : 21s (cold) 12s (hot)

Rev.	Changes Summary	Performed	Checked	Date
Performed by			Page	Revision
Checked by			3 / 36	
Date	14/04/2022			

# TORQUE AND CURRENT VS SPEED CURVE

## Three Phase Induction Motor - Squirrel Cage



Customer :

Product line : NEMA Premium Efficiency Three-Phase

Product code : 11413120

Catalog # : 03036ET3E286TS-W22

TORQUE AND CURRENT VS SPEED CURVE

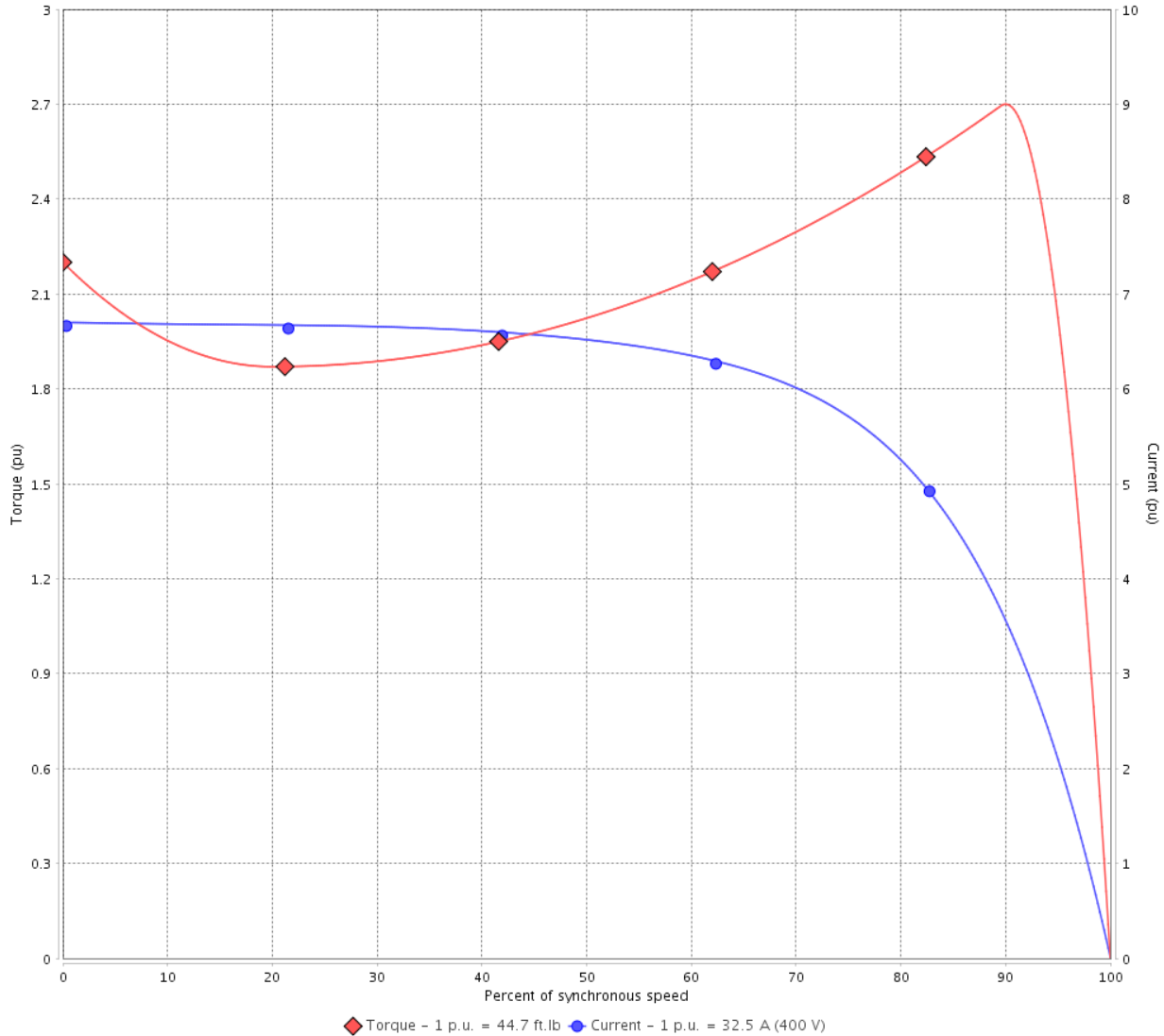

Performance : 400 V 50 Hz 2P IE3

Rated current	: 32.5 A	Moment of inertia (J)	: 3.37 sq.ft.lb
LRC	: 6.7	Duty cycle	: Cont.(S1)
Rated torque	: 44.7 ft.lb	Insulation class	: F
Locked rotor torque	: 220 %	Service factor	: 1.00
Breakdown torque	: 270 %	Temperature rise	: 80 K
Rated speed	: 2940 rpm	Design	: B

Locked rotor time : 21s (cold) 12s (hot)

Rev.	Changes Summary	Performed	Checked	Date
Performed by			Page 4 / 36	Revision
Checked by				
Date	14/04/2022			

# TORQUE AND CURRENT VS SPEED CURVE



## Three Phase Induction Motor - Squirrel Cage

Customer :

Product line : NEMA Premium Efficiency Three-Phase

Product code : 11413120

Catalog # : 03036ET3E286TS-W22

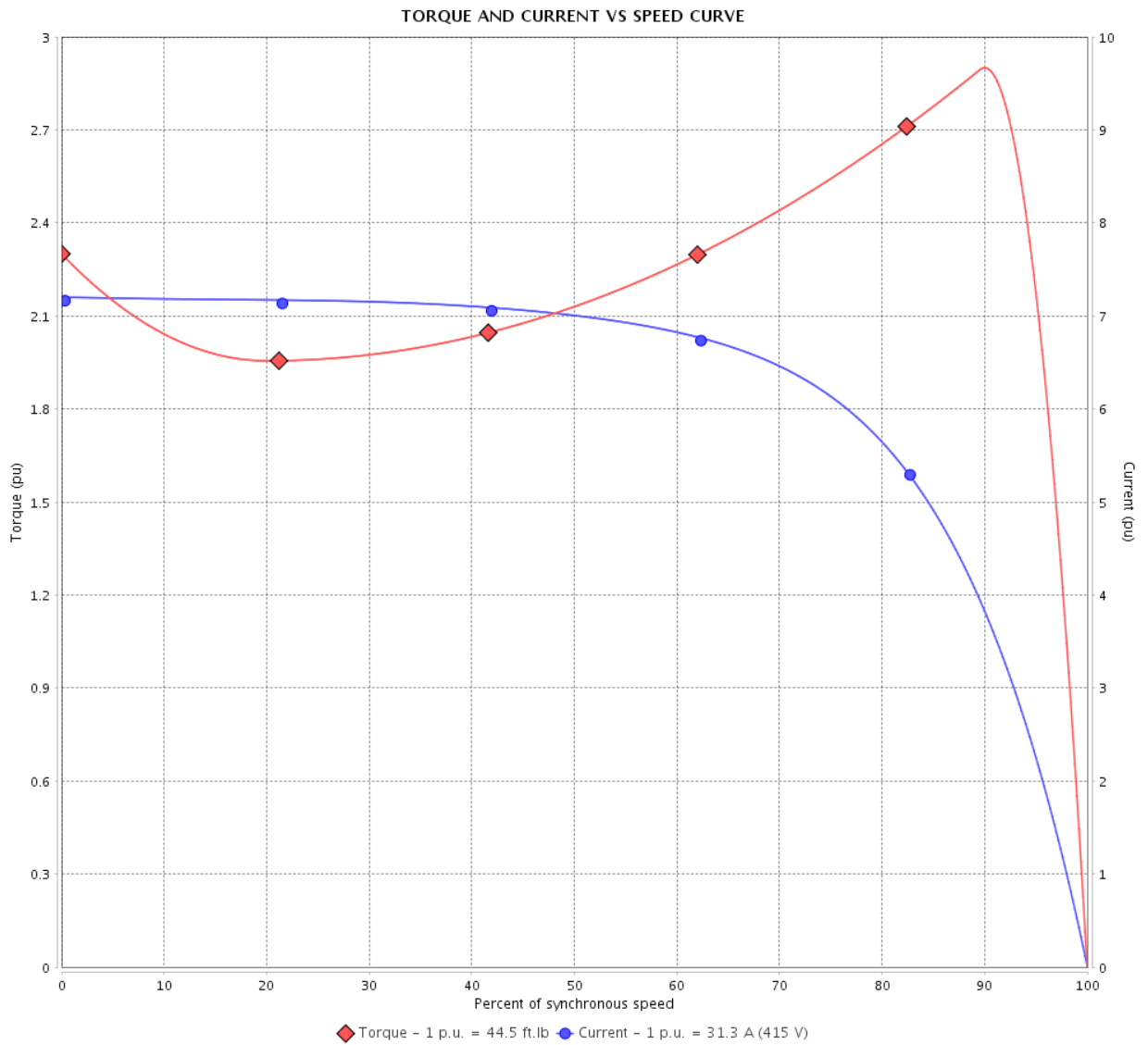

Performance : 415 V 50 Hz 2P IE3

Rated current	: 31.3 A	Moment of inertia (J)	: 3.37 sq.ft.lb
LRC	: 7.2	Duty cycle	: Cont.(S1)
Rated torque	: 44.5 ft.lb	Insulation class	: F
Locked rotor torque	: 229 %	Service factor	: 1.00
Breakdown torque	: 290 %	Temperature rise	: 80 K
Rated speed	: 2950 rpm	Design	: B

Locked rotor time : 21s (cold) 12s (hot)

Rev.	Changes Summary	Performed	Checked	Date
Performed by			Page 5 / 36	Revision
Checked by				
Date	14/04/2022			

# TORQUE AND CURRENT VS SPEED CURVE

Three Phase Induction Motor - Squirrel Cage



Customer :

Product line : NEMA Premium Efficiency Three-Phase

Product code : 11413120

Catalog # : 03036ET3E286TS-W22

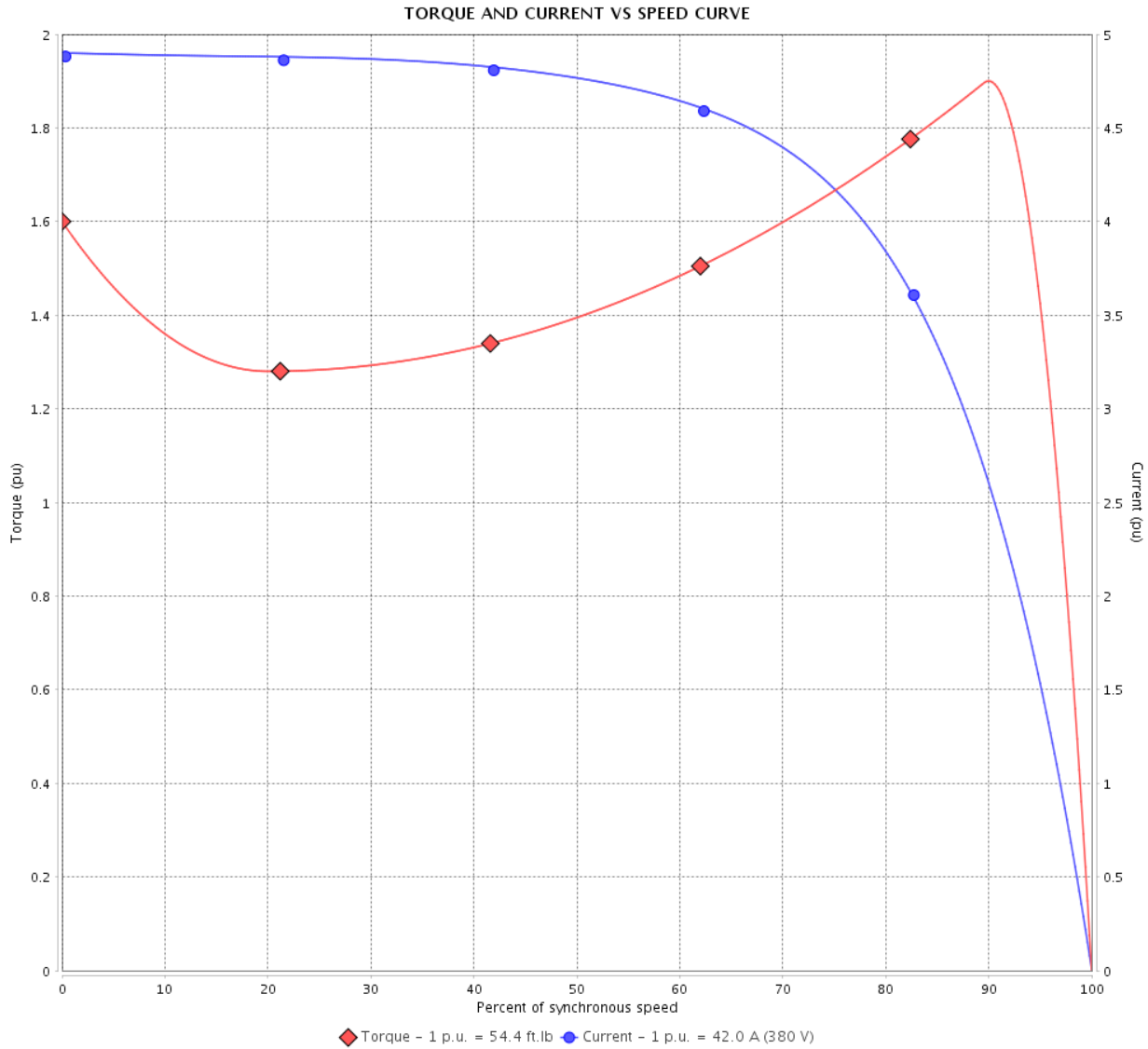

Performance : 380 V 50 Hz 2P

Rated current	: 42.0 A	Moment of inertia (J)	: 3.37 sq.ft.lb
LRC	: 4.9	Duty cycle	: Cont.(S1)
Rated torque	: 54.4 ft.lb	Insulation class	: F
Locked rotor torque	: 160 %	Service factor	: 1.00
Breakdown torque	: 190 %	Temperature rise	: 105 K
Rated speed	: 2895 rpm	Design	: B

Locked rotor time : 21s (cold) 12s (hot)

Rev.	Changes Summary	Performed	Checked	Date
Performed by			Page 6 / 36	Revision
Checked by				
Date	14/04/2022			

# TORQUE AND CURRENT VS SPEED CURVE



## Three Phase Induction Motor - Squirrel Cage

Customer :

Product line : NEMA Premium Efficiency Three-Phase

Product code : 11413120

Catalog # : 03036ET3E286TS-W22

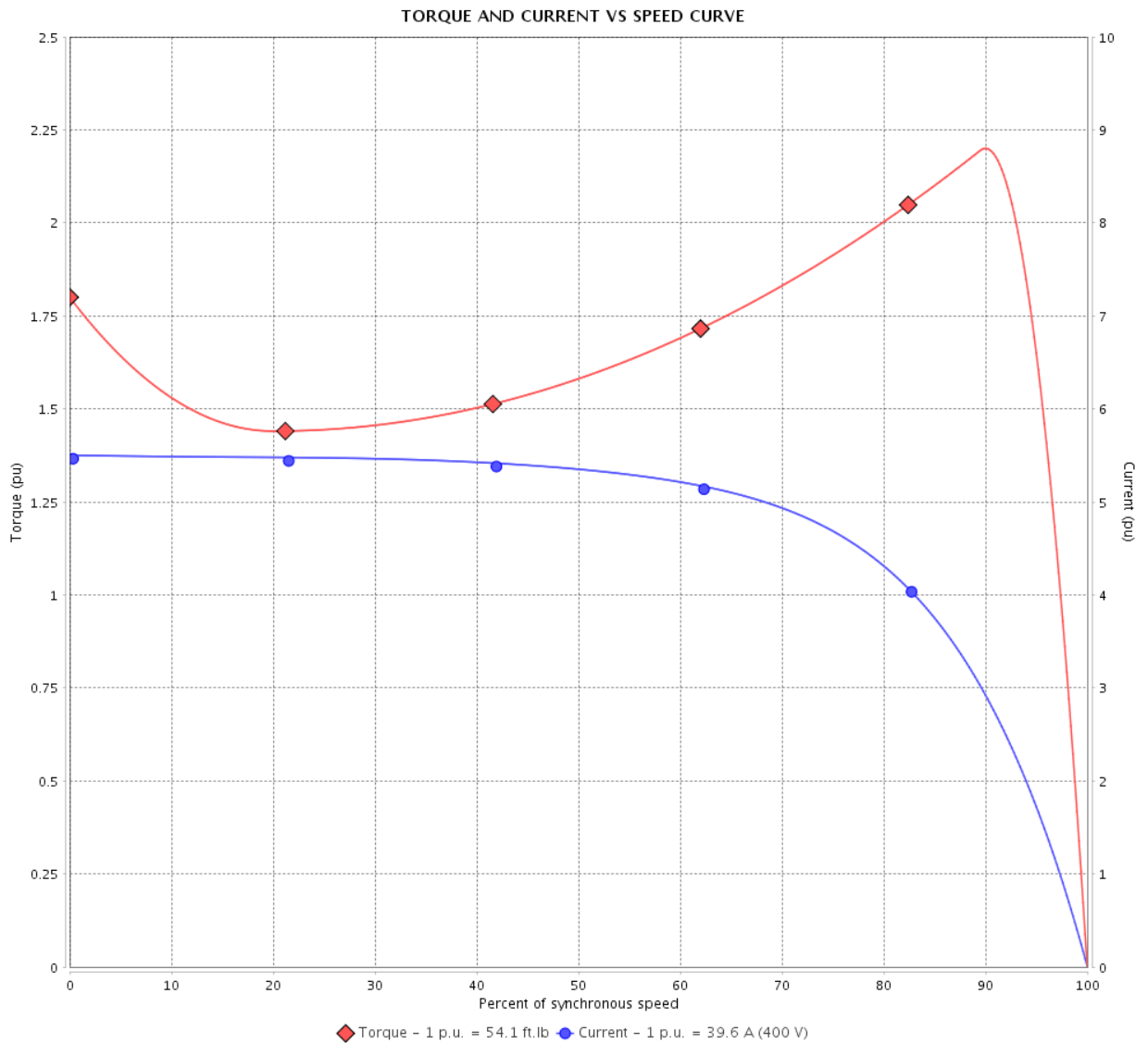

Performance : 400 V 50 Hz 2P IE1

Rated current	: 39.6 A	Moment of inertia (J)	: 3.37 sq.ft.lb
LRC	: 5.5	Duty cycle	: Cont.(S1)
Rated torque	: 54.1 ft.lb	Insulation class	: F
Locked rotor torque	: 180 %	Service factor	: 1.00
Breakdown torque	: 220 %	Temperature rise	: 105 K
Rated speed	: 2910 rpm	Design	: B

Locked rotor time : 21s (cold) 12s (hot)

Rev.	Changes Summary	Performed	Checked	Date
Performed by			Page 7 / 36	Revision
Checked by				
Date	14/04/2022			

# TORQUE AND CURRENT VS SPEED CURVE

Three Phase Induction Motor - Squirrel Cage



Customer :

Product line : NEMA Premium Efficiency Three-Phase

Product code : 11413120

Catalog # : 03036ET3E286TS-W22

TORQUE AND CURRENT VS SPEED CURVE

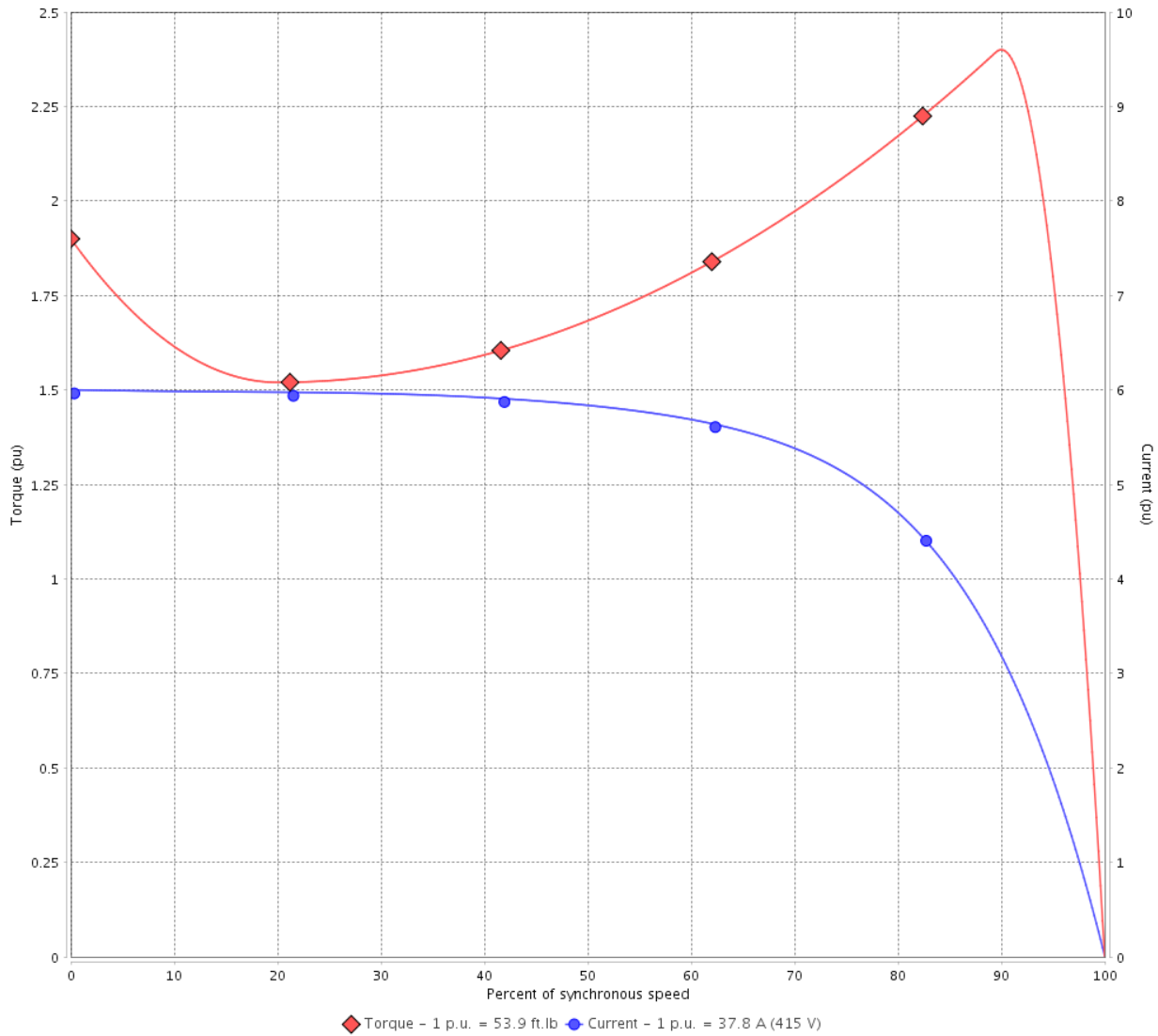

Performance : 415 V 50 Hz 2P IE1

Rated current	: 37.8 A	Moment of inertia (J)	: 3.37 sq.ft.lb
LRC	: 6.0	Duty cycle	: Cont.(S1)
Rated torque	: 53.9 ft.lb	Insulation class	: F
Locked rotor torque	: 190 %	Service factor	: 1.00
Breakdown torque	: 240 %	Temperature rise	: 105 K
Rated speed	: 2925 rpm	Design	: B

Locked rotor time : 21s (cold) 12s (hot)

Rev.	Changes Summary	Performed	Checked	Date
Performed by			Page 8 / 36	Revision
Checked by				
Date	14/04/2022			



# LOAD PERFORMANCE CURVE

## Three Phase Induction Motor - Squirrel Cage



Customer : \_\_\_\_\_

Product line : NEMA Premium Efficiency Three-Phase

Product code : 11413120

Catalog # : 03036ET3E286TS-W22

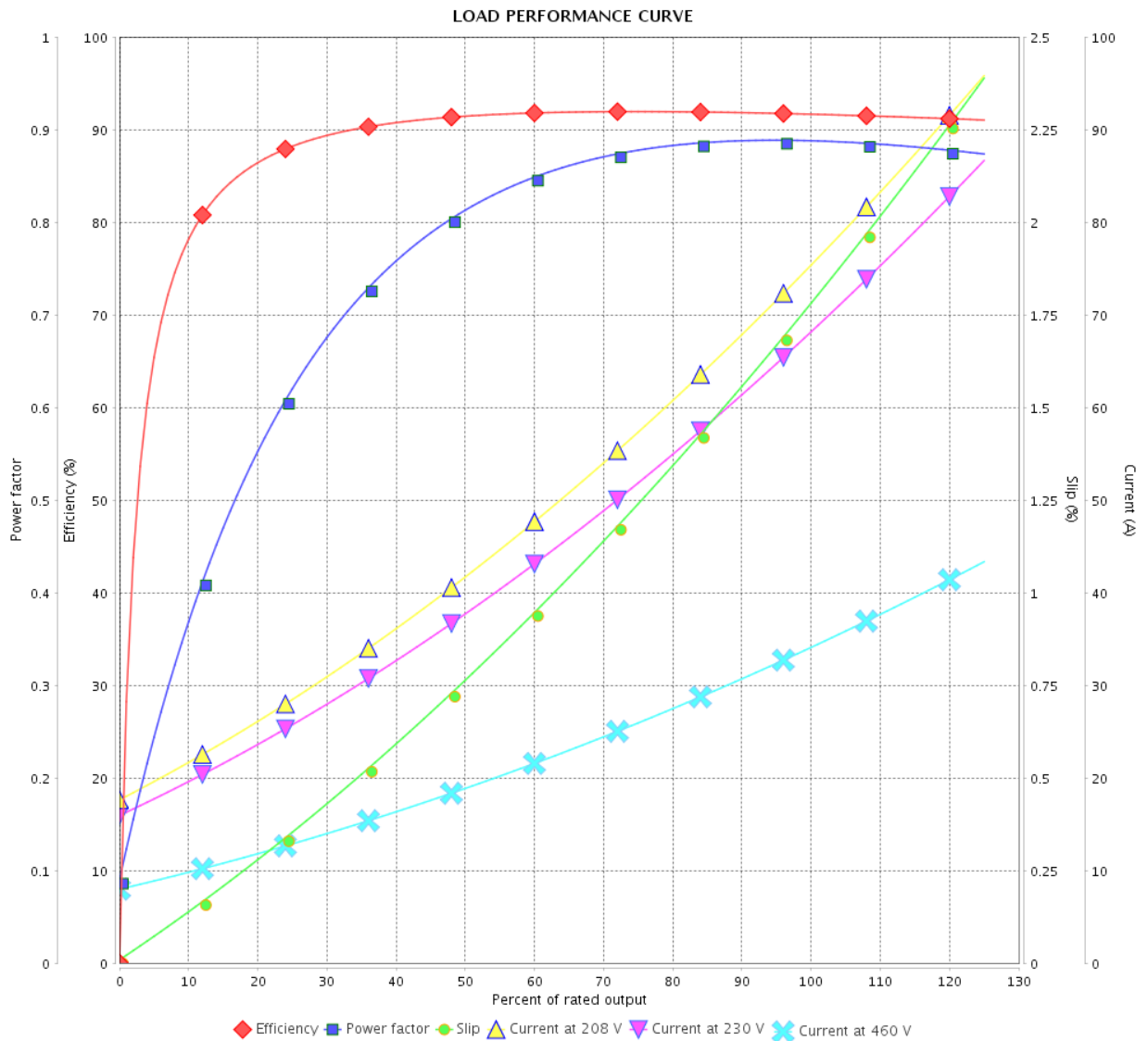

Performance : 230/460 V 60 Hz 2P

Rated current : 67.6/33.8 A  
 LRC : 6.3  
 Rated torque : 44.6 ft.lb  
 Locked rotor torque : 200 %  
 Breakdown torque : 250 %  
 Rated speed : 3535 rpm

Moment of inertia (J) : 3.37 sq.ft.lb  
 Duty cycle : Cont.(S1)  
 Insulation class : F  
 Service factor : 1.25  
 Temperature rise : 80 K  
 Design : B

Rev.	Changes Summary	Performed	Checked	Date
Performed by			Page	Revision
Checked by				
Date				

# LOAD PERFORMANCE CURVE

Three Phase Induction Motor - Squirrel Cage



Customer :

Product line : NEMA Premium Efficiency Three-Phase

Product code : 11413120

Catalog # : 03036ET3E286TS-W22

LOAD PERFORMANCE CURVE

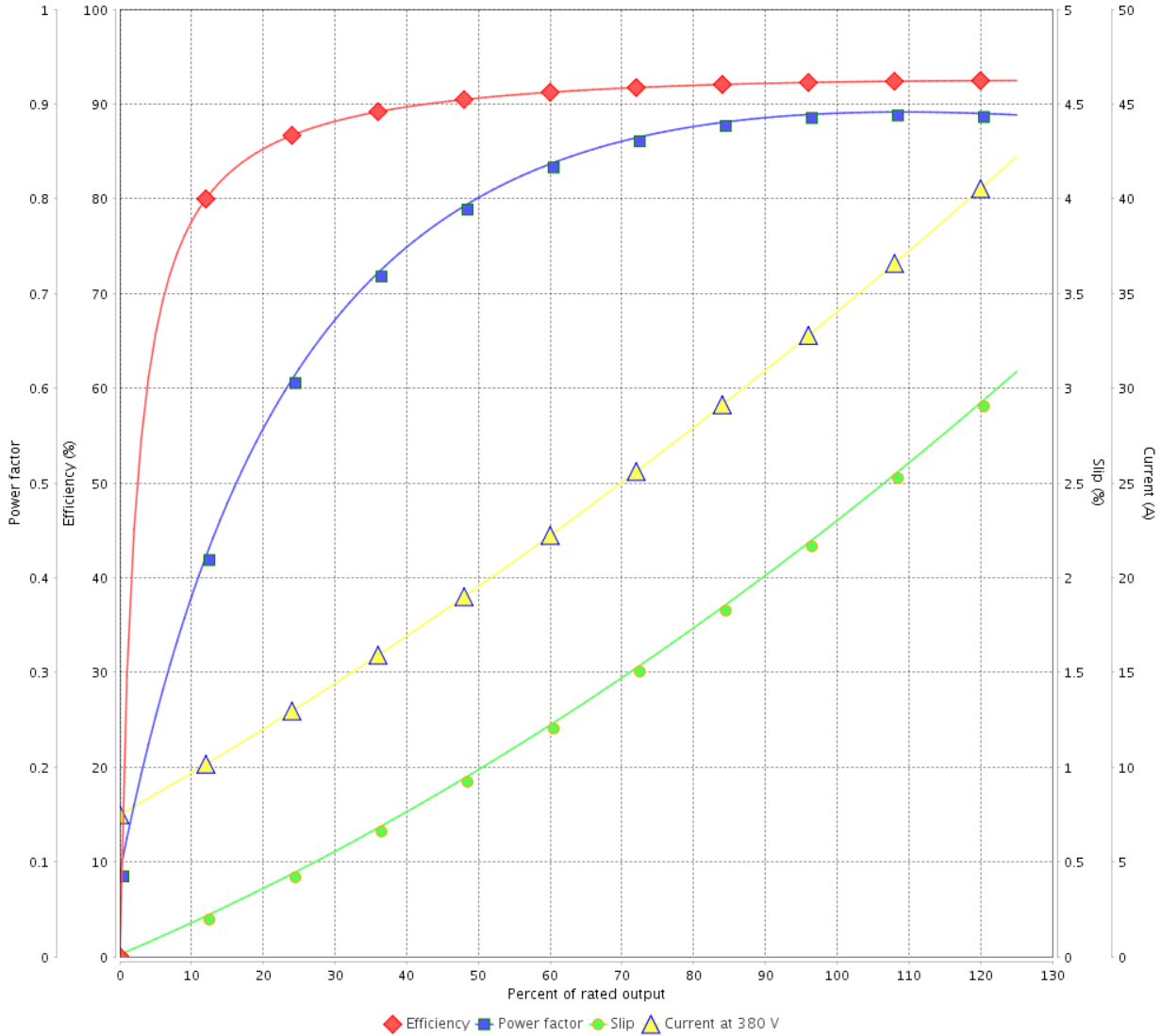

Performance : 380 V 50 Hz 2P IE3

Rated current : 34.2 A  
 LRC : 5.9  
 Rated torque : 44.8 ft.lb  
 Locked rotor torque : 190 %  
 Breakdown torque : 229 %  
 Rated speed : 2930 rpm

Moment of inertia (J) : 3.37 sq.ft.lb  
 Duty cycle : Cont.(S1)  
 Insulation class : F  
 Service factor : 1.00  
 Temperature rise : 80 K  
 Design : B

Rev.	Changes Summary	Performed	Checked	Date
Performed by			Page 10 / 36	Revision
Checked by				
Date	14/04/2022			

# LOAD PERFORMANCE CURVE

## Three Phase Induction Motor - Squirrel Cage



Customer : \_\_\_\_\_

Product line : NEMA Premium Efficiency Three-Phase

Product code : 11413120

Catalog # : 03036ET3E286TS-W22

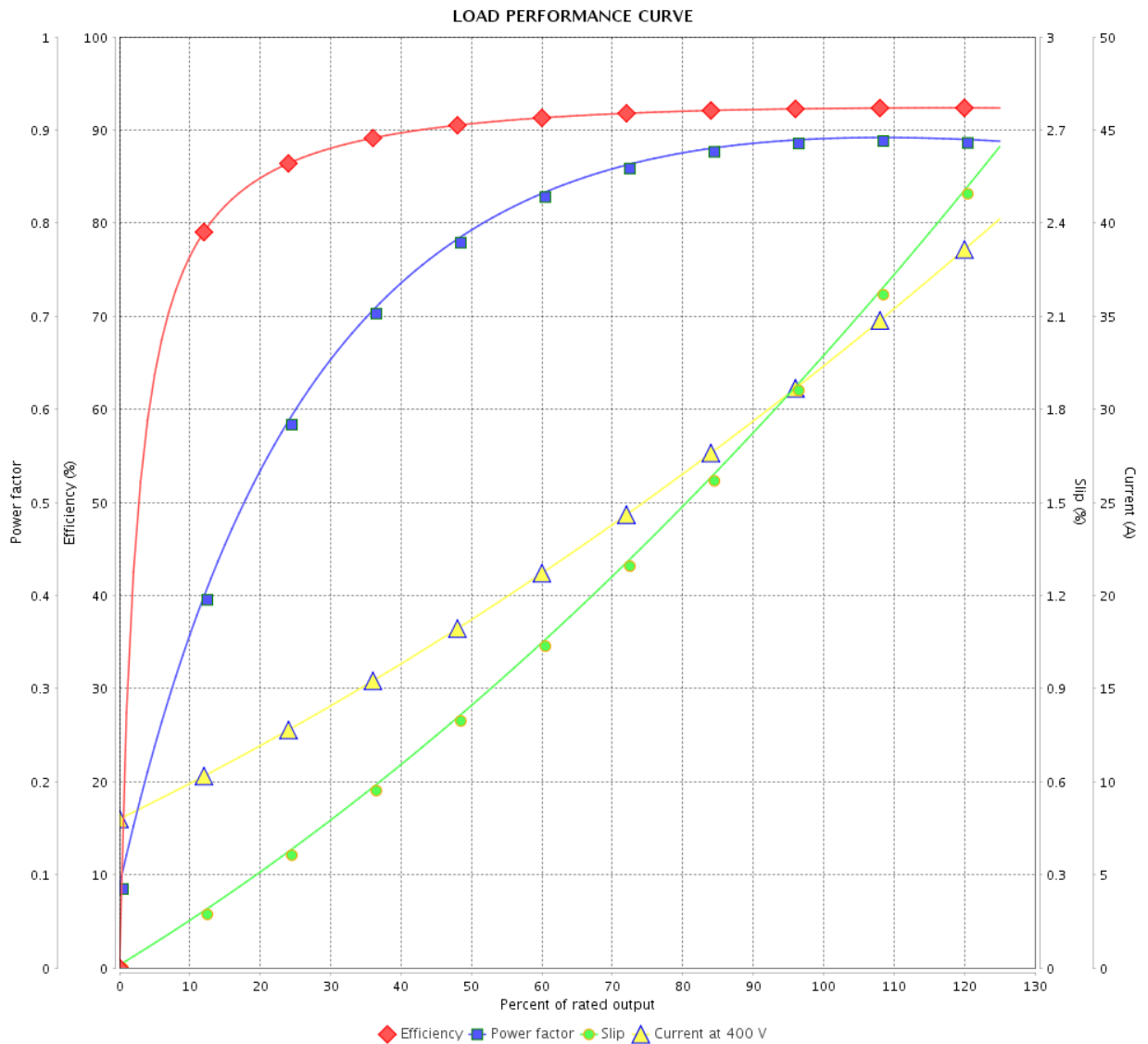

Performance : 400 V 50 Hz 2P IE3

Rated current : 32.5 A  
 LRC : 6.7  
 Rated torque : 44.7 ft.lb  
 Locked rotor torque : 220 %  
 Breakdown torque : 270 %  
 Rated speed : 2940 rpm

Moment of inertia (J) : 3.37 sq.ft.lb  
 Duty cycle : Cont.(S1)  
 Insulation class : F  
 Service factor : 1.00  
 Temperature rise : 80 K  
 Design : B

Rev.	Changes Summary	Performed	Checked	Date
Performed by		Page		Revision
Checked by		11 / 36		
Date		14/04/2022		

# LOAD PERFORMANCE CURVE

## Three Phase Induction Motor - Squirrel Cage



Customer :

Product line : NEMA Premium Efficiency Three-Phase

Product code : 11413120

Catalog # : 03036ET3E286TS-W22

LOAD PERFORMANCE CURVE

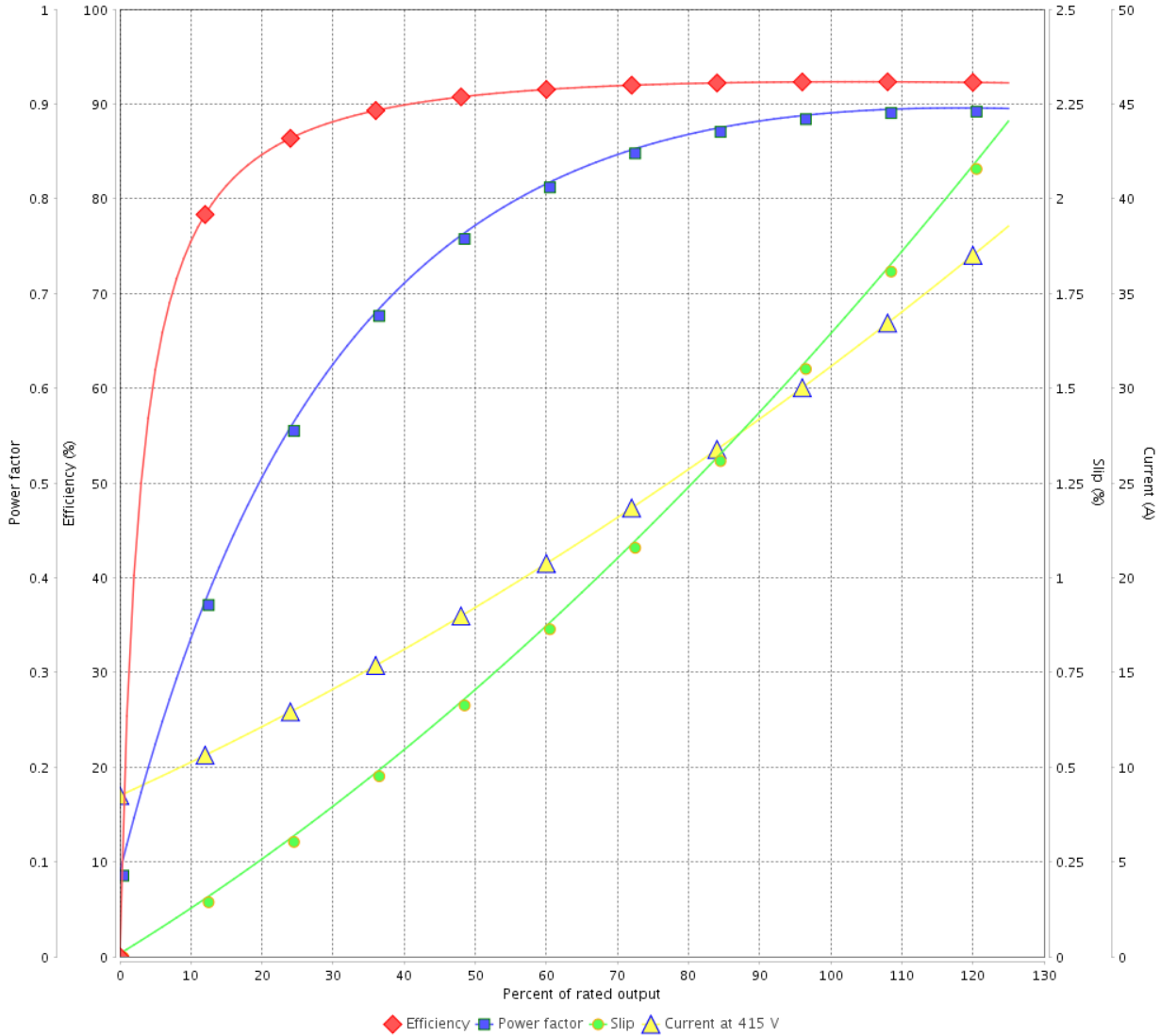

Performance : 415 V 50 Hz 2P IE3

Rated current : 31.3 A  
 LRC : 7.2  
 Rated torque : 44.5 ft.lb  
 Locked rotor torque : 229 %  
 Breakdown torque : 290 %  
 Rated speed : 2950 rpm

Moment of inertia (J) : 3.37 sq.ft.lb  
 Duty cycle : Cont.(S1)  
 Insulation class : F  
 Service factor : 1.00  
 Temperature rise : 80 K  
 Design : B

Rev.	Changes Summary	Performed	Checked	Date
Performed by			Page 12 / 36	Revision
Checked by				
Date	14/04/2022			

# LOAD PERFORMANCE CURVE

## Three Phase Induction Motor - Squirrel Cage



Customer :

Product line : NEMA Premium Efficiency Three-Phase

Product code : 11413120

Catalog # : 03036ET3E286TS-W22

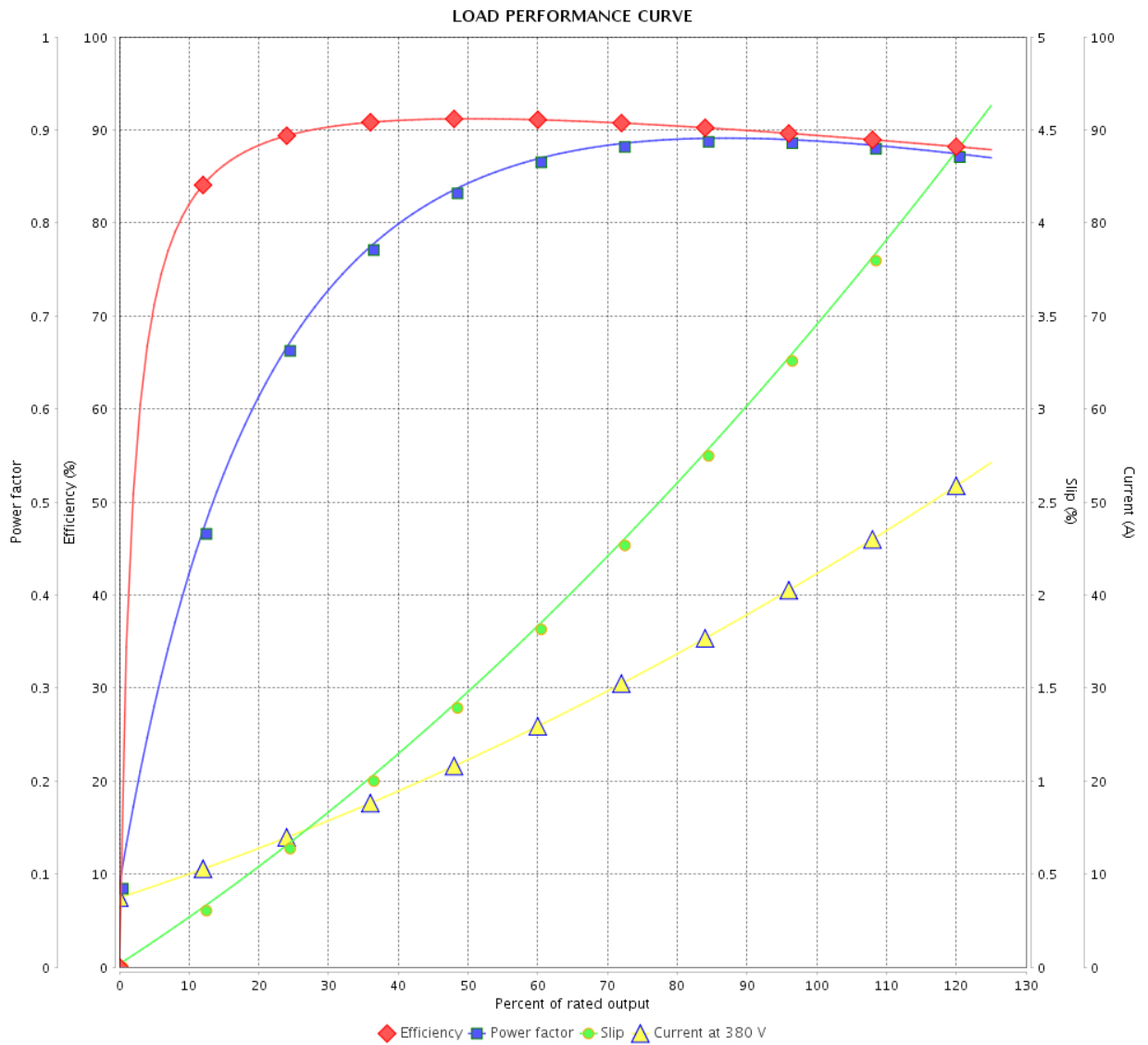

Performance : 380 V 50 Hz 2P

Rated current : 42.0 A  
 LRC : 4.9  
 Rated torque : 54.4 ft.lb  
 Locked rotor torque : 160 %  
 Breakdown torque : 190 %  
 Rated speed : 2895 rpm

Moment of inertia (J) : 3.37 sq.ft.lb  
 Duty cycle : Cont.(S1)  
 Insulation class : F  
 Service factor : 1.00  
 Temperature rise : 105 K  
 Design : B

Rev.	Changes Summary	Performed	Checked	Date
Performed by		Page		Revision
Checked by		13 / 36		
Date		14/04/2022		

# LOAD PERFORMANCE CURVE

Three Phase Induction Motor - Squirrel Cage



Customer :

Product line : NEMA Premium Efficiency Three-Phase

Product code : 11413120

Catalog # : 03036ET3E286TS-W22

LOAD PERFORMANCE CURVE

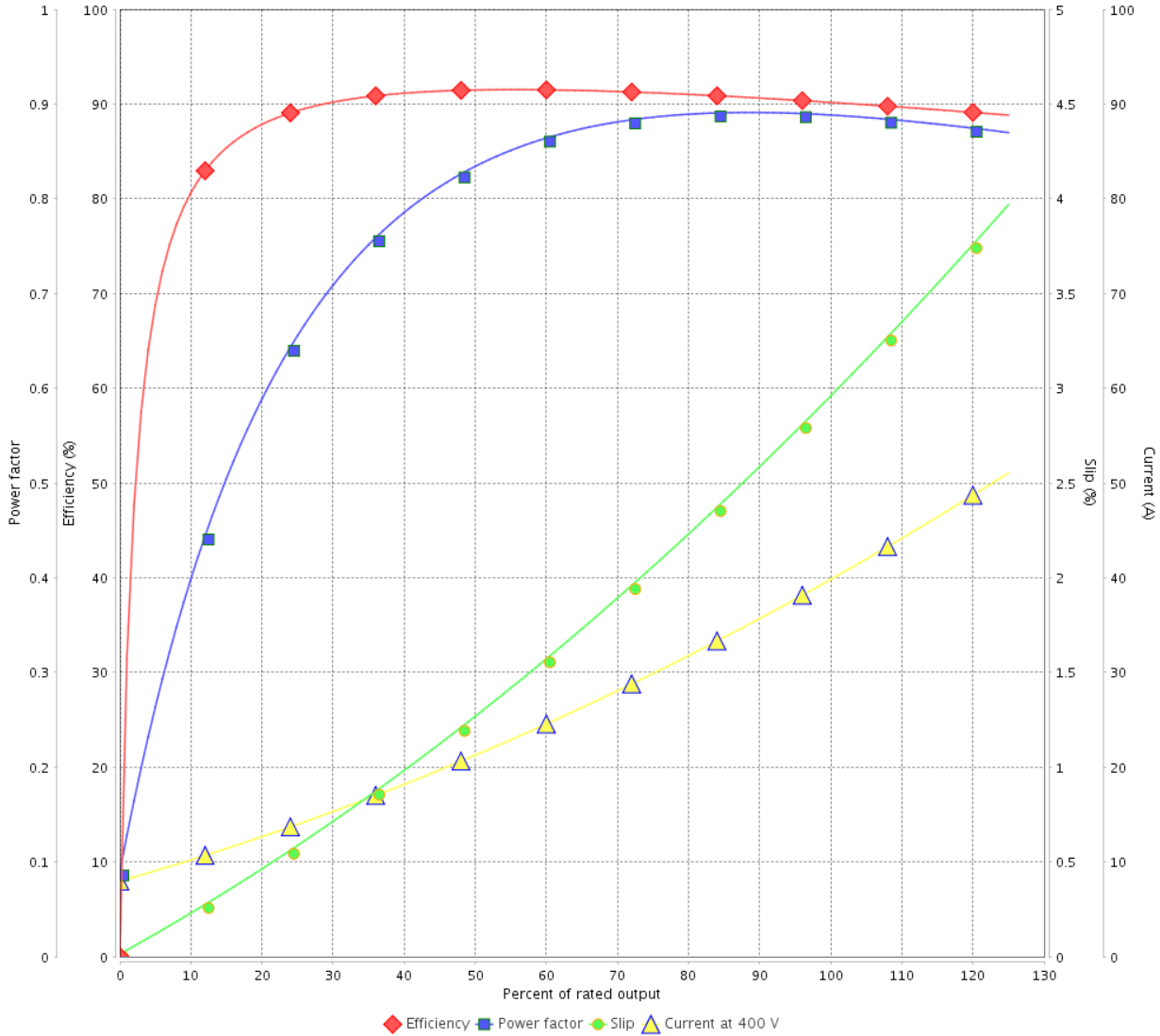

Performance : 400 V 50 Hz 2P IE1

Rated current : 39.6 A  
 LRC : 5.5  
 Rated torque : 54.1 ft.lb  
 Locked rotor torque : 180 %  
 Breakdown torque : 220 %  
 Rated speed : 2910 rpm

Moment of inertia (J) : 3.37 sq.ft.lb  
 Duty cycle : Cont.(S1)  
 Insulation class : F  
 Service factor : 1.00  
 Temperature rise : 105 K  
 Design : B

Rev.	Changes Summary	Performed	Checked	Date
Performed by			Page 14 / 36	Revision
Checked by				
Date	14/04/2022			

# LOAD PERFORMANCE CURVE

## Three Phase Induction Motor - Squirrel Cage



Customer :

Product line : NEMA Premium Efficiency Three-Phase

Product code : 11413120

Catalog # : 03036ET3E286TS-W22

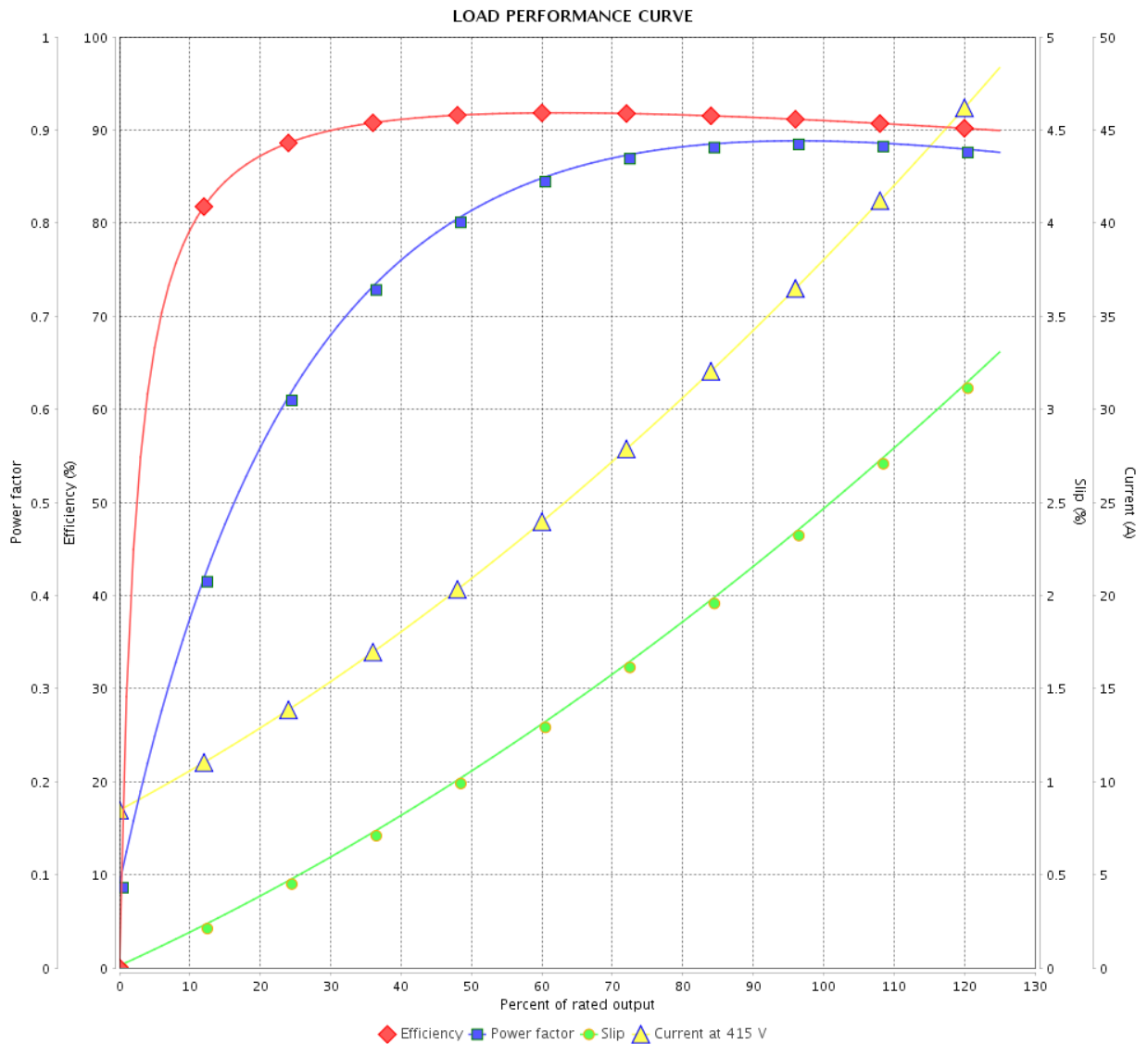

Performance : 415 V 50 Hz 2P IE1

Rated current : 37.8 A  
 LRC : 6.0  
 Rated torque : 53.9 ft.lb  
 Locked rotor torque : 190 %  
 Breakdown torque : 240 %  
 Rated speed : 2925 rpm

Moment of inertia (J) : 3.37 sq.ft.lb  
 Duty cycle : Cont.(S1)  
 Insulation class : F  
 Service factor : 1.00  
 Temperature rise : 105 K  
 Design : B

Rev.	Changes Summary	Performed	Checked	Date
Performed by		Page		Revision
Checked by		15 / 36		
Date		14/04/2022		

# THERMAL LIMIT CURVE



## Three Phase Induction Motor - Squirrel Cage

Customer :

Product line : NEMA Premium Efficiency Three-Phase  
Product code : 11413120  
Catalog # : 03036ET3E286TS-W22

Performance : 230/460 V 60 Hz 2P

Rated current	: 67.6/33.8 A	Moment of inertia (J)	: 3.37 sq.ft.lb
LRC	: 6.3	Duty cycle	: Cont.(S1)
Rated torque	: 44.6 ft.lb	Insulation class	: F
Locked rotor torque	: 200 %	Service factor	: 1.25
Breakdown torque	: 250 %	Temperature rise	: 80 K
Rated speed	: 3535 rpm	Design	: B

Heating constant

Cooling constant

Rev.	Changes Summary	Performed	Checked	Date
Performed by				
Checked by			Page	Revision
Date	14/04/2022		16 / 36	



# THERMAL LIMIT CURVE

Three Phase Induction Motor - Squirrel Cage



Customer : \_\_\_\_\_

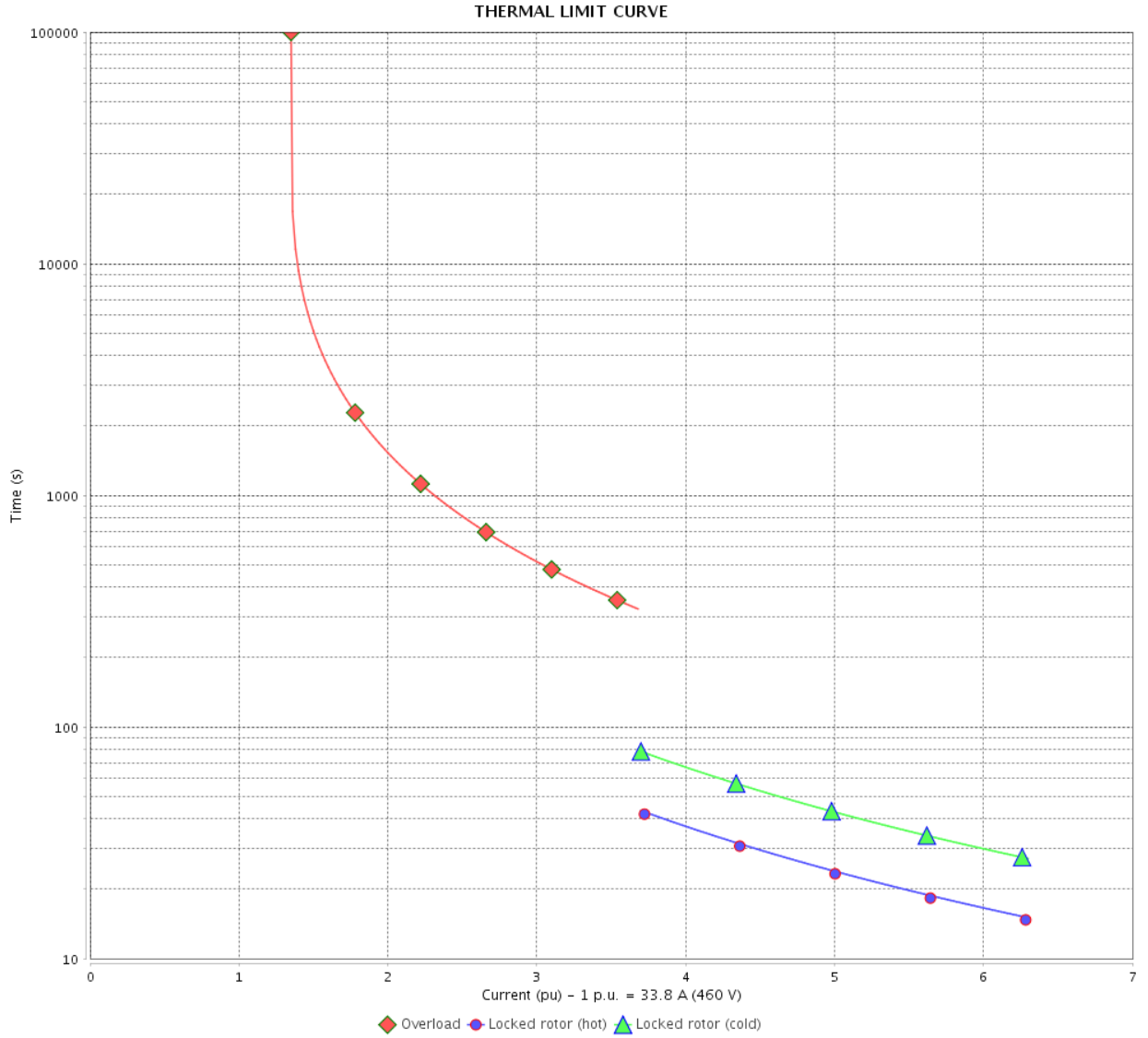

Rev.	Changes Summary	Performed	Checked	Date
Performed by		Page		Revision
Checked by		17 / 36		
Date		14/04/2022		

# THERMAL LIMIT CURVE



## Three Phase Induction Motor - Squirrel Cage

Customer :

Product line : NEMA Premium Efficiency Three-Phase  
Product code : 11413120  
Catalog # : 03036ET3E286TS-W22

Performance : 380 V 50 Hz 2P IE3

Rated current	: 34.2 A	Moment of inertia (J)	: 3.37 sq.ft.lb
LRC	: 5.9	Duty cycle	: Cont.(S1)
Rated torque	: 44.8 ft.lb	Insulation class	: F
Locked rotor torque	: 190 %	Service factor	: 1.00
Breakdown torque	: 229 %	Temperature rise	: 80 K
Rated speed	: 2930 rpm	Design	: B

Heating constant

Cooling constant

Rev.	Changes Summary	Performed	Checked	Date
Performed by				
Checked by			Page	Revision
Date	14/04/2022		18 / 36	

# THERMAL LIMIT CURVE

Three Phase Induction Motor - Squirrel Cage



Customer : \_\_\_\_\_

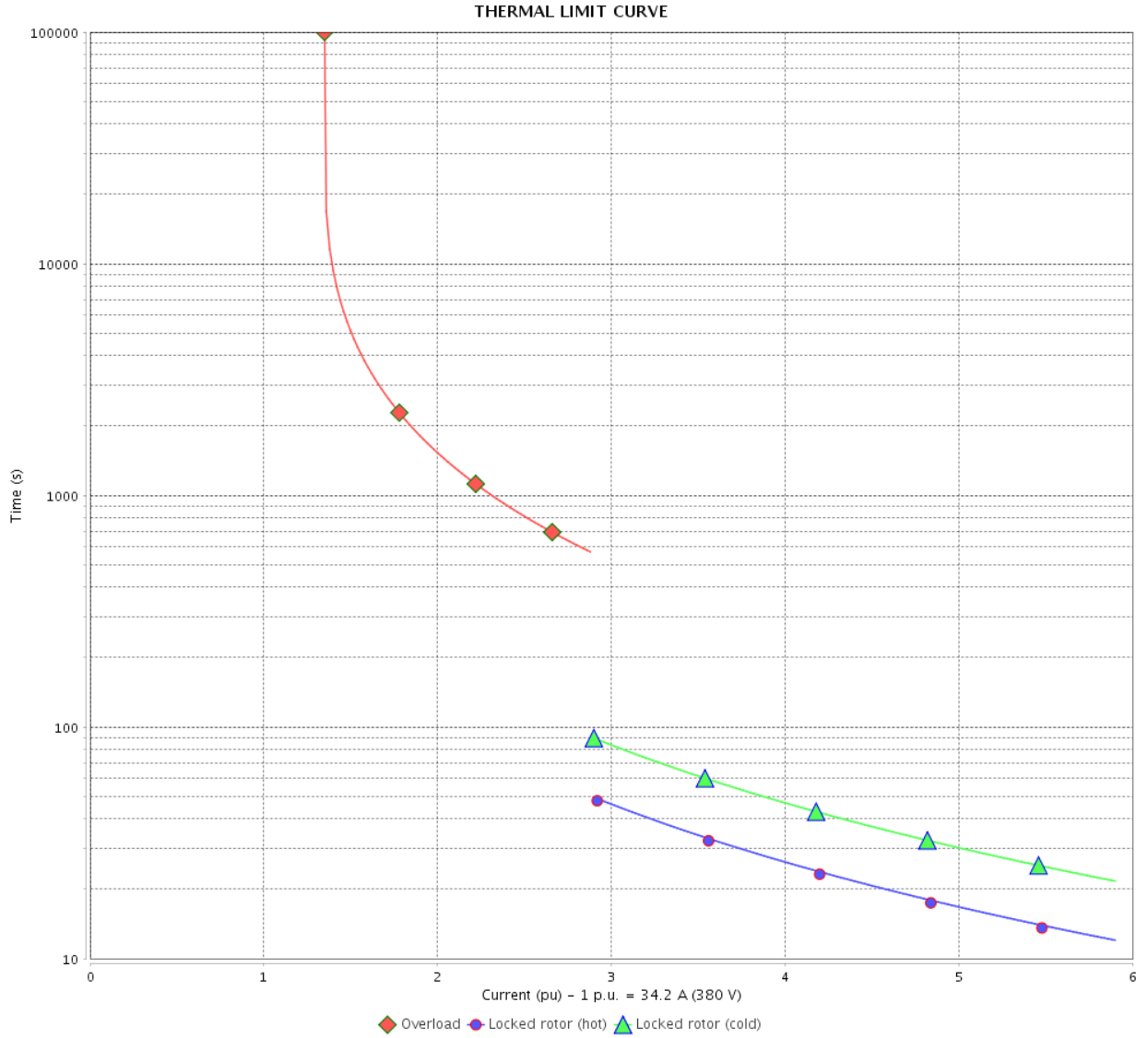

Rev.	Changes Summary	Performed	Checked	Date
Performed by				
Checked by				
Date				
			Page	Revision
			19 / 36	

# THERMAL LIMIT CURVE

## Three Phase Induction Motor - Squirrel Cage



Customer :

Product line : NEMA Premium Efficiency Three-Phase

Product code : 11413120

Catalog # : 03036ET3E286TS-W22

Performance : 400 V 50 Hz 2P IE3

Rated current	: 32.5 A	Moment of inertia (J)	: 3.37 sq.ft.lb
LRC	: 6.7	Duty cycle	: Cont.(S1)
Rated torque	: 44.7 ft.lb	Insulation class	: F
Locked rotor torque	: 220 %	Service factor	: 1.00
Breakdown torque	: 270 %	Temperature rise	: 80 K
Rated speed	: 2940 rpm	Design	: B

Heating constant

Cooling constant

Rev.	Changes Summary	Performed	Checked	Date
Performed by				
Checked by			Page	Revision
Date	14/04/2022		20 / 36	

# THERMAL LIMIT CURVE

Three Phase Induction Motor - Squirrel Cage



Customer : \_\_\_\_\_

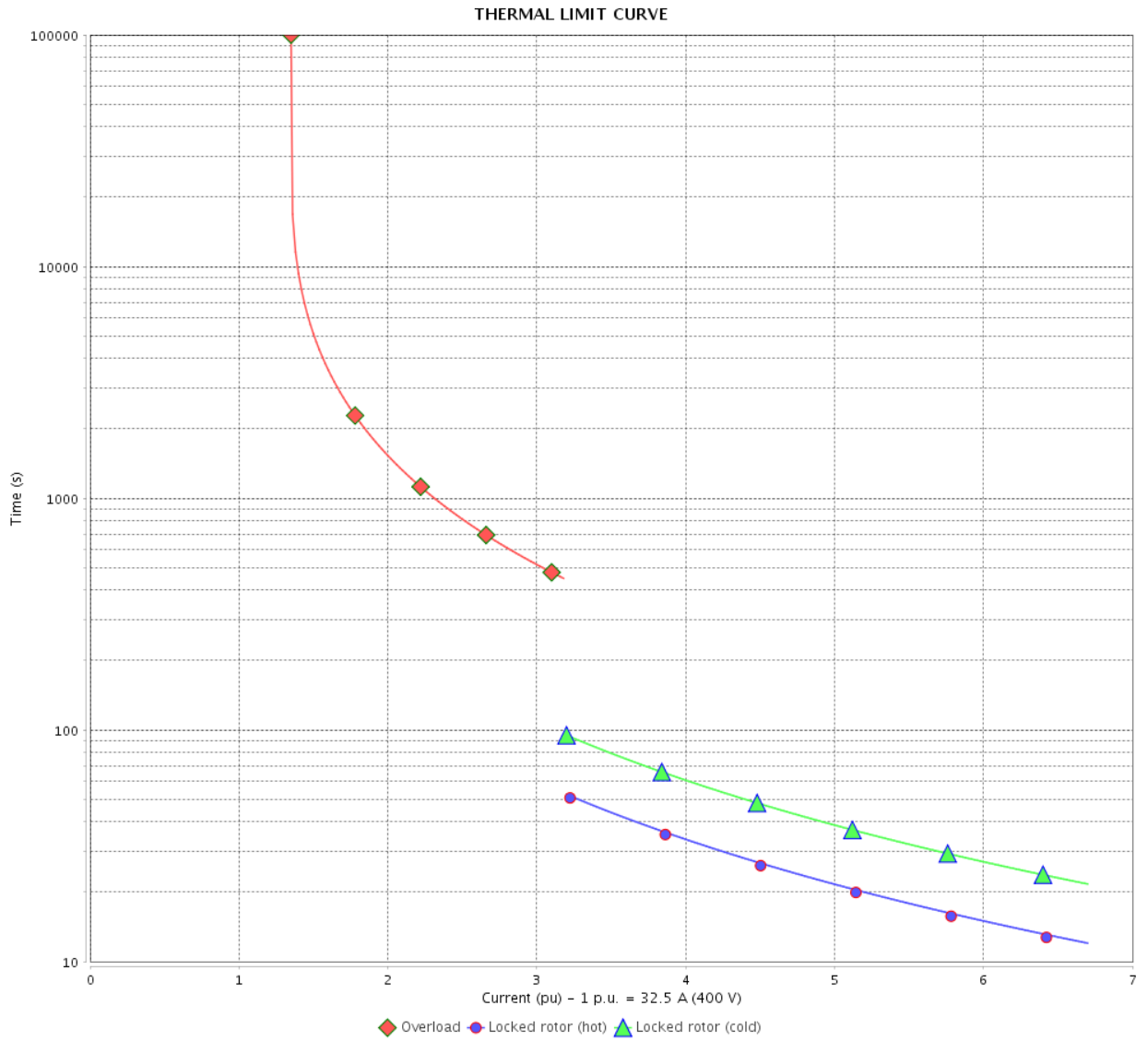

Rev.	Changes Summary	Performed	Checked	Date
Performed by		Page		Revision
Checked by		21 / 36		
Date		14/04/2022		

# THERMAL LIMIT CURVE

## Three Phase Induction Motor - Squirrel Cage



Customer :

Product line : NEMA Premium Efficiency Three-Phase

Product code : 11413120

Catalog # : 03036ET3E286TS-W22

Performance : 415 V 50 Hz 2P IE3

Rated current	: 31.3 A	Moment of inertia (J)	: 3.37 sq.ft.lb
LRC	: 7.2	Duty cycle	: Cont.(S1)
Rated torque	: 44.5 ft.lb	Insulation class	: F
Locked rotor torque	: 229 %	Service factor	: 1.00
Breakdown torque	: 290 %	Temperature rise	: 80 K
Rated speed	: 2950 rpm	Design	: B

Heating constant

Cooling constant

Rev.	Changes Summary	Performed	Checked	Date
Performed by				
Checked by			Page	Revision
Date	14/04/2022		22 / 36	

# THERMAL LIMIT CURVE

Three Phase Induction Motor - Squirrel Cage



Customer : \_\_\_\_\_

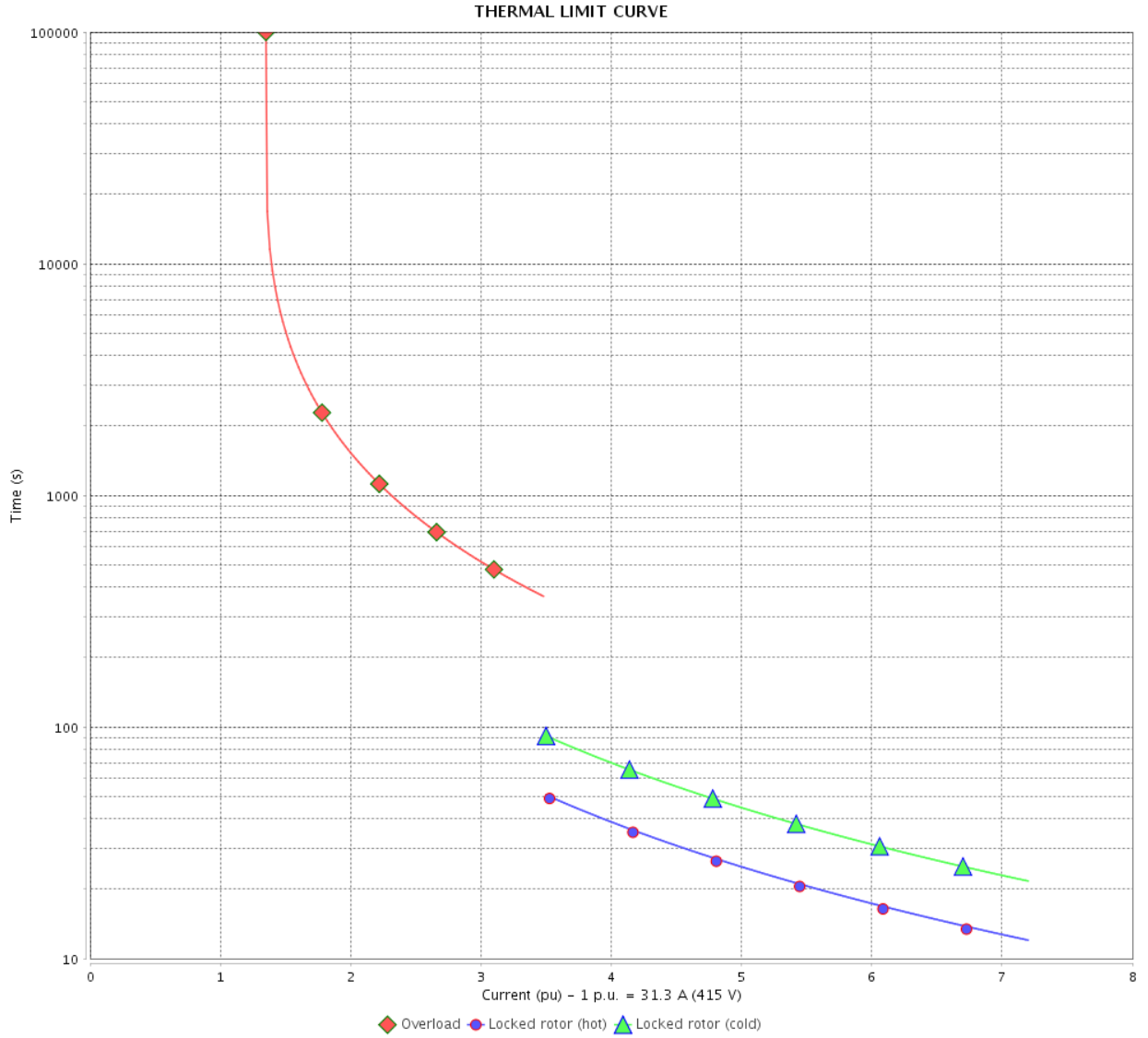

Rev.	Changes Summary	Performed	Checked	Date
Performed by		Page 23 / 36		Revision
Checked by				
Date				

# THERMAL LIMIT CURVE

## Three Phase Induction Motor - Squirrel Cage



Customer :

Product line : NEMA Premium Efficiency Three-Phase

Product code : 11413120

Catalog # : 03036ET3E286TS-W22

Performance : 380 V 50 Hz 2P

Rated current	: 42.0 A	Moment of inertia (J)	: 3.37 sq.ft.lb
LRC	: 4.9	Duty cycle	: Cont.(S1)
Rated torque	: 54.4 ft.lb	Insulation class	: F
Locked rotor torque	: 160 %	Service factor	: 1.00
Breakdown torque	: 190 %	Temperature rise	: 105 K
Rated speed	: 2895 rpm	Design	: B

Heating constant

Cooling constant

Rev.	Changes Summary	Performed	Checked	Date
Performed by				
Checked by			Page	Revision
Date	14/04/2022		24 / 36	



# THERMAL LIMIT CURVE

Three Phase Induction Motor - Squirrel Cage



Customer : \_\_\_\_\_

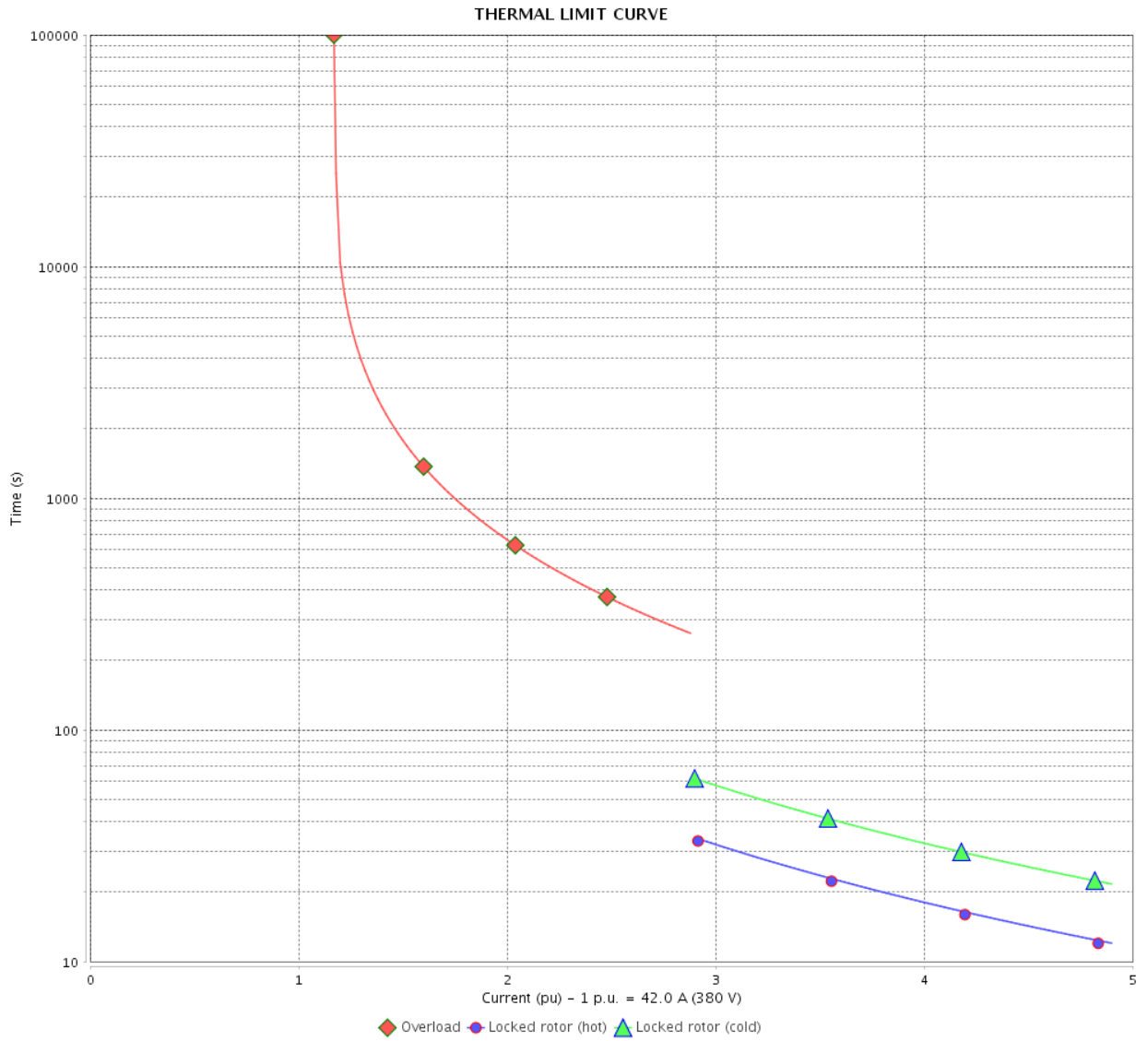

Rev.	Changes Summary	Performed	Checked	Date
Performed by		Page		Revision
Checked by		25 / 36		
Date		14/04/2022		

# THERMAL LIMIT CURVE



## Three Phase Induction Motor - Squirrel Cage

Customer :

Product line : NEMA Premium Efficiency Three-Phase  
 Product code : 11413120  
 Catalog # : 03036ET3E286TS-W22

Performance : 400 V 50 Hz 2P IE1

Rated current : 39.6 A	Moment of inertia (J) : 3.37 sq.ft.lb
LRC : 5.5	Duty cycle : Cont.(S1)
Rated torque : 54.1 ft.lb	Insulation class : F
Locked rotor torque : 180 %	Service factor : 1.00
Breakdown torque : 220 %	Temperature rise : 105 K
Rated speed : 2910 rpm	Design : B

Heating constant

Cooling constant

Rev.	Changes Summary	Performed	Checked	Date
Performed by			Page 26 / 36	Revision
Checked by				
Date	14/04/2022			

# THERMAL LIMIT CURVE

Three Phase Induction Motor - Squirrel Cage



Customer : \_\_\_\_\_

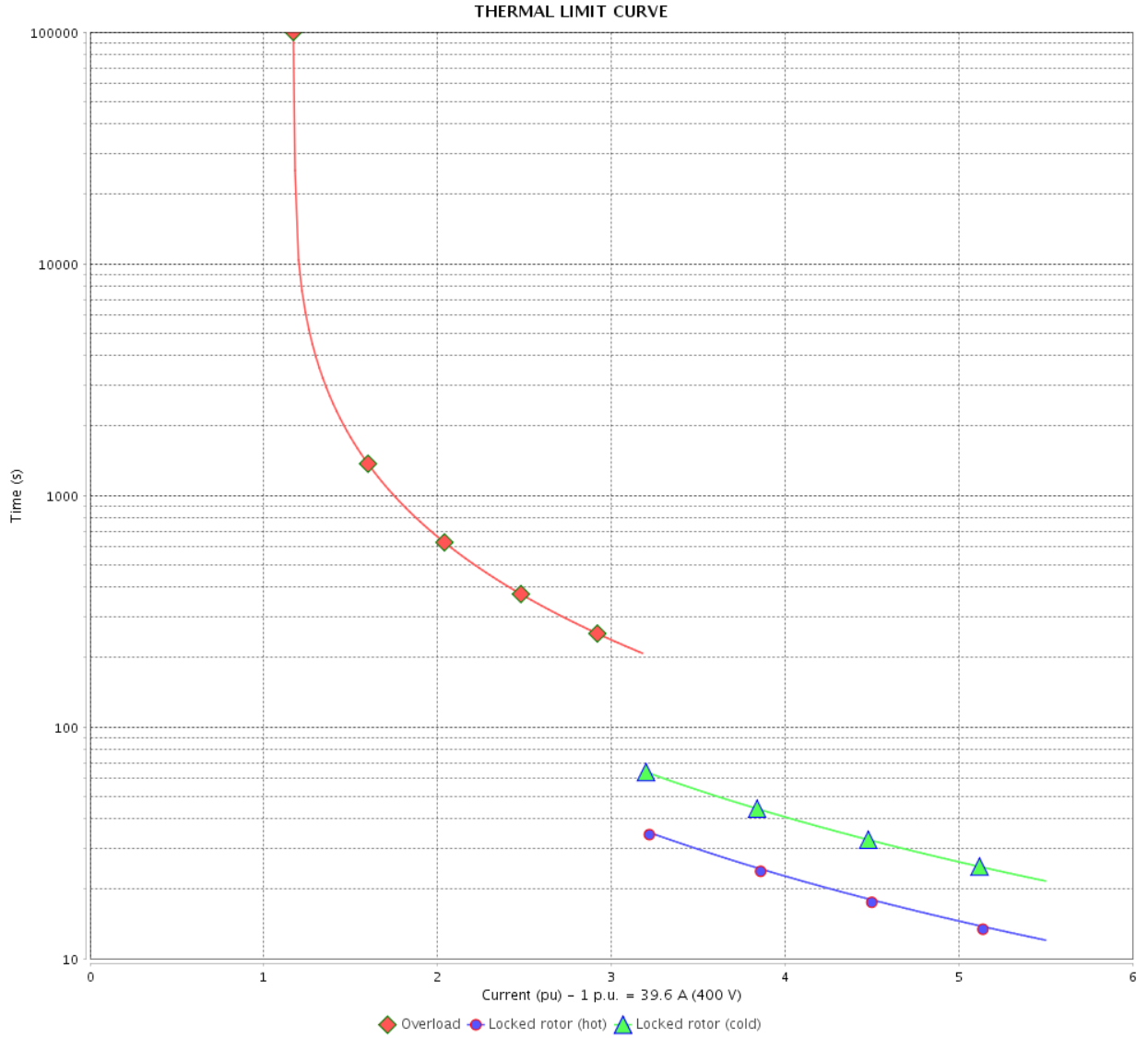

Rev.	Changes Summary	Performed	Checked	Date
Performed by		Page		Revision
Checked by		27 / 36		
Date		14/04/2022		

# THERMAL LIMIT CURVE

## Three Phase Induction Motor - Squirrel Cage



Customer :

Product line : NEMA Premium Efficiency Three-Phase  
Product code : 11413120  
Catalog # : 03036ET3E286TS-W22

Performance : 415 V 50 Hz 2P IE1

Rated current	: 37.8 A	Moment of inertia (J)	: 3.37 sq.ft.lb
LRC	: 6.0	Duty cycle	: Cont.(S1)
Rated torque	: 53.9 ft.lb	Insulation class	: F
Locked rotor torque	: 190 %	Service factor	: 1.00
Breakdown torque	: 240 %	Temperature rise	: 105 K
Rated speed	: 2925 rpm	Design	: B

Heating constant

Cooling constant

Rev.	Changes Summary	Performed	Checked	Date
Performed by				
Checked by			Page	Revision
Date	14/04/2022		28 / 36	

# THERMAL LIMIT CURVE

Three Phase Induction Motor - Squirrel Cage



Customer : \_\_\_\_\_

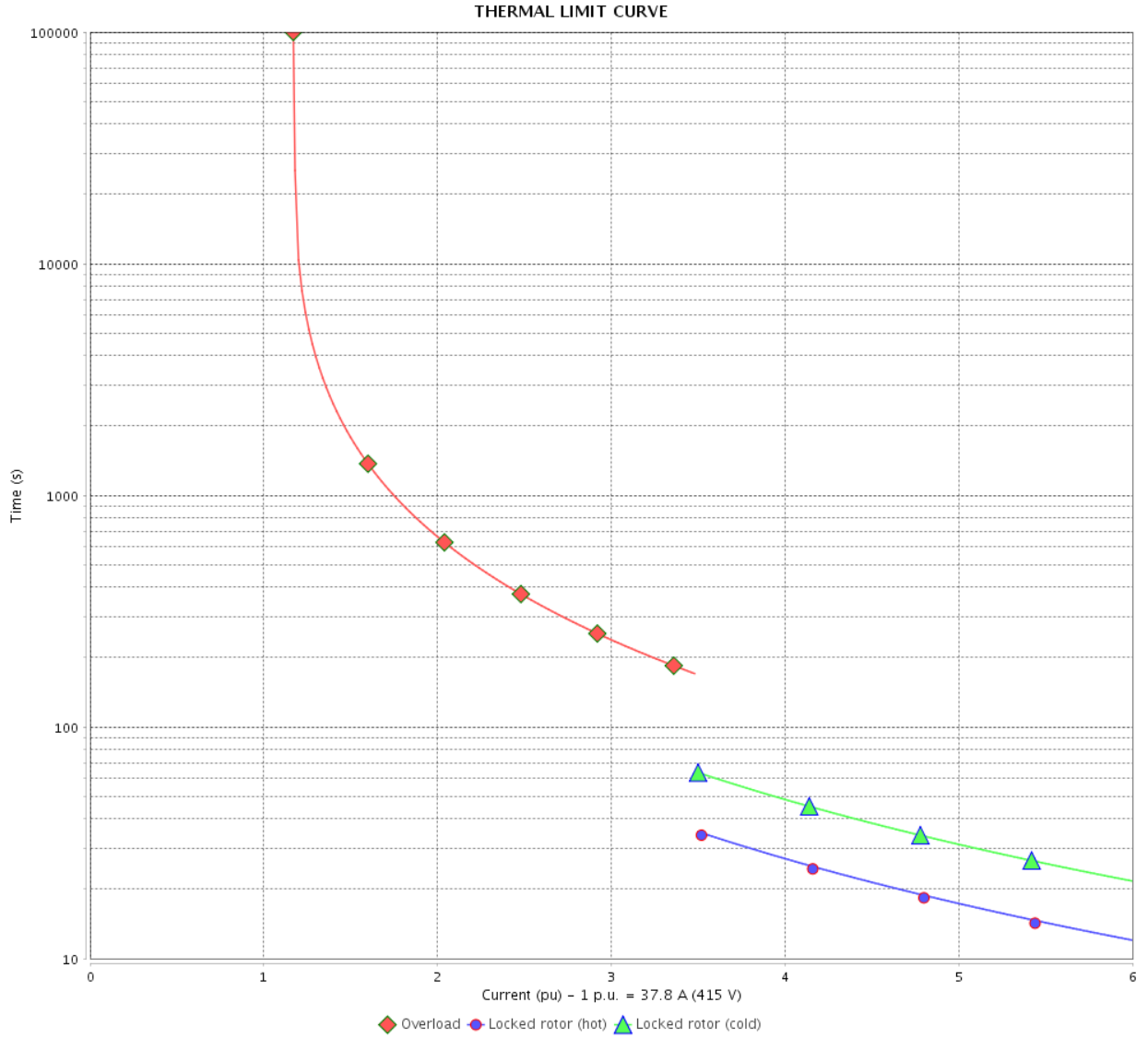

Rev.	Changes Summary	Performed	Checked	Date
Performed by		Page		Revision
Checked by				
Date				

# VFD OPERATION CURVE

Three Phase Induction Motor - Squirrel Cage



Customer :

Product line : NEMA Premium Efficiency Three-Phase

Product code : 11413120

Catalog # : 03036ET3E286TS-W22

VFD OPERATION CURVE

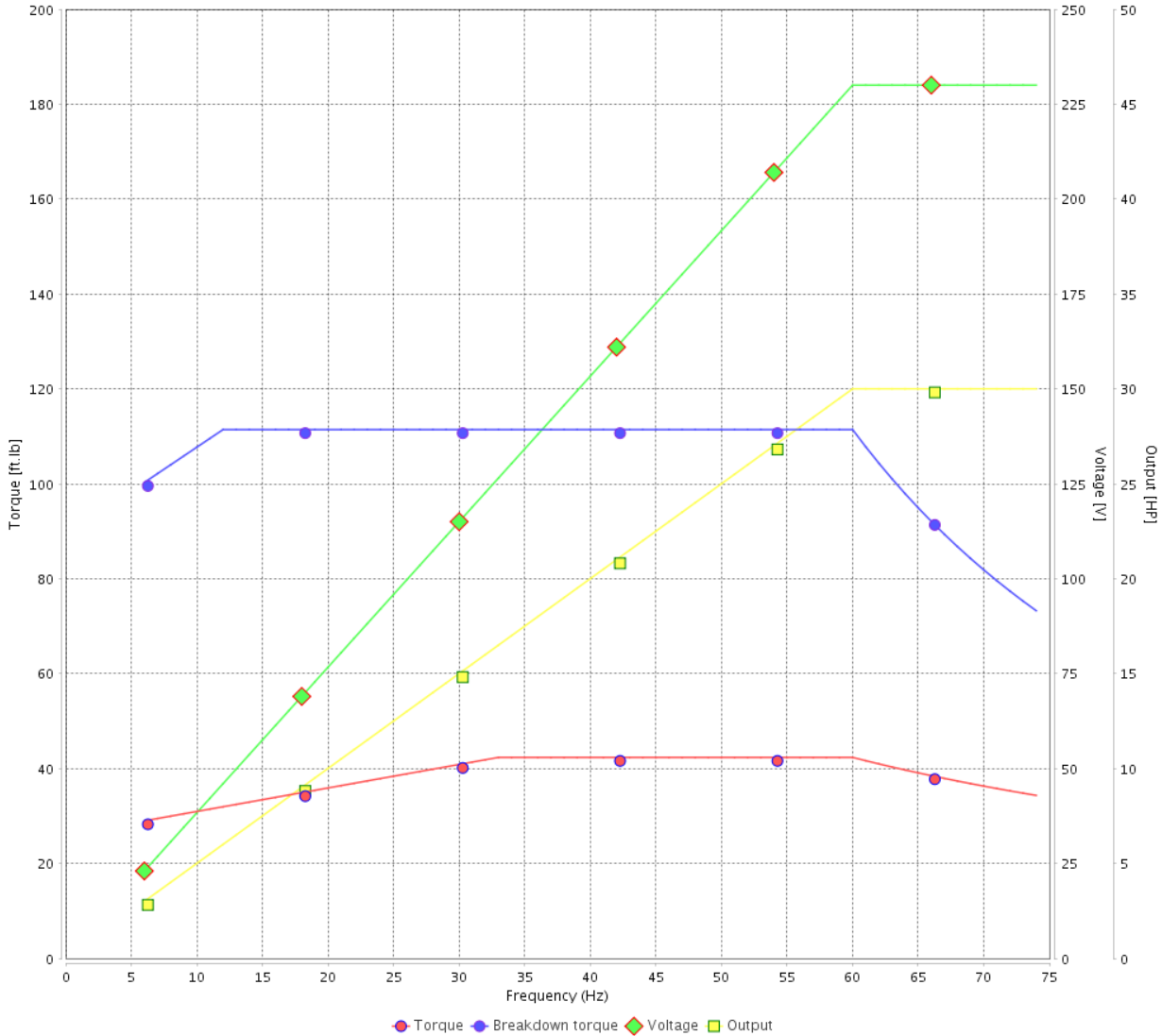

Performance : 230/460 V 60 Hz 2P

Rated current : 67.6/33.8 A  
 LRC : 6.3  
 Rated torque : 44.6 ft.lb  
 Locked rotor torque : 200 %  
 Breakdown torque : 250 %  
 Rated speed : 3535 rpm

Moment of inertia (J) : 3.37 sq.ft.lb  
 Duty cycle : Cont.(S1)  
 Insulation class : F  
 Service factor : 1.25  
 Temperature rise : 80 K  
 Design : B

Rev.	Changes Summary	Performed	Checked	Date
Performed by			Page 30 / 36	Revision
Checked by				
Date	14/04/2022			

# VFD OPERATION CURVE

## Three Phase Induction Motor - Squirrel Cage



Customer :

Product line : NEMA Premium Efficiency Three-Phase

Product code : 11413120

Catalog # : 03036ET3E286TS-W22

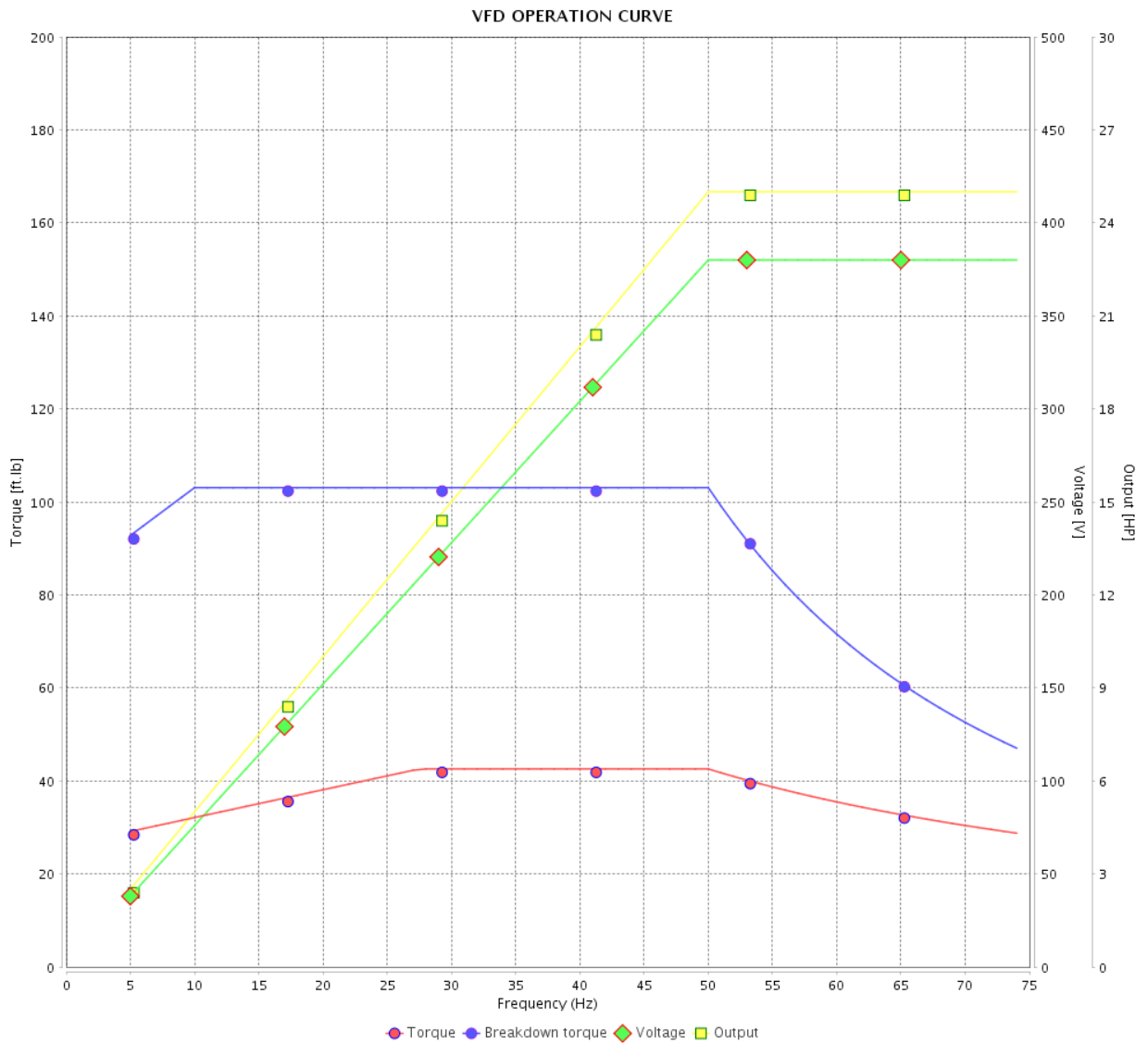

Performance : 380 V 50 Hz 2P IE3

Rated current : 34.2 A  
 LRC : 5.9  
 Rated torque : 44.8 ft.lb  
 Locked rotor torque : 190 %  
 Breakdown torque : 229 %  
 Rated speed : 2930 rpm

Moment of inertia (J) : 3.37 sq.ft.lb  
 Duty cycle : Cont.(S1)  
 Insulation class : F  
 Service factor : 1.00  
 Temperature rise : 80 K  
 Design : B

Rev.	Changes Summary	Performed	Checked	Date
Performed by			Page	Revision
Checked by				
Date				
			31 / 36	

# VFD OPERATION CURVE

Three Phase Induction Motor - Squirrel Cage



Customer : \_\_\_\_\_

Product line : NEMA Premium Efficiency Three-Phase

Product code : 11413120

Catalog # : 03036ET3E286TS-W22

VFD OPERATION CURVE

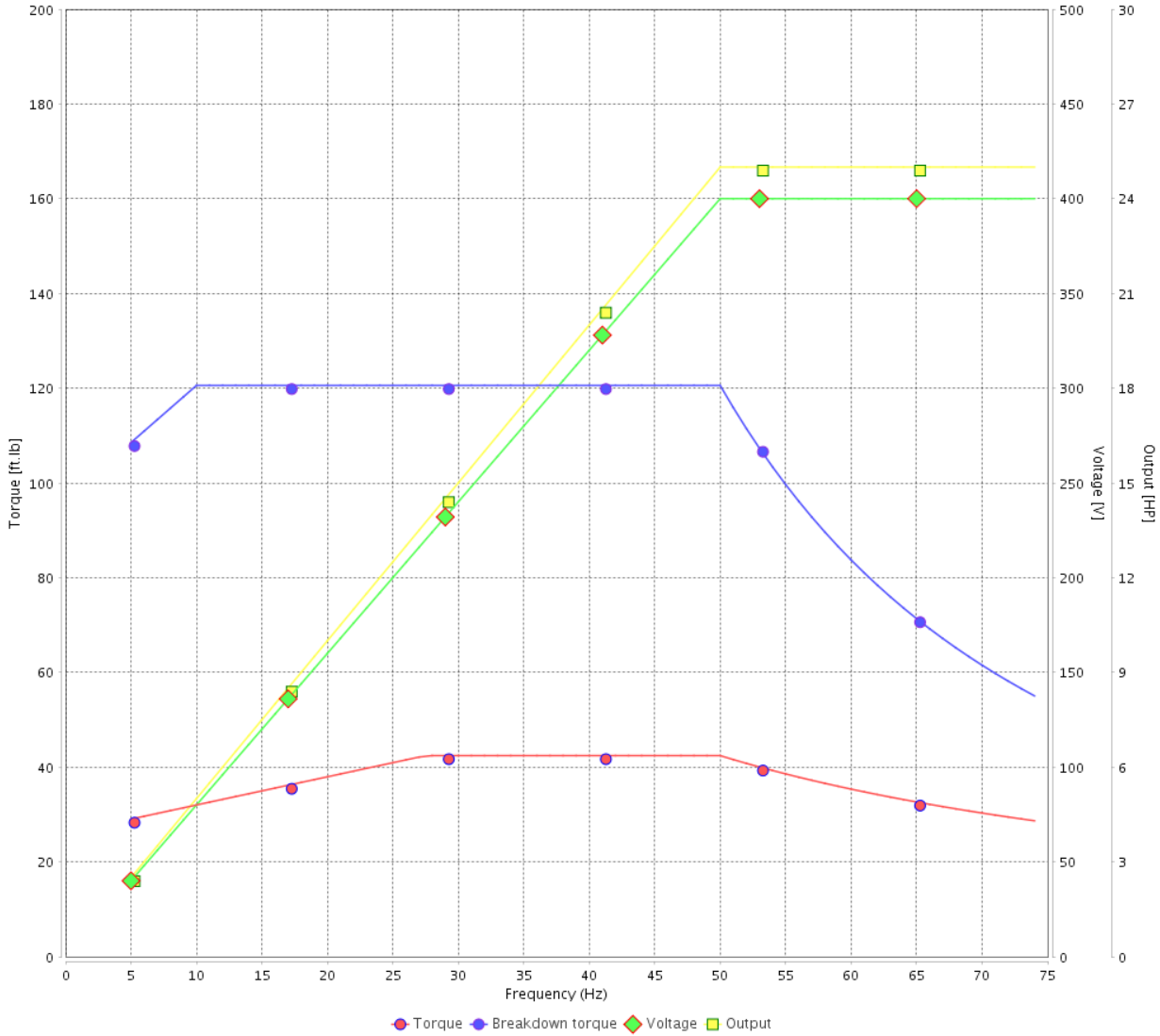

Performance : 400 V 50 Hz 2P IE3

Rated current : 32.5 A  
 LRC : 6.7  
 Rated torque : 44.7 ft.lb  
 Locked rotor torque : 220 %  
 Breakdown torque : 270 %  
 Rated speed : 2940 rpm

Moment of inertia (J) : 3.37 sq.ft.lb  
 Duty cycle : Cont.(S1)  
 Insulation class : F  
 Service factor : 1.00  
 Temperature rise : 80 K  
 Design : B

Rev.	Changes Summary	Performed	Checked	Date
Performed by			Page	Revision
Checked by				
Date				



# VFD OPERATION CURVE

## Three Phase Induction Motor - Squirrel Cage



Customer : \_\_\_\_\_

Product line : NEMA Premium Efficiency Three-Phase

Product code : 11413120

Catalog # : 03036ET3E286TS-W22

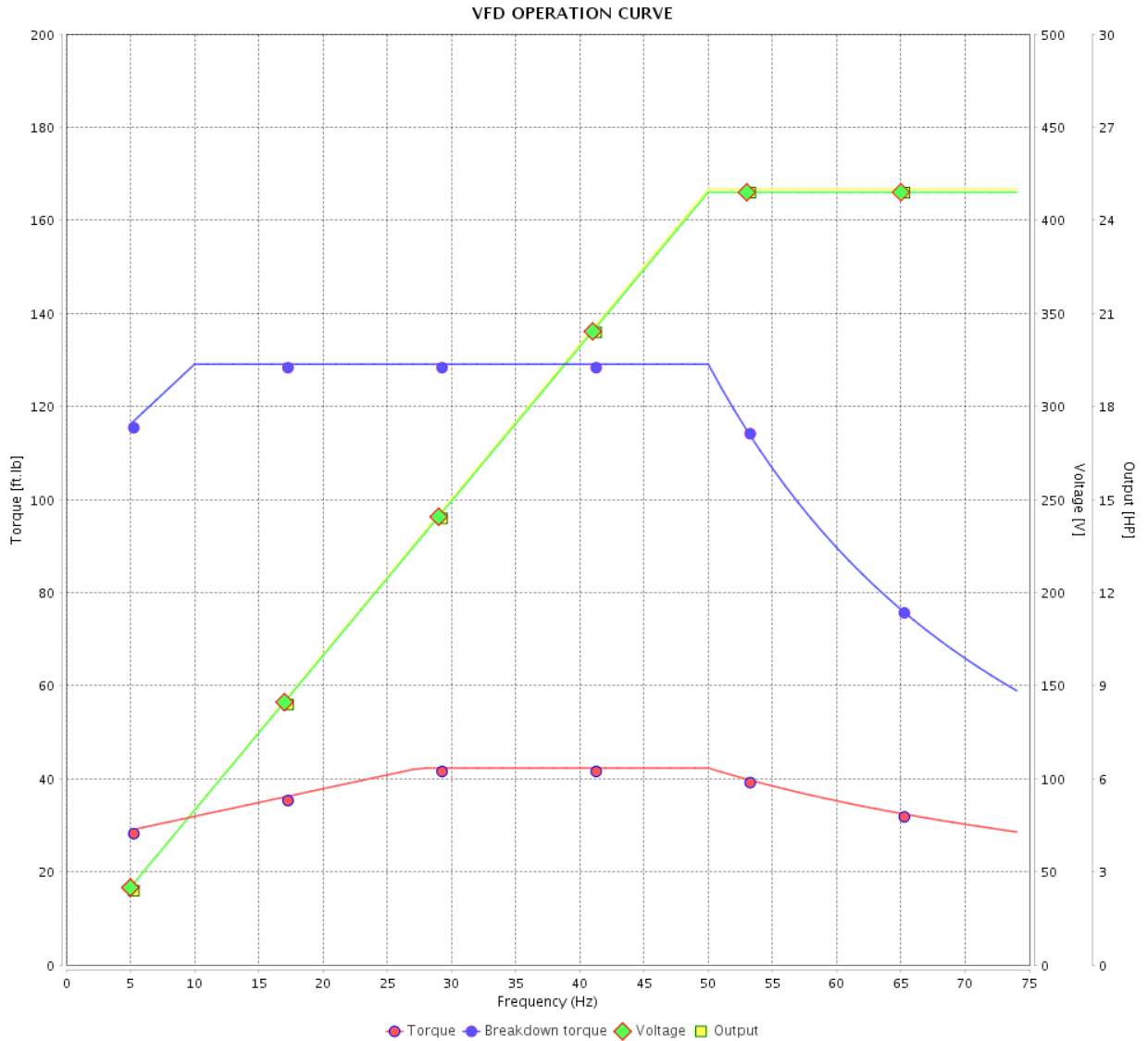

Performance : 415 V 50 Hz 2P IE3

Rated current : 31.3 A  
 LRC : 7.2  
 Rated torque : 44.5 ft.lb  
 Locked rotor torque : 229 %  
 Breakdown torque : 290 %  
 Rated speed : 2950 rpm

Moment of inertia (J) : 3.37 sq.ft.lb  
 Duty cycle : Cont.(S1)  
 Insulation class : F  
 Service factor : 1.00  
 Temperature rise : 80 K  
 Design : B

Rev.	Changes Summary	Performed	Checked	Date
Performed by			Page	Revision
Checked by				
Date				

# VFD OPERATION CURVE

Three Phase Induction Motor - Squirrel Cage



Customer : \_\_\_\_\_

Product line : NEMA Premium Efficiency Three-Phase

Product code : 11413120

Catalog # : 03036ET3E286TS-W22

VFD OPERATION CURVE

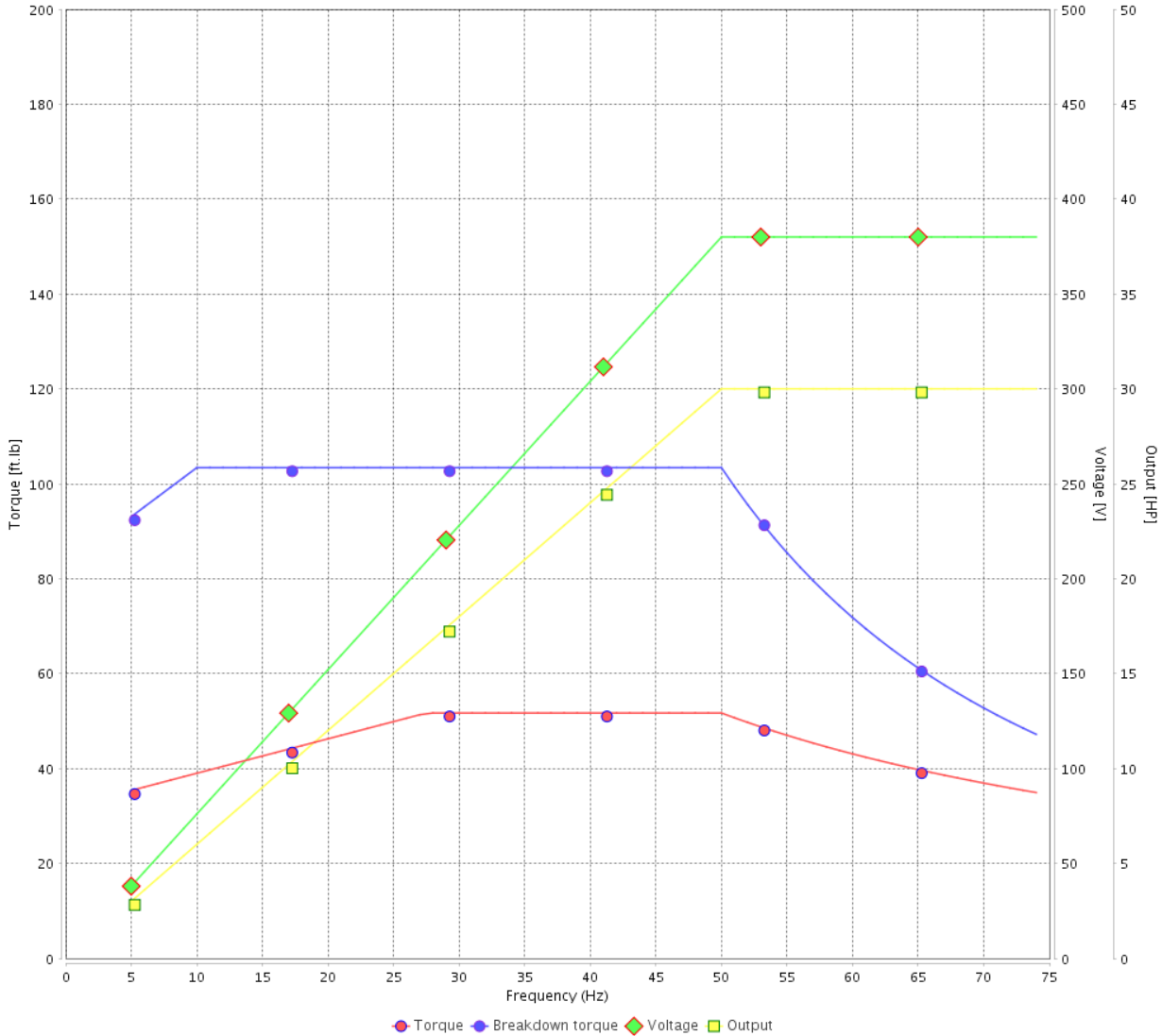

Performance : 380 V 50 Hz 2P

Rated current : 42.0 A  
 LRC : 4.9  
 Rated torque : 54.4 ft.lb  
 Locked rotor torque : 160 %  
 Breakdown torque : 190 %  
 Rated speed : 2895 rpm

Moment of inertia (J) : 3.37 sq.ft.lb  
 Duty cycle : Cont.(S1)  
 Insulation class : F  
 Service factor : 1.00  
 Temperature rise : 105 K  
 Design : B

Rev.	Changes Summary	Performed	Checked	Date
Performed by			Page	Revision
Checked by				
Date				

# VFD OPERATION CURVE

## Three Phase Induction Motor - Squirrel Cage



Customer :

Product line : NEMA Premium Efficiency Three-Phase

Product code : 11413120

Catalog # : 03036ET3E286TS-W22

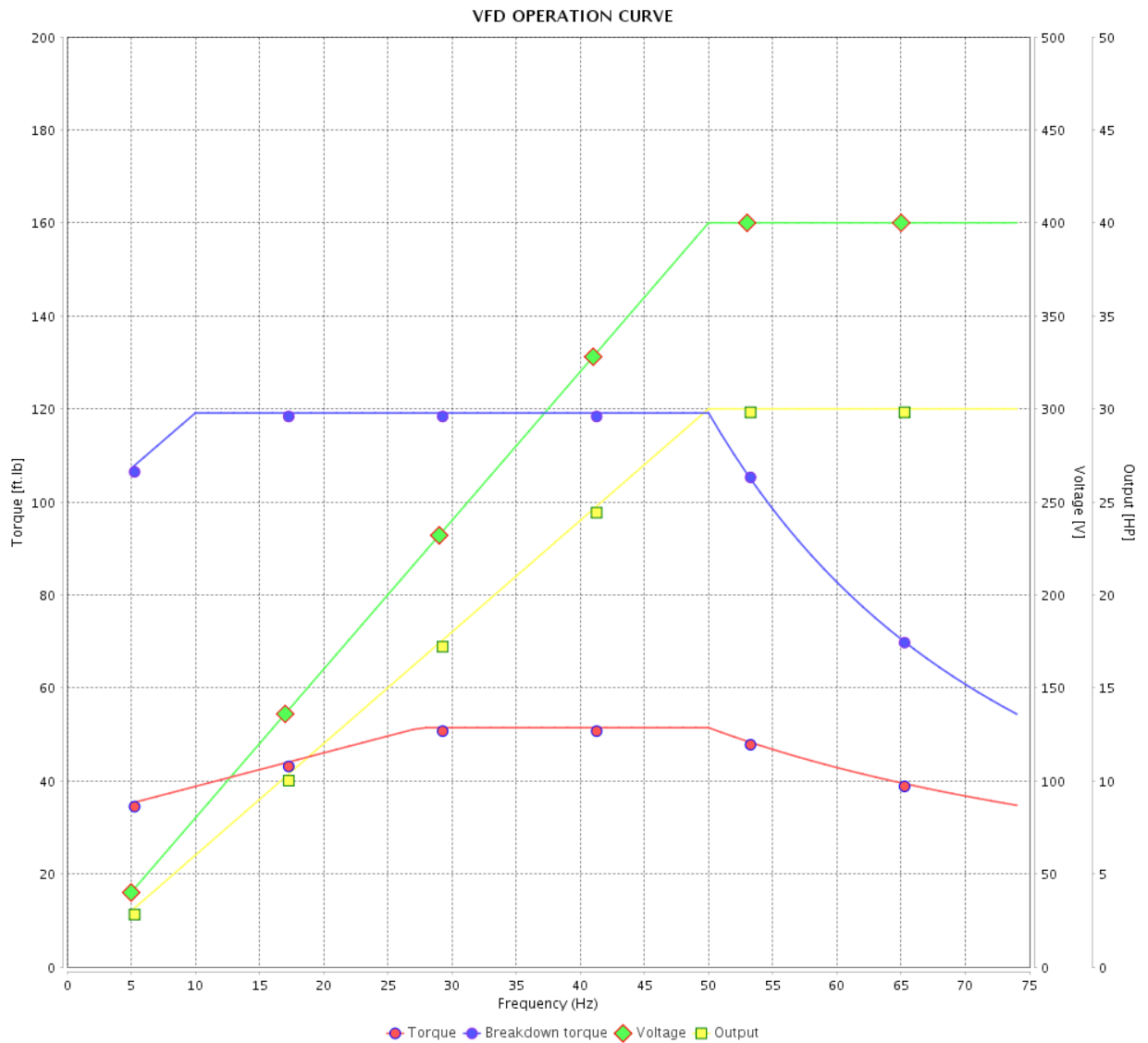

Performance : 400 V 50 Hz 2P IE1

Rated current : 39.6 A  
 LRC : 5.5  
 Rated torque : 54.1 ft.lb  
 Locked rotor torque : 180 %  
 Breakdown torque : 220 %  
 Rated speed : 2910 rpm

Moment of inertia (J) : 3.37 sq.ft.lb  
 Duty cycle : Cont.(S1)  
 Insulation class : F  
 Service factor : 1.00  
 Temperature rise : 105 K  
 Design : B

Rev.	Changes Summary	Performed	Checked	Date
Performed by		Page		Revision
Checked by		35 / 36		
Date		14/04/2022		

# VFD OPERATION CURVE

Three Phase Induction Motor - Squirrel Cage



Customer :

Product line : NEMA Premium Efficiency Three-Phase

Product code : 11413120

Catalog # : 03036ET3E286TS-W22

VFD OPERATION CURVE

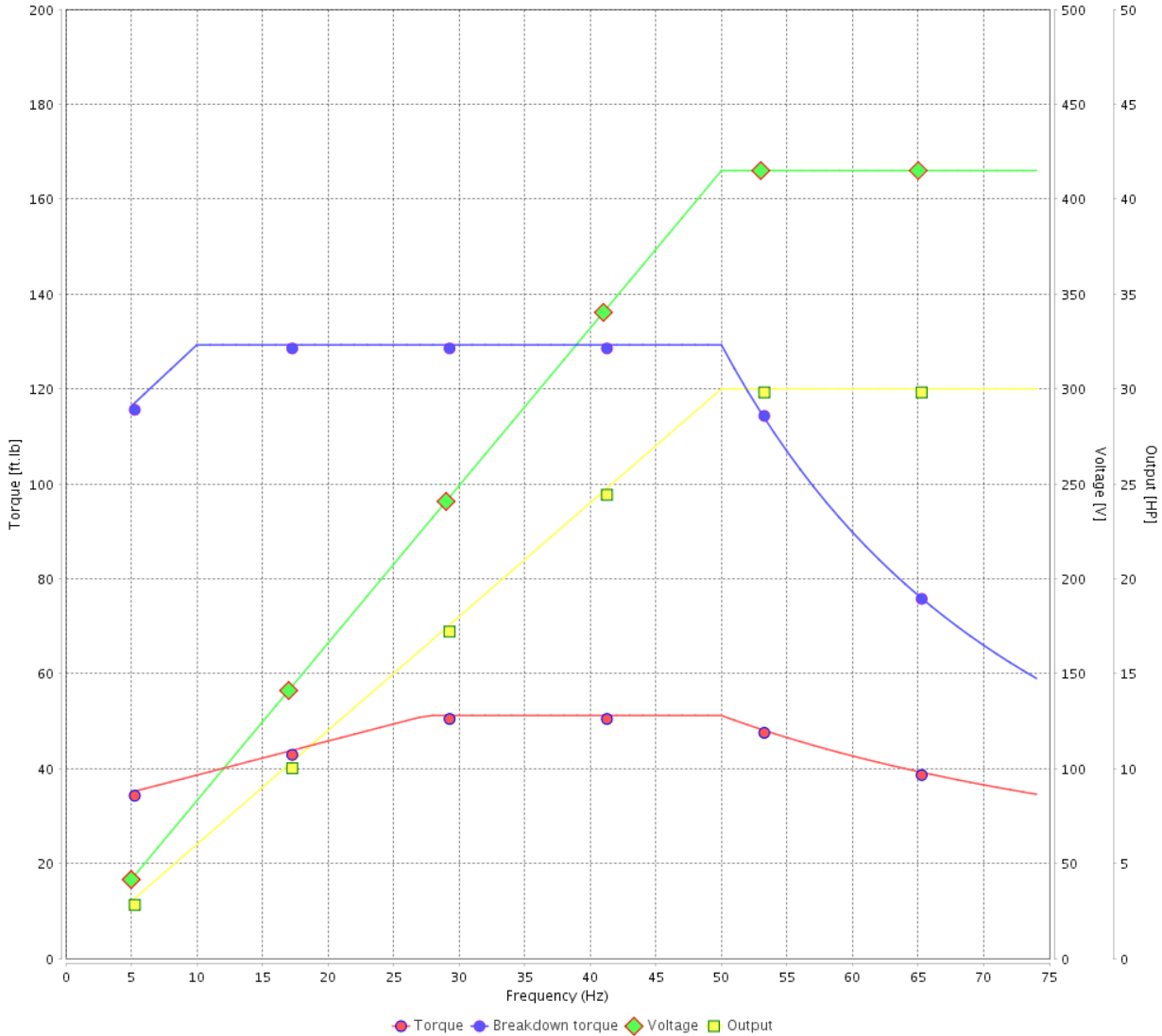

Performance : 415 V 50 Hz 2P IE1

Rated current : 37.8 A  
 LRC : 6.0  
 Rated torque : 53.9 ft.lb  
 Locked rotor torque : 190 %  
 Breakdown torque : 240 %  
 Rated speed : 2925 rpm

Moment of inertia (J) : 3.37 sq.ft.lb  
 Duty cycle : Cont.(S1)  
 Insulation class : F  
 Service factor : 1.00  
 Temperature rise : 105 K  
 Design : B

Rev.	Changes Summary	Performed	Checked	Date
Performed by			Page 36 / 36	Revision
Checked by				
Date	14/04/2022			

1 2 3 4 5 6

A

B

C

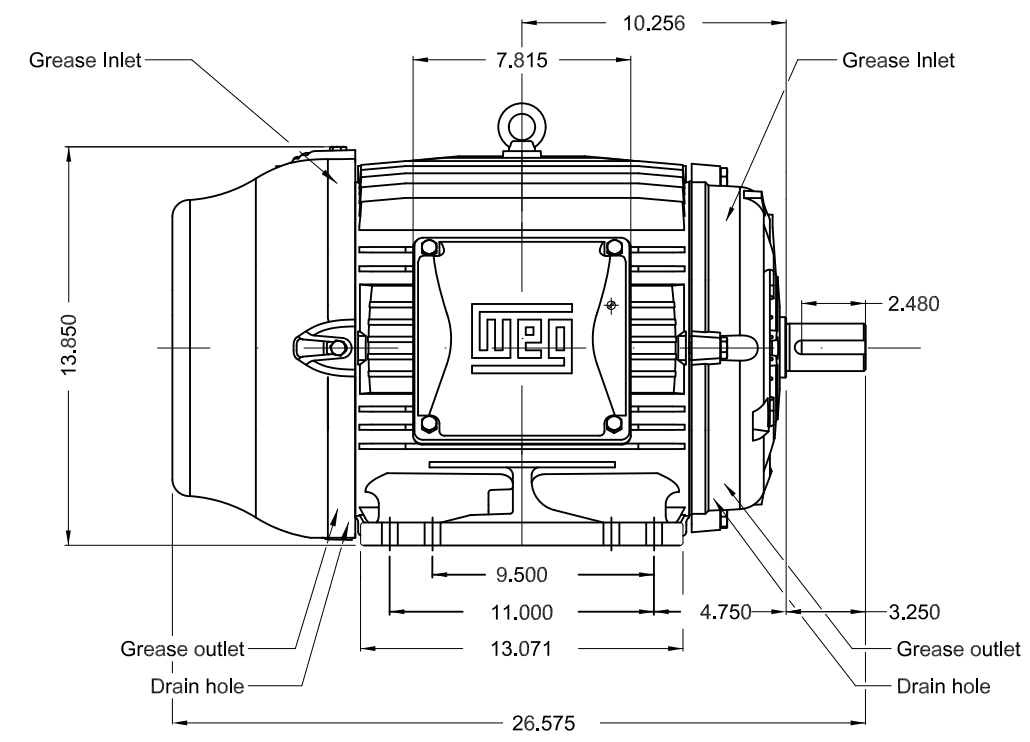
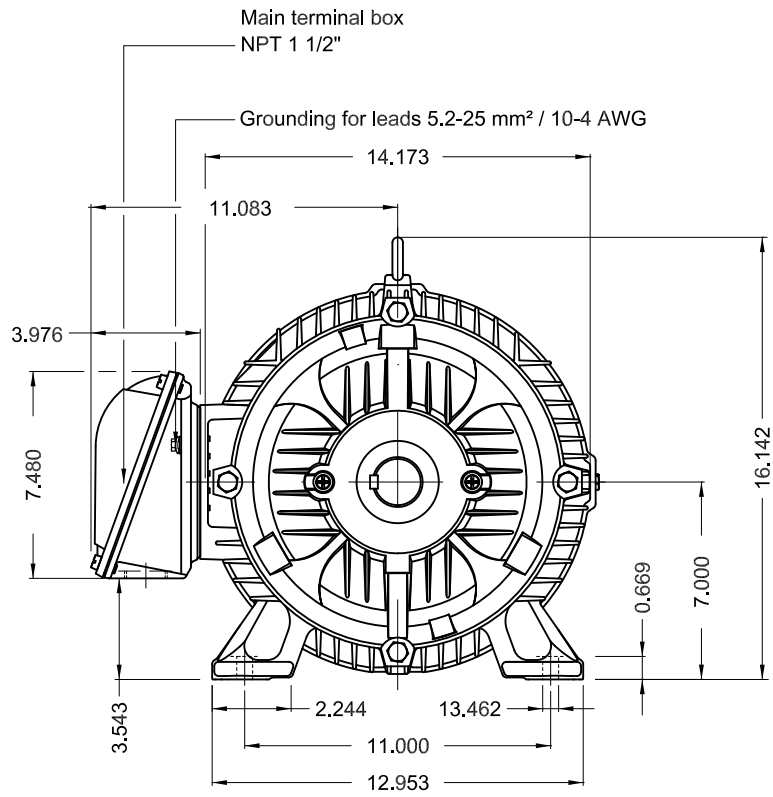

D

E

Without vertical jackscrews  
 Color RAL 5009  
 Painting plan 203A  
 Mounting B3R(D)

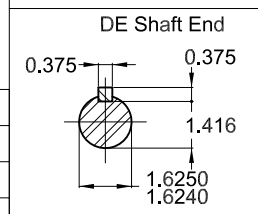

30 HP 02 Poles 60 Hz A

ECM	LOC	SUMMARY OF MODIFICATIONS	EXECUTED	CHECKED	RELEASED	DATE	VER
EXECUTED	PIRWBUSER	THREE PH. MOTOR W22 PREM. EFF. FRAME 284/6TS IP55 TEFC					
CHECKED							
RELEASED							
REL DT.	WMO		Jaragua do Sul	Product Engineering	SHEET	1 / 1	

**PREVIEW**  
**WDD**



Dimensions in inches XME A3



FOR SAFE AREA  
Mod.TE1BFOXON  
CC029A



For use on 60Hz  
Class I, Div 2, Gr A, B, C and D - T3  
Class I, Zone 2, IIC - T3  
Class II, Div 2, Gr F and G - T4  
For use on PWM: Gr. A, B, C, D and F,  
VT 1000:1, CT 20:1, 1.00SF - T3A

MODEL 03036ET3E286TS-W22

Inverter Duty Motor  
Severe Duty

PH3 60Hz Fr. 284/6TS 1000m.a.s.l. IP55 TEFC 415lb

V 230/460 A 67.6/33.8

HP 30 kW 22

SF 1.25 SFA 84.5/42.3

RPM 3535 PF 0.89

AMB 40°C INS cl. F DT80K NEMA NOM EFF 91.7%

DUTY CONT. DES B Code G

USABLE @208V 76.7A SF 1.10 SFA 84.4

30HP 22kW 50Hz 380V 42.0A 2895RPM SF 1.00 EFF 89.5%

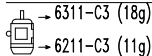
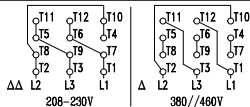

MOBIL POLYREX EM (14000h)

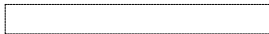

MADE IN MEXICO  
11413120