

DATA SHEET

Three Phase Induction Motor - Squirrel Cage



Customer					
Product line		: W40 JP Pump NEMA Premium Efficiency Three-Phase		Product code : 14836778	
				Catalog # : 03036OT3E284JPV-W40	
Frame		: 284/6JP		Cooling method : IC01 - ODP	
Insulation class		: F		Mounting : W-6	
Duty cycle		: Cont.(S1)		Rotation ¹ : Both (CW and CCW)	
Ambient temperature		: -20°C to +40°C		Starting method : Direct On Line	
Altitude		: 1000 m.a.s.l.		Approx. weight ² : 326 lb	
Protection degree		: IP23		Moment of inertia (J) : 1.59 sq.ft.lb	
Design		: B			
Output [HP]	30	25	25	25	25
Poles	2	2	2	2	2
Frequency [Hz]	60	50	50	50	50
Rated voltage [V]	230/460	380	400	415	415
Rated current [A]	70.0/35.0	35.0	34.0	33.6	33.6
L. R. Amperes [A]	441/221	231	238	225	225
LRC [A]	6.3x(Code G)	6.6x(Code G)	7.0x(Code H)	6.7x(Code H)	6.7x(Code H)
No load current [A]	25.8/12.9	11.0	13.0	14.0	14.0
Rated speed [RPM]	3550	2940	2950	2955	2955
Slip [%]	1.39	2.00	1.67	1.50	1.50
Rated torque [ft.lb]	44.4	44.7	44.5	44.4	44.4
Locked rotor torque [%]	180	170	190	200	200
Breakdown torque [%]	260	240	260	270	270
Service factor	1.25	1.00	1.00	1.00	1.00
Temperature rise	80 K	80 K	80 K	80 K	80 K
Locked rotor time	18s (cold) 10s (hot)	12s (cold) 7s (hot)	12s (cold) 7s (hot)	16s (cold) 9s (hot)	16s (cold) 9s (hot)
Noise level ²	73.0 dB(A)				
Efficiency (%)	25%	90.0	88.0	88.2	88.3
	50%	90.2	89.7	89.8	89.8
	75%	91.7	90.7	90.8	90.8
	100%	91.7	92.4	92.4	92.4
Power Factor	25%	0.47	0.51	0.45	0.42
	50%	0.73	0.75	0.70	0.66
	75%	0.82	0.83	0.80	0.77
	100%	0.86	0.87	0.85	0.83
Bearing type	: Drive end : 6311 Z C3	: Non drive end : 6211 Z C3	Foundation loads		
Sealing	: Without	: Without	Max. traction		
	: Bearing Seal	: Bearing Seal	Max. compression		
Lubrication interval	: 11517 h	: 14226 h			
Lubricant amount	: 18 g	: 11 g			
Lubricant type	: Mobil Polyrex EM				
Notes					
USABLE @208V 77.4A SF 1.15 SFA 89.0A					
This revision replaces and cancel the previous one, which must be eliminated. (1) Looking the motor from the shaft end. (2) Measured at 1m and with tolerance of +3dB(A). (3) Approximate weight subject to changes after manufacturing process. (4) At 100% of full load.			These are average values based on tests with sinusoidal power supply, subject to the tolerances stipulated in NEMA MG-1.		
Rev.	Changes Summary		Performed	Checked	Date
Performed by					
Checked by				Page	Revision
Date	14/04/2022			1 / 21	

TORQUE AND CURRENT VS SPEED CURVE



Three Phase Induction Motor - Squirrel Cage

Customer :

Product line : W40 JP Pump NEMA Premium Efficiency Three-Phase

Product code : 14836778

Catalog # : 03036OT3E284JPV-W40

TORQUE AND CURRENT VS SPEED CURVE

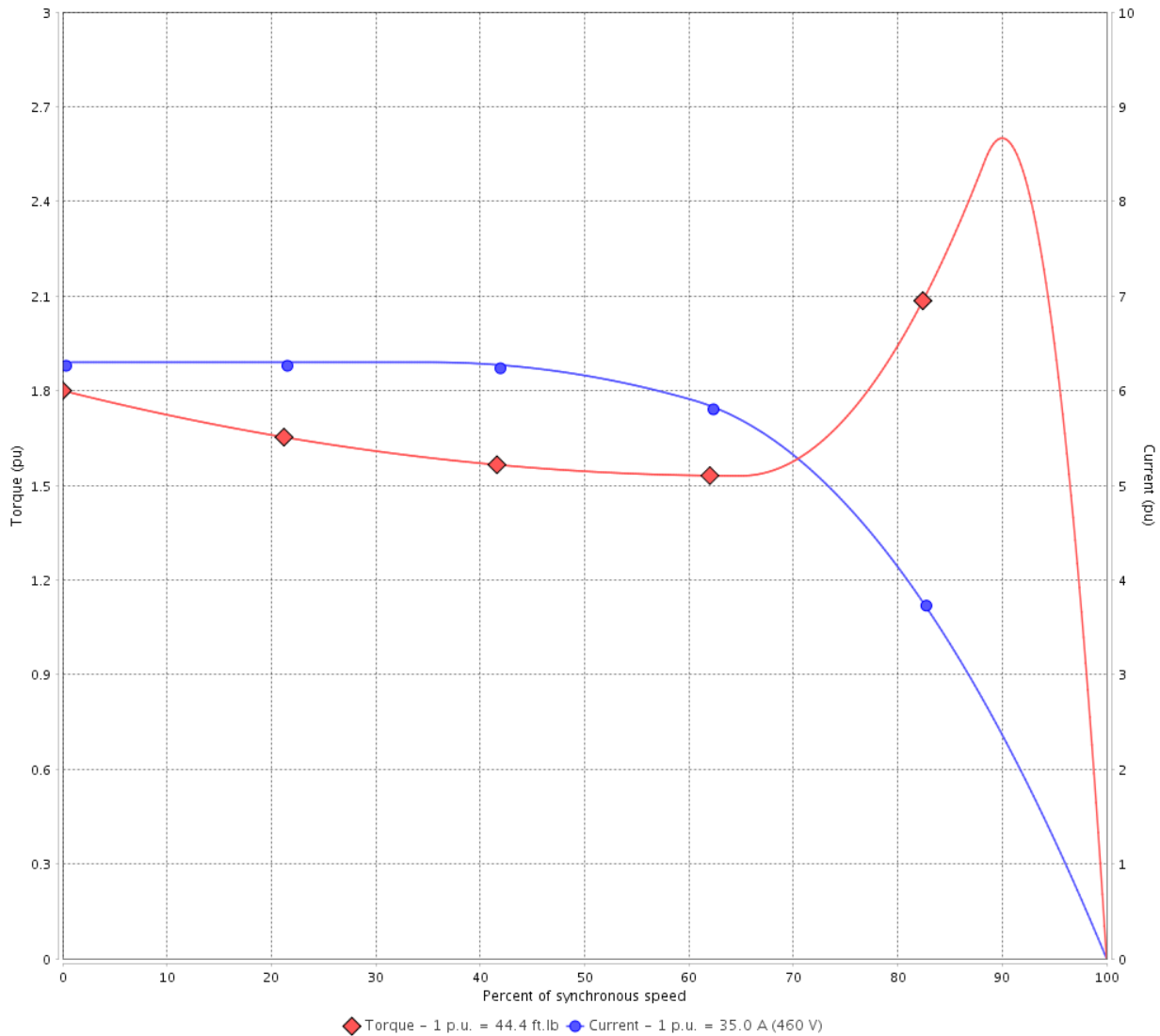

Performance : 230/460 V 60 Hz 2P

Rated current : 70.0/35.0 A
 LRC : 6.3
 Rated torque : 44.4 ft.lb
 Locked rotor torque : 180 %
 Breakdown torque : 260 %
 Rated speed : 3550 rpm

Moment of inertia (J) : 1.59 sq.ft.lb
 Duty cycle : Cont.(S1)
 Insulation class : F
 Service factor : 1.25
 Temperature rise : 80 K
 Design : B

Locked rotor time : 18s (cold) 10s (hot)

Rev.	Changes Summary	Performed	Checked	Date
Performed by			Page 2 / 21	Revision
Checked by				
Date	14/04/2022			

TORQUE AND CURRENT VS SPEED CURVE



Three Phase Induction Motor - Squirrel Cage

Customer :

Product line : W40 JP Pump NEMA Premium Efficiency Three-Phase

Product code : 14836778

Catalog # : 03036OT3E284JPV-W40

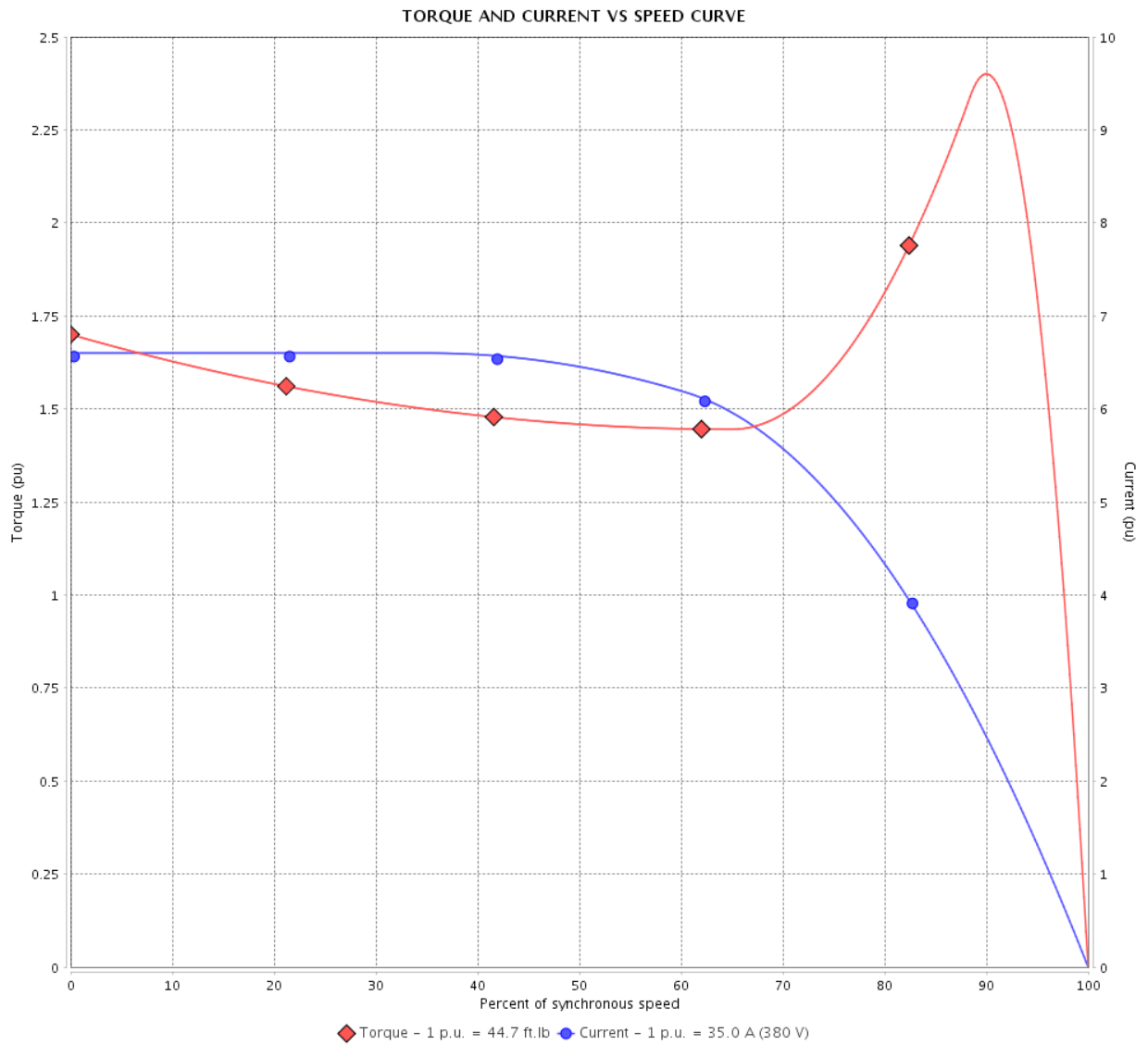

Performance : 380 V 50 Hz 2P IE3

Rated current : 35.0 A
 LRC : 6.6
 Rated torque : 44.7 ft.lb
 Locked rotor torque : 170 %
 Breakdown torque : 240 %
 Rated speed : 2940 rpm

Moment of inertia (J) : 1.59 sq.ft.lb
 Duty cycle : Cont.(S1)
 Insulation class : F
 Service factor : 1.00
 Temperature rise : 80 K
 Design : B

Locked rotor time : 12s (cold) 7s (hot)

Rev.	Changes Summary	Performed	Checked	Date
Performed by			Page 3 / 21	Revision
Checked by				
Date	14/04/2022			

TORQUE AND CURRENT VS SPEED CURVE

Three Phase Induction Motor - Squirrel Cage



Customer :

Product line : W40 JP Pump NEMA Premium Efficiency Three-Phase

Product code : 14836778

Catalog # : 03036OT3E284JPV-W40

TORQUE AND CURRENT VS SPEED CURVE

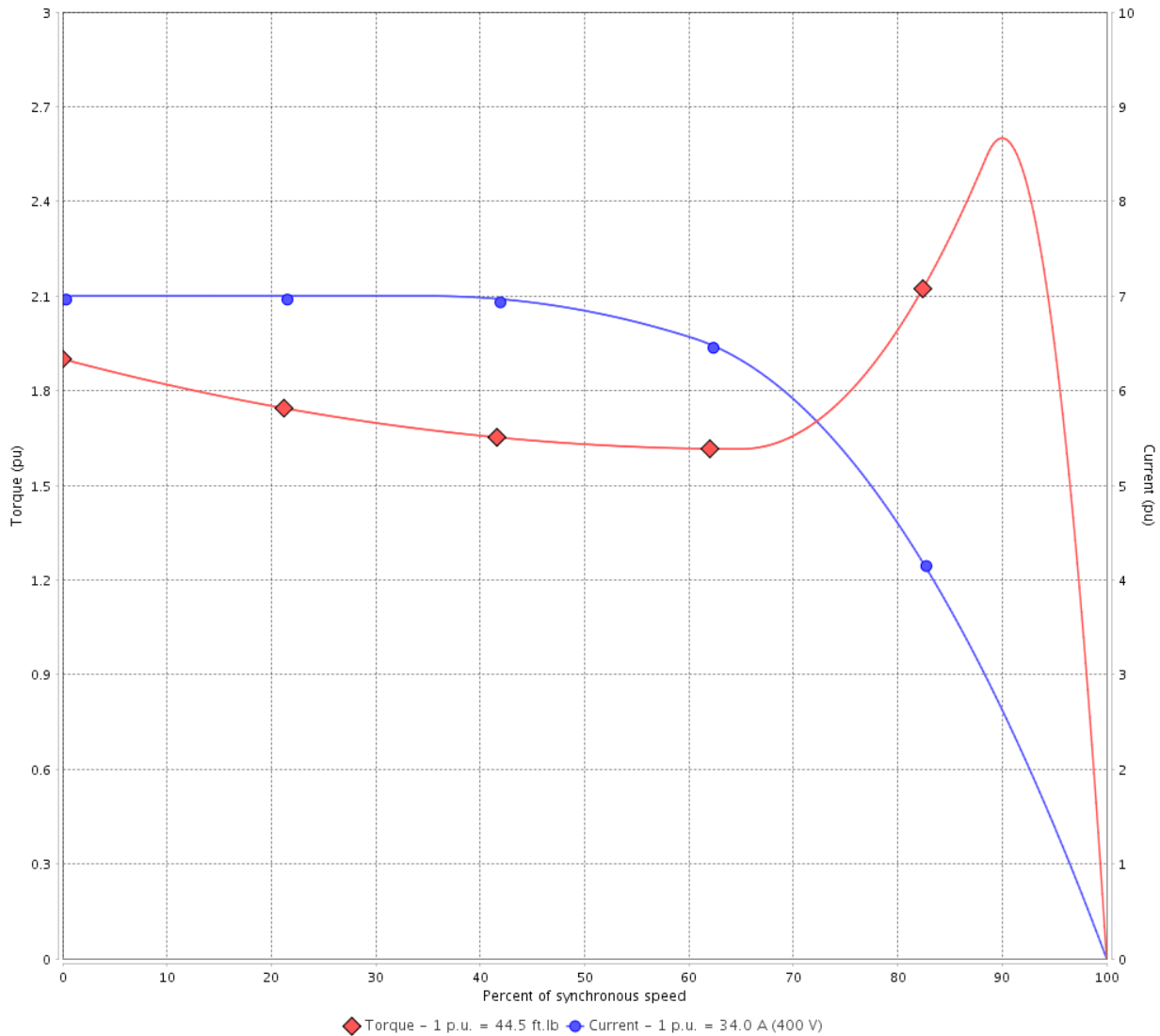

Performance : 400 V 50 Hz 2P IE3

Rated current	: 34.0 A	Moment of inertia (J)	: 1.59 sq.ft.lb
LRC	: 7.0	Duty cycle	: Cont.(S1)
Rated torque	: 44.5 ft.lb	Insulation class	: F
Locked rotor torque	: 190 %	Service factor	: 1.00
Breakdown torque	: 260 %	Temperature rise	: 80 K
Rated speed	: 2950 rpm	Design	: B

Locked rotor time : 12s (cold) 7s (hot)

Rev.	Changes Summary	Performed	Checked	Date
Performed by			Page 4 / 21	Revision
Checked by				
Date	14/04/2022			

TORQUE AND CURRENT VS SPEED CURVE



Three Phase Induction Motor - Squirrel Cage

Customer :

Product line : W40 JP Pump NEMA Premium Efficiency Three-Phase

Product code : 14836778

Catalog # : 03036OT3E284JPV-W40

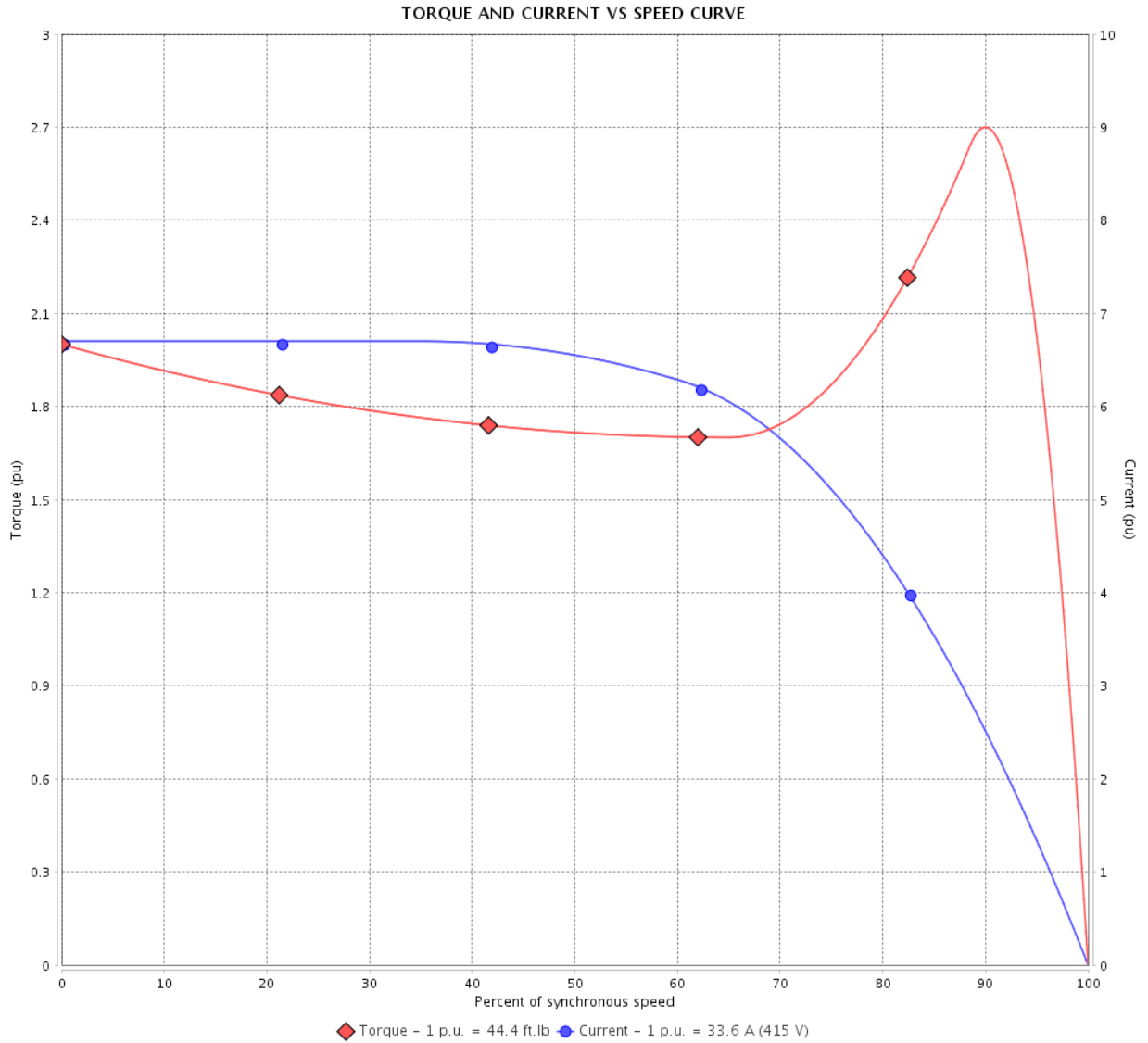

Performance : 415 V 50 Hz 2P IE3

Rated current	: 33.6 A	Moment of inertia (J)	: 1.59 sq.ft.lb
LRC	: 6.7	Duty cycle	: Cont.(S1)
Rated torque	: 44.4 ft.lb	Insulation class	: F
Locked rotor torque	: 200 %	Service factor	: 1.00
Breakdown torque	: 270 %	Temperature rise	: 80 K
Rated speed	: 2955 rpm	Design	: B

Locked rotor time : 16s (cold) 9s (hot)

Rev.	Changes Summary	Performed	Checked	Date
Performed by			Page 5 / 21	Revision
Checked by				
Date	14/04/2022			

LOAD PERFORMANCE CURVE

Three Phase Induction Motor - Squirrel Cage



Customer :

Product line : W40 JP Pump NEMA Premium Efficiency Three-Phase

Product code : 14836778

Catalog # : 03036OT3E284JPV-W40

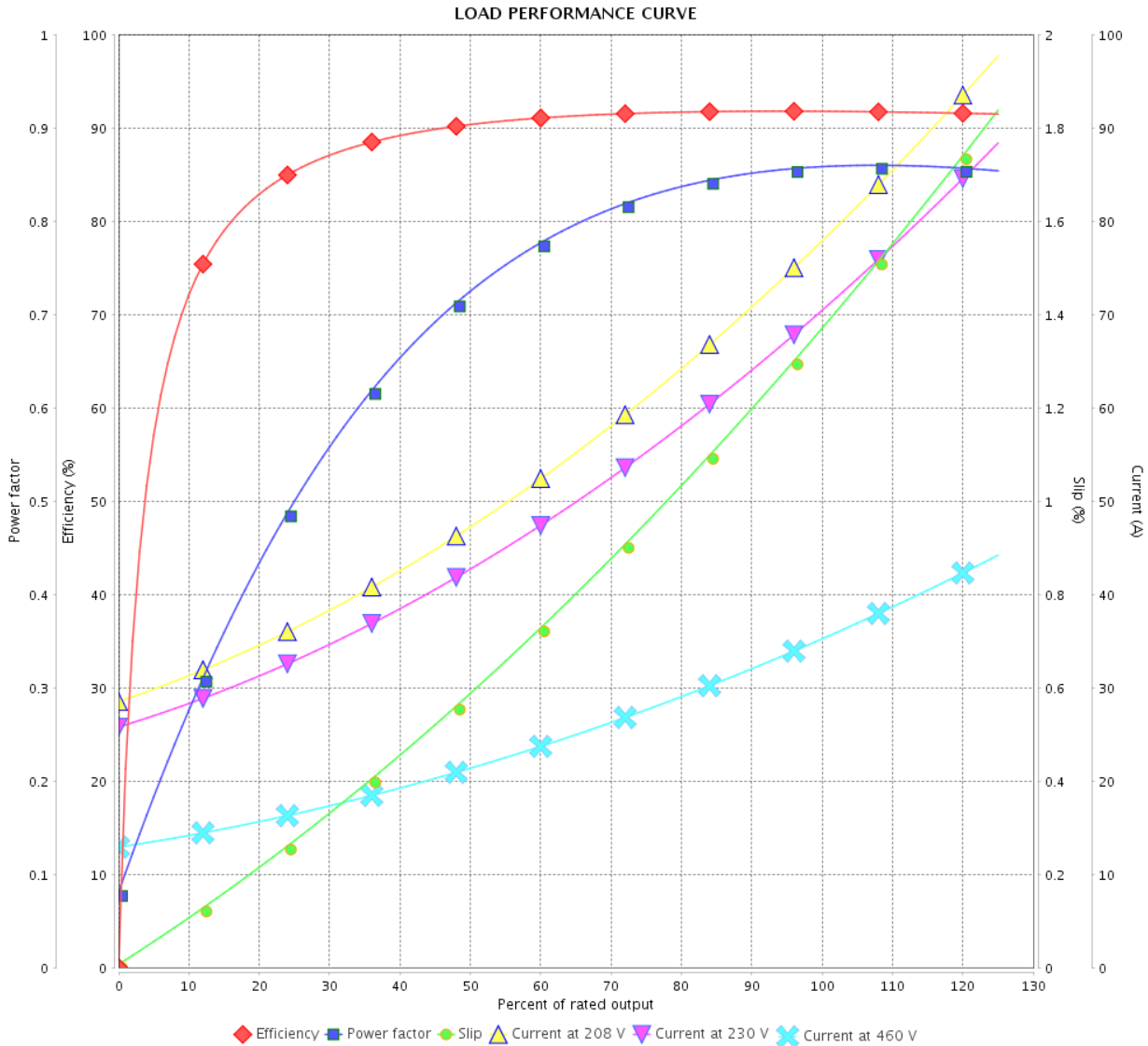

Performance : 230/460 V 60 Hz 2P

Rated current : 70.0/35.0 A
 LRC : 6.3
 Rated torque : 44.4 ft.lb
 Locked rotor torque : 180 %
 Breakdown torque : 260 %
 Rated speed : 3550 rpm

Moment of inertia (J) : 1.59 sq.ft.lb
 Duty cycle : Cont.(S1)
 Insulation class : F
 Service factor : 1.25
 Temperature rise : 80 K
 Design : B

Rev.	Changes Summary	Performed	Checked	Date
Performed by			Page 6 / 21	Revision
Checked by				
Date	14/04/2022			

LOAD PERFORMANCE CURVE

Three Phase Induction Motor - Squirrel Cage



Customer : _____

Product line : W40 JP Pump NEMA Premium
Efficiency Three-Phase

Product code : 14836778

Catalog # : 03036OT3E284JPV-W40

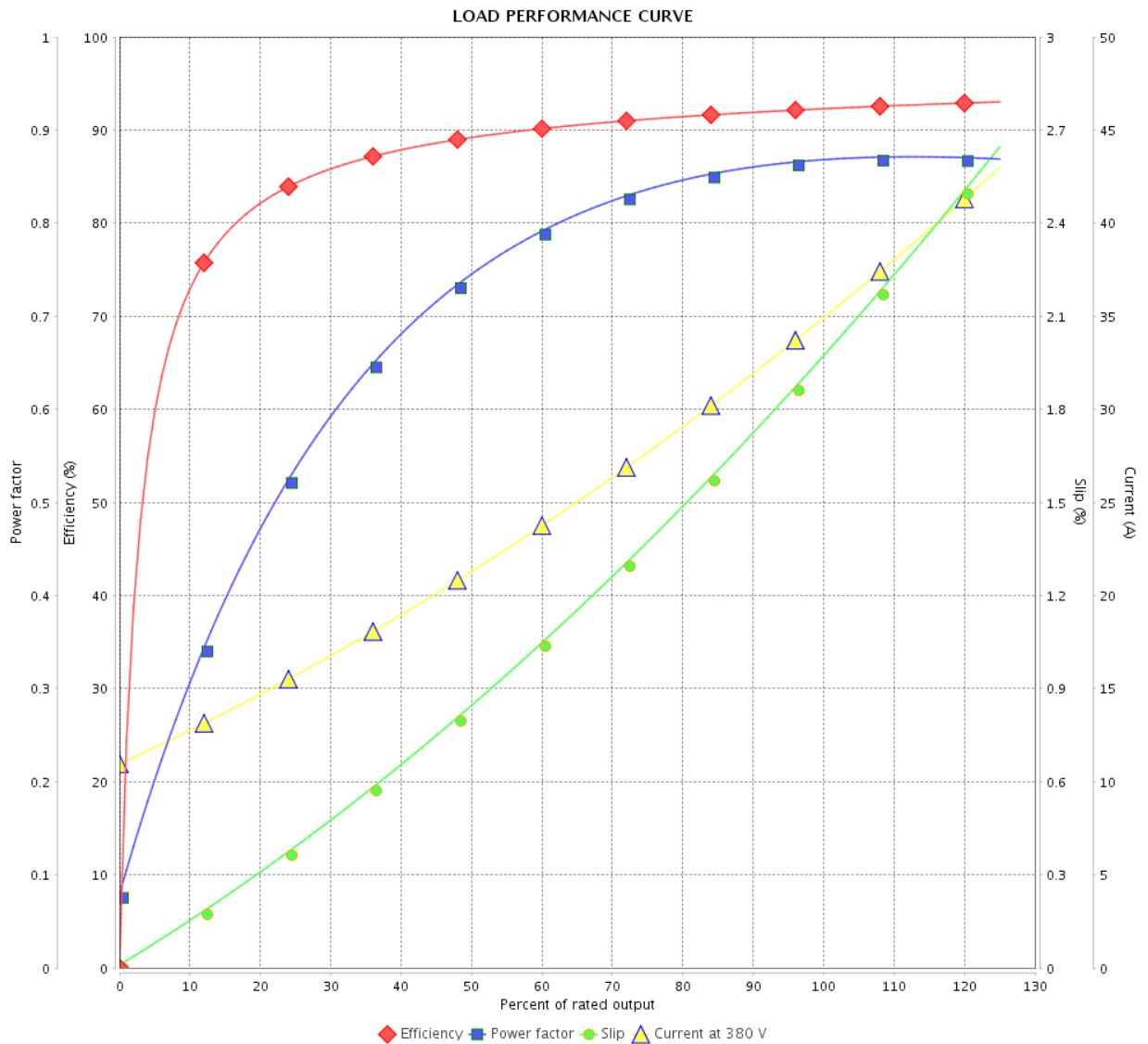

Performance : 380 V 50 Hz 2P IE3

Rated current : 35.0 A
LRC : 6.6
Rated torque : 44.7 ft.lb
Locked rotor torque : 170 %
Breakdown torque : 240 %
Rated speed : 2940 rpm

Moment of inertia (J) : 1.59 sq.ft.lb
Duty cycle : Cont.(S1)
Insulation class : F
Service factor : 1.00
Temperature rise : 80 K
Design : B

Rev.	Changes Summary	Performed	Checked	Date
Performed by		Page		Revision
Checked by		7 / 21		
Date		14/04/2022		

LOAD PERFORMANCE CURVE

Three Phase Induction Motor - Squirrel Cage



Customer :

Product line : W40 JP Pump NEMA Premium
Efficiency Three-Phase

Product code : 14836778

Catalog # : 03036OT3E284JPV-W40

LOAD PERFORMANCE CURVE

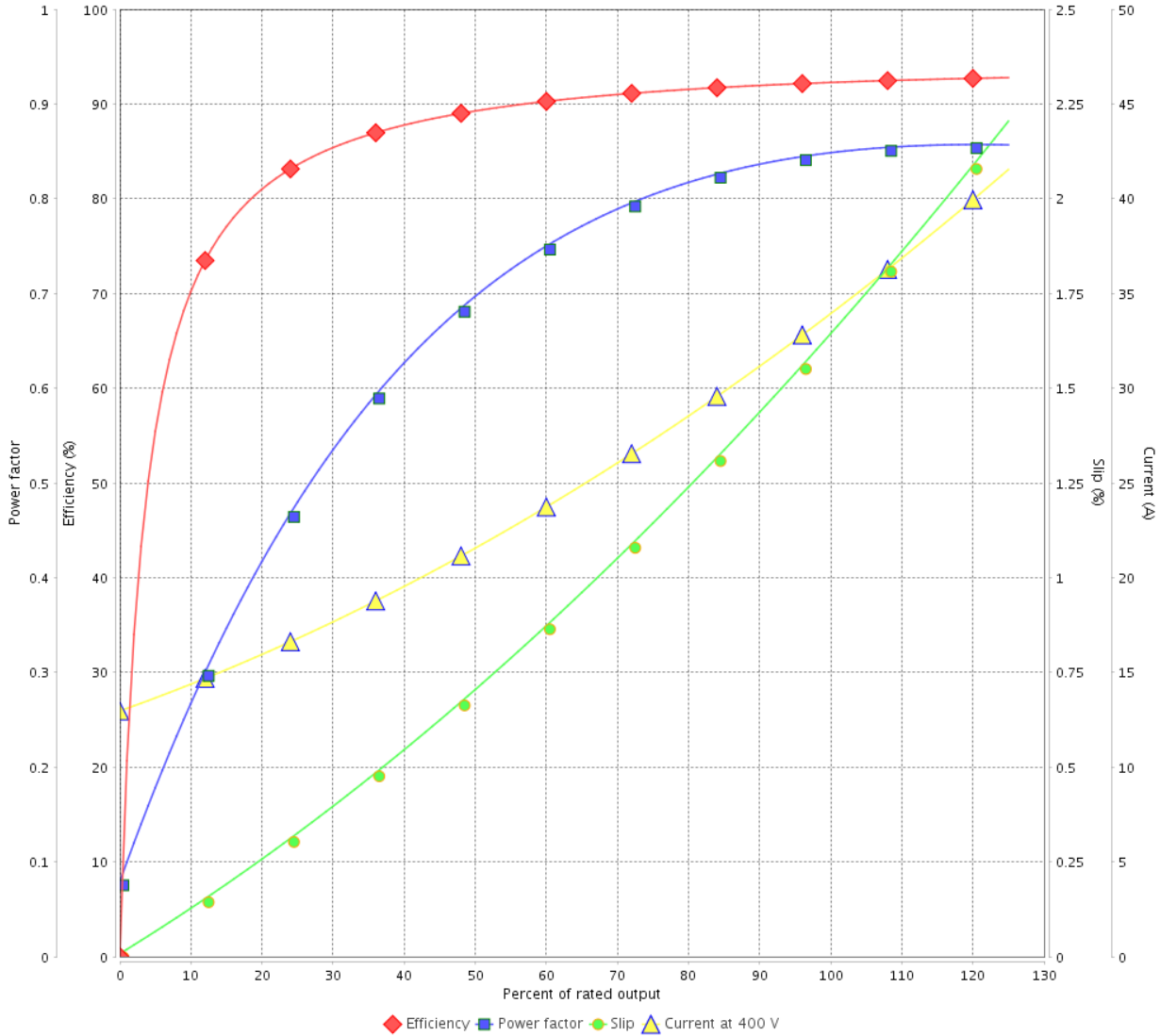

Performance : 400 V 50 Hz 2P IE3

Rated current : 34.0 A
LRC : 7.0
Rated torque : 44.5 ft.lb
Locked rotor torque : 190 %
Breakdown torque : 260 %
Rated speed : 2950 rpm

Moment of inertia (J) : 1.59 sq.ft.lb
Duty cycle : Cont.(S1)
Insulation class : F
Service factor : 1.00
Temperature rise : 80 K
Design : B

Rev.	Changes Summary	Performed	Checked	Date
Performed by			Page 8 / 21	Revision
Checked by				
Date	14/04/2022			

LOAD PERFORMANCE CURVE

Three Phase Induction Motor - Squirrel Cage



Customer :

Product line : W40 JP Pump NEMA Premium Efficiency Three-Phase

Product code : 14836778

Catalog # : 03036OT3E284JPV-W40

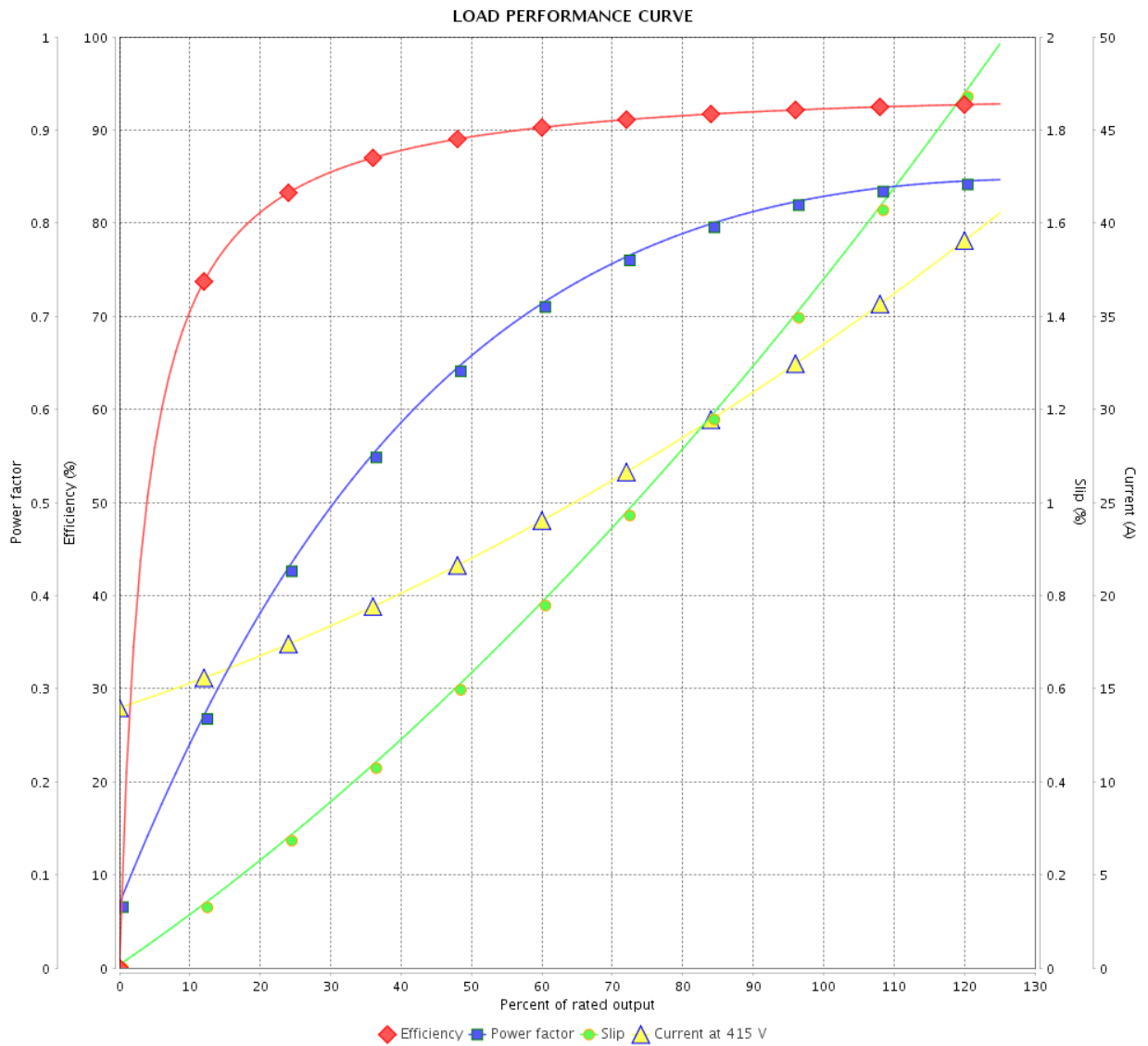

Performance : 415 V 50 Hz 2P IE3

Rated current : 33.6 A
 LRC : 6.7
 Rated torque : 44.4 ft.lb
 Locked rotor torque : 200 %
 Breakdown torque : 270 %
 Rated speed : 2955 rpm

Moment of inertia (J) : 1.59 sq.ft.lb
 Duty cycle : Cont.(S1)
 Insulation class : F
 Service factor : 1.00
 Temperature rise : 80 K
 Design : B

Rev.	Changes Summary	Performed	Checked	Date
Performed by		Page		Revision
Checked by		9 / 21		
Date		14/04/2022		

THERMAL LIMIT CURVE



Three Phase Induction Motor - Squirrel Cage

Customer :

Product line : W40 JP Pump NEMA Premium
Efficiency Three-Phase

Product code : 14836778

Catalog # : 03036OT3E284JPV-W40

Performance : 230/460 V 60 Hz 2P

Rated current : 70.0/35.0 A
LRC : 6.3
Rated torque : 44.4 ft.lb
Locked rotor torque : 180 %
Breakdown torque : 260 %
Rated speed : 3550 rpm

Moment of inertia (J) : 1.59 sq.ft.lb
Duty cycle : Cont.(S1)
Insulation class : F
Service factor : 1.25
Temperature rise : 80 K
Design : B

Heating constant

Cooling constant

Rev.	Changes Summary	Performed	Checked	Date
Performed by				
Checked by			Page	Revision
Date	14/04/2022		10 / 21	

THERMAL LIMIT CURVE

Three Phase Induction Motor - Squirrel Cage



Customer : _____

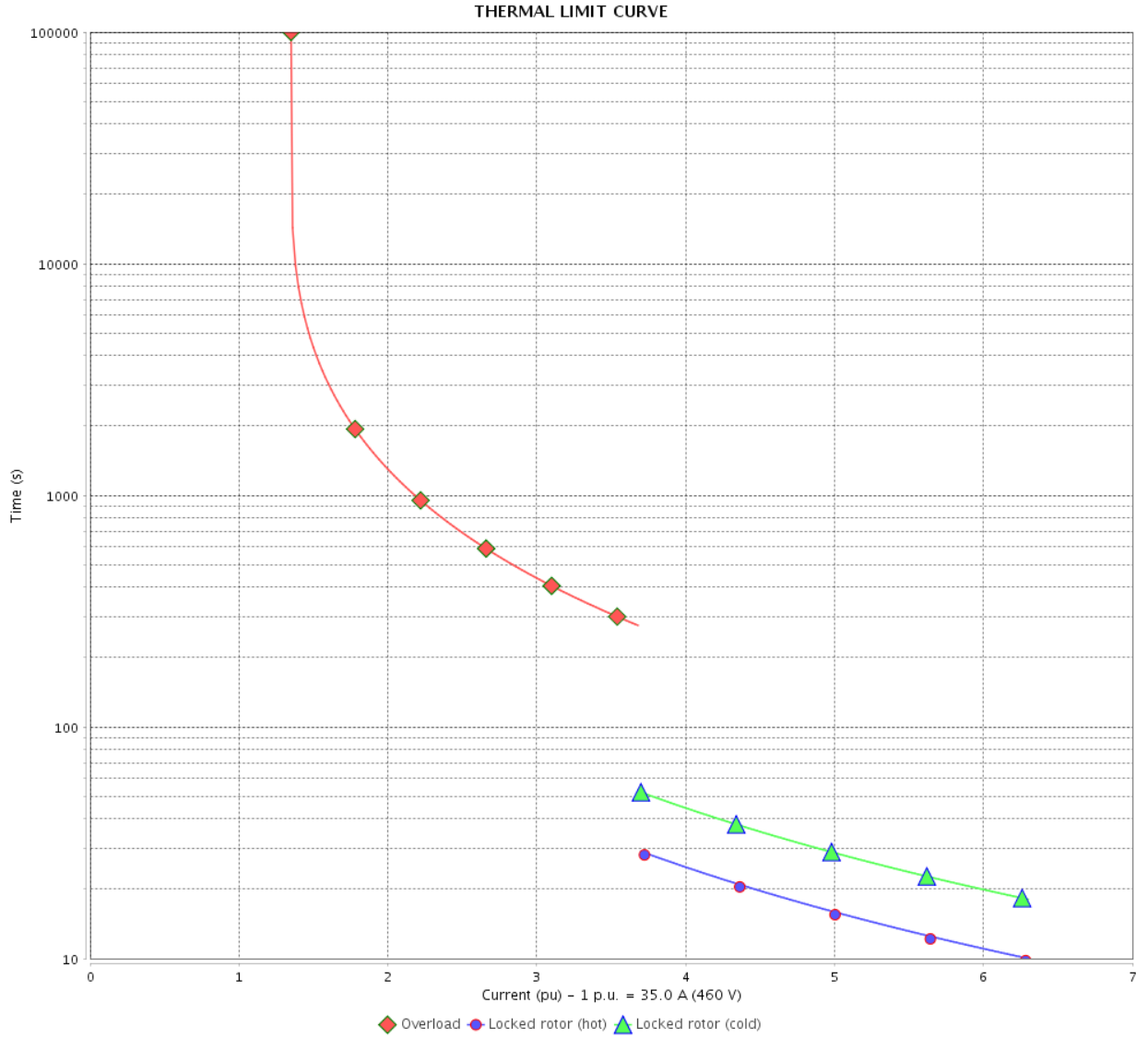

Rev.	Changes Summary	Performed	Checked	Date
Performed by		Page		Revision
Checked by		11 / 21		
Date		14/04/2022		

THERMAL LIMIT CURVE



Three Phase Induction Motor - Squirrel Cage

Customer :

Product line : W40 JP Pump NEMA Premium
Efficiency Three-Phase

Product code : 14836778

Catalog # : 03036OT3E284JPV-W40

Performance : 380 V 50 Hz 2P IE3

Rated current : 35.0 A
LRC : 6.6
Rated torque : 44.7 ft.lb
Locked rotor torque : 170 %
Breakdown torque : 240 %
Rated speed : 2940 rpm

Moment of inertia (J) : 1.59 sq.ft.lb
Duty cycle : Cont.(S1)
Insulation class : F
Service factor : 1.00
Temperature rise : 80 K
Design : B

Heating constant

Cooling constant

Rev.	Changes Summary	Performed	Checked	Date
Performed by				
Checked by			Page	Revision
Date	14/04/2022		12 / 21	

THERMAL LIMIT CURVE

Three Phase Induction Motor - Squirrel Cage



Customer : _____

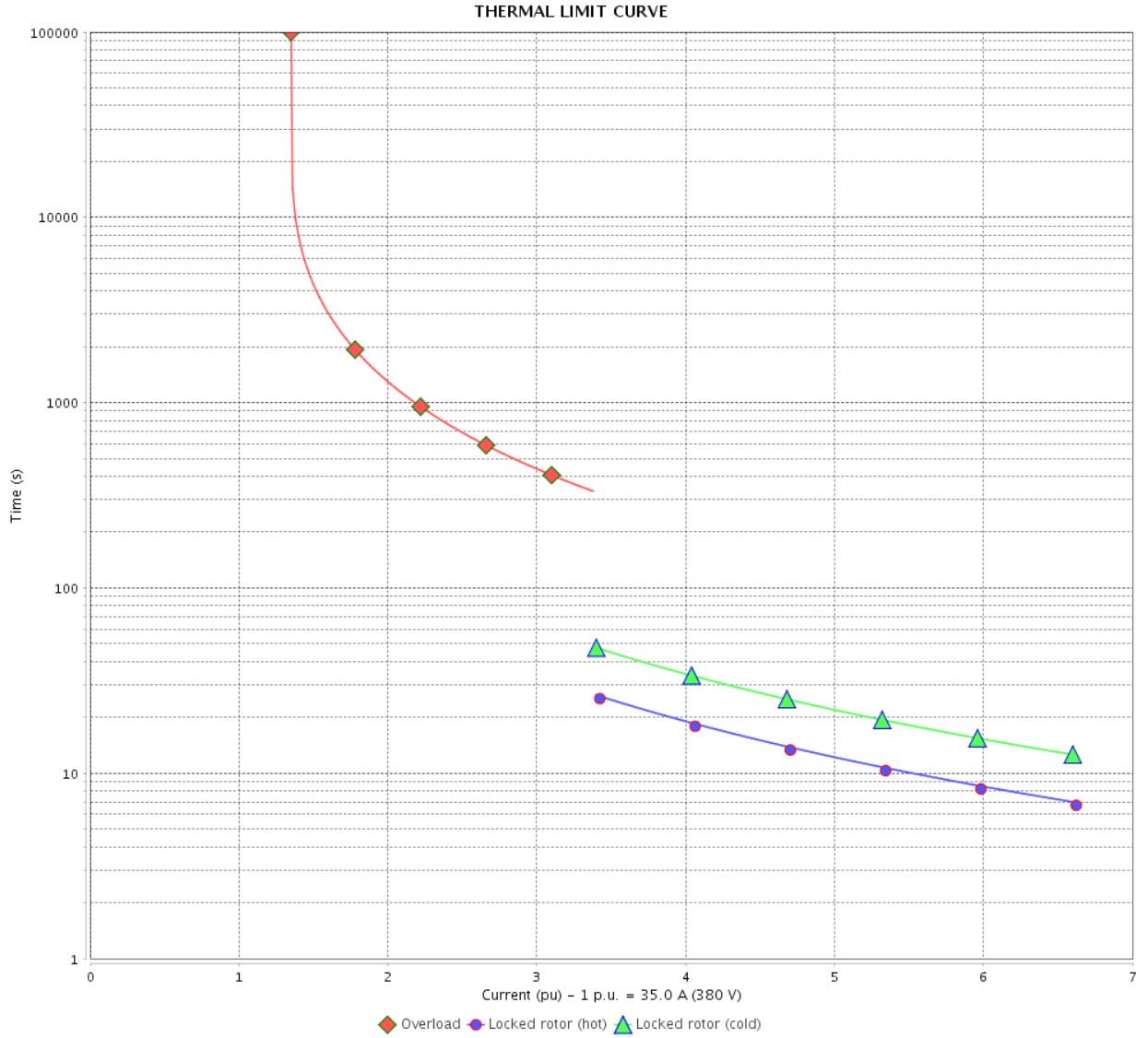

Rev.	Changes Summary	Performed	Checked	Date
Performed by		Page 13 / 21		Revision
Checked by				
Date				

THERMAL LIMIT CURVE



Three Phase Induction Motor - Squirrel Cage

Customer :

Product line : W40 JP Pump NEMA Premium
Efficiency Three-Phase

Product code : 14836778

Catalog # : 03036OT3E284JPV-W40

Performance : 400 V 50 Hz 2P IE3

Rated current : 34.0 A
LRC : 7.0
Rated torque : 44.5 ft.lb
Locked rotor torque : 190 %
Breakdown torque : 260 %
Rated speed : 2950 rpm

Moment of inertia (J) : 1.59 sq.ft.lb
Duty cycle : Cont.(S1)
Insulation class : F
Service factor : 1.00
Temperature rise : 80 K
Design : B

Heating constant

Cooling constant

Rev.	Changes Summary	Performed	Checked	Date
Performed by				
Checked by			Page	Revision
Date	14/04/2022		14 / 21	

THERMAL LIMIT CURVE

Three Phase Induction Motor - Squirrel Cage



Customer : _____

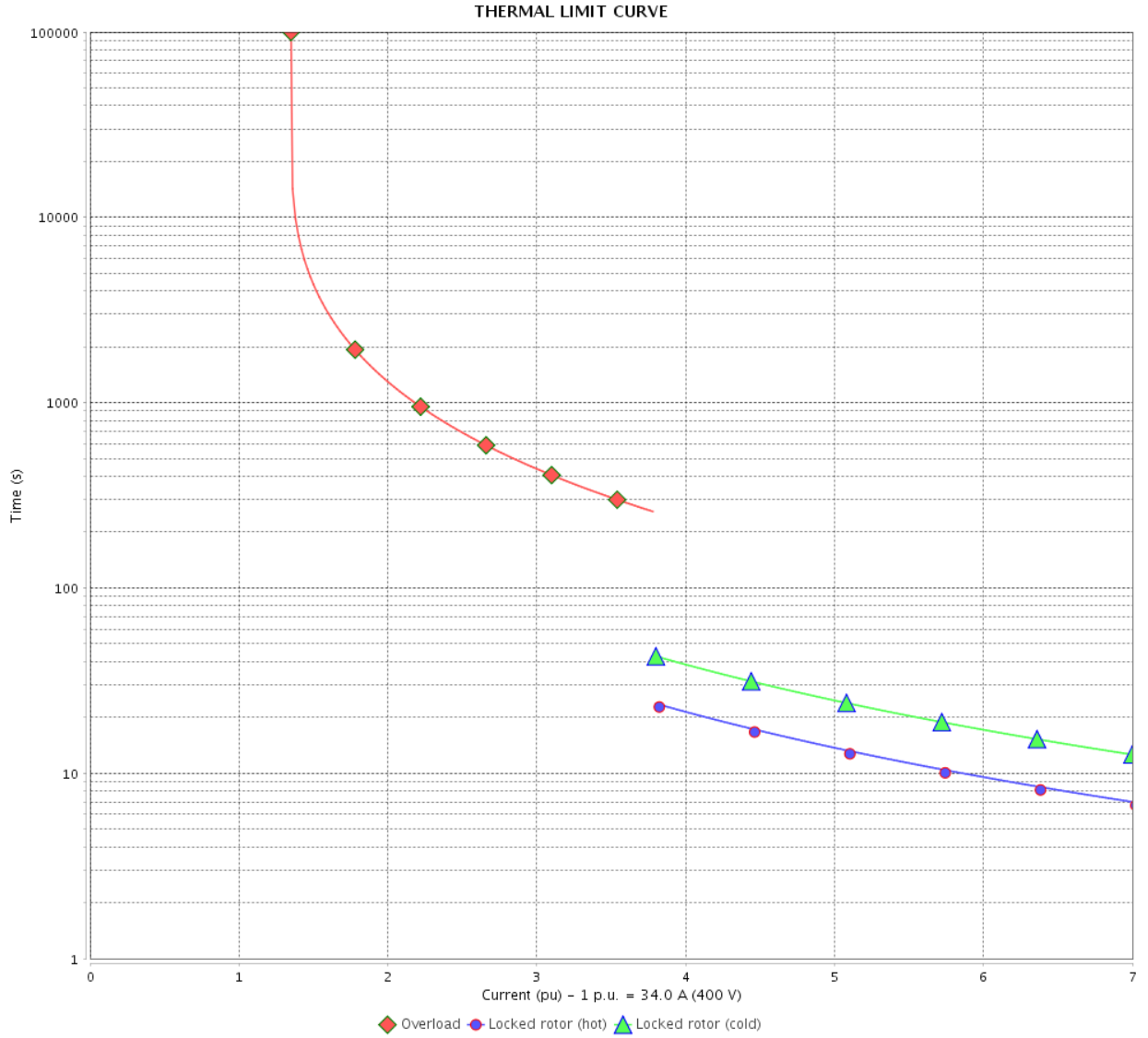

Rev.	Changes Summary	Performed	Checked	Date
Performed by		Page		Revision
Checked by		15 / 21		
Date		14/04/2022		

THERMAL LIMIT CURVE



Three Phase Induction Motor - Squirrel Cage

Customer :

Product line : W40 JP Pump NEMA Premium
Efficiency Three-Phase

Product code : 14836778

Catalog # : 03036OT3E284JPV-W40

Performance : 415 V 50 Hz 2P IE3

Rated current	: 33.6 A	Moment of inertia (J)	: 1.59 sq.ft.lb
LRC	: 6.7	Duty cycle	: Cont.(S1)
Rated torque	: 44.4 ft.lb	Insulation class	: F
Locked rotor torque	: 200 %	Service factor	: 1.00
Breakdown torque	: 270 %	Temperature rise	: 80 K
Rated speed	: 2955 rpm	Design	: B

Heating constant

Cooling constant

Rev.	Changes Summary	Performed	Checked	Date
Performed by				
Checked by			Page	Revision
Date	14/04/2022		16 / 21	

THERMAL LIMIT CURVE

Three Phase Induction Motor - Squirrel Cage



Customer : _____

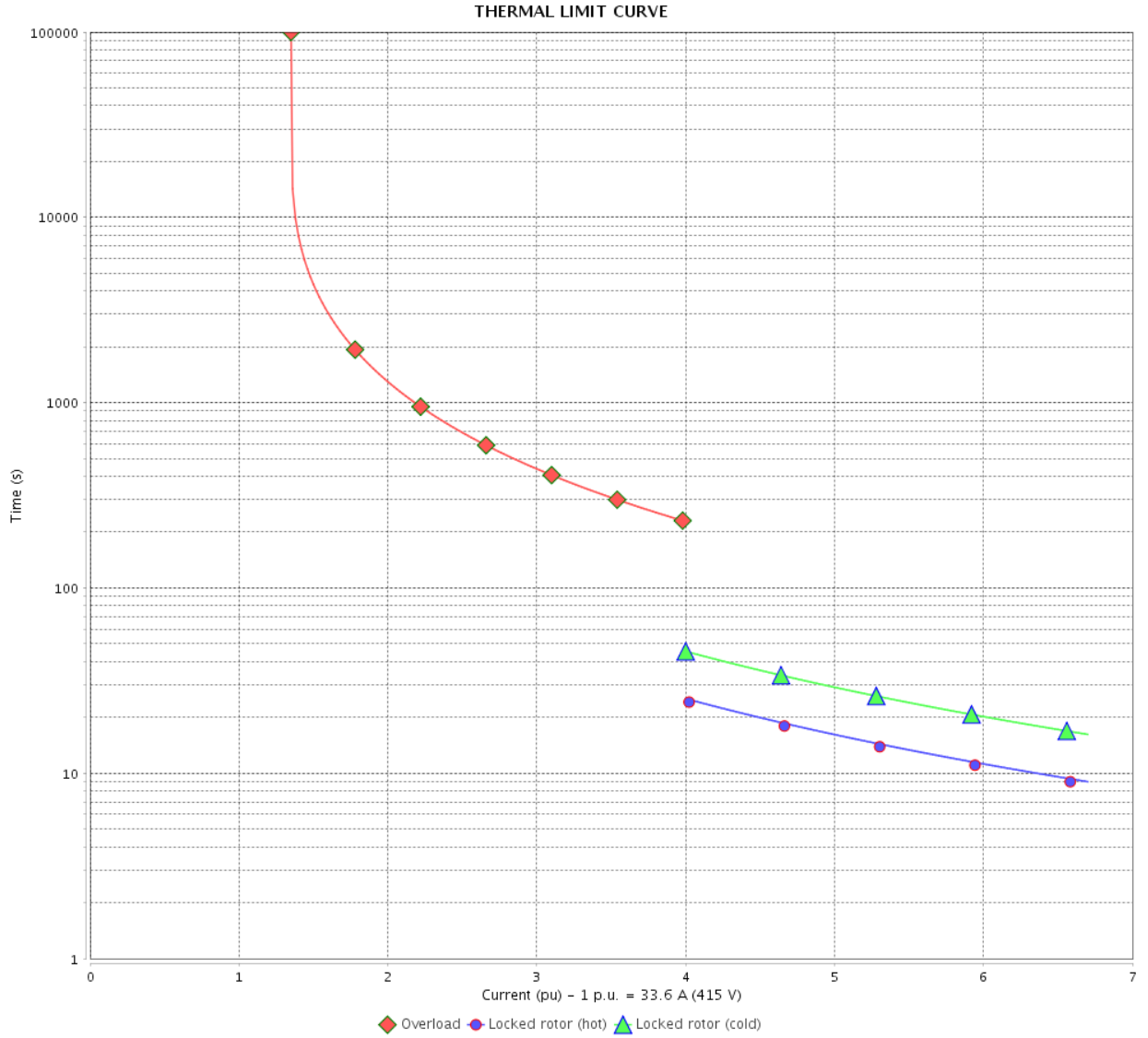

Rev.	Changes Summary	Performed	Checked	Date
Performed by				
Checked by				
Date				
		Page	Revision	
		17 / 21		

VFD OPERATION CURVE

Three Phase Induction Motor - Squirrel Cage



Customer :

Product line : W40 JP Pump NEMA Premium Efficiency Three-Phase

Product code : 14836778

Catalog # : 03036OT3E284JPV-W40

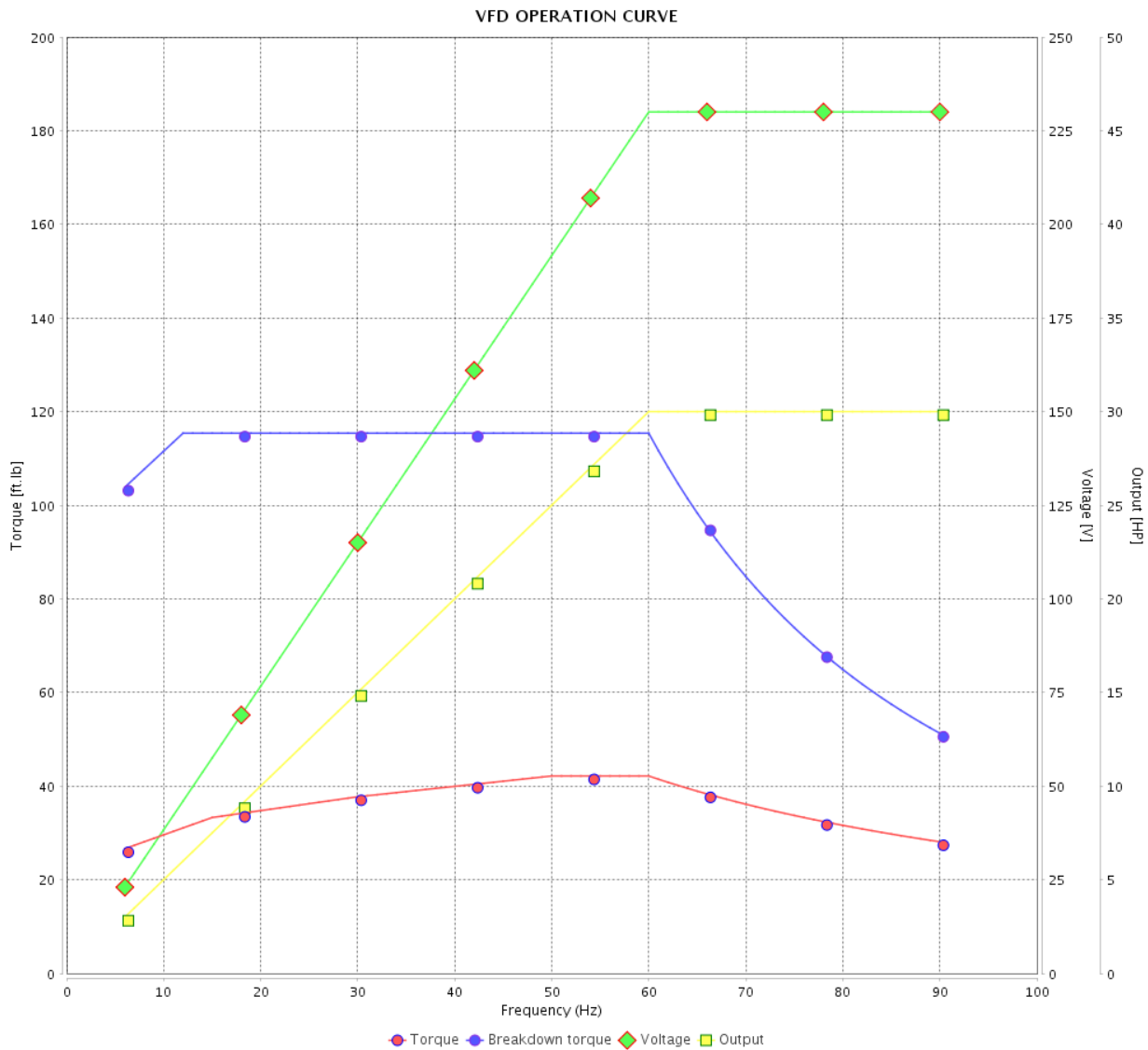

Performance : 230/460 V 60 Hz 2P

Rated current : 70.0/35.0 A
 LRC : 6.3
 Rated torque : 44.4 ft.lb
 Locked rotor torque : 180 %
 Breakdown torque : 260 %
 Rated speed : 3550 rpm

Moment of inertia (J) : 1.59 sq.ft.lb
 Duty cycle : Cont.(S1)
 Insulation class : F
 Service factor : 1.25
 Temperature rise : 80 K
 Design : B

Rev.	Changes Summary	Performed	Checked	Date
Performed by			Page 18 / 21	Revision
Checked by				
Date	14/04/2022			

VFD OPERATION CURVE

Three Phase Induction Motor - Squirrel Cage



Customer :

Product line : W40 JP Pump NEMA Premium Efficiency Three-Phase

Product code : 14836778

Catalog # : 03036OT3E284JPV-W40

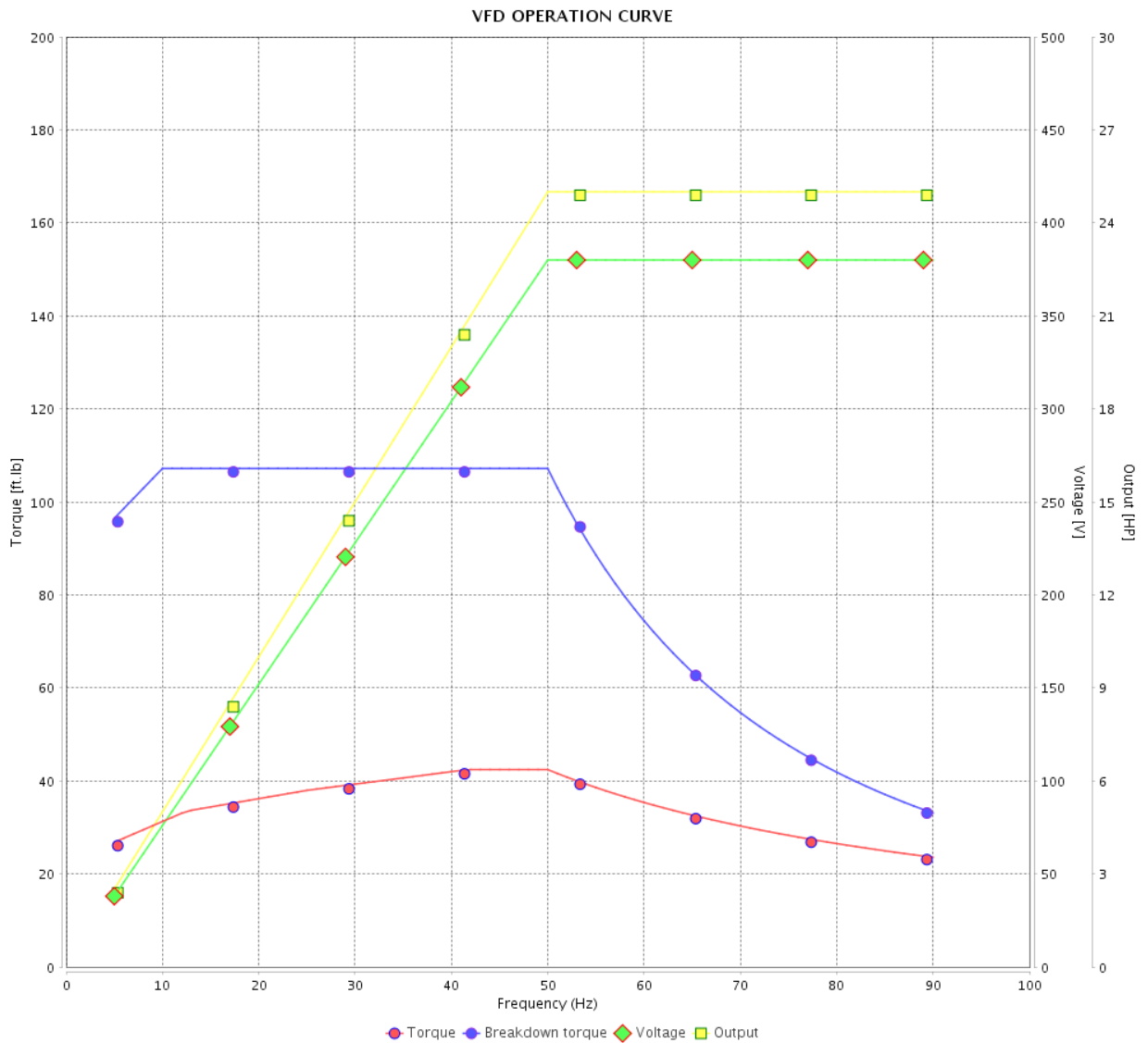

Performance : 380 V 50 Hz 2P IE3

Rated current : 35.0 A
 LRC : 6.6
 Rated torque : 44.7 ft.lb
 Locked rotor torque : 170 %
 Breakdown torque : 240 %
 Rated speed : 2940 rpm

Moment of inertia (J) : 1.59 sq.ft.lb
 Duty cycle : Cont.(S1)
 Insulation class : F
 Service factor : 1.00
 Temperature rise : 80 K
 Design : B

Rev.	Changes Summary	Performed	Checked	Date
Performed by			Page	Revision
Checked by				
Date				
			19 / 21	

VFD OPERATION CURVE

Three Phase Induction Motor - Squirrel Cage



Customer :

Product line : W40 JP Pump NEMA Premium Efficiency Three-Phase

Product code : 14836778

Catalog # : 03036OT3E284JPV-W40

VFD OPERATION CURVE

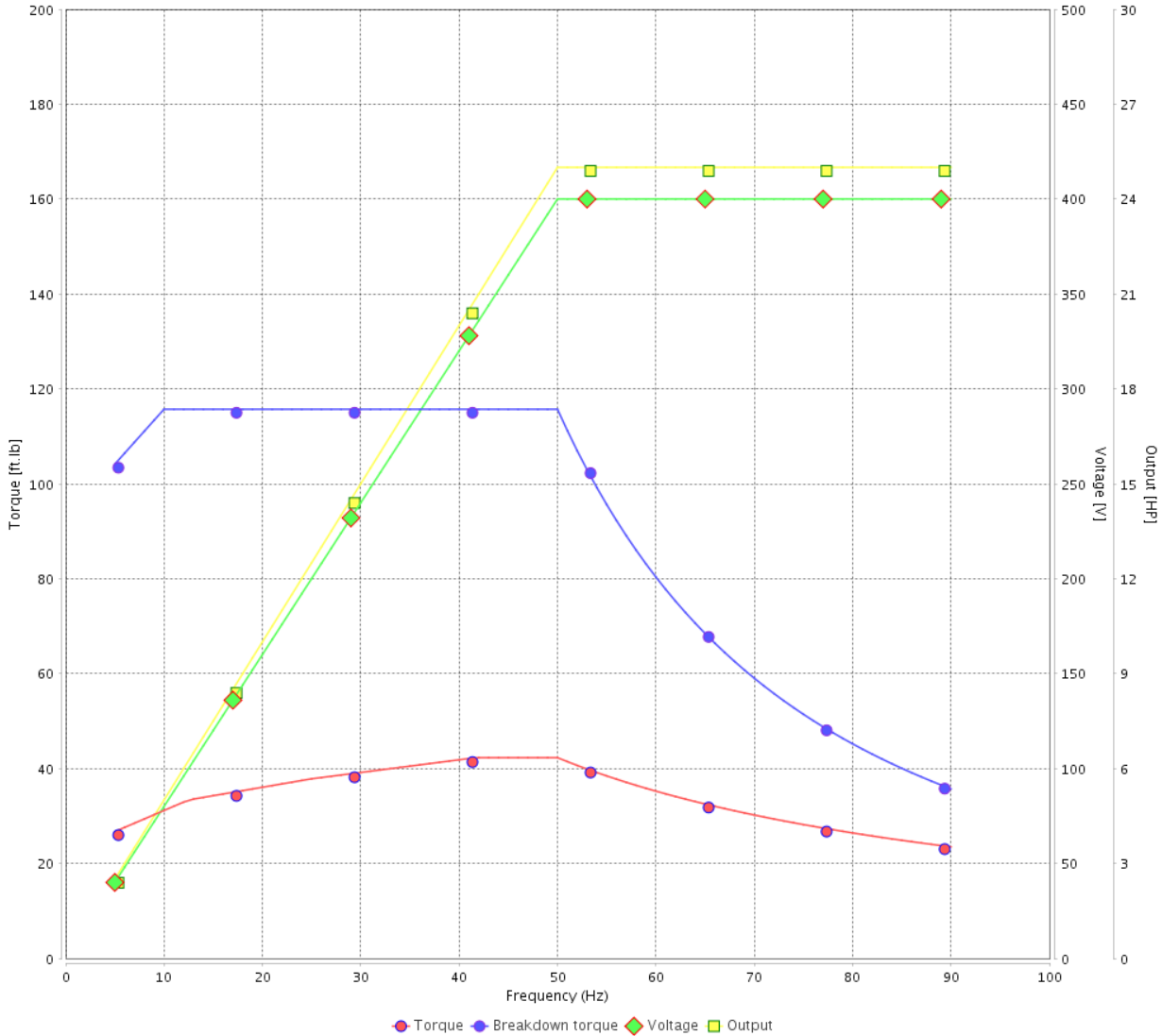

Performance : 400 V 50 Hz 2P IE3

Rated current : 34.0 A
 LRC : 7.0
 Rated torque : 44.5 ft.lb
 Locked rotor torque : 190 %
 Breakdown torque : 260 %
 Rated speed : 2950 rpm

Moment of inertia (J) : 1.59 sq.ft.lb
 Duty cycle : Cont.(S1)
 Insulation class : F
 Service factor : 1.00
 Temperature rise : 80 K
 Design : B

Rev.	Changes Summary	Performed	Checked	Date
Performed by			Page 20 / 21	Revision
Checked by				
Date	14/04/2022			

VFD OPERATION CURVE

Three Phase Induction Motor - Squirrel Cage



Customer : _____

Product line : W40 JP Pump NEMA Premium Efficiency Three-Phase

Product code : 14836778

Catalog # : 03036OT3E284JPV-W40

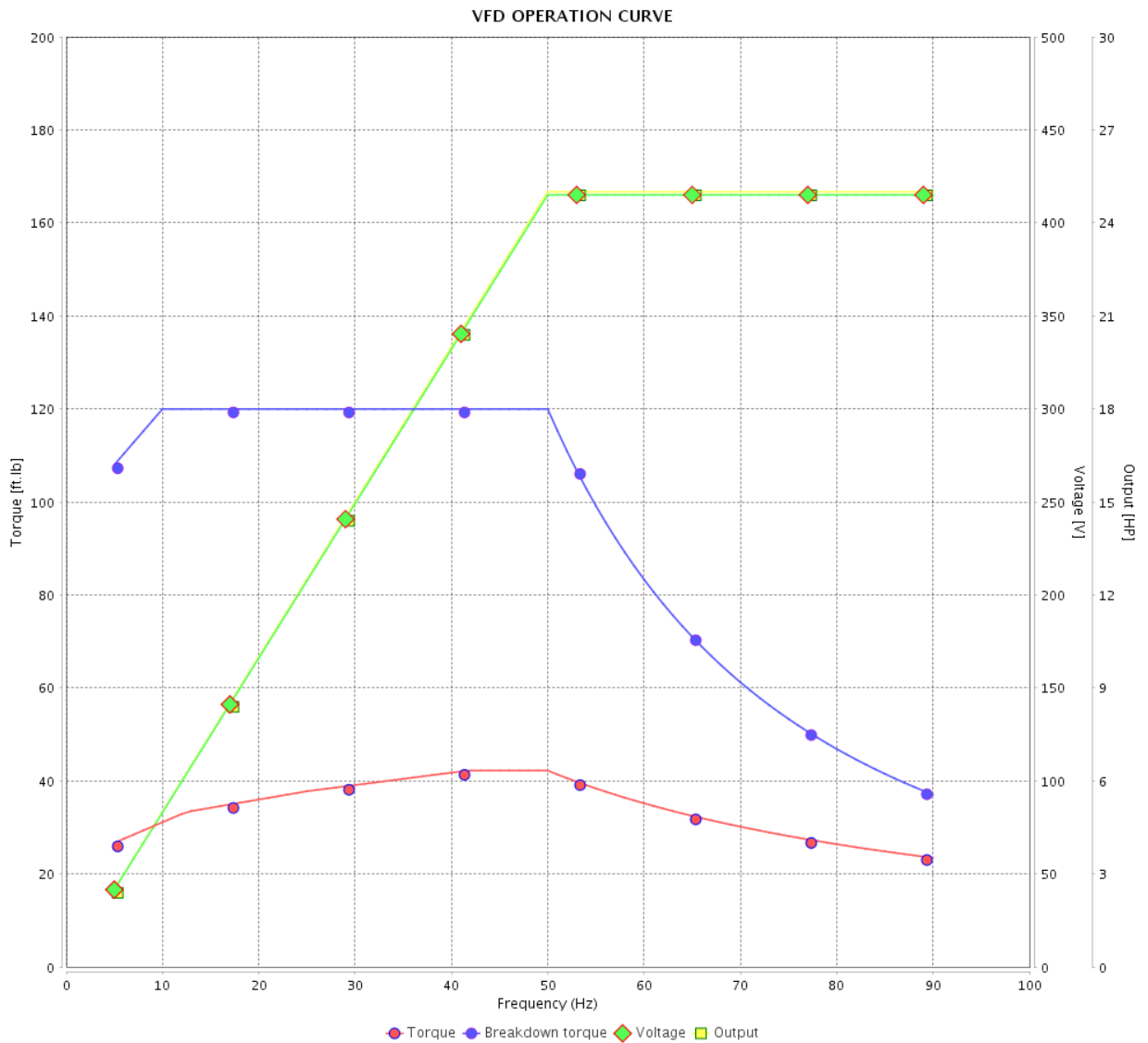

Performance : 415 V 50 Hz 2P IE3

Rated current : 33.6 A
 LRC : 6.7
 Rated torque : 44.4 ft.lb
 Locked rotor torque : 200 %
 Breakdown torque : 270 %
 Rated speed : 2955 rpm

Moment of inertia (J) : 1.59 sq.ft.lb
 Duty cycle : Cont.(S1)
 Insulation class : F
 Service factor : 1.00
 Temperature rise : 80 K
 Design : B

Rev.	Changes Summary	Performed	Checked	Date
Performed by			Page 21 / 21	Revision
Checked by				
Date	14/04/2022			

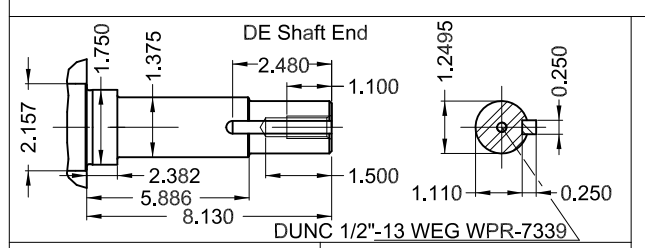
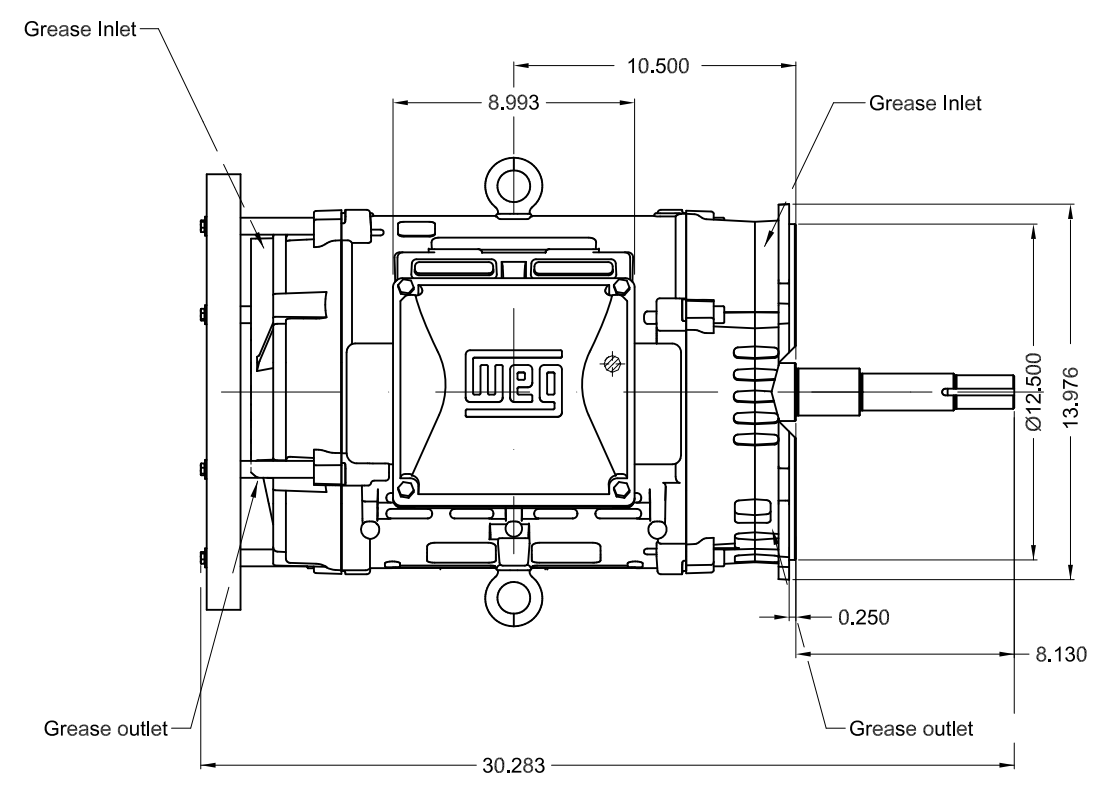
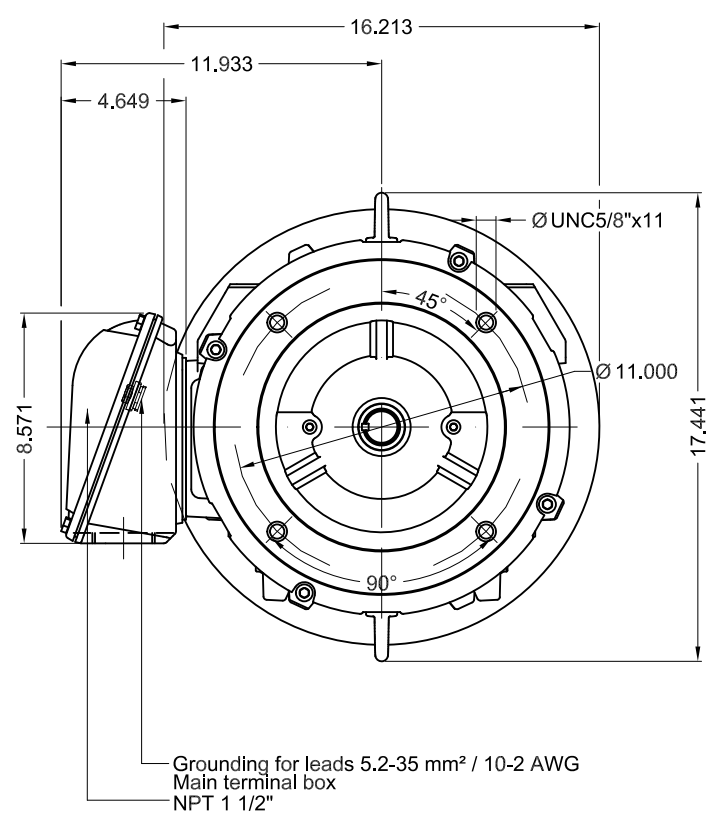

30 HP 02 Poles 60 Hz A

1:7

ECM	LOC	SUMMARY OF MODIFICATIONS	EXECUTED	CHECKED	RELEASED	DATE	VER
EXECUTED	PIRWBUSER	THREE PH. MOTOR W40 CLOSE COUPLED PUMP JP TYPE PREM 100					
CHECKED		FRAME 284/6JP IP23 ODP					
RELEASED							
REL DT.	WMO	Jaragua do Sul	Product Engineering	SHEET	1 / 1		

Color RAL 5009
 Painting plan 203A
 Mounting NEMA W-6
 Mounting V18

PREVIEW
 WDD

