

# DATA SHEET

## Three Phase Induction Motor - Squirrel Cage



Customer :					
Product line	: W40 NEMA Premium Efficiency Three-Phase	Product code :	14270659		
		Catalog # :	04012OT3E364T-W40		
Frame	: 364/5T	Cooling method	: IC01 - ODP		
Insulation class	: F	Mounting	: F-1		
Duty cycle	: Cont.(S1)	Rotation <sup>1</sup>	: Both (CW and CCW)		
Ambient temperature	: -20°C to +40°C	Starting method	: Direct On Line		
Altitude	: 1000 m.a.s.l.	Approx. weight <sup>2</sup>	: 745 lb		
Protection degree	: IP23	Moment of inertia (J)	: 21.8 sq.ft.lb		
Design	: B				
Output [HP]	40	30	30	30	
Poles	6	6	6	6	
Frequency [Hz]	60	50	50	50	
Rated voltage [V]	230/460	380	400	415	
Rated current [A]	94.2/47.1	42.7	41.0	40.0	
L. R. Amperes [A]	603/301	295	287	320	
LRC [A]	6.4x(Code G)	6.9x(Code H)	7.0x(Code H)	8.0x(Code J)	
No load current [A]	31.6/15.8	15.6	16.7	17.6	
Rated speed [RPM]	1185	985	985	985	
Slip [%]	1.25	1.50	1.50	1.50	
Rated torque [ft.lb]	177	160	160	160	
Locked rotor torque [%]	200	200	229	250	
Breakdown torque [%]	229	260	290	310	
Service factor	1.25	1.00	1.00	1.00	
Temperature rise	80 K	80 K	80 K	80 K	
Locked rotor time	39s (cold) 22s (hot)	45s (cold) 25s (hot)	50s (cold) 28s (hot)	41s (cold) 23s (hot)	
Noise level <sup>2</sup>	68.0 dB(A)				
Efficiency (%)	25%	93.5	91.7	91.7	91.7
	50%	93.6	91.8	91.8	91.8
	75%	94.1	92.2	92.2	92.2
	100%	94.1	92.2	92.2	92.2
Power Factor	25%	0.49	0.47	0.43	0.41
	50%	0.74	0.72	0.69	0.66
	75%	0.82	0.82	0.79	0.78
	100%	0.85	0.85	0.84	0.83
Bearing type	: <u>Drive end</u> 6314 C3 <u>Non drive end</u> 6212 Z C3	Foundation loads			
Sealing	: Without Without	Max. traction	: 1326 lb		
	: Bearing Seal Bearing Seal	Max. compression	: 2072 lb		
Lubrication interval	: 20000 h 20000 h				
Lubricant amount	: 27 g 13 g				
Lubricant type	: Mobil Polyrex EM				
Notes USABLE @208V 104A SF 1.15 SFA 120A					
This revision replaces and cancel the previous one, which must be eliminated. (1) Looking the motor from the shaft end. (2) Measured at 1m and with tolerance of +3dB(A). (3) Approximate weight subject to changes after manufacturing process. (4) At 100% of full load.			These are average values based on tests with sinusoidal power supply, subject to the tolerances stipulated in NEMA MG-1.		
Rev.	Changes Summary		Performed	Checked	Date
Performed by					
Checked by				Page	Revision
Date	12/04/2022			1 / 21	

# TORQUE AND CURRENT VS SPEED CURVE

Three Phase Induction Motor - Squirrel Cage



Customer :

Product line : W40 NEMA Premium Efficiency  
Three-Phase

Product code : 14270659

Catalog # : 04012OT3E364T-W40

TORQUE AND CURRENT VS SPEED CURVE

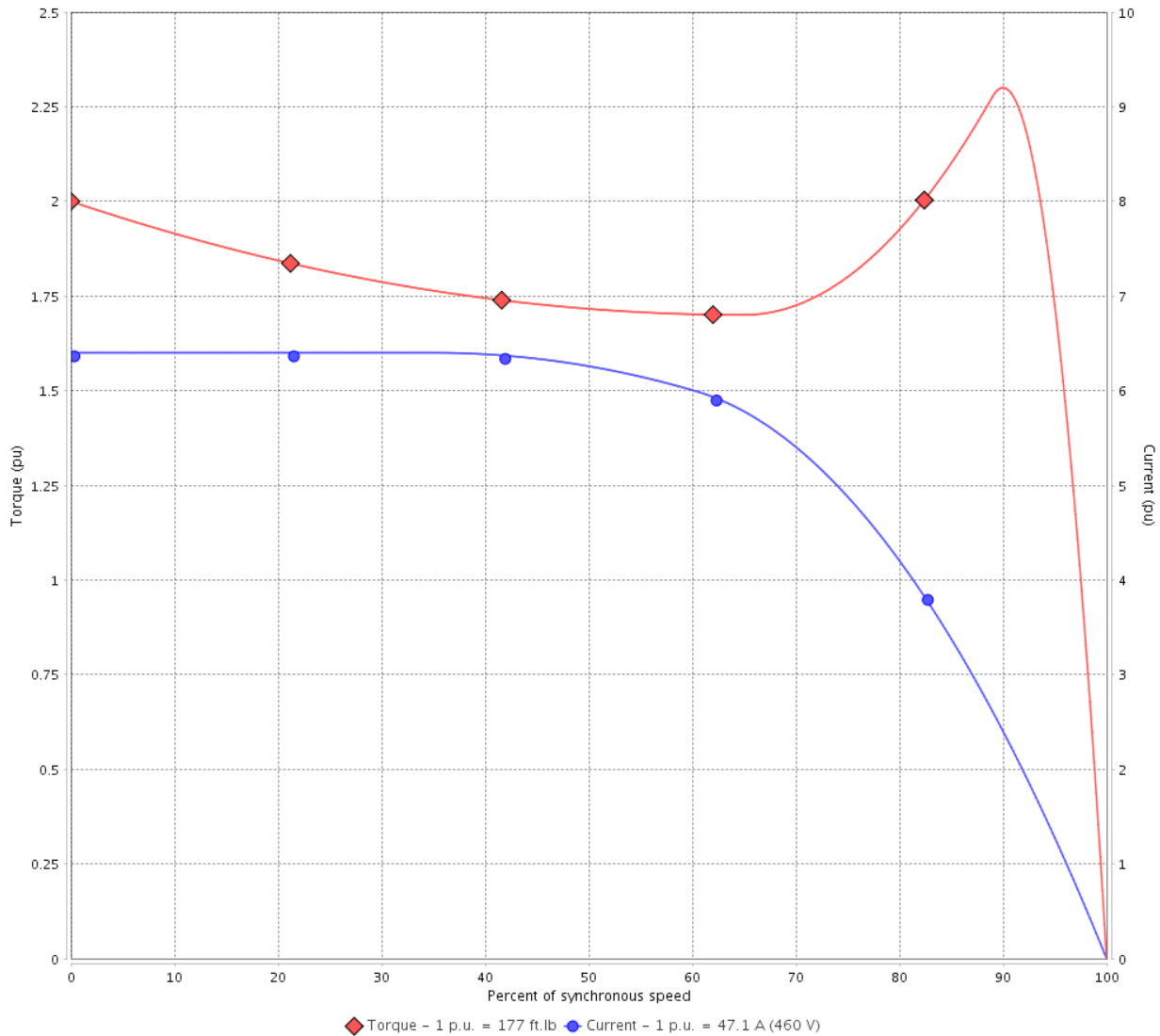

Performance : 230/460 V 60 Hz 6P

Rated current : 94.2/47.1 A  
LRC : 6.4  
Rated torque : 177 ft.lb  
Locked rotor torque : 200 %  
Breakdown torque : 229 %  
Rated speed : 1185 rpm

Moment of inertia (J) : 21.8 sq.ft.lb  
Duty cycle : Cont.(S1)  
Insulation class : F  
Service factor : 1.25  
Temperature rise : 80 K  
Design : B

Locked rotor time : 39s (cold) 22s (hot)

Rev.	Changes Summary	Performed	Checked	Date
Performed by			Page 2 / 21	Revision
Checked by				
Date	12/04/2022			

# TORQUE AND CURRENT VS SPEED CURVE



## Three Phase Induction Motor - Squirrel Cage

Customer :

Product line : W40 NEMA Premium Efficiency  
Three-Phase

Product code : 14270659

Catalog # : 04012OT3E364T-W40

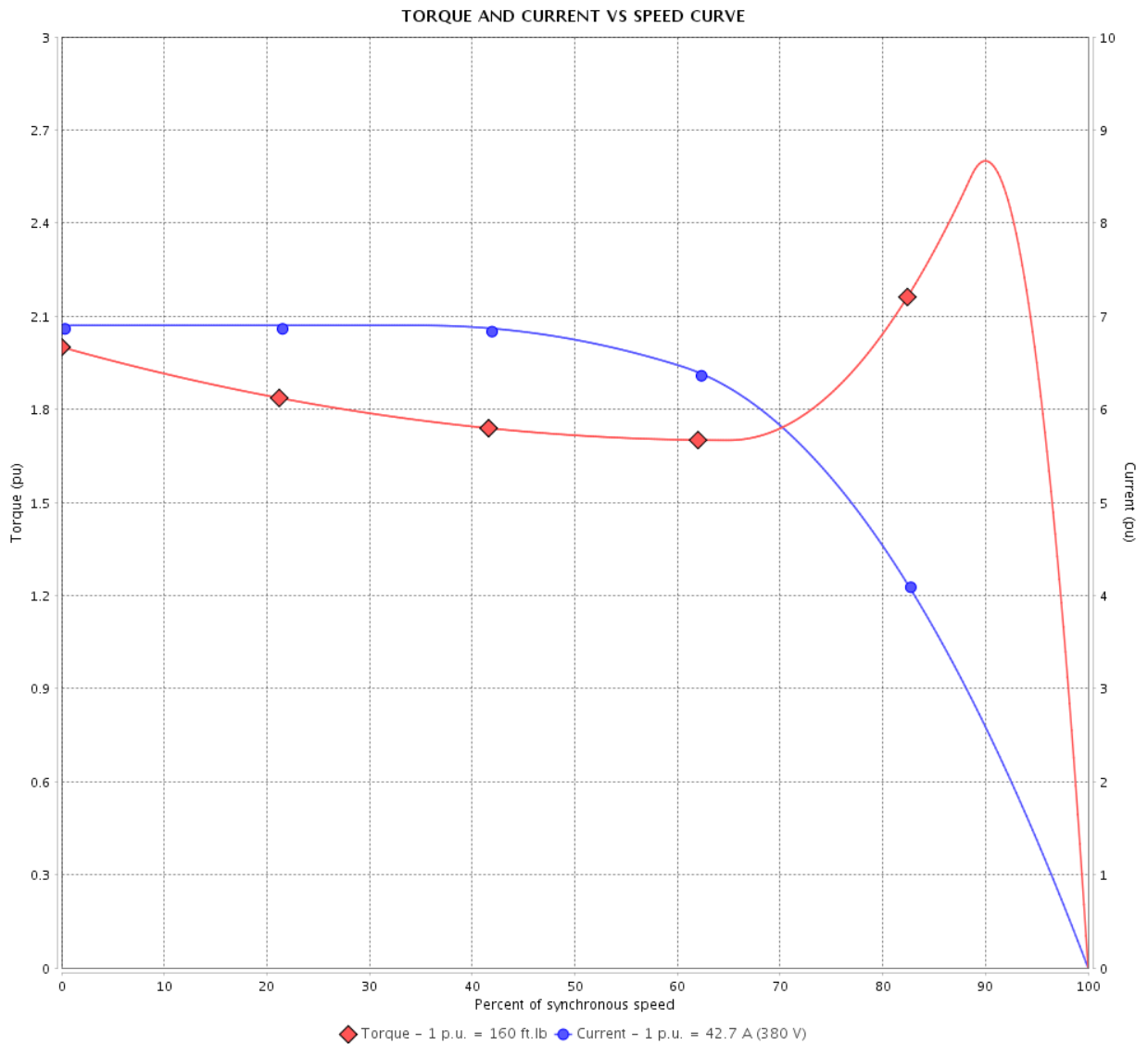

Performance : 380 V 50 Hz 6P IE3

Rated current	: 42.7 A	Moment of inertia (J)	: 21.8 sq.ft.lb
LRC	: 6.9	Duty cycle	: Cont.(S1)
Rated torque	: 160 ft.lb	Insulation class	: F
Locked rotor torque	: 200 %	Service factor	: 1.00
Breakdown torque	: 260 %	Temperature rise	: 80 K
Rated speed	: 985 rpm	Design	: B

Locked rotor time : 45s (cold) 25s (hot)

Rev.	Changes Summary	Performed	Checked	Date
Performed by			Page 3 / 21	Revision
Checked by				
Date	12/04/2022			

# TORQUE AND CURRENT VS SPEED CURVE

Three Phase Induction Motor - Squirrel Cage



Customer :

Product line : W40 NEMA Premium Efficiency  
Three-Phase

Product code : 14270659

Catalog # : 04012OT3E364T-W40

TORQUE AND CURRENT VS SPEED CURVE

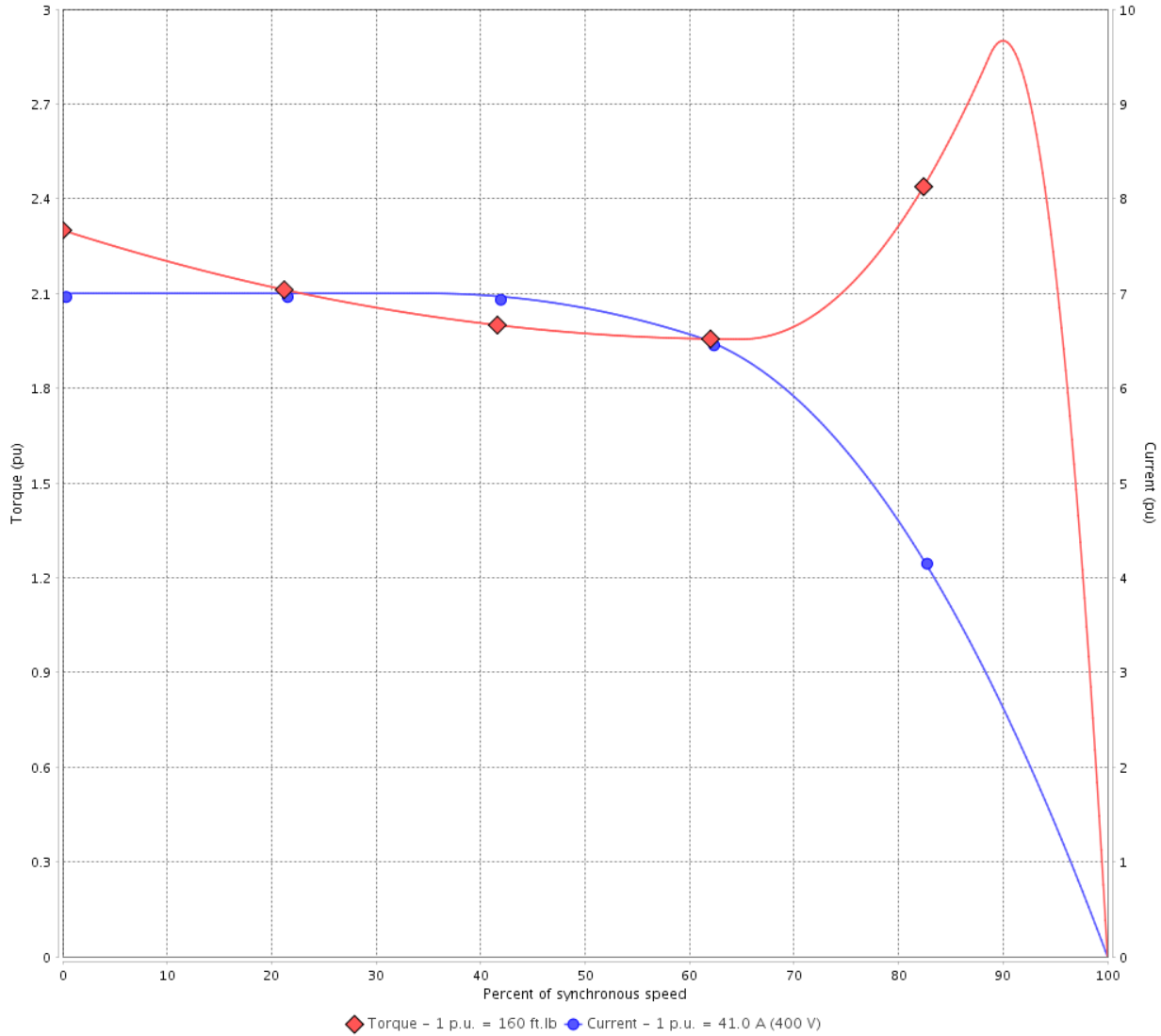

Performance : 400 V 50 Hz 6P IE3

Rated current	: 41.0 A	Moment of inertia (J)	: 21.8 sq.ft.lb
LRC	: 7.0	Duty cycle	: Cont.(S1)
Rated torque	: 160 ft.lb	Insulation class	: F
Locked rotor torque	: 229 %	Service factor	: 1.00
Breakdown torque	: 290 %	Temperature rise	: 80 K
Rated speed	: 985 rpm	Design	: B

Locked rotor time : 50s (cold) 28s (hot)

Rev.	Changes Summary	Performed	Checked	Date
Performed by			Page 4 / 21	Revision
Checked by				
Date	12/04/2022			

# TORQUE AND CURRENT VS SPEED CURVE



## Three Phase Induction Motor - Squirrel Cage

Customer :

Product line : W40 NEMA Premium Efficiency  
Three-Phase

Product code : 14270659

Catalog # : 04012OT3E364T-W40

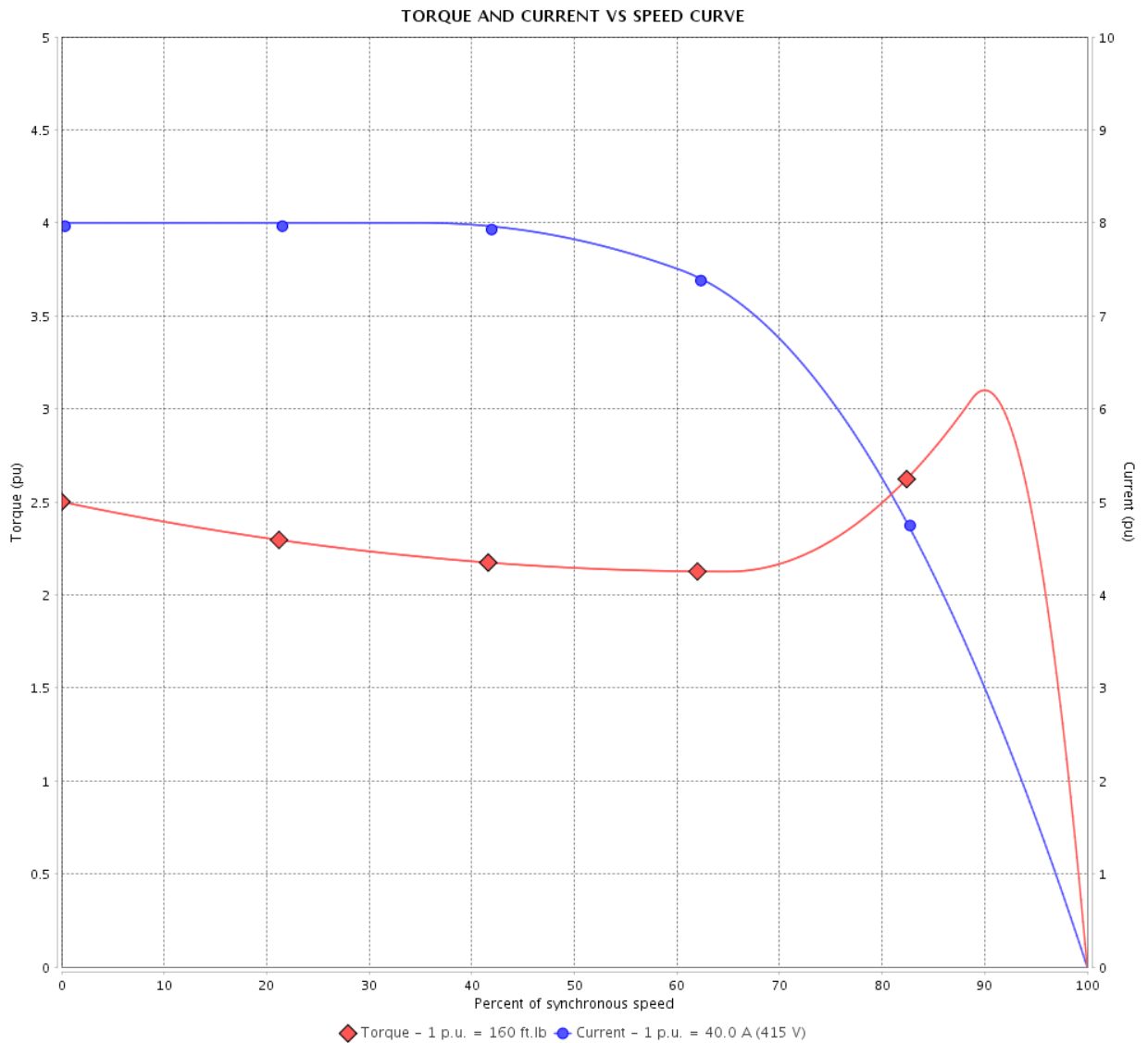

Performance : 415 V 50 Hz 6P IE3

Rated current	: 40.0 A	Moment of inertia (J)	: 21.8 sq.ft.lb
LRC	: 8.0	Duty cycle	: Cont.(S1)
Rated torque	: 160 ft.lb	Insulation class	: F
Locked rotor torque	: 250 %	Service factor	: 1.00
Breakdown torque	: 310 %	Temperature rise	: 80 K
Rated speed	: 985 rpm	Design	: B

Locked rotor time : 41s (cold) 23s (hot)

Rev.	Changes Summary	Performed	Checked	Date
Performed by			Page 5 / 21	Revision
Checked by				
Date	12/04/2022			

# LOAD PERFORMANCE CURVE

## Three Phase Induction Motor - Squirrel Cage



Customer :

Product line : W40 NEMA Premium Efficiency  
Three-Phase

Product code : 14270659

Catalog # : 04012OT3E364T-W40

LOAD PERFORMANCE CURVE

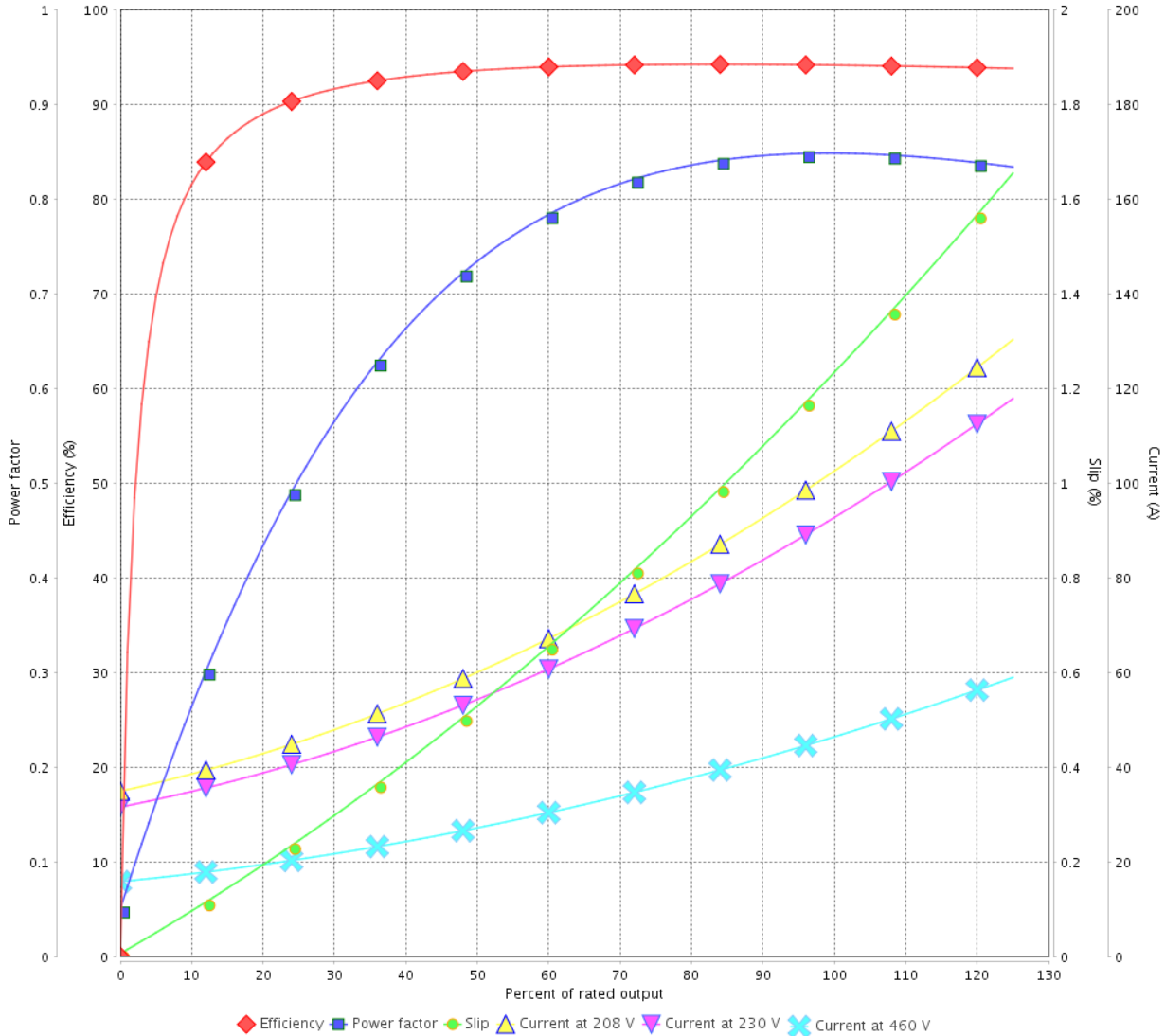

Performance : 230/460 V 60 Hz 6P

Rated current : 94.2/47.1 A  
 LRC : 6.4  
 Rated torque : 177 ft.lb  
 Locked rotor torque : 200 %  
 Breakdown torque : 229 %  
 Rated speed : 1185 rpm

Moment of inertia (J) : 21.8 sq.ft.lb  
 Duty cycle : Cont.(S1)  
 Insulation class : F  
 Service factor : 1.25  
 Temperature rise : 80 K  
 Design : B

Rev.	Changes Summary	Performed	Checked	Date
Performed by			Page 6 / 21	Revision
Checked by				
Date	12/04/2022			

# LOAD PERFORMANCE CURVE

## Three Phase Induction Motor - Squirrel Cage



Customer :

Product line : W40 NEMA Premium Efficiency Three-Phase

Product code : 14270659

Catalog # : 040120T3E364T-W40

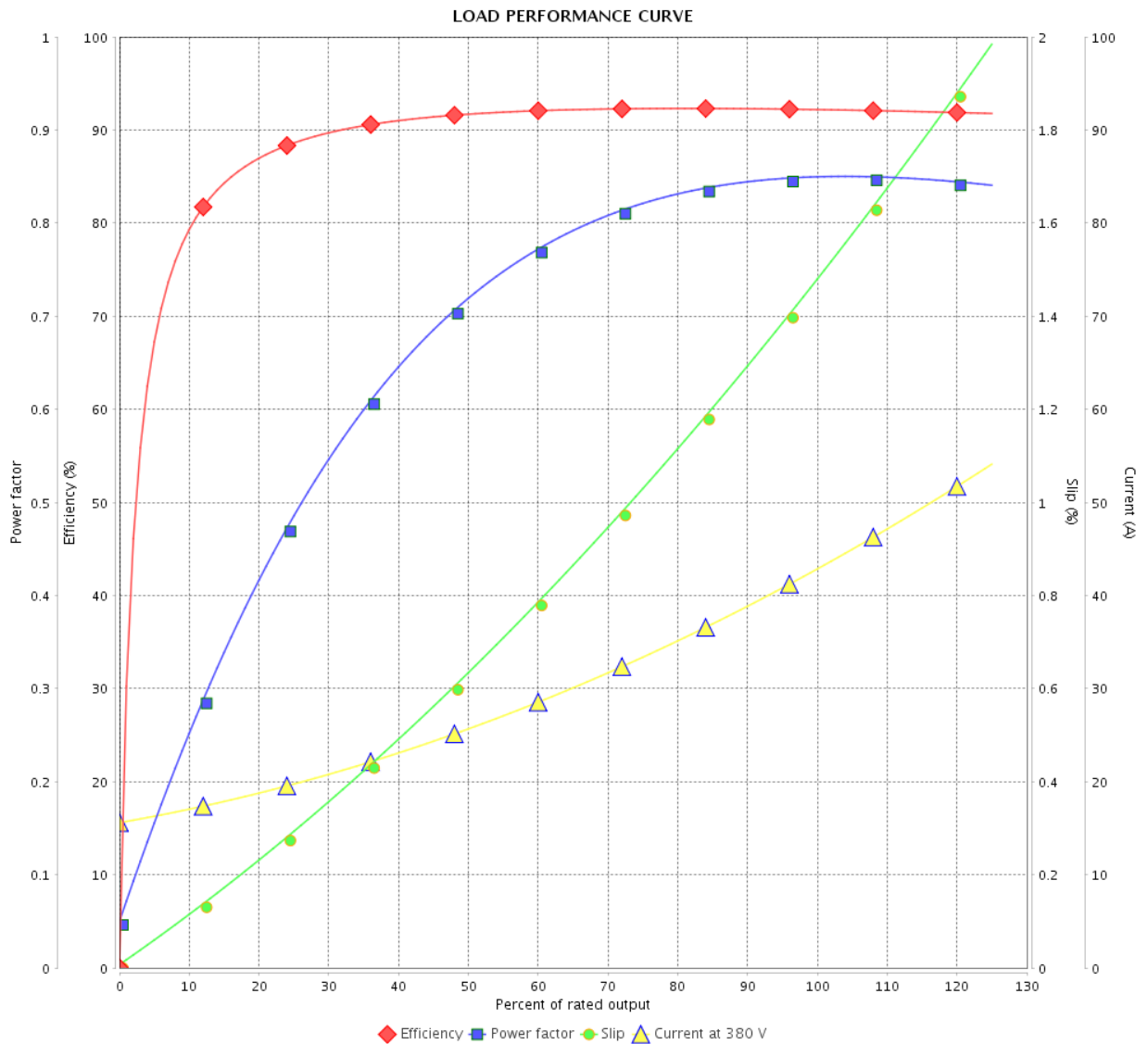

Performance : 380 V 50 Hz 6P IE3

Rated current : 42.7 A  
 LRC : 6.9  
 Rated torque : 160 ft.lb  
 Locked rotor torque : 200 %  
 Breakdown torque : 260 %  
 Rated speed : 985 rpm

Moment of inertia (J) : 21.8 sq.ft.lb  
 Duty cycle : Cont.(S1)  
 Insulation class : F  
 Service factor : 1.00  
 Temperature rise : 80 K  
 Design : B

Rev.	Changes Summary	Performed	Checked	Date
Performed by		Page		Revision
Checked by		7 / 21		
Date		12/04/2022		

# LOAD PERFORMANCE CURVE

Three Phase Induction Motor - Squirrel Cage



Customer :

Product line : W40 NEMA Premium Efficiency  
Three-Phase

Product code : 14270659

Catalog # : 040120T3E364T-W40

LOAD PERFORMANCE CURVE

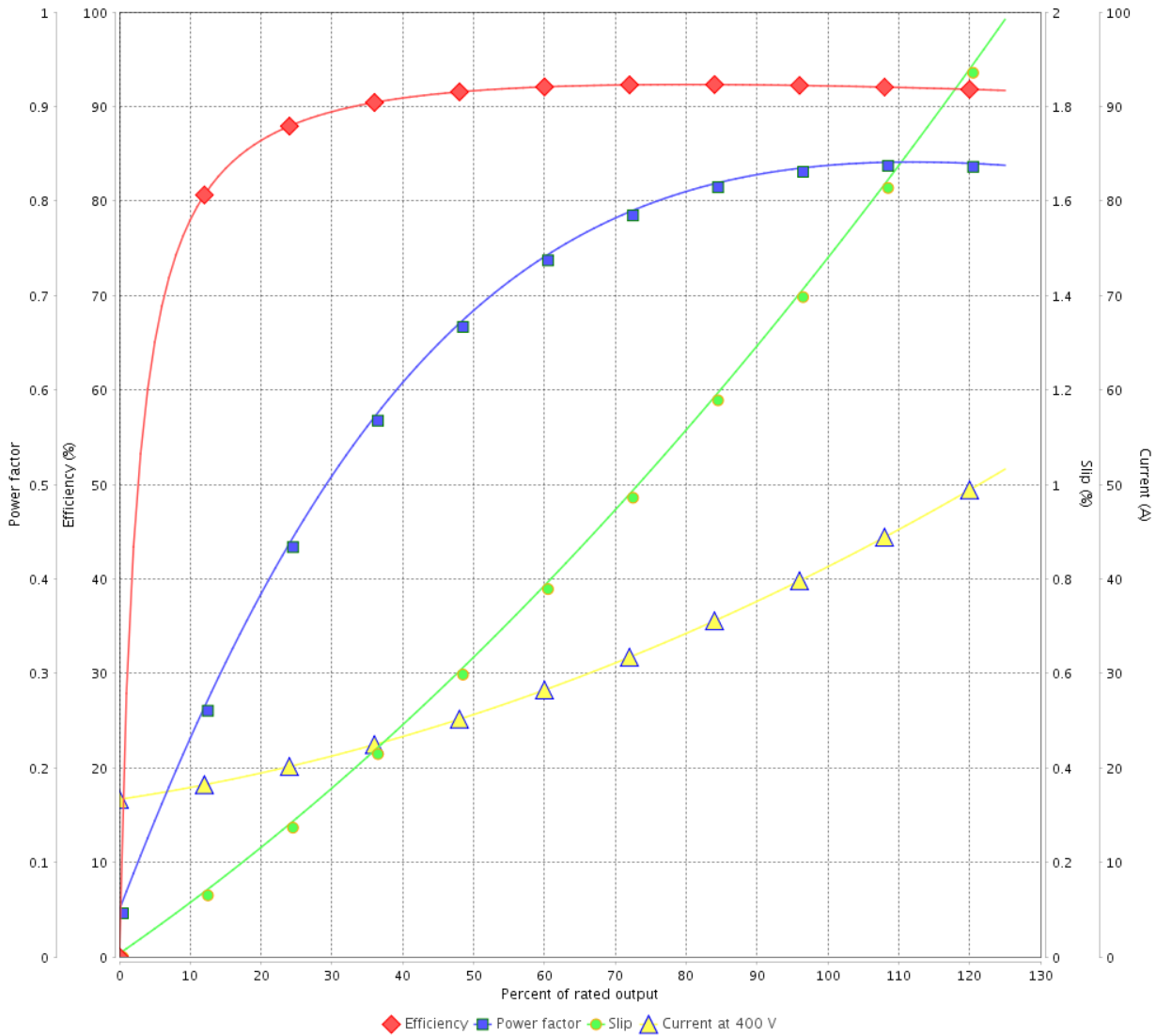

Performance : 400 V 50 Hz 6P IE3

Rated current : 41.0 A  
LRC : 7.0  
Rated torque : 160 ft.lb  
Locked rotor torque : 229 %  
Breakdown torque : 290 %  
Rated speed : 985 rpm

Moment of inertia (J) : 21.8 sq.ft.lb  
Duty cycle : Cont.(S1)  
Insulation class : F  
Service factor : 1.00  
Temperature rise : 80 K  
Design : B

Rev.	Changes Summary	Performed	Checked	Date
Performed by		Page		Revision
Checked by		8 / 21		
Date		12/04/2022		



# LOAD PERFORMANCE CURVE

## Three Phase Induction Motor - Squirrel Cage



Customer :

Product line : W40 NEMA Premium Efficiency Three-Phase

Product code : 14270659

Catalog # : 04012OT3E364T-W40

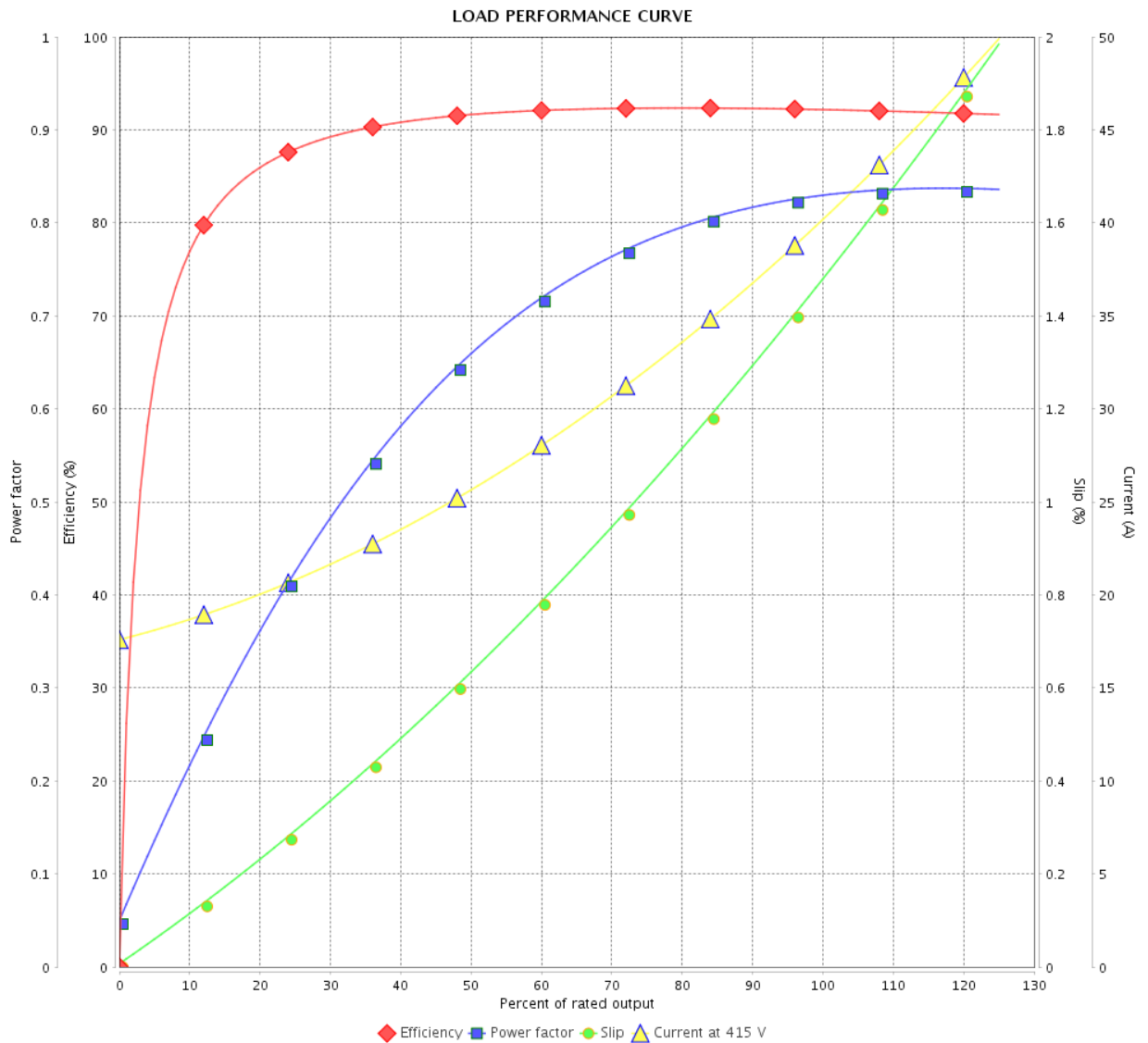

Performance : 415 V 50 Hz 6P IE3

Rated current : 40.0 A  
 LRC : 8.0  
 Rated torque : 160 ft.lb  
 Locked rotor torque : 250 %  
 Breakdown torque : 310 %  
 Rated speed : 985 rpm

Moment of inertia (J) : 21.8 sq.ft.lb  
 Duty cycle : Cont.(S1)  
 Insulation class : F  
 Service factor : 1.00  
 Temperature rise : 80 K  
 Design : B

Rev.	Changes Summary	Performed	Checked	Date
Performed by		Page		Revision
Checked by		9 / 21		
Date		12/04/2022		

# THERMAL LIMIT CURVE



## Three Phase Induction Motor - Squirrel Cage

Customer :

Product line : W40 NEMA Premium Efficiency Three-Phase  
 Product code : 14270659  
 Catalog # : 04012OT3E364T-W40

Performance : 230/460 V 60 Hz 6P

Rated current : 94.2/47.1 A	Moment of inertia (J) : 21.8 sq.ft.lb
LRC : 6.4	Duty cycle : Cont.(S1)
Rated torque : 177 ft.lb	Insulation class : F
Locked rotor torque : 200 %	Service factor : 1.25
Breakdown torque : 229 %	Temperature rise : 80 K
Rated speed : 1185 rpm	Design : B

Heating constant

Cooling constant

Rev.	Changes Summary	Performed	Checked	Date
Performed by			Page 10 / 21	Revision
Checked by				
Date	12/04/2022			

# THERMAL LIMIT CURVE

Three Phase Induction Motor - Squirrel Cage



Customer : \_\_\_\_\_

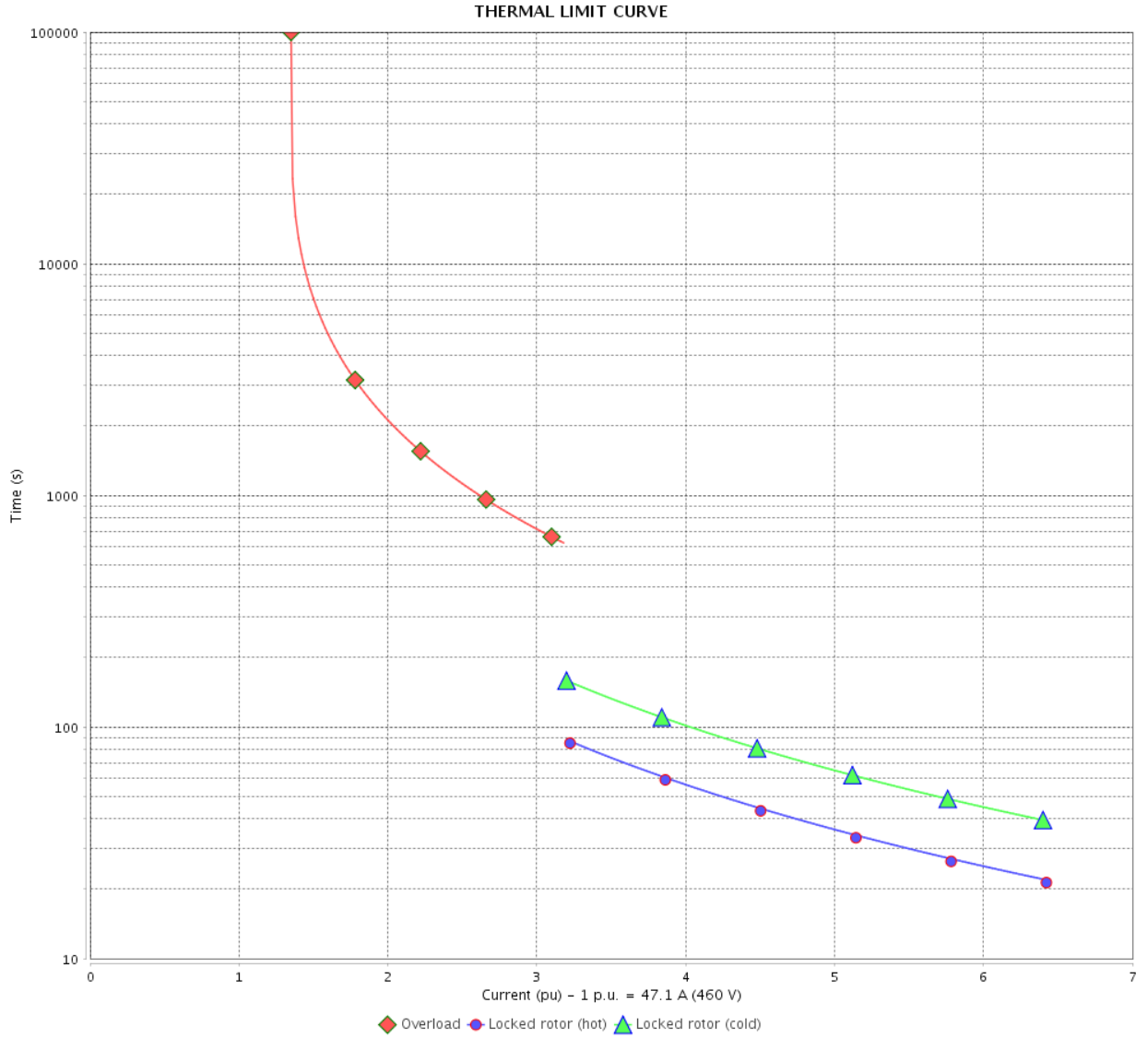

Rev.	Changes Summary	Performed	Checked	Date
Performed by		Page		Revision
Checked by		11 / 21		
Date		12/04/2022		

# THERMAL LIMIT CURVE



## Three Phase Induction Motor - Squirrel Cage

Customer :

Product line : W40 NEMA Premium Efficiency  
Three-Phase

Product code : 14270659

Catalog # : 04012OT3E364T-W40

Performance : 380 V 50 Hz 6P IE3

Rated current : 42.7 A	Moment of inertia (J) : 21.8 sq.ft.lb
LRC : 6.9	Duty cycle : Cont.(S1)
Rated torque : 160 ft.lb	Insulation class : F
Locked rotor torque : 200 %	Service factor : 1.00
Breakdown torque : 260 %	Temperature rise : 80 K
Rated speed : 985 rpm	Design : B

Heating constant

Cooling constant

Rev.	Changes Summary	Performed	Checked	Date
Performed by			Page 12 / 21	Revision
Checked by				
Date	12/04/2022			

# THERMAL LIMIT CURVE

Three Phase Induction Motor - Squirrel Cage



Customer : \_\_\_\_\_

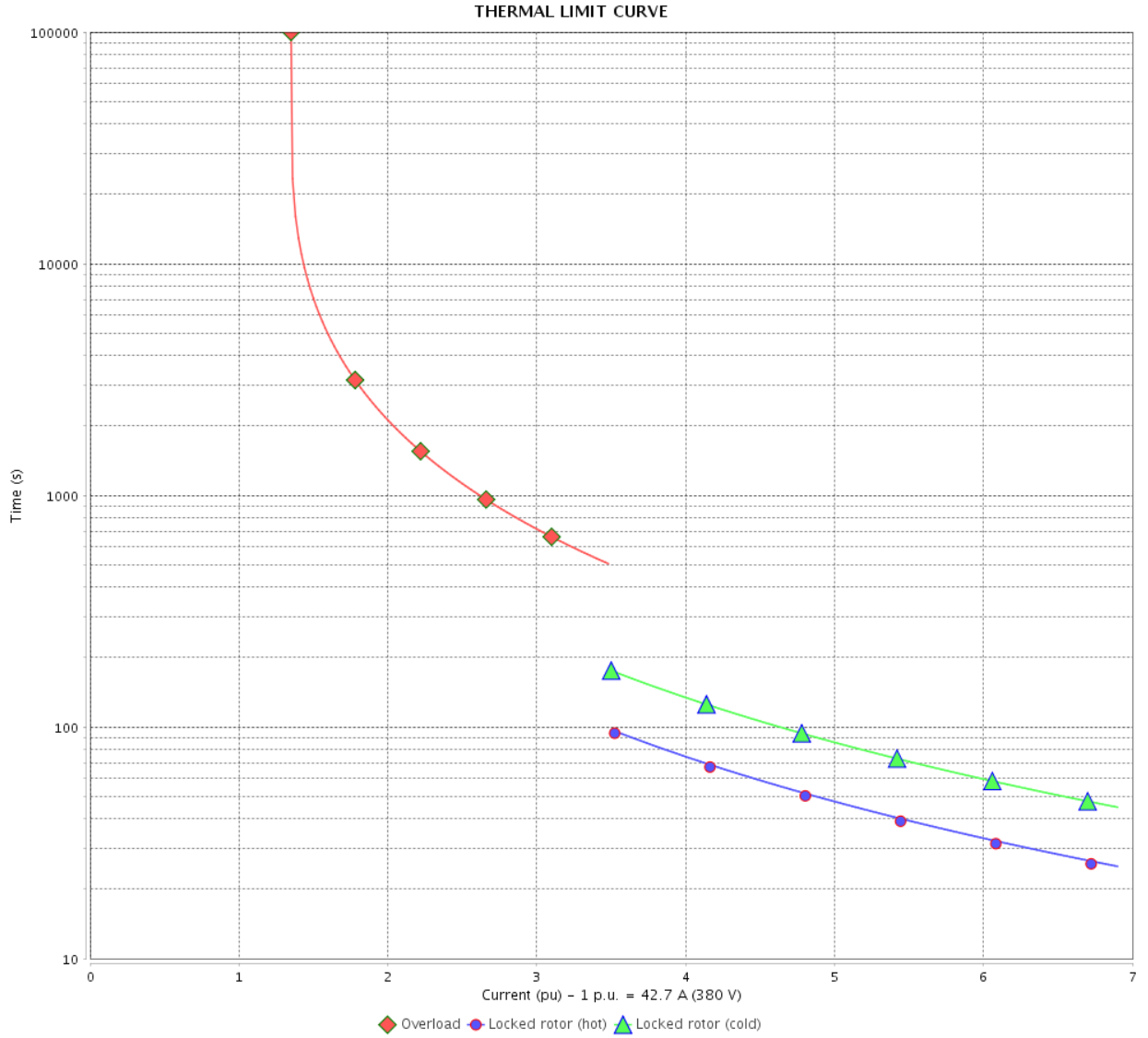

Rev.	Changes Summary	Performed	Checked	Date
Performed by		Page 13 / 21		Revision
Checked by				
Date				

# THERMAL LIMIT CURVE

## Three Phase Induction Motor - Squirrel Cage



Customer :

Product line : W40 NEMA Premium Efficiency  
Three-Phase

Product code : 14270659

Catalog # : 04012OT3E364T-W40

Performance : 400 V 50 Hz 6P IE3

Rated current	: 41.0 A	Moment of inertia (J)	: 21.8 sq.ft.lb
LRC	: 7.0	Duty cycle	: Cont.(S1)
Rated torque	: 160 ft.lb	Insulation class	: F
Locked rotor torque	: 229 %	Service factor	: 1.00
Breakdown torque	: 290 %	Temperature rise	: 80 K
Rated speed	: 985 rpm	Design	: B

Heating constant

Cooling constant

Rev.	Changes Summary	Performed	Checked	Date
Performed by				
Checked by			Page	Revision
Date	12/04/2022		14 / 21	

# THERMAL LIMIT CURVE

Three Phase Induction Motor - Squirrel Cage



Customer : \_\_\_\_\_

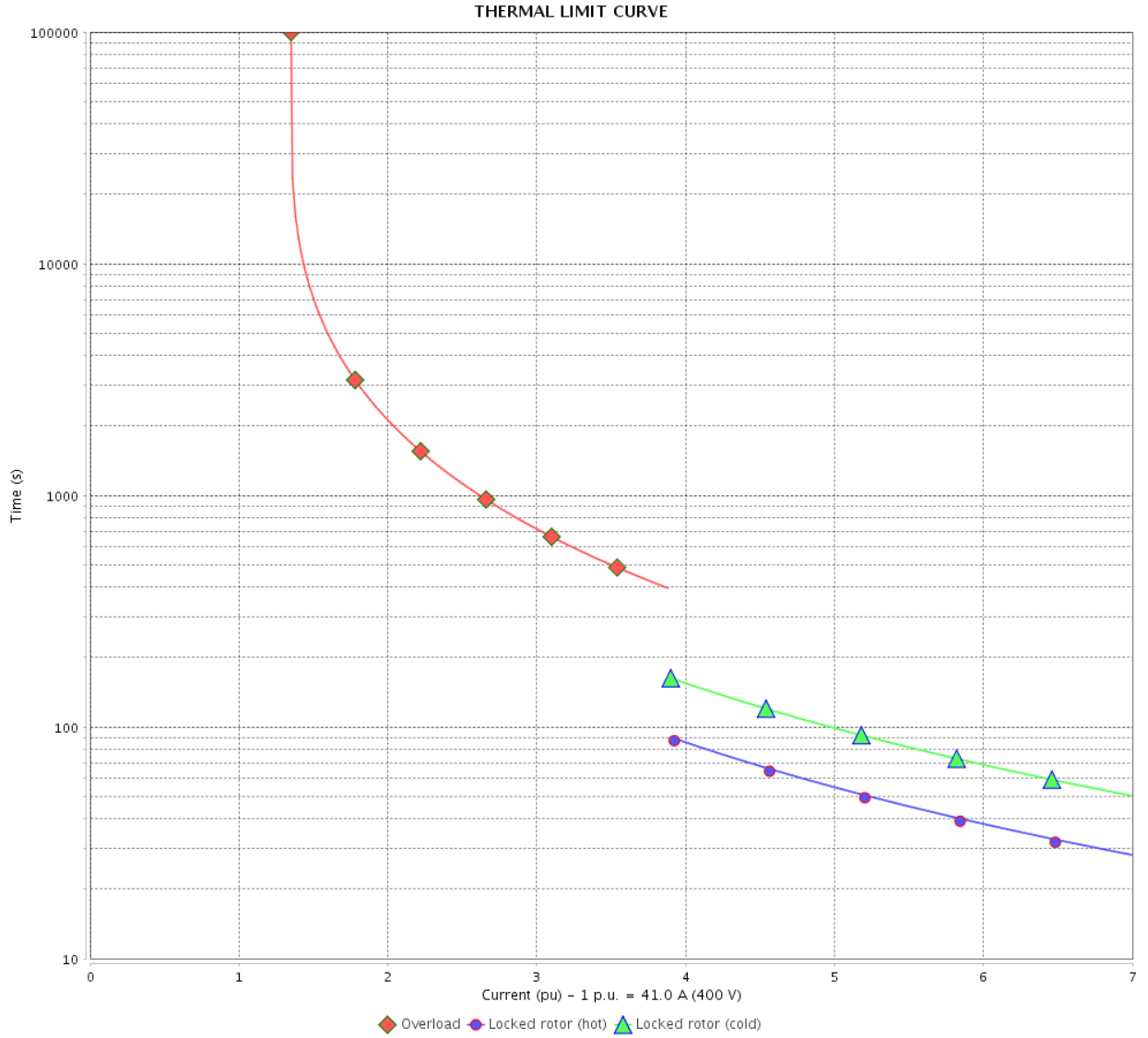

Rev.	Changes Summary	Performed	Checked	Date
Performed by		Page		Revision
Checked by		15 / 21		
Date		12/04/2022		

# THERMAL LIMIT CURVE

## Three Phase Induction Motor - Squirrel Cage



Customer :

Product line : W40 NEMA Premium Efficiency  
Three-Phase

Product code : 14270659

Catalog # : 04012OT3E364T-W40

Performance : 415 V 50 Hz 6P IE3

Rated current	: 40.0 A	Moment of inertia (J)	: 21.8 sq.ft.lb
LRC	: 8.0	Duty cycle	: Cont.(S1)
Rated torque	: 160 ft.lb	Insulation class	: F
Locked rotor torque	: 250 %	Service factor	: 1.00
Breakdown torque	: 310 %	Temperature rise	: 80 K
Rated speed	: 985 rpm	Design	: B

Heating constant

Cooling constant

Rev.	Changes Summary	Performed	Checked	Date
Performed by				
Checked by			Page	Revision
Date	12/04/2022		16 / 21	



# THERMAL LIMIT CURVE

Three Phase Induction Motor - Squirrel Cage



Customer : \_\_\_\_\_

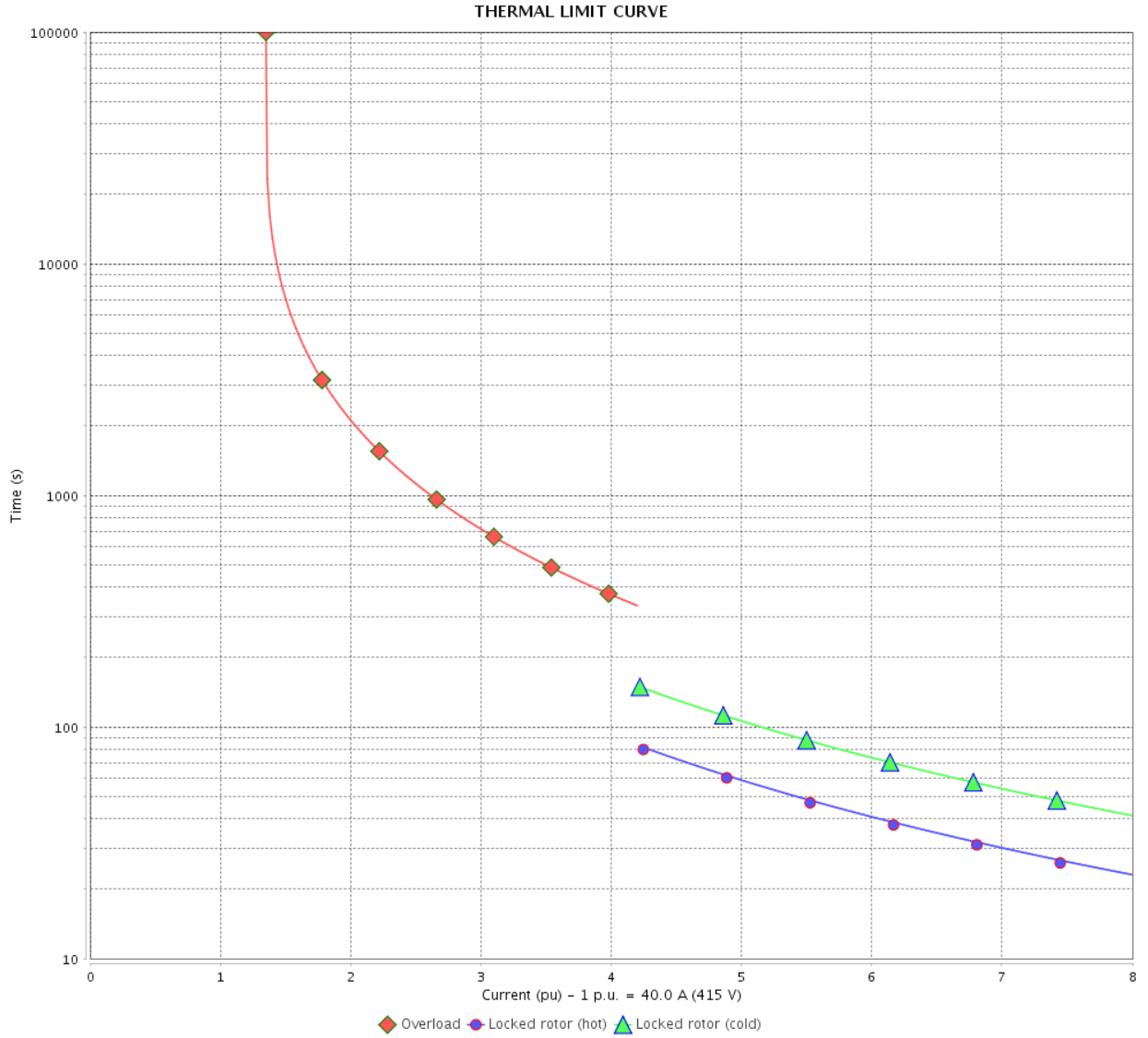

Rev.	Changes Summary	Performed	Checked	Date
Performed by		Page 17 / 21		Revision
Checked by				
Date				

# VFD OPERATION CURVE

Three Phase Induction Motor - Squirrel Cage



Customer :

Product line : W40 NEMA Premium Efficiency Three-Phase

Product code : 14270659

Catalog # : 04012OT3E364T-W40

VFD OPERATION CURVE

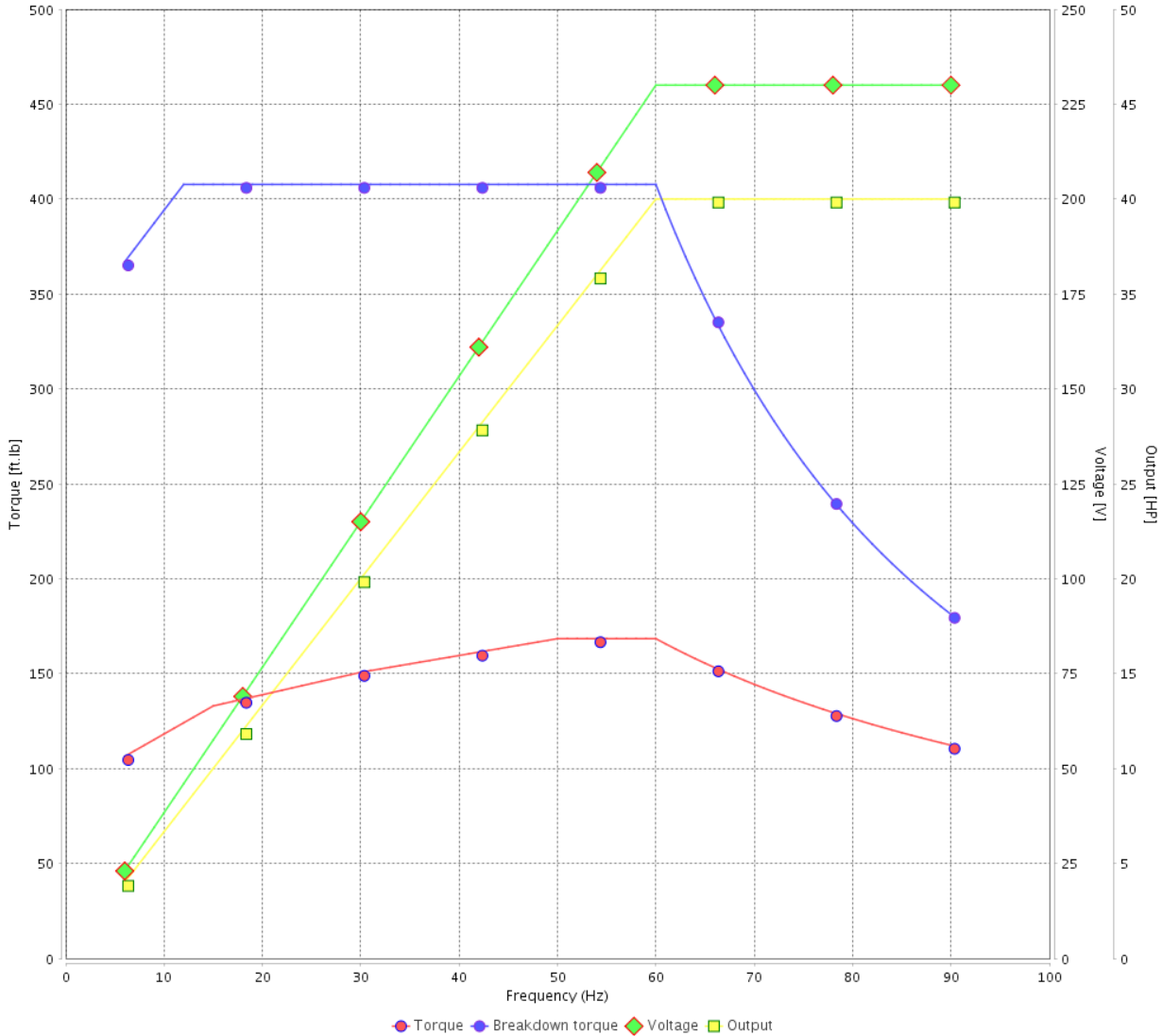

Performance : 230/460 V 60 Hz 6P

Rated current : 94.2/47.1 A  
 LRC : 6.4  
 Rated torque : 177 ft.lb  
 Locked rotor torque : 200 %  
 Breakdown torque : 229 %  
 Rated speed : 1185 rpm

Moment of inertia (J) : 21.8 sq.ft.lb  
 Duty cycle : Cont.(S1)  
 Insulation class : F  
 Service factor : 1.25  
 Temperature rise : 80 K  
 Design : B

Rev.	Changes Summary	Performed	Checked	Date
Performed by			Page	Revision
Checked by				
Date				

# VFD OPERATION CURVE

Three Phase Induction Motor - Squirrel Cage



Customer : \_\_\_\_\_

Product line : W40 NEMA Premium Efficiency  
Three-Phase

Product code : 14270659

Catalog # : 04012OT3E364T-W40

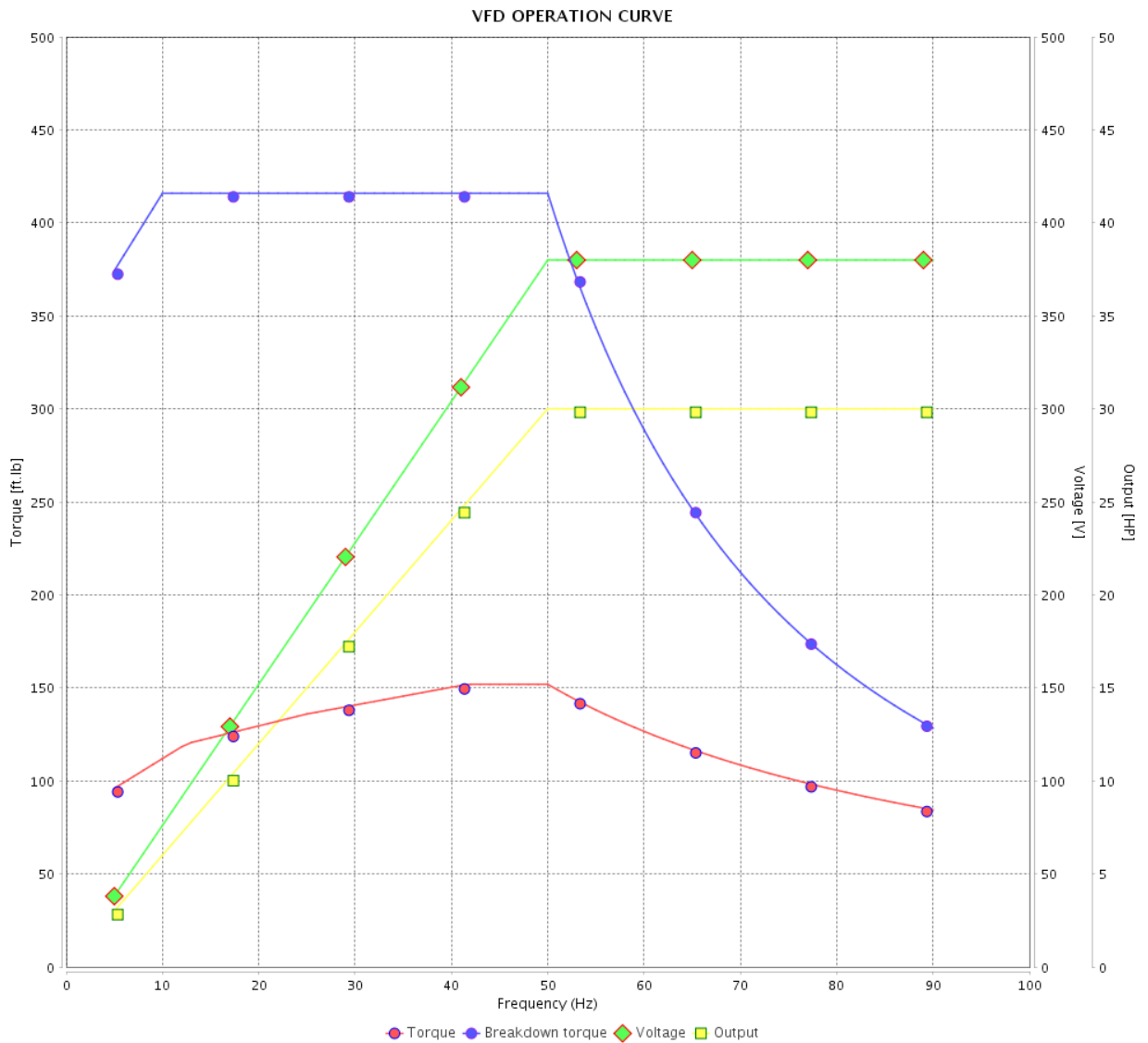

Performance : 380 V 50 Hz 6P IE3

Rated current : 42.7 A  
 LRC : 6.9  
 Rated torque : 160 ft.lb  
 Locked rotor torque : 200 %  
 Breakdown torque : 260 %  
 Rated speed : 985 rpm

Moment of inertia (J) : 21.8 sq.ft.lb  
 Duty cycle : Cont.(S1)  
 Insulation class : F  
 Service factor : 1.00  
 Temperature rise : 80 K  
 Design : B

Rev.	Changes Summary	Performed	Checked	Date
Performed by			Page 19 / 21	Revision
Checked by				
Date	12/04/2022			

# VFD OPERATION CURVE

Three Phase Induction Motor - Squirrel Cage



Customer :

Product line : W40 NEMA Premium Efficiency  
Three-Phase

Product code : 14270659

Catalog # : 04012OT3E364T-W40

VFD OPERATION CURVE

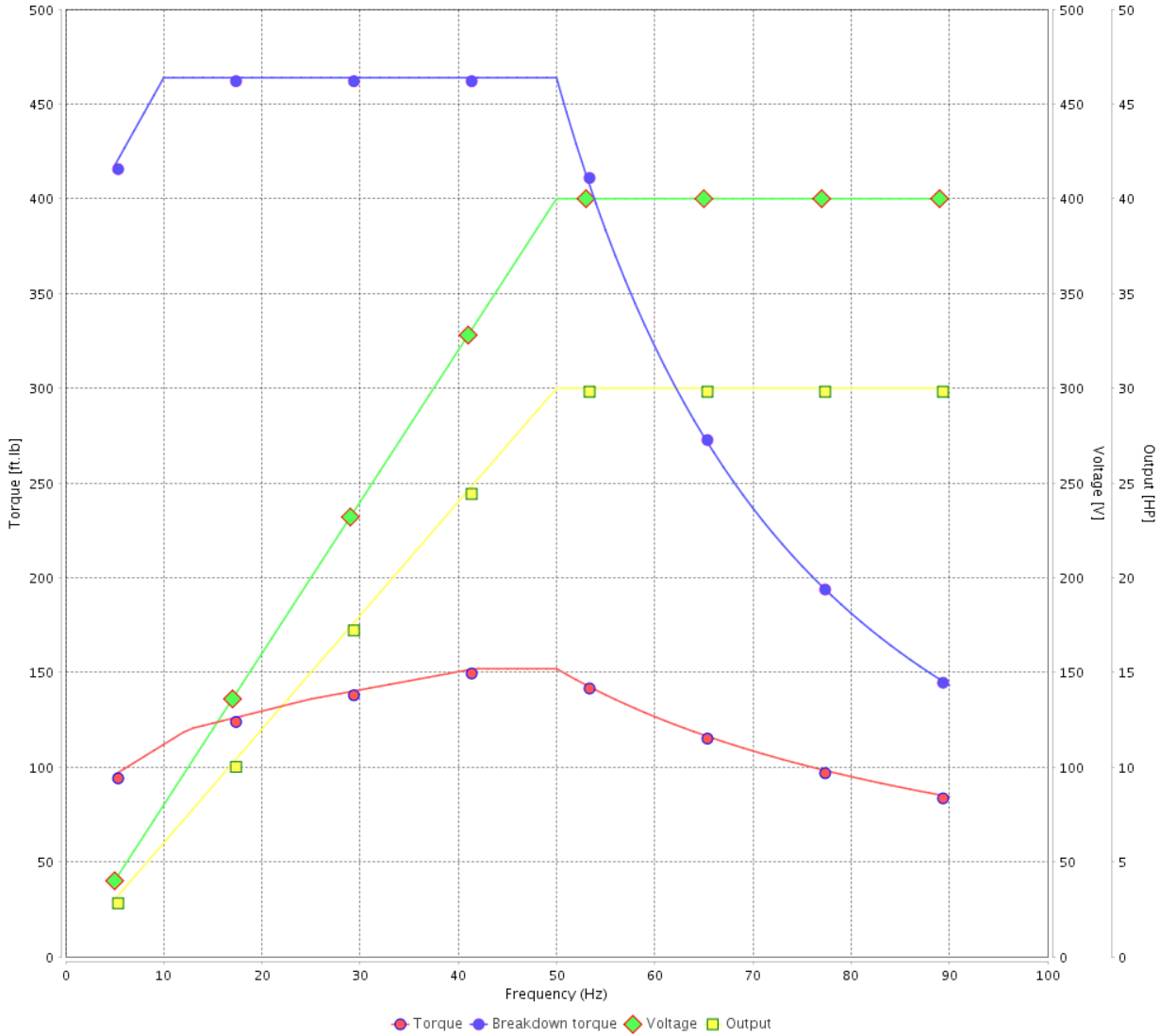

Performance : 400 V 50 Hz 6P IE3

Rated current : 41.0 A  
LRC : 7.0  
Rated torque : 160 ft.lb  
Locked rotor torque : 229 %  
Breakdown torque : 290 %  
Rated speed : 985 rpm

Moment of inertia (J) : 21.8 sq.ft.lb  
Duty cycle : Cont.(S1)  
Insulation class : F  
Service factor : 1.00  
Temperature rise : 80 K  
Design : B

Rev.	Changes Summary	Performed	Checked	Date
Performed by			Page	Revision
Checked by				
Date				

# VFD OPERATION CURVE

Three Phase Induction Motor - Squirrel Cage



Customer :

Product line : W40 NEMA Premium Efficiency  
Three-Phase

Product code : 14270659

Catalog # : 04012OT3E364T-W40

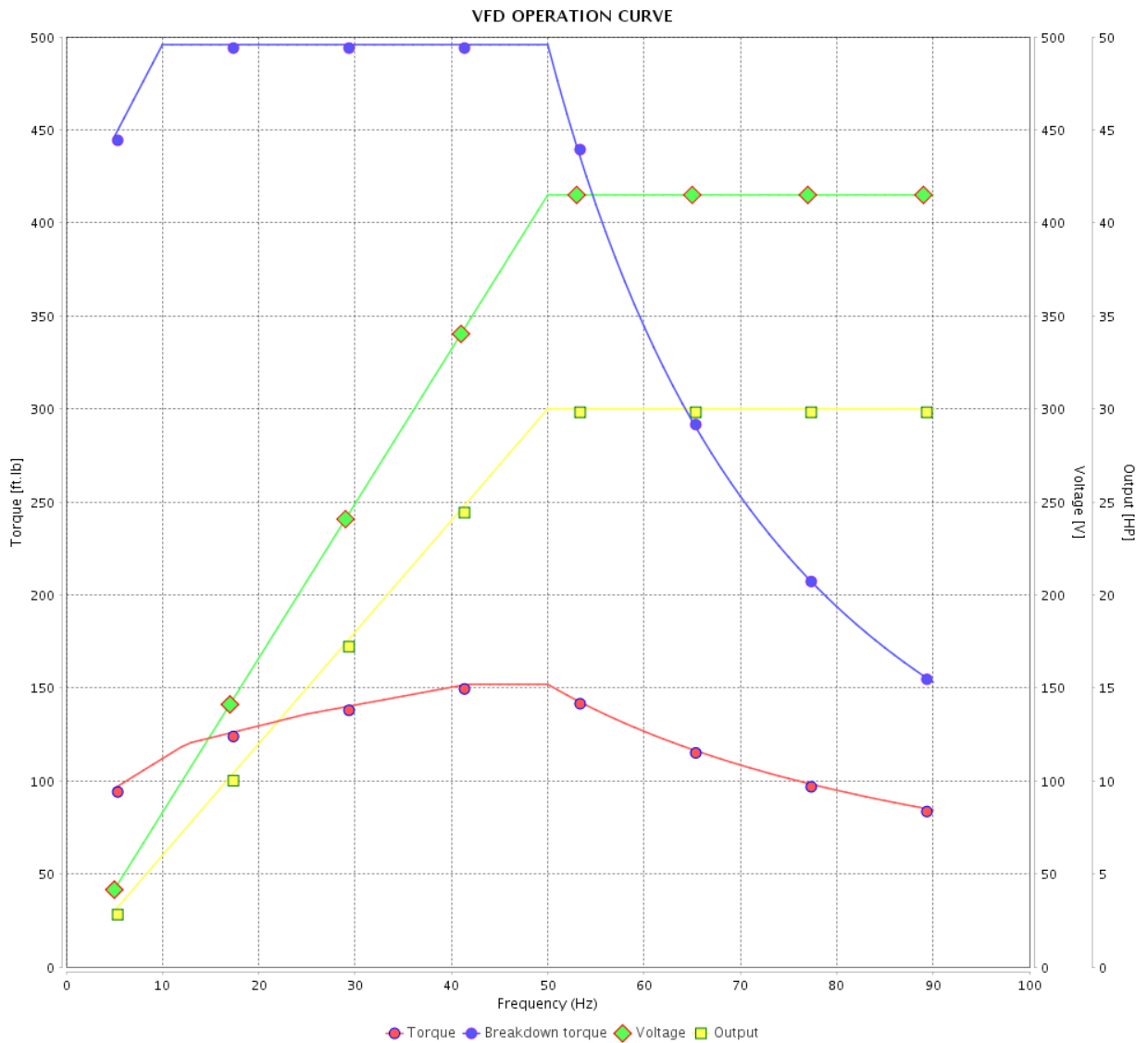

Performance : 415 V 50 Hz 6P IE3

Rated current : 40.0 A  
LRC : 8.0  
Rated torque : 160 ft.lb  
Locked rotor torque : 250 %  
Breakdown torque : 310 %  
Rated speed : 985 rpm

Moment of inertia (J) : 21.8 sq.ft.lb  
Duty cycle : Cont.(S1)  
Insulation class : F  
Service factor : 1.00  
Temperature rise : 80 K  
Design : B

Rev.	Changes Summary	Performed	Checked	Date
Performed by			Page	Revision
Checked by			21 / 21	
Date	12/04/2022			

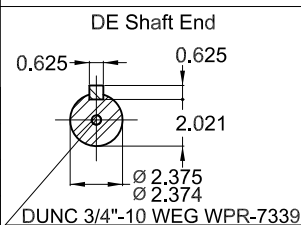
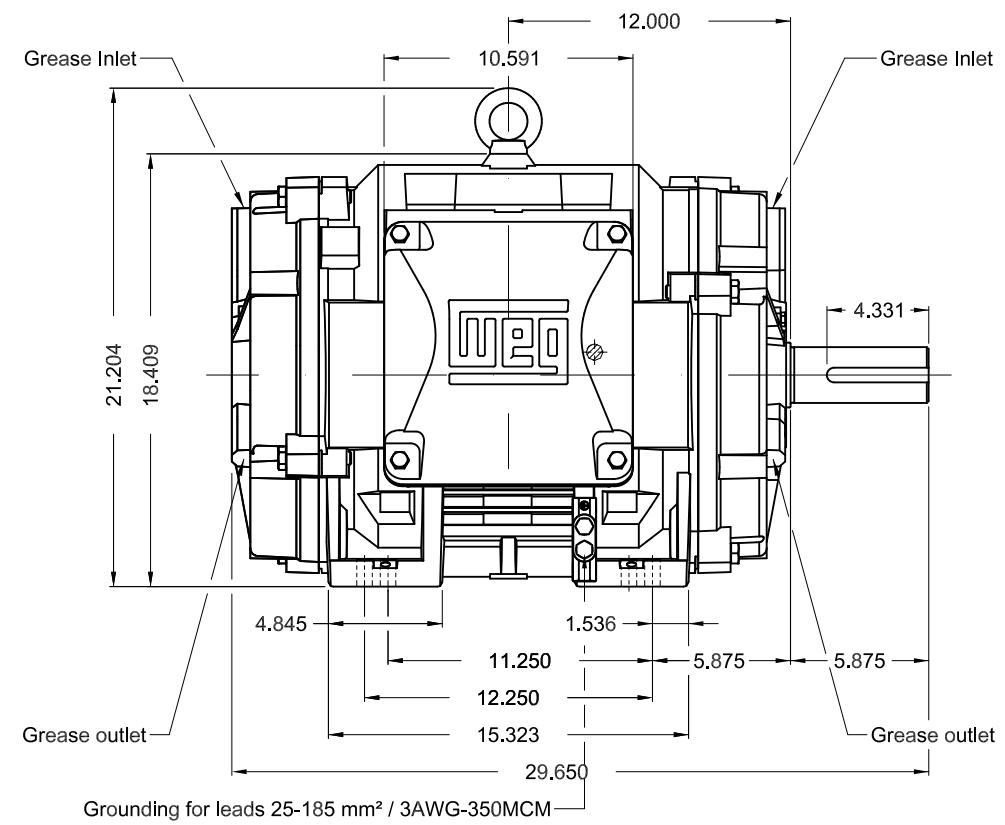
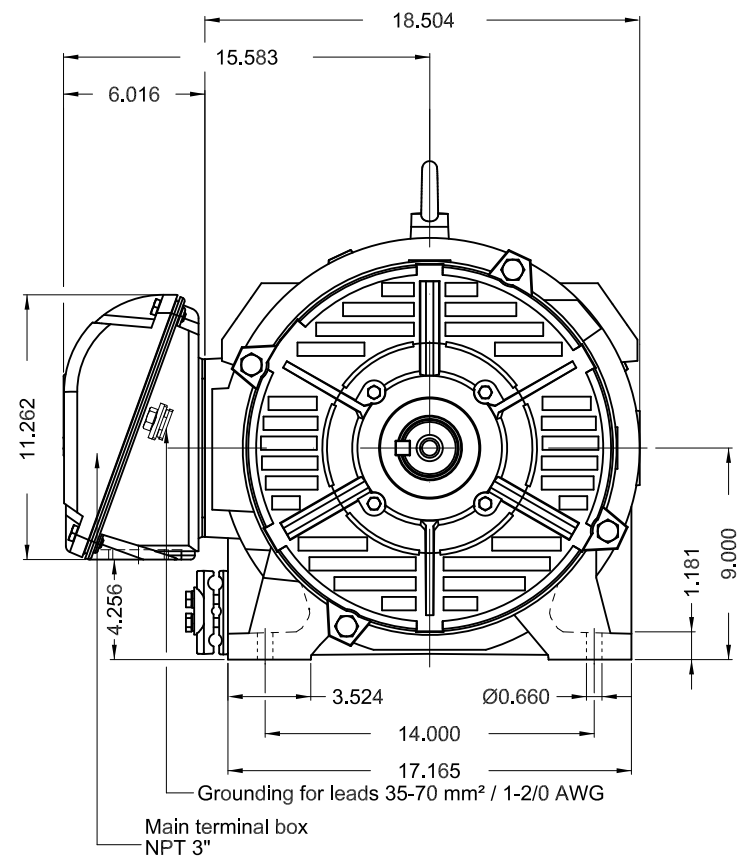

Color RAL 5009  
 Painting plan 203A  
 Mounting NEMA F-1  
 Mounting B3R(D)

40 HP 06 Poles 60 Hz

A

1:8

ECM	LOC	SUMMARY OF MODIFICATIONS	EXECUTED	CHECKED	RELEASED	DATE	VER
EXECUTED	PIRWBUSER	THREE PH. MOTOR W40 PREM. EFF.					
CHECKED		FRAME 364/5T IP23 ODP					
RELEASED							
REL DT.	WMO	Jaragua do Sul	Product Engineering	SHEET	1 / 1		

PREVIEW  
 WDD



**WEG** **W40 NEMA**  
**CC029A Premium**  
*Inverter Duty Motor*



IEC 60034-1  
 MOD.T01#FOXON



For 60Hz use on PWM, VT 1000:1, CT 2:1, 1.0SF

MODEL 040120T3E364T-W40  
 MADE IN BRAZIL  
 14270659

PH 3	FR 364/5T	HP(kW) 40.0(30.0)	Hz 60
V 230/460	A 94.2/47.1	RPM 1185	DES B
NEMA NOM EFF 94.1 %	INS. CL. F $\Delta$ T 80 K	IP23	
ENCL ODP	DUTY CONT.	AMB. 40°C	
CODE G	PF 0.85	SF 1.25	SFA 118/58.9
USABLE @208V	104 A	SF 1.15	SFA 120
30HP 22kW 50Hz 380V 42.7A 985RPM SF1.00 EFF 92.2% (IE3)	ALT 1000 m.a.s.l.		

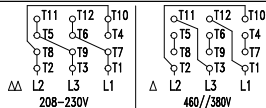

→ 6314-C3(27g) MOBIL POLYREX EM  
 → 6212-Z-C3(13g) 20000 h

ALT 1000 m.a.s.l. 745 Lbs