

DATA SHEET



Three Phase Induction Motor - Squirrel Cage

Customer								
Product line	: NEMA Premium Efficiency Three-Phase			Product code :	12448085			
				Catalog # :	04018ET3E324TS-W22			
Frame	: 324/6TS			Cooling method	: IC411 - TEFC			
Insulation class	: F			Mounting	: F-1			
Duty cycle	: Cont.(S1)			Rotation ¹	: Both (CW and CCW)			
Ambient temperature	: -20°C to +40°C			Starting method	: Direct On Line			
Altitude	: 1000 m.a.s.l.			Approx. weight ²	: 569 lb			
Protection degree	: IP55			Moment of inertia (J)	: 9.16 sq.ft.lb			
Design	: B							
Output [HP]	40	30	30	30	40	40	40	
Poles	4	4	4	4	4	4	4	
Frequency [Hz]	60	50	50	50	50	50	50	
Rated voltage [V]	230/460	380	400	415	380	400	415	
Rated current [A]	94.2/47.1	42.8	41.6	41.1	57.4	54.1	52.8	
L. R. Amperes [A]	575/287	282	304	316	287	303	317	
LRC [A]	6.1x(Code G)	6.6x(Code G)	7.3x(Code H)	7.7x(Code J)	5.0x(Code E)	5.6x(Code F)	6.0x(Code G)	
No load current [A]	34.0/17.0	16.8	17.3	18.6	16.8	17.3	18.6	
Rated speed [RPM]	1770	1475	1480	1480	1460	1465	1470	
Slip [%]	1.67	1.67	1.33	1.33	2.67	2.33	2.00	
Rated torque [ft.lb]	119	107	106	106	144	143	143	
Locked rotor torque [%]	229	240	270	280	170	190	210	
Breakdown torque [%]	240	260	290	310	180	210	229	
Service factor	1.25	1.00	1.00	1.00	1.00	1.00	1.00	
Temperature rise	80 K	80 K	80 K	80 K	105 K	105 K	80 K	
Locked rotor time	36s (cold) 20s (hot)	25s (cold) 14s (hot)	27s (cold) 15s (hot)	27s (cold) 15s (hot)	25s (cold) 14s (hot)	27s (cold) 15s (hot)	27s (cold) 15s (hot)	
Noise level ²	66.0 dB(A)	63.0 dB(A)	63.0 dB(A)	63.0 dB(A)	63.0 dB(A)	63.0 dB(A)	63.0 dB(A)	
Efficiency (%)	25%	93.4	92.8	92.1	91.1	94.0	93.5	92.8
	50%	93.6	92.9	92.4	91.7	93.6	93.6	93.0
	75%	94.1	93.1	93.0	92.6	93.0	93.0	93.0
	100%	94.1	93.0	93.2	93.1	92.4	93.0	93.0
Power Factor	25%	0.46	0.43	0.40	0.38	0.53	0.49	0.47
	50%	0.72	0.68	0.64	0.62	0.78	0.74	0.72
	75%	0.80	0.78	0.75	0.73	0.84	0.82	0.80
	100%	0.85	0.84	0.82	0.80	0.86	0.86	0.85
Bearing type	: Drive end 6312 C3 Non drive end 6212 C3		Foundation loads					
Sealing	: V'Ring V'Ring		Max. traction : 977 lb					
Lubrication interval	: 20000 h 20000 h		Max. compression : 1546 lb					
Lubricant amount	: 21 g 13 g							
Lubricant type	: Mobil Polyrex EM							
Notes								
USABLE @208V 104A SF 1.15 SFA 120A								
This revision replaces and cancel the previous one, which must be eliminated. (1) Looking the motor from the shaft end. (2) Measured at 1m and with tolerance of +3dB(A). (3) Approximate weight subject to changes after manufacturing process. (4) At 100% of full load.				These are average values based on tests with sinusoidal power supply, subject to the tolerances stipulated in NEMA MG-1.				
Rev.	Changes Summary			Performed	Checked	Date		
Performed by								
Checked by					Page	Revision		
Date	12/04/2022				1 / 36			

TORQUE AND CURRENT VS SPEED CURVE

Three Phase Induction Motor - Squirrel Cage



Customer :

Product line : NEMA Premium Efficiency Three-Phase

Product code : 12448085

Catalog # : 04018ET3E324TS-W22

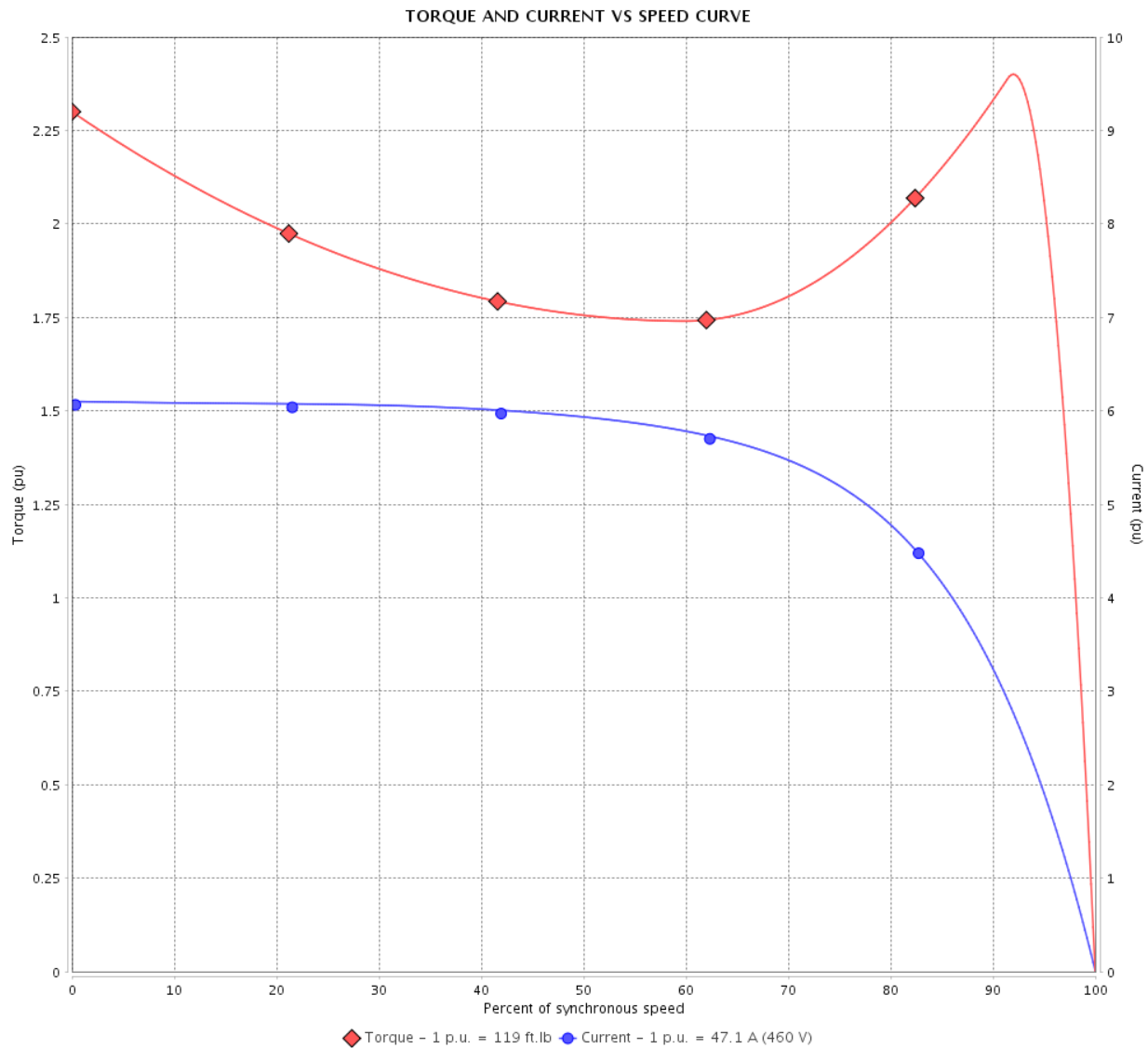

Performance : 230/460 V 60 Hz 4P

Rated current	: 94.2/47.1 A	Moment of inertia (J)	: 9.16 sq.ft.lb
LRC	: 6.1	Duty cycle	: Cont.(S1)
Rated torque	: 119 ft.lb	Insulation class	: F
Locked rotor torque	: 229 %	Service factor	: 1.25
Breakdown torque	: 240 %	Temperature rise	: 80 K
Rated speed	: 1770 rpm	Design	: B

Locked rotor time : 36s (cold) 20s (hot)

Rev.	Changes Summary	Performed	Checked	Date
Performed by			Page 2 / 36	Revision
Checked by				
Date	12/04/2022			

TORQUE AND CURRENT VS SPEED CURVE



Three Phase Induction Motor - Squirrel Cage

Customer :

Product line : NEMA Premium Efficiency Three-Phase

Product code : 12448085

Catalog # : 04018ET3E324TS-W22

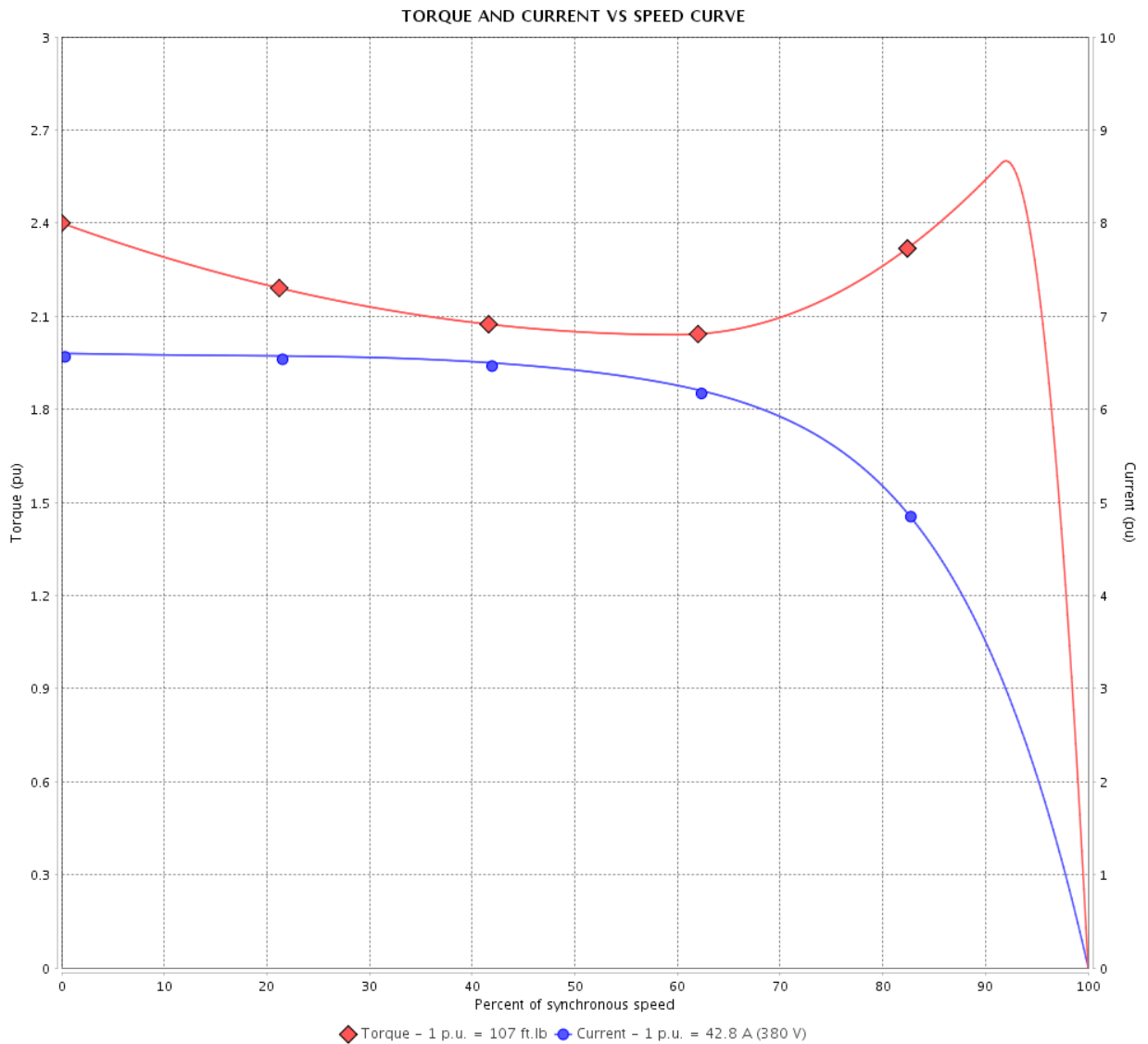

Performance : 380 V 50 Hz 4P IE3

Rated current	: 42.8 A	Moment of inertia (J)	: 9.16 sq.ft.lb
LRC	: 6.6	Duty cycle	: Cont.(S1)
Rated torque	: 107 ft.lb	Insulation class	: F
Locked rotor torque	: 240 %	Service factor	: 1.00
Breakdown torque	: 260 %	Temperature rise	: 80 K
Rated speed	: 1475 rpm	Design	: B

Locked rotor time : 25s (cold) 14s (hot)

Rev.	Changes Summary	Performed	Checked	Date
Performed by			Page 3 / 36	Revision
Checked by				
Date	12/04/2022			

TORQUE AND CURRENT VS SPEED CURVE

Three Phase Induction Motor - Squirrel Cage



Customer :

Product line : NEMA Premium Efficiency Three-Phase

Product code : 12448085

Catalog # : 04018ET3E324TS-W22

TORQUE AND CURRENT VS SPEED CURVE

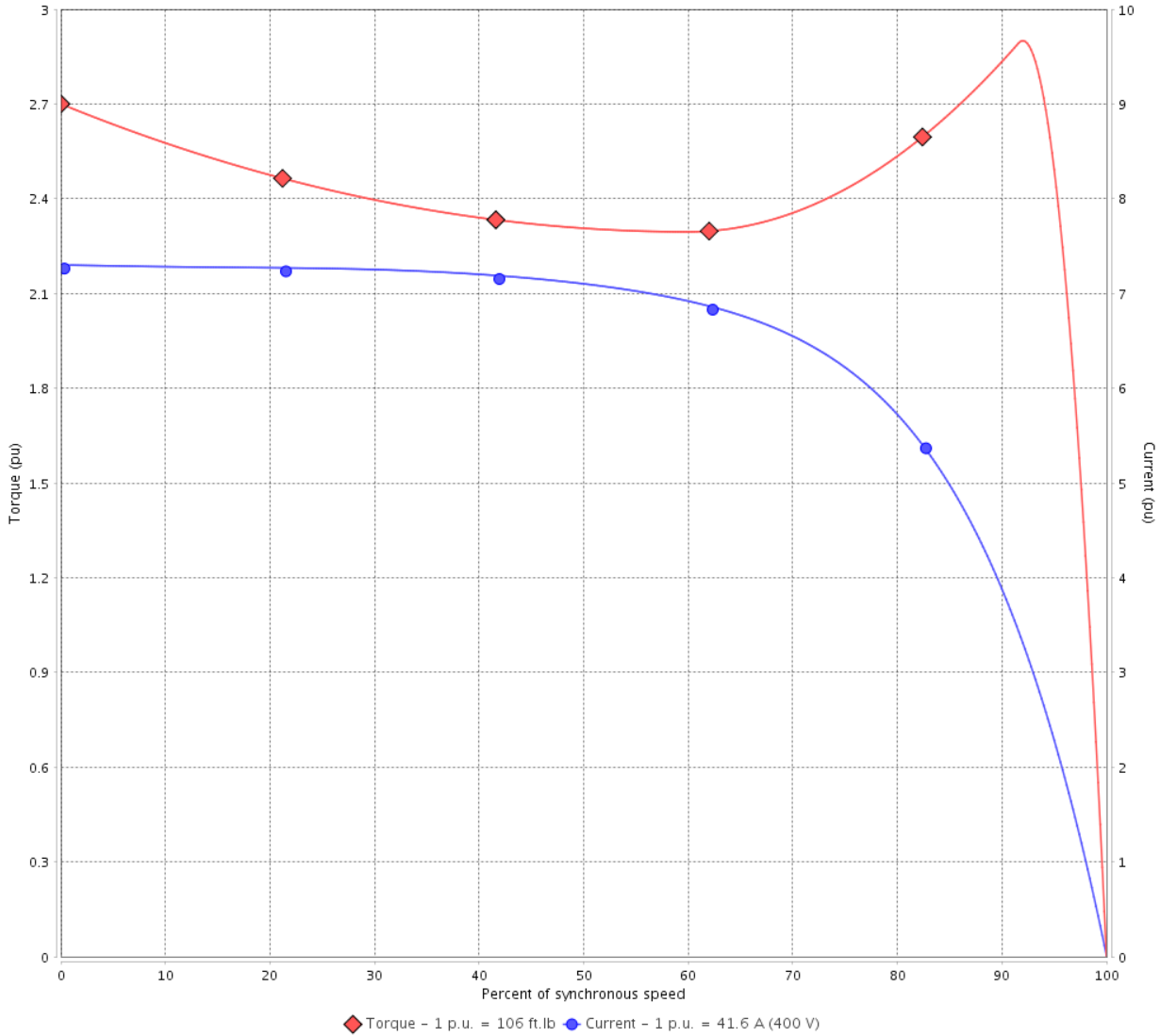

Performance : 400 V 50 Hz 4P IE3

Rated current	: 41.6 A	Moment of inertia (J)	: 9.16 sq.ft.lb
LRC	: 7.3	Duty cycle	: Cont.(S1)
Rated torque	: 106 ft.lb	Insulation class	: F
Locked rotor torque	: 270 %	Service factor	: 1.00
Breakdown torque	: 290 %	Temperature rise	: 80 K
Rated speed	: 1480 rpm	Design	: B

Locked rotor time : 27s (cold) 15s (hot)

Rev.	Changes Summary	Performed	Checked	Date
Performed by			Page 4 / 36	Revision
Checked by				
Date	12/04/2022			

TORQUE AND CURRENT VS SPEED CURVE



Three Phase Induction Motor - Squirrel Cage

Customer :

Product line : NEMA Premium Efficiency Three-Phase

Product code : 12448085

Catalog # : 04018ET3E324TS-W22

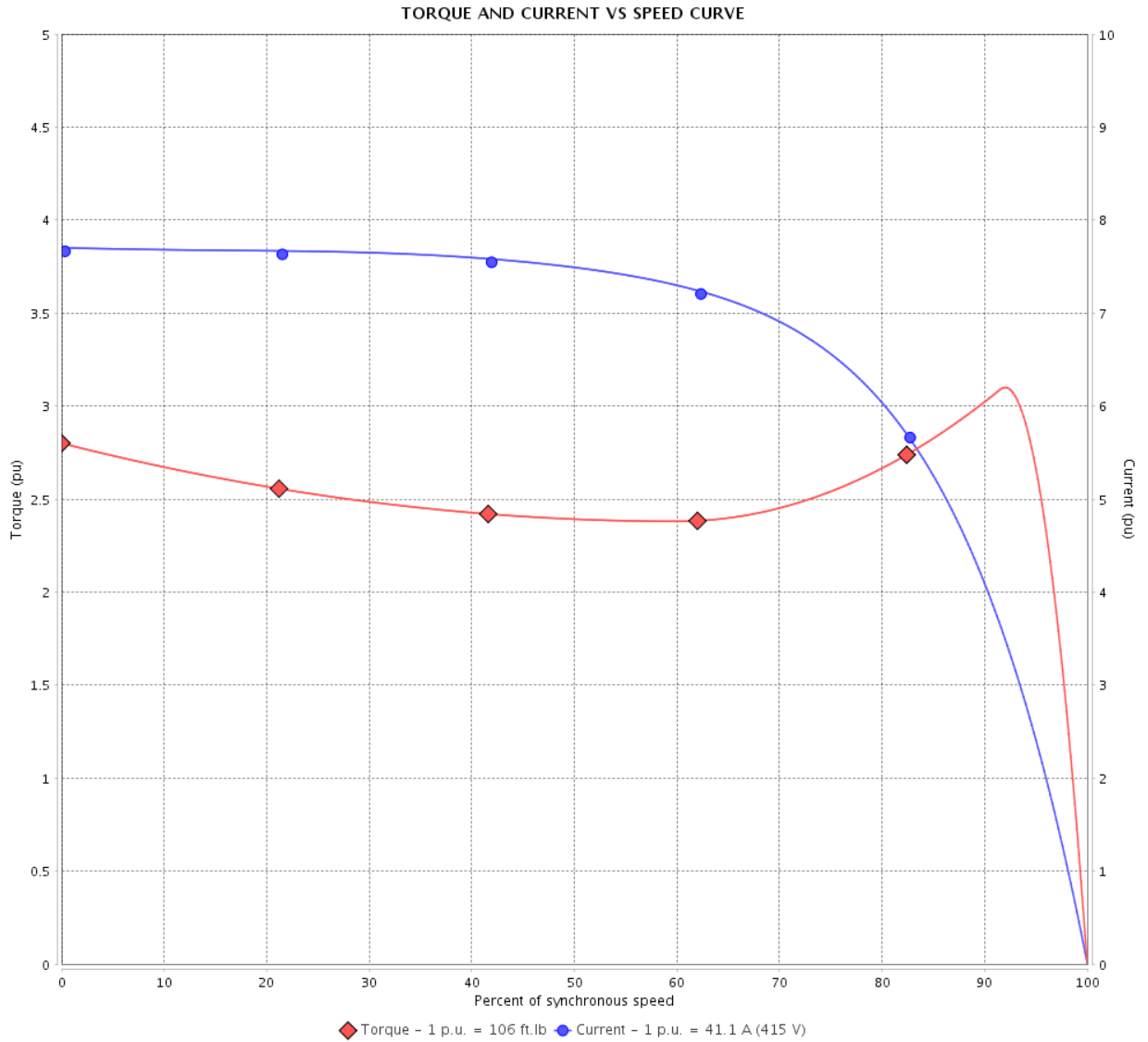

Performance : 415 V 50 Hz 4P IE3

Rated current	: 41.1 A	Moment of inertia (J)	: 9.16 sq.ft.lb
LRC	: 7.7	Duty cycle	: Cont.(S1)
Rated torque	: 106 ft.lb	Insulation class	: F
Locked rotor torque	: 280 %	Service factor	: 1.00
Breakdown torque	: 310 %	Temperature rise	: 80 K
Rated speed	: 1480 rpm	Design	: B

Locked rotor time : 27s (cold) 15s (hot)

Rev.	Changes Summary	Performed	Checked	Date
Performed by			Page 5 / 36	Revision
Checked by				
Date	12/04/2022			

TORQUE AND CURRENT VS SPEED CURVE

Three Phase Induction Motor - Squirrel Cage



Customer :

Product line : NEMA Premium Efficiency Three-Phase

Product code : 12448085

Catalog # : 04018ET3E324TS-W22

TORQUE AND CURRENT VS SPEED CURVE

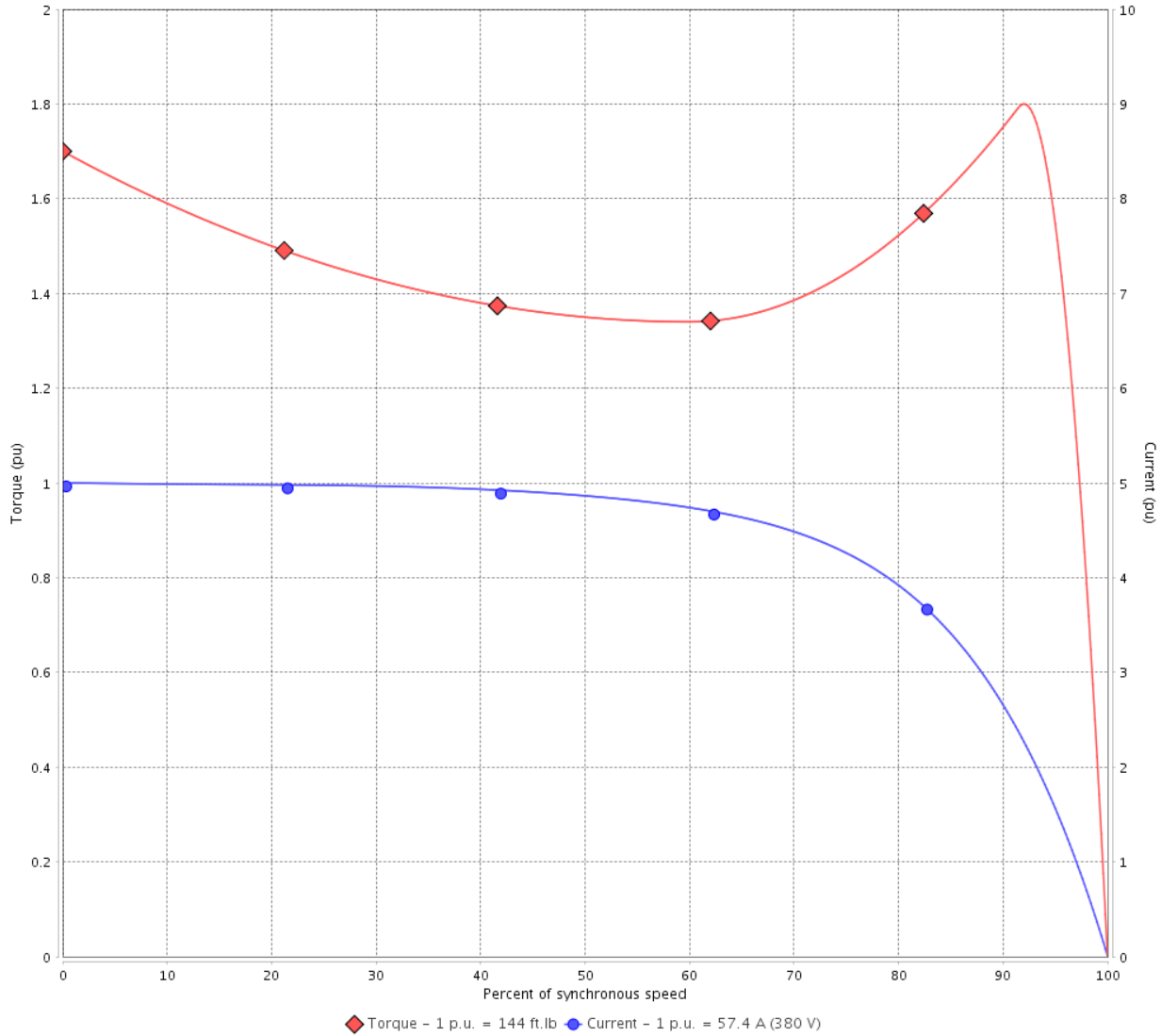

Performance : 380 V 50 Hz 4P IE2

Rated current	: 57.4 A	Moment of inertia (J)	: 9.16 sq.ft.lb
LRC	: 5.0	Duty cycle	: Cont.(S1)
Rated torque	: 144 ft.lb	Insulation class	: F
Locked rotor torque	: 170 %	Service factor	: 1.00
Breakdown torque	: 180 %	Temperature rise	: 105 K
Rated speed	: 1460 rpm	Design	: B

Locked rotor time : 25s (cold) 14s (hot)

Rev.	Changes Summary	Performed	Checked	Date
Performed by			Page 6 / 36	Revision
Checked by				
Date	12/04/2022			

TORQUE AND CURRENT VS SPEED CURVE



Three Phase Induction Motor - Squirrel Cage

Customer :

Product line : NEMA Premium Efficiency Three-Phase

Product code : 12448085

Catalog # : 04018ET3E324TS-W22

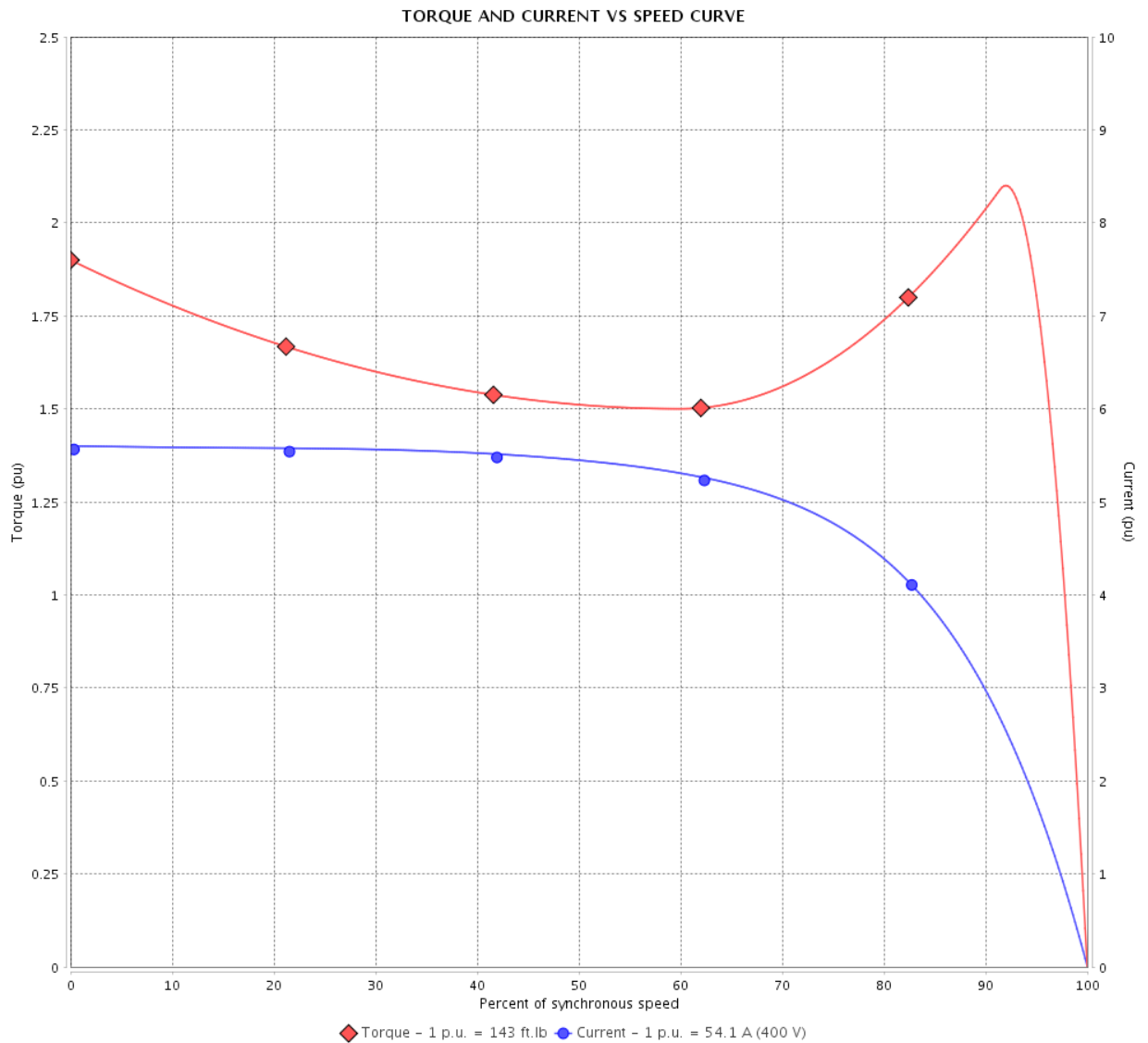

Performance : 400 V 50 Hz 4P IE2

Rated current	: 54.1 A	Moment of inertia (J)	: 9.16 sq.ft.lb
LRC	: 5.6	Duty cycle	: Cont.(S1)
Rated torque	: 143 ft.lb	Insulation class	: F
Locked rotor torque	: 190 %	Service factor	: 1.00
Breakdown torque	: 210 %	Temperature rise	: 105 K
Rated speed	: 1465 rpm	Design	: B

Locked rotor time : 27s (cold) 15s (hot)

Rev.	Changes Summary	Performed	Checked	Date
Performed by			Page 7 / 36	Revision
Checked by				
Date	12/04/2022			

TORQUE AND CURRENT VS SPEED CURVE

Three Phase Induction Motor - Squirrel Cage



Customer :

Product line : NEMA Premium Efficiency Three-Phase

Product code : 12448085

Catalog # : 04018ET3E324TS-W22

TORQUE AND CURRENT VS SPEED CURVE

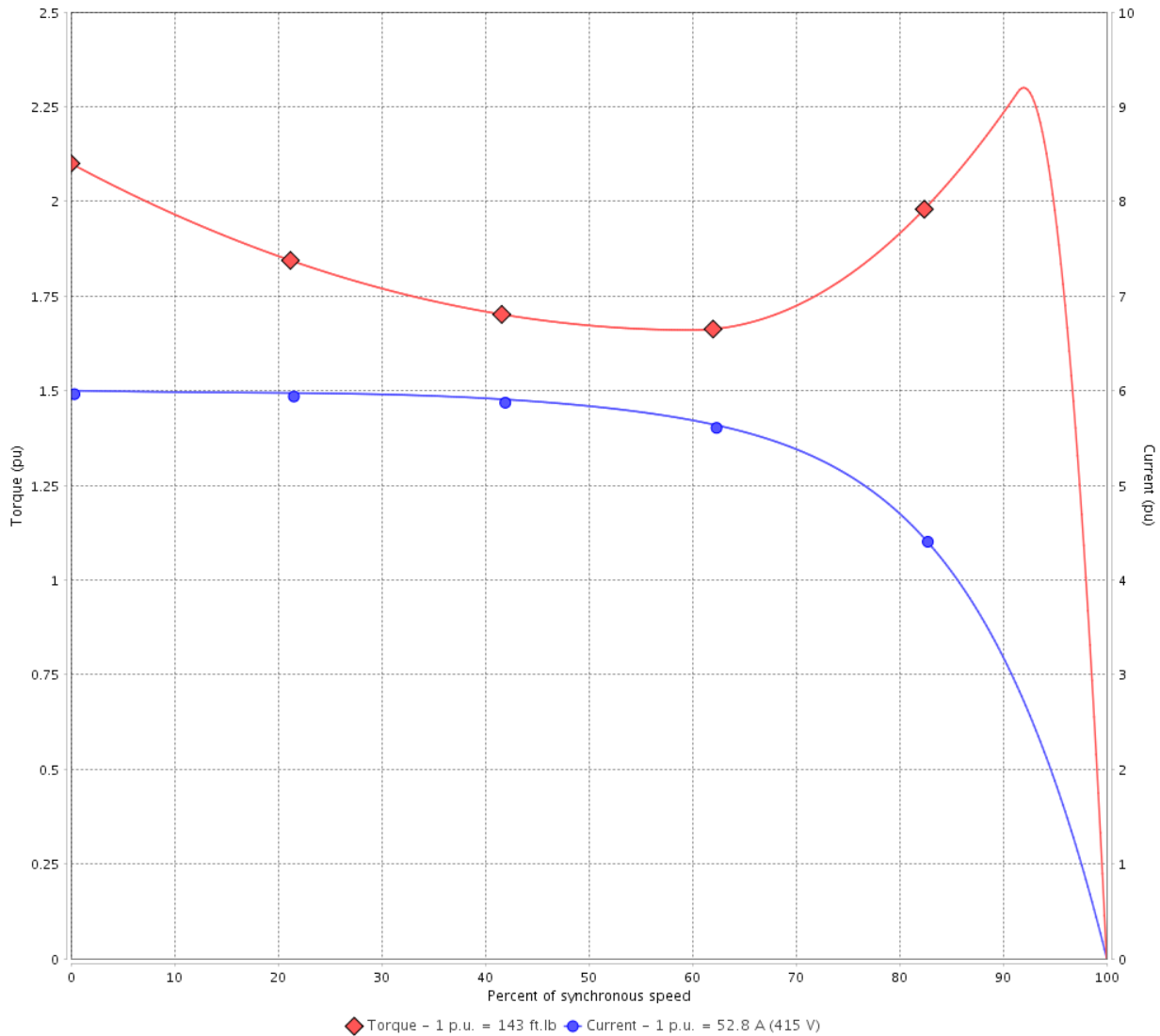

Performance : 415 V 50 Hz 4P IE2

Rated current	: 52.8 A	Moment of inertia (J)	: 9.16 sq.ft.lb
LRC	: 6.0	Duty cycle	: Cont.(S1)
Rated torque	: 143 ft.lb	Insulation class	: F
Locked rotor torque	: 210 %	Service factor	: 1.00
Breakdown torque	: 229 %	Temperature rise	: 80 K
Rated speed	: 1470 rpm	Design	: B

Locked rotor time : 27s (cold) 15s (hot)

Rev.	Changes Summary	Performed	Checked	Date
Performed by			Page	Revision
Checked by				
Date	12/04/2022			
			8 / 36	

LOAD PERFORMANCE CURVE

Three Phase Induction Motor - Squirrel Cage



Customer :

Product line : NEMA Premium Efficiency Three-Phase

Product code : 12448085

Catalog # : 04018ET3E324TS-W22

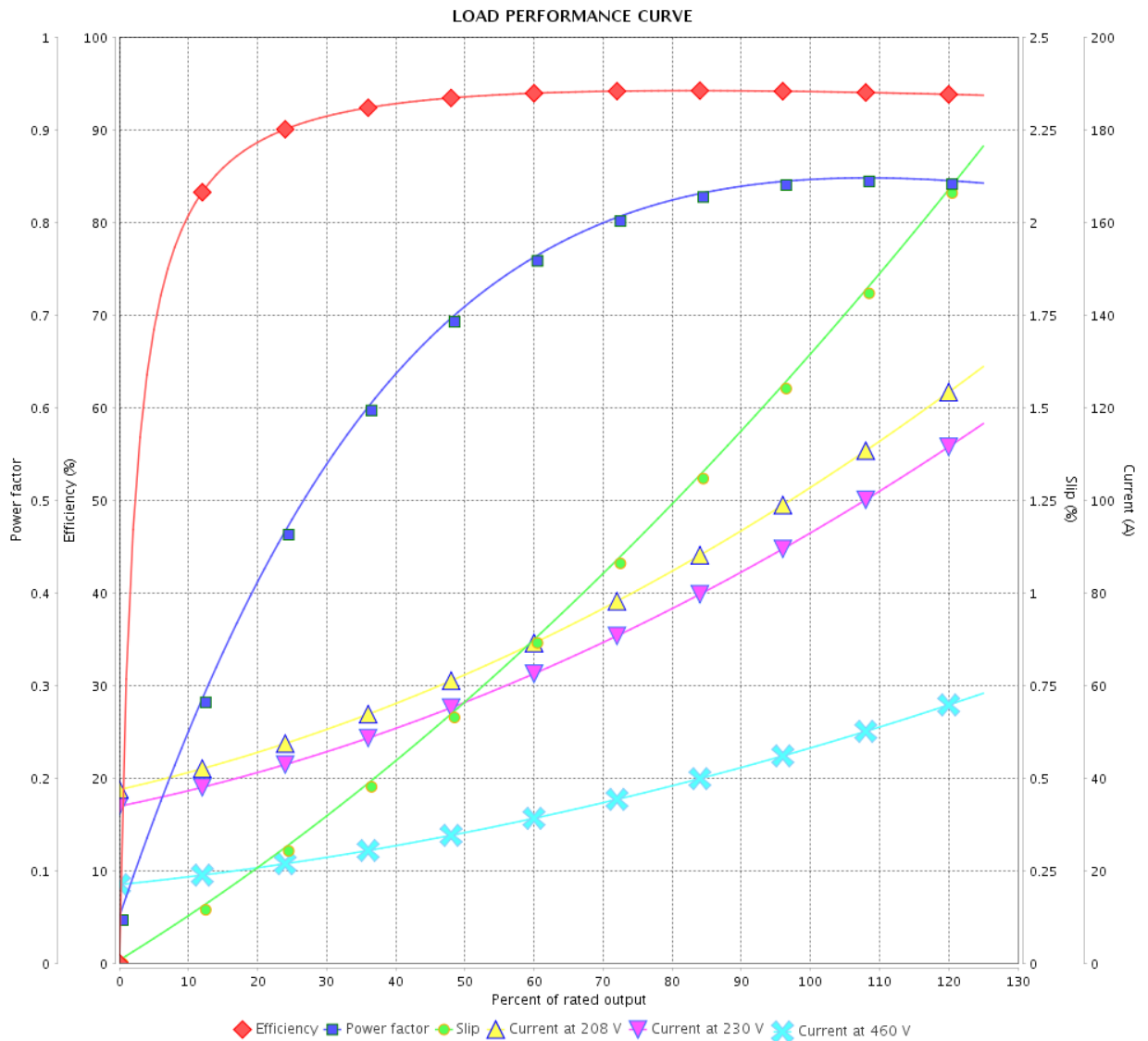

Performance : 230/460 V 60 Hz 4P

Rated current : 94.2/47.1 A
 LRC : 6.1
 Rated torque : 119 ft.lb
 Locked rotor torque : 229 %
 Breakdown torque : 240 %
 Rated speed : 1770 rpm

Moment of inertia (J) : 9.16 sq.ft.lb
 Duty cycle : Cont.(S1)
 Insulation class : F
 Service factor : 1.25
 Temperature rise : 80 K
 Design : B

Rev.	Changes Summary	Performed	Checked	Date
Performed by			Page	Revision
Checked by				
Date				

LOAD PERFORMANCE CURVE

Three Phase Induction Motor - Squirrel Cage



Customer :

Product line : NEMA Premium Efficiency Three-Phase

Product code : 12448085

Catalog # : 04018ET3E324TS-W22

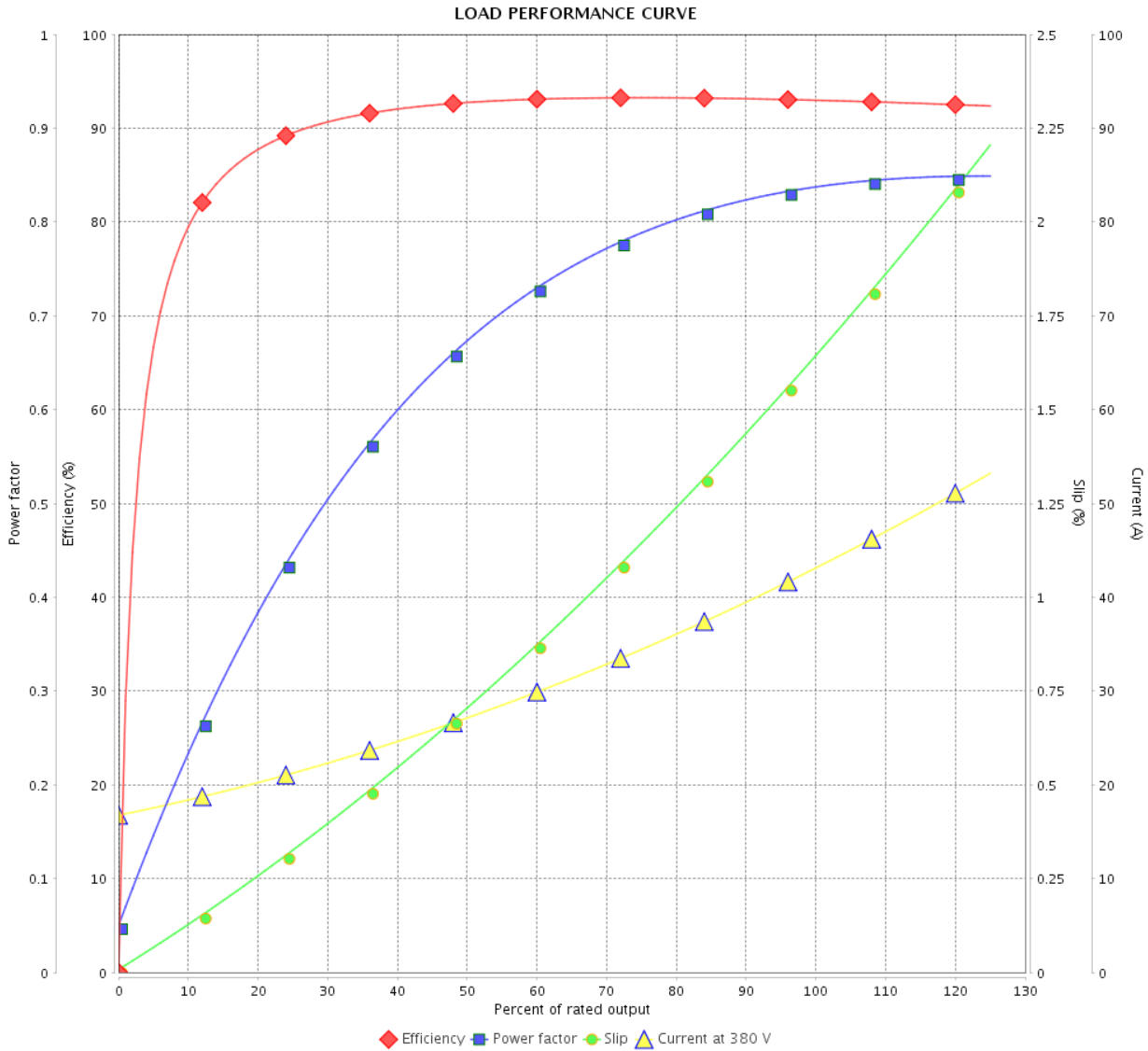

Performance : 380 V 50 Hz 4P IE3

Rated current : 42.8 A
 LRC : 6.6
 Rated torque : 107 ft.lb
 Locked rotor torque : 240 %
 Breakdown torque : 260 %
 Rated speed : 1475 rpm

Moment of inertia (J) : 9.16 sq.ft.lb
 Duty cycle : Cont.(S1)
 Insulation class : F
 Service factor : 1.00
 Temperature rise : 80 K
 Design : B

Rev.	Changes Summary	Performed	Checked	Date
Performed by				
Checked by				
Date				
			Page	Revision
			10 / 36	

LOAD PERFORMANCE CURVE

Three Phase Induction Motor - Squirrel Cage



Customer :

Product line : NEMA Premium Efficiency Three-Phase

Product code : 12448085

Catalog # : 04018ET3E324TS-W22

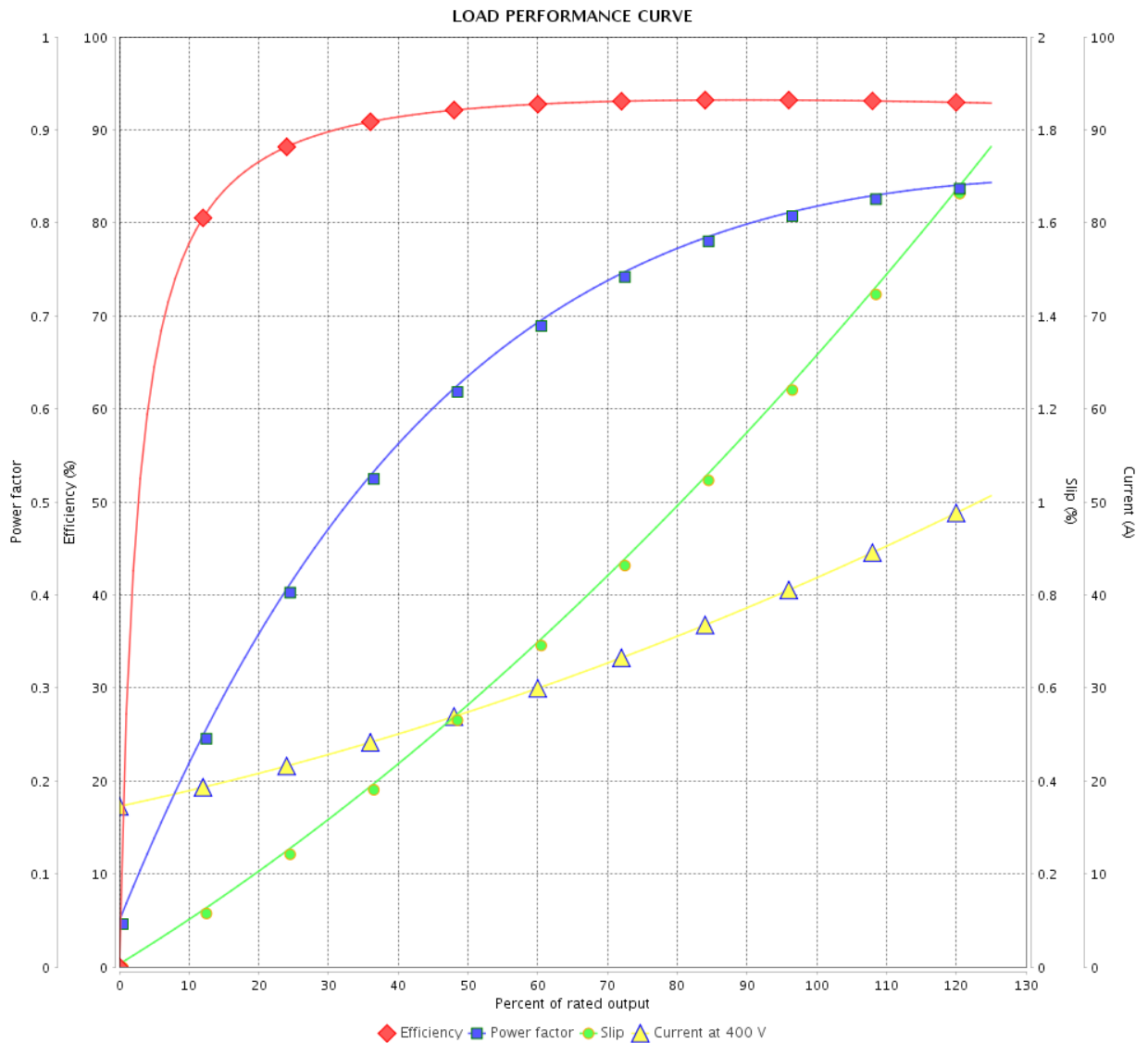

Performance : 400 V 50 Hz 4P IE3

Rated current : 41.6 A
 LRC : 7.3
 Rated torque : 106 ft.lb
 Locked rotor torque : 270 %
 Breakdown torque : 290 %
 Rated speed : 1480 rpm

Moment of inertia (J) : 9.16 sq.ft.lb
 Duty cycle : Cont.(S1)
 Insulation class : F
 Service factor : 1.00
 Temperature rise : 80 K
 Design : B

Rev.	Changes Summary	Performed	Checked	Date
Performed by			Page	Revision
Checked by				
Date				
			11 / 36	

LOAD PERFORMANCE CURVE

Three Phase Induction Motor - Squirrel Cage



Customer :

Product line : NEMA Premium Efficiency Three-Phase

Product code : 12448085

Catalog # : 04018ET3E324TS-W22

LOAD PERFORMANCE CURVE

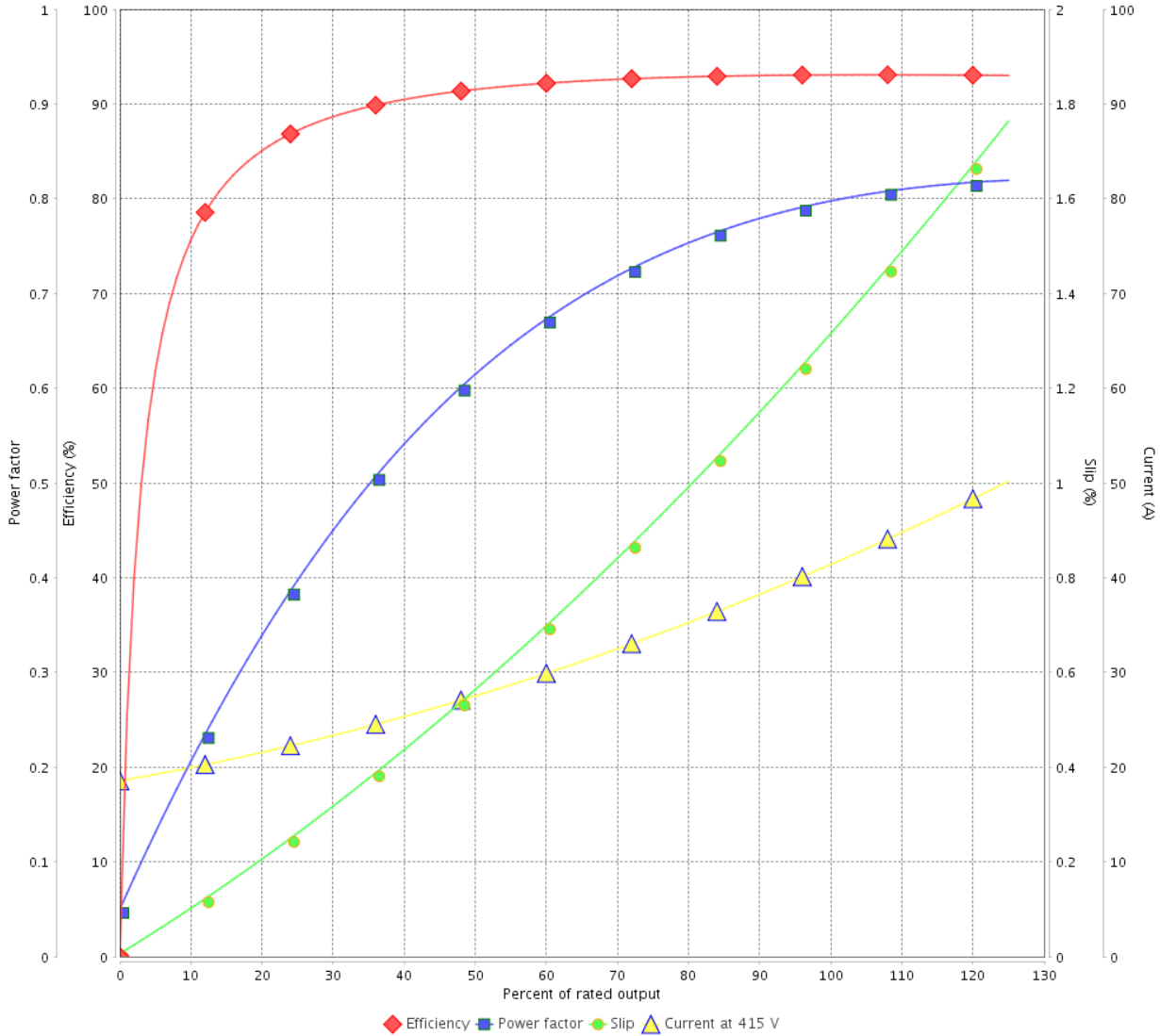

Performance : 415 V 50 Hz 4P IE3

Rated current : 41.1 A
 LRC : 7.7
 Rated torque : 106 ft.lb
 Locked rotor torque : 280 %
 Breakdown torque : 310 %
 Rated speed : 1480 rpm

Moment of inertia (J) : 9.16 sq.ft.lb
 Duty cycle : Cont.(S1)
 Insulation class : F
 Service factor : 1.00
 Temperature rise : 80 K
 Design : B

Rev.	Changes Summary	Performed	Checked	Date
Performed by			Page 12 / 36	Revision
Checked by				
Date	12/04/2022			

LOAD PERFORMANCE CURVE

Three Phase Induction Motor - Squirrel Cage



Customer : _____

Product line : NEMA Premium Efficiency Three-Phase

Product code : 12448085

Catalog # : 04018ET3E324TS-W22

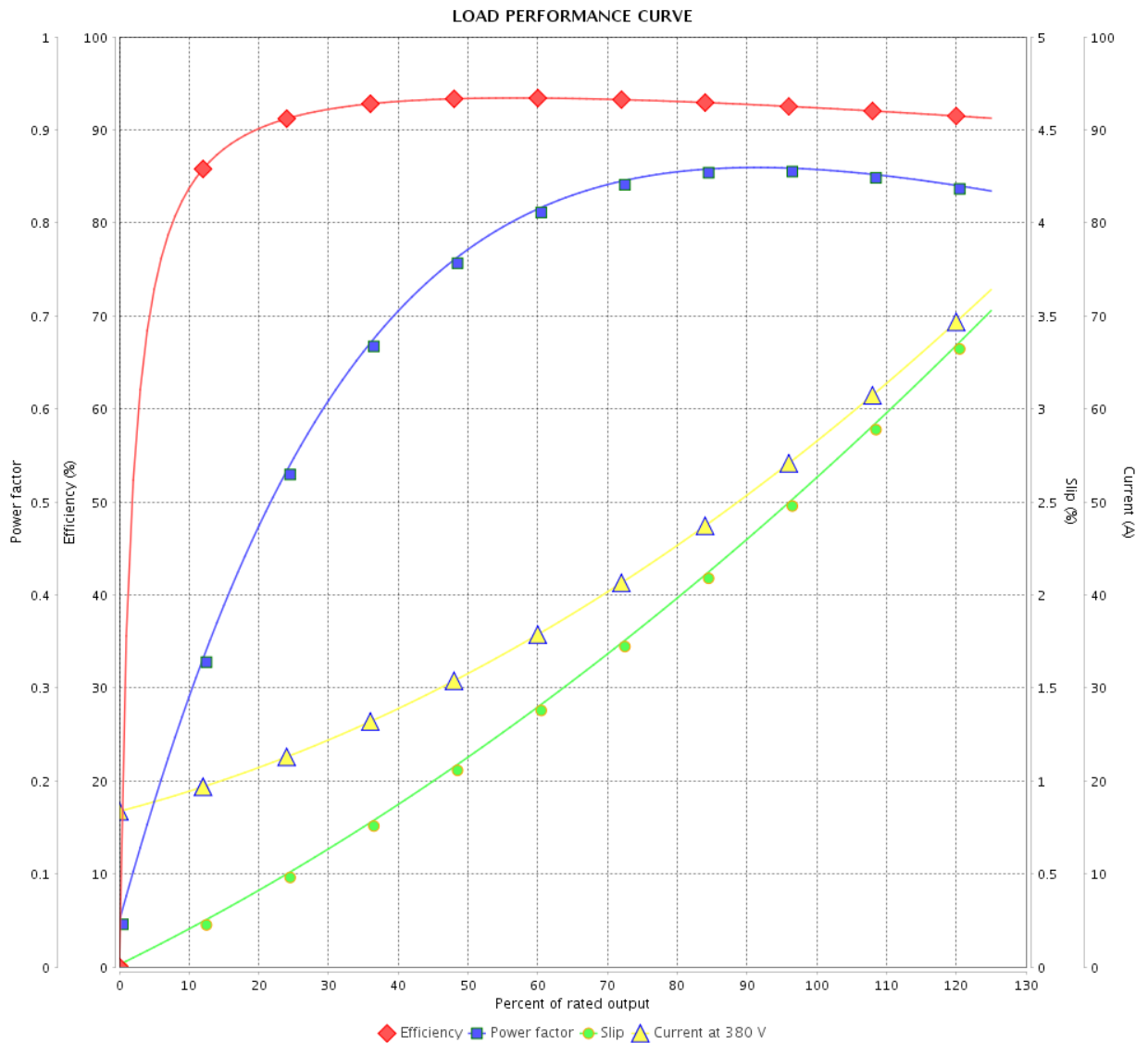

Performance : 380 V 50 Hz 4P IE2

Rated current : 57.4 A
 LRC : 5.0
 Rated torque : 144 ft.lb
 Locked rotor torque : 170 %
 Breakdown torque : 180 %
 Rated speed : 1460 rpm

Moment of inertia (J) : 9.16 sq.ft.lb
 Duty cycle : Cont.(S1)
 Insulation class : F
 Service factor : 1.00
 Temperature rise : 105 K
 Design : B

Rev.	Changes Summary	Performed	Checked	Date
Performed by		Page		Revision
Checked by		13 / 36		
Date		12/04/2022		

LOAD PERFORMANCE CURVE

Three Phase Induction Motor - Squirrel Cage



Customer :

Product line : NEMA Premium Efficiency Three-Phase

Product code : 12448085

Catalog # : 04018ET3E324TS-W22

LOAD PERFORMANCE CURVE

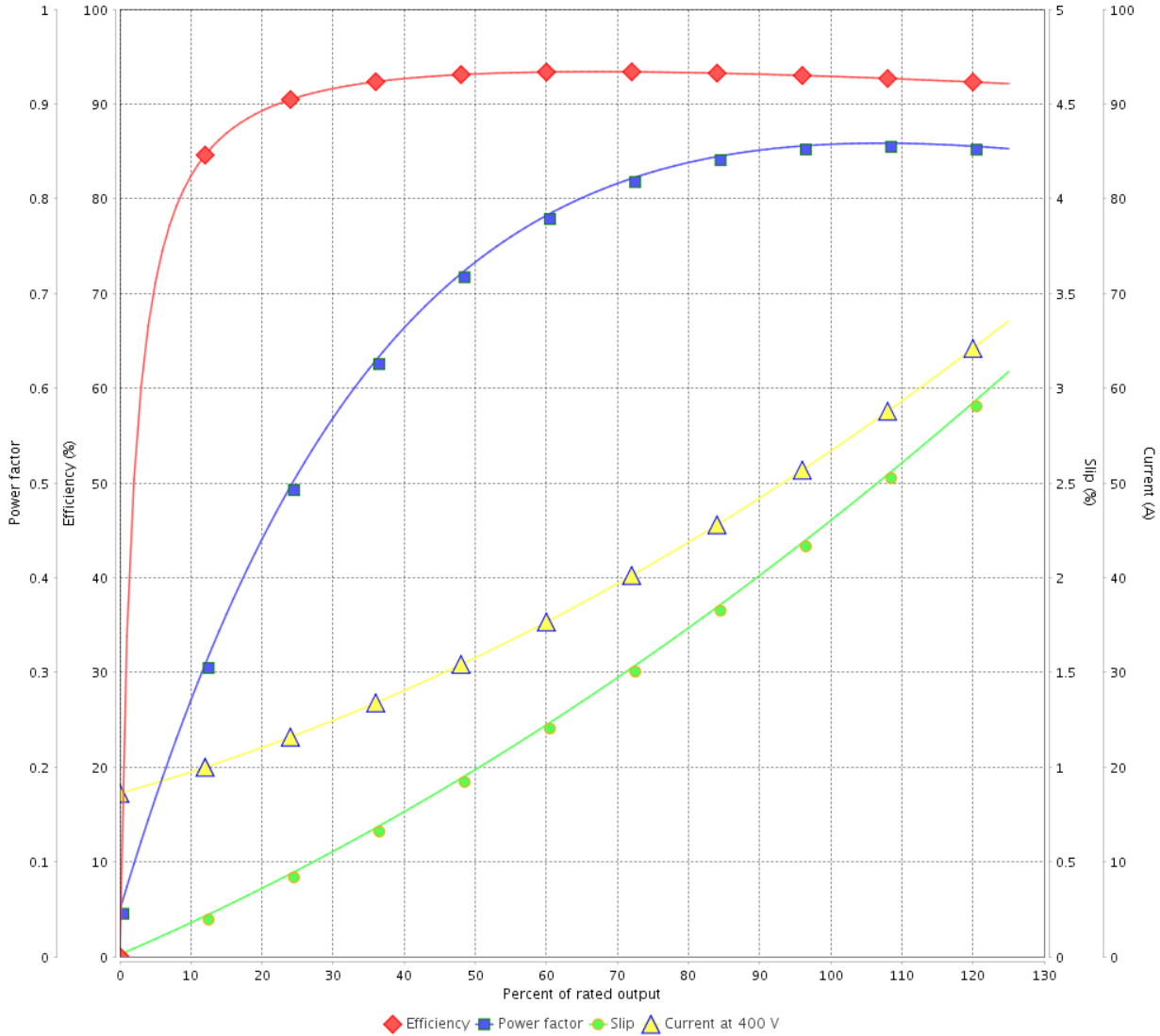

Performance : 400 V 50 Hz 4P IE2

Rated current : 54.1 A
 LRC : 5.6
 Rated torque : 143 ft.lb
 Locked rotor torque : 190 %
 Breakdown torque : 210 %
 Rated speed : 1465 rpm

Moment of inertia (J) : 9.16 sq.ft.lb
 Duty cycle : Cont.(S1)
 Insulation class : F
 Service factor : 1.00
 Temperature rise : 105 K
 Design : B

Rev.	Changes Summary	Performed	Checked	Date
Performed by			Page	Revision
Checked by				
Date				

LOAD PERFORMANCE CURVE

Three Phase Induction Motor - Squirrel Cage



Customer : _____

Product line : NEMA Premium Efficiency Three-Phase

Product code : 12448085

Catalog # : 04018ET3E324TS-W22

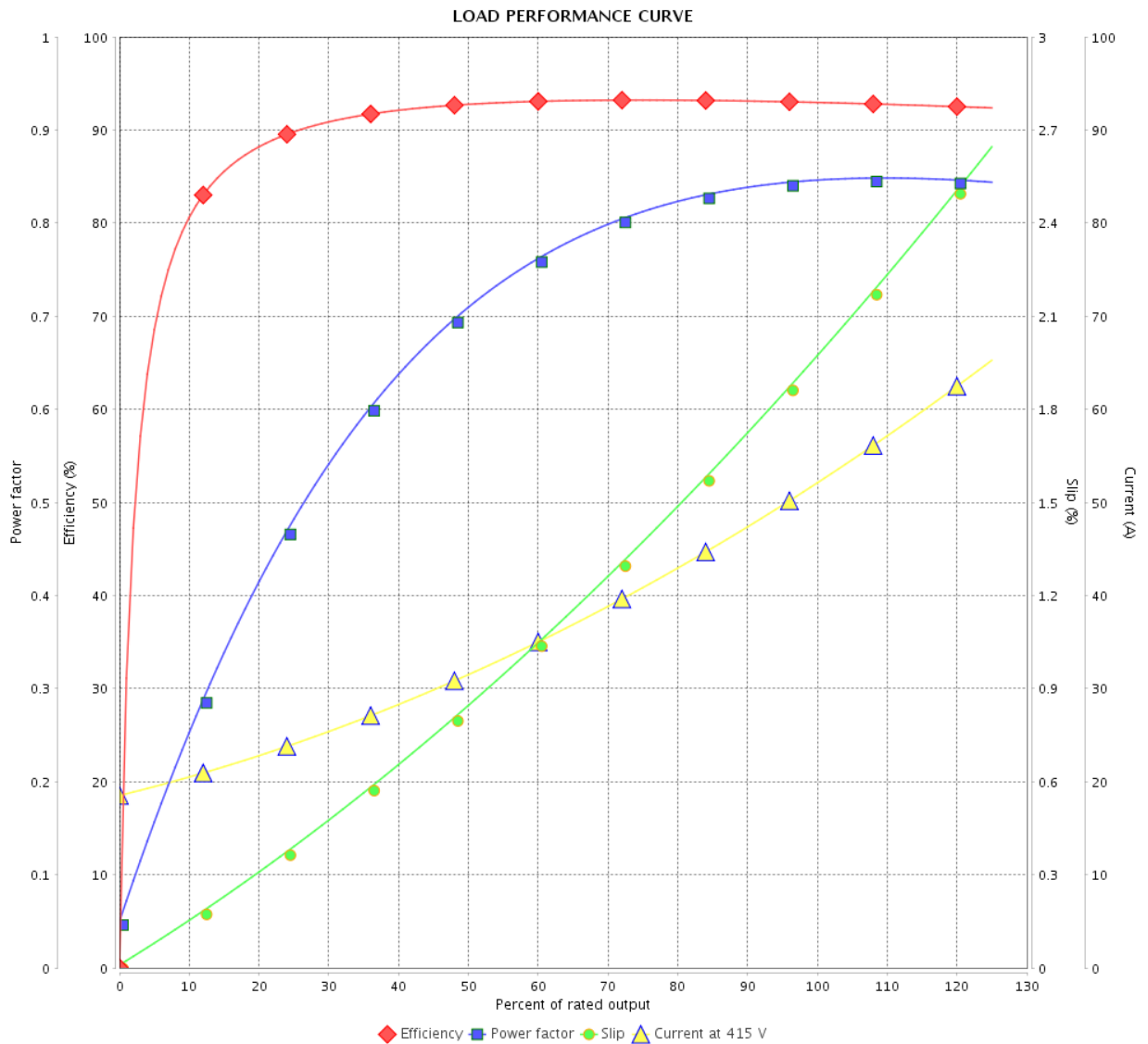

Performance : 415 V 50 Hz 4P IE2

Rated current : 52.8 A
 LRC : 6.0
 Rated torque : 143 ft.lb
 Locked rotor torque : 210 %
 Breakdown torque : 229 %
 Rated speed : 1470 rpm

Moment of inertia (J) : 9.16 sq.ft.lb
 Duty cycle : Cont.(S1)
 Insulation class : F
 Service factor : 1.00
 Temperature rise : 80 K
 Design : B

Rev.	Changes Summary	Performed	Checked	Date
Performed by		Page		Revision
Checked by		15 / 36		
Date		12/04/2022		

THERMAL LIMIT CURVE

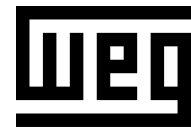

Three Phase Induction Motor - Squirrel Cage

Customer :

Product line : NEMA Premium Efficiency Three-Phase
Product code : 12448085
Catalog # : 04018ET3E324TS-W22

Performance : 230/460 V 60 Hz 4P

Rated current	: 94.2/47.1 A	Moment of inertia (J)	: 9.16 sq.ft.lb
LRC	: 6.1	Duty cycle	: Cont.(S1)
Rated torque	: 119 ft.lb	Insulation class	: F
Locked rotor torque	: 229 %	Service factor	: 1.25
Breakdown torque	: 240 %	Temperature rise	: 80 K
Rated speed	: 1770 rpm	Design	: B

Heating constant

Cooling constant

Rev.	Changes Summary	Performed	Checked	Date
Performed by				
Checked by			Page	Revision
Date	12/04/2022		16 / 36	

THERMAL LIMIT CURVE

Three Phase Induction Motor - Squirrel Cage



Customer : _____

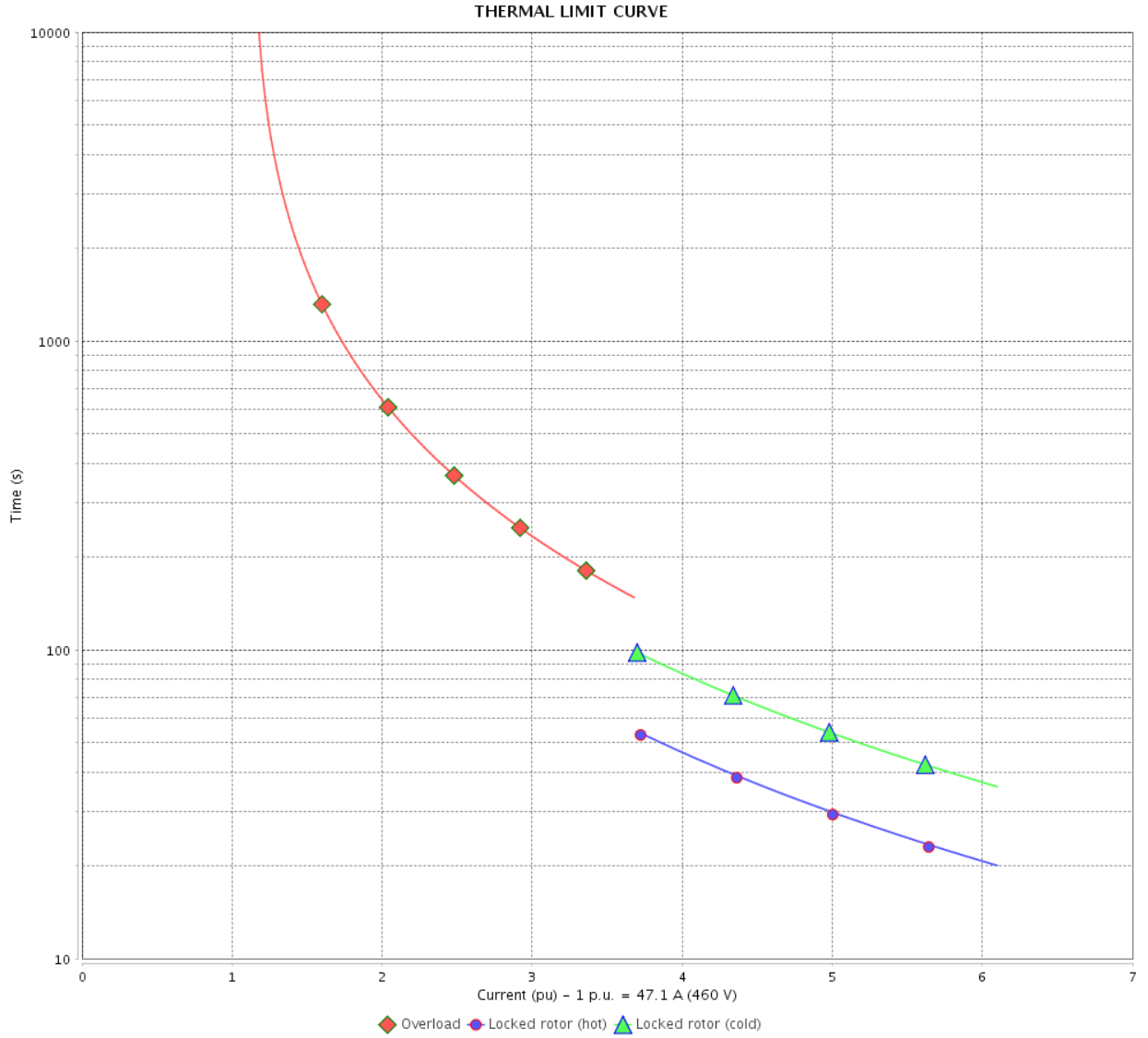

Rev.	Changes Summary	Performed	Checked	Date
Performed by		Page		Revision
Checked by		17 / 36		
Date		12/04/2022		

THERMAL LIMIT CURVE



Three Phase Induction Motor - Squirrel Cage

Customer :

Product line : NEMA Premium Efficiency Three-Phase
 Product code : 12448085
 Catalog # : 04018ET3E324TS-W22

Performance : 380 V 50 Hz 4P IE3

Rated current : 42.8 A	Moment of inertia (J) : 9.16 sq.ft.lb
LRC : 6.6	Duty cycle : Cont.(S1)
Rated torque : 107 ft.lb	Insulation class : F
Locked rotor torque : 240 %	Service factor : 1.00
Breakdown torque : 260 %	Temperature rise : 80 K
Rated speed : 1475 rpm	Design : B

Heating constant

Cooling constant

Rev.	Changes Summary	Performed	Checked	Date
Performed by			Page 18 / 36	Revision
Checked by				
Date	12/04/2022			

THERMAL LIMIT CURVE

Three Phase Induction Motor - Squirrel Cage



Customer : _____

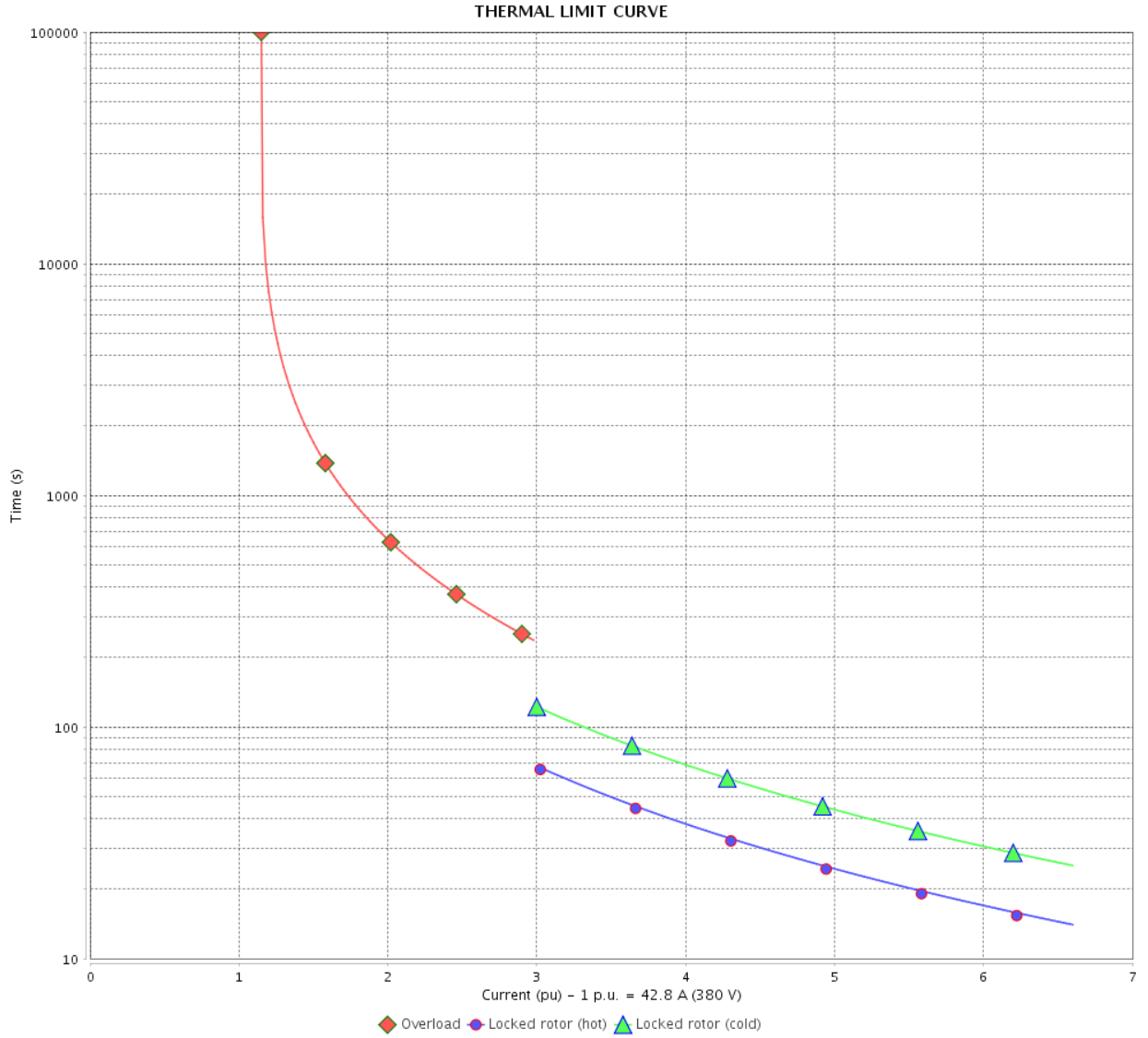

Rev.	Changes Summary	Performed	Checked	Date
Performed by		Page 19 / 36		Revision
Checked by				
Date				

THERMAL LIMIT CURVE

Three Phase Induction Motor - Squirrel Cage



Customer :

Product line : NEMA Premium Efficiency Three-Phase
Product code : 12448085
Catalog # : 04018ET3E324TS-W22

Performance : 400 V 50 Hz 4P IE3

Rated current	: 41.6 A	Moment of inertia (J)	: 9.16 sq.ft.lb
LRC	: 7.3	Duty cycle	: Cont.(S1)
Rated torque	: 106 ft.lb	Insulation class	: F
Locked rotor torque	: 270 %	Service factor	: 1.00
Breakdown torque	: 290 %	Temperature rise	: 80 K
Rated speed	: 1480 rpm	Design	: B

Heating constant

Cooling constant

Rev.	Changes Summary	Performed	Checked	Date
Performed by				
Checked by			Page	Revision
Date	12/04/2022		20 / 36	

THERMAL LIMIT CURVE

Three Phase Induction Motor - Squirrel Cage



Customer : _____

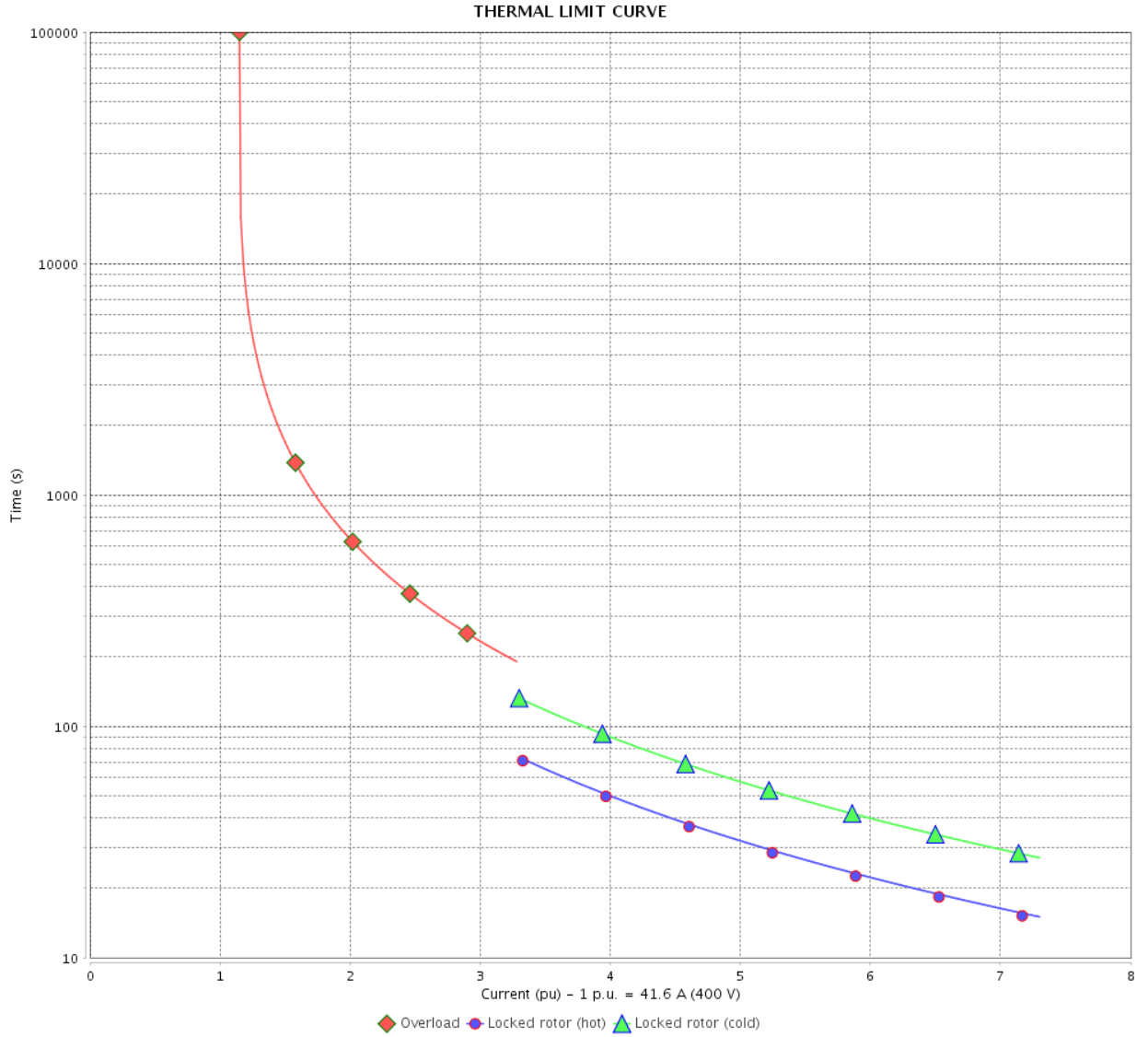

Rev.	Changes Summary	Performed	Checked	Date
Performed by		Page		Revision
Checked by		21 / 36		
Date		12/04/2022		

THERMAL LIMIT CURVE

Three Phase Induction Motor - Squirrel Cage



Customer :

Product line : NEMA Premium Efficiency Three-Phase
Product code : 12448085
Catalog # : 04018ET3E324TS-W22

Performance : 415 V 50 Hz 4P IE3

Rated current	: 41.1 A	Moment of inertia (J)	: 9.16 sq.ft.lb
LRC	: 7.7	Duty cycle	: Cont.(S1)
Rated torque	: 106 ft.lb	Insulation class	: F
Locked rotor torque	: 280 %	Service factor	: 1.00
Breakdown torque	: 310 %	Temperature rise	: 80 K
Rated speed	: 1480 rpm	Design	: B

Heating constant

Cooling constant

Rev.	Changes Summary	Performed	Checked	Date
Performed by				
Checked by			Page	Revision
Date	12/04/2022		22 / 36	

THERMAL LIMIT CURVE

Three Phase Induction Motor - Squirrel Cage



Customer : _____

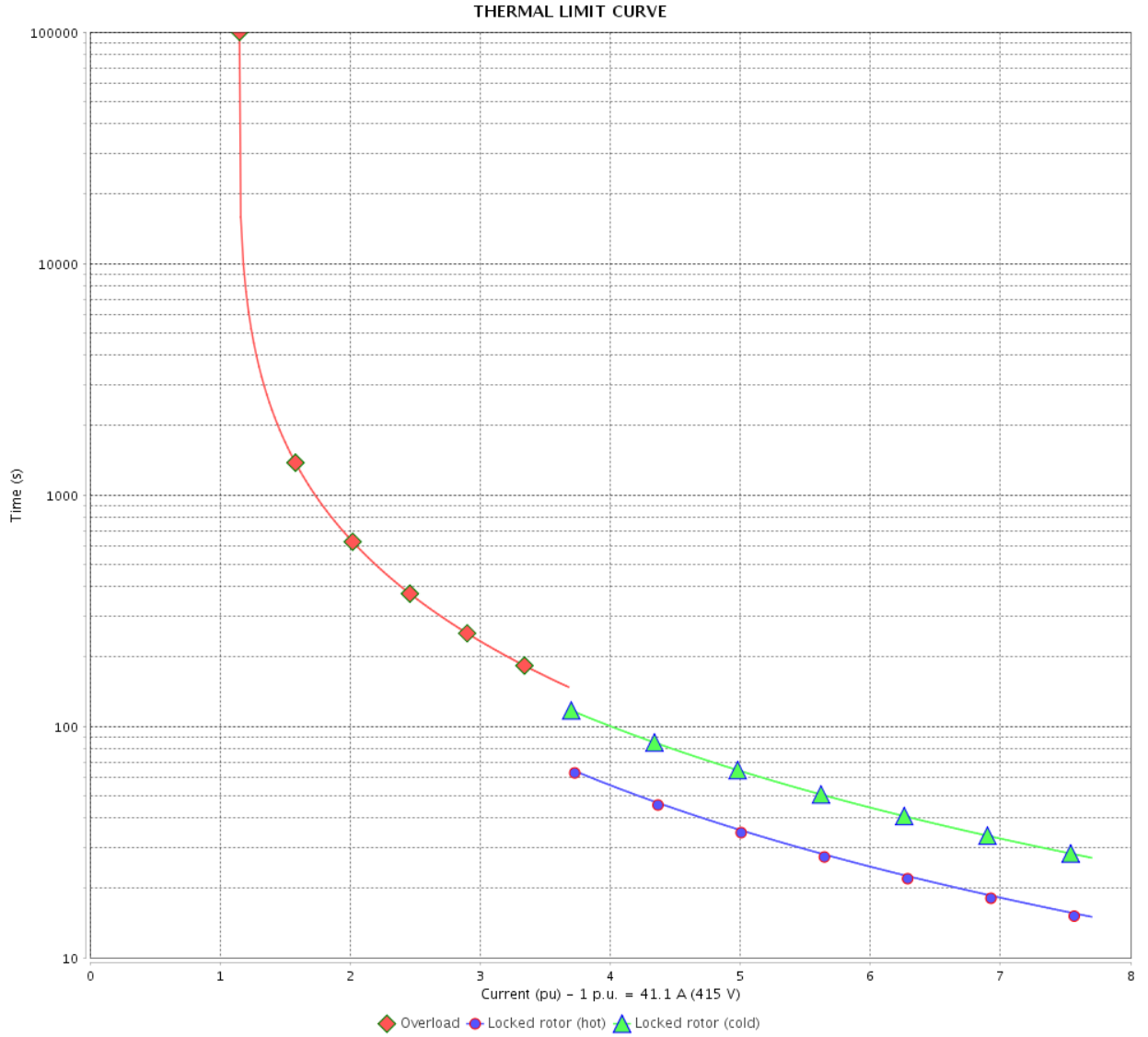

Rev.	Changes Summary	Performed	Checked	Date
Performed by		Page		Revision
Checked by		23 / 36		
Date		12/04/2022		

THERMAL LIMIT CURVE



Three Phase Induction Motor - Squirrel Cage

Customer :

Product line : NEMA Premium Efficiency Three-Phase
Product code : 12448085
Catalog # : 04018ET3E324TS-W22

Performance : 380 V 50 Hz 4P IE2

Rated current	: 57.4 A	Moment of inertia (J)	: 9.16 sq.ft.lb
LRC	: 5.0	Duty cycle	: Cont.(S1)
Rated torque	: 144 ft.lb	Insulation class	: F
Locked rotor torque	: 170 %	Service factor	: 1.00
Breakdown torque	: 180 %	Temperature rise	: 105 K
Rated speed	: 1460 rpm	Design	: B

Heating constant

Cooling constant

Rev.	Changes Summary	Performed	Checked	Date
Performed by				
Checked by			Page	Revision
Date	12/04/2022		24 / 36	

THERMAL LIMIT CURVE

Three Phase Induction Motor - Squirrel Cage



Customer : _____

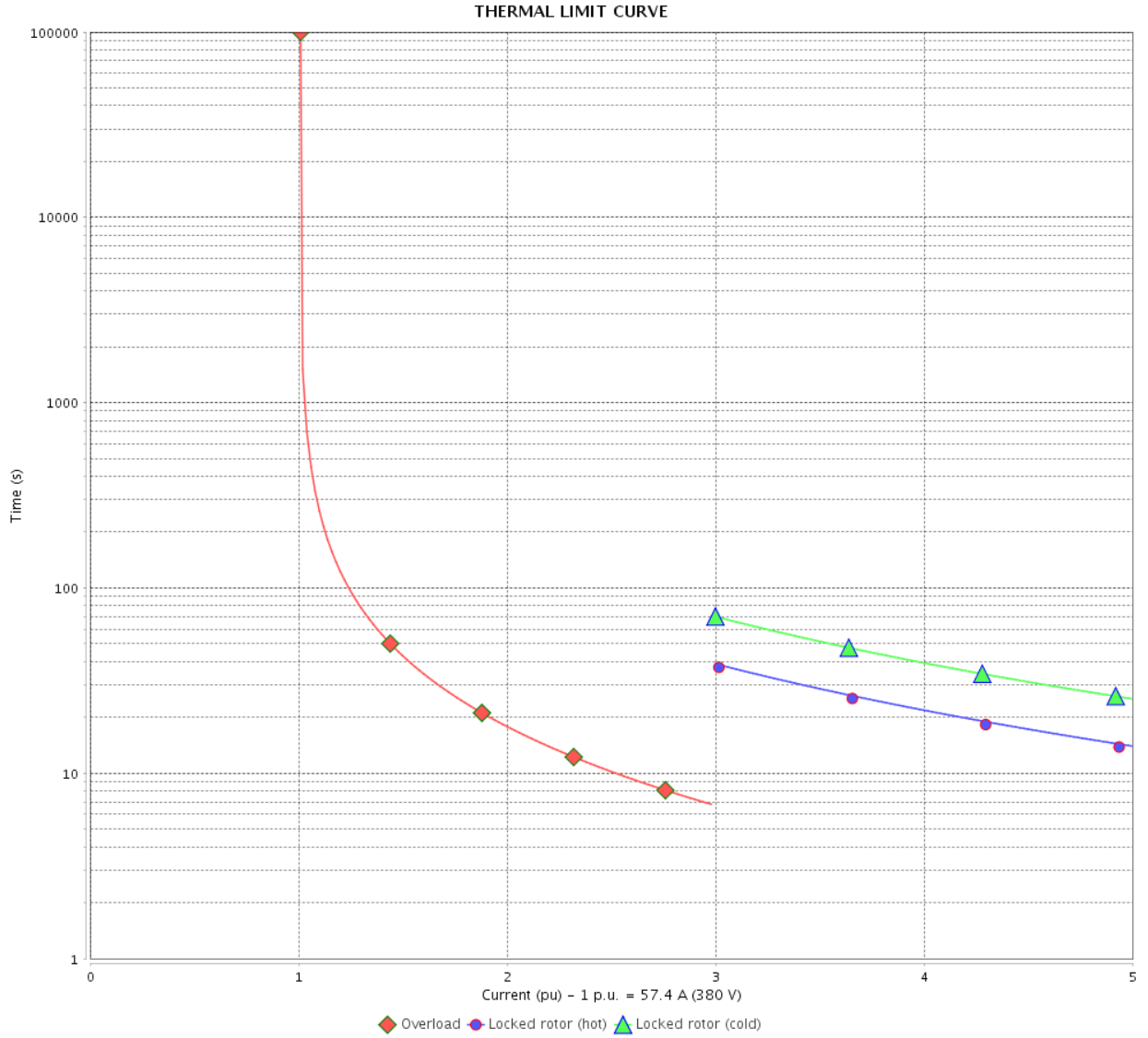

Rev.	Changes Summary	Performed	Checked	Date
Performed by		Page 25 / 36		Revision
Checked by				
Date				

THERMAL LIMIT CURVE



Three Phase Induction Motor - Squirrel Cage

Customer :

Product line : NEMA Premium Efficiency Three-Phase
Product code : 12448085
Catalog # : 04018ET3E324TS-W22

Performance : 400 V 50 Hz 4P IE2

Rated current	: 54.1 A	Moment of inertia (J)	: 9.16 sq.ft.lb
LRC	: 5.6	Duty cycle	: Cont.(S1)
Rated torque	: 143 ft.lb	Insulation class	: F
Locked rotor torque	: 190 %	Service factor	: 1.00
Breakdown torque	: 210 %	Temperature rise	: 105 K
Rated speed	: 1465 rpm	Design	: B

Heating constant

Cooling constant

Rev.	Changes Summary	Performed	Checked	Date
Performed by				
Checked by			Page	Revision
Date	12/04/2022		26 / 36	

THERMAL LIMIT CURVE

Three Phase Induction Motor - Squirrel Cage



Customer : _____

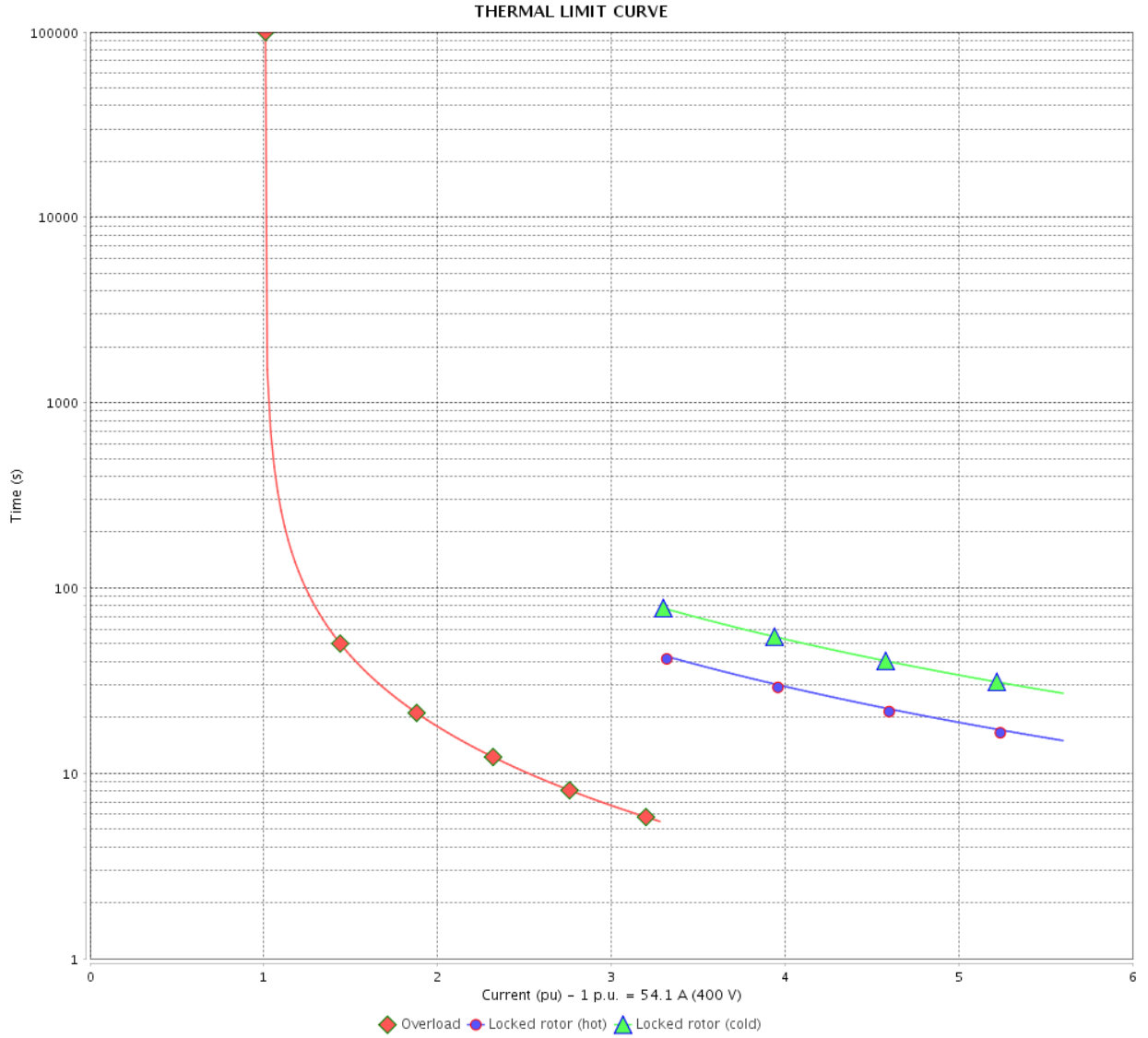

Rev.	Changes Summary	Performed	Checked	Date
Performed by		Page 27 / 36		Revision
Checked by				
Date				

THERMAL LIMIT CURVE

Three Phase Induction Motor - Squirrel Cage



Customer :

Product line : NEMA Premium Efficiency Three-Phase
Product code : 12448085
Catalog # : 04018ET3E324TS-W22

Performance : 415 V 50 Hz 4P IE2

Rated current	: 52.8 A	Moment of inertia (J)	: 9.16 sq.ft.lb
LRC	: 6.0	Duty cycle	: Cont.(S1)
Rated torque	: 143 ft.lb	Insulation class	: F
Locked rotor torque	: 210 %	Service factor	: 1.00
Breakdown torque	: 229 %	Temperature rise	: 80 K
Rated speed	: 1470 rpm	Design	: B

Heating constant

Cooling constant

Rev.	Changes Summary	Performed	Checked	Date
Performed by				
Checked by			Page	Revision
Date	12/04/2022		28 / 36	

THERMAL LIMIT CURVE

Three Phase Induction Motor - Squirrel Cage



Customer : _____

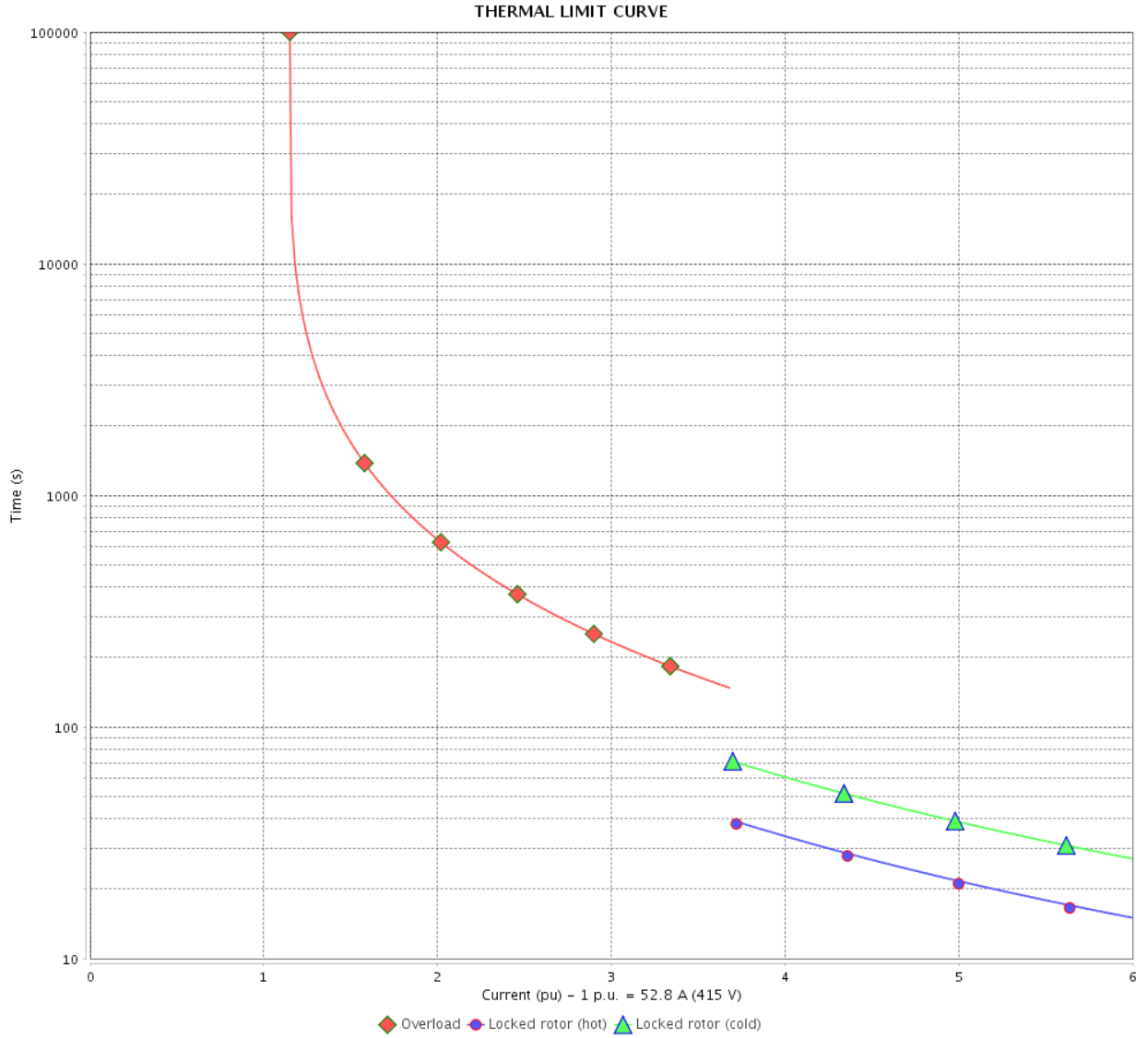

Rev.	Changes Summary	Performed	Checked	Date
Performed by				
Checked by				
Date				
			Page	Revision
			29 / 36	

VFD OPERATION CURVE

Three Phase Induction Motor - Squirrel Cage



Customer :

Product line : NEMA Premium Efficiency Three-Phase

Product code : 12448085

Catalog # : 04018ET3E324TS-W22

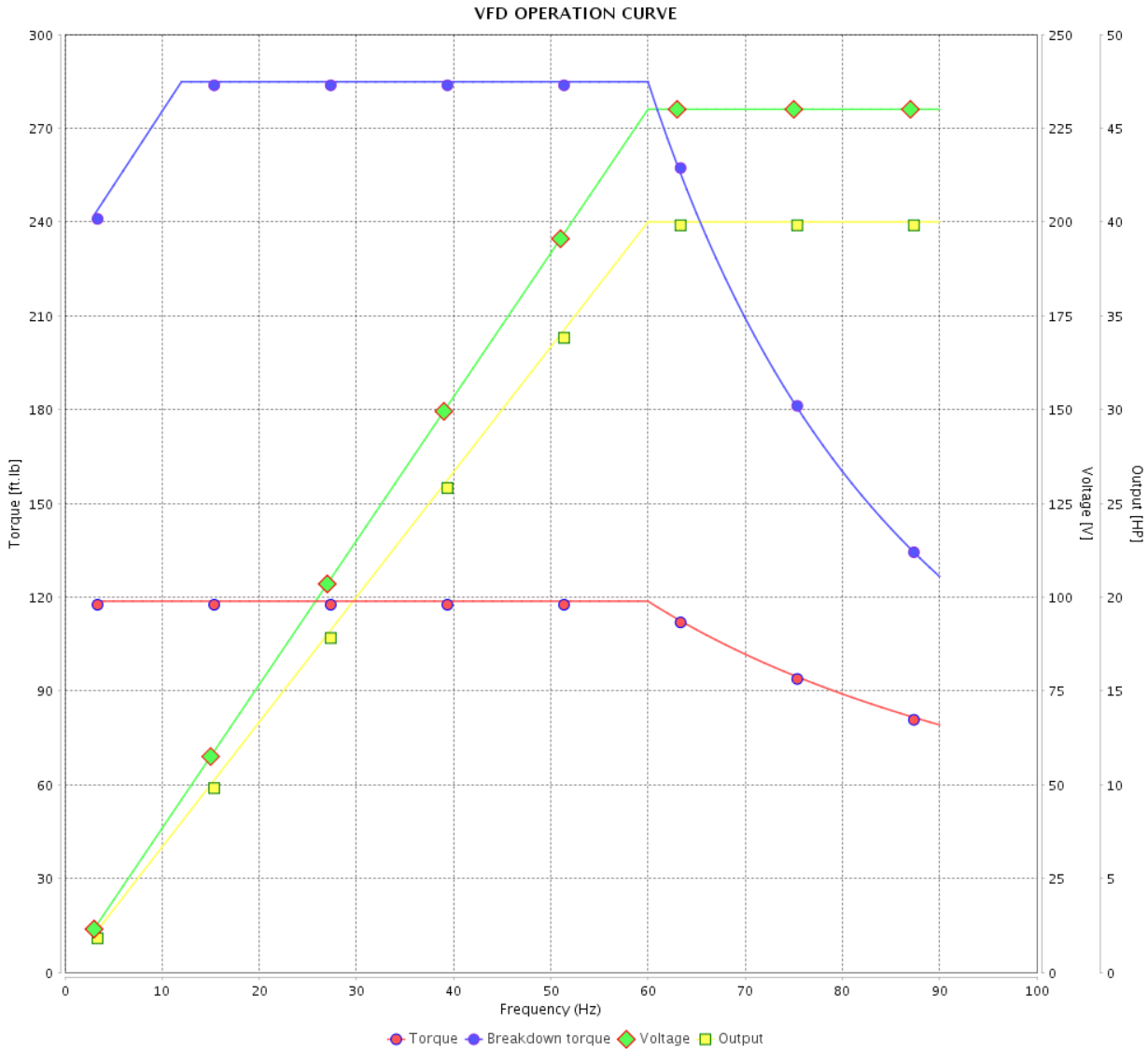

Performance : 230/460 V 60 Hz 4P

Rated current : 94.2/47.1 A
 LRC : 6.1
 Rated torque : 119 ft.lb
 Locked rotor torque : 229 %
 Breakdown torque : 240 %
 Rated speed : 1770 rpm

Moment of inertia (J) : 9.16 sq.ft.lb
 Duty cycle : Cont.(S1)
 Insulation class : F
 Service factor : 1.25
 Temperature rise : 80 K
 Design : B

Rev.	Changes Summary	Performed	Checked	Date
Performed by			Page 30 / 36	Revision
Checked by				
Date	12/04/2022			

VFD OPERATION CURVE

Three Phase Induction Motor - Squirrel Cage



Customer :

Product line : NEMA Premium Efficiency Three-Phase

Product code : 12448085

Catalog # : 04018ET3E324TS-W22

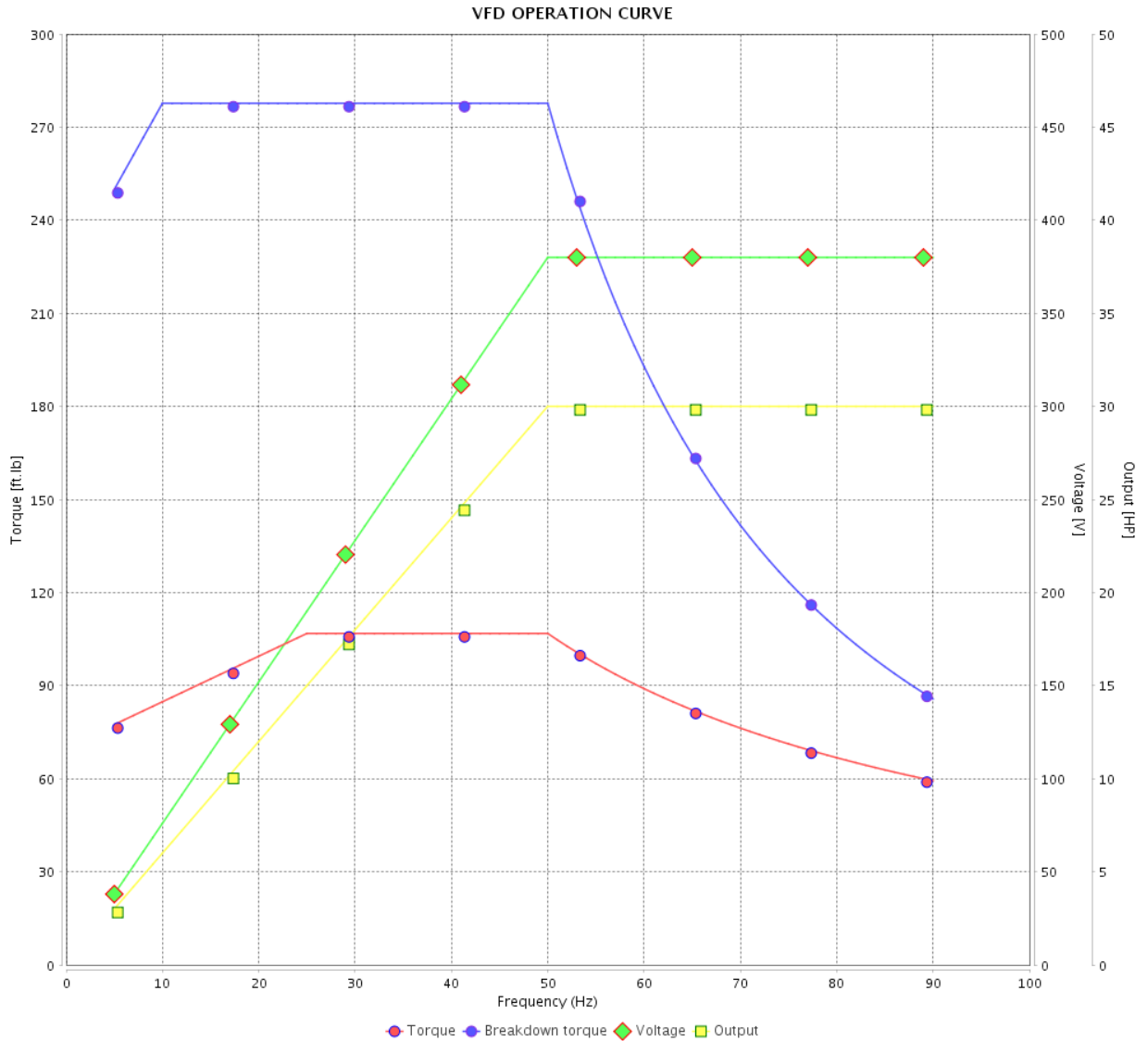

Performance : 380 V 50 Hz 4P IE3

Rated current : 42.8 A
 LRC : 6.6
 Rated torque : 107 ft.lb
 Locked rotor torque : 240 %
 Breakdown torque : 260 %
 Rated speed : 1475 rpm

Moment of inertia (J) : 9.16 sq.ft.lb
 Duty cycle : Cont.(S1)
 Insulation class : F
 Service factor : 1.00
 Temperature rise : 80 K
 Design : B

Rev.	Changes Summary	Performed	Checked	Date
Performed by			Page	Revision
Checked by				
Date				

VFD OPERATION CURVE

Three Phase Induction Motor - Squirrel Cage



Customer :

Product line : NEMA Premium Efficiency Three-Phase

Product code : 12448085

Catalog # : 04018ET3E324TS-W22

VFD OPERATION CURVE

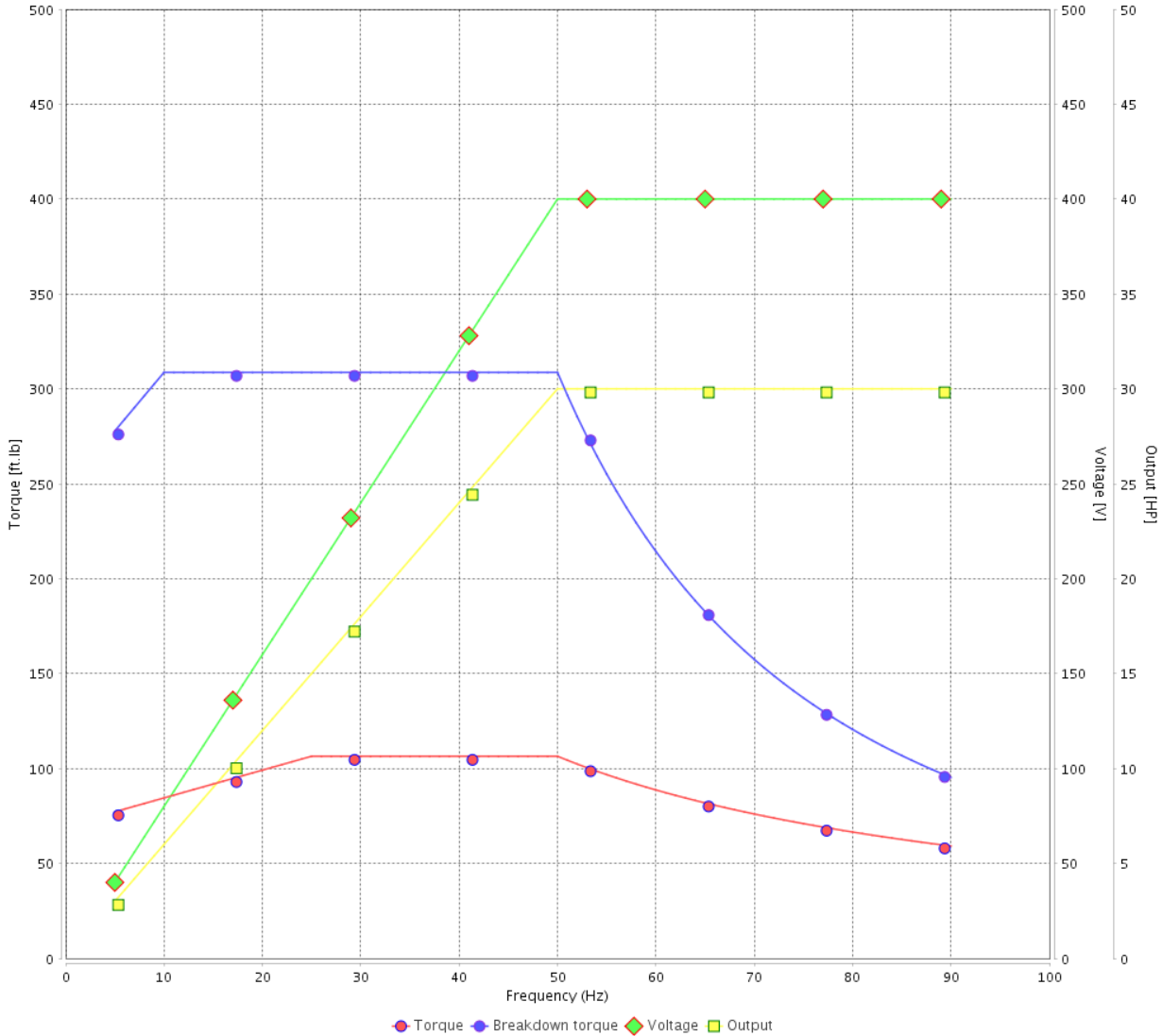

Performance : 400 V 50 Hz 4P IE3

Rated current	: 41.6 A	Moment of inertia (J)	: 9.16 sq.ft.lb
LRC	: 7.3	Duty cycle	: Cont.(S1)
Rated torque	: 106 ft.lb	Insulation class	: F
Locked rotor torque	: 270 %	Service factor	: 1.00
Breakdown torque	: 290 %	Temperature rise	: 80 K
Rated speed	: 1480 rpm	Design	: B

Rev.	Changes Summary	Performed	Checked	Date
Performed by		Page		Revision
Checked by		32 / 36		
Date	12/04/2022			

VFD OPERATION CURVE

Three Phase Induction Motor - Squirrel Cage



Customer :

Product line : NEMA Premium Efficiency Three-Phase

Product code : 12448085

Catalog # : 04018ET3E324TS-W22

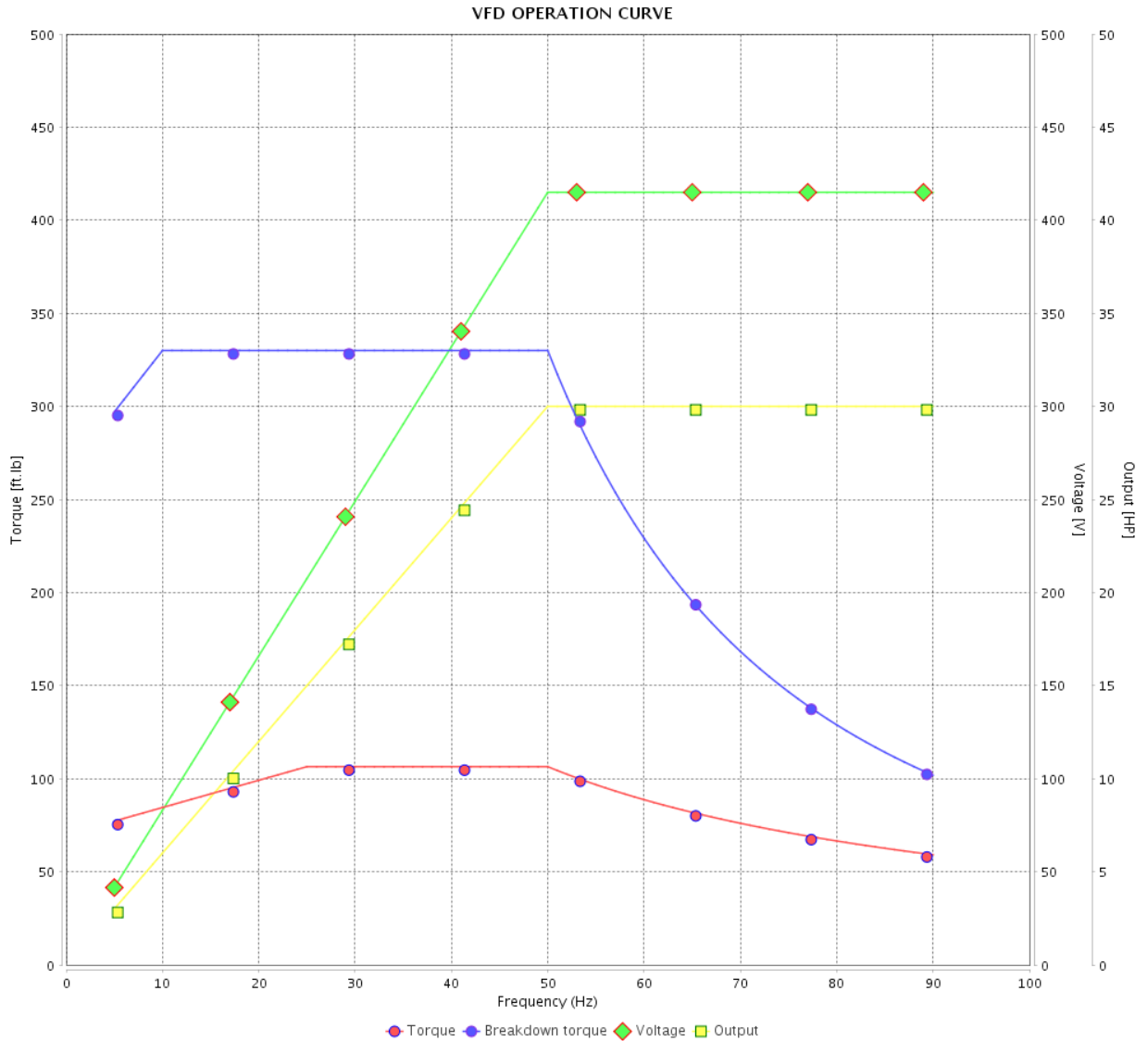

Performance : 415 V 50 Hz 4P IE3

Rated current : 41.1 A
 LRC : 7.7
 Rated torque : 106 ft.lb
 Locked rotor torque : 280 %
 Breakdown torque : 310 %
 Rated speed : 1480 rpm

Moment of inertia (J) : 9.16 sq.ft.lb
 Duty cycle : Cont.(S1)
 Insulation class : F
 Service factor : 1.00
 Temperature rise : 80 K
 Design : B

Rev.	Changes Summary	Performed	Checked	Date
Performed by			Page 33 / 36	Revision
Checked by				
Date	12/04/2022			

VFD OPERATION CURVE

Three Phase Induction Motor - Squirrel Cage



Customer :

Product line : NEMA Premium Efficiency Three-Phase

Product code : 12448085

Catalog # : 04018ET3E324TS-W22

VFD OPERATION CURVE

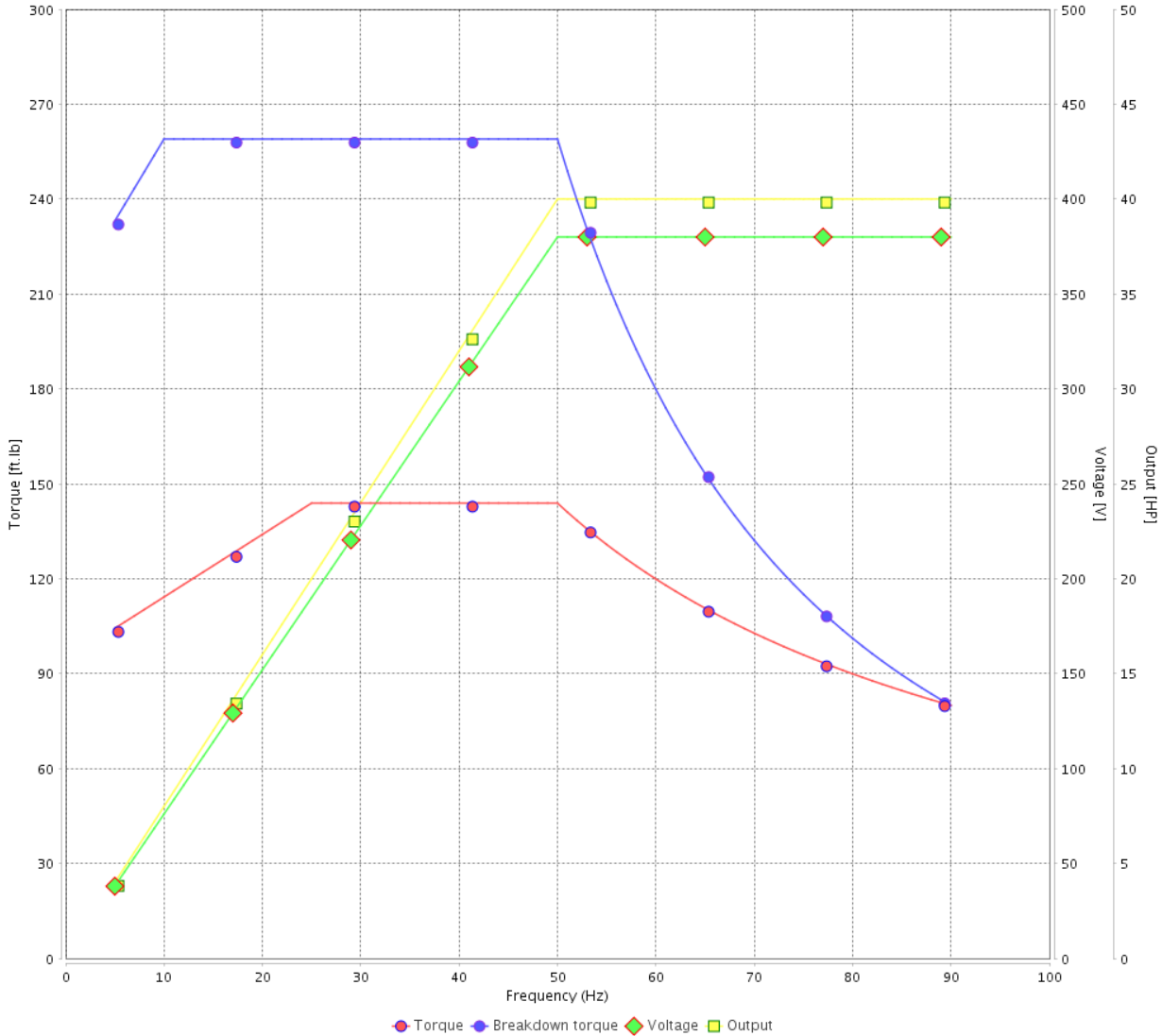

Performance : 380 V 50 Hz 4P IE2

Rated current	: 57.4 A	Moment of inertia (J)	: 9.16 sq.ft.lb
LRC	: 5.0	Duty cycle	: Cont.(S1)
Rated torque	: 144 ft.lb	Insulation class	: F
Locked rotor torque	: 170 %	Service factor	: 1.00
Breakdown torque	: 180 %	Temperature rise	: 105 K
Rated speed	: 1460 rpm	Design	: B

Rev.	Changes Summary	Performed	Checked	Date
Performed by			Page 34 / 36	Revision
Checked by				
Date	12/04/2022			

VFD OPERATION CURVE

Three Phase Induction Motor - Squirrel Cage



Customer : _____

Product line : NEMA Premium Efficiency Three-Phase

Product code : 12448085

Catalog # : 04018ET3E324TS-W22

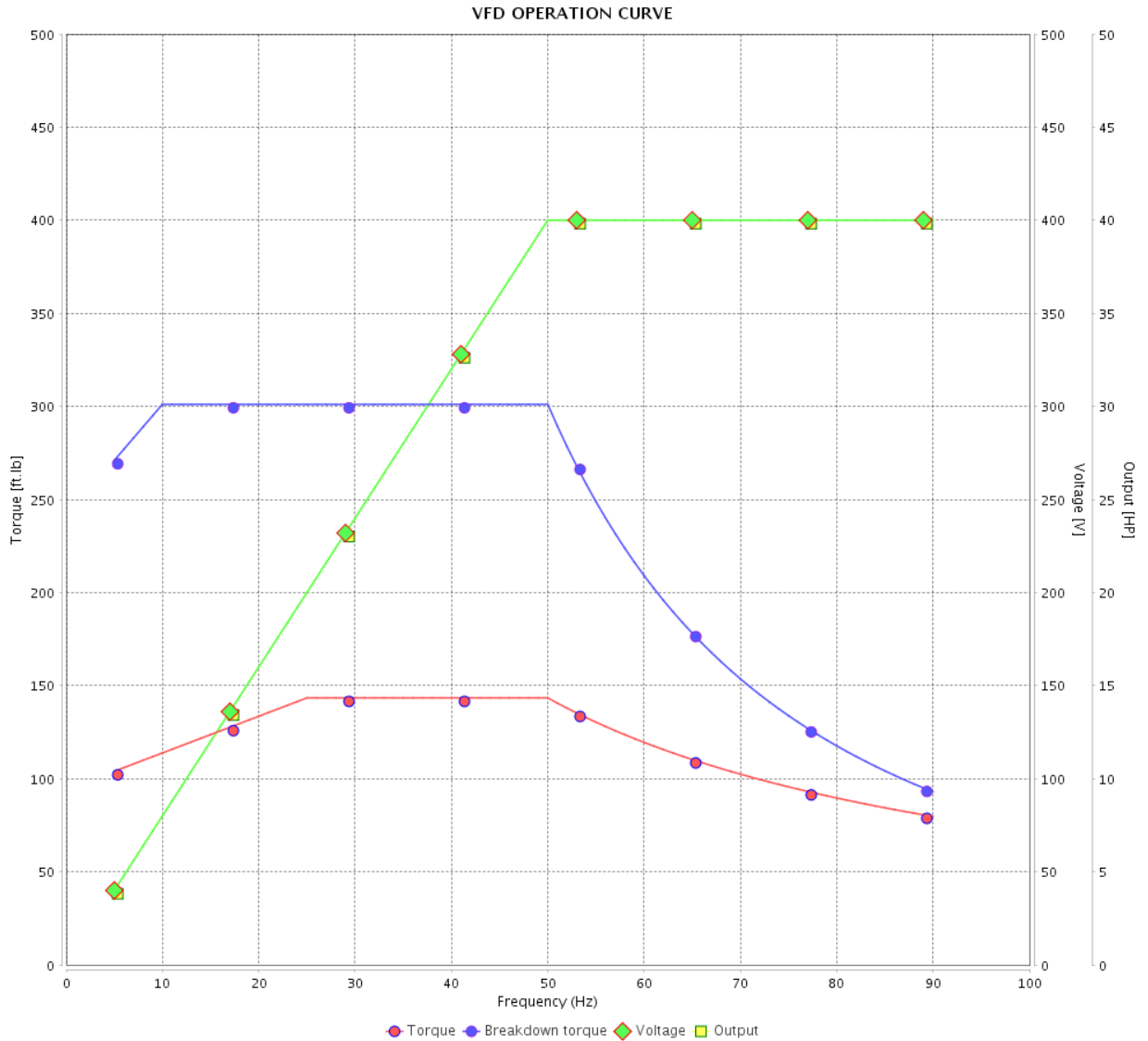

Performance : 400 V 50 Hz 4P IE2

Rated current : 54.1 A
 LRC : 5.6
 Rated torque : 143 ft.lb
 Locked rotor torque : 190 %
 Breakdown torque : 210 %
 Rated speed : 1465 rpm

Moment of inertia (J) : 9.16 sq.ft.lb
 Duty cycle : Cont.(S1)
 Insulation class : F
 Service factor : 1.00
 Temperature rise : 105 K
 Design : B

Rev.	Changes Summary	Performed	Checked	Date
Performed by		Page		Revision
Checked by		35 / 36		
Date	12/04/2022			

VFD OPERATION CURVE

Three Phase Induction Motor - Squirrel Cage



Customer : _____

Product line : NEMA Premium Efficiency Three-Phase

Product code : 12448085

Catalog # : 04018ET3E324TS-W22

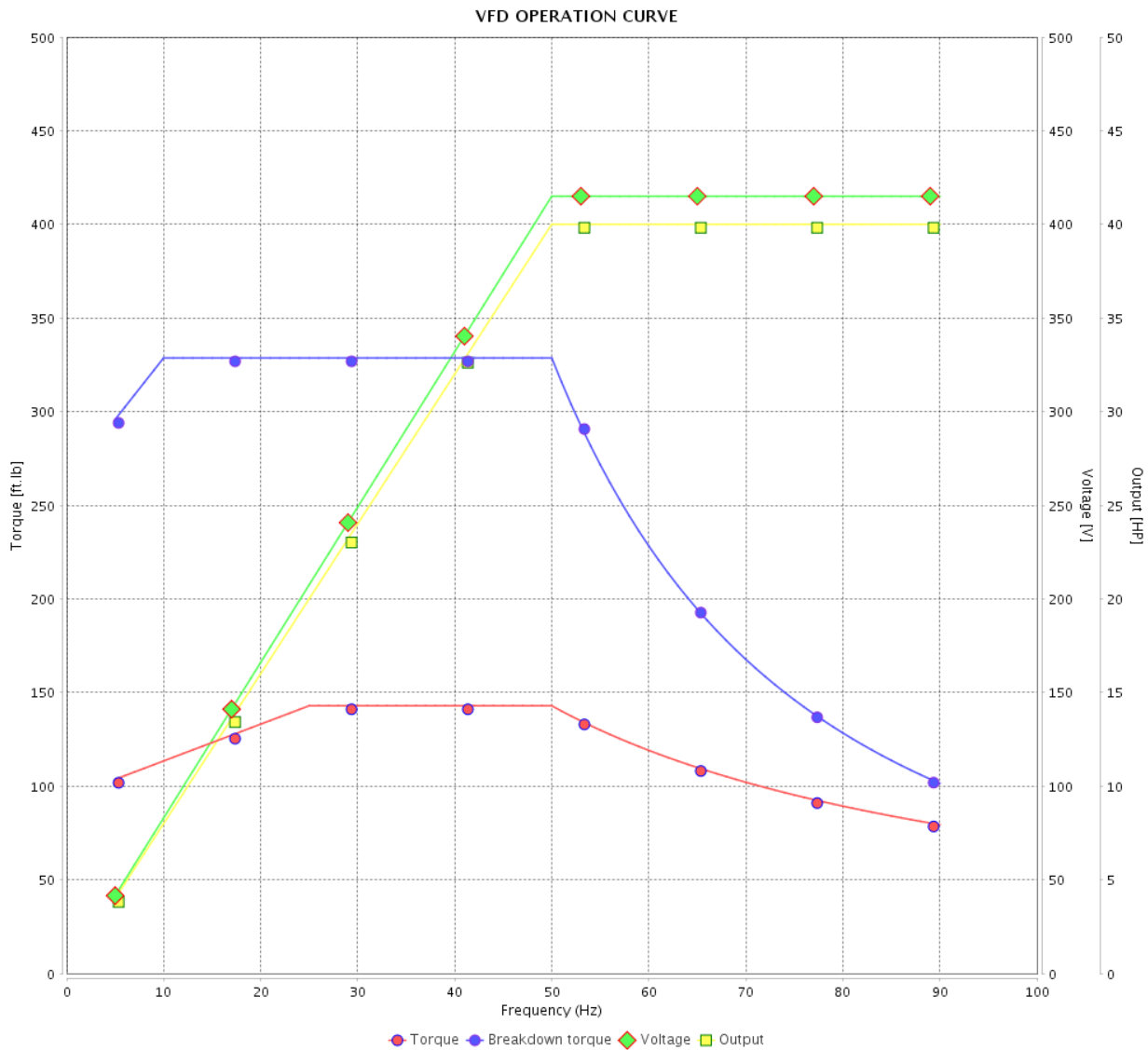

Performance : 415 V 50 Hz 4P IE2

Rated current	: 52.8 A	Moment of inertia (J)	: 9.16 sq.ft.lb
LRC	: 6.0	Duty cycle	: Cont.(S1)
Rated torque	: 143 ft.lb	Insulation class	: F
Locked rotor torque	: 210 %	Service factor	: 1.00
Breakdown torque	: 229 %	Temperature rise	: 80 K
Rated speed	: 1470 rpm	Design	: B

Rev.	Changes Summary	Performed	Checked	Date
Performed by			Page 36 / 36	Revision
Checked by				
Date	12/04/2022			

1 2 3 4 5 6

A

B

C

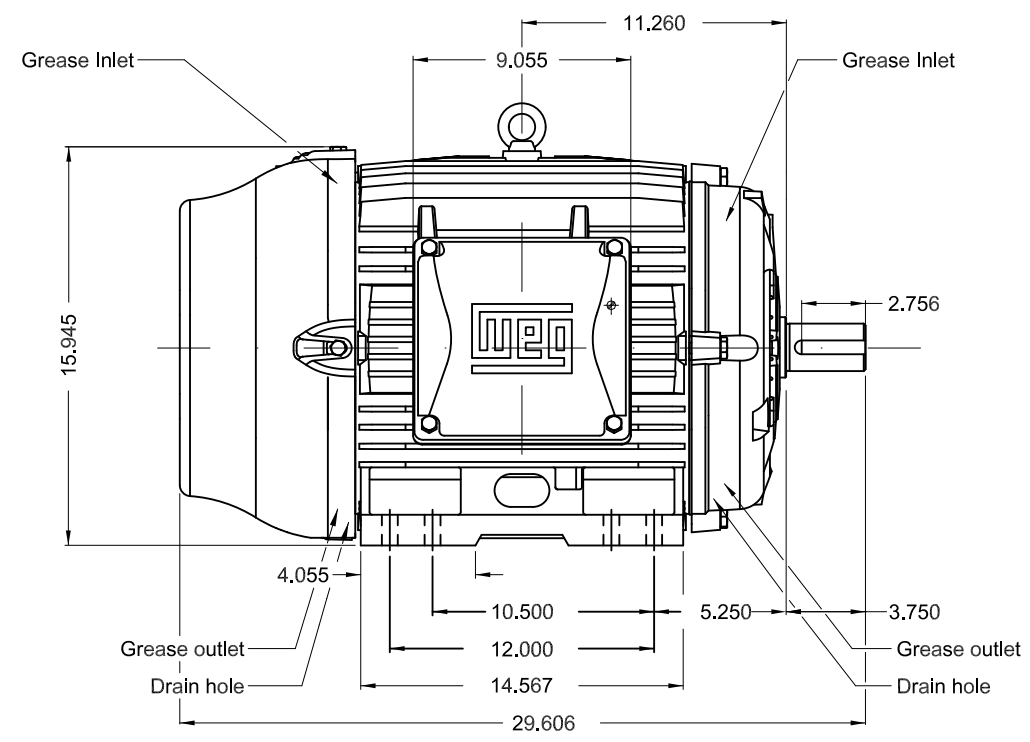
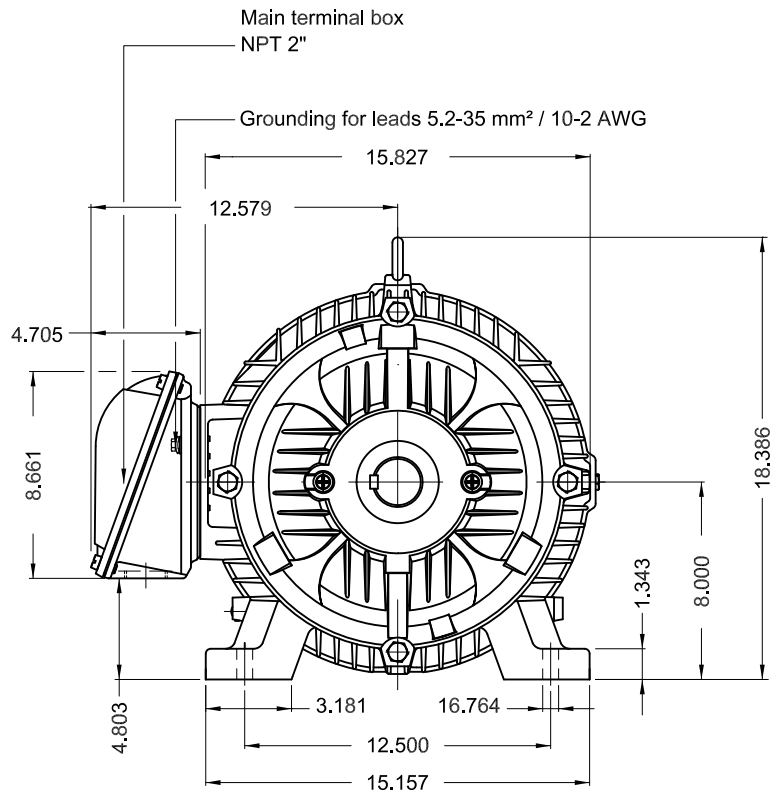

D

E

TS shaft end
Color RAL 5009
Painting plan 203A
Mounting NEMA F-1
Mounting B3R(D)

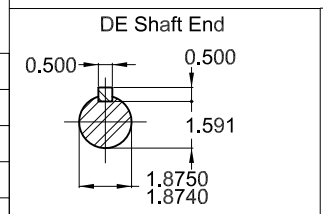

40 HP 04 Poles 60 Hz A

ECM	LOC	SUMMARY OF MODIFICATIONS	EXECUTED	CHECKED	RELEASED	DATE	VER
EXECUTED	PIRWBUSER	THREE PH. MOTOR W22 PREM. EFF. FRAME 324/6TS IP55 TEFC					
CHECKED							
RELEASED							
REL DT.	WMO	Jaragua do Sul	Product Engineering	SHEET 1 / 1			

PREVIEW
WDD



MADE IN MEXICO
12448085



FOR SAFE AREA
Mod.TE1BFOXON
CC029A



For use on 60Hz
Class I, Div 2, Gr A, B, C and D - T3
Class I, Zone 2, IIC - T3
Class II, Div 2, Gr F and G - T4
For use on PWM: Gr. A, B, C, D and F,
VT 1000:1, CT 20:1, 1.00SF - T3A

MODEL 04018ET3E324TS-W22

Inverter Duty Motor
Severe Duty

PH3 60Hz Fr. 324/6TS 1000m.a.s.l. IP55 TEFC 570lb

V 230/460 A 94.2/47.1

HP 40 kW 30

SF 1.25 SFA 118/58.9

RPM 1770 PF 0.85

AMB 40°C INS cl. F DT80K NEMA NOM EFF 94.1%

DUTY CONT. DES B Code G

USABLE @208V 104A SF 1.15 SFA 120

40HP 30kW 50Hz 380V 57.4A 1460RPM SF 1.00 EFF 92.4% (IE2)

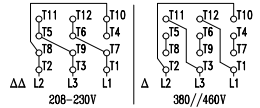

- 6312-C3 (21g)
- 6212-C3 (13g)

MOBIL POLYREX EM (20000h)

