

# DATA SHEET



## Three Phase Induction Motor - Squirrel Cage

Customer :							
Product line	: NEMA Premium Efficiency Three-Phase	Product code :	11625473				
		Catalog # :	04018ET3ER324TC-W22				
Frame	: 324TC	Cooling method	: IC411 - TEFC				
Insulation class	: F	Mounting	: W-6				
Duty cycle	: Cont.(S1)	Rotation <sup>1</sup>	: Both (CW and CCW)				
Ambient temperature	: -20°C to +40°C	Starting method	: Direct On Line				
Altitude	: 1000 m.a.s.l.	Approx. weight <sup>2</sup>	: 567 lb				
Protection degree	: IP55	Moment of inertia (J)	: 9.16 sq.ft.lb				
Design	: B						
Output [HP]	40	30	30	30	40	40	40
Poles	4	4	4	4	4	4	4
Frequency [Hz]	60	50	50	50	50	50	50
Rated voltage [V]	230/460	380	400	415	380	400	415
Rated current [A]	94.2/47.1	42.8	41.6	41.1	57.4	57.4	52.8
L. R. Amperes [A]	575/287	282	304	316	287	287	317
LRC [A]	6.1x(Code G)	6.6x(Code H)	7.3x(Code J)	7.7x(Code J)	5.0x(Code E)	5.0x(Code E)	6.0x(Code G)
No load current [A]	34.0/17.0	16.8	17.3	18.6	16.8	16.8	18.6
Rated speed [RPM]	1770	1475	1480	1480	1460	1460	1470
Slip [%]	1.67	1.67	1.33	1.33	2.67	2.67	2.00
Rated torque [ft.lb]	118	107	106	106	144	144	143
Locked rotor torque [%]	229	240	270	280	170	170	210
Breakdown torque [%]	240	260	290	310	180	180	229
Service factor	1.25	1.00	1.00	1.00	1.00	1.00	1.00
Temperature rise	80 K	80 K	80 K	80 K	105 K	105 K	80 K
Locked rotor time	36s (cold) 20s (hot)	25s (cold) 14s (hot)	27s (cold) 15s (hot)	27s (cold) 15s (hot)	25s (cold) 14s (hot)	25s (cold) 14s (hot)	27s (cold) 15s (hot)
Noise level <sup>2</sup>	66.0 dB(A)	63.0 dB(A)	63.0 dB(A)	63.0 dB(A)	63.0 dB(A)	63.0 dB(A)	63.0 dB(A)
Efficiency (%)	25%	93.4	92.8	92.1	91.1	94.0	92.8
	50%	93.6	92.9	92.4	91.7	93.6	93.0
	75%	94.1	93.1	93.0	92.6	93.0	93.0
	100%	94.1	93.0	93.2	93.1	92.4	93.0
Power Factor	25%	0.46	0.43	0.40	0.38	0.53	0.47
	50%	0.72	0.68	0.64	0.62	0.78	0.72
	75%	0.80	0.78	0.75	0.73	0.84	0.80
	100%	0.85	0.84	0.82	0.80	0.86	0.85
Bearing type	: Drive end : 6312 C3	Non drive end : 6212 C3	Foundation loads				
Sealing	: V'Ring	V'Ring	Max. traction	: 978 lb			
Lubrication interval	: 14000 h	15000 h	Max. compression	: 1545 lb			
Lubricant amount	: 21 g	13 g					
Lubricant type	: Mobil Polyrex EM						
Notes USABLE @208V 104A SF 1.15 SFA 120A							
This revision replaces and cancel the previous one, which must be eliminated. (1) Looking the motor from the shaft end. (2) Measured at 1m and with tolerance of +3dB(A). (3) Approximate weight subject to changes after manufacturing process. (4) At 100% of full load.				These are average values based on tests with sinusoidal power supply, subject to the tolerances stipulated in NEMA MG-1.			
Rev.	Changes Summary			Performed	Checked	Date	
Performed by							
Checked by					Page	Revision	
Date	12/04/2022				1 / 36		

# TORQUE AND CURRENT VS SPEED CURVE

## Three Phase Induction Motor - Squirrel Cage



Customer :

Product line : NEMA Premium Efficiency Three-Phase

Product code : 11625473

Catalog # : 04018ET3ER324TC-W22

TORQUE AND CURRENT VS SPEED CURVE

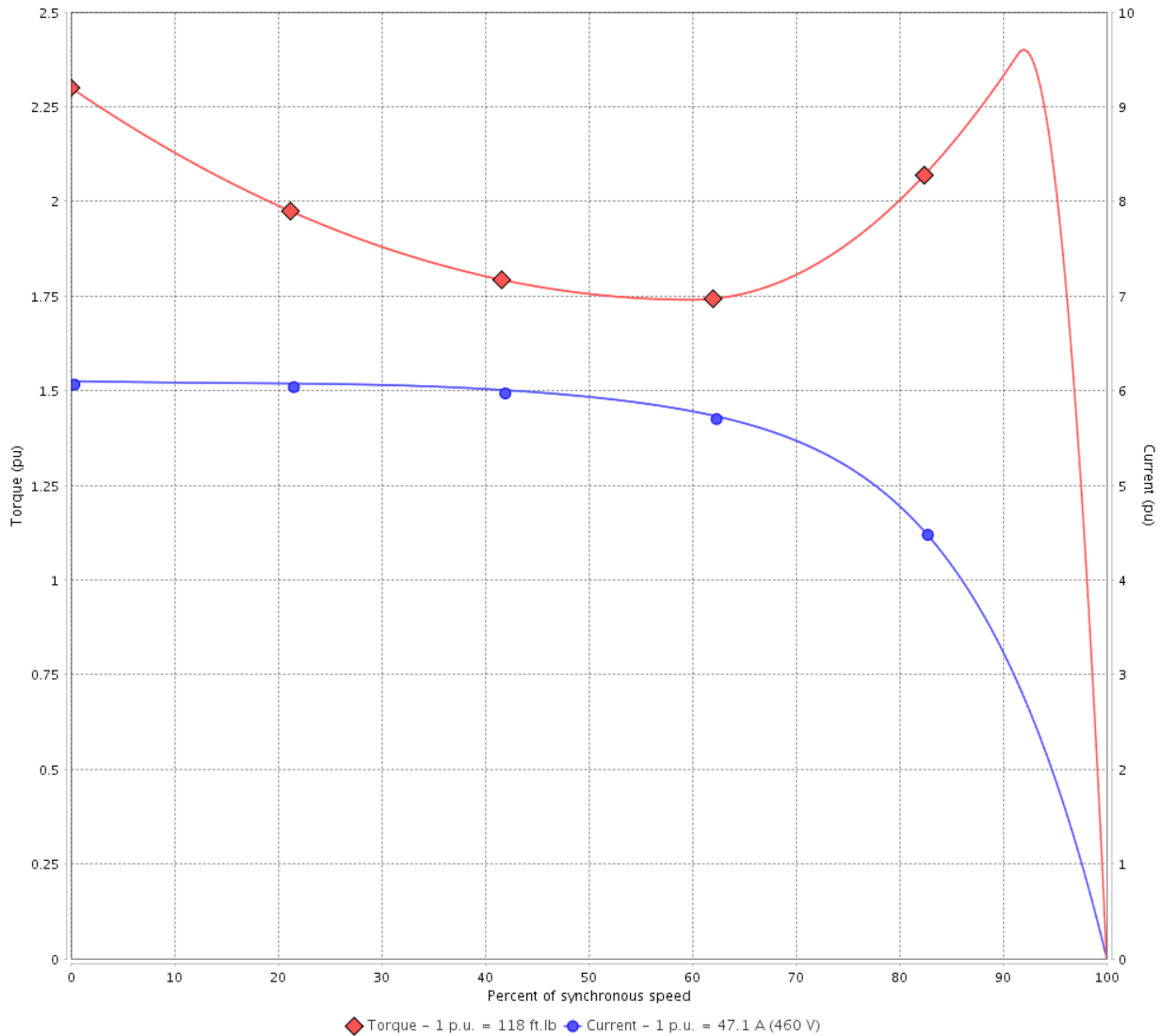

Performance : 230/460 V 60 Hz 4P

Rated current	: 94.2/47.1 A	Moment of inertia (J)	: 9.16 sq.ft.lb
LRC	: 6.1	Duty cycle	: Cont.(S1)
Rated torque	: 118 ft.lb	Insulation class	: F
Locked rotor torque	: 229 %	Service factor	: 1.25
Breakdown torque	: 240 %	Temperature rise	: 80 K
Rated speed	: 1770 rpm	Design	: B

Locked rotor time : 36s (cold) 20s (hot)

Rev.	Changes Summary	Performed	Checked	Date
Performed by			Page 2 / 36	Revision
Checked by				
Date	12/04/2022			

# TORQUE AND CURRENT VS SPEED CURVE



## Three Phase Induction Motor - Squirrel Cage

Customer :

Product line : NEMA Premium Efficiency Three-Phase

Product code : 11625473

Catalog # : 04018ET3ER324TC-W22

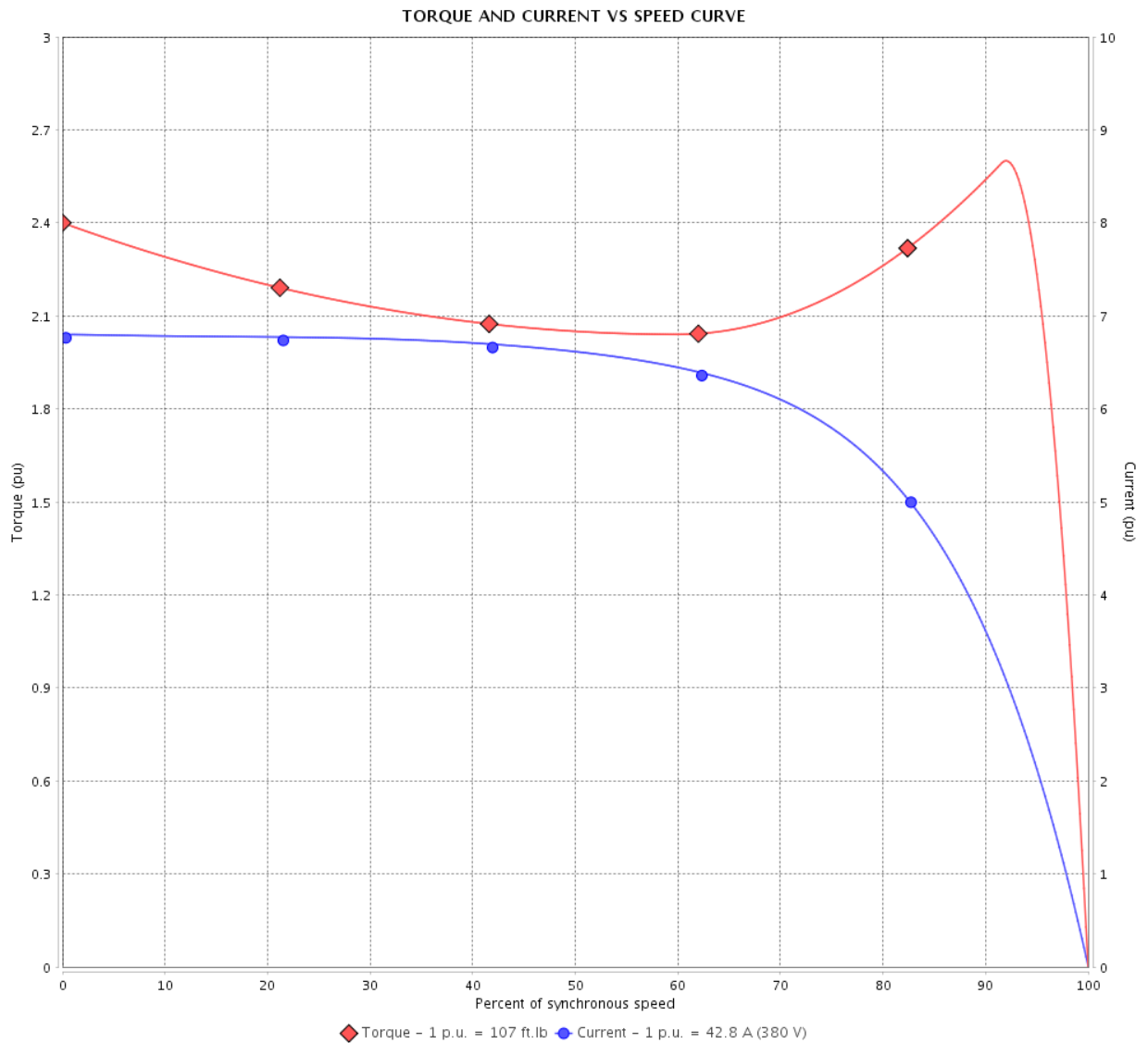

Performance : 380 V 50 Hz 4P IE3

Rated current	: 42.8 A	Moment of inertia (J)	: 9.16 sq.ft.lb
LRC	: 6.6	Duty cycle	: Cont.(S1)
Rated torque	: 107 ft.lb	Insulation class	: F
Locked rotor torque	: 240 %	Service factor	: 1.00
Breakdown torque	: 260 %	Temperature rise	: 80 K
Rated speed	: 1475 rpm	Design	: B

Locked rotor time : 25s (cold) 14s (hot)

Rev.	Changes Summary	Performed	Checked	Date
Performed by			Page 3 / 36	Revision
Checked by				
Date	12/04/2022			

# TORQUE AND CURRENT VS SPEED CURVE

Three Phase Induction Motor - Squirrel Cage



Customer :

Product line : NEMA Premium Efficiency Three-Phase

Product code : 11625473

Catalog # : 04018ET3ER324TC-W22

TORQUE AND CURRENT VS SPEED CURVE

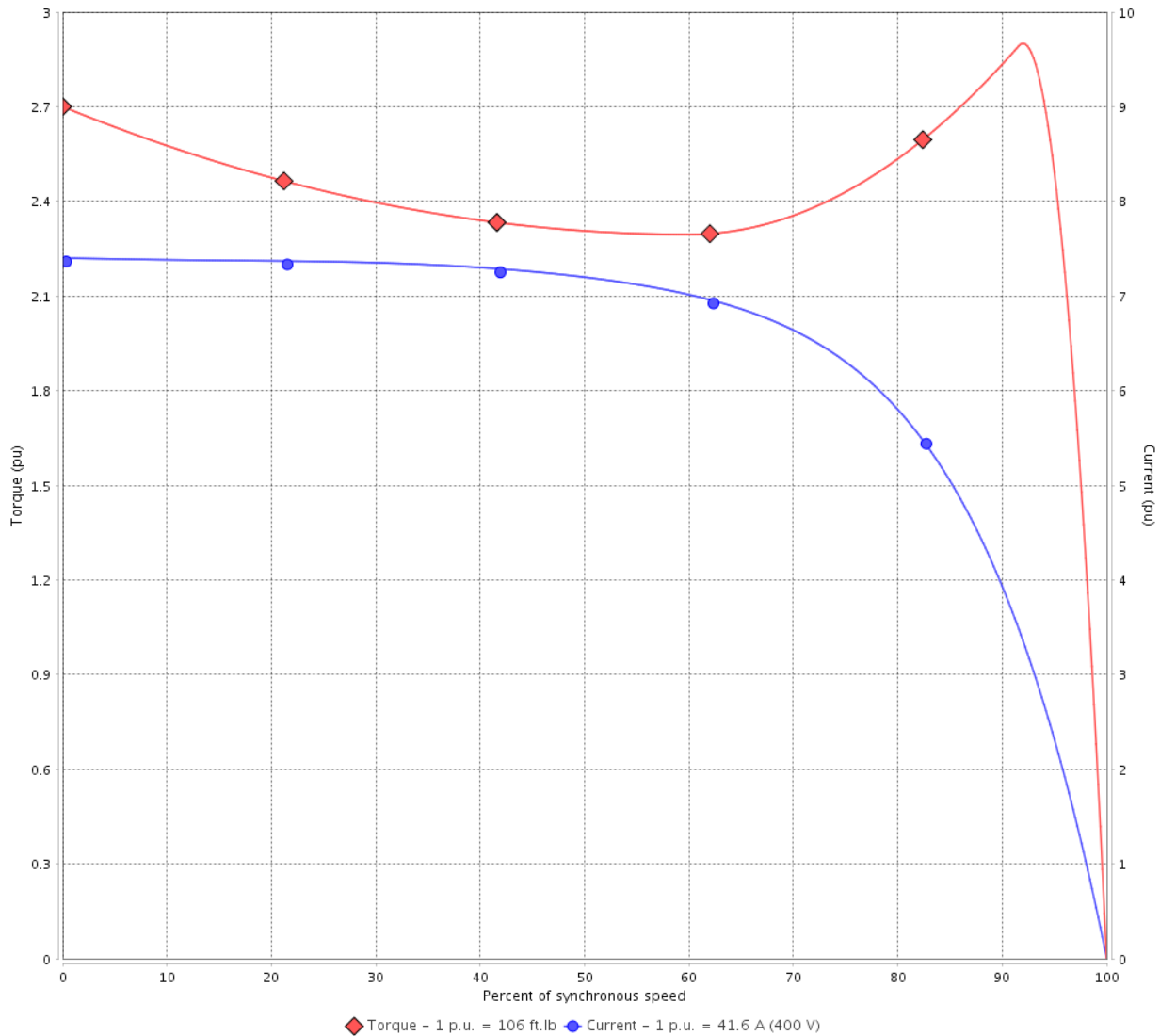

Performance : 400 V 50 Hz 4P IE3

Rated current	: 41.6 A	Moment of inertia (J)	: 9.16 sq.ft.lb
LRC	: 7.3	Duty cycle	: Cont.(S1)
Rated torque	: 106 ft.lb	Insulation class	: F
Locked rotor torque	: 270 %	Service factor	: 1.00
Breakdown torque	: 290 %	Temperature rise	: 80 K
Rated speed	: 1480 rpm	Design	: B

Locked rotor time : 27s (cold) 15s (hot)

Rev.	Changes Summary	Performed	Checked	Date
Performed by			Page 4 / 36	Revision
Checked by				
Date	12/04/2022			

# TORQUE AND CURRENT VS SPEED CURVE



## Three Phase Induction Motor - Squirrel Cage

Customer :

Product line : NEMA Premium Efficiency Three-Phase

Product code : 11625473

Catalog # : 04018ET3ER324TC-W22

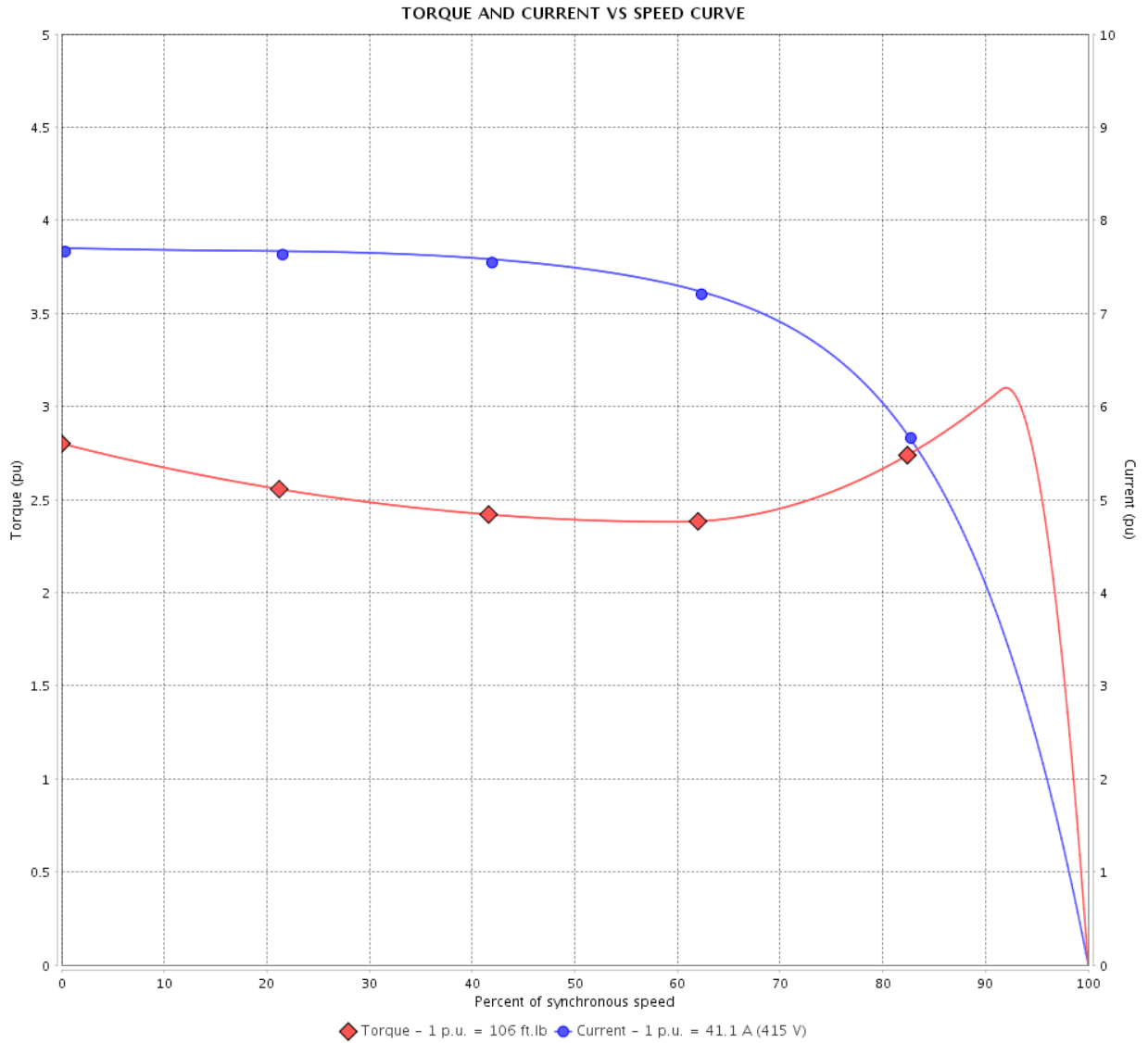

Performance : 415 V 50 Hz 4P IE3

Rated current	: 41.1 A	Moment of inertia (J)	: 9.16 sq.ft.lb
LRC	: 7.7	Duty cycle	: Cont.(S1)
Rated torque	: 106 ft.lb	Insulation class	: F
Locked rotor torque	: 280 %	Service factor	: 1.00
Breakdown torque	: 310 %	Temperature rise	: 80 K
Rated speed	: 1480 rpm	Design	: B

Locked rotor time : 27s (cold) 15s (hot)

Rev.	Changes Summary	Performed	Checked	Date
Performed by			Page 5 / 36	Revision
Checked by				
Date	12/04/2022			

# TORQUE AND CURRENT VS SPEED CURVE

## Three Phase Induction Motor - Squirrel Cage



Customer :

Product line : NEMA Premium Efficiency Three-Phase

Product code : 11625473

Catalog # : 04018ET3ER324TC-W22

TORQUE AND CURRENT VS SPEED CURVE

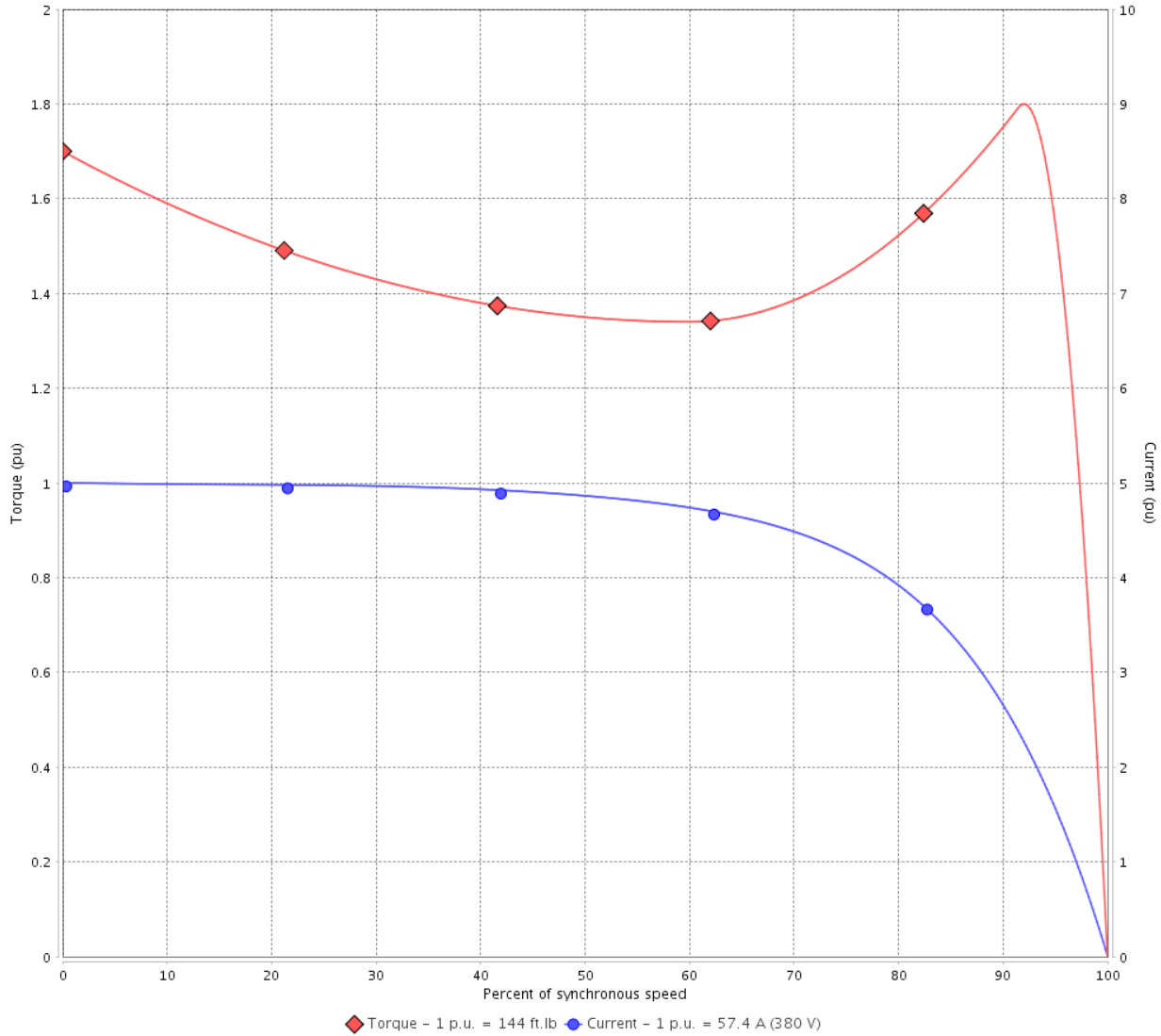

Performance : 380 V 50 Hz 4P IE2

Rated current	: 57.4 A	Moment of inertia (J)	: 9.16 sq.ft.lb
LRC	: 5.0	Duty cycle	: Cont.(S1)
Rated torque	: 144 ft.lb	Insulation class	: F
Locked rotor torque	: 170 %	Service factor	: 1.00
Breakdown torque	: 180 %	Temperature rise	: 105 K
Rated speed	: 1460 rpm	Design	: B

Locked rotor time : 25s (cold) 14s (hot)

Rev.	Changes Summary	Performed	Checked	Date
Performed by			Page 6 / 36	Revision
Checked by				
Date	12/04/2022			

# TORQUE AND CURRENT VS SPEED CURVE



## Three Phase Induction Motor - Squirrel Cage

Customer :

Product line : NEMA Premium Efficiency Three-Phase

Product code : 11625473

Catalog # : 04018ET3ER324TC-W22

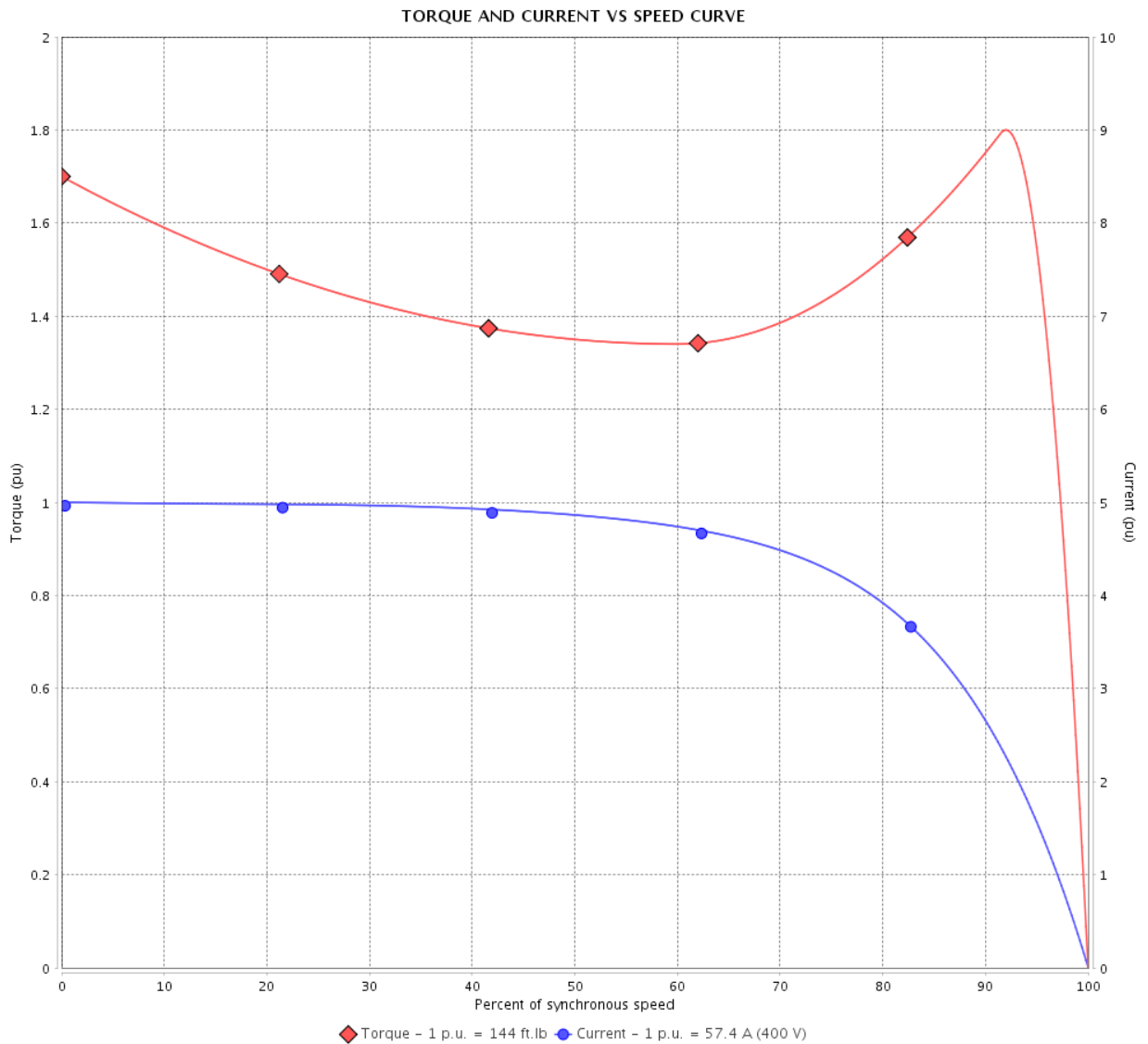

Performance : 400 V 50 Hz 4P IE2

Rated current	: 57.4 A	Moment of inertia (J)	: 9.16 sq.ft.lb
LRC	: 5.0	Duty cycle	: Cont.(S1)
Rated torque	: 144 ft.lb	Insulation class	: F
Locked rotor torque	: 170 %	Service factor	: 1.00
Breakdown torque	: 180 %	Temperature rise	: 105 K
Rated speed	: 1460 rpm	Design	: B

Locked rotor time : 25s (cold) 14s (hot)

Rev.	Changes Summary	Performed	Checked	Date
Performed by			Page	Revision
Checked by			7 / 36	
Date	12/04/2022			

# TORQUE AND CURRENT VS SPEED CURVE

Three Phase Induction Motor - Squirrel Cage



Customer :

Product line : NEMA Premium Efficiency Three-Phase

Product code : 11625473

Catalog # : 04018ET3ER324TC-W22

TORQUE AND CURRENT VS SPEED CURVE

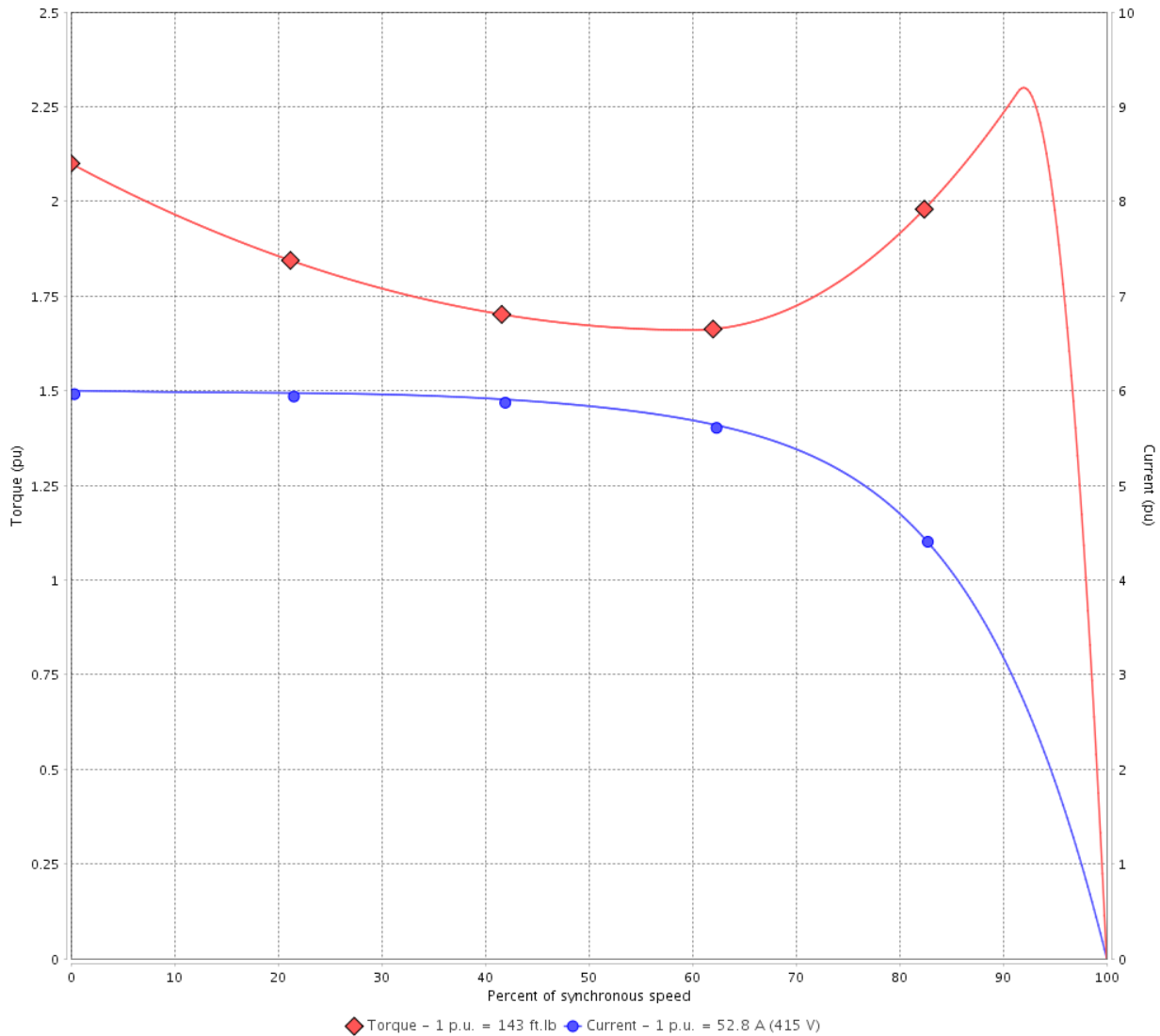

Performance : 415 V 50 Hz 4P IE2

Rated current	: 52.8 A	Moment of inertia (J)	: 9.16 sq.ft.lb
LRC	: 6.0	Duty cycle	: Cont.(S1)
Rated torque	: 143 ft.lb	Insulation class	: F
Locked rotor torque	: 210 %	Service factor	: 1.00
Breakdown torque	: 229 %	Temperature rise	: 80 K
Rated speed	: 1470 rpm	Design	: B

Locked rotor time : 27s (cold) 15s (hot)

Rev.	Changes Summary	Performed	Checked	Date
Performed by			Page	Revision
Checked by				
Date	12/04/2022			
			8 / 36	



# LOAD PERFORMANCE CURVE

## Three Phase Induction Motor - Squirrel Cage



Customer :

Product line : NEMA Premium Efficiency Three-Phase

Product code : 11625473

Catalog # : 04018ET3ER324TC-W22

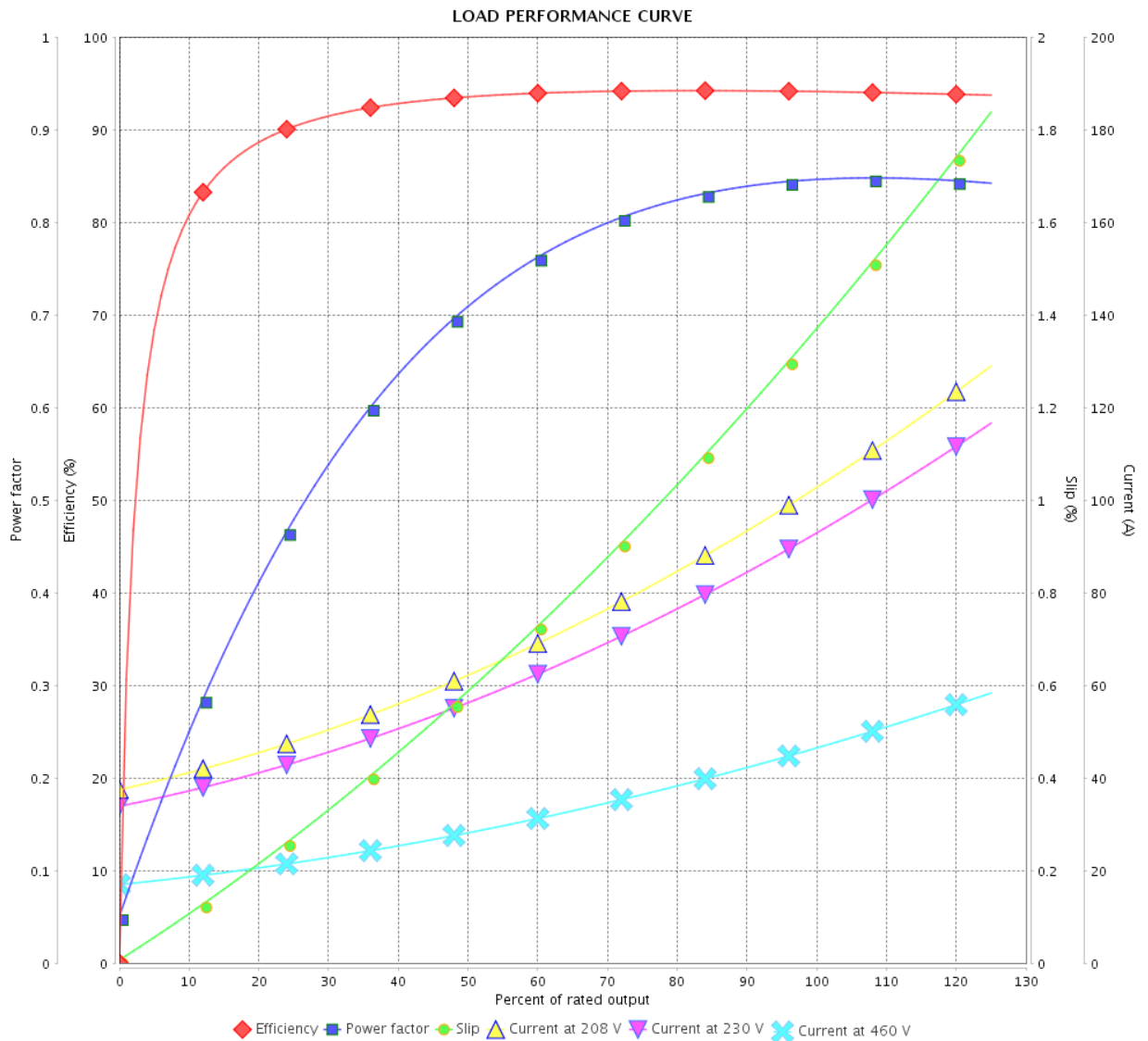

Performance : 230/460 V 60 Hz 4P

Rated current : 94.2/47.1 A  
 LRC : 6.1  
 Rated torque : 118 ft.lb  
 Locked rotor torque : 229 %  
 Breakdown torque : 240 %  
 Rated speed : 1770 rpm

Moment of inertia (J) : 9.16 sq.ft.lb  
 Duty cycle : Cont.(S1)  
 Insulation class : F  
 Service factor : 1.25  
 Temperature rise : 80 K  
 Design : B

Rev.	Changes Summary	Performed	Checked	Date
Performed by			Page	Revision
Checked by				
Date				

# LOAD PERFORMANCE CURVE

Three Phase Induction Motor - Squirrel Cage



Customer :

Product line : NEMA Premium Efficiency Three-Phase

Product code : 11625473

Catalog # : 04018ET3ER324TC-W22

LOAD PERFORMANCE CURVE

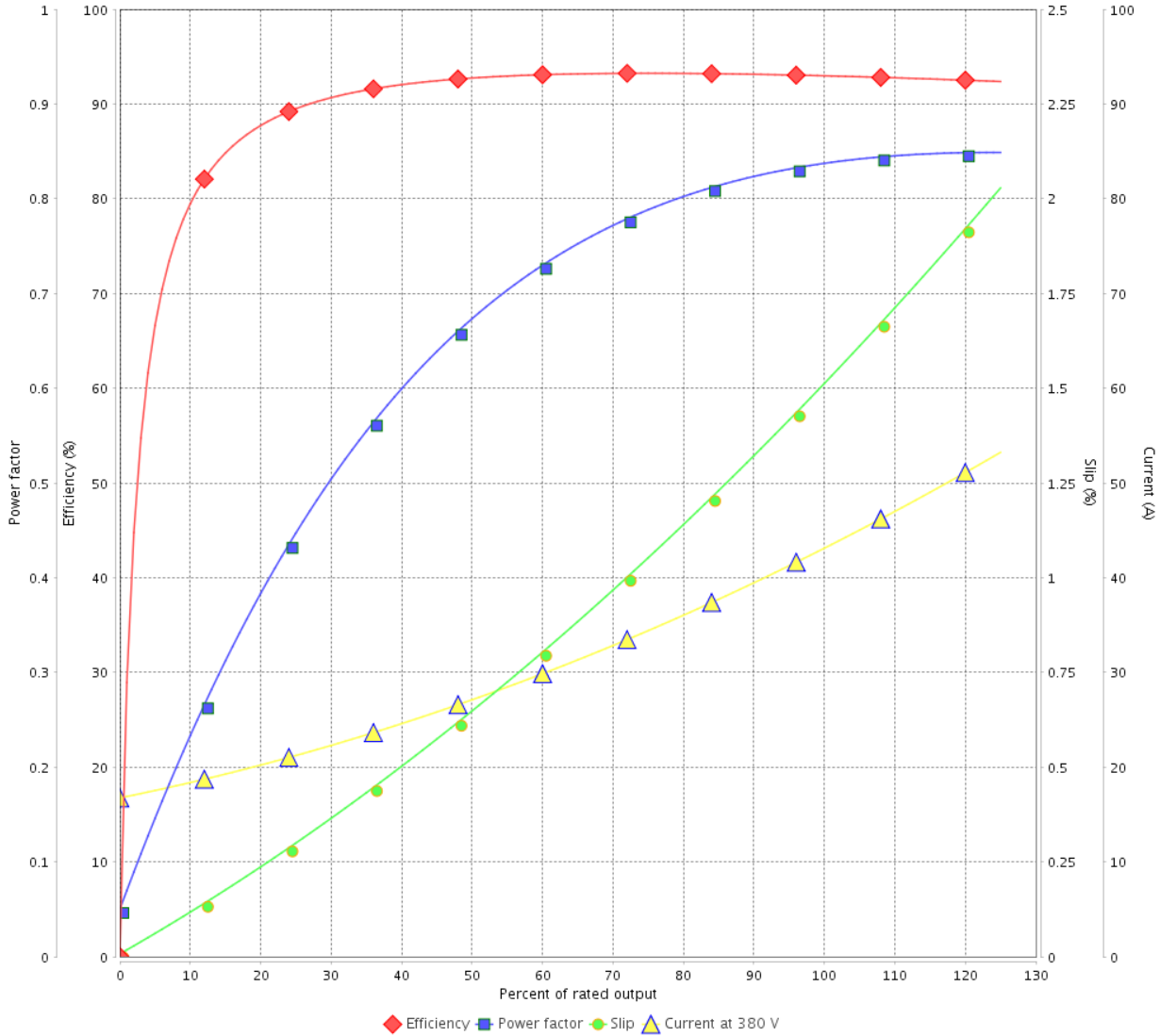

Performance : 380 V 50 Hz 4P IE3

Rated current : 42.8 A  
 LRC : 6.6  
 Rated torque : 107 ft.lb  
 Locked rotor torque : 240 %  
 Breakdown torque : 260 %  
 Rated speed : 1475 rpm

Moment of inertia (J) : 9.16 sq.ft.lb  
 Duty cycle : Cont.(S1)  
 Insulation class : F  
 Service factor : 1.00  
 Temperature rise : 80 K  
 Design : B

Rev.	Changes Summary	Performed	Checked	Date
Performed by		Page		Revision
Checked by		10 / 36		
Date	12/04/2022			

# LOAD PERFORMANCE CURVE

## Three Phase Induction Motor - Squirrel Cage



Customer :

Product line : NEMA Premium Efficiency Three-Phase

Product code : 11625473

Catalog # : 04018ET3ER324TC-W22

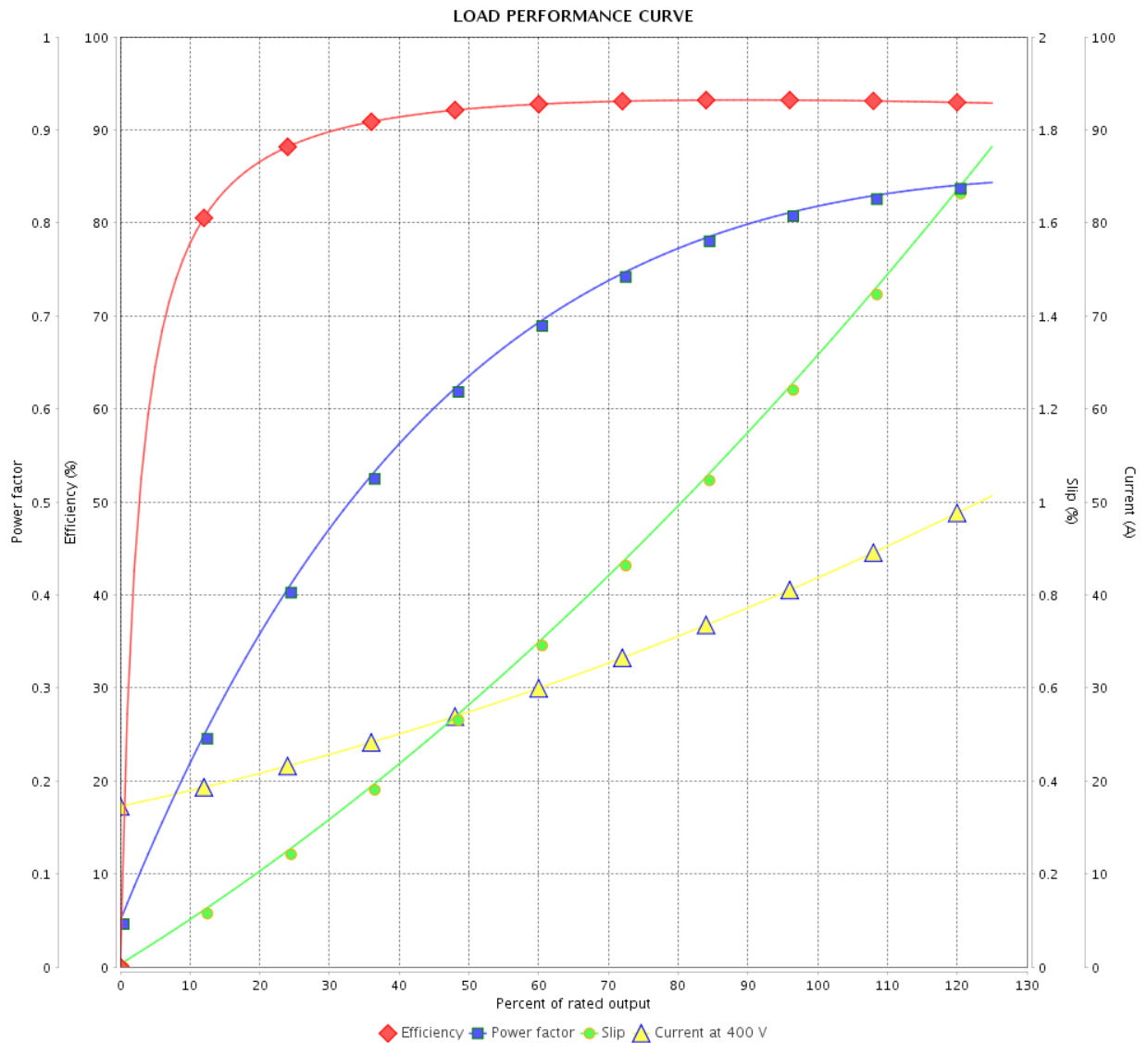

Performance : 400 V 50 Hz 4P IE3

Rated current : 41.6 A  
 LRC : 7.3  
 Rated torque : 106 ft.lb  
 Locked rotor torque : 270 %  
 Breakdown torque : 290 %  
 Rated speed : 1480 rpm

Moment of inertia (J) : 9.16 sq.ft.lb  
 Duty cycle : Cont.(S1)  
 Insulation class : F  
 Service factor : 1.00  
 Temperature rise : 80 K  
 Design : B

Rev.	Changes Summary	Performed	Checked	Date
Performed by			Page	Revision
Checked by				
Date				

# LOAD PERFORMANCE CURVE

Three Phase Induction Motor - Squirrel Cage



Customer :

Product line : NEMA Premium Efficiency Three-Phase

Product code : 11625473

Catalog # : 04018ET3ER324TC-W22

LOAD PERFORMANCE CURVE

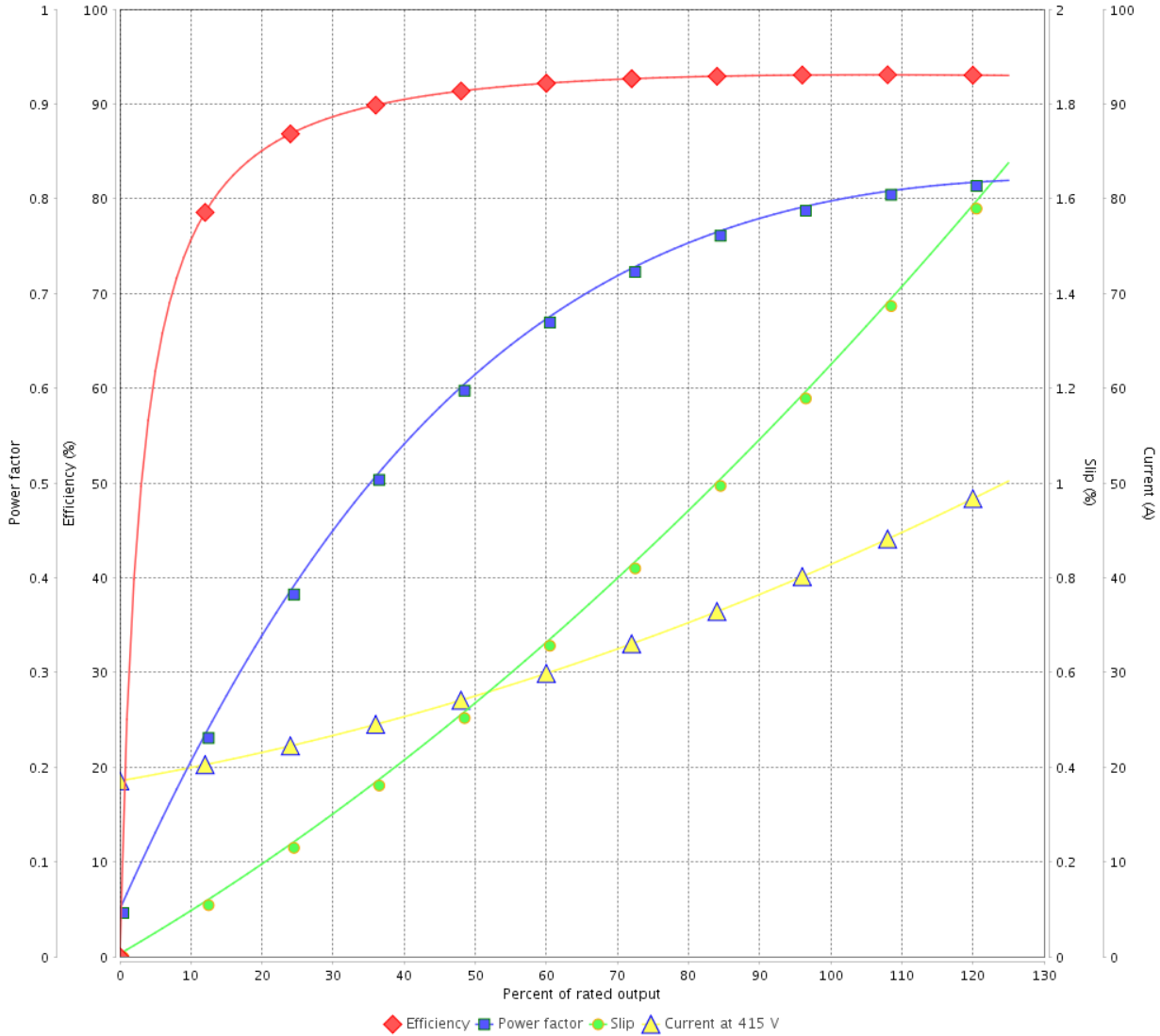

Performance : 415 V 50 Hz 4P IE3

Rated current : 41.1 A  
 LRC : 7.7  
 Rated torque : 106 ft.lb  
 Locked rotor torque : 280 %  
 Breakdown torque : 310 %  
 Rated speed : 1480 rpm

Moment of inertia (J) : 9.16 sq.ft.lb  
 Duty cycle : Cont.(S1)  
 Insulation class : F  
 Service factor : 1.00  
 Temperature rise : 80 K  
 Design : B

Rev.	Changes Summary	Performed	Checked	Date
Performed by			Page 12 / 36	Revision
Checked by				
Date	12/04/2022			

# LOAD PERFORMANCE CURVE

## Three Phase Induction Motor - Squirrel Cage



Customer : \_\_\_\_\_

Product line : NEMA Premium Efficiency Three-Phase

Product code : 11625473

Catalog # : 04018ET3ER324TC-W22

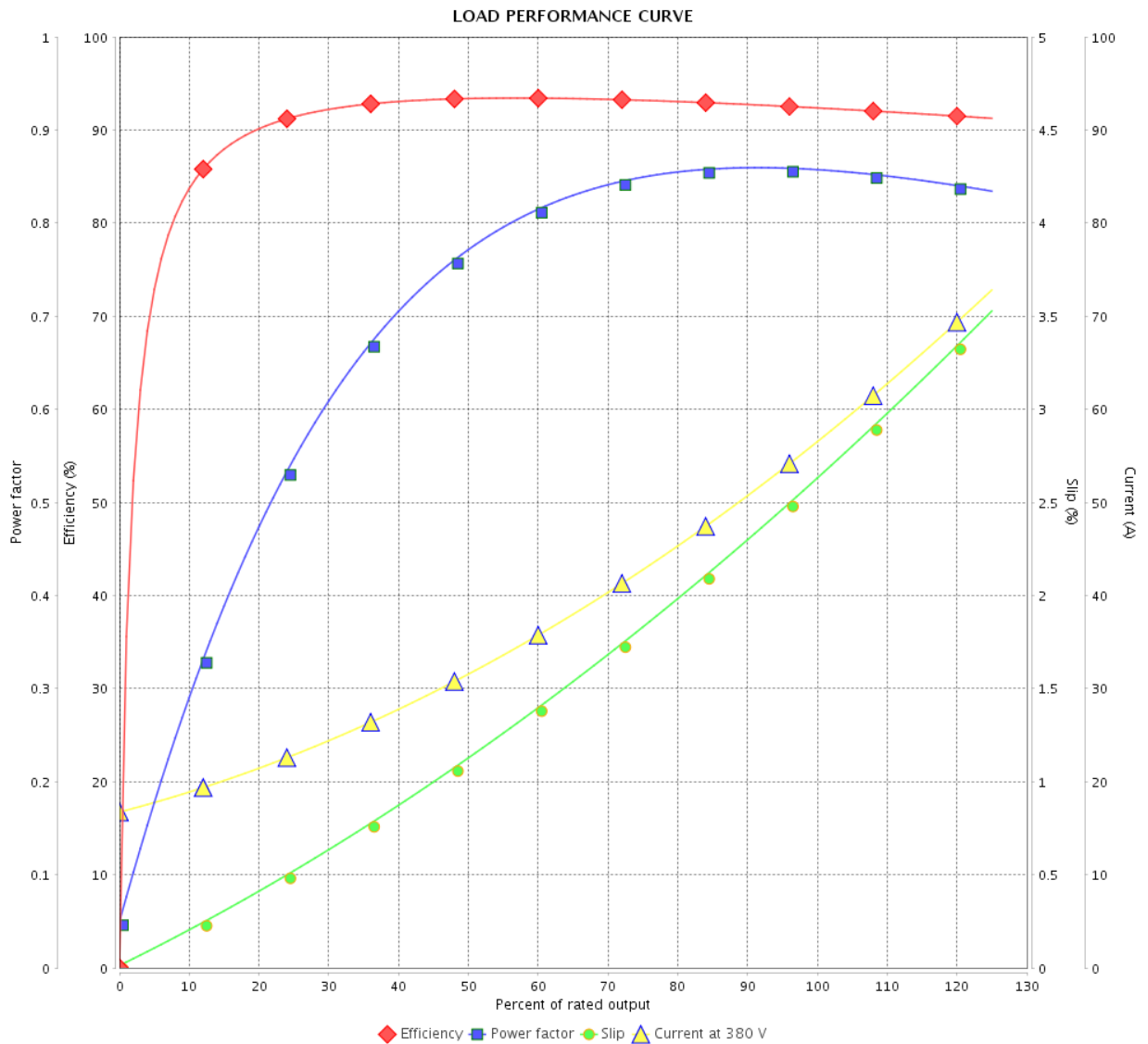

Performance : 380 V 50 Hz 4P IE2

Rated current : 57.4 A  
 LRC : 5.0  
 Rated torque : 144 ft.lb  
 Locked rotor torque : 170 %  
 Breakdown torque : 180 %  
 Rated speed : 1460 rpm

Moment of inertia (J) : 9.16 sq.ft.lb  
 Duty cycle : Cont.(S1)  
 Insulation class : F  
 Service factor : 1.00  
 Temperature rise : 105 K  
 Design : B

Rev.	Changes Summary	Performed	Checked	Date
Performed by			Page	Revision
Checked by				
Date				

# LOAD PERFORMANCE CURVE

Three Phase Induction Motor - Squirrel Cage



Customer : \_\_\_\_\_

Product line : NEMA Premium Efficiency Three-Phase

Product code : 11625473

Catalog # : 04018ET3ER324TC-W22

LOAD PERFORMANCE CURVE

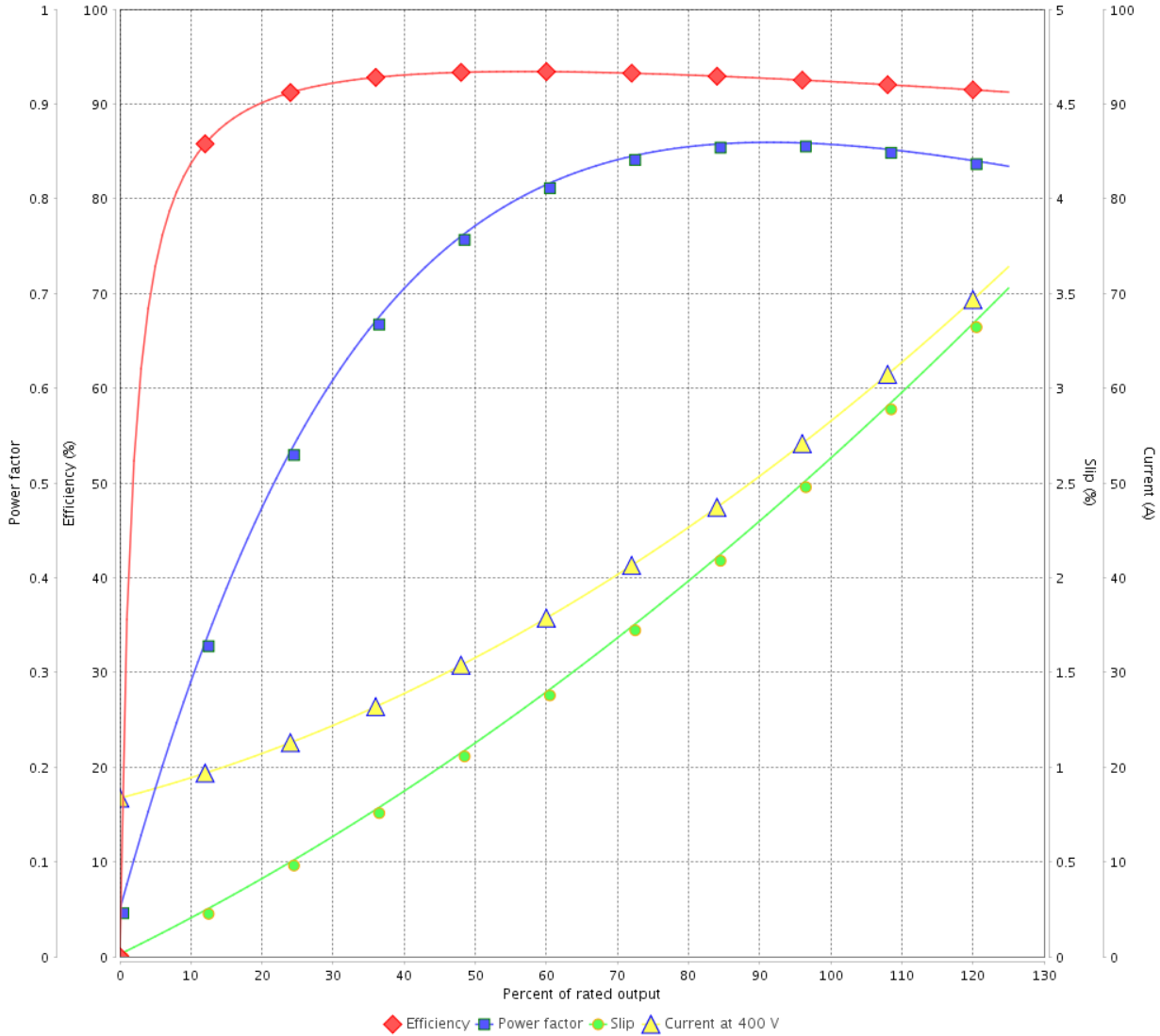

Performance : 400 V 50 Hz 4P IE2

Rated current : 57.4 A  
 LRC : 5.0  
 Rated torque : 144 ft.lb  
 Locked rotor torque : 170 %  
 Breakdown torque : 180 %  
 Rated speed : 1460 rpm

Moment of inertia (J) : 9.16 sq.ft.lb  
 Duty cycle : Cont.(S1)  
 Insulation class : F  
 Service factor : 1.00  
 Temperature rise : 105 K  
 Design : B

Rev.	Changes Summary	Performed	Checked	Date
Performed by		Page		Revision
Checked by		14 / 36		
Date	12/04/2022			

# LOAD PERFORMANCE CURVE

## Three Phase Induction Motor - Squirrel Cage



Customer : \_\_\_\_\_

Product line : NEMA Premium Efficiency Three-Phase

Product code : 11625473

Catalog # : 04018ET3ER324TC-W22

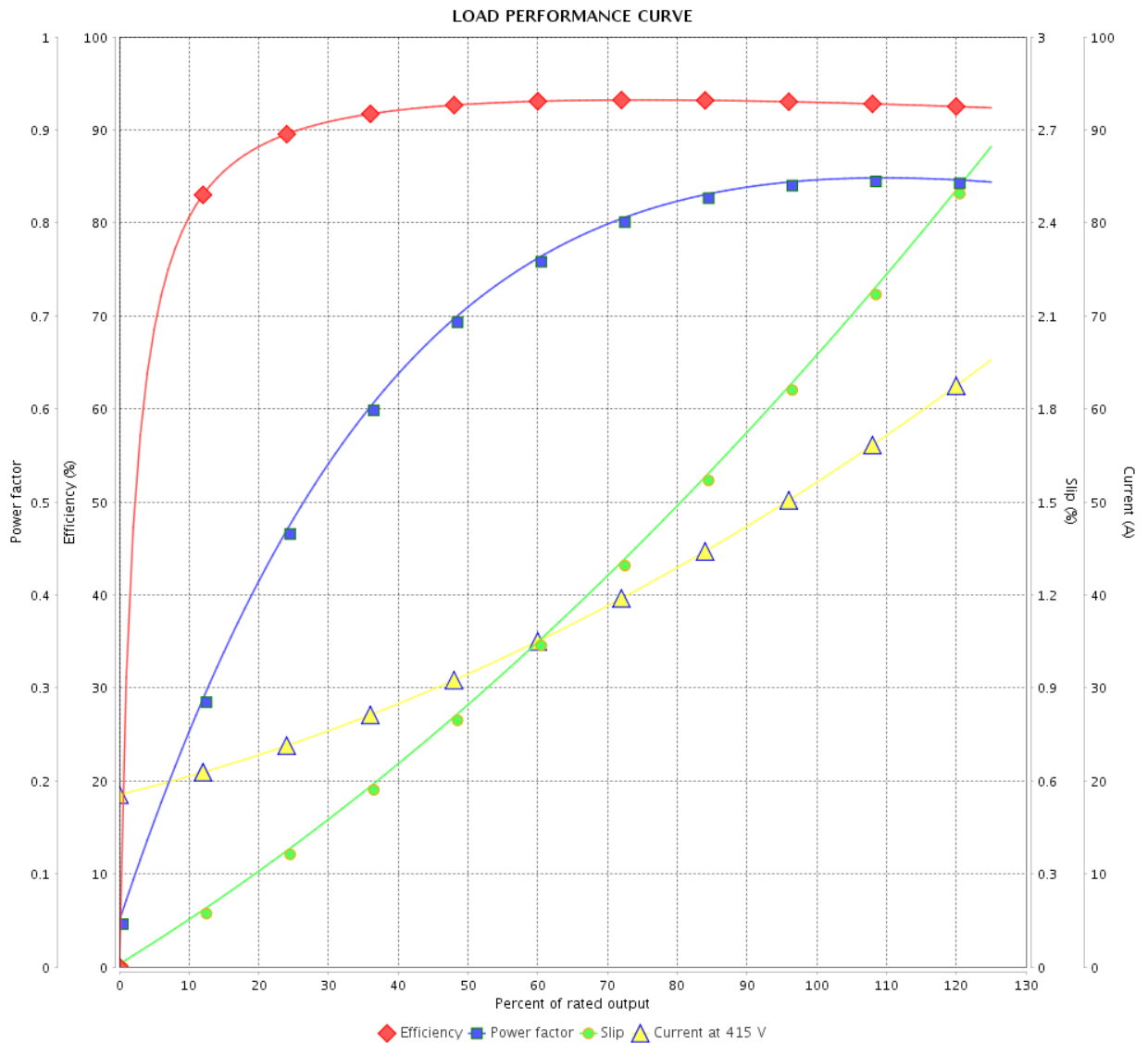

Performance : 415 V 50 Hz 4P IE2

Rated current : 52.8 A  
 LRC : 6.0  
 Rated torque : 143 ft.lb  
 Locked rotor torque : 210 %  
 Breakdown torque : 229 %  
 Rated speed : 1470 rpm

Moment of inertia (J) : 9.16 sq.ft.lb  
 Duty cycle : Cont.(S1)  
 Insulation class : F  
 Service factor : 1.00  
 Temperature rise : 80 K  
 Design : B

Rev.	Changes Summary	Performed	Checked	Date
Performed by			Page	Revision
Checked by				
Date				
			15 / 36	

# THERMAL LIMIT CURVE



## Three Phase Induction Motor - Squirrel Cage

Customer :

Product line : NEMA Premium Efficiency Three-Phase  
Product code : 11625473  
Catalog # : 04018ET3ER324TC-W22

Performance : 230/460 V 60 Hz 4P

Rated current	: 94.2/47.1 A	Moment of inertia (J)	: 9.16 sq.ft.lb
LRC	: 6.1	Duty cycle	: Cont.(S1)
Rated torque	: 118 ft.lb	Insulation class	: F
Locked rotor torque	: 229 %	Service factor	: 1.25
Breakdown torque	: 240 %	Temperature rise	: 80 K
Rated speed	: 1770 rpm	Design	: B

Heating constant

Cooling constant

Rev.	Changes Summary	Performed	Checked	Date
Performed by				
Checked by			Page	Revision
Date	12/04/2022		16 / 36	



# THERMAL LIMIT CURVE

Three Phase Induction Motor - Squirrel Cage



Customer : \_\_\_\_\_

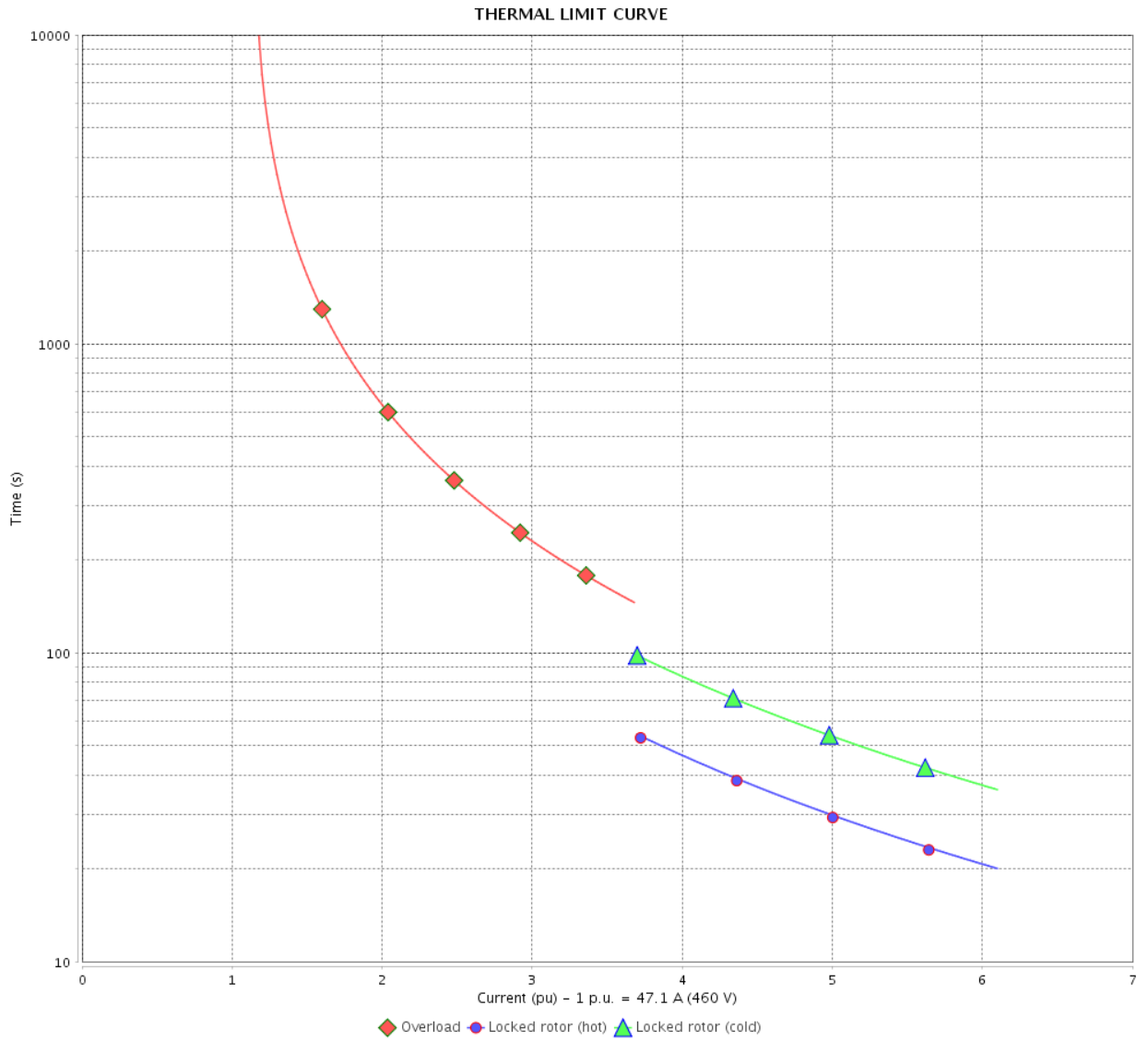

Rev.	Changes Summary	Performed	Checked	Date
Performed by		Page 17 / 36		Revision
Checked by				
Date				

# THERMAL LIMIT CURVE

## Three Phase Induction Motor - Squirrel Cage



Customer :

Product line : NEMA Premium Efficiency Three-Phase  
Product code : 11625473  
Catalog # : 04018ET3ER324TC-W22

Performance : 380 V 50 Hz 4P IE3

Rated current	: 42.8 A	Moment of inertia (J)	: 9.16 sq.ft.lb
LRC	: 6.6	Duty cycle	: Cont.(S1)
Rated torque	: 107 ft.lb	Insulation class	: F
Locked rotor torque	: 240 %	Service factor	: 1.00
Breakdown torque	: 260 %	Temperature rise	: 80 K
Rated speed	: 1475 rpm	Design	: B

Heating constant

Cooling constant

Rev.	Changes Summary	Performed	Checked	Date
Performed by				
Checked by			Page	Revision
Date	12/04/2022		18 / 36	

# THERMAL LIMIT CURVE

Three Phase Induction Motor - Squirrel Cage



Customer : \_\_\_\_\_

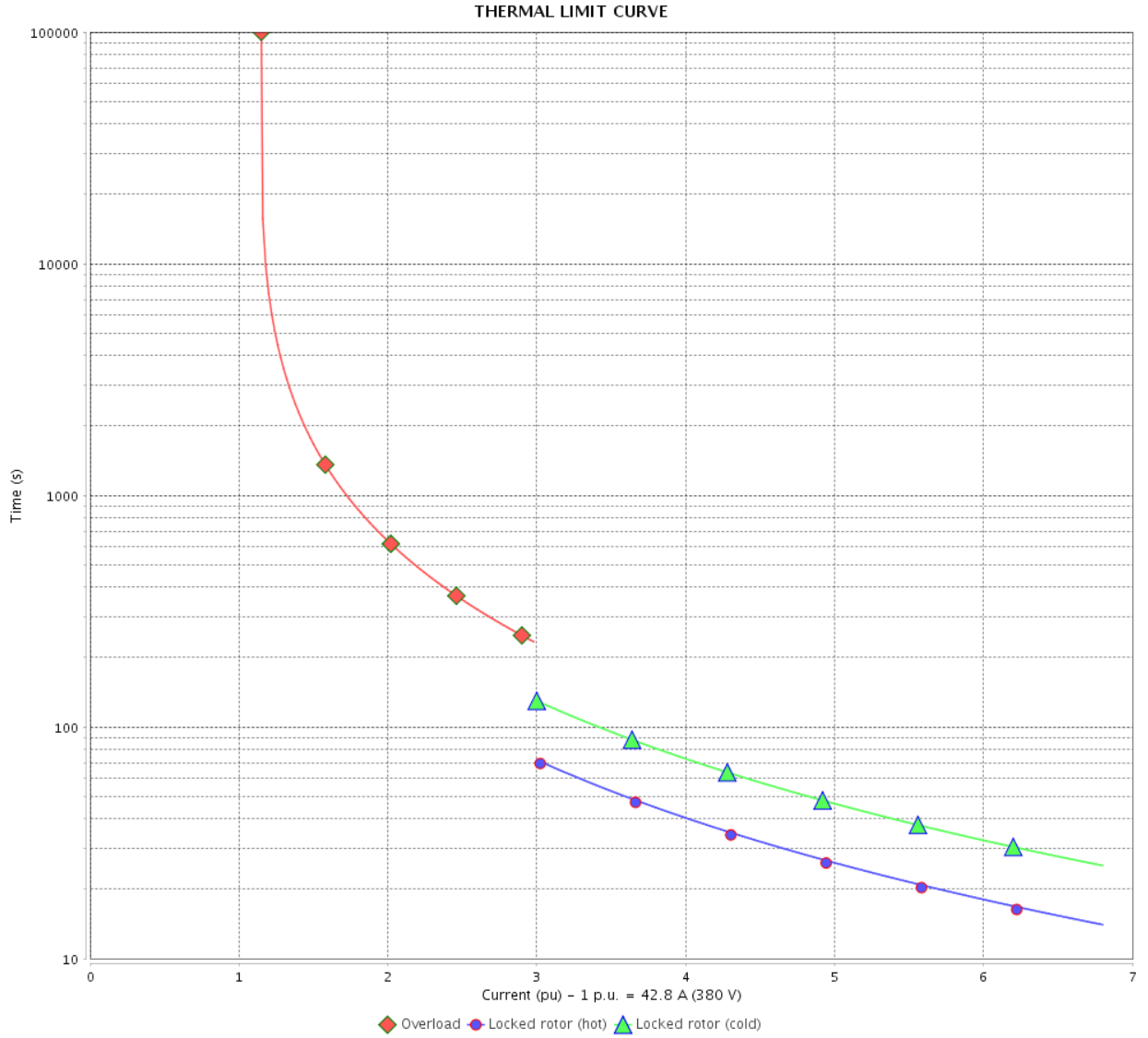

Rev.	Changes Summary	Performed	Checked	Date
Performed by		Page 19 / 36		Revision
Checked by				
Date				

# THERMAL LIMIT CURVE



## Three Phase Induction Motor - Squirrel Cage

Customer :

Product line : NEMA Premium Efficiency Three-Phase  
Product code : 11625473  
Catalog # : 04018ET3ER324TC-W22

Performance : 400 V 50 Hz 4P IE3

Rated current	: 41.6 A	Moment of inertia (J)	: 9.16 sq.ft.lb
LRC	: 7.3	Duty cycle	: Cont.(S1)
Rated torque	: 106 ft.lb	Insulation class	: F
Locked rotor torque	: 270 %	Service factor	: 1.00
Breakdown torque	: 290 %	Temperature rise	: 80 K
Rated speed	: 1480 rpm	Design	: B

Heating constant

Cooling constant

Rev.	Changes Summary	Performed	Checked	Date
Performed by				
Checked by			Page	Revision
Date	12/04/2022		20 / 36	

# THERMAL LIMIT CURVE

Three Phase Induction Motor - Squirrel Cage



Customer : \_\_\_\_\_

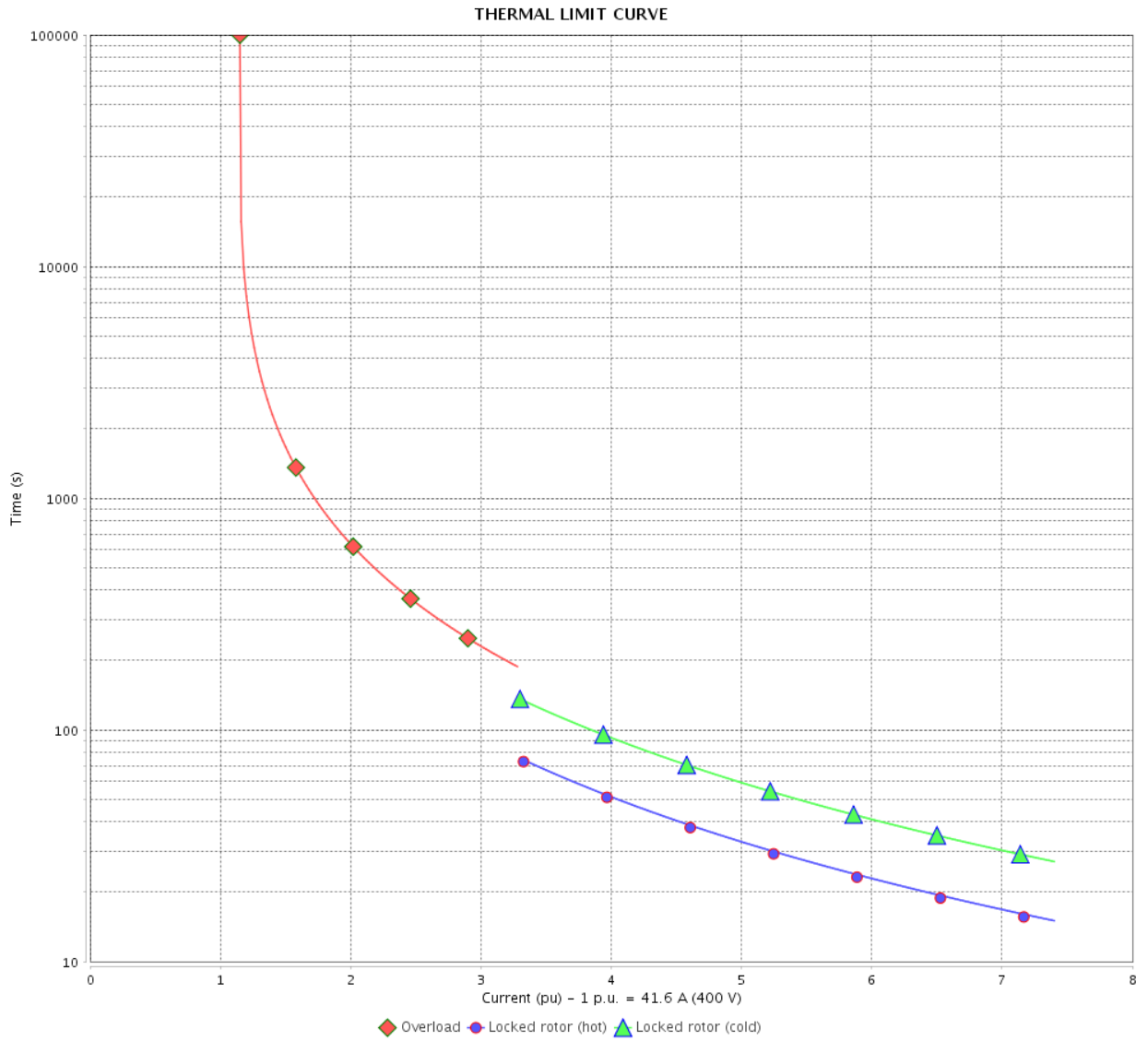

Rev.	Changes Summary	Performed	Checked	Date
Performed by		Page		Revision
Checked by		21 / 36		
Date		12/04/2022		

# THERMAL LIMIT CURVE

## Three Phase Induction Motor - Squirrel Cage



Customer :

Product line : NEMA Premium Efficiency Three-Phase  
Product code : 11625473  
Catalog # : 04018ET3ER324TC-W22

Performance : 415 V 50 Hz 4P IE3

Rated current	: 41.1 A	Moment of inertia (J)	: 9.16 sq.ft.lb
LRC	: 7.7	Duty cycle	: Cont.(S1)
Rated torque	: 106 ft.lb	Insulation class	: F
Locked rotor torque	: 280 %	Service factor	: 1.00
Breakdown torque	: 310 %	Temperature rise	: 80 K
Rated speed	: 1480 rpm	Design	: B

Heating constant

Cooling constant

Rev.	Changes Summary	Performed	Checked	Date
Performed by				
Checked by			Page	Revision
Date	12/04/2022		22 / 36	

# THERMAL LIMIT CURVE

Three Phase Induction Motor - Squirrel Cage



Customer : \_\_\_\_\_

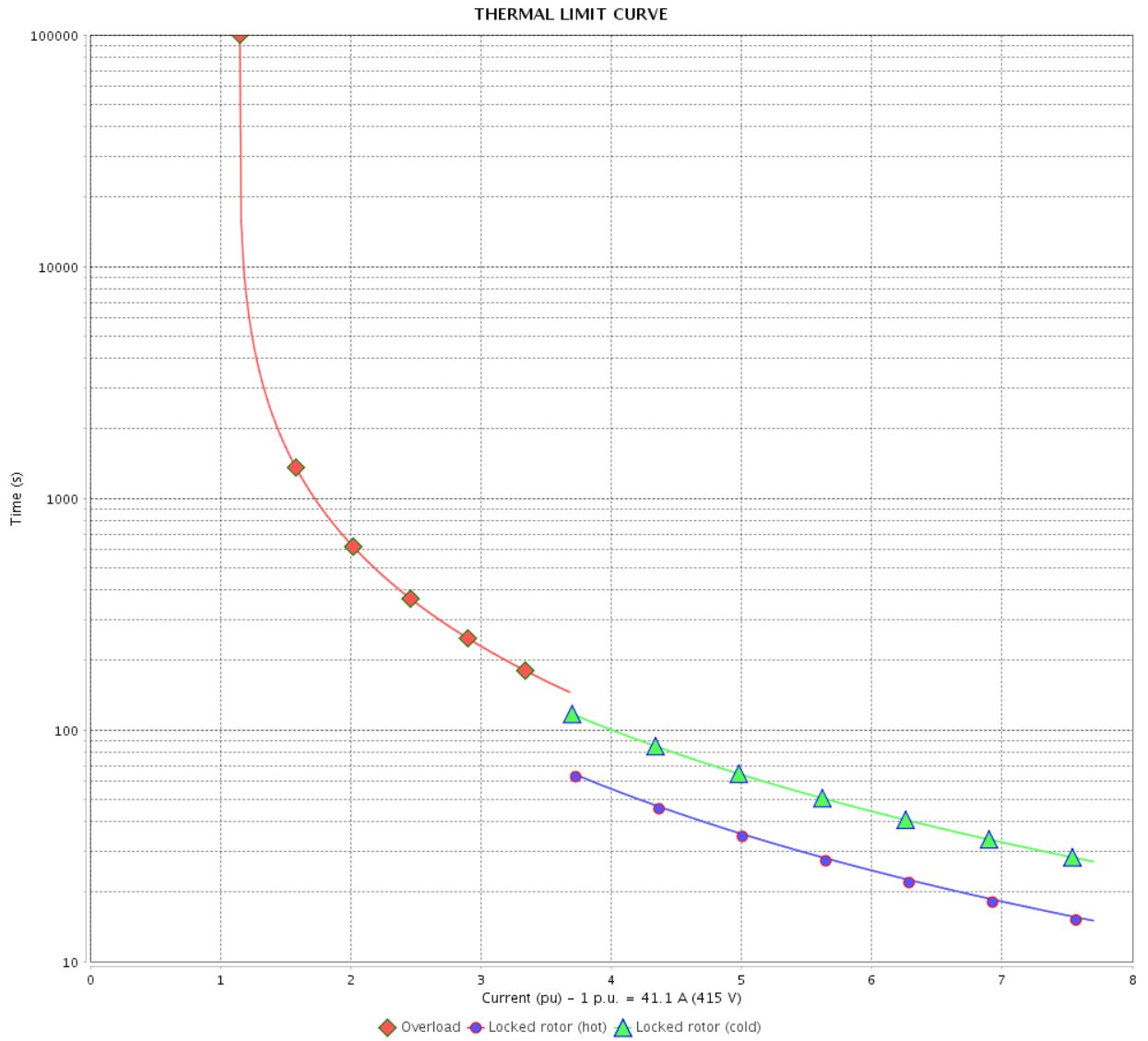

Rev.	Changes Summary	Performed	Checked	Date
Performed by		Page 23 / 36		Revision
Checked by				
Date				

# THERMAL LIMIT CURVE



## Three Phase Induction Motor - Squirrel Cage

Customer :

Product line : NEMA Premium Efficiency Three-Phase  
Product code : 11625473  
Catalog # : 04018ET3ER324TC-W22

Performance : 380 V 50 Hz 4P IE2

Rated current	: 57.4 A	Moment of inertia (J)	: 9.16 sq.ft.lb
LRC	: 5.0	Duty cycle	: Cont.(S1)
Rated torque	: 144 ft.lb	Insulation class	: F
Locked rotor torque	: 170 %	Service factor	: 1.00
Breakdown torque	: 180 %	Temperature rise	: 105 K
Rated speed	: 1460 rpm	Design	: B

Heating constant

Cooling constant

Rev.	Changes Summary	Performed	Checked	Date
Performed by				
Checked by			Page	Revision
Date	12/04/2022		24 / 36	



# THERMAL LIMIT CURVE

Three Phase Induction Motor - Squirrel Cage



Customer : \_\_\_\_\_

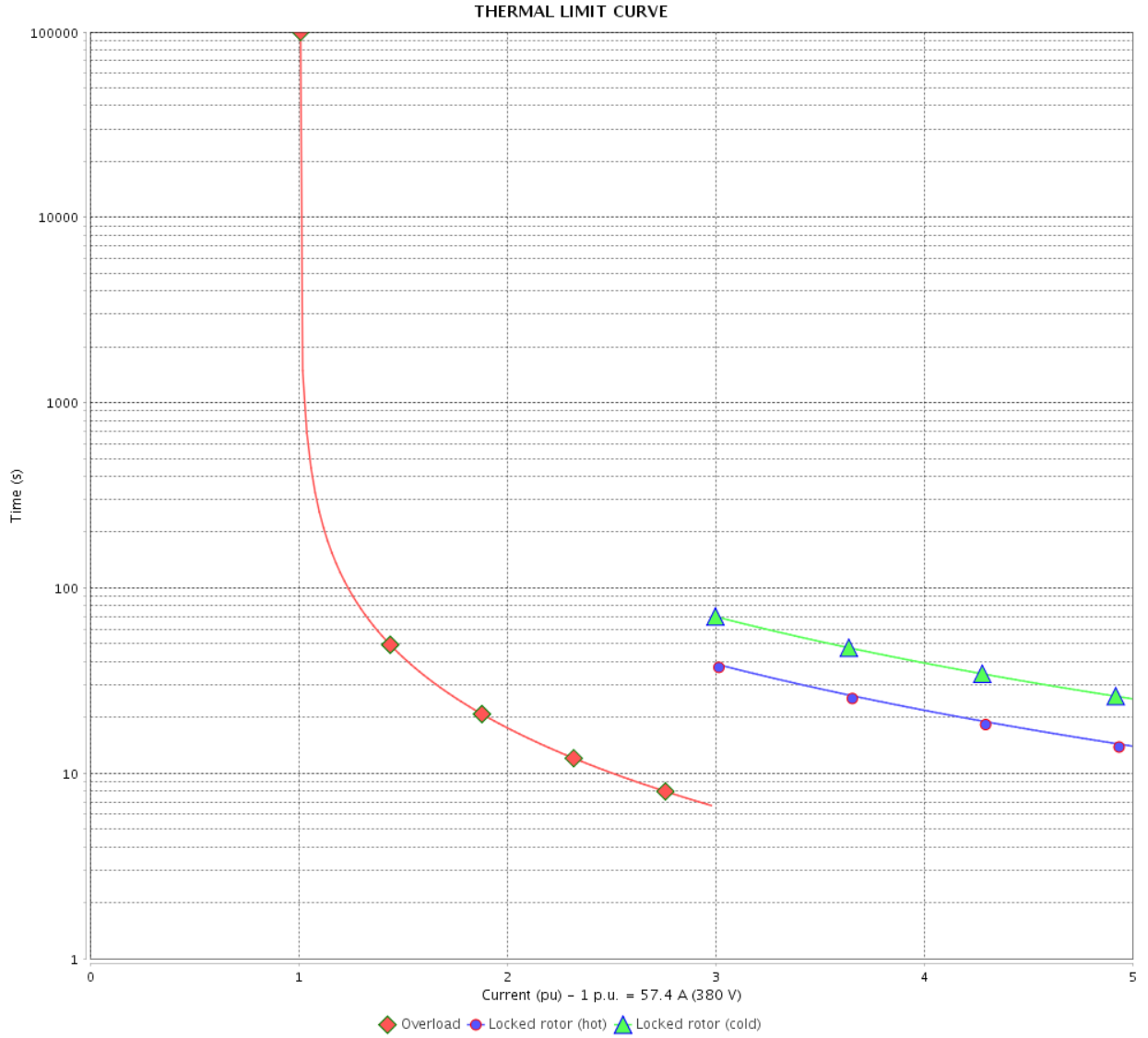

Rev.	Changes Summary	Performed	Checked	Date
Performed by				
Checked by				
Date				
			Page	Revision
			25 / 36	

# THERMAL LIMIT CURVE

## Three Phase Induction Motor - Squirrel Cage



Customer :

Product line : NEMA Premium Efficiency Three-Phase  
Product code : 11625473  
Catalog # : 04018ET3ER324TC-W22

Performance : 400 V 50 Hz 4P IE2

Rated current	: 57.4 A	Moment of inertia (J)	: 9.16 sq.ft.lb
LRC	: 5.0	Duty cycle	: Cont.(S1)
Rated torque	: 144 ft.lb	Insulation class	: F
Locked rotor torque	: 170 %	Service factor	: 1.00
Breakdown torque	: 180 %	Temperature rise	: 105 K
Rated speed	: 1460 rpm	Design	: B

Heating constant

Cooling constant

Rev.	Changes Summary	Performed	Checked	Date
Performed by				
Checked by			Page	Revision
Date	12/04/2022		26 / 36	

# THERMAL LIMIT CURVE

Three Phase Induction Motor - Squirrel Cage



Customer : \_\_\_\_\_

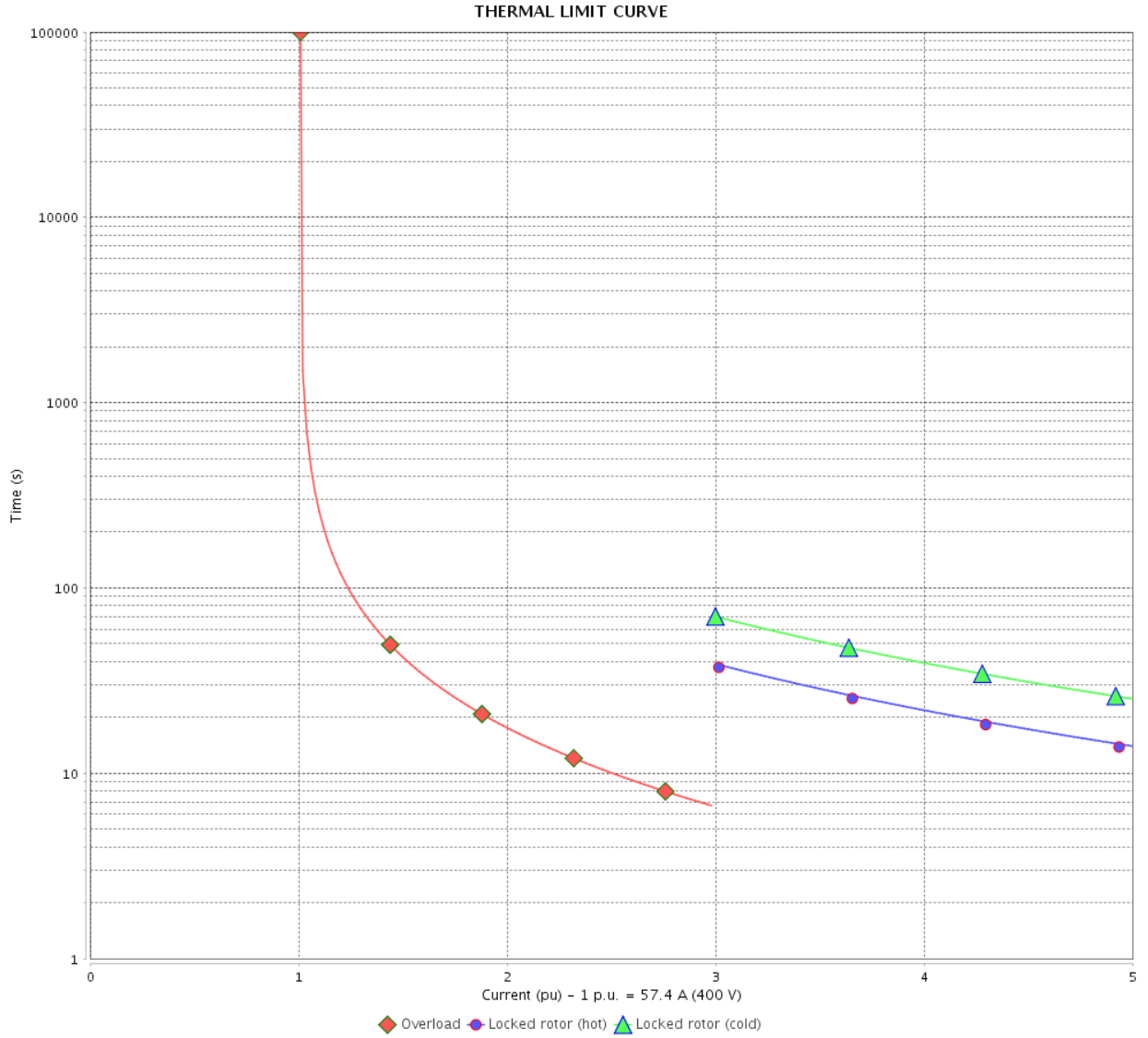

Rev.	Changes Summary	Performed	Checked	Date
Performed by		Page 27 / 36		Revision
Checked by				
Date				

# THERMAL LIMIT CURVE

## Three Phase Induction Motor - Squirrel Cage



Customer :

Product line : NEMA Premium Efficiency Three-Phase  
Product code : 11625473  
Catalog # : 04018ET3ER324TC-W22

Performance : 415 V 50 Hz 4P IE2

Rated current	: 52.8 A	Moment of inertia (J)	: 9.16 sq.ft.lb
LRC	: 6.0	Duty cycle	: Cont.(S1)
Rated torque	: 143 ft.lb	Insulation class	: F
Locked rotor torque	: 210 %	Service factor	: 1.00
Breakdown torque	: 229 %	Temperature rise	: 80 K
Rated speed	: 1470 rpm	Design	: B

Heating constant

Cooling constant

Rev.	Changes Summary	Performed	Checked	Date
Performed by				
Checked by			Page	Revision
Date	12/04/2022		28 / 36	

# THERMAL LIMIT CURVE

Three Phase Induction Motor - Squirrel Cage



Customer : \_\_\_\_\_

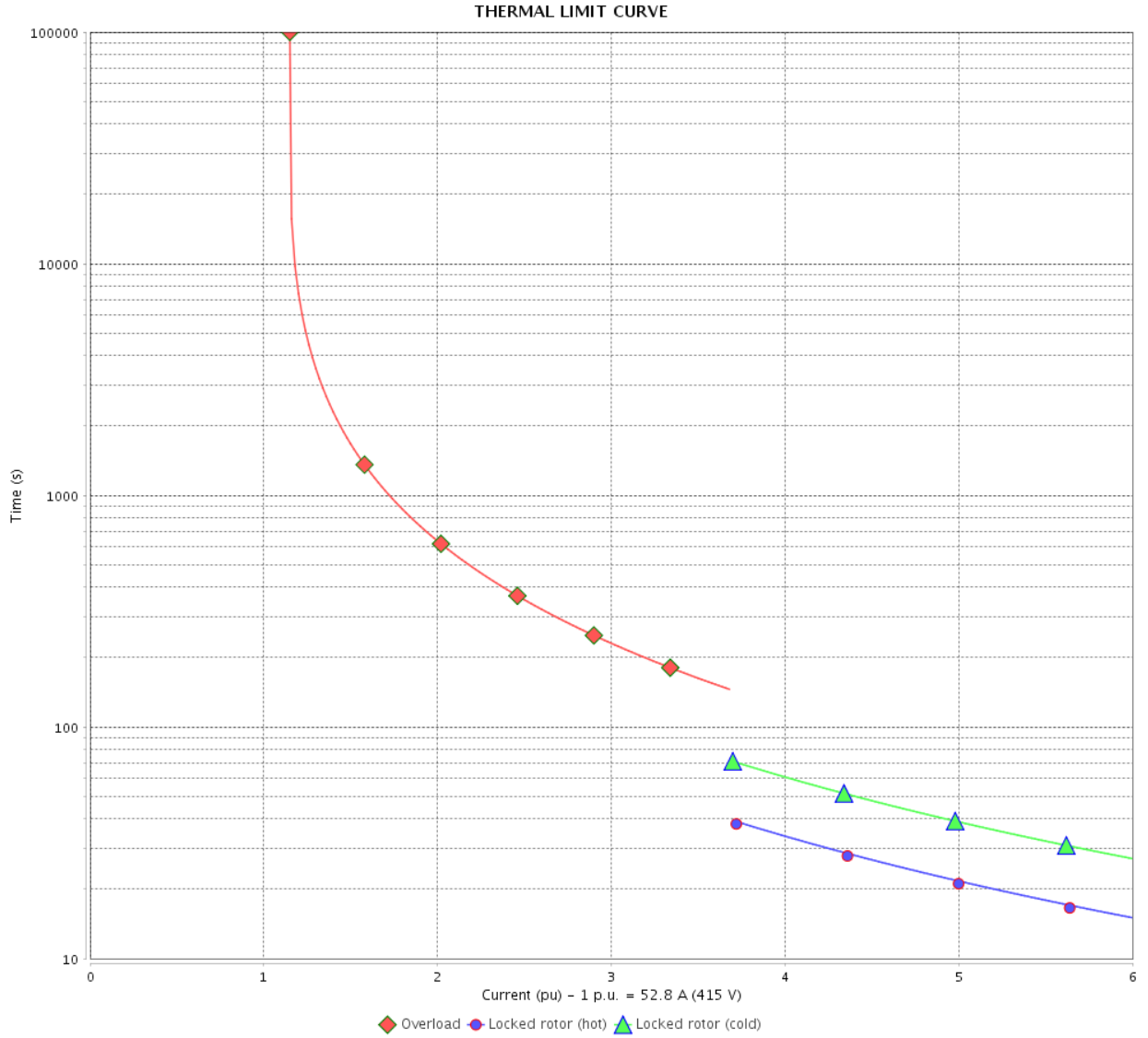

Rev.	Changes Summary	Performed	Checked	Date
Performed by				
Checked by				
Date				
			Page	Revision
			29 / 36	

# VFD OPERATION CURVE

Three Phase Induction Motor - Squirrel Cage



Customer :

Product line : NEMA Premium Efficiency Three-Phase

Product code : 11625473

Catalog # : 04018ET3ER324TC-W22

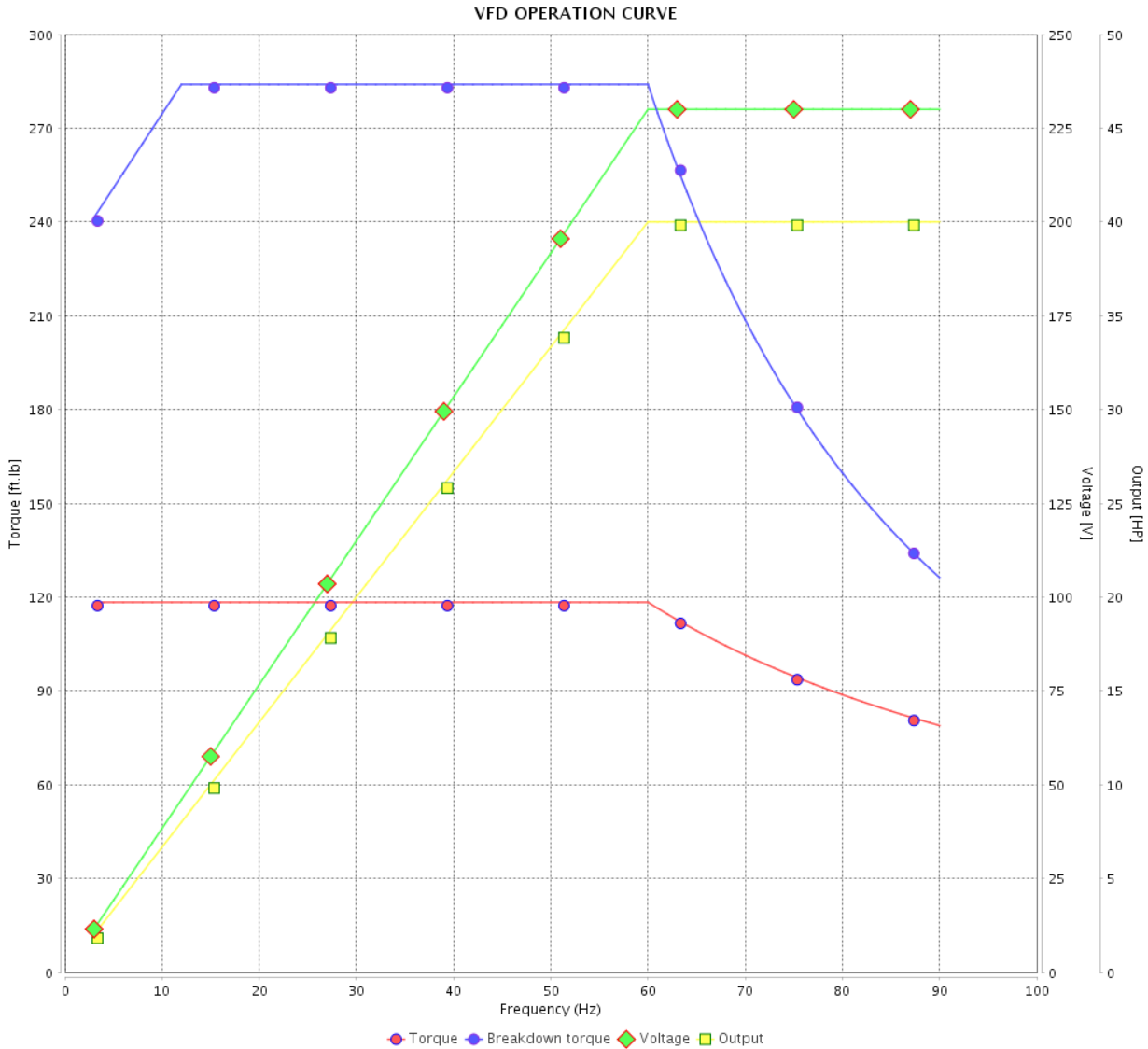

Performance : 230/460 V 60 Hz 4P

Rated current : 94.2/47.1 A  
 LRC : 6.1  
 Rated torque : 118 ft.lb  
 Locked rotor torque : 229 %  
 Breakdown torque : 240 %  
 Rated speed : 1770 rpm

Moment of inertia (J) : 9.16 sq.ft.lb  
 Duty cycle : Cont.(S1)  
 Insulation class : F  
 Service factor : 1.25  
 Temperature rise : 80 K  
 Design : B

Rev.	Changes Summary	Performed	Checked	Date
Performed by			Page	Revision
Checked by				
Date				

# VFD OPERATION CURVE

Three Phase Induction Motor - Squirrel Cage



Customer : \_\_\_\_\_

Product line : NEMA Premium Efficiency Three-Phase

Product code : 11625473

Catalog # : 04018ET3ER324TC-W22

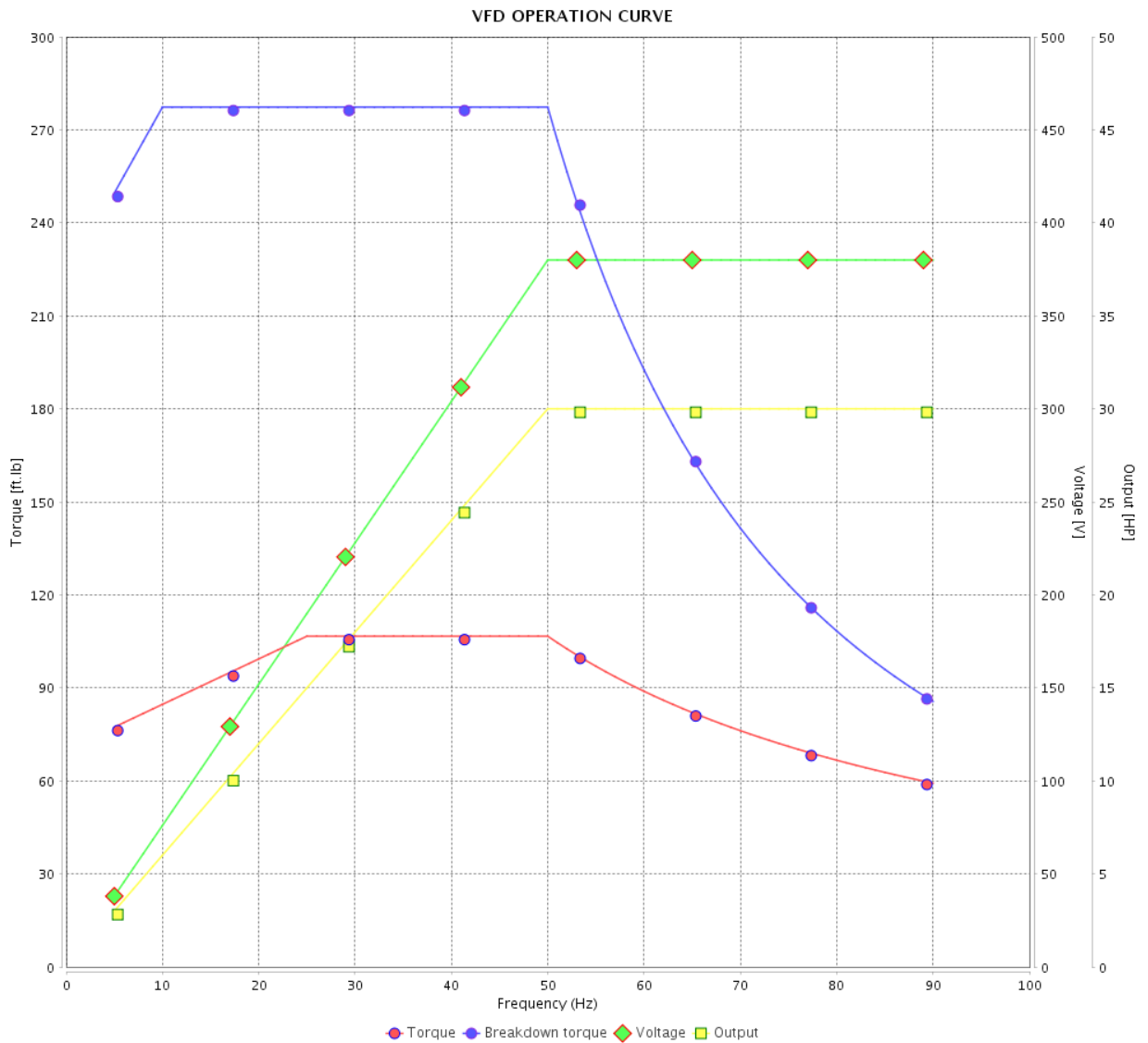

Performance : 380 V 50 Hz 4P IE3

Rated current : 42.8 A  
 LRC : 6.6  
 Rated torque : 107 ft.lb  
 Locked rotor torque : 240 %  
 Breakdown torque : 260 %  
 Rated speed : 1475 rpm

Moment of inertia (J) : 9.16 sq.ft.lb  
 Duty cycle : Cont.(S1)  
 Insulation class : F  
 Service factor : 1.00  
 Temperature rise : 80 K  
 Design : B

Rev.	Changes Summary	Performed	Checked	Date
Performed by			Page 31 / 36	Revision
Checked by				
Date	12/04/2022			

# VFD OPERATION CURVE

Three Phase Induction Motor - Squirrel Cage



Customer :

Product line : NEMA Premium Efficiency Three-Phase

Product code : 11625473

Catalog # : 04018ET3ER324TC-W22

VFD OPERATION CURVE

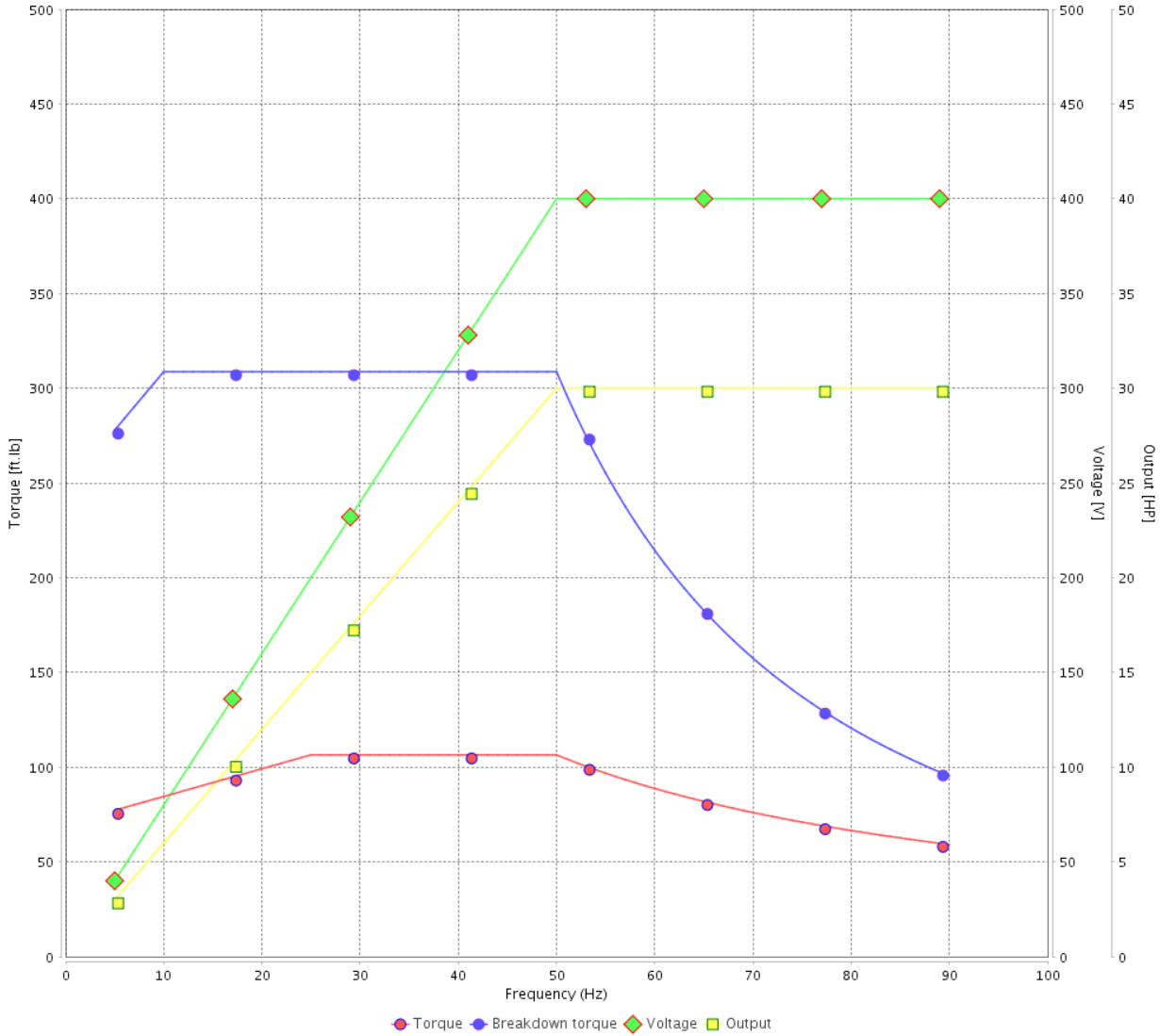

Performance : 400 V 50 Hz 4P IE3

Rated current	: 41.6 A	Moment of inertia (J)	: 9.16 sq.ft.lb
LRC	: 7.3	Duty cycle	: Cont.(S1)
Rated torque	: 106 ft.lb	Insulation class	: F
Locked rotor torque	: 270 %	Service factor	: 1.00
Breakdown torque	: 290 %	Temperature rise	: 80 K
Rated speed	: 1480 rpm	Design	: B

Rev.	Changes Summary	Performed	Checked	Date
Performed by			Page	Revision
Checked by			32 / 36	
Date	12/04/2022			



# VFD OPERATION CURVE

## Three Phase Induction Motor - Squirrel Cage



Customer :

Product line : NEMA Premium Efficiency Three-Phase

Product code : 11625473

Catalog # : 04018ET3ER324TC-W22

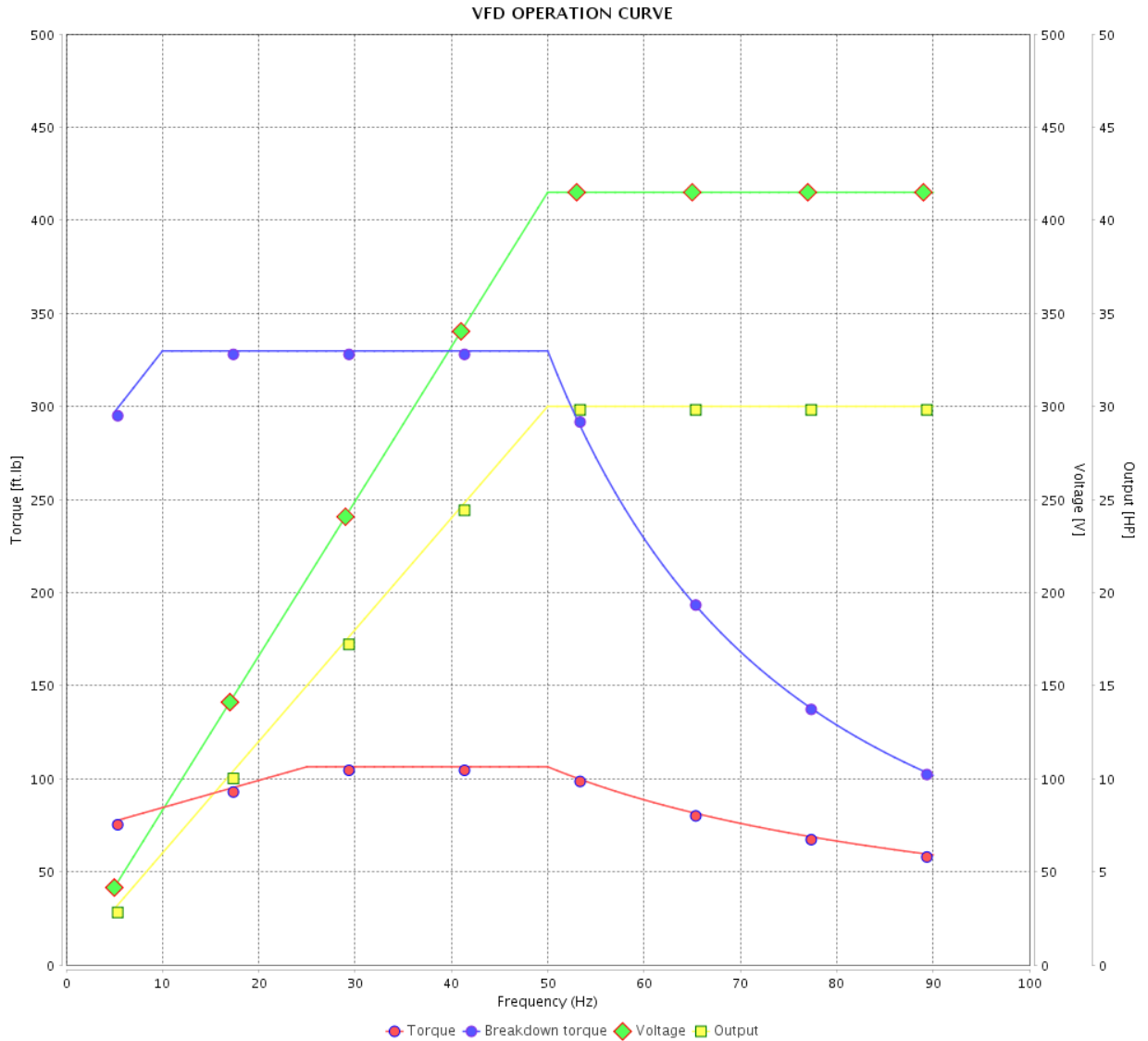

Performance : 415 V 50 Hz 4P IE3

Rated current : 41.1 A  
 LRC : 7.7  
 Rated torque : 106 ft.lb  
 Locked rotor torque : 280 %  
 Breakdown torque : 310 %  
 Rated speed : 1480 rpm

Moment of inertia (J) : 9.16 sq.ft.lb  
 Duty cycle : Cont.(S1)  
 Insulation class : F  
 Service factor : 1.00  
 Temperature rise : 80 K  
 Design : B

Rev.	Changes Summary	Performed	Checked	Date
Performed by		Page		Revision
Checked by		33 / 36		
Date	12/04/2022			

# VFD OPERATION CURVE

Three Phase Induction Motor - Squirrel Cage



Customer :

Product line : NEMA Premium Efficiency Three-Phase

Product code : 11625473

Catalog # : 04018ET3ER324TC-W22

VFD OPERATION CURVE

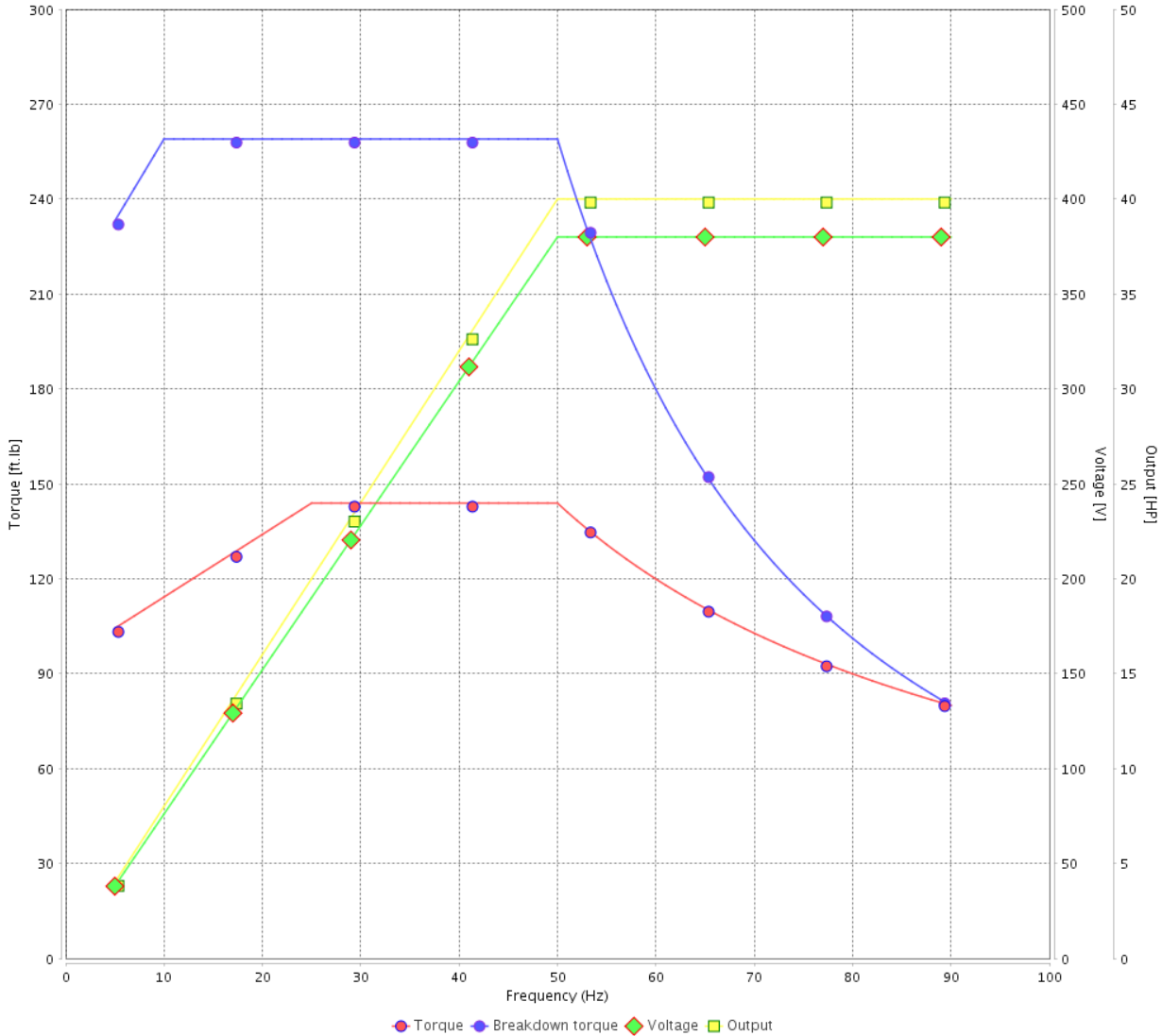

Performance : 380 V 50 Hz 4P IE2

Rated current	: 57.4 A	Moment of inertia (J)	: 9.16 sq.ft.lb
LRC	: 5.0	Duty cycle	: Cont.(S1)
Rated torque	: 144 ft.lb	Insulation class	: F
Locked rotor torque	: 170 %	Service factor	: 1.00
Breakdown torque	: 180 %	Temperature rise	: 105 K
Rated speed	: 1460 rpm	Design	: B

Rev.	Changes Summary	Performed	Checked	Date
Performed by			Page 34 / 36	Revision
Checked by				
Date	12/04/2022			

# VFD OPERATION CURVE

## Three Phase Induction Motor - Squirrel Cage



Customer :

Product line : NEMA Premium Efficiency Three-Phase

Product code : 11625473

Catalog # : 04018ET3ER324TC-W22

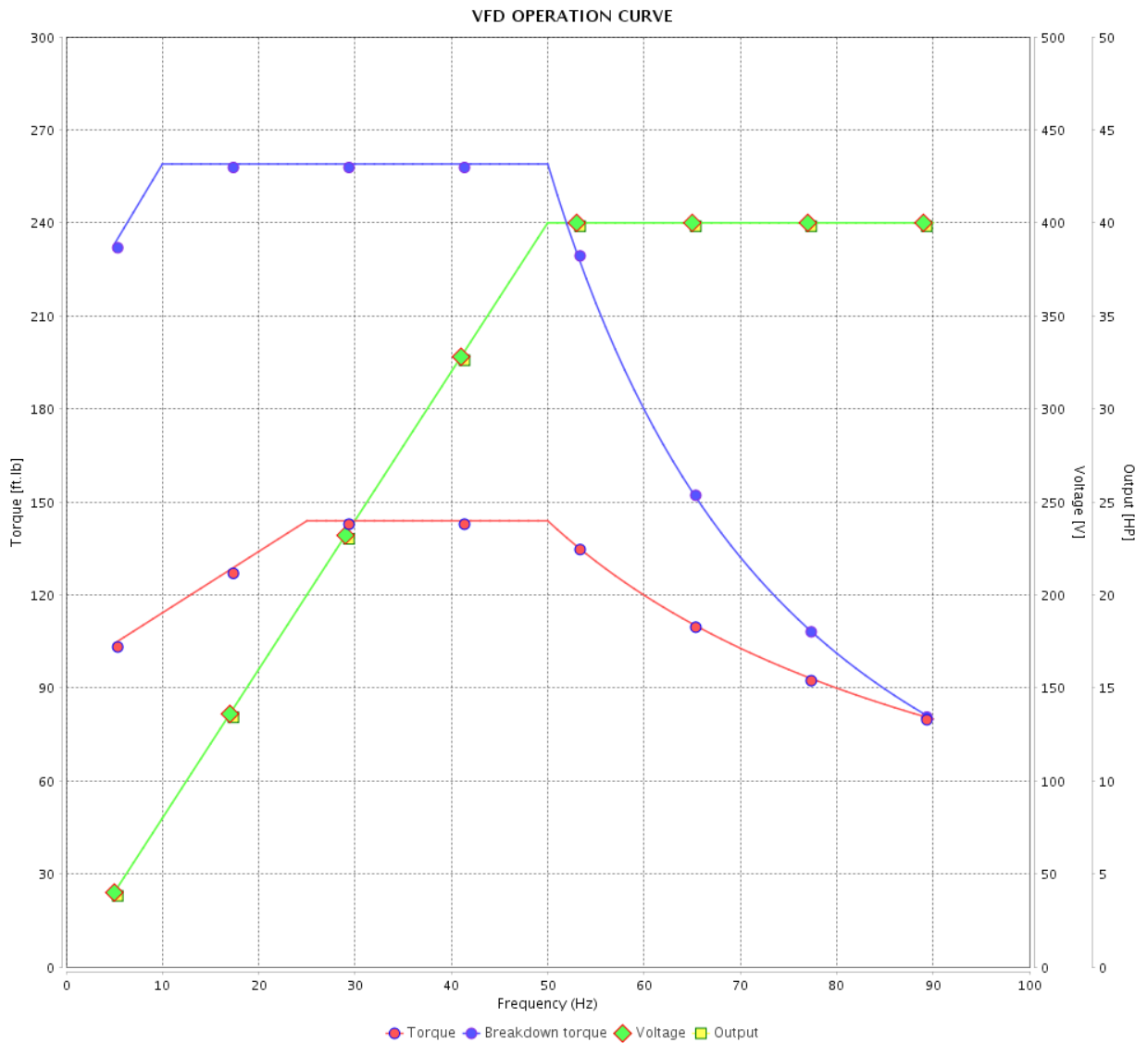

Performance : 400 V 50 Hz 4P IE2

Rated current : 57.4 A  
 LRC : 5.0  
 Rated torque : 144 ft.lb  
 Locked rotor torque : 170 %  
 Breakdown torque : 180 %  
 Rated speed : 1460 rpm

Moment of inertia (J) : 9.16 sq.ft.lb  
 Duty cycle : Cont.(S1)  
 Insulation class : F  
 Service factor : 1.00  
 Temperature rise : 105 K  
 Design : B

Rev.	Changes Summary	Performed	Checked	Date
Performed by		Page		Revision
Checked by		35 / 36		
Date		12/04/2022		

# VFD OPERATION CURVE

Three Phase Induction Motor - Squirrel Cage



Customer :

Product line : NEMA Premium Efficiency Three-Phase

Product code : 11625473

Catalog # : 04018ET3ER324TC-W22

VFD OPERATION CURVE

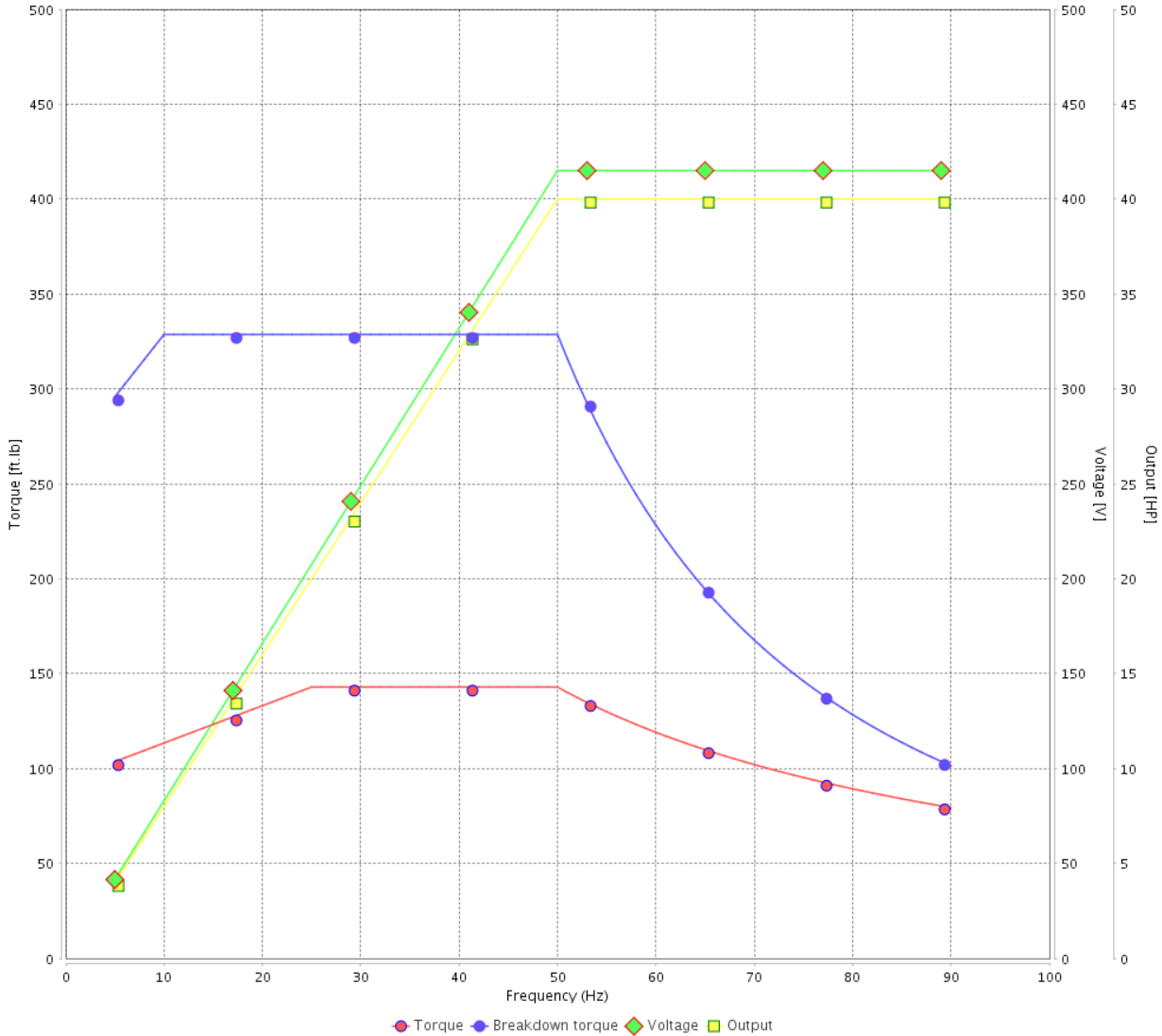

Performance : 415 V 50 Hz 4P IE2

Rated current	: 52.8 A	Moment of inertia (J)	: 9.16 sq.ft.lb
LRC	: 6.0	Duty cycle	: Cont.(S1)
Rated torque	: 143 ft.lb	Insulation class	: F
Locked rotor torque	: 210 %	Service factor	: 1.00
Breakdown torque	: 229 %	Temperature rise	: 80 K
Rated speed	: 1470 rpm	Design	: B

Rev.	Changes Summary	Performed	Checked	Date
Performed by			Page 36 / 36	Revision
Checked by				
Date	12/04/2022			

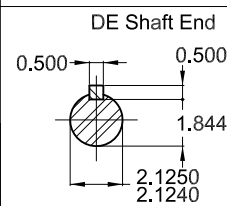
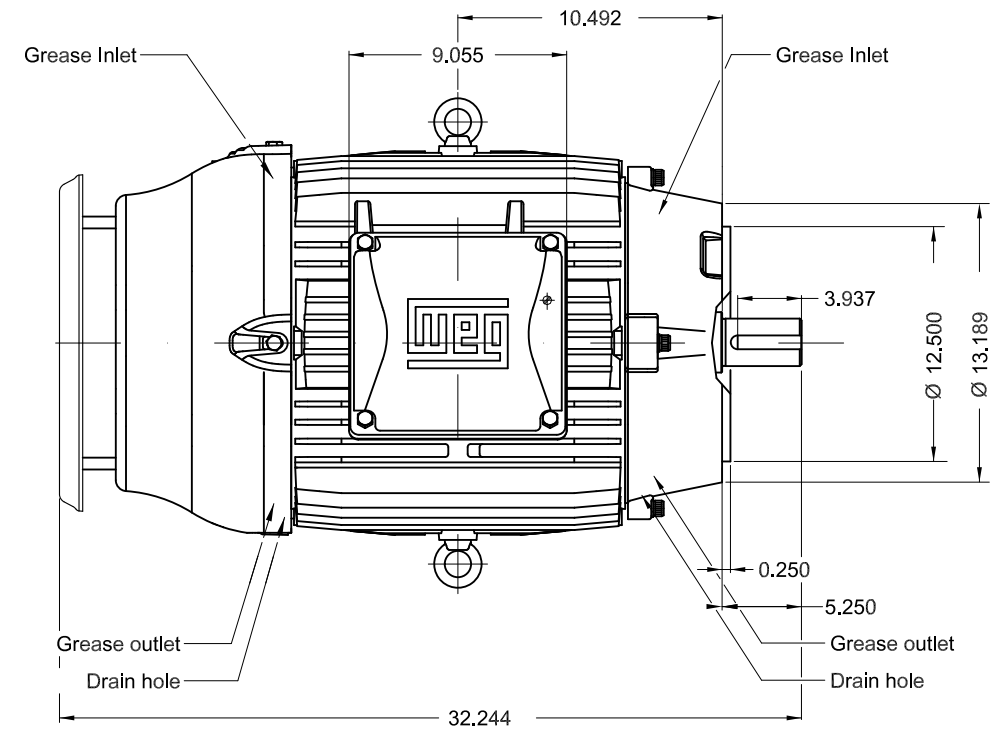
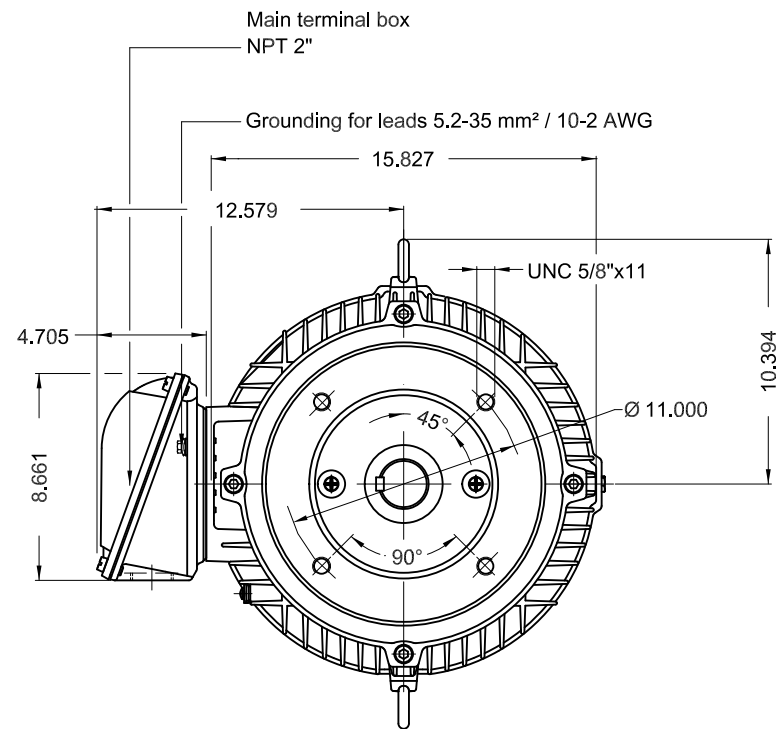

Color RAL 5009  
 Painting plan 203A  
 Mounting V18

40 HP 04 Poles 60 Hz

Dimensions in inches

ECM	LOC	SUMMARY OF MODIFICATIONS	EXECUTED	CHECKED	RELEASED	DATE	VER
EXECUTED	PIRWBUSER	THREE PH. MOTOR W22 PREM. EFF.					
CHECKED		FRAME 324TC IP55 TEFC					
RELEASED							
REL DT.	WMO	Jaragua do Sul	Product Engineering				

**PREVIEW**  
 WDD



SHEET 1 / 1



FOR SAFE AREA  
Mod.TE1BFOXON  
CC029A



For use on 60Hz  
Class I, Div 2, Gr A, B, C and D - T3  
Class I, Zone 2, IIC - T3  
Class II, Div 2, Gr F and G - T4  
For use on PWM: Gr. A, B, C, D and F,  
VT 1000:1, CT 20:1, 1.00SF - T3A

MODEL 04018ET3ER324TC-W22

Inverter Duty Motor  
Severe Duty

PH3 60Hz Fr. 324TC 1000m.a.s.l. IP55 TEFC 567lb

V 230/460

A 94.2/47.1

HP 40

kW 30

SF 1.25

SFA 118/58.9

RPM 1775

PF 0.85

AMB 40°C

INS cl. F DT80K NEMA NOM EFF 94.1%

DUTY CONT.

DES B Code G

USABLE @208V 104A SF 1.15 SFA 120

40HP 30kW 50Hz 380V 57.4A 1460RPM SF 1.00 EFF 92.4% (IE2)

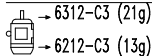
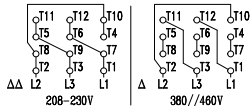

MOBIL POLYREX EM (14000h)

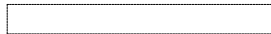

MADE IN BRAZIL  
11625473