

DATA SHEET

Three Phase Induction Motor - Squirrel Cage



Customer :					
Product line	: W40 JP Pump NEMA Premium Efficiency Three-Phase	Product code :	14486992		
		Catalog # :	04018OT3E324JP-W40		
Frame	: 324JP	Cooling method	: IC01 - ODP		
Insulation class	: F	Mounting	: F-1		
Duty cycle	: Cont.(S1)	Rotation ¹	: Both (CW and CCW)		
Ambient temperature	: -20°C to +40°C	Starting method	: Direct On Line		
Altitude	: 1000 m.a.s.l.	Approx. weight ²	: 463 lb		
Protection degree	: IP23	Moment of inertia (J)	: 5.69 sq.ft.lb		
Design	: B				
Output [HP]	40	30	30	30	30
Poles	4	4	4	4	4
Frequency [Hz]	60	50	50	50	50
Rated voltage [V]	230/460	380	400	415	415
Rated current [A]	95.2/47.6	43.3	42.2	41.7	41.7
L. R. Amperes [A]	590/295	290	283	313	313
LRC [A]	6.2x(Code G)	6.7x(Code H)	6.7x(Code H)	7.5x(Code J)	7.5x(Code J)
No load current [A]	37.0/18.5	18.3	20.3	22.1	22.1
Rated speed [RPM]	1775	1475	1480	1480	1480
Slip [%]	1.39	1.67	1.33	1.33	1.33
Rated torque [ft.lb]	118	107	106	106	106
Locked rotor torque [%]	200	229	260	280	280
Breakdown torque [%]	240	270	300	330	330
Service factor	1.25	1.00	1.00	1.00	1.00
Temperature rise	80 K	80 K	80 K	80 K	80 K
Locked rotor time	23s (cold) 13s (hot)	30s (cold) 17s (hot)	30s (cold) 17s (hot)	25s (cold) 14s (hot)	25s (cold) 14s (hot)
Noise level ²	66.0 dB(A)				
Efficiency (%)	25%	93.5	92.4	92.5	92.4
	50%	93.6	92.6	92.6	92.5
	75%	94.1	93.0	93.0	93.0
	100%	94.1	93.0	93.0	93.0
Power Factor	25%	0.44	0.42	0.38	0.34
	50%	0.70	0.68	0.63	0.59
	75%	0.80	0.78	0.75	0.72
	100%	0.84	0.83	0.81	0.79
Bearing type	: <u>Drive end</u> 6312 Z C3 <u>Non drive end</u> 6211 Z C3	Foundation loads			
Sealing	: Without Without	Max. traction			
	: Bearing Seal Bearing Seal	Max. compression			
Lubrication interval	: 20000 h 20000 h				
Lubricant amount	: 21 g 11 g				
Lubricant type	: Mobil Polyrex EM				
Notes					
USABLE @208V 105A SF 1.15 SFA 121A					
This revision replaces and cancel the previous one, which must be eliminated. (1) Looking the motor from the shaft end. (2) Measured at 1m and with tolerance of +3dB(A). (3) Approximate weight subject to changes after manufacturing process. (4) At 100% of full load.			These are average values based on tests with sinusoidal power supply, subject to the tolerances stipulated in NEMA MG-1.		
Rev.	Changes Summary		Performed	Checked	Date
Performed by					
Checked by				Page	Revision
Date	13/04/2022			1 / 21	

TORQUE AND CURRENT VS SPEED CURVE

Three Phase Induction Motor - Squirrel Cage



Customer :

Product line : W40 JP Pump NEMA Premium Efficiency Three-Phase

Product code : 14486992

Catalog # : 04018OT3E324JP-W40

TORQUE AND CURRENT VS SPEED CURVE

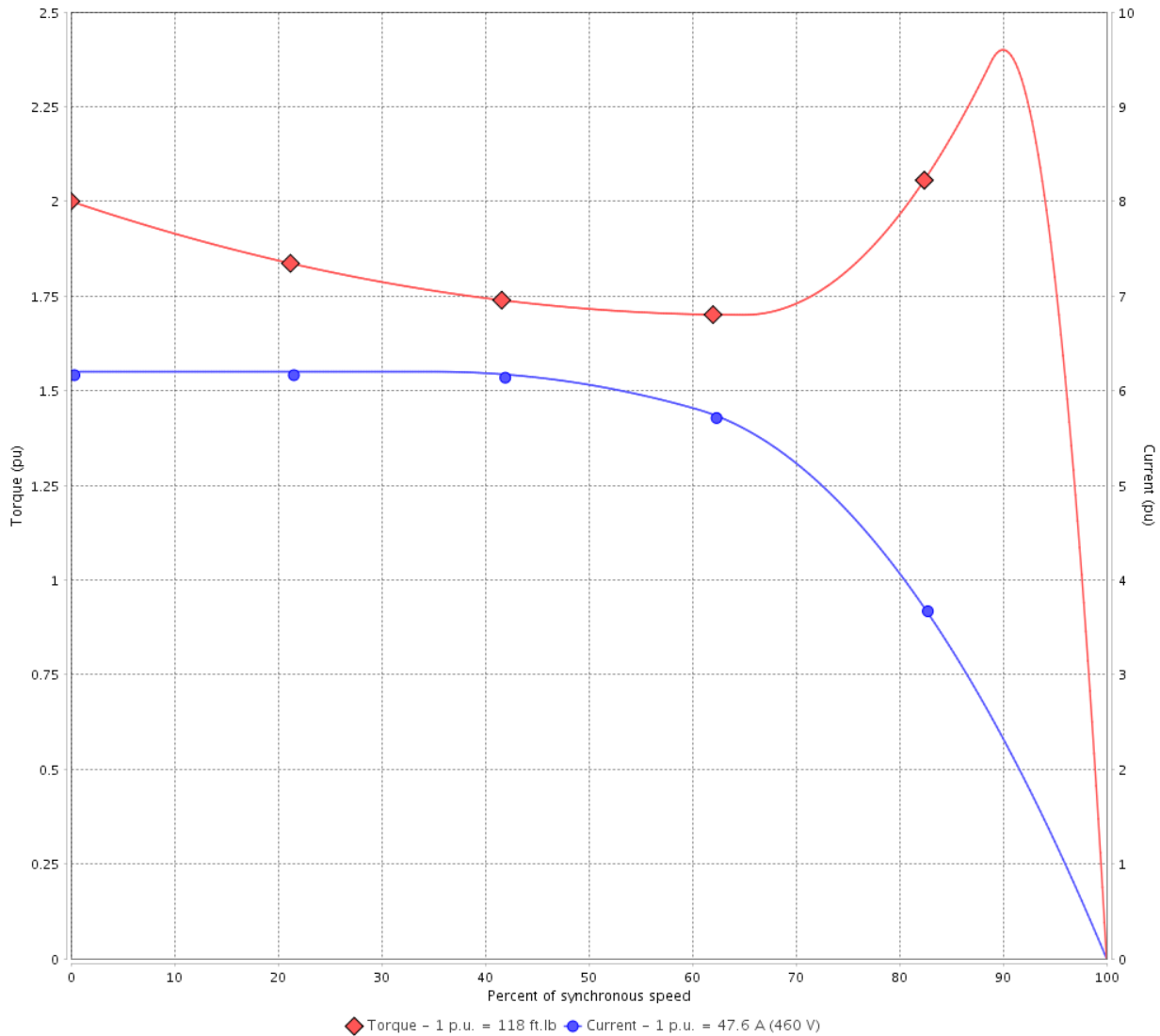

Performance : 230/460 V 60 Hz 4P

Rated current	: 95.2/47.6 A	Moment of inertia (J)	: 5.69 sq.ft.lb
LRC	: 6.2	Duty cycle	: Cont.(S1)
Rated torque	: 118 ft.lb	Insulation class	: F
Locked rotor torque	: 200 %	Service factor	: 1.25
Breakdown torque	: 240 %	Temperature rise	: 80 K
Rated speed	: 1775 rpm	Design	: B

Locked rotor time : 23s (cold) 13s (hot)

Rev.	Changes Summary	Performed	Checked	Date
Performed by			Page 2 / 21	Revision
Checked by				
Date	13/04/2022			

TORQUE AND CURRENT VS SPEED CURVE



Three Phase Induction Motor - Squirrel Cage

Customer :

Product line : W40 JP Pump NEMA Premium Efficiency Three-Phase

Product code : 14486992

Catalog # : 04018OT3E324JP-W40

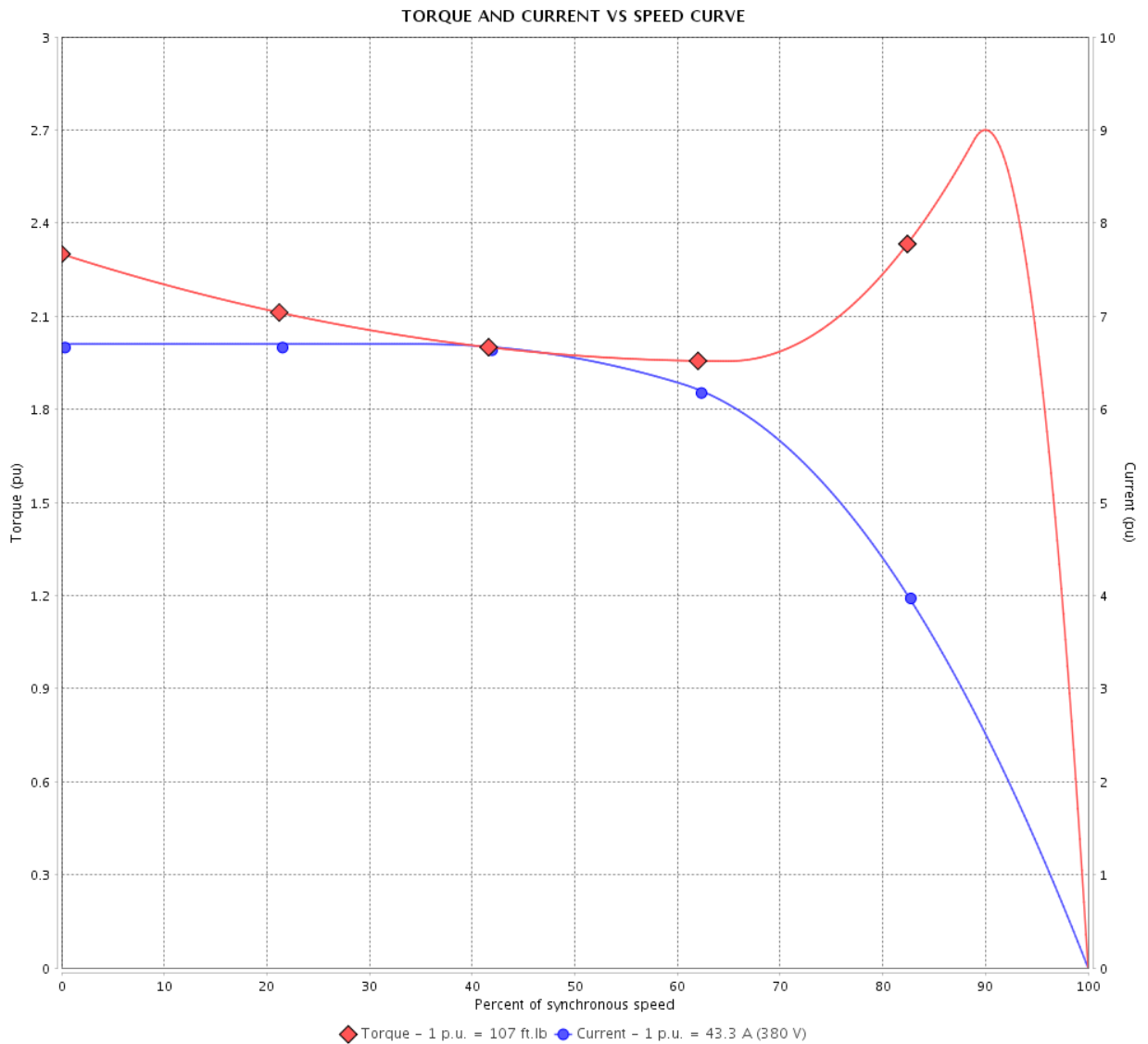

Performance : 380 V 50 Hz 4P IE3

Rated current	: 43.3 A	Moment of inertia (J)	: 5.69 sq.ft.lb
LRC	: 6.7	Duty cycle	: Cont.(S1)
Rated torque	: 107 ft.lb	Insulation class	: F
Locked rotor torque	: 229 %	Service factor	: 1.00
Breakdown torque	: 270 %	Temperature rise	: 80 K
Rated speed	: 1475 rpm	Design	: B

Locked rotor time : 30s (cold) 17s (hot)

Rev.	Changes Summary	Performed	Checked	Date
Performed by			Page 3 / 21	Revision
Checked by				
Date	13/04/2022			

TORQUE AND CURRENT VS SPEED CURVE

Three Phase Induction Motor - Squirrel Cage



Customer :

Product line : W40 JP Pump NEMA Premium Efficiency Three-Phase

Product code : 14486992

Catalog # : 04018OT3E324JP-W40

TORQUE AND CURRENT VS SPEED CURVE

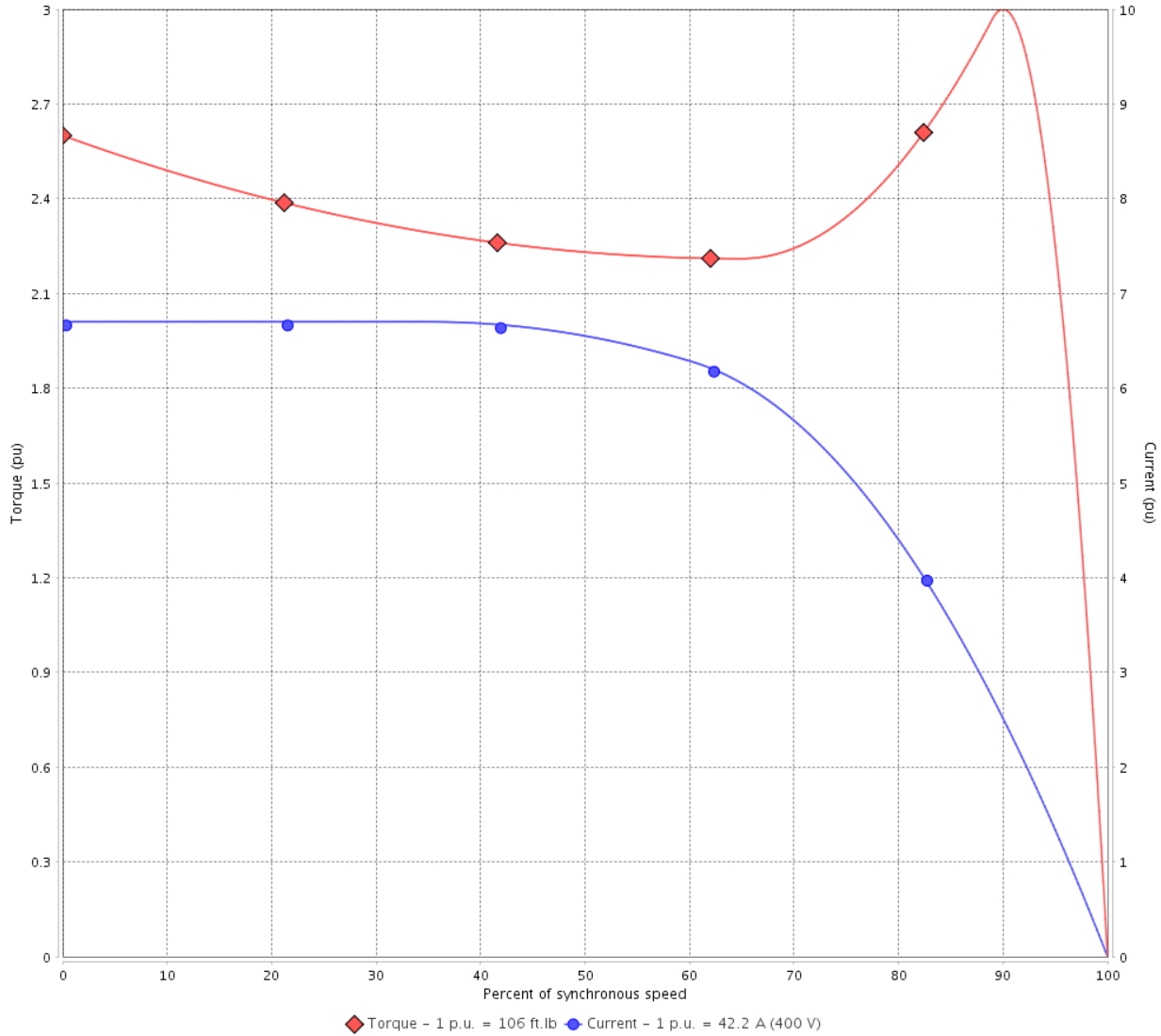

Performance : 400 V 50 Hz 4P IE3

Rated current	: 42.2 A	Moment of inertia (J)	: 5.69 sq.ft.lb
LRC	: 6.7	Duty cycle	: Cont.(S1)
Rated torque	: 106 ft.lb	Insulation class	: F
Locked rotor torque	: 260 %	Service factor	: 1.00
Breakdown torque	: 300 %	Temperature rise	: 80 K
Rated speed	: 1480 rpm	Design	: B

Locked rotor time : 30s (cold) 17s (hot)

Rev.	Changes Summary	Performed	Checked	Date
Performed by			Page 4 / 21	Revision
Checked by				
Date	13/04/2022			

TORQUE AND CURRENT VS SPEED CURVE



Three Phase Induction Motor - Squirrel Cage

Customer :

Product line : W40 JP Pump NEMA Premium Efficiency Three-Phase

Product code : 14486992

Catalog # : 04018OT3E324JP-W40

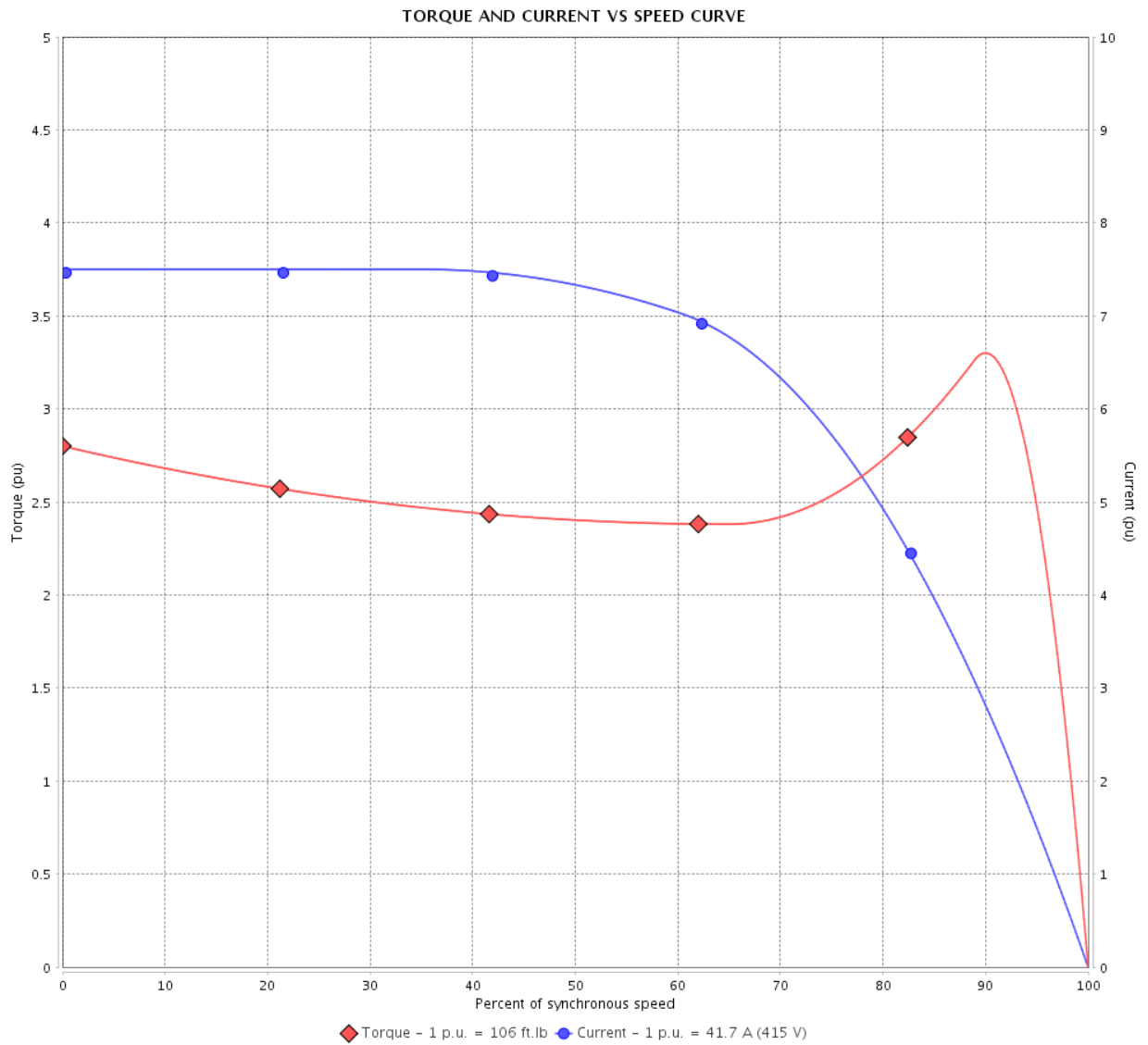

Performance : 415 V 50 Hz 4P IE3

Rated current	: 41.7 A	Moment of inertia (J)	: 5.69 sq.ft.lb
LRC	: 7.5	Duty cycle	: Cont.(S1)
Rated torque	: 106 ft.lb	Insulation class	: F
Locked rotor torque	: 280 %	Service factor	: 1.00
Breakdown torque	: 330 %	Temperature rise	: 80 K
Rated speed	: 1480 rpm	Design	: B

Locked rotor time : 25s (cold) 14s (hot)

Rev.	Changes Summary	Performed	Checked	Date
Performed by			Page 5 / 21	Revision
Checked by				
Date	13/04/2022			

LOAD PERFORMANCE CURVE

Three Phase Induction Motor - Squirrel Cage



Customer :

Product line : W40 JP Pump NEMA Premium Efficiency Three-Phase

Product code : 14486992

Catalog # : 04018OT3E324JP-W40

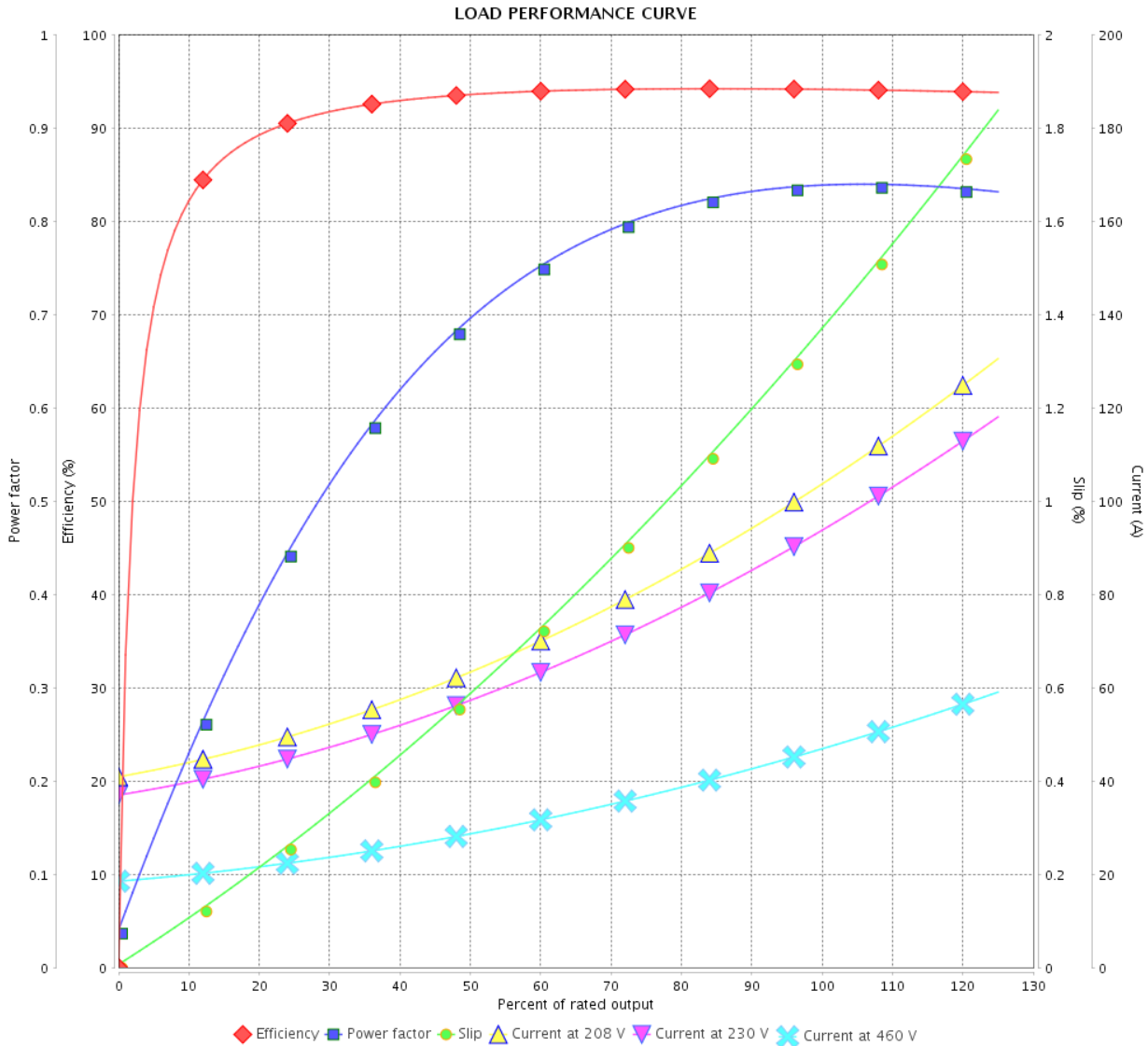

Performance : 230/460 V 60 Hz 4P

Rated current : 95.2/47.6 A
 LRC : 6.2
 Rated torque : 118 ft.lb
 Locked rotor torque : 200 %
 Breakdown torque : 240 %
 Rated speed : 1775 rpm

Moment of inertia (J) : 5.69 sq.ft.lb
 Duty cycle : Cont.(S1)
 Insulation class : F
 Service factor : 1.25
 Temperature rise : 80 K
 Design : B

Rev.	Changes Summary	Performed	Checked	Date
Performed by			Page	Revision
Checked by			6 / 21	
Date	13/04/2022			

LOAD PERFORMANCE CURVE

Three Phase Induction Motor - Squirrel Cage



Customer :

Product line : W40 JP Pump NEMA Premium Efficiency Three-Phase

Product code : 14486992

Catalog # : 04018OT3E324JP-W40

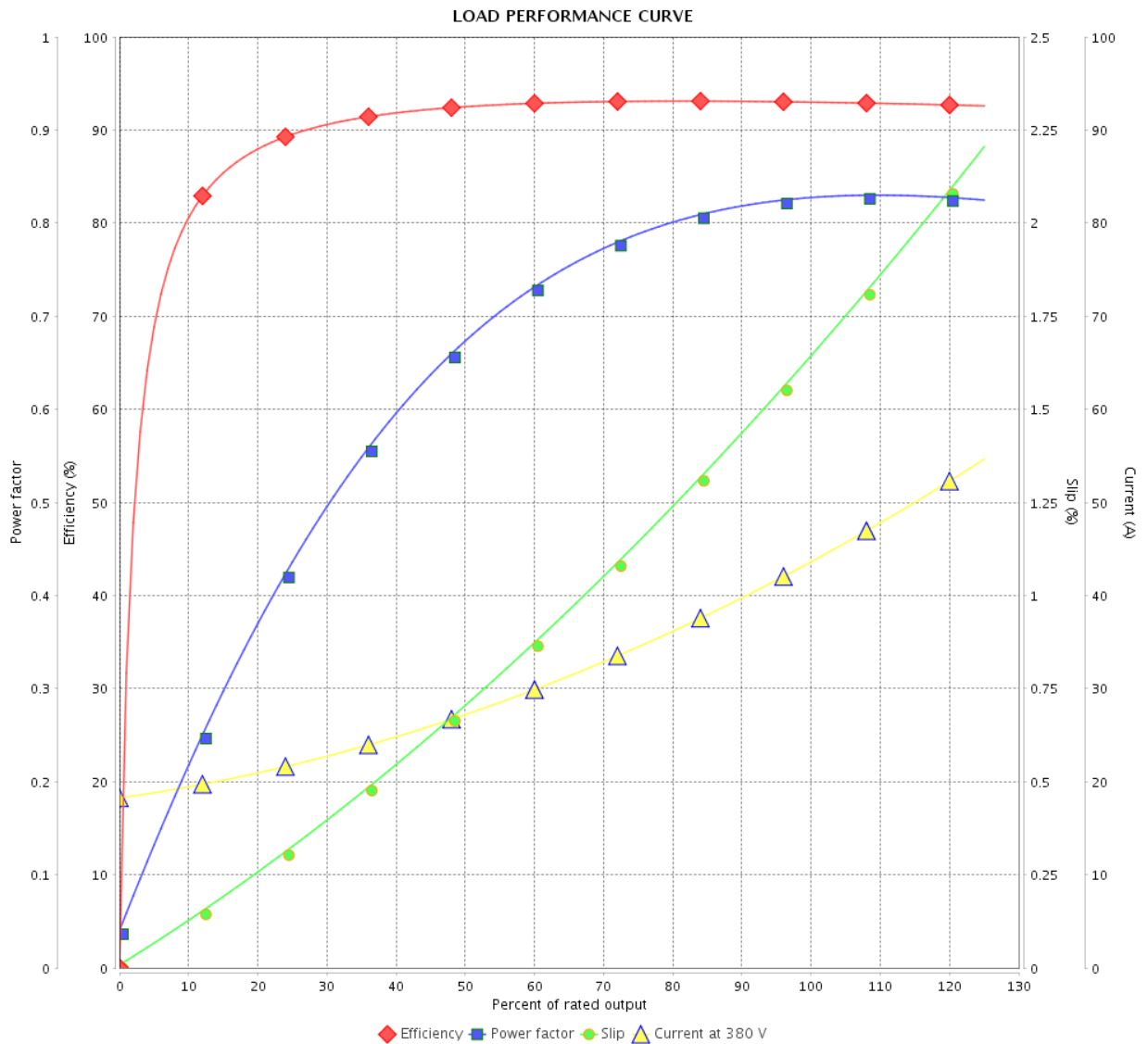

Performance : 380 V 50 Hz 4P IE3

Rated current : 43.3 A
 LRC : 6.7
 Rated torque : 107 ft.lb
 Locked rotor torque : 229 %
 Breakdown torque : 270 %
 Rated speed : 1475 rpm

Moment of inertia (J) : 5.69 sq.ft.lb
 Duty cycle : Cont.(S1)
 Insulation class : F
 Service factor : 1.00
 Temperature rise : 80 K
 Design : B

Rev.	Changes Summary	Performed	Checked	Date
Performed by		Page		Revision
Checked by		7 / 21		
Date		13/04/2022		

LOAD PERFORMANCE CURVE

Three Phase Induction Motor - Squirrel Cage



Customer :

Product line : W40 JP Pump NEMA Premium
Efficiency Three-Phase

Product code : 14486992

Catalog # : 04018OT3E324JP-W40

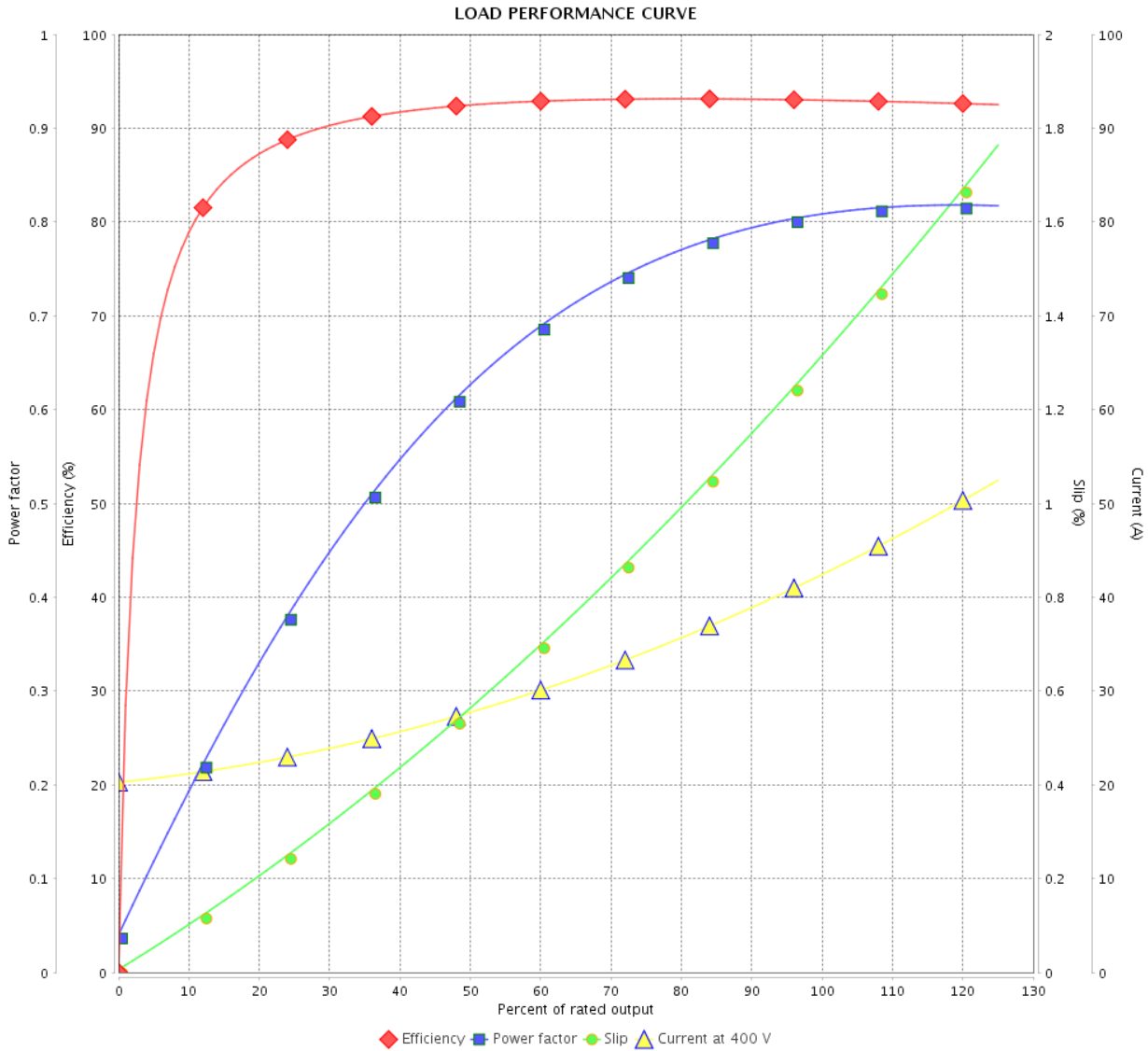

Performance : 400 V 50 Hz 4P IE3

Rated current : 42.2 A
LRC : 6.7
Rated torque : 106 ft.lb
Locked rotor torque : 260 %
Breakdown torque : 300 %
Rated speed : 1480 rpm

Moment of inertia (J) : 5.69 sq.ft.lb
Duty cycle : Cont.(S1)
Insulation class : F
Service factor : 1.00
Temperature rise : 80 K
Design : B

Rev.	Changes Summary	Performed	Checked	Date
Performed by			Page 8 / 21	Revision
Checked by				
Date	13/04/2022			

LOAD PERFORMANCE CURVE

Three Phase Induction Motor - Squirrel Cage



Customer :

Product line : W40 JP Pump NEMA Premium Efficiency Three-Phase

Product code : 14486992

Catalog # : 04018OT3E324JP-W40

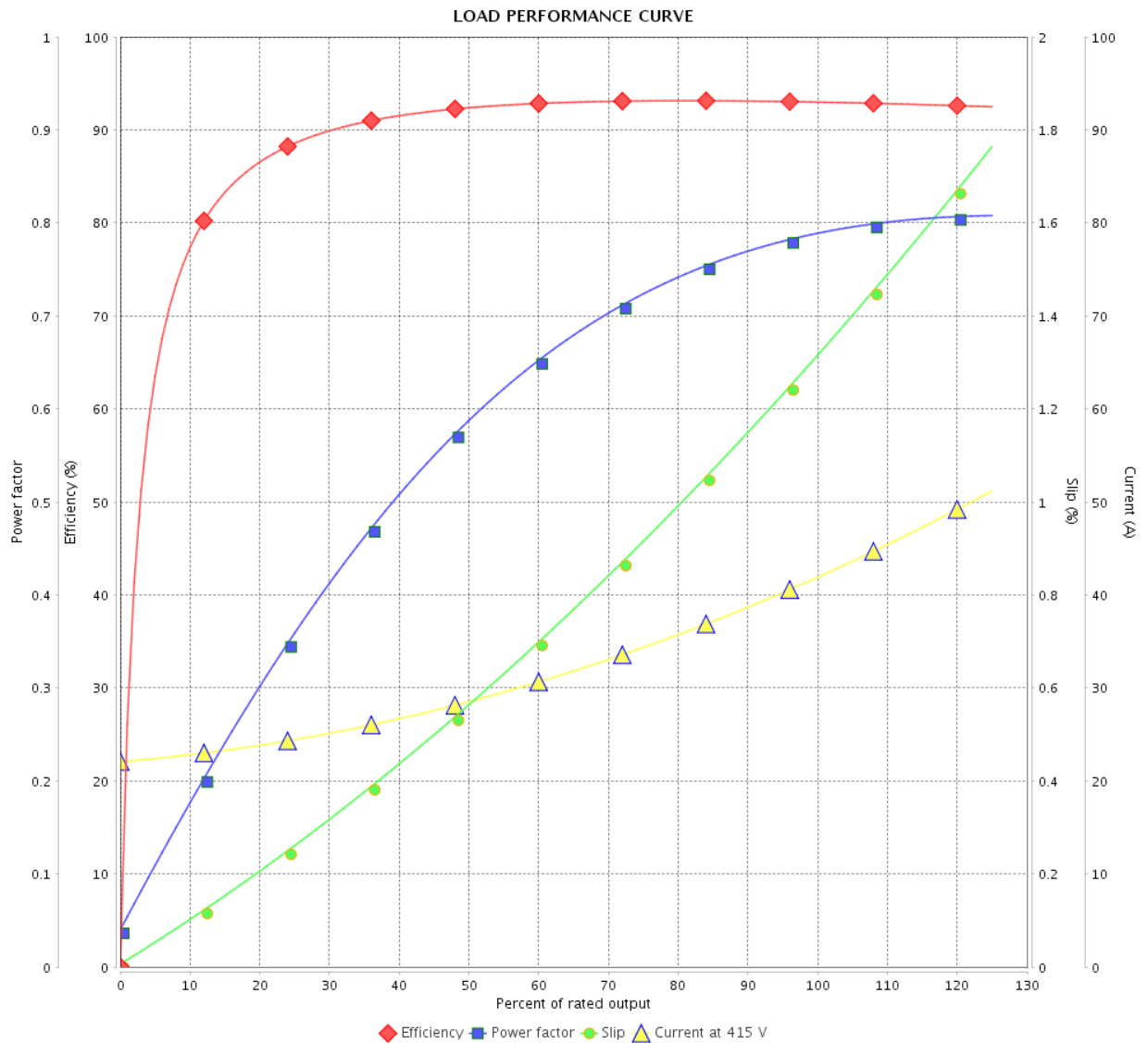

Performance : 415 V 50 Hz 4P IE3

Rated current : 41.7 A
 LRC : 7.5
 Rated torque : 106 ft.lb
 Locked rotor torque : 280 %
 Breakdown torque : 330 %
 Rated speed : 1480 rpm

Moment of inertia (J) : 5.69 sq.ft.lb
 Duty cycle : Cont.(S1)
 Insulation class : F
 Service factor : 1.00
 Temperature rise : 80 K
 Design : B

Rev.	Changes Summary	Performed	Checked	Date
Performed by			Page	Revision
Checked by				
Date				

THERMAL LIMIT CURVE

Three Phase Induction Motor - Squirrel Cage



Customer :

Product line : W40 JP Pump NEMA Premium
Efficiency Three-Phase

Product code : 14486992

Catalog # : 04018OT3E324JP-W40

Performance : 230/460 V 60 Hz 4P

Rated current : 95.2/47.6 A
LRC : 6.2
Rated torque : 118 ft.lb
Locked rotor torque : 200 %
Breakdown torque : 240 %
Rated speed : 1775 rpm

Moment of inertia (J) : 5.69 sq.ft.lb
Duty cycle : Cont.(S1)
Insulation class : F
Service factor : 1.25
Temperature rise : 80 K
Design : B

Heating constant

Cooling constant

Rev.	Changes Summary	Performed	Checked	Date
Performed by				
Checked by			Page	Revision
Date	13/04/2022		10 / 21	

THERMAL LIMIT CURVE

Three Phase Induction Motor - Squirrel Cage



Customer : _____

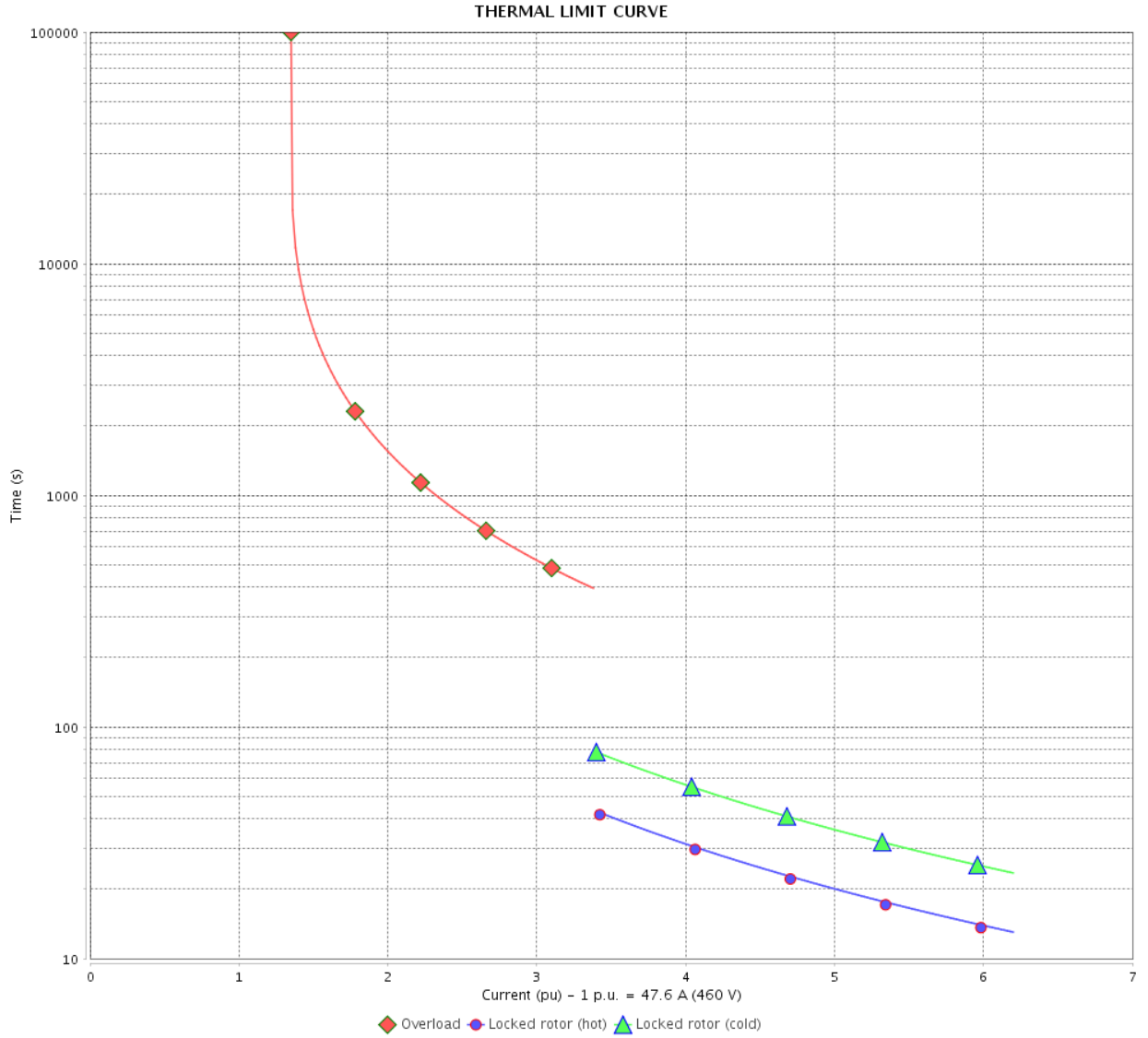

Rev.	Changes Summary	Performed	Checked	Date
Performed by		Page		Revision
Checked by		11 / 21		
Date		13/04/2022		

THERMAL LIMIT CURVE



Three Phase Induction Motor - Squirrel Cage

Customer :

Product line : W40 JP Pump NEMA Premium
Efficiency Three-Phase

Product code : 14486992

Catalog # : 04018OT3E324JP-W40

Performance : 380 V 50 Hz 4P IE3

Rated current	: 43.3 A	Moment of inertia (J)	: 5.69 sq.ft.lb
LRC	: 6.7	Duty cycle	: Cont.(S1)
Rated torque	: 107 ft.lb	Insulation class	: F
Locked rotor torque	: 229 %	Service factor	: 1.00
Breakdown torque	: 270 %	Temperature rise	: 80 K
Rated speed	: 1475 rpm	Design	: B

Heating constant

Cooling constant

Rev.	Changes Summary	Performed	Checked	Date
Performed by				
Checked by			Page	Revision
Date	13/04/2022		12 / 21	

THERMAL LIMIT CURVE

Three Phase Induction Motor - Squirrel Cage



Customer : _____

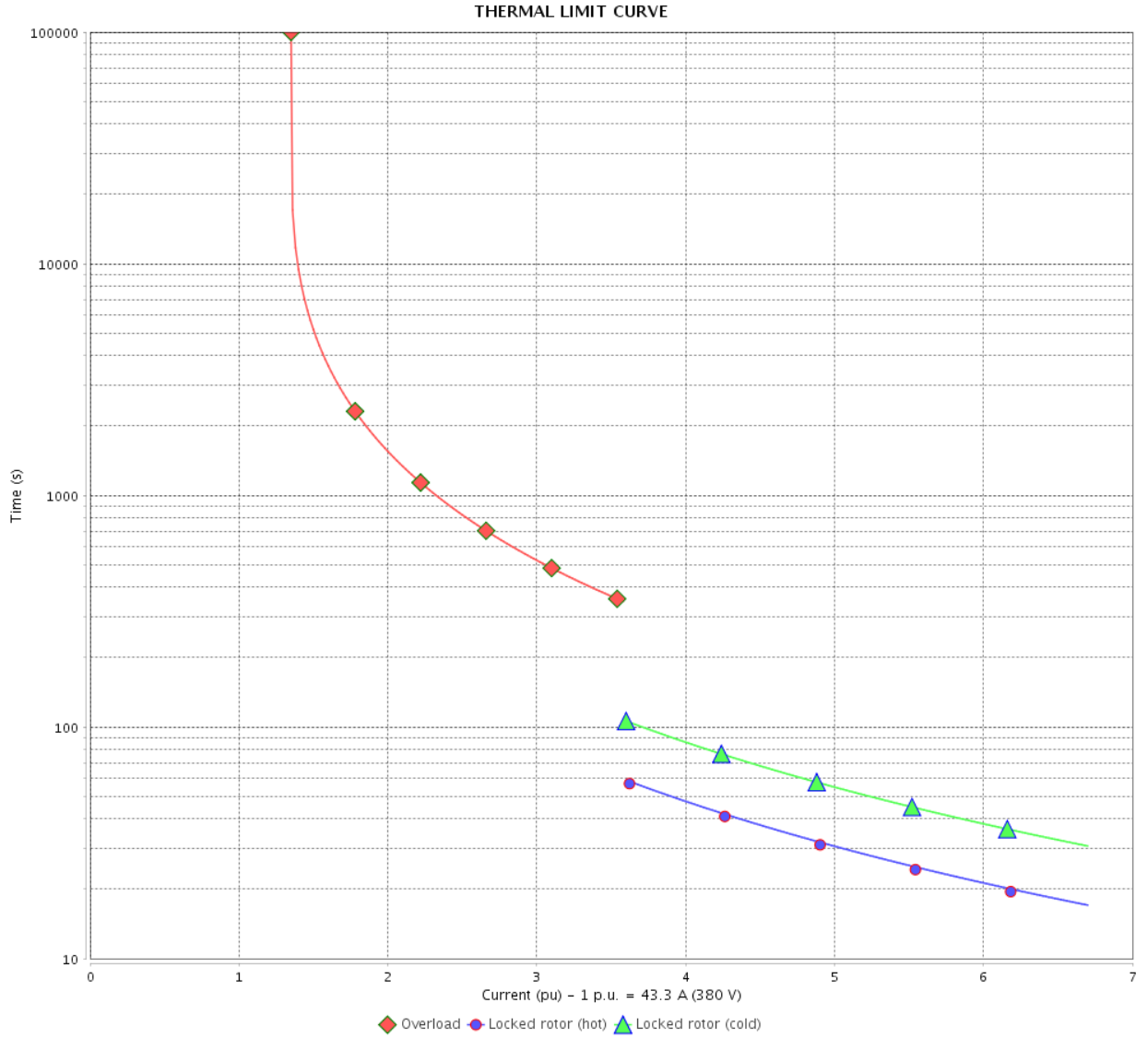

Rev.	Changes Summary	Performed	Checked	Date
Performed by		Page 13 / 21 Revision		
Checked by				
Date				

THERMAL LIMIT CURVE

Three Phase Induction Motor - Squirrel Cage



Customer :

Product line : W40 JP Pump NEMA Premium
Efficiency Three-Phase

Product code : 14486992

Catalog # : 04018OT3E324JP-W40

Performance : 400 V 50 Hz 4P IE3

Rated current	: 42.2 A	Moment of inertia (J)	: 5.69 sq.ft.lb
LRC	: 6.7	Duty cycle	: Cont.(S1)
Rated torque	: 106 ft.lb	Insulation class	: F
Locked rotor torque	: 260 %	Service factor	: 1.00
Breakdown torque	: 300 %	Temperature rise	: 80 K
Rated speed	: 1480 rpm	Design	: B

Heating constant

Cooling constant

Rev.	Changes Summary	Performed	Checked	Date
Performed by				
Checked by			Page	Revision
Date	13/04/2022		14 / 21	

THERMAL LIMIT CURVE

Three Phase Induction Motor - Squirrel Cage



Customer : _____

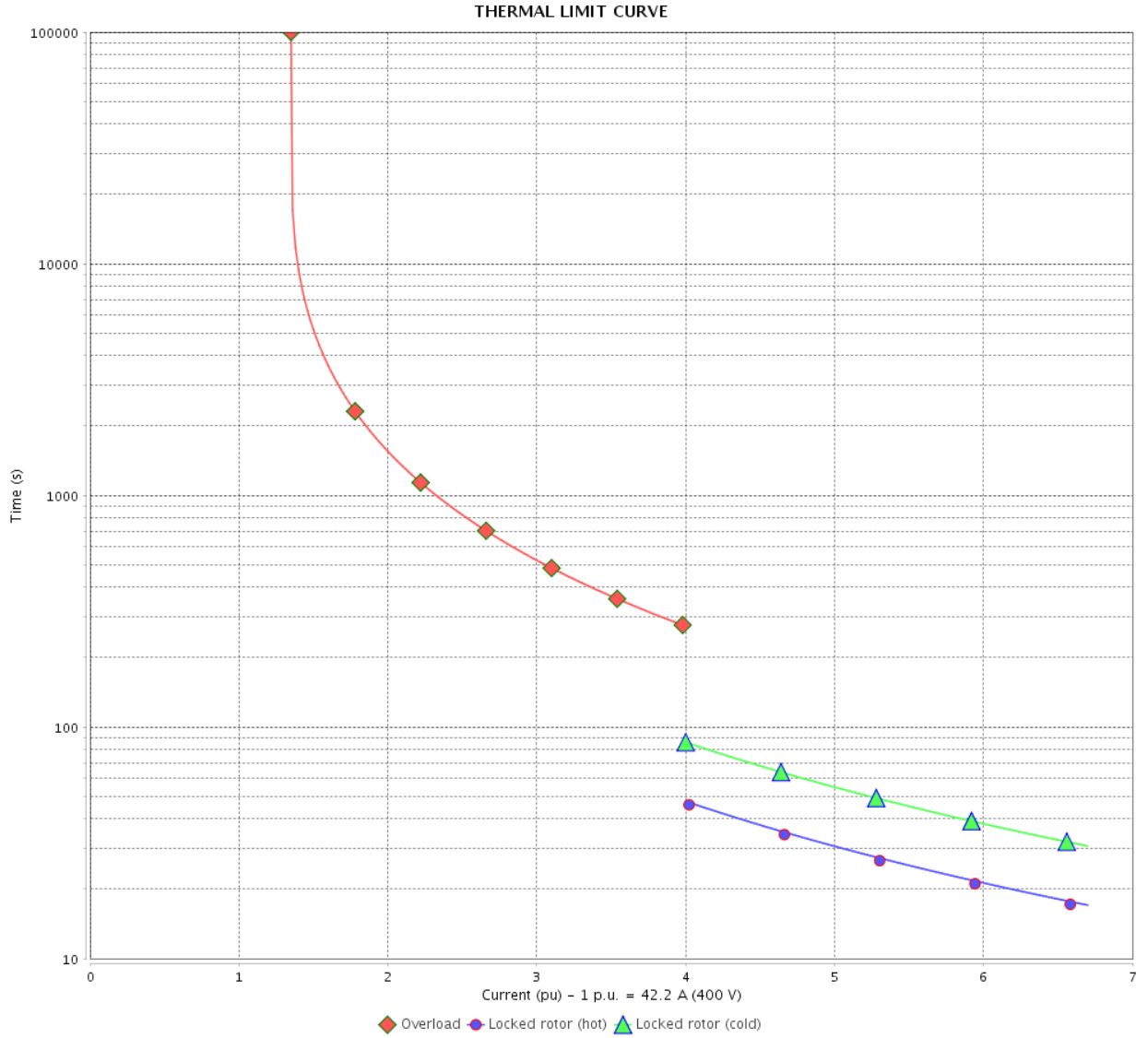

Rev.	Changes Summary	Performed	Checked	Date
Performed by		Page		Revision
Checked by		15 / 21		
Date		13/04/2022		

THERMAL LIMIT CURVE



Three Phase Induction Motor - Squirrel Cage

Customer :

Product line : W40 JP Pump NEMA Premium
Efficiency Three-Phase

Product code : 14486992

Catalog # : 04018OT3E324JP-W40

Performance : 415 V 50 Hz 4P IE3

Rated current	: 41.7 A	Moment of inertia (J)	: 5.69 sq.ft.lb
LRC	: 7.5	Duty cycle	: Cont.(S1)
Rated torque	: 106 ft.lb	Insulation class	: F
Locked rotor torque	: 280 %	Service factor	: 1.00
Breakdown torque	: 330 %	Temperature rise	: 80 K
Rated speed	: 1480 rpm	Design	: B

Heating constant

Cooling constant

Rev.	Changes Summary	Performed	Checked	Date
Performed by				
Checked by			Page	Revision
Date	13/04/2022		16 / 21	

THERMAL LIMIT CURVE

Three Phase Induction Motor - Squirrel Cage



Customer : _____

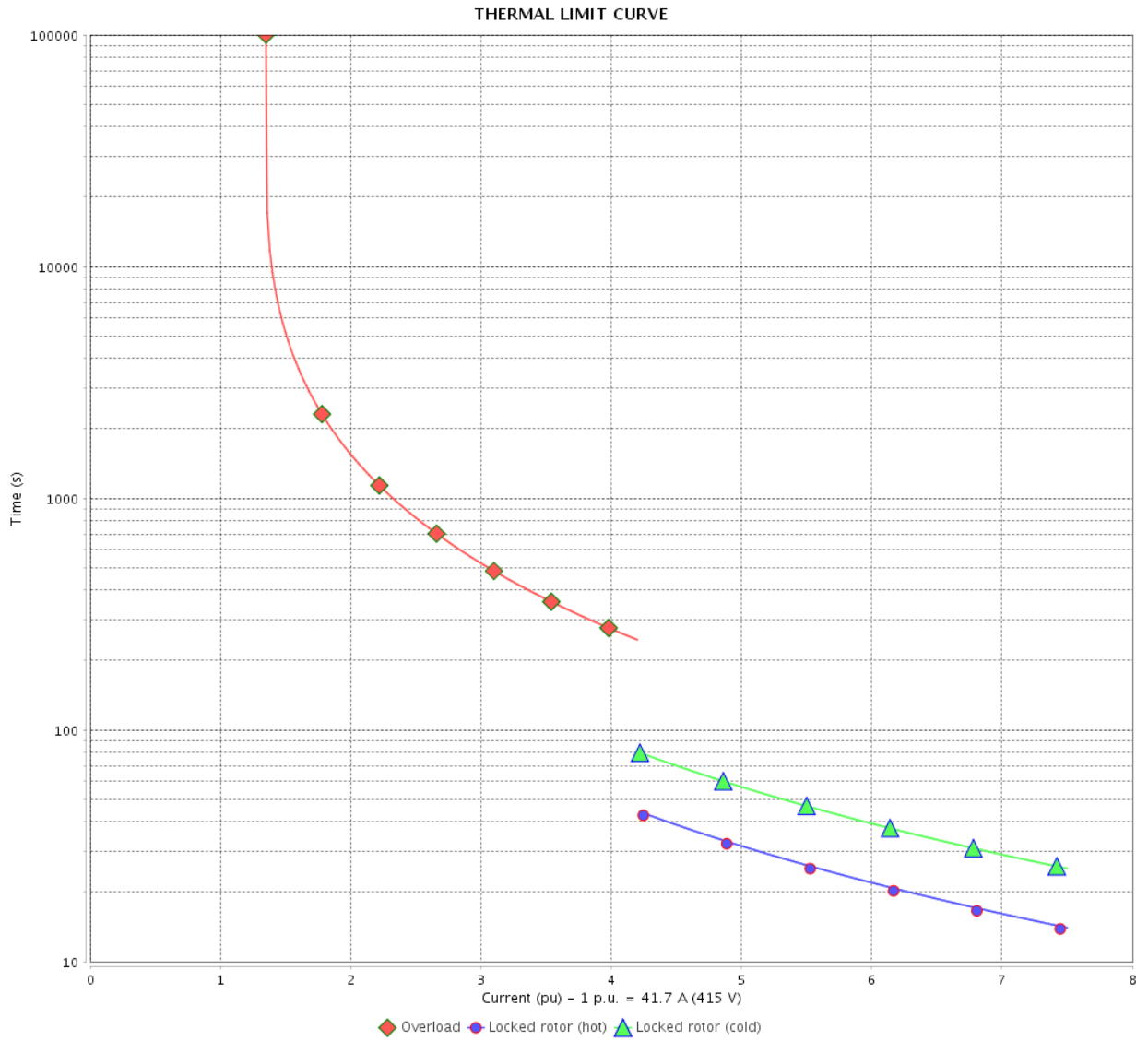

Rev.	Changes Summary	Performed	Checked	Date
Performed by		Page 17 / 21		Revision
Checked by				
Date				

VFD OPERATION CURVE

Three Phase Induction Motor - Squirrel Cage



Customer :

Product line : W40 JP Pump NEMA Premium Efficiency Three-Phase

Product code : 14486992

Catalog # : 04018OT3E324JP-W40

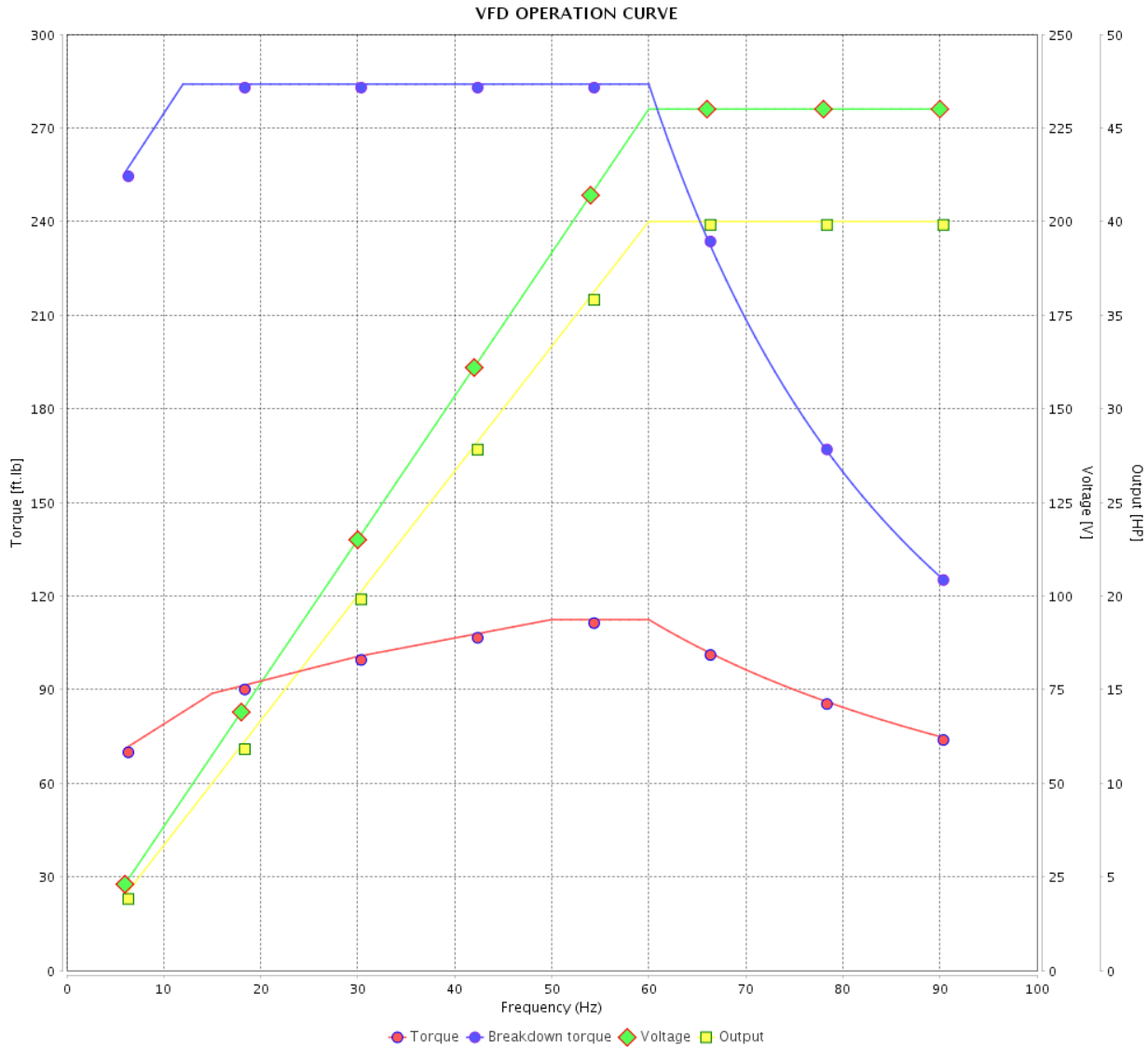

Performance : 230/460 V 60 Hz 4P

Rated current : 95.2/47.6 A
 LRC : 6.2
 Rated torque : 118 ft.lb
 Locked rotor torque : 200 %
 Breakdown torque : 240 %
 Rated speed : 1775 rpm

Moment of inertia (J) : 5.69 sq.ft.lb
 Duty cycle : Cont.(S1)
 Insulation class : F
 Service factor : 1.25
 Temperature rise : 80 K
 Design : B

Rev.	Changes Summary	Performed	Checked	Date
Performed by			Page 18 / 21	Revision
Checked by				
Date	13/04/2022			

VFD OPERATION CURVE

Three Phase Induction Motor - Squirrel Cage



Customer :

Product line : W40 JP Pump NEMA Premium Efficiency Three-Phase

Product code : 14486992

Catalog # : 04018OT3E324JP-W40

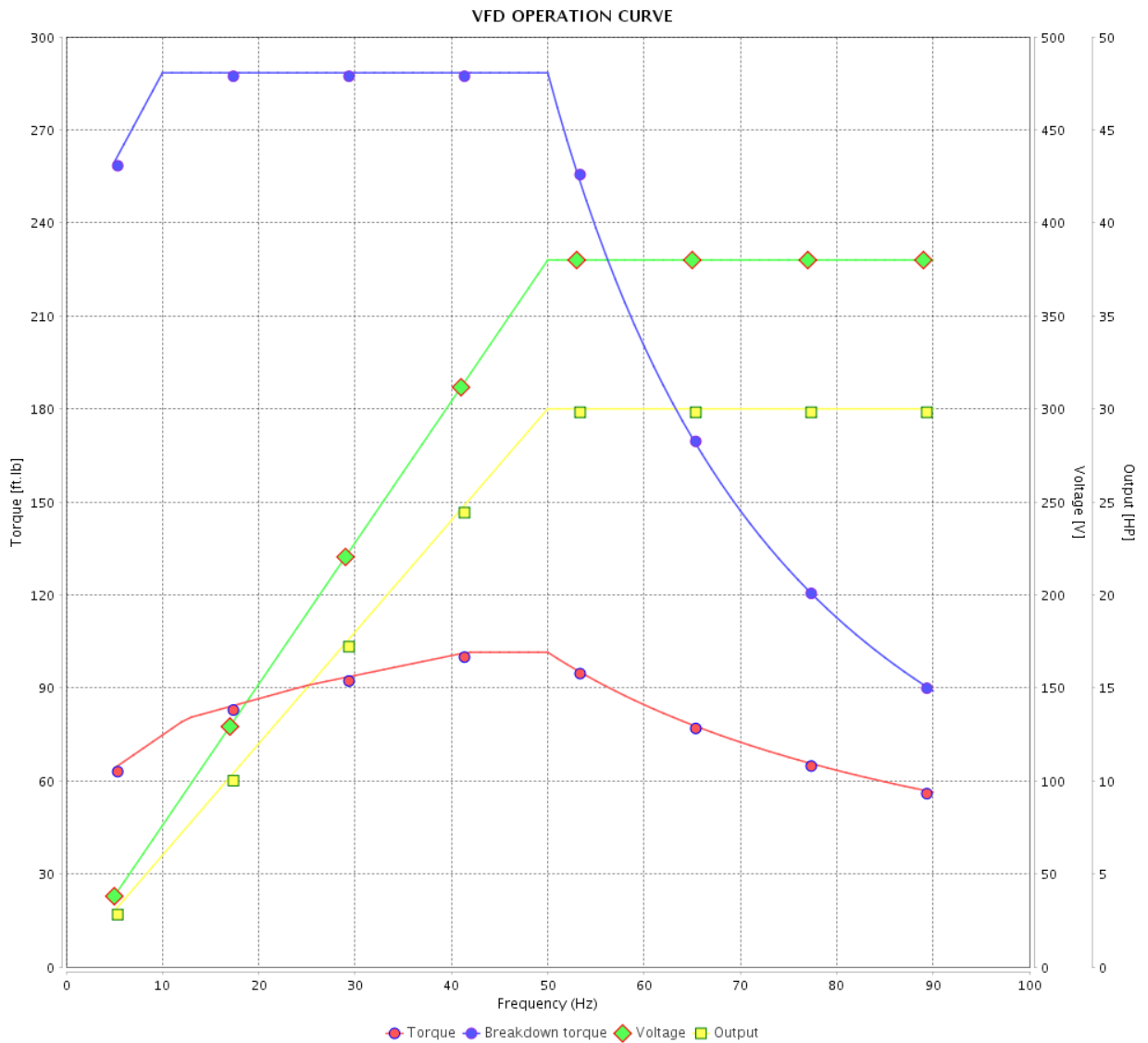

Performance : 380 V 50 Hz 4P IE3

Rated current : 43.3 A
 LRC : 6.7
 Rated torque : 107 ft.lb
 Locked rotor torque : 229 %
 Breakdown torque : 270 %
 Rated speed : 1475 rpm

Moment of inertia (J) : 5.69 sq.ft.lb
 Duty cycle : Cont.(S1)
 Insulation class : F
 Service factor : 1.00
 Temperature rise : 80 K
 Design : B

Rev.	Changes Summary	Performed	Checked	Date
Performed by			Page	Revision
Checked by			19 / 21	
Date	13/04/2022			

VFD OPERATION CURVE

Three Phase Induction Motor - Squirrel Cage



Customer :

Product line : W40 JP Pump NEMA Premium Efficiency Three-Phase

Product code : 14486992

Catalog # : 04018OT3E324JP-W40

VFD OPERATION CURVE

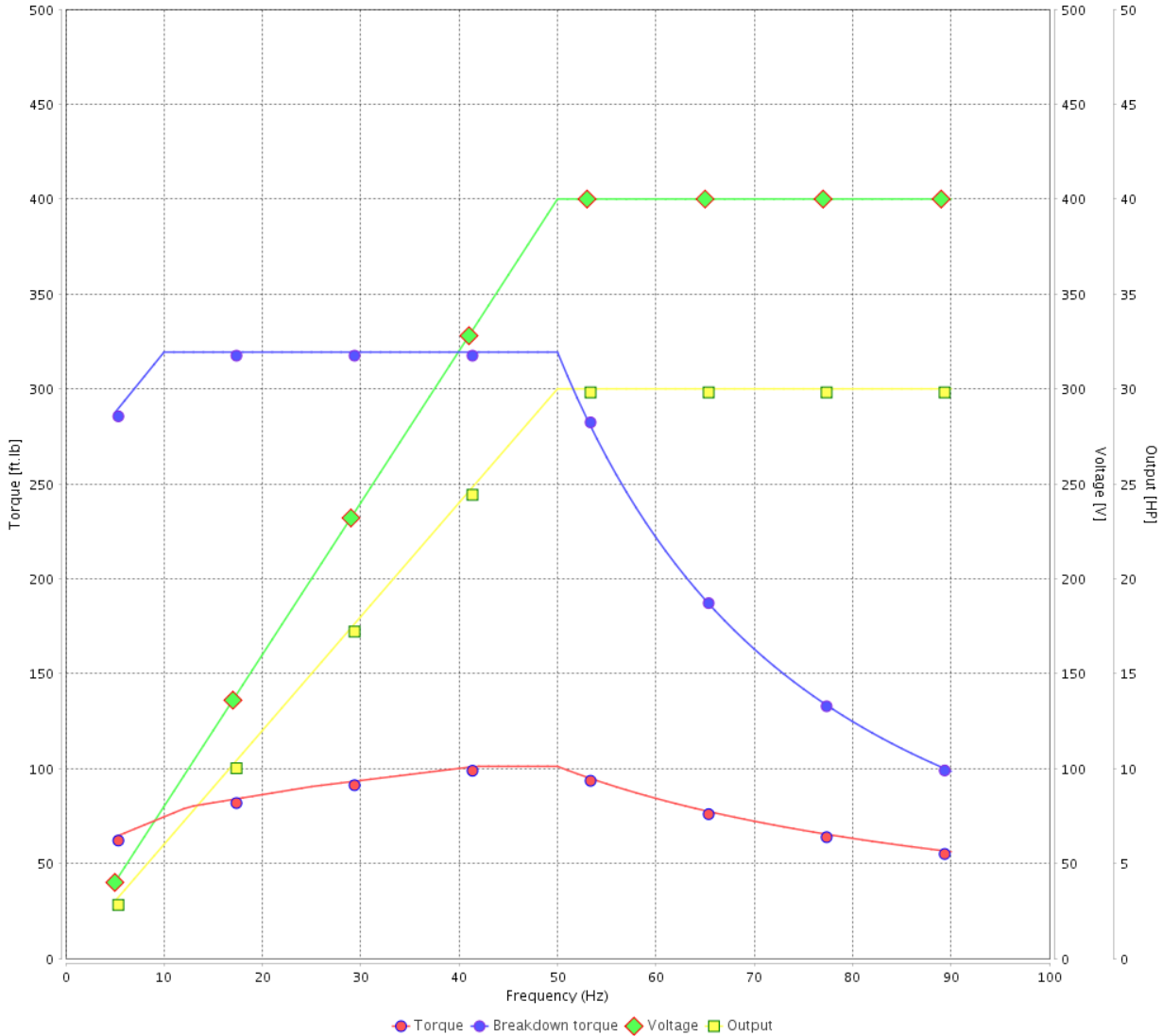

Performance : 400 V 50 Hz 4P IE3

Rated current	: 42.2 A	Moment of inertia (J)	: 5.69 sq.ft.lb
LRC	: 6.7	Duty cycle	: Cont.(S1)
Rated torque	: 106 ft.lb	Insulation class	: F
Locked rotor torque	: 260 %	Service factor	: 1.00
Breakdown torque	: 300 %	Temperature rise	: 80 K
Rated speed	: 1480 rpm	Design	: B

Rev.	Changes Summary	Performed	Checked	Date
Performed by			Page 20 / 21	Revision
Checked by				
Date	13/04/2022			

VFD OPERATION CURVE

Three Phase Induction Motor - Squirrel Cage



Customer :

Product line : W40 JP Pump NEMA Premium Efficiency Three-Phase

Product code : 14486992

Catalog # : 04018OT3E324JP-W40

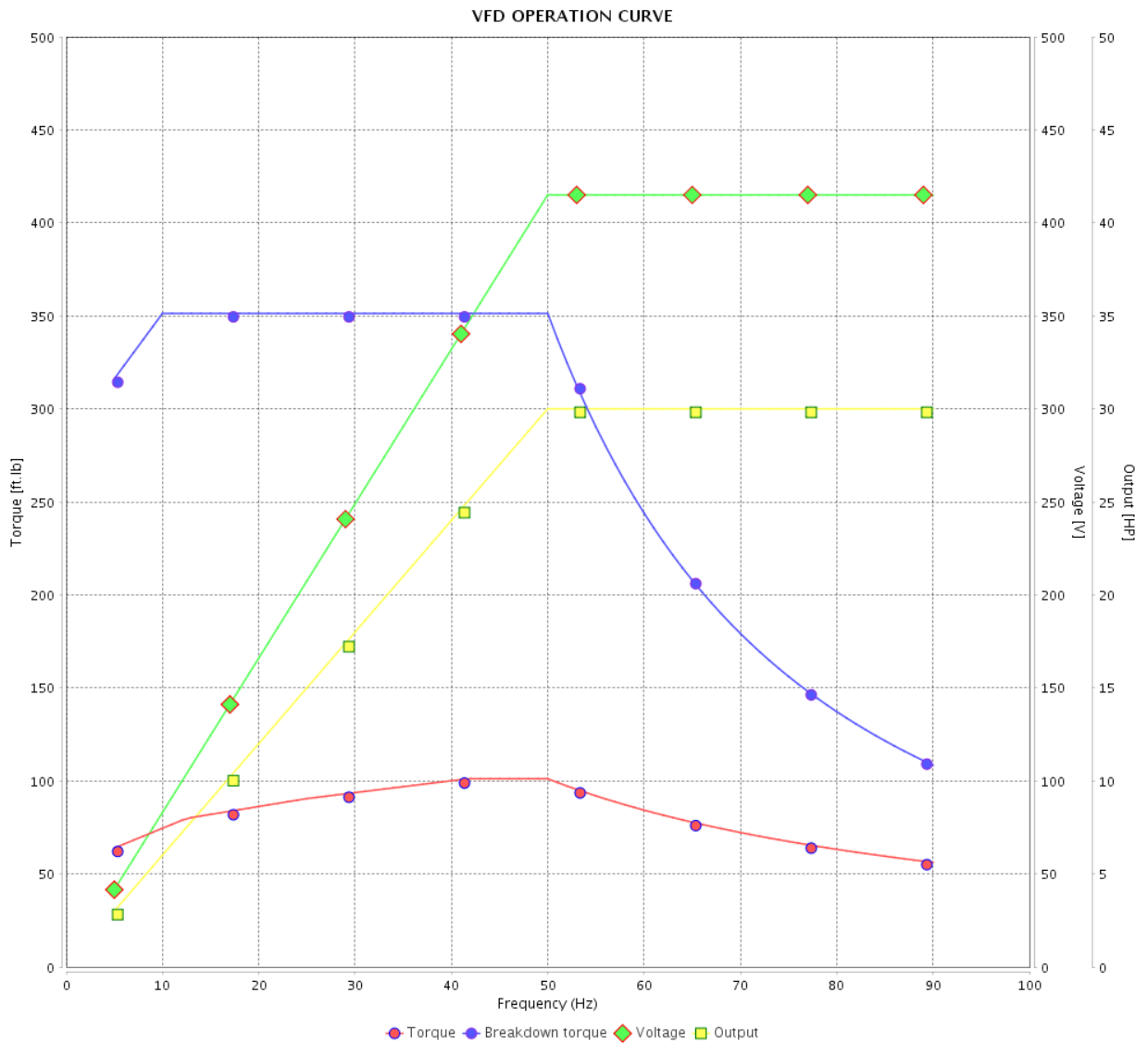

Performance : 415 V 50 Hz 4P IE3

Rated current : 41.7 A
 LRC : 7.5
 Rated torque : 106 ft.lb
 Locked rotor torque : 280 %
 Breakdown torque : 330 %
 Rated speed : 1480 rpm

Moment of inertia (J) : 5.69 sq.ft.lb
 Duty cycle : Cont.(S1)
 Insulation class : F
 Service factor : 1.00
 Temperature rise : 80 K
 Design : B

Rev.	Changes Summary	Performed	Checked	Date
Performed by			Page 21 / 21	Revision
Checked by				
Date	13/04/2022			

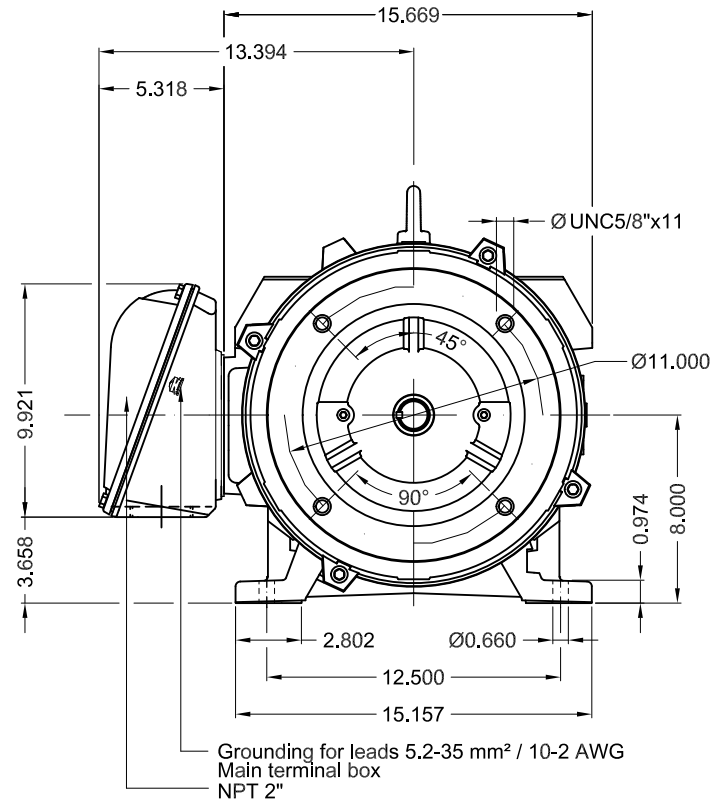

Grounding for leads 5.2-35 mm² / 10-2 AWG
Main terminal box
NPT 2"

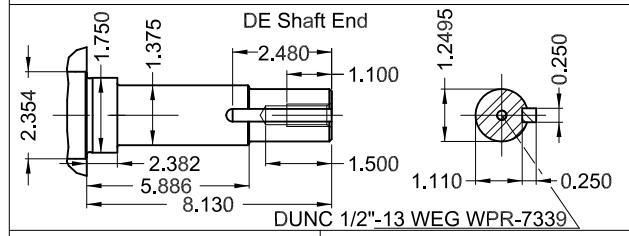
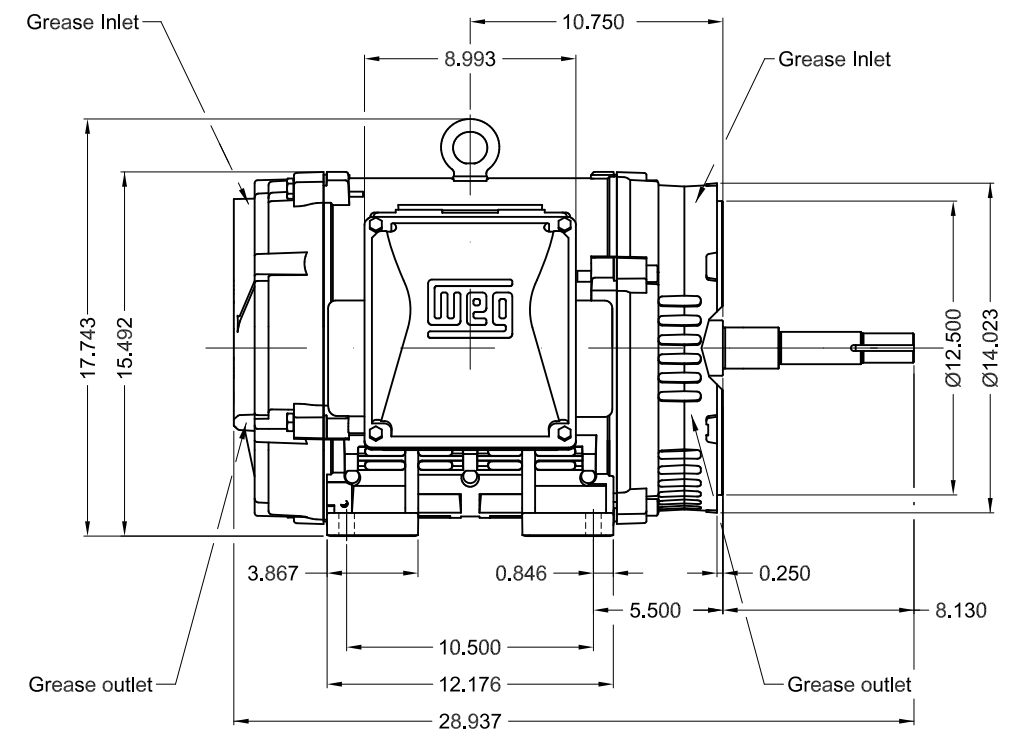

40 HP 04 Poles 60 Hz A

1:8

ECM	LOC	SUMMARY OF MODIFICATIONS	EXECUTED	CHECKED	RELEASED	DATE	VER
EXECUTED	PIRWBUSER	THREE PH. MOTOR W40 CLOSE COUPLED PUMP JP TYPE PREM. FT. FRAME 324JP IP23 ODP					
CHECKED							
RELEASED							
REL DT.	WMO	Jaragua do Sul	Product Engineering	WDD	SHEET	1 / 1	

Color RAL 5009
Painting plan 203A
Mounting NEMA F-1
Mounting B34R(D)

PREVIEW



WEG **W40 NEMA**
CC029A Premium
Inverter Duty Motor



IEC 60034-1
 MOD.T01#FOXON



For 60Hz use on PWM, VT 1000:1, CT 3:1, 1.0SF

MODEL 040180T3E324JP-W40
 MADE IN BRAZIL
 14486992

PH 3	FR 324JP	HP(kW) 40.0(30.0)	Hz 60				
V 230/460	A 95.2/47.6	RPM 1775	DES B				
NEMA NOM EFF 94.1 %	INS. CL. F Δ T 80 K	IP23			→ 6312-Z-C3 → 6211-Z-C3 MOBIL POLYREX EM 21 g 20000 h		
ENCL ODP	DUTY CONT.	AMB. 40°C					
CODE G	PF 0.84	SF 1.25	SFA 119/59.5				
USABLE @208V	105 A	SF 1.15	SFA 121				
30HP 22kW 50Hz 380V 43.3A 1475RPM SF1.00 EFF 93.0% (IE3)	ALT 1000 m.a.s.l.	463 Lbs					