

# DATA SHEET

## Three Phase Induction Motor - Squirrel Cage



Customer :					
Product line	: W40 NEMA Premium Efficiency Three-Phase	Product code :	14496819		
		Catalog # :	04018OT3E324TSC-W40		
Frame	: 324TSC	Cooling method	: IC01 - ODP		
Insulation class	: F	Mounting	: F-1		
Duty cycle	: Cont.(S1)	Rotation <sup>1</sup>	: Both (CW and CCW)		
Ambient temperature	: -20°C to +40°C	Starting method	: Direct On Line		
Altitude	: 1000 m.a.s.l.	Approx. weight <sup>2</sup>	: 574 lb		
Protection degree	: IP23	Moment of inertia (J)	: 5.69 sq.ft.lb		
Design	: B				
Output [HP]	40	30	30	30	
Poles	4	4	4	4	
Frequency [Hz]	60	50	50	50	
Rated voltage [V]	230/460	380	400	415	
Rated current [A]	95.2/47.6	43.3	42.2	41.7	
L. R. Amperes [A]	590/295	290	283	313	
LRC [A]	6.2x(Code G)	6.7x(Code H)	6.7x(Code H)	7.5x(Code J)	
No load current [A]	37.0/18.5	18.3	20.3	22.1	
Rated speed [RPM]	1775	1475	1480	1480	
Slip [%]	1.39	1.67	1.33	1.33	
Rated torque [ft.lb]	118	107	106	106	
Locked rotor torque [%]	200	229	260	280	
Breakdown torque [%]	240	270	300	330	
Service factor	1.25	1.00	1.00	1.00	
Temperature rise	80 K	80 K	80 K	80 K	
Locked rotor time	23s (cold) 13s (hot)	30s (cold) 17s (hot)	30s (cold) 17s (hot)	25s (cold) 14s (hot)	
Noise level <sup>2</sup>	66.0 dB(A)				
Efficiency (%)	25%	93.5	92.4	92.5	92.4
	50%	93.6	92.6	92.6	92.5
	75%	94.1	93.0	93.0	93.0
	100%	94.1	93.0	93.0	93.0
Power Factor	25%	0.44	0.42	0.38	0.34
	50%	0.70	0.68	0.63	0.59
	75%	0.80	0.78	0.75	0.72
	100%	0.84	0.83	0.81	0.79
Bearing type	: Drive end : 6312 Z C3	Non drive end : 6211 Z C3	Foundation loads		
Sealing	: Without	Without	Max. traction		
	Bearing Seal	Bearing Seal	Max. compression		
Lubrication interval	: 20000 h	20000 h			
Lubricant amount	: 21 g	11 g			
Lubricant type	: Mobil Polyrex EM				
Notes USABLE @208V 105A SF 1.15 SFA 121A					
This revision replaces and cancel the previous one, which must be eliminated. (1) Looking the motor from the shaft end. (2) Measured at 1m and with tolerance of +3dB(A). (3) Approximate weight subject to changes after manufacturing process. (4) At 100% of full load.			These are average values based on tests with sinusoidal power supply, subject to the tolerances stipulated in NEMA MG-1.		
Rev.	Changes Summary		Performed	Checked	Date
Performed by					
Checked by				Page	Revision
Date	12/04/2022			1 / 21	

# TORQUE AND CURRENT VS SPEED CURVE

## Three Phase Induction Motor - Squirrel Cage



Customer :

Product line : W40 NEMA Premium Efficiency  
Three-Phase

Product code : 14496819

Catalog # : 04018OT3E324TSC-W40

TORQUE AND CURRENT VS SPEED CURVE

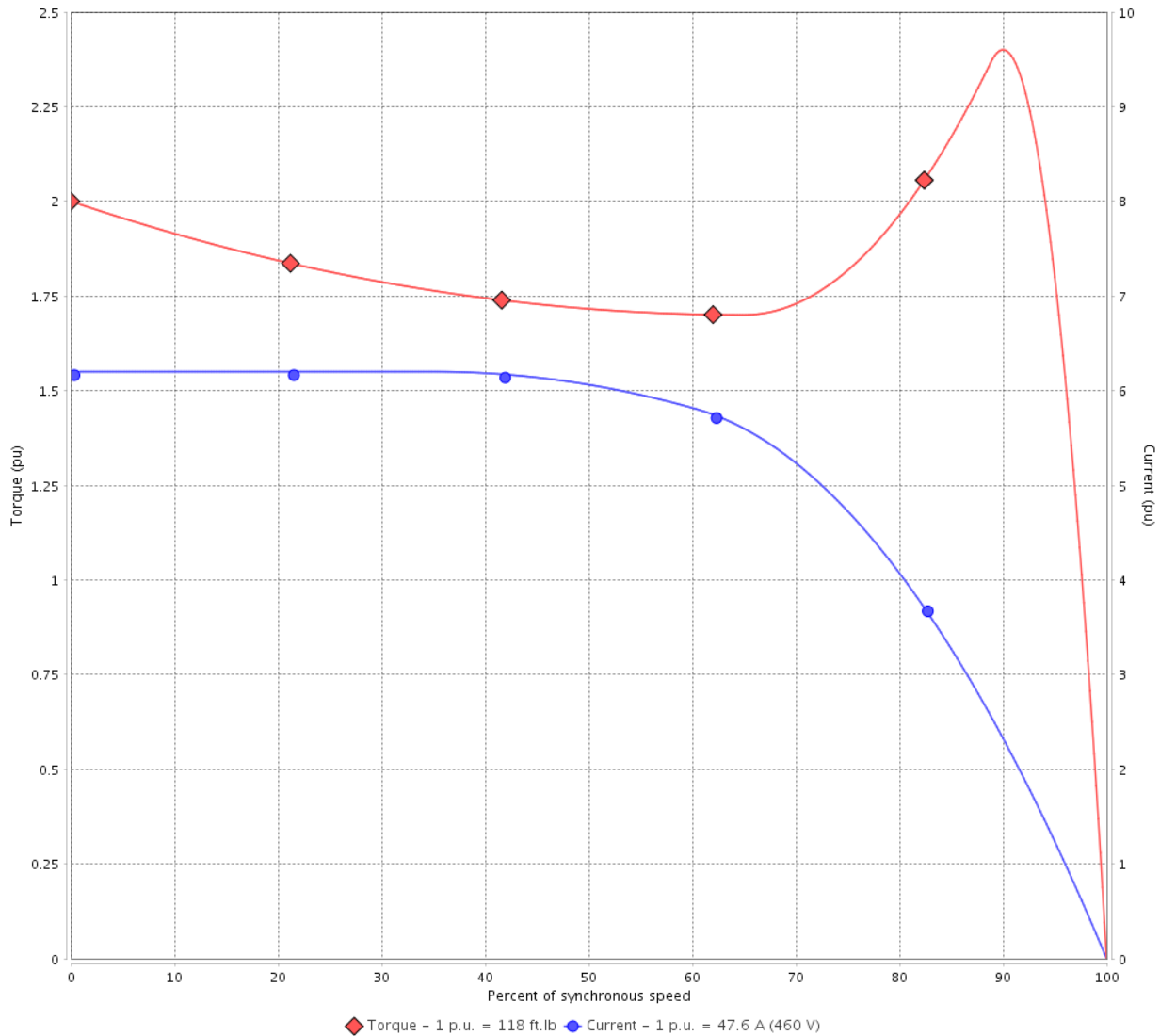

Performance : 230/460 V 60 Hz 4P

Rated current	: 95.2/47.6 A	Moment of inertia (J)	: 5.69 sq.ft.lb
LRC	: 6.2	Duty cycle	: Cont.(S1)
Rated torque	: 118 ft.lb	Insulation class	: F
Locked rotor torque	: 200 %	Service factor	: 1.25
Breakdown torque	: 240 %	Temperature rise	: 80 K
Rated speed	: 1775 rpm	Design	: B

Locked rotor time : 23s (cold) 13s (hot)

Rev.	Changes Summary	Performed	Checked	Date
Performed by			Page 2 / 21	Revision
Checked by				
Date	12/04/2022			

# TORQUE AND CURRENT VS SPEED CURVE



## Three Phase Induction Motor - Squirrel Cage

Customer :

Product line : W40 NEMA Premium Efficiency  
Three-Phase

Product code : 14496819

Catalog # : 04018OT3E324TSC-W40

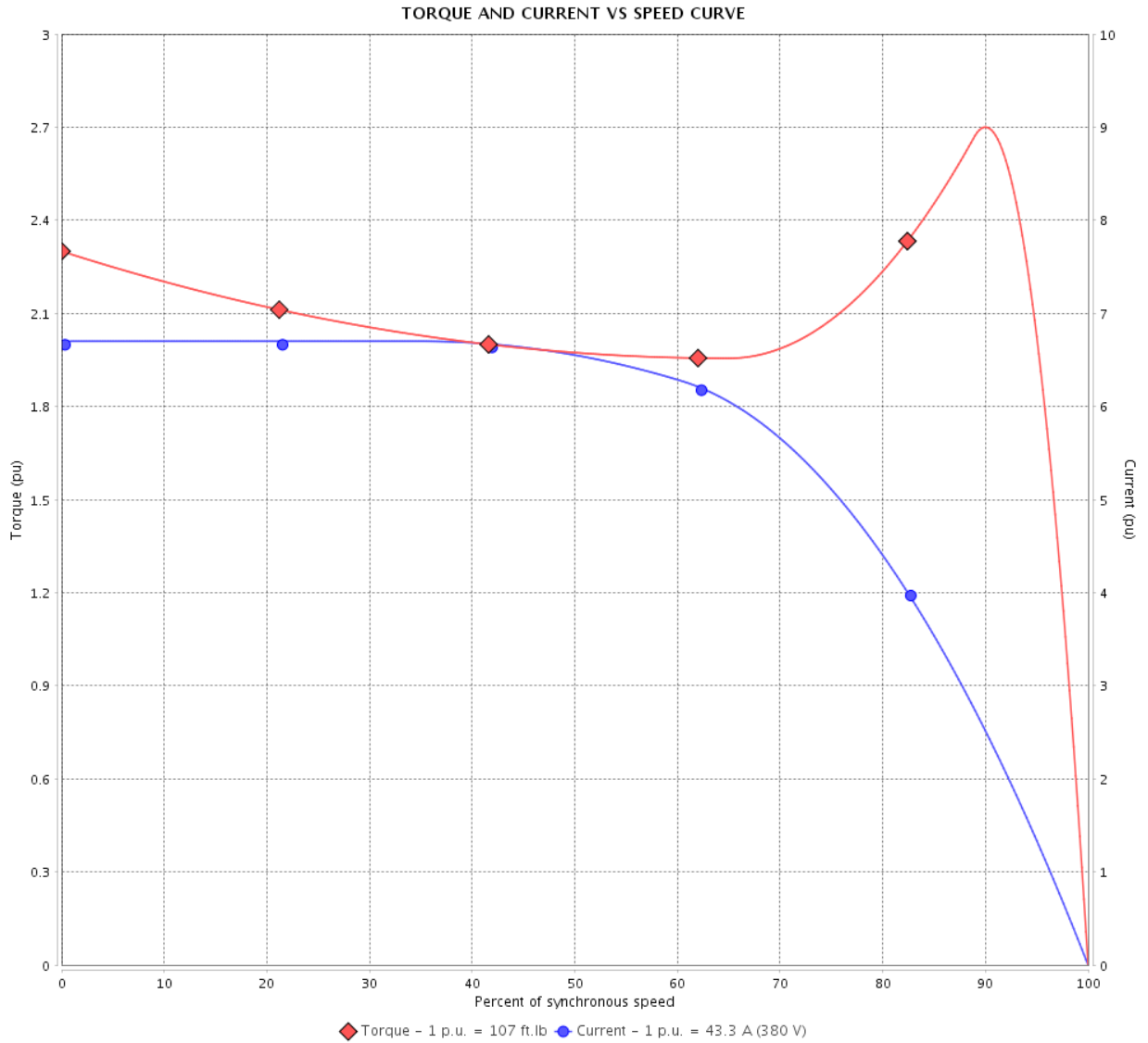

Performance : 380 V 50 Hz 4P IE3

Rated current	: 43.3 A	Moment of inertia (J)	: 5.69 sq.ft.lb
LRC	: 6.7	Duty cycle	: Cont.(S1)
Rated torque	: 107 ft.lb	Insulation class	: F
Locked rotor torque	: 229 %	Service factor	: 1.00
Breakdown torque	: 270 %	Temperature rise	: 80 K
Rated speed	: 1475 rpm	Design	: B

Locked rotor time : 30s (cold) 17s (hot)

Rev.	Changes Summary	Performed	Checked	Date
Performed by			Page 3 / 21	Revision
Checked by				
Date	12/04/2022			

# TORQUE AND CURRENT VS SPEED CURVE

## Three Phase Induction Motor - Squirrel Cage



Customer :

Product line : W40 NEMA Premium Efficiency  
Three-Phase

Product code : 14496819

Catalog # : 04018OT3E324TSC-W40

TORQUE AND CURRENT VS SPEED CURVE

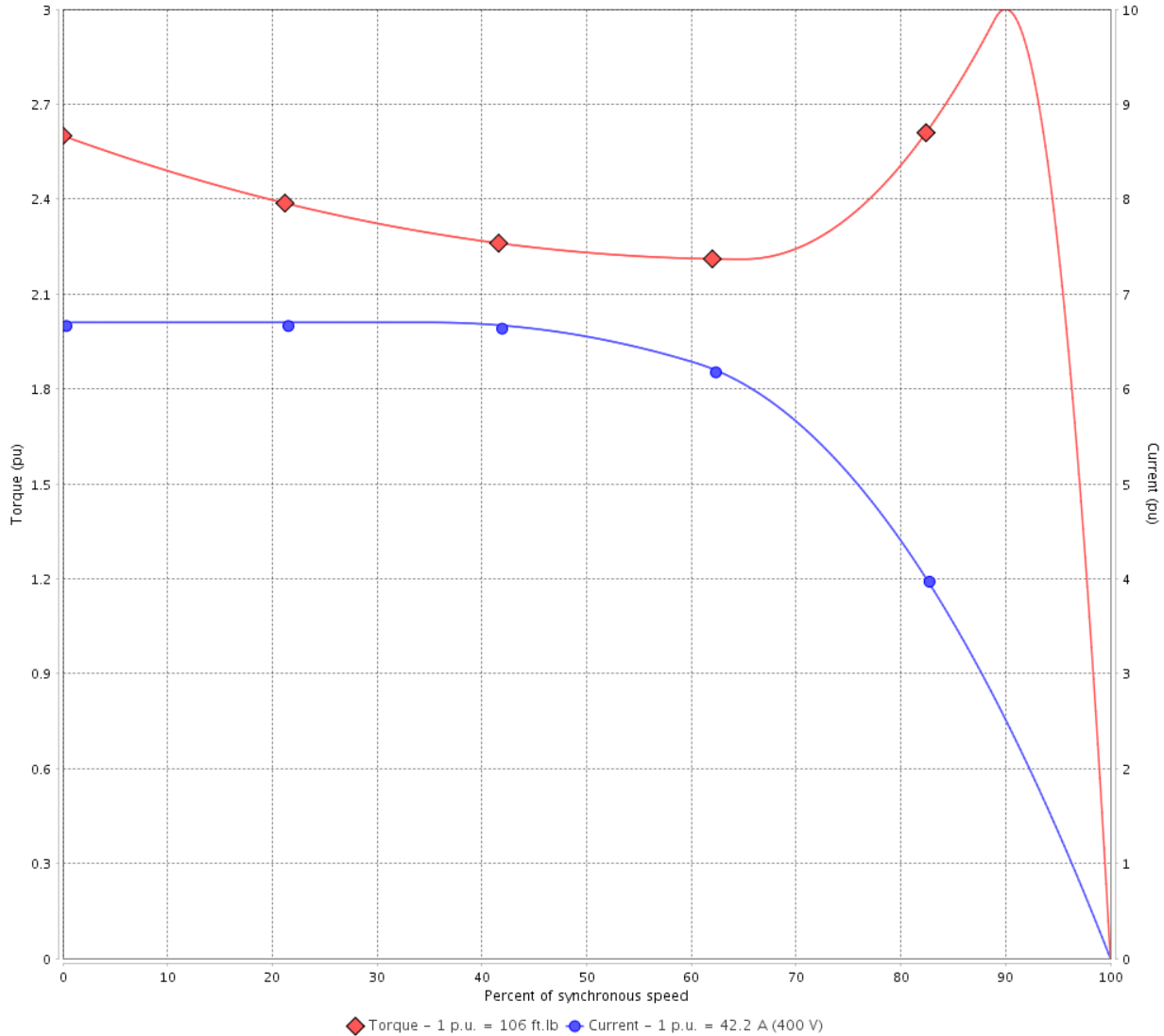

Performance : 400 V 50 Hz 4P IE3

Rated current	: 42.2 A	Moment of inertia (J)	: 5.69 sq.ft.lb
LRC	: 6.7	Duty cycle	: Cont.(S1)
Rated torque	: 106 ft.lb	Insulation class	: F
Locked rotor torque	: 260 %	Service factor	: 1.00
Breakdown torque	: 300 %	Temperature rise	: 80 K
Rated speed	: 1480 rpm	Design	: B

Locked rotor time : 30s (cold) 17s (hot)

Rev.	Changes Summary	Performed	Checked	Date
Performed by			Page 4 / 21	Revision
Checked by				
Date	12/04/2022			

# TORQUE AND CURRENT VS SPEED CURVE



## Three Phase Induction Motor - Squirrel Cage

Customer :

Product line : W40 NEMA Premium Efficiency  
Three-Phase

Product code : 14496819

Catalog # : 04018OT3E324TSC-W40

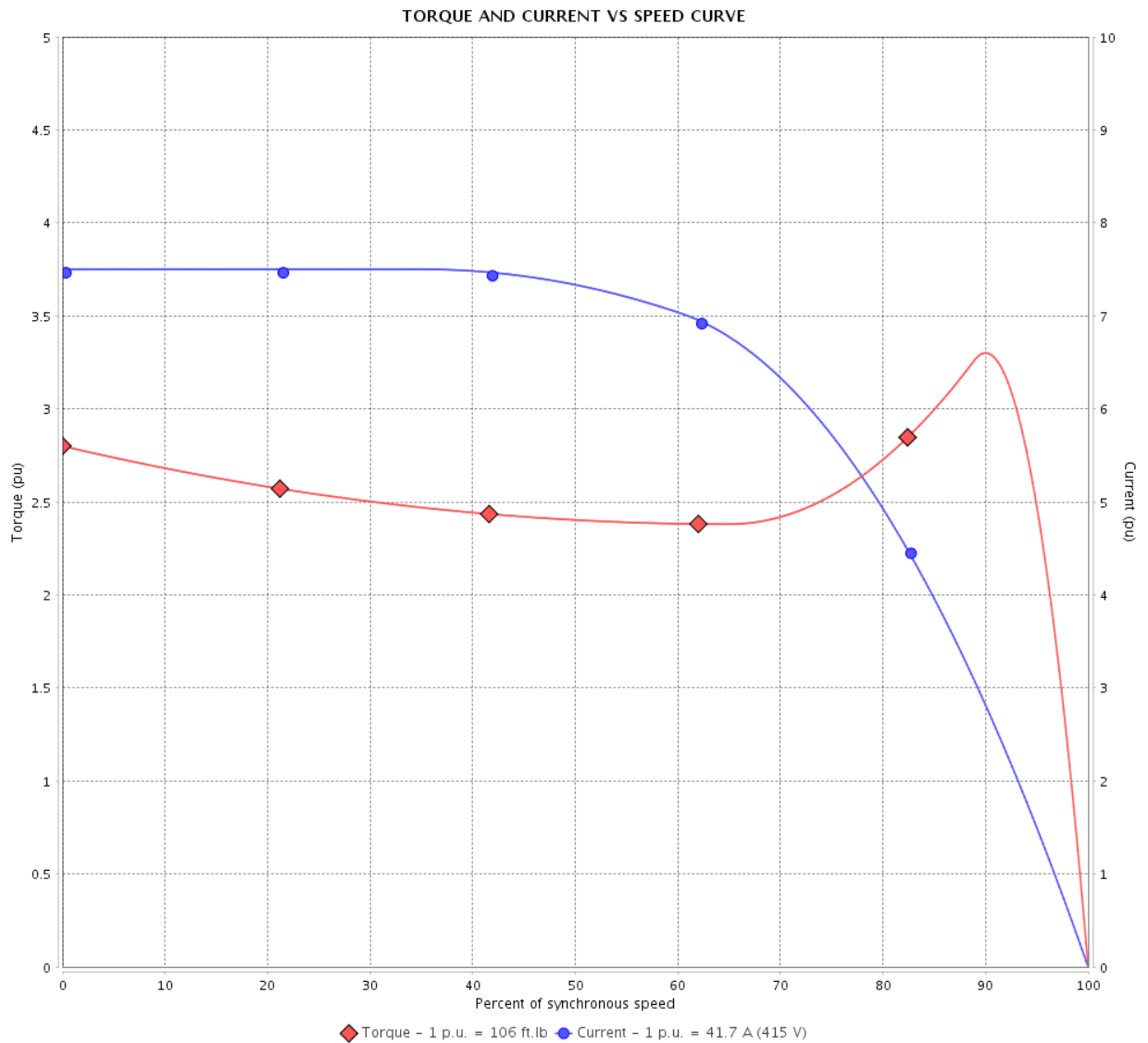

Performance : 415 V 50 Hz 4P IE3

Rated current	: 41.7 A	Moment of inertia (J)	: 5.69 sq.ft.lb
LRC	: 7.5	Duty cycle	: Cont.(S1)
Rated torque	: 106 ft.lb	Insulation class	: F
Locked rotor torque	: 280 %	Service factor	: 1.00
Breakdown torque	: 330 %	Temperature rise	: 80 K
Rated speed	: 1480 rpm	Design	: B

Locked rotor time : 25s (cold) 14s (hot)

Rev.	Changes Summary	Performed	Checked	Date
Performed by			Page	Revision
Checked by			5 / 21	
Date	12/04/2022			

# LOAD PERFORMANCE CURVE

Three Phase Induction Motor - Squirrel Cage



Customer :

Product line : W40 NEMA Premium Efficiency Three-Phase

Product code : 14496819

Catalog # : 04018OT3E324TSC-W40

LOAD PERFORMANCE CURVE

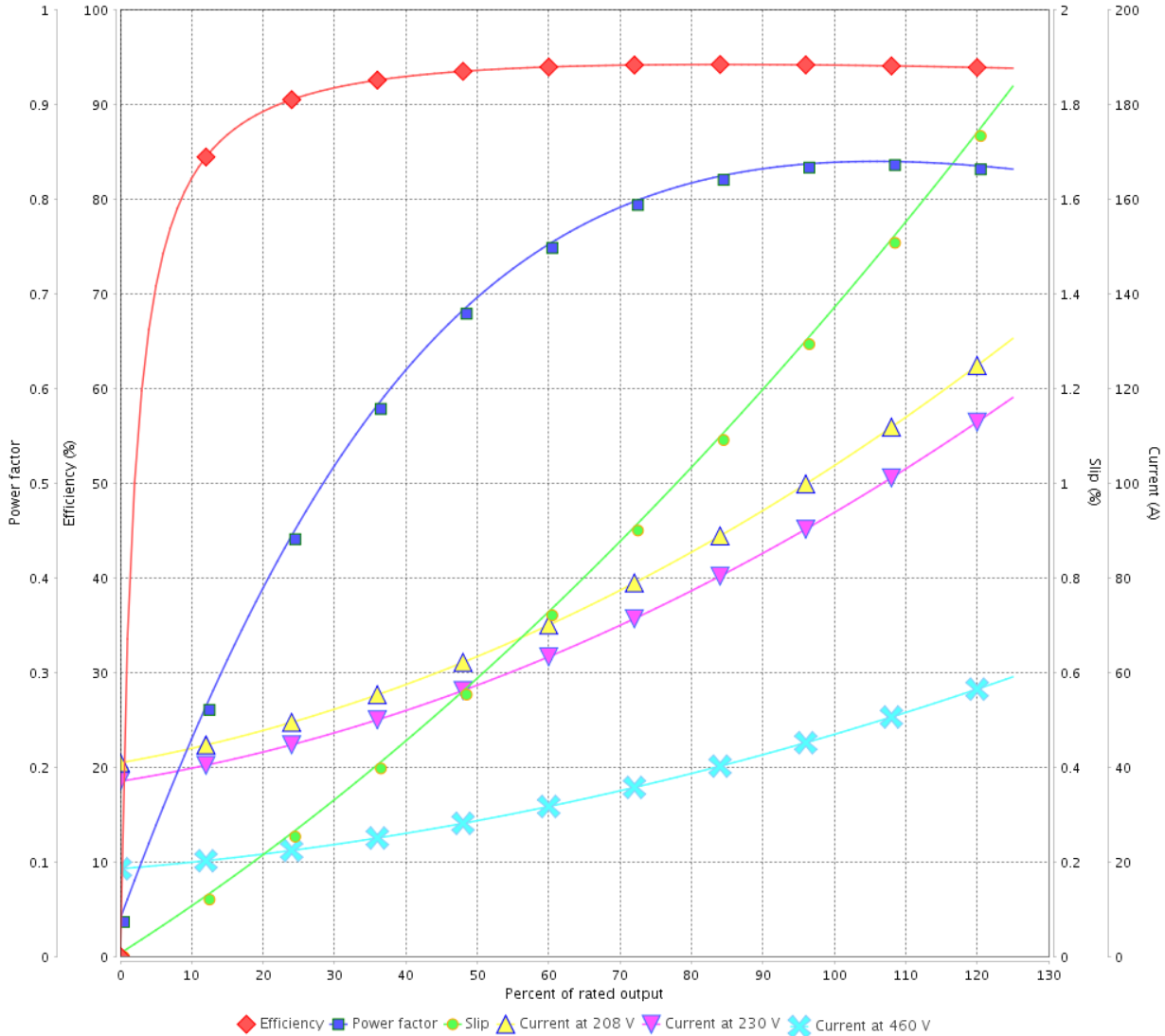

Performance : 230/460 V 60 Hz 4P

Rated current : 95.2/47.6 A  
 LRC : 6.2  
 Rated torque : 118 ft.lb  
 Locked rotor torque : 200 %  
 Breakdown torque : 240 %  
 Rated speed : 1775 rpm

Moment of inertia (J) : 5.69 sq.ft.lb  
 Duty cycle : Cont.(S1)  
 Insulation class : F  
 Service factor : 1.25  
 Temperature rise : 80 K  
 Design : B

Rev.	Changes Summary	Performed	Checked	Date
Performed by			Page	Revision
Checked by			6 / 21	
Date	12/04/2022			

# LOAD PERFORMANCE CURVE

## Three Phase Induction Motor - Squirrel Cage



Customer :

Product line : W40 NEMA Premium Efficiency Three-Phase

Product code : 14496819

Catalog # : 04018OT3E324TSC-W40

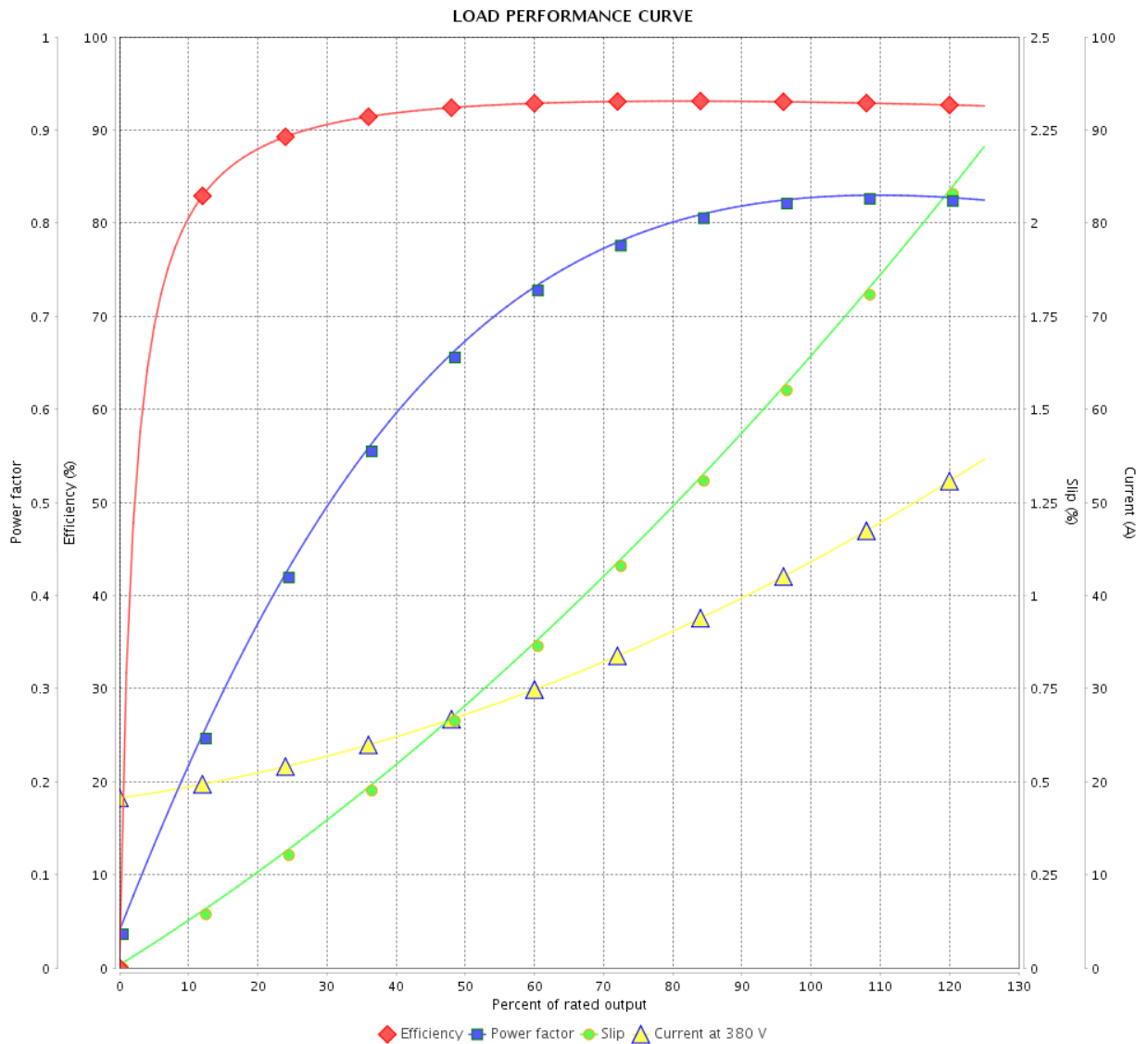

Performance : 380 V 50 Hz 4P IE3

Rated current : 43.3 A  
 LRC : 6.7  
 Rated torque : 107 ft.lb  
 Locked rotor torque : 229 %  
 Breakdown torque : 270 %  
 Rated speed : 1475 rpm

Moment of inertia (J) : 5.69 sq.ft.lb  
 Duty cycle : Cont.(S1)  
 Insulation class : F  
 Service factor : 1.00  
 Temperature rise : 80 K  
 Design : B

Rev.	Changes Summary	Performed	Checked	Date
Performed by			Page	Revision
Checked by				
Date				

# LOAD PERFORMANCE CURVE

Three Phase Induction Motor - Squirrel Cage



Customer :

Product line : W40 NEMA Premium Efficiency Three-Phase

Product code : 14496819

Catalog # : 04018OT3E324TSC-W40

LOAD PERFORMANCE CURVE

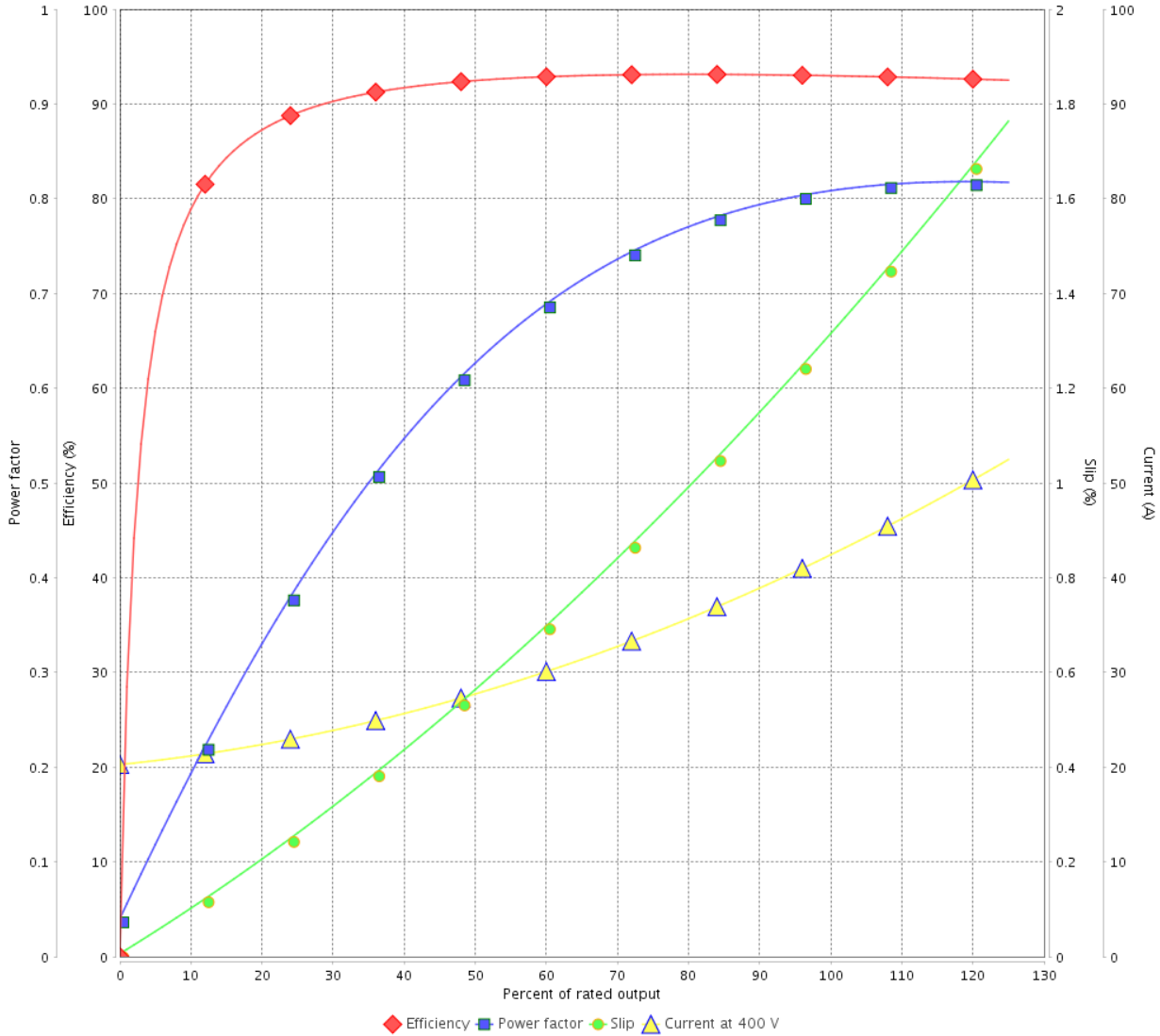

Performance : 400 V 50 Hz 4P IE3

Rated current : 42.2 A  
 LRC : 6.7  
 Rated torque : 106 ft.lb  
 Locked rotor torque : 260 %  
 Breakdown torque : 300 %  
 Rated speed : 1480 rpm

Moment of inertia (J) : 5.69 sq.ft.lb  
 Duty cycle : Cont.(S1)  
 Insulation class : F  
 Service factor : 1.00  
 Temperature rise : 80 K  
 Design : B

Rev.	Changes Summary	Performed	Checked	Date
Performed by			Page 8 / 21	Revision
Checked by				
Date	12/04/2022			



# LOAD PERFORMANCE CURVE

## Three Phase Induction Motor - Squirrel Cage



Customer :

Product line : W40 NEMA Premium Efficiency  
Three-Phase

Product code : 14496819

Catalog # : 04018OT3E324TSC-W40

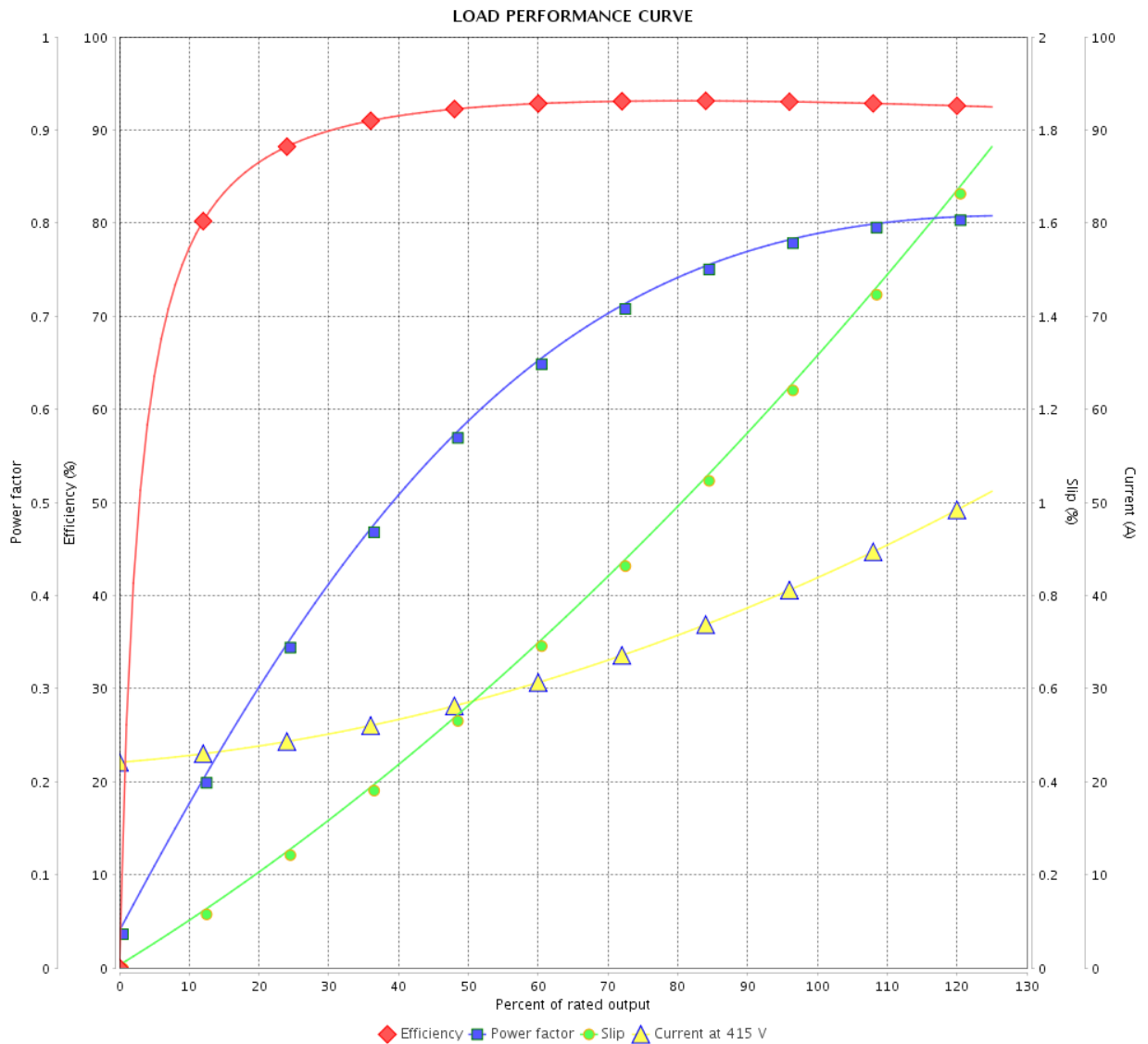

Performance : 415 V 50 Hz 4P IE3

Rated current : 41.7 A  
 LRC : 7.5  
 Rated torque : 106 ft.lb  
 Locked rotor torque : 280 %  
 Breakdown torque : 330 %  
 Rated speed : 1480 rpm

Moment of inertia (J) : 5.69 sq.ft.lb  
 Duty cycle : Cont.(S1)  
 Insulation class : F  
 Service factor : 1.00  
 Temperature rise : 80 K  
 Design : B

Rev.	Changes Summary	Performed	Checked	Date
Performed by			Page	Revision
Checked by				
Date				

# THERMAL LIMIT CURVE



## Three Phase Induction Motor - Squirrel Cage

Customer :

Product line : W40 NEMA Premium Efficiency  
Three-Phase

Product code : 14496819

Catalog # : 04018OT3E324TSC-W40

Performance : 230/460 V 60 Hz 4P

Rated current : 95.2/47.6 A  
LRC : 6.2  
Rated torque : 118 ft.lb  
Locked rotor torque : 200 %  
Breakdown torque : 240 %  
Rated speed : 1775 rpm

Moment of inertia (J) : 5.69 sq.ft.lb  
Duty cycle : Cont.(S1)  
Insulation class : F  
Service factor : 1.25  
Temperature rise : 80 K  
Design : B

Heating constant

Cooling constant

Rev.	Changes Summary	Performed	Checked	Date
Performed by				
Checked by			Page	Revision
Date	12/04/2022		10 / 21	

# THERMAL LIMIT CURVE

Three Phase Induction Motor - Squirrel Cage



Customer : \_\_\_\_\_

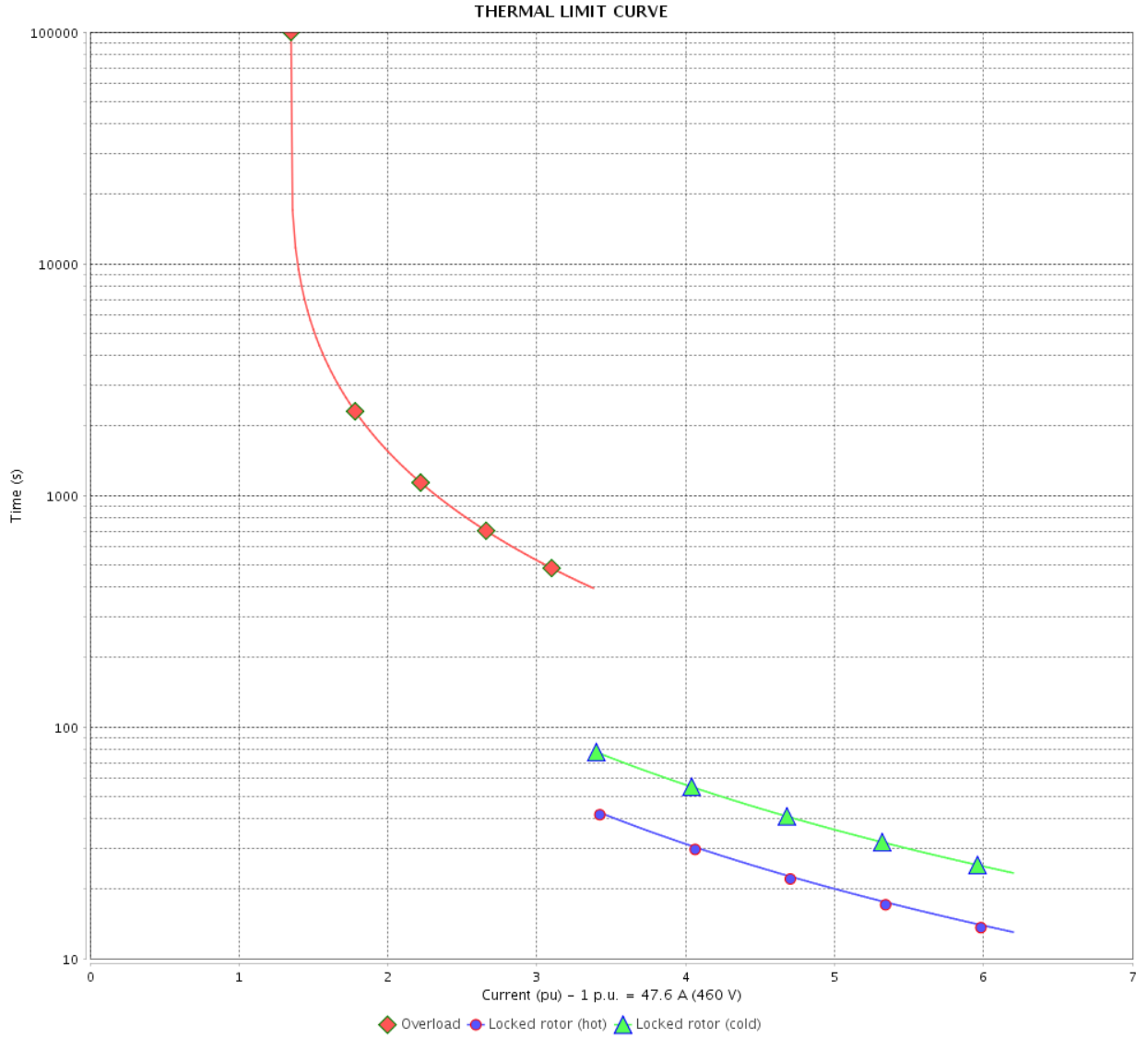

Rev.	Changes Summary	Performed	Checked	Date
Performed by		Page		Revision
Checked by		11 / 21		
Date		12/04/2022		

# THERMAL LIMIT CURVE



## Three Phase Induction Motor - Squirrel Cage

Customer :

Product line : W40 NEMA Premium Efficiency  
Three-Phase

Product code : 14496819

Catalog # : 04018OT3E324TSC-W40

Performance : 380 V 50 Hz 4P IE3

Rated current : 43.3 A	Moment of inertia (J) : 5.69 sq.ft.lb
LRC : 6.7	Duty cycle : Cont.(S1)
Rated torque : 107 ft.lb	Insulation class : F
Locked rotor torque : 229 %	Service factor : 1.00
Breakdown torque : 270 %	Temperature rise : 80 K
Rated speed : 1475 rpm	Design : B

Heating constant

Cooling constant

Rev.	Changes Summary	Performed	Checked	Date
Performed by			Page 12 / 21	Revision
Checked by				
Date	12/04/2022			

# THERMAL LIMIT CURVE

Three Phase Induction Motor - Squirrel Cage



Customer : \_\_\_\_\_

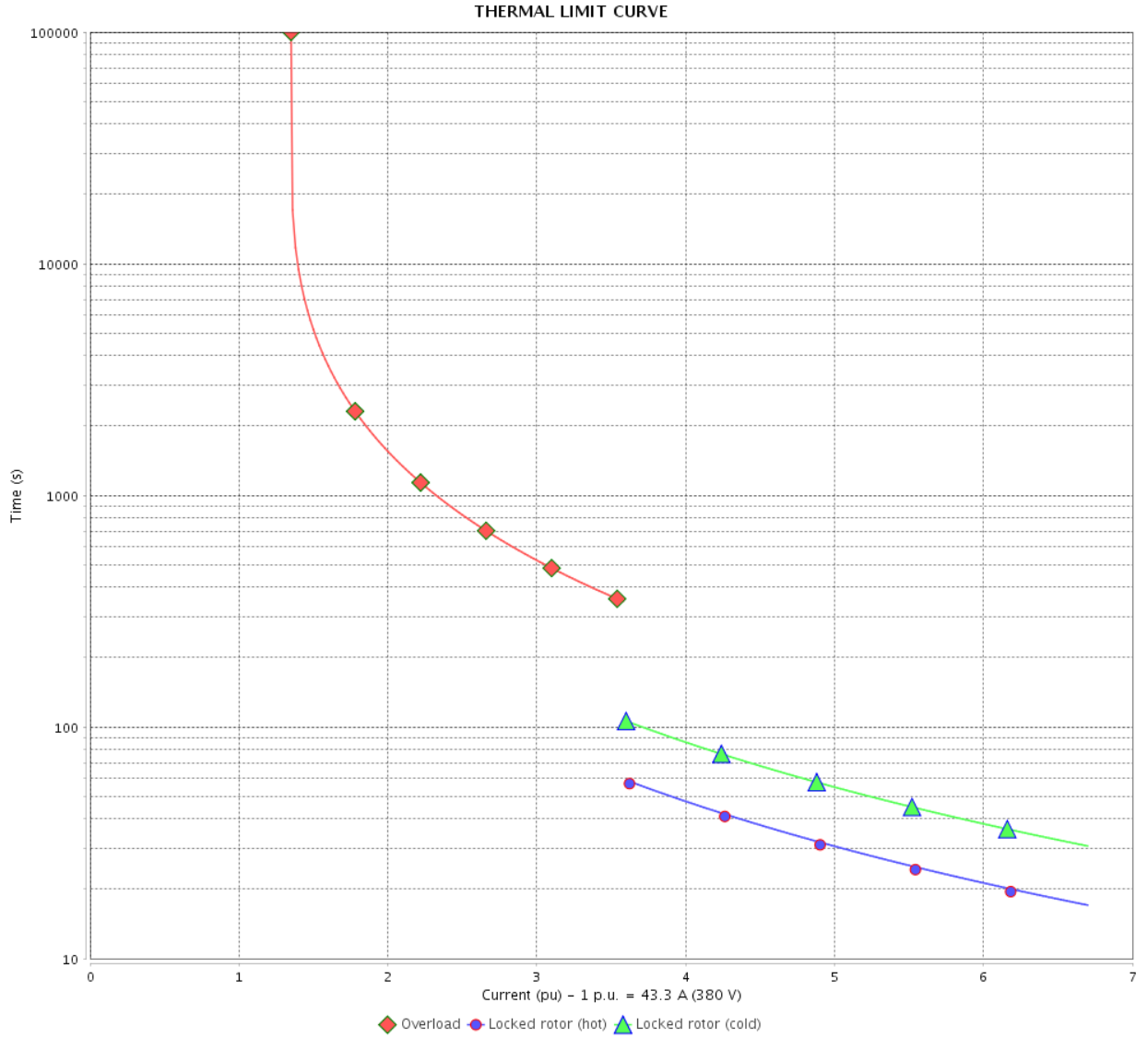

Rev.	Changes Summary	Performed	Checked	Date
Performed by		Page		Revision
Checked by		13 / 21		
Date		12/04/2022		

# THERMAL LIMIT CURVE



## Three Phase Induction Motor - Squirrel Cage

Customer :

Product line : W40 NEMA Premium Efficiency  
Three-Phase

Product code : 14496819

Catalog # : 04018OT3E324TSC-W40

Performance : 400 V 50 Hz 4P IE3

Rated current : 42.2 A	Moment of inertia (J) : 5.69 sq.ft.lb
LRC : 6.7	Duty cycle : Cont.(S1)
Rated torque : 106 ft.lb	Insulation class : F
Locked rotor torque : 260 %	Service factor : 1.00
Breakdown torque : 300 %	Temperature rise : 80 K
Rated speed : 1480 rpm	Design : B

Heating constant

Cooling constant

Rev.	Changes Summary	Performed	Checked	Date
Performed by			Page 14 / 21	Revision
Checked by				
Date	12/04/2022			

# THERMAL LIMIT CURVE

Three Phase Induction Motor - Squirrel Cage



Customer : \_\_\_\_\_

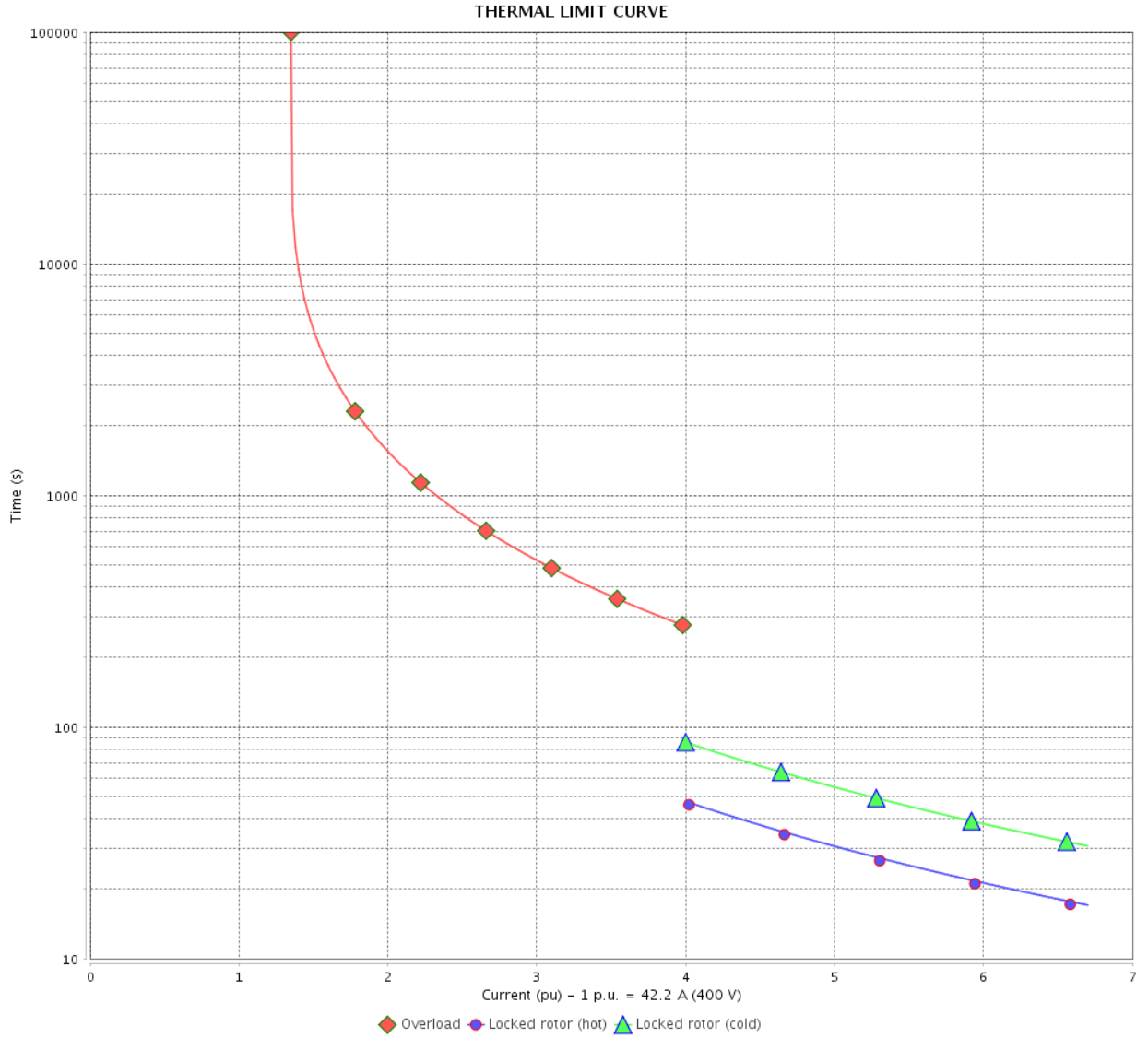

Rev.	Changes Summary	Performed	Checked	Date
Performed by		Page		Revision
Checked by		15 / 21		
Date		12/04/2022		

# THERMAL LIMIT CURVE

## Three Phase Induction Motor - Squirrel Cage



Customer :

Product line : W40 NEMA Premium Efficiency  
Three-Phase

Product code : 14496819

Catalog # : 04018OT3E324TSC-W40

Performance : 415 V 50 Hz 4P IE3

Rated current : 41.7 A	Moment of inertia (J) : 5.69 sq.ft.lb
LRC : 7.5	Duty cycle : Cont.(S1)
Rated torque : 106 ft.lb	Insulation class : F
Locked rotor torque : 280 %	Service factor : 1.00
Breakdown torque : 330 %	Temperature rise : 80 K
Rated speed : 1480 rpm	Design : B

Heating constant

Cooling constant

Rev.	Changes Summary	Performed	Checked	Date
Performed by			Page 16 / 21	Revision
Checked by				
Date	12/04/2022			



# THERMAL LIMIT CURVE

Three Phase Induction Motor - Squirrel Cage



Customer : \_\_\_\_\_

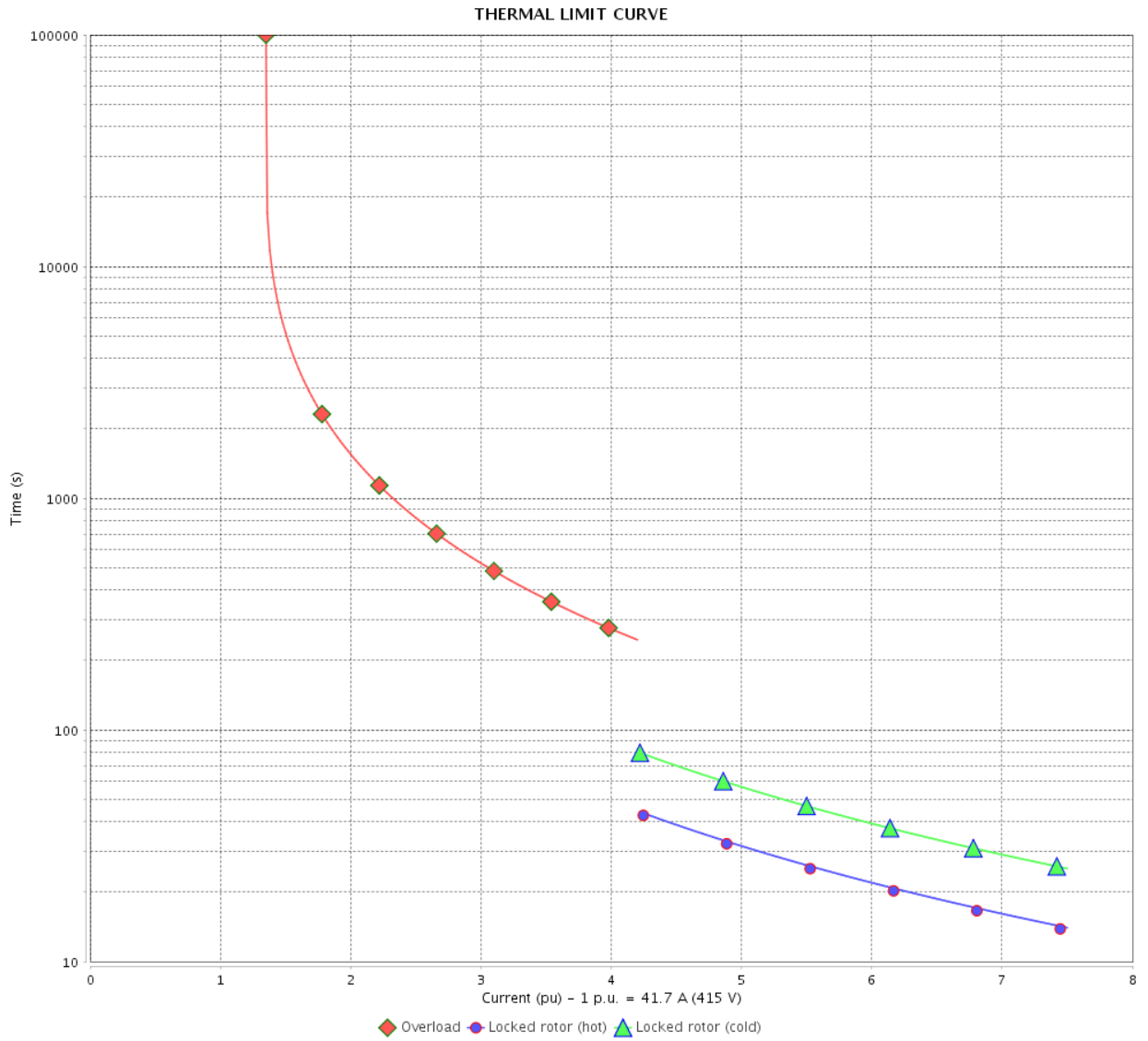

Rev.	Changes Summary	Performed	Checked	Date
Performed by		Page		Revision
Checked by				
Date				

# VFD OPERATION CURVE

Three Phase Induction Motor - Squirrel Cage



Customer :

Product line : W40 NEMA Premium Efficiency Three-Phase

Product code : 14496819

Catalog # : 04018OT3E324TSC-W40

VFD OPERATION CURVE

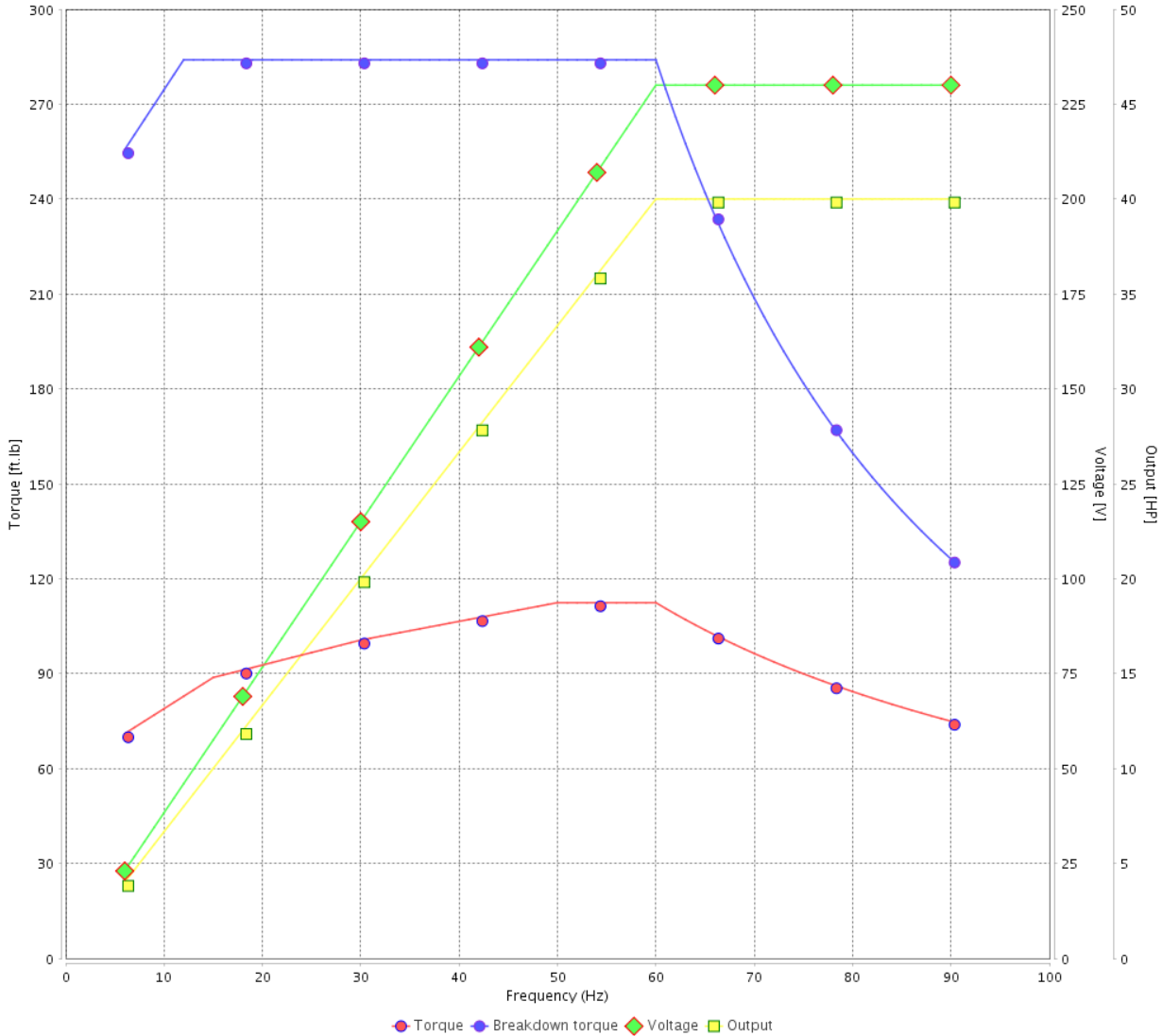

Performance : 230/460 V 60 Hz 4P

Rated current : 95.2/47.6 A  
 LRC : 6.2  
 Rated torque : 118 ft.lb  
 Locked rotor torque : 200 %  
 Breakdown torque : 240 %  
 Rated speed : 1775 rpm

Moment of inertia (J) : 5.69 sq.ft.lb  
 Duty cycle : Cont.(S1)  
 Insulation class : F  
 Service factor : 1.25  
 Temperature rise : 80 K  
 Design : B

Rev.	Changes Summary	Performed	Checked	Date
Performed by			Page 18 / 21	Revision
Checked by				
Date	12/04/2022			

# VFD OPERATION CURVE

Three Phase Induction Motor - Squirrel Cage



Customer :

Product line : W40 NEMA Premium Efficiency Three-Phase

Product code : 14496819

Catalog # : 04018OT3E324TSC-W40

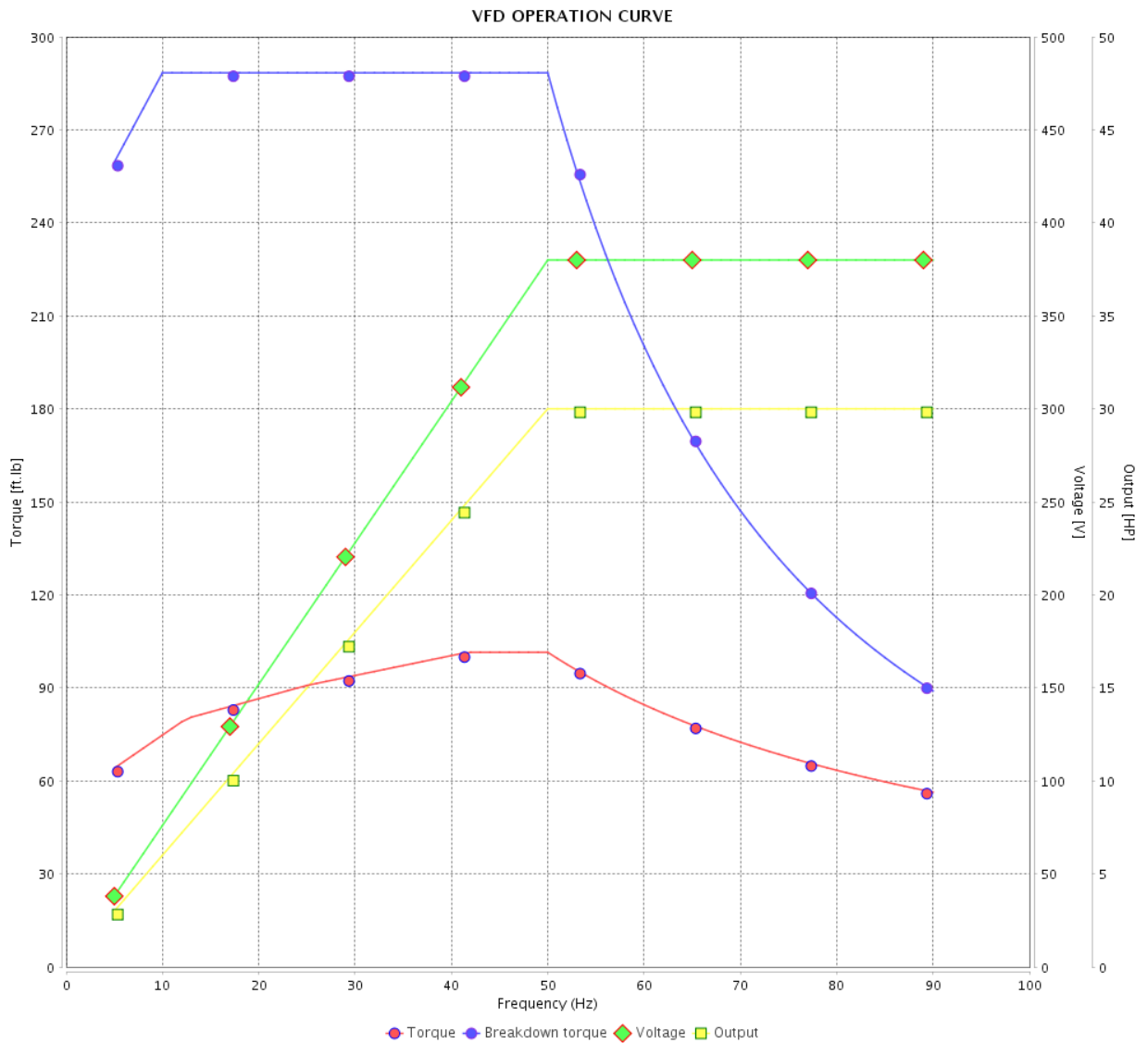

Performance : 380 V 50 Hz 4P IE3

Rated current : 43.3 A  
 LRC : 6.7  
 Rated torque : 107 ft.lb  
 Locked rotor torque : 229 %  
 Breakdown torque : 270 %  
 Rated speed : 1475 rpm

Moment of inertia (J) : 5.69 sq.ft.lb  
 Duty cycle : Cont.(S1)  
 Insulation class : F  
 Service factor : 1.00  
 Temperature rise : 80 K  
 Design : B

Rev.	Changes Summary	Performed	Checked	Date
Performed by			Page	Revision
Checked by			19 / 21	
Date	12/04/2022			

# VFD OPERATION CURVE

Three Phase Induction Motor - Squirrel Cage



Customer :

Product line : W40 NEMA Premium Efficiency  
Three-Phase

Product code : 14496819

Catalog # : 04018OT3E324TSC-W40

VFD OPERATION CURVE

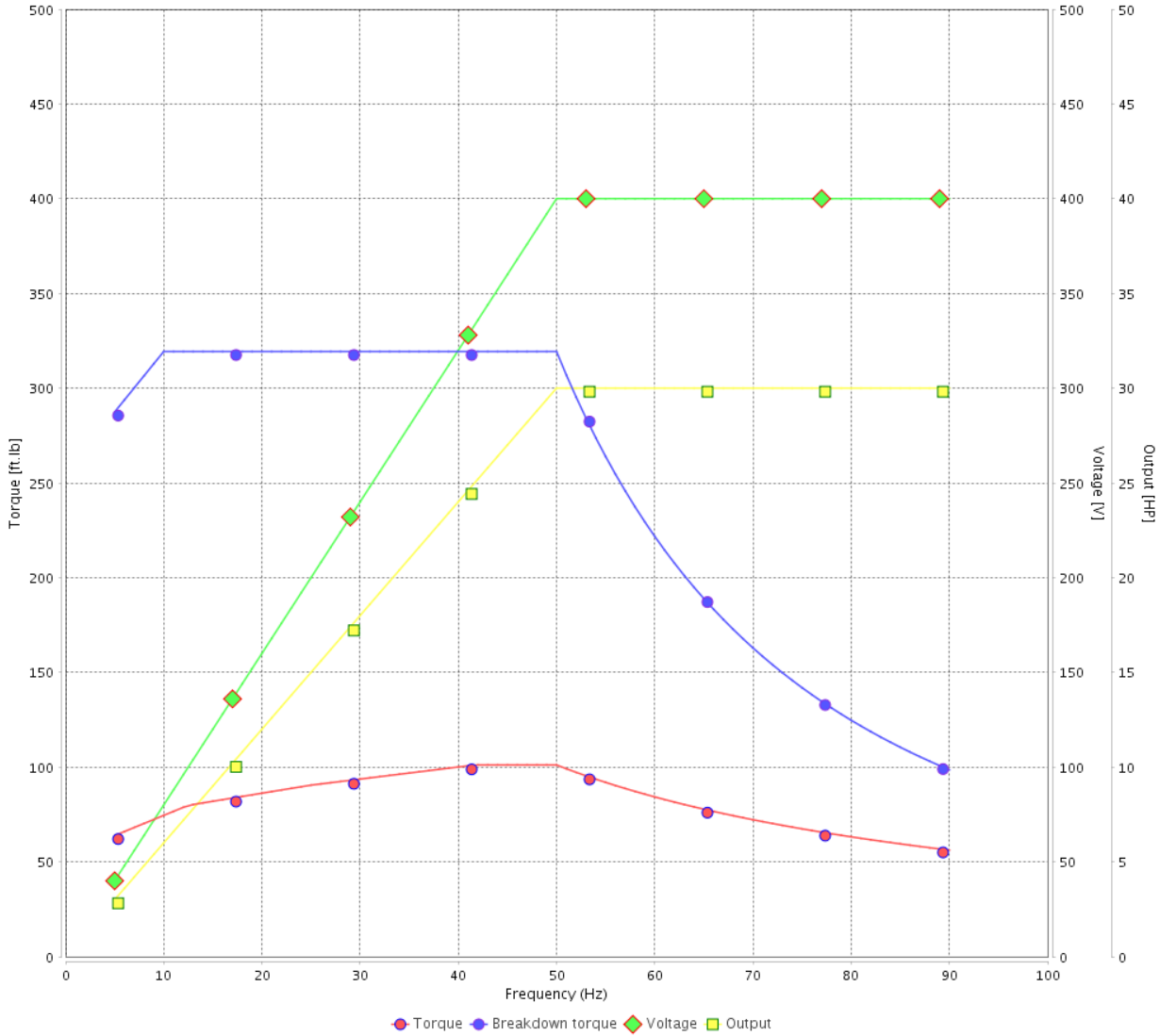

Performance : 400 V 50 Hz 4P IE3

Rated current : 42.2 A  
LRC : 6.7  
Rated torque : 106 ft.lb  
Locked rotor torque : 260 %  
Breakdown torque : 300 %  
Rated speed : 1480 rpm

Moment of inertia (J) : 5.69 sq.ft.lb  
Duty cycle : Cont.(S1)  
Insulation class : F  
Service factor : 1.00  
Temperature rise : 80 K  
Design : B

Rev.	Changes Summary	Performed	Checked	Date
Performed by			Page	Revision
Checked by				
Date				

# VFD OPERATION CURVE

Three Phase Induction Motor - Squirrel Cage



Customer :

Product line : W40 NEMA Premium Efficiency Three-Phase

Product code : 14496819

Catalog # : 04018OT3E324TSC-W40

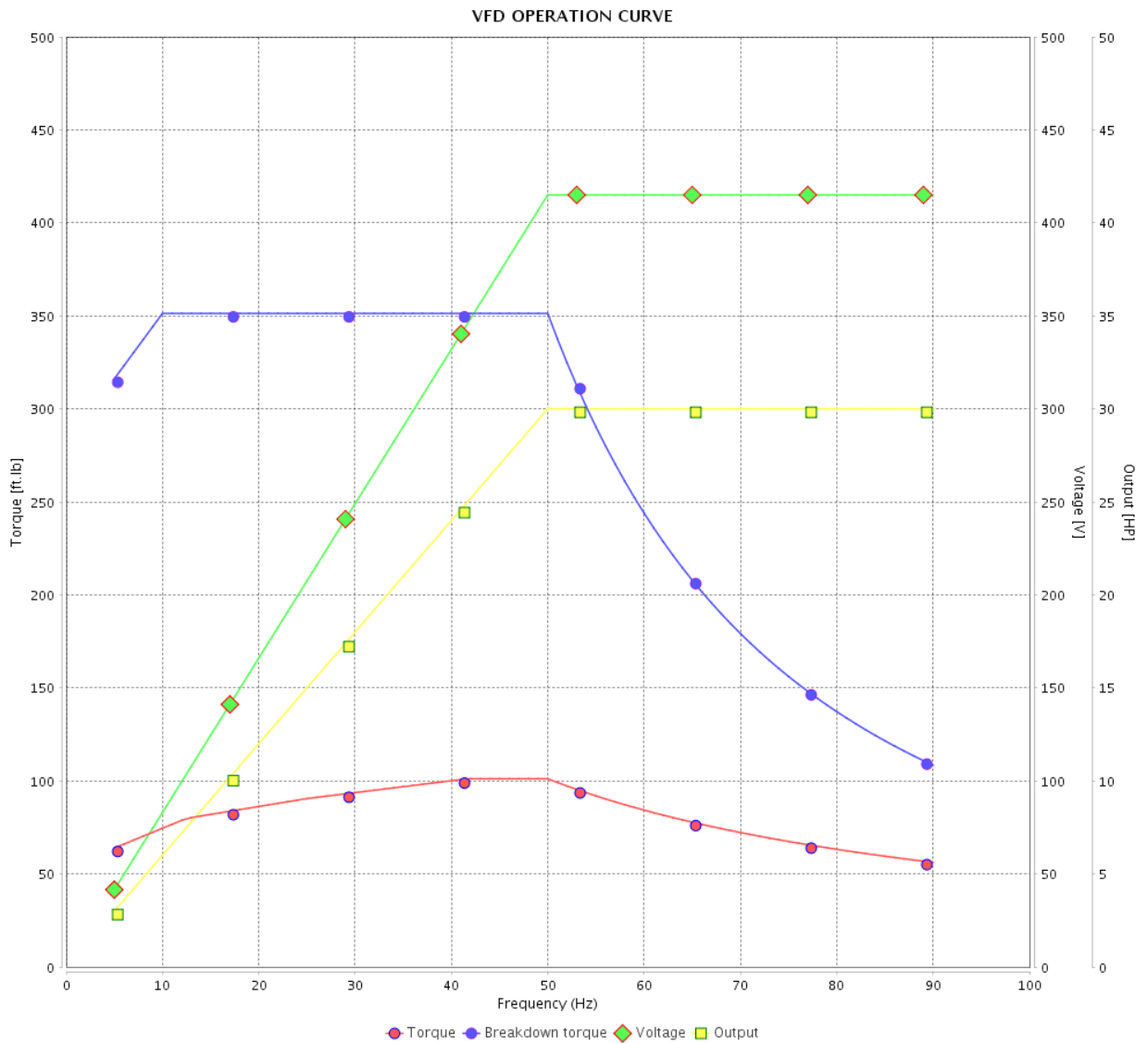

Performance : 415 V 50 Hz 4P IE3

Rated current : 41.7 A  
 LRC : 7.5  
 Rated torque : 106 ft.lb  
 Locked rotor torque : 280 %  
 Breakdown torque : 330 %  
 Rated speed : 1480 rpm

Moment of inertia (J) : 5.69 sq.ft.lb  
 Duty cycle : Cont.(S1)  
 Insulation class : F  
 Service factor : 1.00  
 Temperature rise : 80 K  
 Design : B

Rev.	Changes Summary	Performed	Checked	Date
Performed by		Page		Revision
Checked by		21 / 21		
Date	12/04/2022			

1 2 3 4 5 6

A

B

C

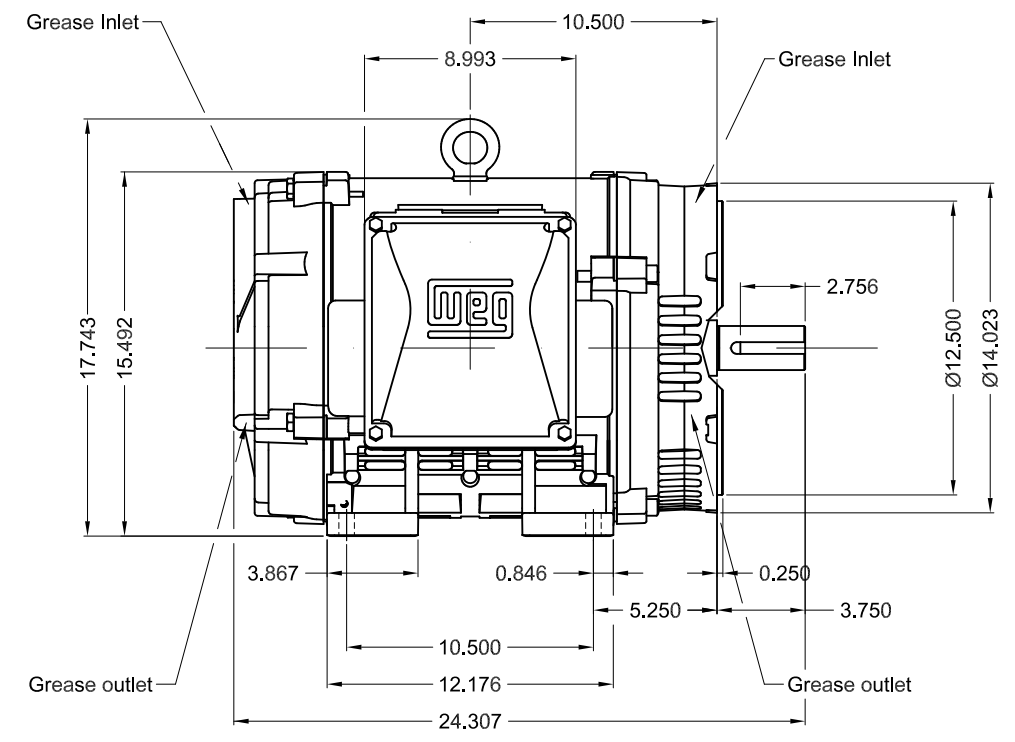
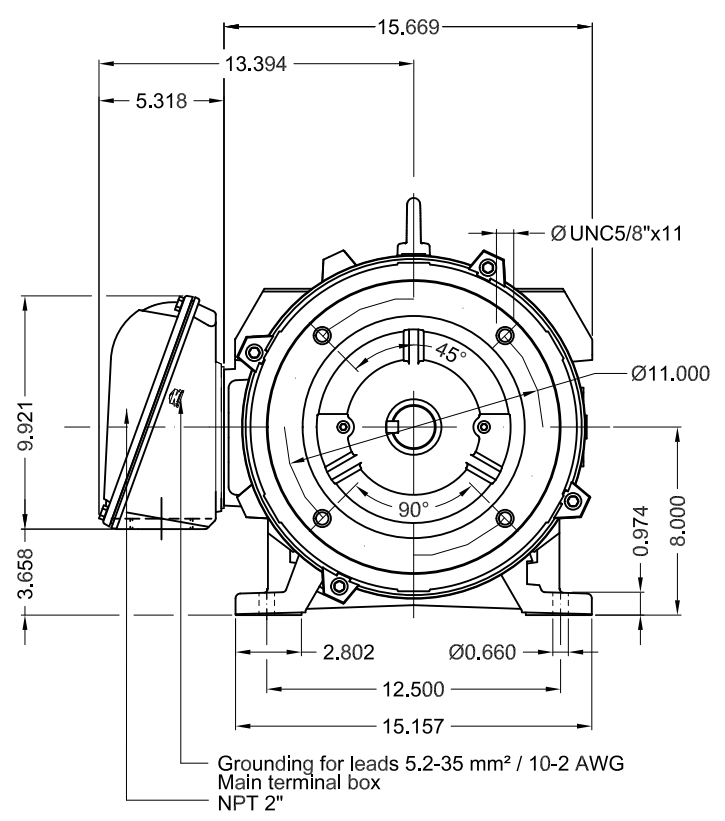

D

E

TS shaft end
Color RAL 5009
Painting plan 203A
Mounting NEMA F-1
Mounting B34R(D)

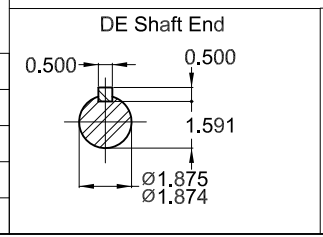

40 HP 04 Poles 60 Hz A

1:8

ECM	LOC	SUMMARY OF MODIFICATIONS	EXECUTED	CHECKED	RELEASED	DATE	VER
EXECUTED	PIRWBUSER	THREE PH. MOTOR W40 PREM. EFF.					
CHECKED		FRAME 324TSC IP23 ODP					
RELEASED							
REL DT.	WMO	Jaragua do Sul	Product Engineering	SHEET	1 / 1		

PREVIEW  
WDD

