

DATA SHEET

Three Phase Induction Motor - Squirrel Cage



Customer							
Product line	: NEMA Premium Efficiency Three-Phase	Product code	: 12447815				
		Catalog #	: 04036ST3QIE324TS-W22				
Frame	: 324/6TS	Cooling method	: IC411 - TEFC				
Insulation class	: F	Mounting	: F-1				
Duty cycle	: Cont.(S1)	Rotation ¹	: Both (CW and CCW)				
Ambient temperature	: -20°C to +40°C	Starting method	: Direct On Line				
Altitude	: 1000 m.a.s.l.	Approx. weight ²	: 535 lb				
Protection degree	: IP55	Moment of inertia (J)	: 4.90 sq.ft.lb				
Design	: B						
Output [HP]	40	30	30	30	40	40	40
Poles	2	2	2	2	2	2	2
Frequency [Hz]	60	50	50	50	50	50	50
Rated voltage [V]	460	380	400	415	380	400	415
Rated current [A]	46.3	41.0	39.4	38.4	56.9	53.7	51.7
L. R. Amperes [A]	292	295	296	292	285	301	321
LRC [A]	6.3x(Code G)	7.2x(Code H)	7.5x(Code H)	7.6x(Code H)	5.0x(Code E)	5.6x(Code F)	6.2x(Code G)
No load current [A]	11.0	12.0	11.0	12.0	10.0	11.0	12.0
Rated speed [RPM]	3555	2960	2965	2970	2930	2940	2950
Slip [%]	1.25	1.33	1.17	1.00	2.33	2.00	1.67
Rated torque [ft.lb]	59.1	53.2	53.1	53.0	71.7	71.4	71.2
Locked rotor torque [%]	250	240	270	290	180	200	220
Breakdown torque [%]	240	250	280	310	200	210	229
Service factor	1.25	1.00	1.00	1.00	1.00	1.00	1.00
Temperature rise	80 K	80 K	80 K	80 K	105 K	105 K	105 K
Locked rotor time	81s (cold) 45s (hot)	100s (cold) 56s (hot)	93s (cold) 52s (hot)	90s (cold) 50s (hot)	27s (cold) 15s (hot)	59s (cold) 33s (hot)	59s (cold) 33s (hot)
Noise level ²	76.0 dB(A)	72.0 dB(A)	72.0 dB(A)	72.0 dB(A)	72.0 dB(A)	72.0 dB(A)	72.0 dB(A)
Efficiency (%)	25%						
	50%	91.7	90.9	90.3	90.7	91.7	91.7
	75%	92.4	91.8	91.7	92.1	91.7	91.7
	100%	92.4	92.7	92.7	92.7	91.0	91.7
Power Factor	25%						
	50%	0.80	0.77	0.75	0.73	0.84	0.82
	75%	0.86	0.85	0.83	0.82	0.88	0.87
	100%	0.88	0.88	0.87	0.86	0.88	0.88
Bearing type	: 6312 C3	6212 C3	Foundation loads				
Sealing	: Inpro/Seal	Inpro/Seal	Max. traction	: 361 lb			
Lubrication interval	: 12000 h	15000 h	Max. compression	: 896 lb			
Lubricant amount	: 21 g	13 g					
Lubricant type	: Mobil Polyrex EM						
Notes							
This revision replaces and cancel the previous one, which must be eliminated. (1) Looking the motor from the shaft end. (2) Measured at 1m and with tolerance of +3dB(A). (3) Approximate weight subject to changes after manufacturing process. (4) At 100% of full load.				These are average values based on tests with sinusoidal power supply, subject to the tolerances stipulated in NEMA MG-1.			
Rev.	Changes Summary			Performed	Checked	Date	
Performed by							
Checked by					Page	Revision	
Date	12/04/2022				1 / 36		

TORQUE AND CURRENT VS SPEED CURVE

Three Phase Induction Motor - Squirrel Cage



Customer :

Product line : NEMA Premium Efficiency Three-Phase

Product code : 12447815

Catalog # : 04036ST3QIE324TS-W22

TORQUE AND CURRENT VS SPEED CURVE

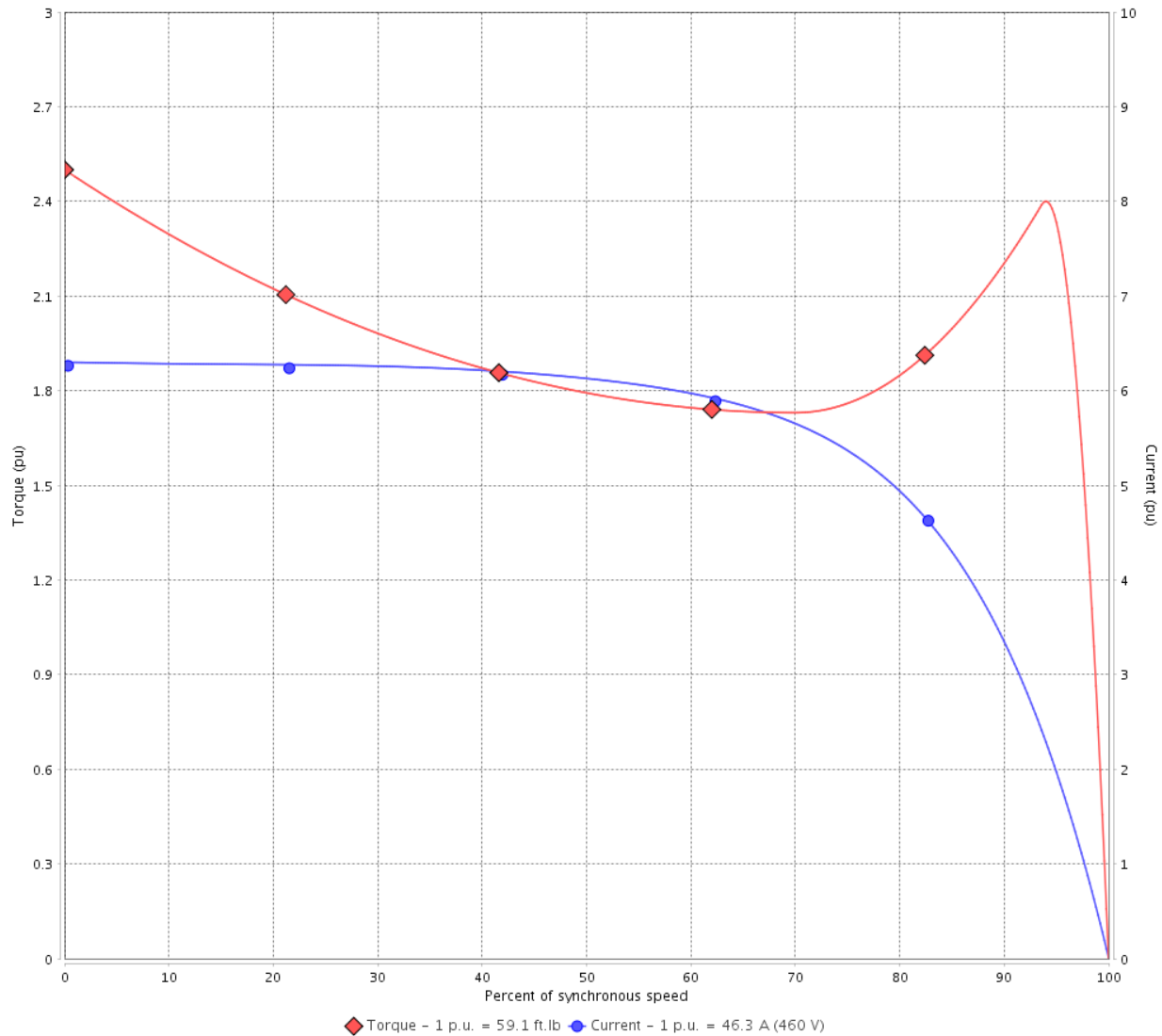

Performance : 460 V 60 Hz 2P

Rated current	: 46.3 A	Moment of inertia (J)	: 4.90 sq.ft.lb
LRC	: 6.3	Duty cycle	: Cont.(S1)
Rated torque	: 59.1 ft.lb	Insulation class	: F
Locked rotor torque	: 250 %	Service factor	: 1.25
Breakdown torque	: 240 %	Temperature rise	: 80 K
Rated speed	: 3555 rpm	Design	: B

Locked rotor time : 81s (cold) 45s (hot)

Rev.	Changes Summary	Performed	Checked	Date
Performed by			Page 2 / 36	Revision
Checked by				
Date	12/04/2022			

TORQUE AND CURRENT VS SPEED CURVE



Three Phase Induction Motor - Squirrel Cage

Customer :

Product line : NEMA Premium Efficiency Three-Phase

Product code : 12447815

Catalog # : 04036ST3QIE324TS-W22

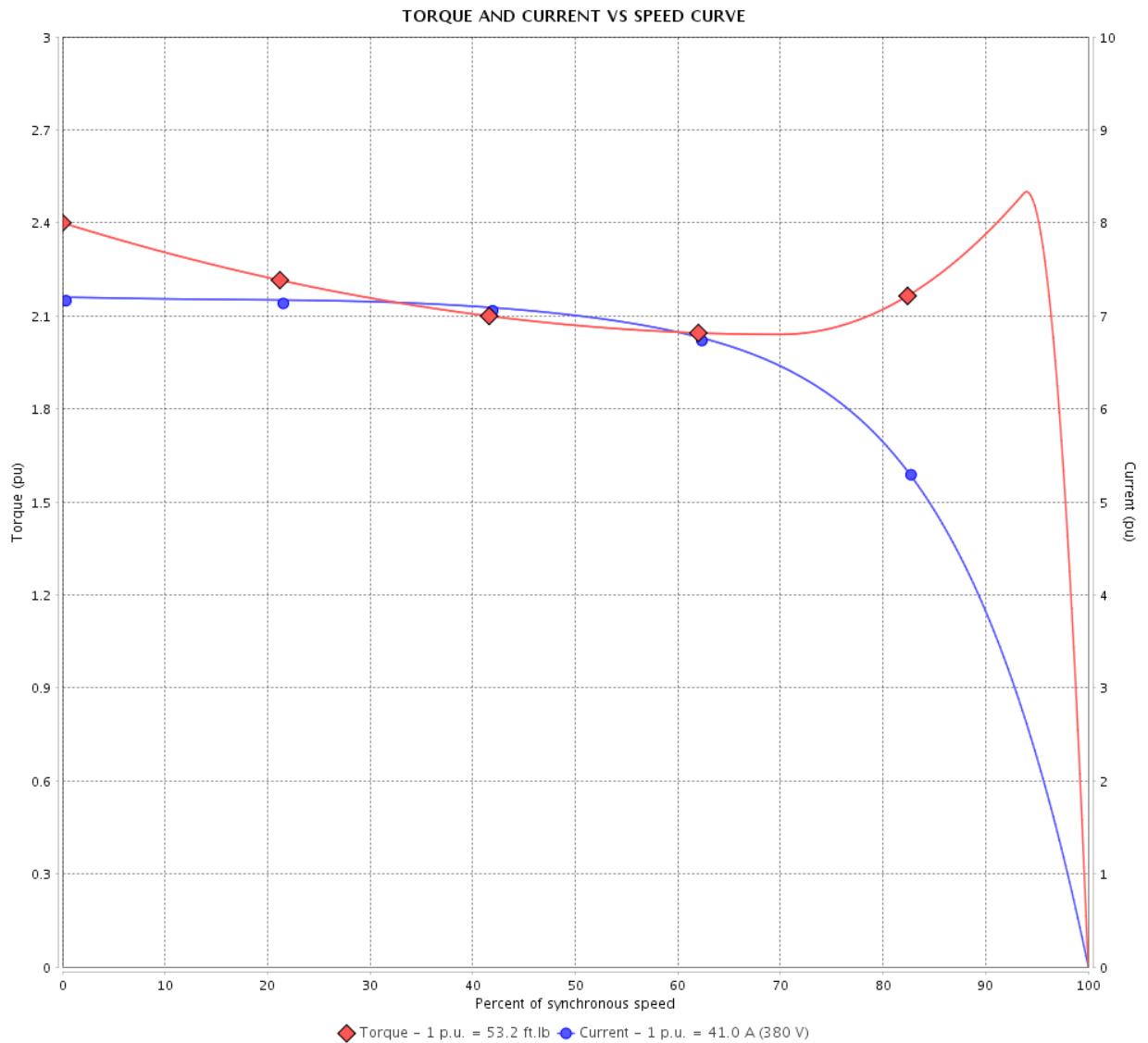

Performance : 380 V 50 Hz 2P IE3

Rated current	: 41.0 A	Moment of inertia (J)	: 4.90 sq.ft.lb
LRC	: 7.2	Duty cycle	: Cont.(S1)
Rated torque	: 53.2 ft.lb	Insulation class	: F
Locked rotor torque	: 240 %	Service factor	: 1.00
Breakdown torque	: 250 %	Temperature rise	: 80 K
Rated speed	: 2960 rpm	Design	: B

Locked rotor time : 100s (cold) 56s (hot)

Rev.	Changes Summary	Performed	Checked	Date
Performed by			Page 3 / 36	Revision
Checked by				
Date	12/04/2022			

TORQUE AND CURRENT VS SPEED CURVE

Three Phase Induction Motor - Squirrel Cage



Customer :

Product line : NEMA Premium Efficiency Three-Phase

Product code : 12447815

Catalog # : 04036ST3QIE324TS-W22

TORQUE AND CURRENT VS SPEED CURVE

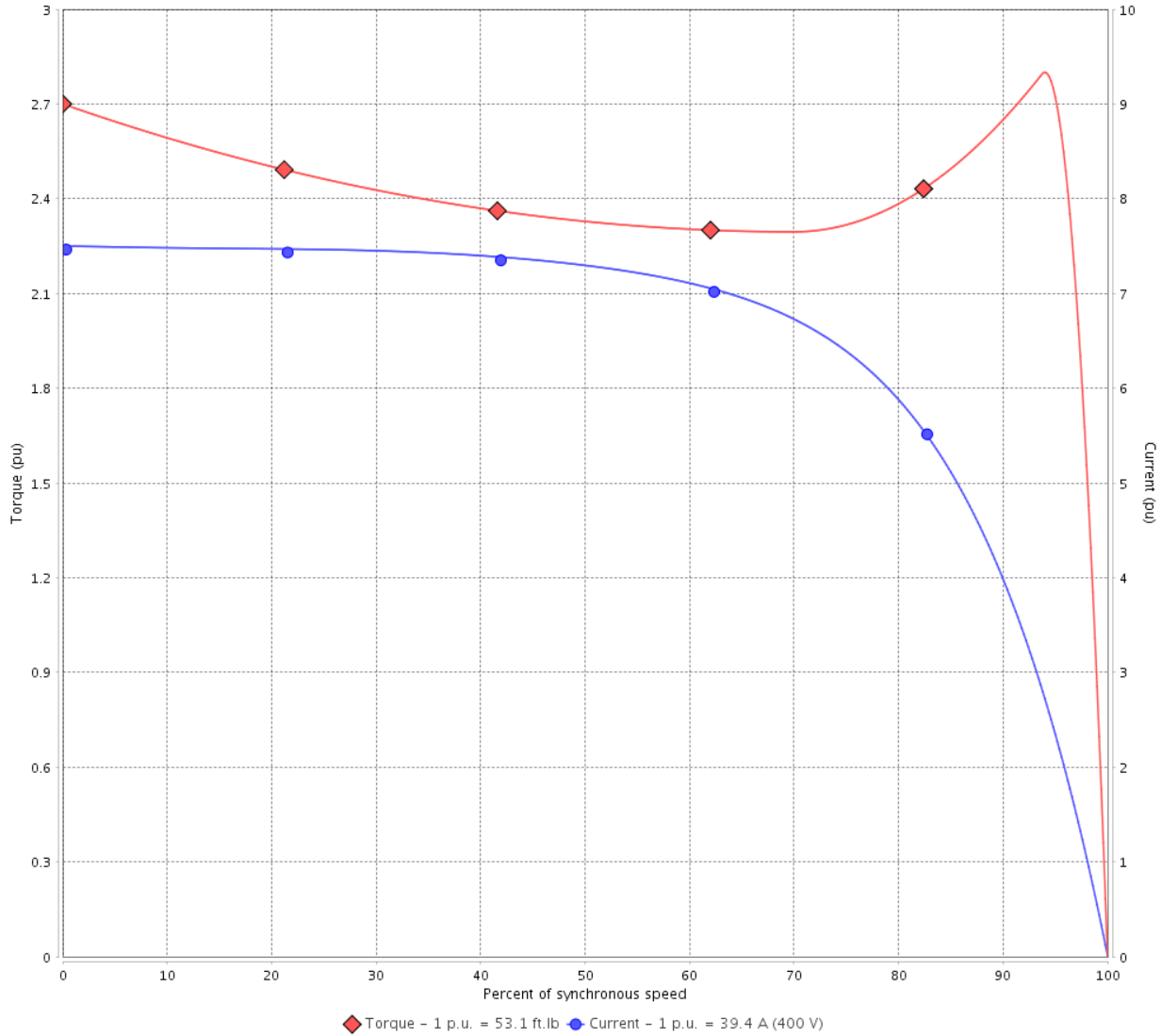

Performance : 400 V 50 Hz 2P IE3

Rated current	: 39.4 A	Moment of inertia (J)	: 4.90 sq.ft.lb
LRC	: 7.5	Duty cycle	: Cont.(S1)
Rated torque	: 53.1 ft.lb	Insulation class	: F
Locked rotor torque	: 270 %	Service factor	: 1.00
Breakdown torque	: 280 %	Temperature rise	: 80 K
Rated speed	: 2965 rpm	Design	: B

Locked rotor time : 93s (cold) 52s (hot)

Rev.	Changes Summary	Performed	Checked	Date
Performed by			Page 4 / 36	Revision
Checked by				
Date	12/04/2022			

TORQUE AND CURRENT VS SPEED CURVE



Three Phase Induction Motor - Squirrel Cage

Customer :

Product line : NEMA Premium Efficiency Three-Phase

Product code : 12447815

Catalog # : 04036ST3QIE324TS-W22

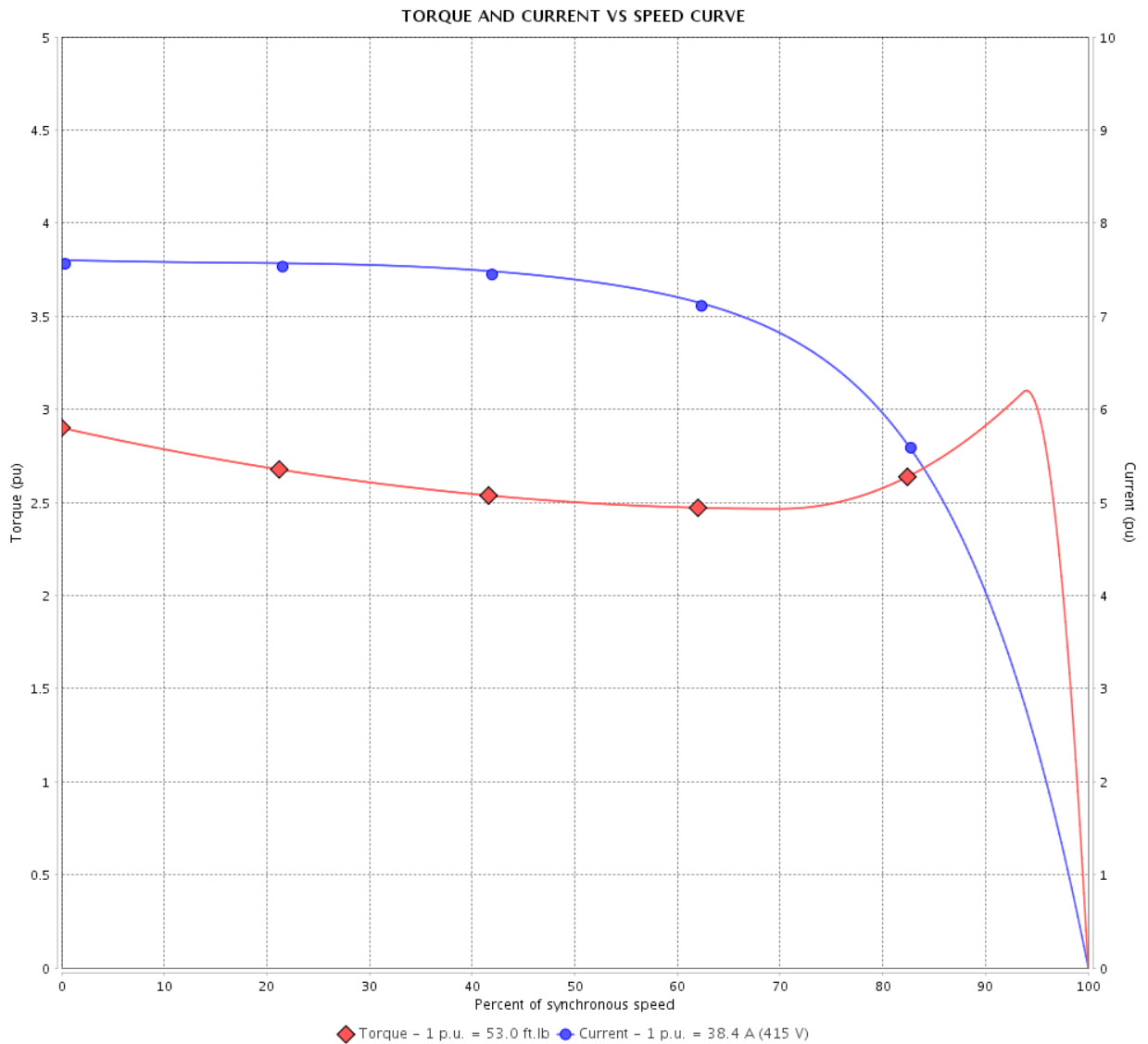

Performance : 415 V 50 Hz 2P IE3

Rated current	: 38.4 A	Moment of inertia (J)	: 4.90 sq.ft.lb
LRC	: 7.6	Duty cycle	: Cont.(S1)
Rated torque	: 53.0 ft.lb	Insulation class	: F
Locked rotor torque	: 290 %	Service factor	: 1.00
Breakdown torque	: 310 %	Temperature rise	: 80 K
Rated speed	: 2970 rpm	Design	: B

Locked rotor time : 90s (cold) 50s (hot)

Rev.	Changes Summary	Performed	Checked	Date
Performed by			Page 5 / 36	Revision
Checked by				
Date	12/04/2022			

TORQUE AND CURRENT VS SPEED CURVE

Three Phase Induction Motor - Squirrel Cage



Customer :

Product line : NEMA Premium Efficiency Three-Phase

Product code : 12447815

Catalog # : 04036ST3QIE324TS-W22

TORQUE AND CURRENT VS SPEED CURVE

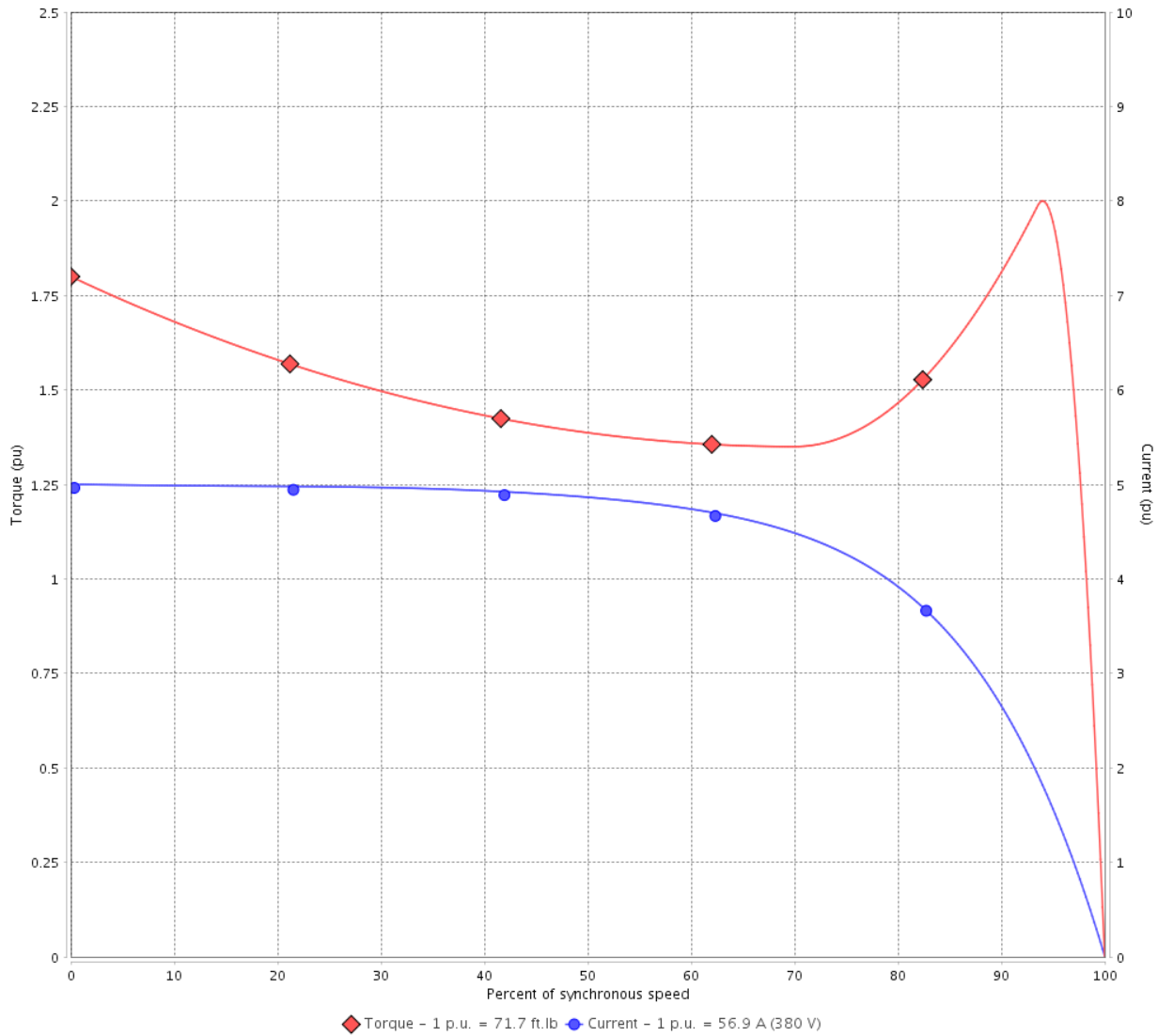

Performance : 380 V 50 Hz 2P IE1

Rated current	: 56.9 A	Moment of inertia (J)	: 4.90 sq.ft.lb
LRC	: 5.0	Duty cycle	: Cont.(S1)
Rated torque	: 71.7 ft.lb	Insulation class	: F
Locked rotor torque	: 180 %	Service factor	: 1.00
Breakdown torque	: 200 %	Temperature rise	: 105 K
Rated speed	: 2930 rpm	Design	: B

Locked rotor time : 27s (cold) 15s (hot)

Rev.	Changes Summary	Performed	Checked	Date
Performed by			Page 6 / 36	Revision
Checked by				
Date	12/04/2022			

TORQUE AND CURRENT VS SPEED CURVE



Three Phase Induction Motor - Squirrel Cage

Customer :

Product line : NEMA Premium Efficiency Three-Phase

Product code : 12447815

Catalog # : 04036ST3QIE324TS-W22

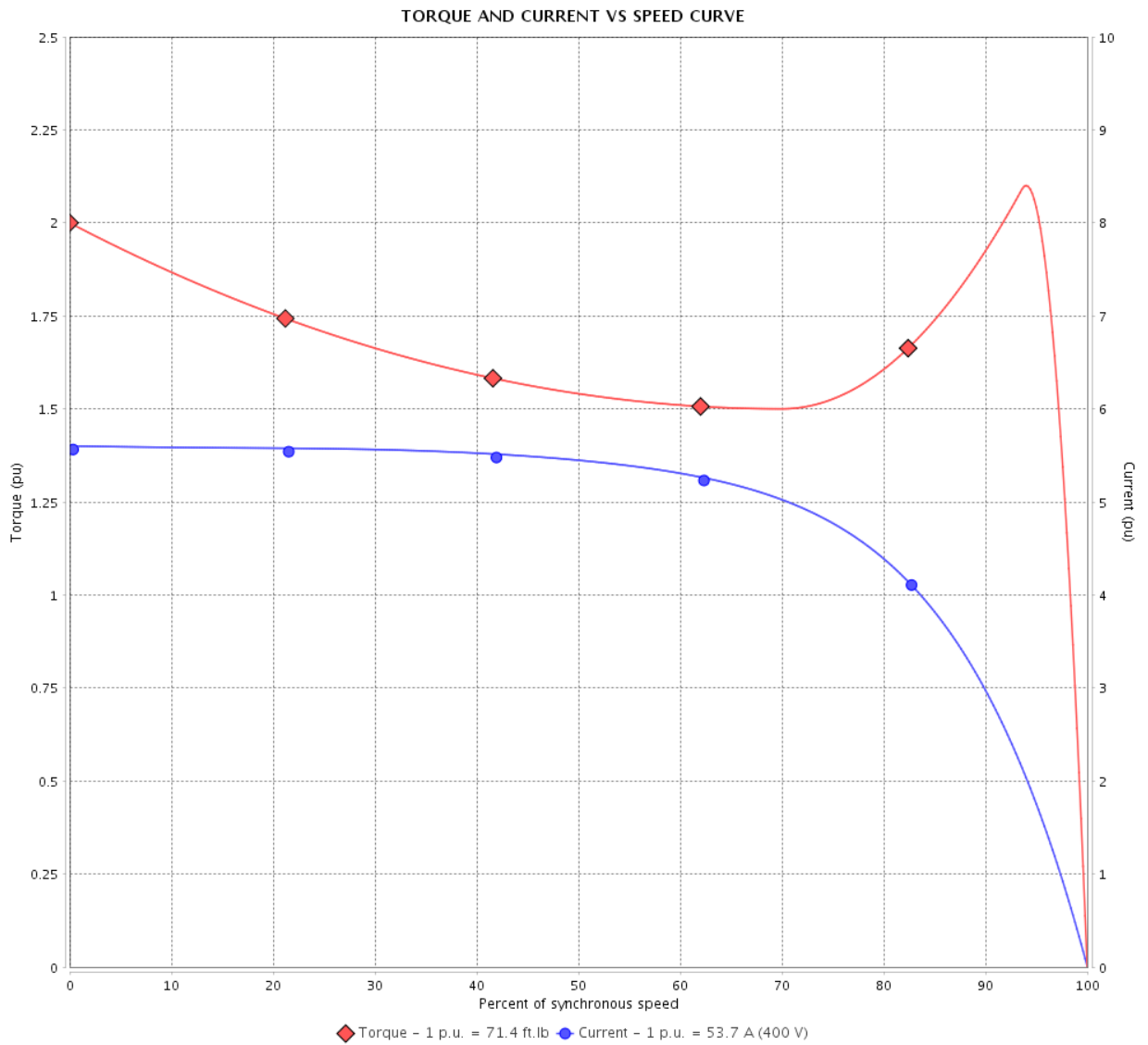

Performance : 400 V 50 Hz 2P IE1

Rated current	: 53.7 A	Moment of inertia (J)	: 4.90 sq.ft.lb
LRC	: 5.6	Duty cycle	: Cont.(S1)
Rated torque	: 71.4 ft.lb	Insulation class	: F
Locked rotor torque	: 200 %	Service factor	: 1.00
Breakdown torque	: 210 %	Temperature rise	: 105 K
Rated speed	: 2940 rpm	Design	: B

Locked rotor time : 59s (cold) 33s (hot)

Rev.	Changes Summary	Performed	Checked	Date
Performed by			Page 7 / 36	Revision
Checked by				
Date	12/04/2022			

TORQUE AND CURRENT VS SPEED CURVE

Three Phase Induction Motor - Squirrel Cage



Customer :

Product line : NEMA Premium Efficiency Three-Phase

Product code : 12447815

Catalog # : 04036ST3QIE324TS-W22

TORQUE AND CURRENT VS SPEED CURVE

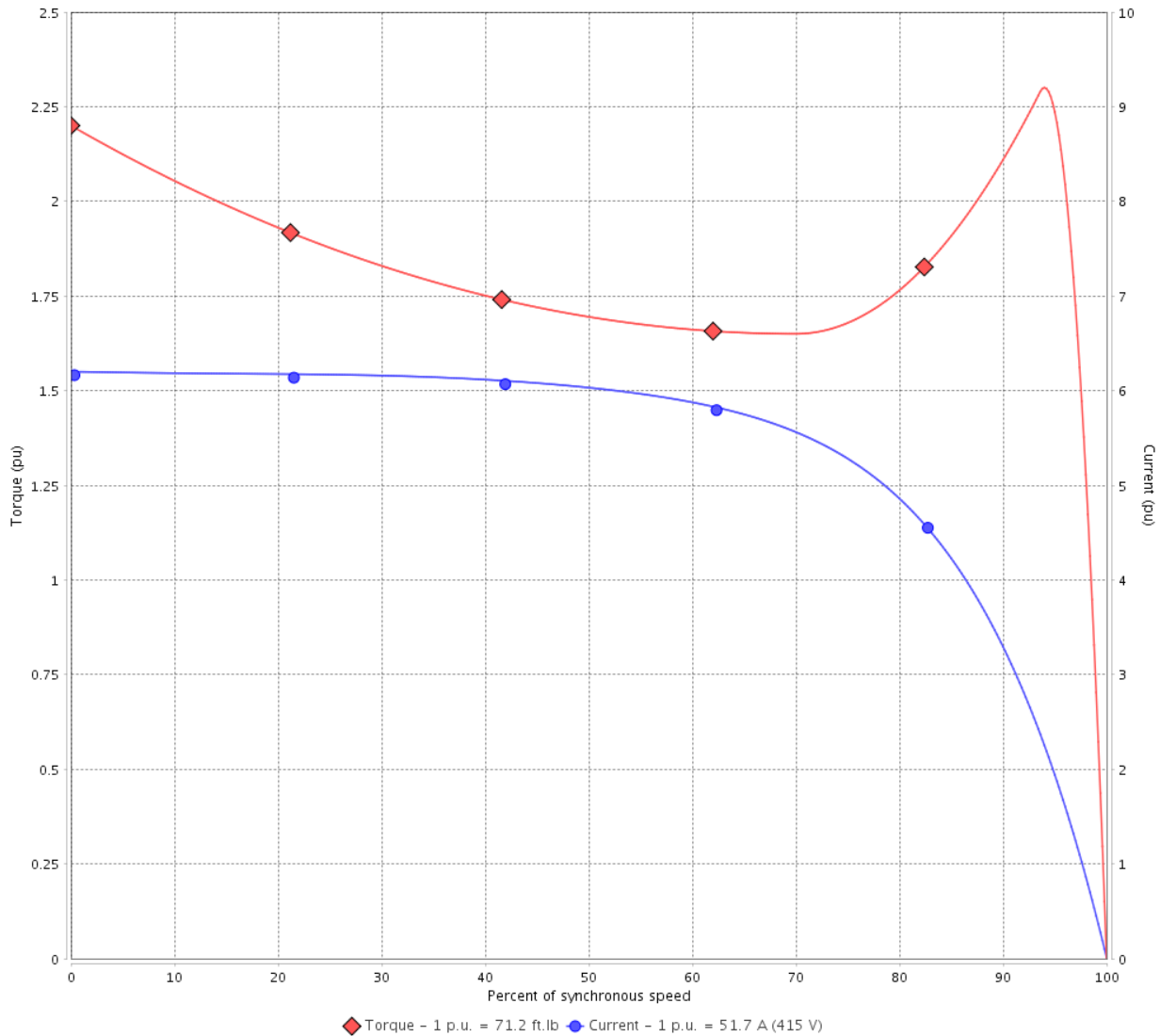

Performance : 415 V 50 Hz 2P IE1

Rated current	: 51.7 A	Moment of inertia (J)	: 4.90 sq.ft.lb
LRC	: 6.2	Duty cycle	: Cont.(S1)
Rated torque	: 71.2 ft.lb	Insulation class	: F
Locked rotor torque	: 220 %	Service factor	: 1.00
Breakdown torque	: 229 %	Temperature rise	: 105 K
Rated speed	: 2950 rpm	Design	: B

Locked rotor time : 59s (cold) 33s (hot)

Rev.	Changes Summary	Performed	Checked	Date
Performed by			Page 8 / 36	Revision
Checked by				
Date	12/04/2022			

LOAD PERFORMANCE CURVE

Three Phase Induction Motor - Squirrel Cage



Customer : _____

Product line : NEMA Premium Efficiency Three-Phase

Product code : 12447815

Catalog # : 04036ST3QIE324TS-W22

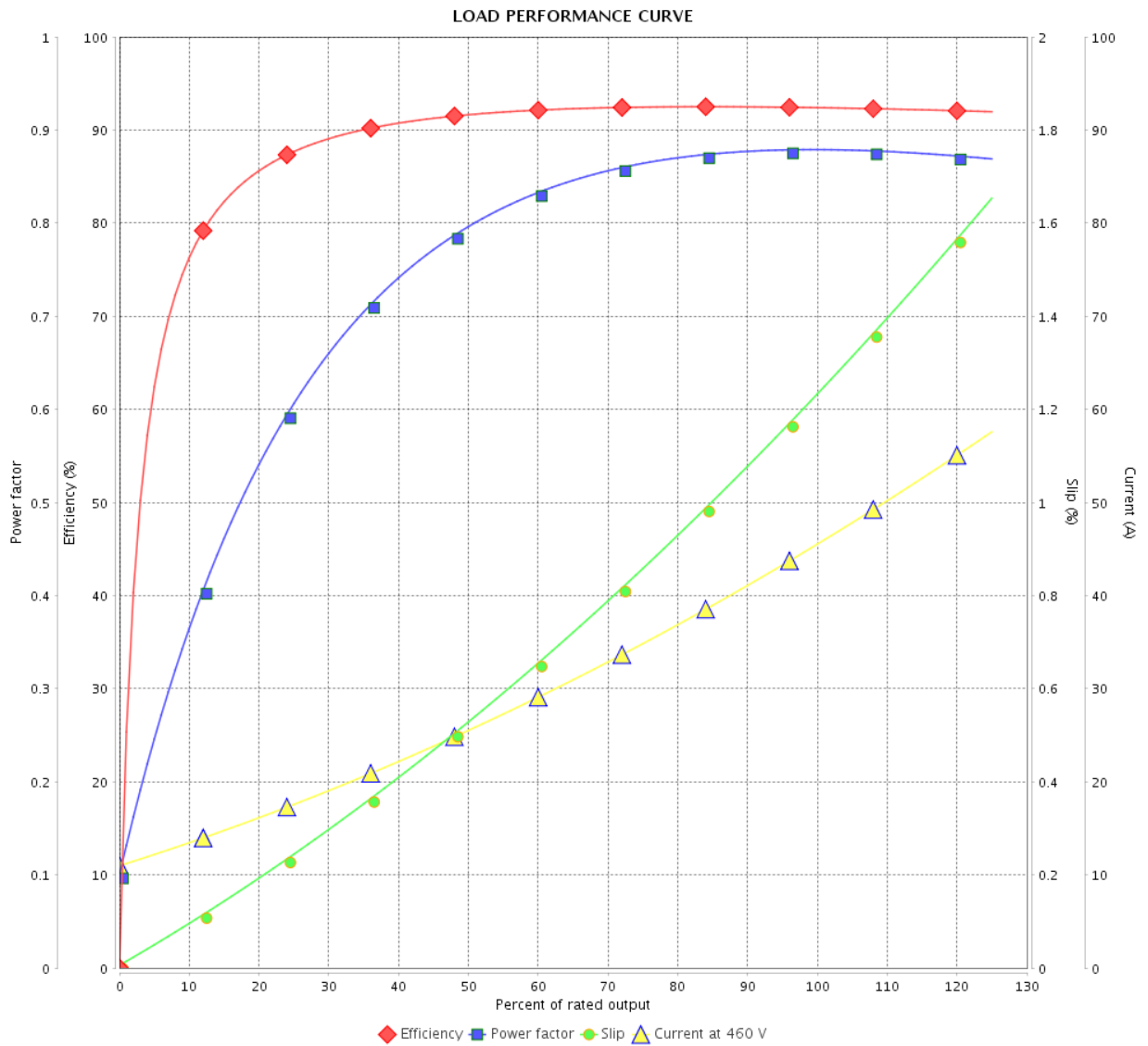

Performance : 460 V 60 Hz 2P

Rated current : 46.3 A
 LRC : 6.3
 Rated torque : 59.1 ft.lb
 Locked rotor torque : 250 %
 Breakdown torque : 240 %
 Rated speed : 3555 rpm

Moment of inertia (J) : 4.90 sq.ft.lb
 Duty cycle : Cont.(S1)
 Insulation class : F
 Service factor : 1.25
 Temperature rise : 80 K
 Design : B

Rev.	Changes Summary	Performed	Checked	Date
Performed by		Page		Revision
Checked by		9 / 36		
Date		12/04/2022		

LOAD PERFORMANCE CURVE

Three Phase Induction Motor - Squirrel Cage



Customer :

Product line : NEMA Premium Efficiency Three-Phase

Product code : 12447815

Catalog # : 04036ST3QIE324TS-W22

LOAD PERFORMANCE CURVE

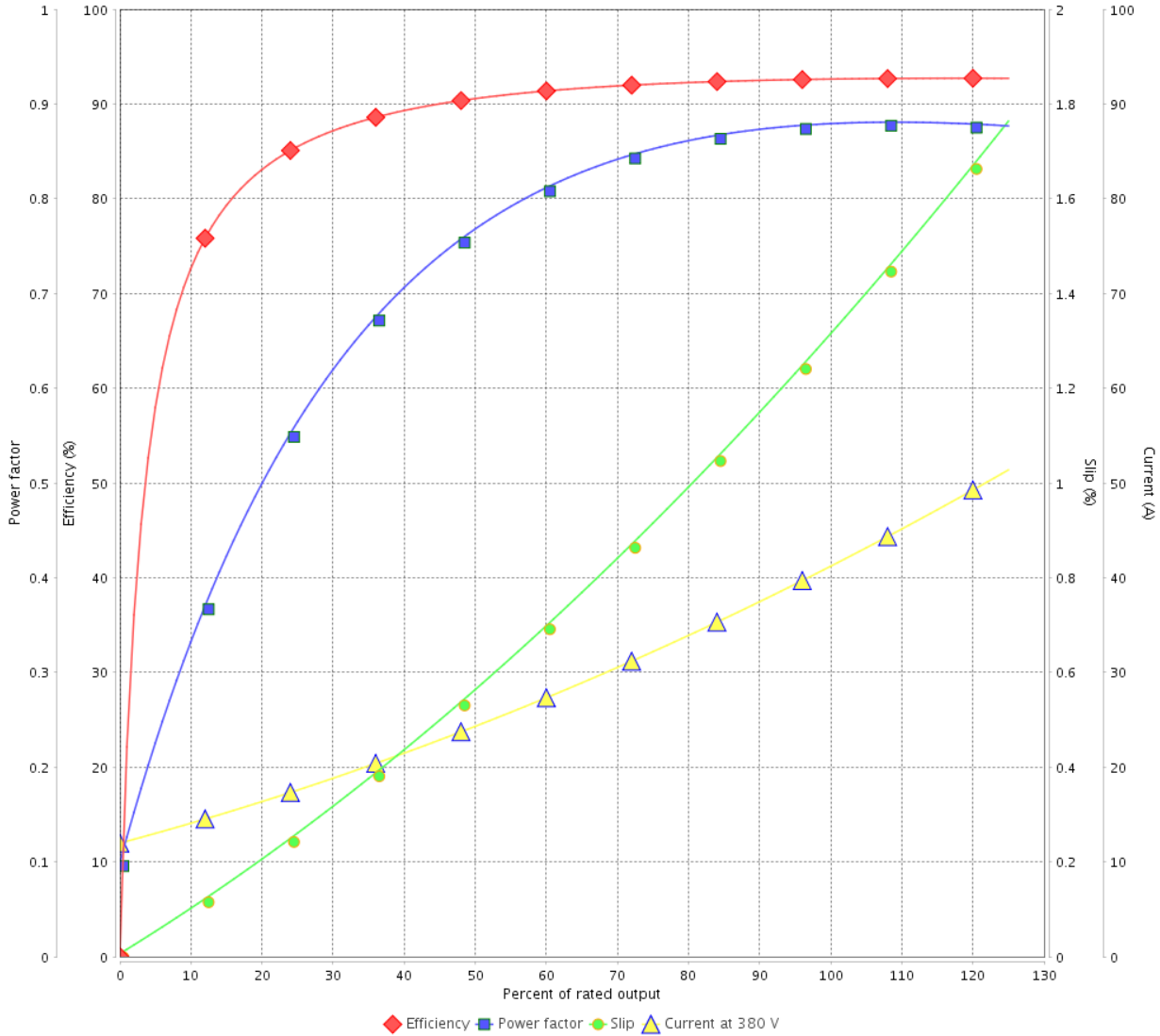

Performance : 380 V 50 Hz 2P IE3

Rated current : 41.0 A
 LRC : 7.2
 Rated torque : 53.2 ft.lb
 Locked rotor torque : 240 %
 Breakdown torque : 250 %
 Rated speed : 2960 rpm

Moment of inertia (J) : 4.90 sq.ft.lb
 Duty cycle : Cont.(S1)
 Insulation class : F
 Service factor : 1.00
 Temperature rise : 80 K
 Design : B

Rev.	Changes Summary	Performed	Checked	Date
Performed by			Page 10 / 36	Revision
Checked by				
Date	12/04/2022			

LOAD PERFORMANCE CURVE

Three Phase Induction Motor - Squirrel Cage



Customer :

Product line : NEMA Premium Efficiency Three-Phase

Product code : 12447815

Catalog # : 04036ST3QIE324TS-W22

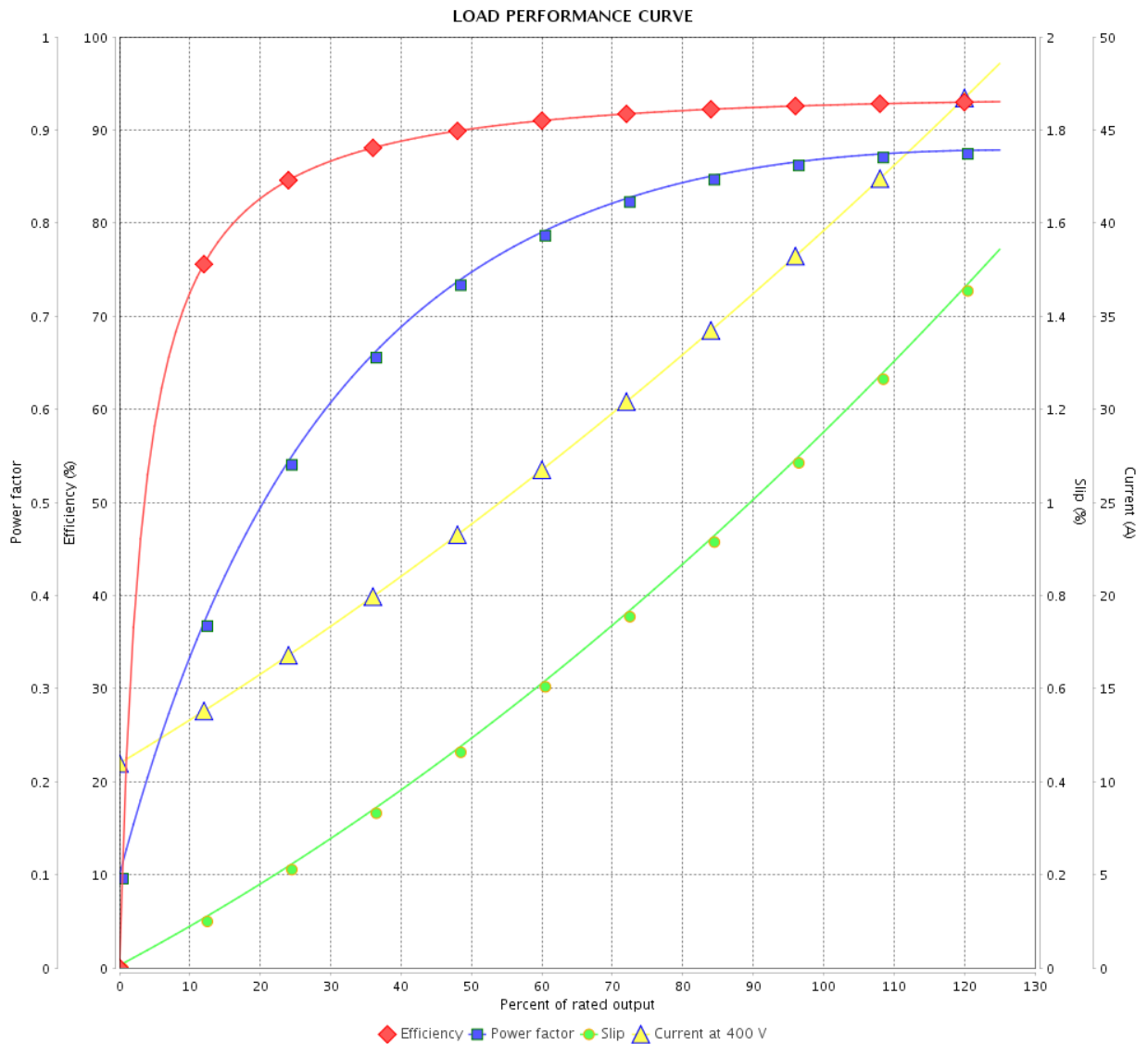

Performance : 400 V 50 Hz 2P IE3

Rated current : 39.4 A
 LRC : 7.5
 Rated torque : 53.1 ft.lb
 Locked rotor torque : 270 %
 Breakdown torque : 280 %
 Rated speed : 2965 rpm

Moment of inertia (J) : 4.90 sq.ft.lb
 Duty cycle : Cont.(S1)
 Insulation class : F
 Service factor : 1.00
 Temperature rise : 80 K
 Design : B

Rev.	Changes Summary	Performed	Checked	Date
Performed by		Page		Revision
Checked by		11 / 36		
Date		12/04/2022		

LOAD PERFORMANCE CURVE

Three Phase Induction Motor - Squirrel Cage



Customer :

Product line : NEMA Premium Efficiency Three-Phase

Product code : 12447815

Catalog # : 04036ST3QIE324TS-W22

LOAD PERFORMANCE CURVE

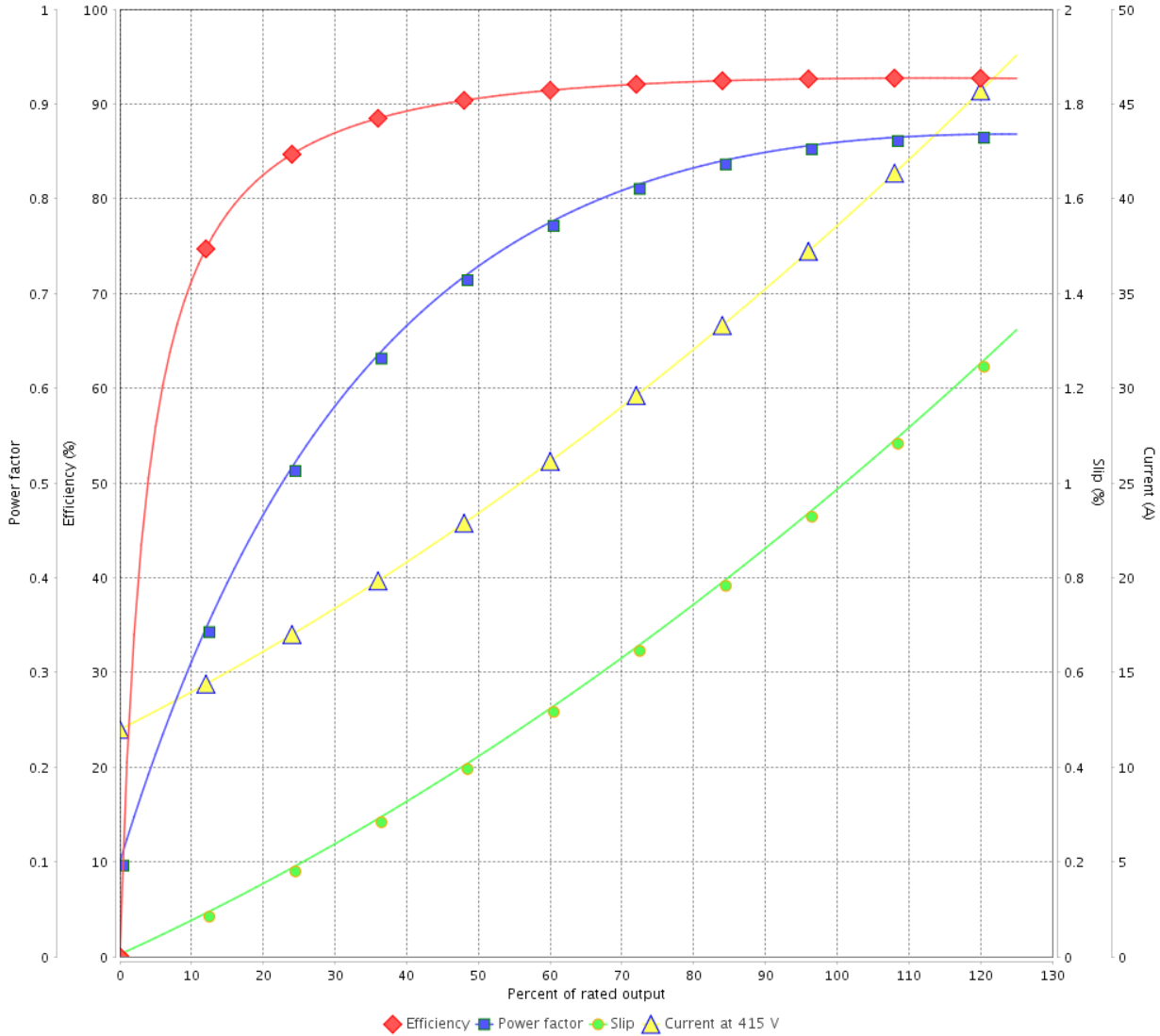

Performance : 415 V 50 Hz 2P IE3

Rated current : 38.4 A
 LRC : 7.6
 Rated torque : 53.0 ft.lb
 Locked rotor torque : 290 %
 Breakdown torque : 310 %
 Rated speed : 2970 rpm

Moment of inertia (J) : 4.90 sq.ft.lb
 Duty cycle : Cont.(S1)
 Insulation class : F
 Service factor : 1.00
 Temperature rise : 80 K
 Design : B

Rev.	Changes Summary	Performed	Checked	Date
Performed by		Page		Revision
Checked by		12 / 36		
Date		12/04/2022		

LOAD PERFORMANCE CURVE

Three Phase Induction Motor - Squirrel Cage



Customer : _____

Product line : NEMA Premium Efficiency Three-Phase

Product code : 12447815

Catalog # : 04036ST3QIE324TS-W22

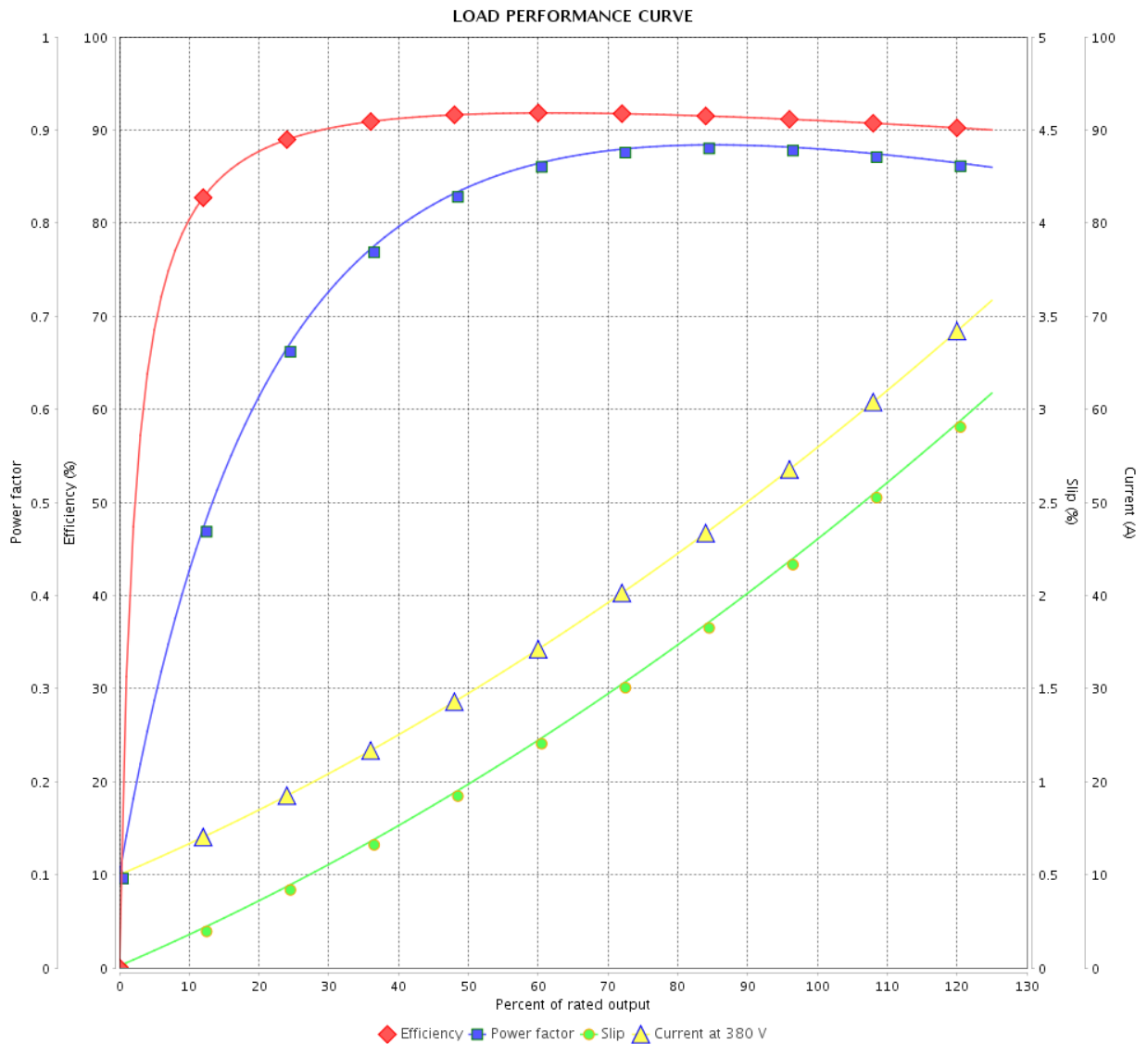

Performance : 380 V 50 Hz 2P IE1

Rated current : 56.9 A
 LRC : 5.0
 Rated torque : 71.7 ft.lb
 Locked rotor torque : 180 %
 Breakdown torque : 200 %
 Rated speed : 2930 rpm

Moment of inertia (J) : 4.90 sq.ft.lb
 Duty cycle : Cont.(S1)
 Insulation class : F
 Service factor : 1.00
 Temperature rise : 105 K
 Design : B

Rev.	Changes Summary	Performed	Checked	Date
Performed by		Page		Revision
Checked by		13 / 36		
Date		12/04/2022		

LOAD PERFORMANCE CURVE

Three Phase Induction Motor - Squirrel Cage



Customer :

Product line : NEMA Premium Efficiency Three-Phase

Product code : 12447815

Catalog # : 04036ST3QIE324TS-W22

LOAD PERFORMANCE CURVE

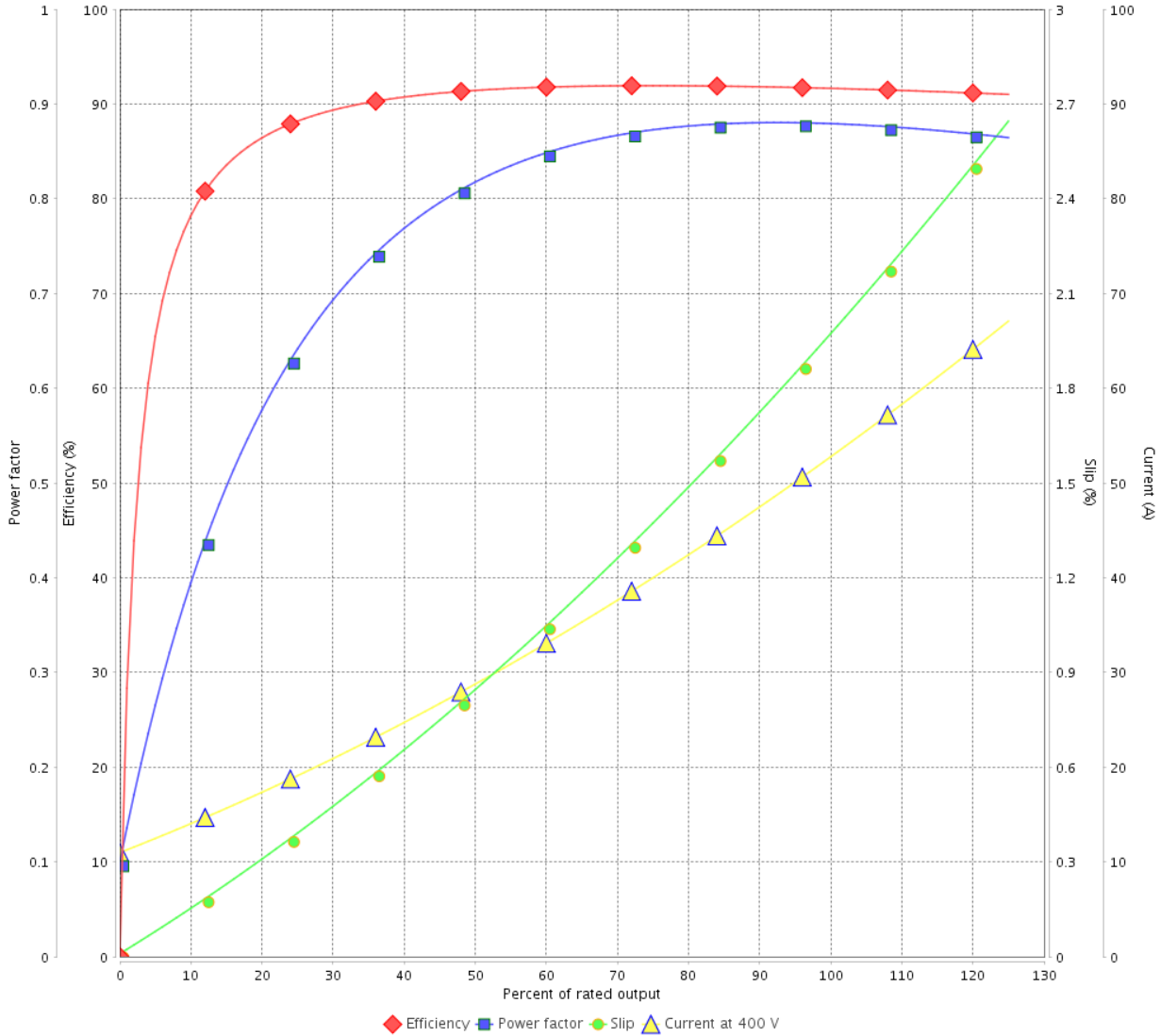

Performance : 400 V 50 Hz 2P IE1

Rated current : 53.7 A
 LRC : 5.6
 Rated torque : 71.4 ft.lb
 Locked rotor torque : 200 %
 Breakdown torque : 210 %
 Rated speed : 2940 rpm

Moment of inertia (J) : 4.90 sq.ft.lb
 Duty cycle : Cont.(S1)
 Insulation class : F
 Service factor : 1.00
 Temperature rise : 105 K
 Design : B

Rev.	Changes Summary	Performed	Checked	Date
Performed by		Page		Revision
Checked by		14 / 36		
Date		12/04/2022		

LOAD PERFORMANCE CURVE

Three Phase Induction Motor - Squirrel Cage



Customer :

Product line : NEMA Premium Efficiency Three-Phase

Product code : 12447815

Catalog # : 04036ST3QIE324TS-W22

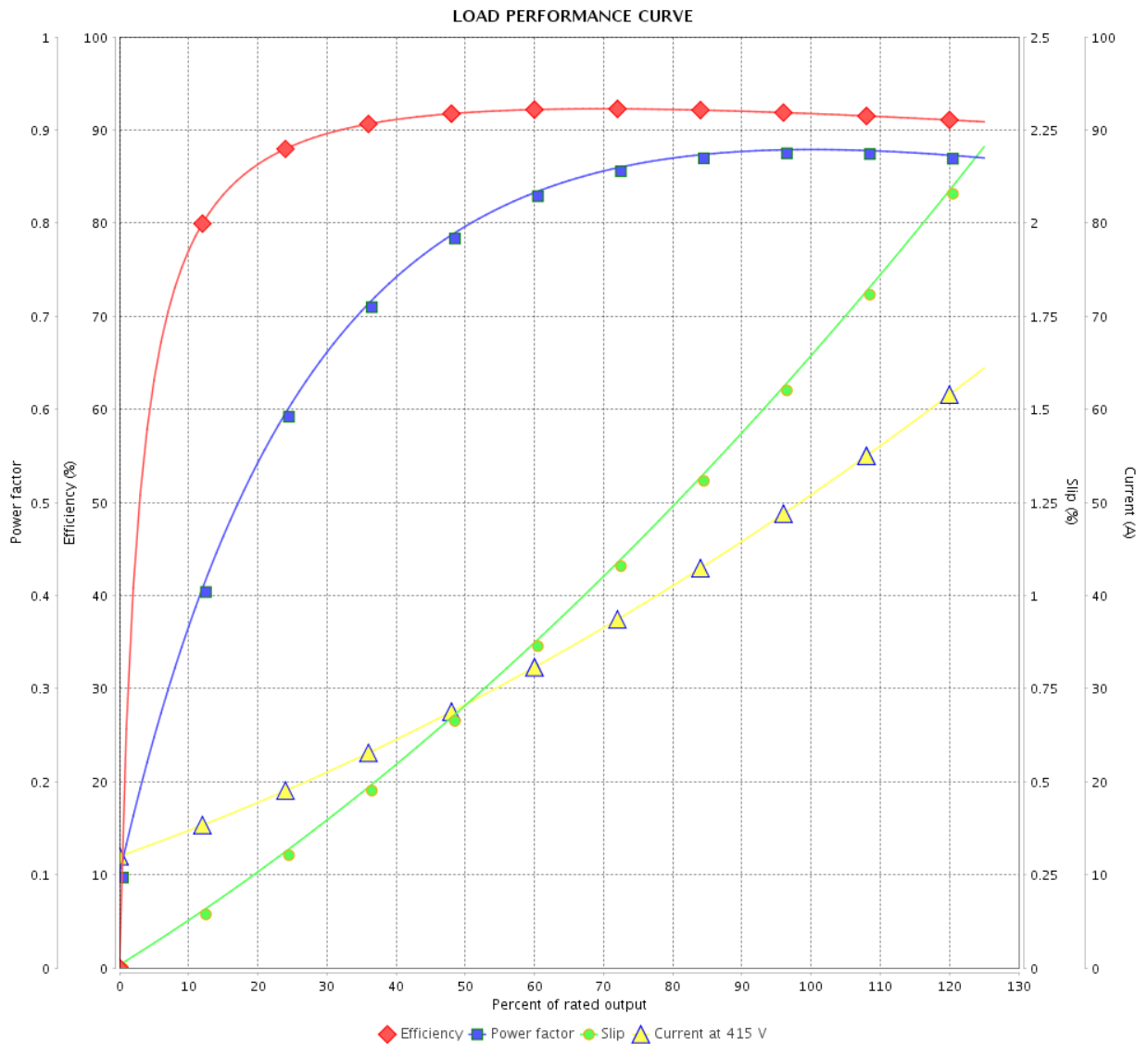

Performance : 415 V 50 Hz 2P IE1

Rated current : 51.7 A
 LRC : 6.2
 Rated torque : 71.2 ft.lb
 Locked rotor torque : 220 %
 Breakdown torque : 229 %
 Rated speed : 2950 rpm

Moment of inertia (J) : 4.90 sq.ft.lb
 Duty cycle : Cont.(S1)
 Insulation class : F
 Service factor : 1.00
 Temperature rise : 105 K
 Design : B

Rev.	Changes Summary	Performed	Checked	Date
Performed by			Page	Revision
Checked by				
Date				
			15 / 36	

THERMAL LIMIT CURVE



Three Phase Induction Motor - Squirrel Cage

Customer :

Product line : NEMA Premium Efficiency Three-Phase
Product code : 12447815
Catalog # : 04036ST3QIE324TS-W22

Performance : 460 V 60 Hz 2P

Rated current	: 46.3 A	Moment of inertia (J)	: 4.90 sq.ft.lb
LRC	: 6.3	Duty cycle	: Cont.(S1)
Rated torque	: 59.1 ft.lb	Insulation class	: F
Locked rotor torque	: 250 %	Service factor	: 1.25
Breakdown torque	: 240 %	Temperature rise	: 80 K
Rated speed	: 3555 rpm	Design	: B

Heating constant

Cooling constant

Rev.	Changes Summary	Performed	Checked	Date
Performed by				
Checked by			Page	Revision
Date	12/04/2022		16 / 36	

THERMAL LIMIT CURVE

Three Phase Induction Motor - Squirrel Cage



Customer : _____

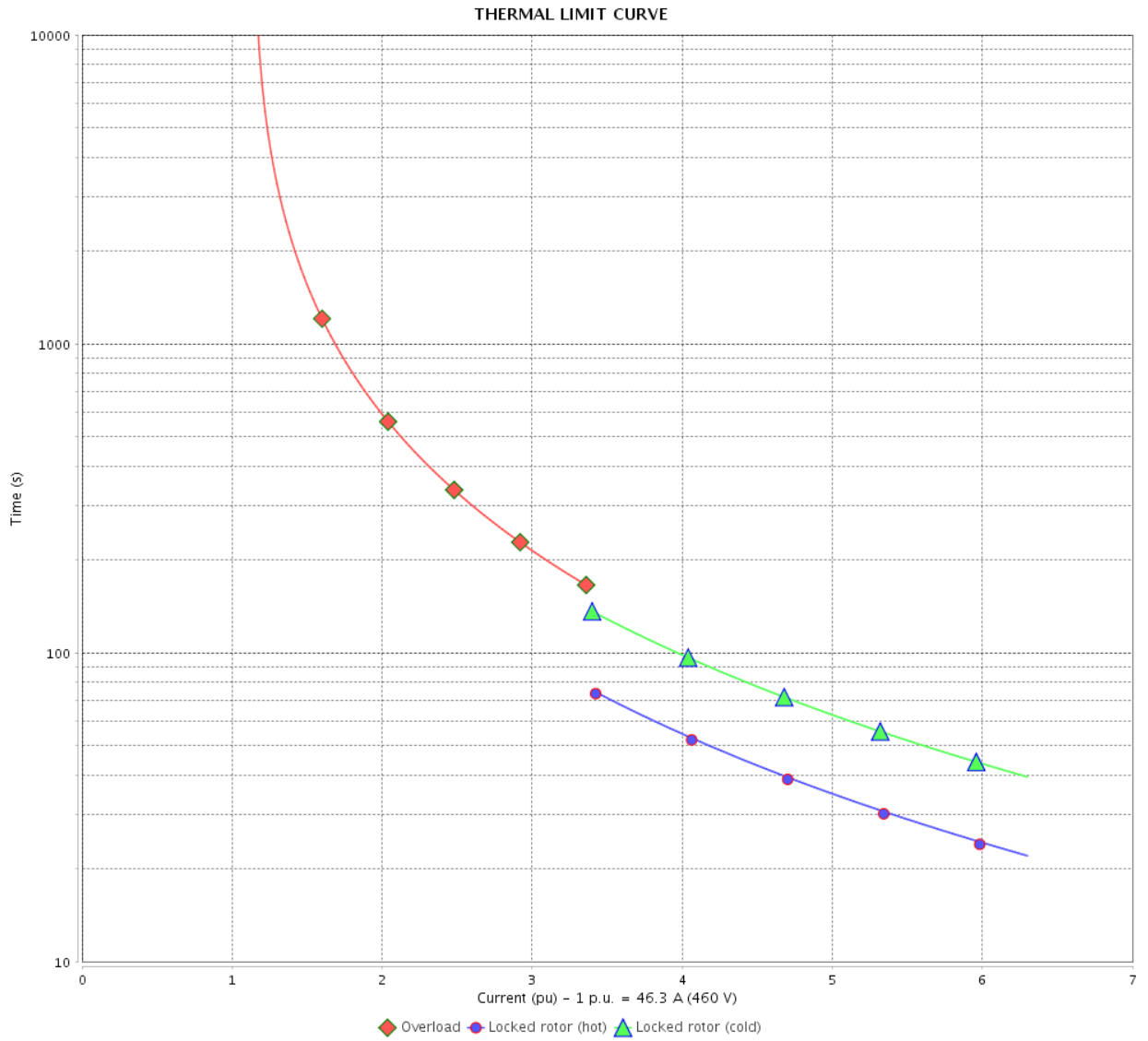

Rev.	Changes Summary	Performed	Checked	Date
Performed by		Page 17 / 36		Revision
Checked by				
Date				

THERMAL LIMIT CURVE



Three Phase Induction Motor - Squirrel Cage

Customer :

Product line : NEMA Premium Efficiency Three-Phase
 Product code : 12447815
 Catalog # : 04036ST3QIE324TS-W22

Performance : 380 V 50 Hz 2P IE3

Rated current : 41.0 A	Moment of inertia (J) : 4.90 sq.ft.lb
LRC : 7.2	Duty cycle : Cont.(S1)
Rated torque : 53.2 ft.lb	Insulation class : F
Locked rotor torque : 240 %	Service factor : 1.00
Breakdown torque : 250 %	Temperature rise : 80 K
Rated speed : 2960 rpm	Design : B

Heating constant

Cooling constant

Rev.	Changes Summary	Performed	Checked	Date
Performed by			Page 18 / 36	Revision
Checked by				
Date	12/04/2022			

THERMAL LIMIT CURVE

Three Phase Induction Motor - Squirrel Cage



Customer : _____

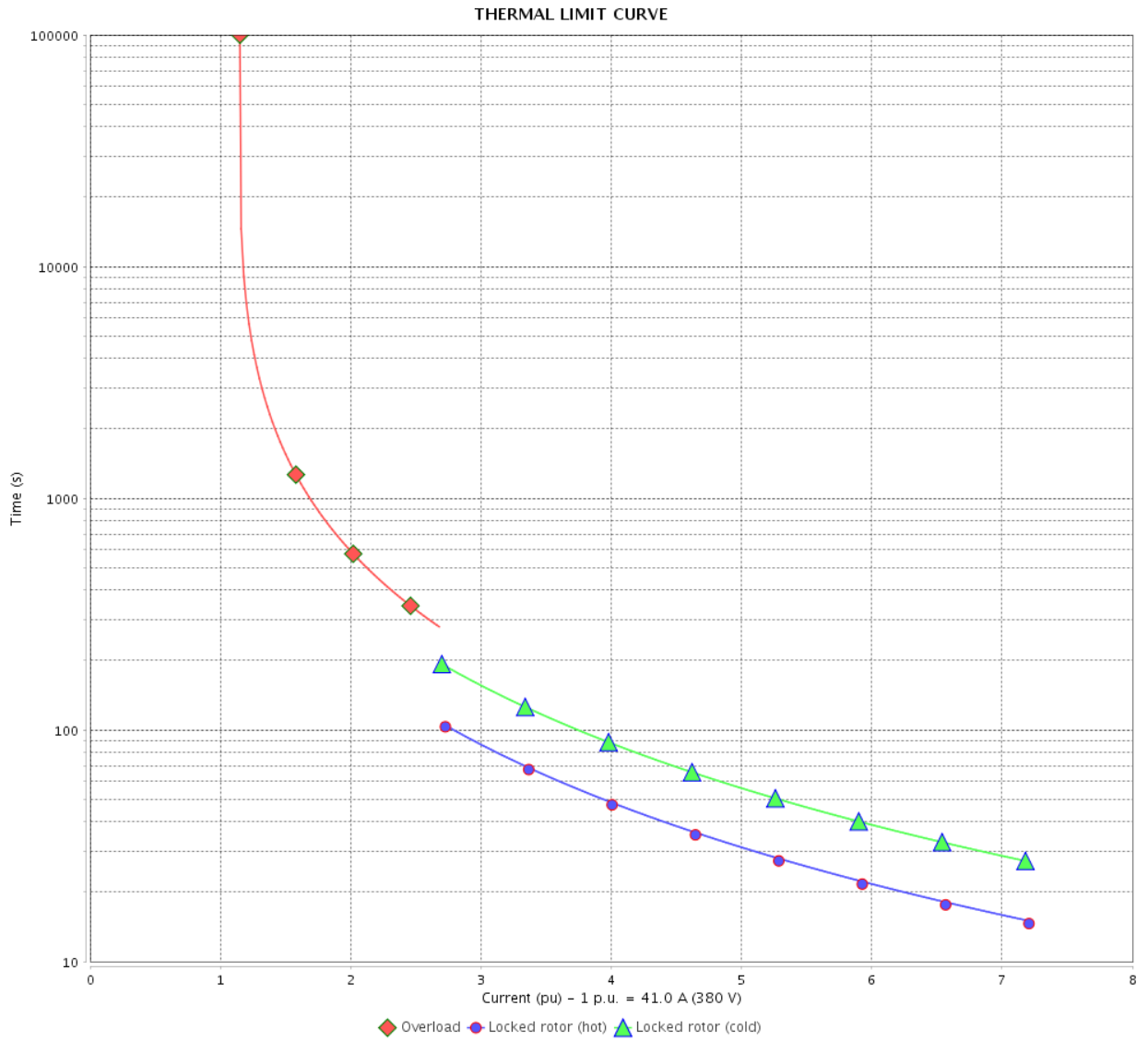

Rev.	Changes Summary	Performed	Checked	Date
Performed by		Page		Revision
Checked by		19 / 36		
Date		12/04/2022		

THERMAL LIMIT CURVE



Three Phase Induction Motor - Squirrel Cage

Customer :

Product line : NEMA Premium Efficiency Three-Phase
 Product code : 12447815
 Catalog # : 04036ST3QIE324TS-W22

Performance : 400 V 50 Hz 2P IE3

Rated current : 39.4 A	Moment of inertia (J) : 4.90 sq.ft.lb
LRC : 7.5	Duty cycle : Cont.(S1)
Rated torque : 53.1 ft.lb	Insulation class : F
Locked rotor torque : 270 %	Service factor : 1.00
Breakdown torque : 280 %	Temperature rise : 80 K
Rated speed : 2965 rpm	Design : B

Heating constant

Cooling constant

Rev.	Changes Summary	Performed	Checked	Date
Performed by			Page 20 / 36	Revision
Checked by				
Date	12/04/2022			

THERMAL LIMIT CURVE

Three Phase Induction Motor - Squirrel Cage



Customer : _____

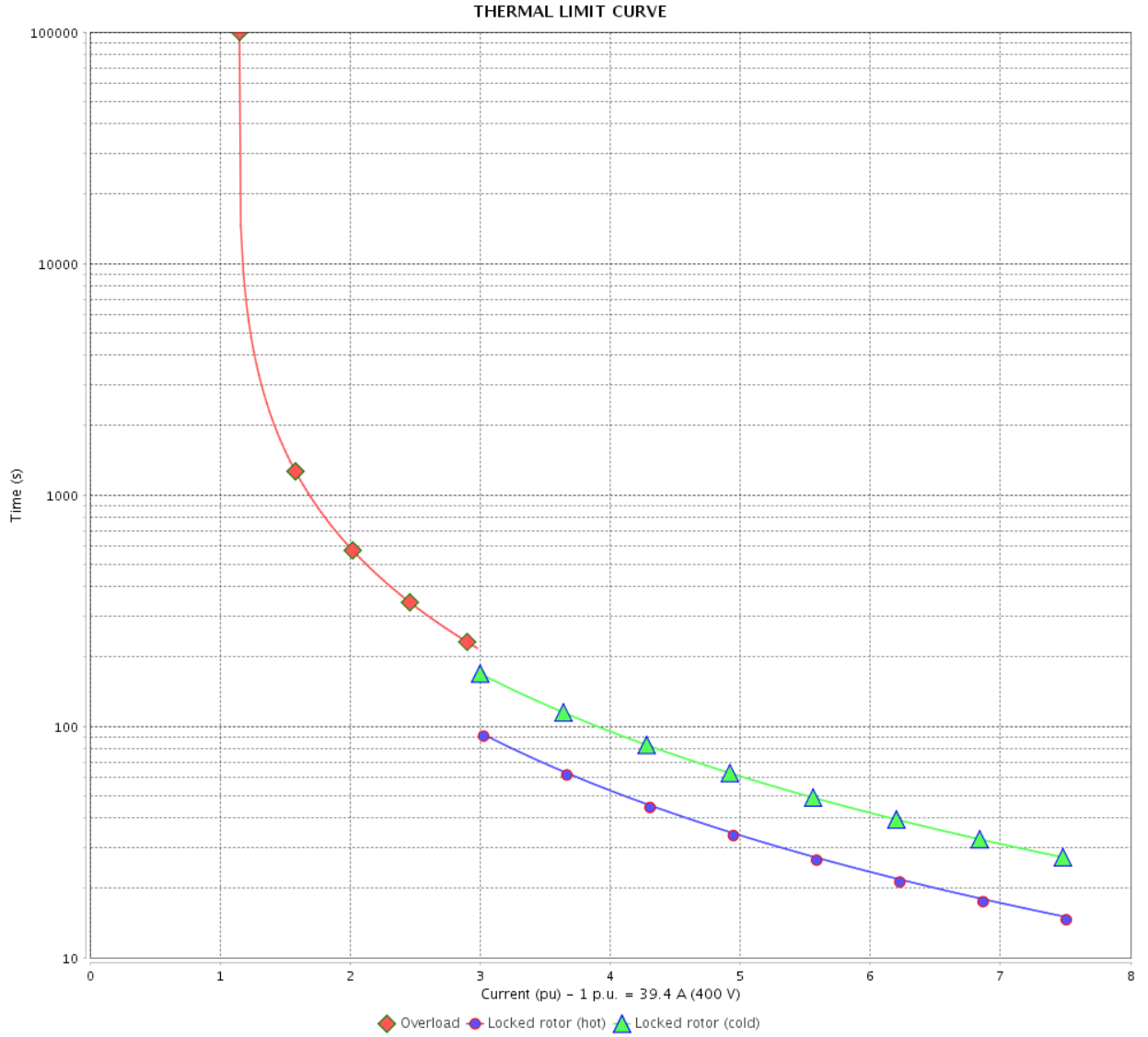

Rev.	Changes Summary	Performed	Checked	Date
Performed by		Page 21 / 36		Revision
Checked by				
Date				

THERMAL LIMIT CURVE



Three Phase Induction Motor - Squirrel Cage

Customer :

Product line : NEMA Premium Efficiency Three-Phase
Product code : 12447815
Catalog # : 04036ST3QIE324TS-W22

Performance : 415 V 50 Hz 2P IE3

Rated current	: 38.4 A	Moment of inertia (J)	: 4.90 sq.ft.lb
LRC	: 7.6	Duty cycle	: Cont.(S1)
Rated torque	: 53.0 ft.lb	Insulation class	: F
Locked rotor torque	: 290 %	Service factor	: 1.00
Breakdown torque	: 310 %	Temperature rise	: 80 K
Rated speed	: 2970 rpm	Design	: B

Heating constant

Cooling constant

Rev.	Changes Summary	Performed	Checked	Date
Performed by				
Checked by			Page	Revision
Date	12/04/2022		22 / 36	

THERMAL LIMIT CURVE

Three Phase Induction Motor - Squirrel Cage



Customer : _____

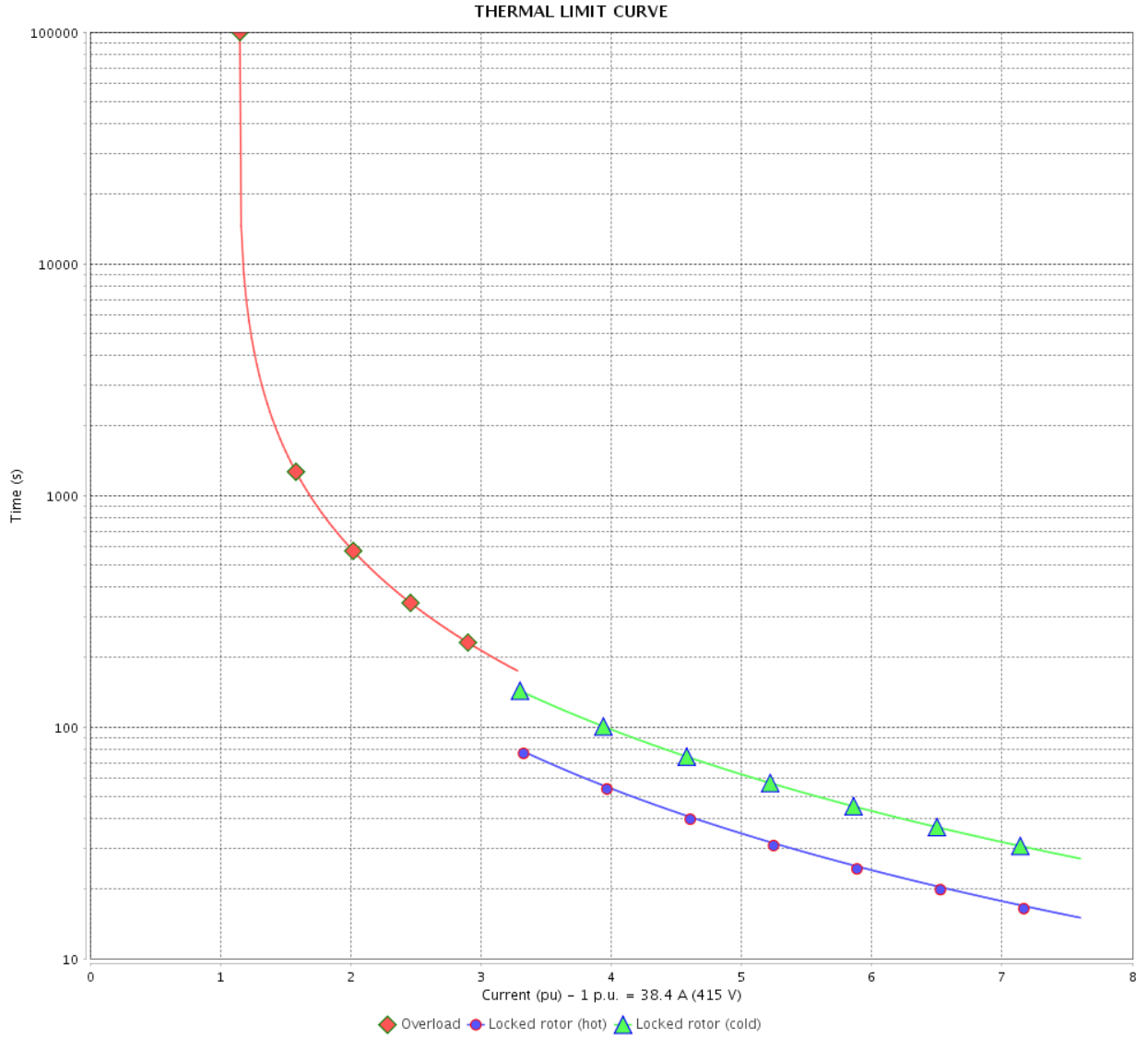

Rev.	Changes Summary	Performed	Checked	Date
Performed by		Page 23 / 36		Revision
Checked by				
Date				

THERMAL LIMIT CURVE

Three Phase Induction Motor - Squirrel Cage



Customer :

Product line : NEMA Premium Efficiency Three-Phase
Product code : 12447815
Catalog # : 04036ST3QIE324TS-W22

Performance : 380 V 50 Hz 2P IE1

Rated current	: 56.9 A	Moment of inertia (J)	: 4.90 sq.ft.lb
LRC	: 5.0	Duty cycle	: Cont.(S1)
Rated torque	: 71.7 ft.lb	Insulation class	: F
Locked rotor torque	: 180 %	Service factor	: 1.00
Breakdown torque	: 200 %	Temperature rise	: 105 K
Rated speed	: 2930 rpm	Design	: B

Heating constant

Cooling constant

Rev.	Changes Summary	Performed	Checked	Date
Performed by				
Checked by			Page	Revision
Date	12/04/2022		24 / 36	

THERMAL LIMIT CURVE

Three Phase Induction Motor - Squirrel Cage



Customer : _____

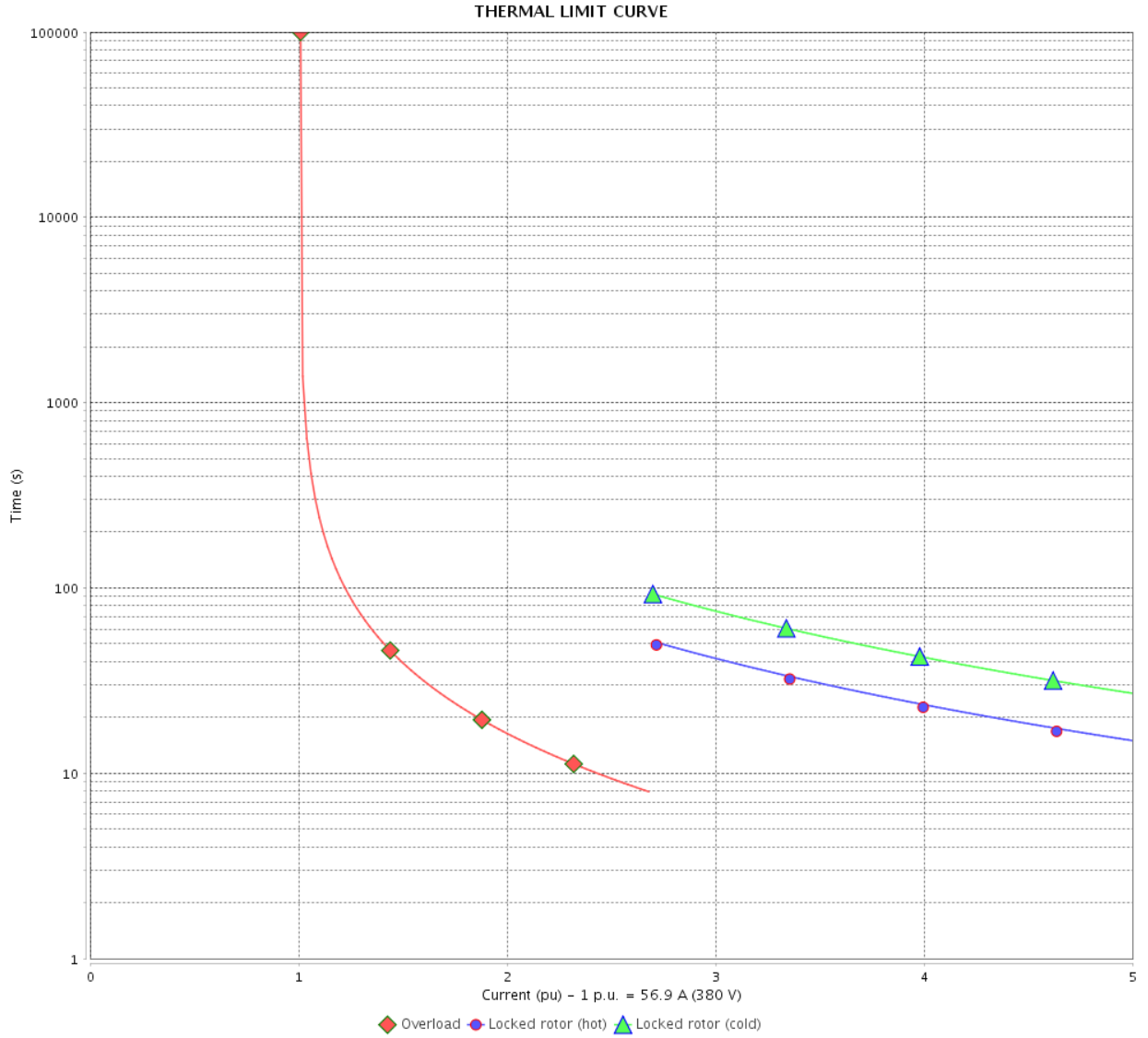

Rev.	Changes Summary	Performed	Checked	Date
Performed by				
Checked by				
Date				
			Page	Revision
			25 / 36	

THERMAL LIMIT CURVE



Three Phase Induction Motor - Squirrel Cage

Customer :

Product line : NEMA Premium Efficiency Three-Phase
 Product code : 12447815
 Catalog # : 04036ST3QIE324TS-W22

Performance : 400 V 50 Hz 2P IE1

Rated current : 53.7 A	Moment of inertia (J) : 4.90 sq.ft.lb
LRC : 5.6	Duty cycle : Cont.(S1)
Rated torque : 71.4 ft.lb	Insulation class : F
Locked rotor torque : 200 %	Service factor : 1.00
Breakdown torque : 210 %	Temperature rise : 105 K
Rated speed : 2940 rpm	Design : B

Heating constant

Cooling constant

Rev.	Changes Summary	Performed	Checked	Date
Performed by			Page 26 / 36	Revision
Checked by				
Date	12/04/2022			

THERMAL LIMIT CURVE

Three Phase Induction Motor - Squirrel Cage



Customer : _____

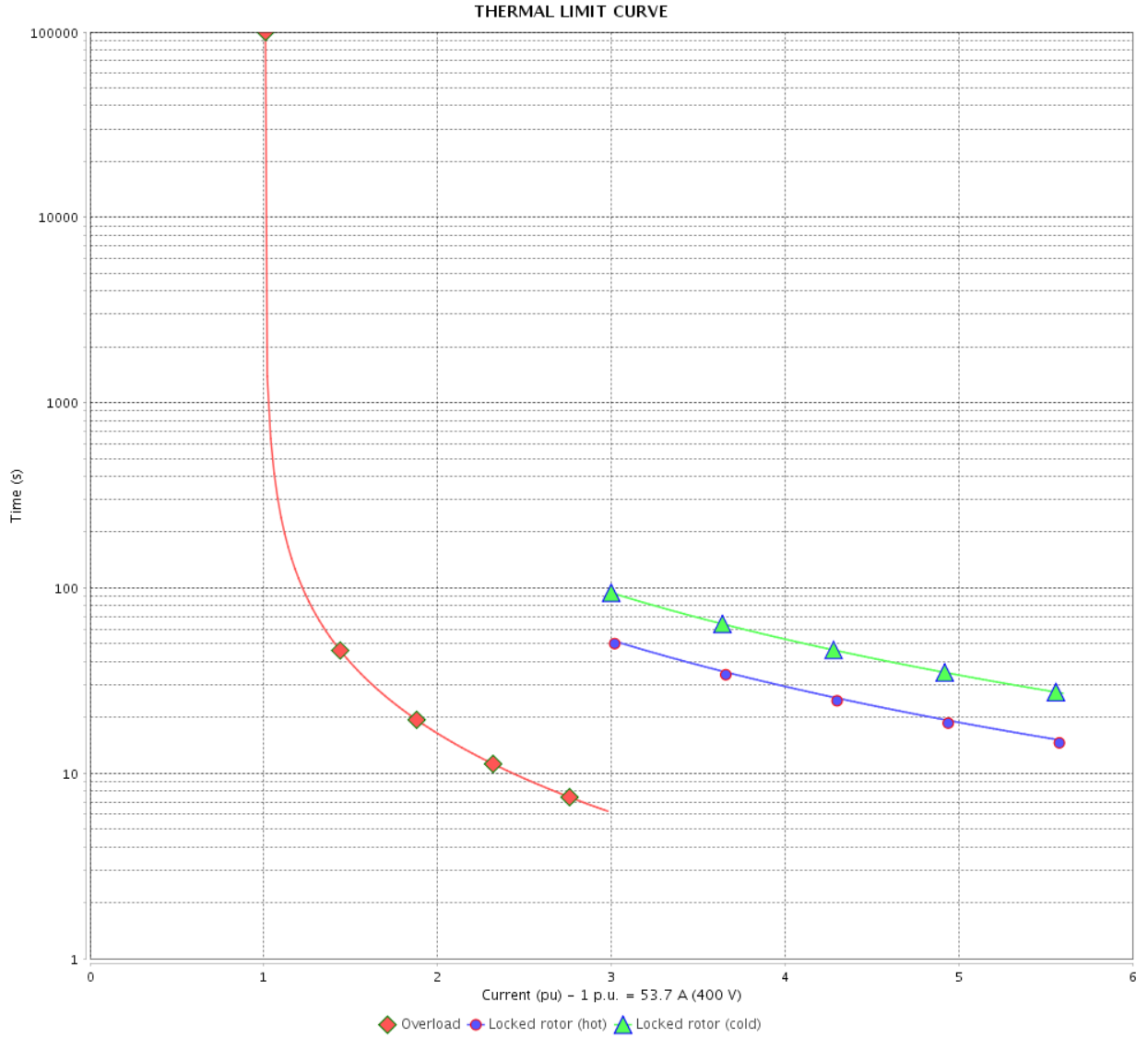

Rev.	Changes Summary	Performed	Checked	Date
Performed by				
Checked by				
Date				
			Page	Revision
			27 / 36	

THERMAL LIMIT CURVE

Three Phase Induction Motor - Squirrel Cage



Customer :

Product line : NEMA Premium Efficiency Three-Phase
Product code : 12447815
Catalog # : 04036ST3QIE324TS-W22

Performance : 415 V 50 Hz 2P IE1

Rated current	: 51.7 A	Moment of inertia (J)	: 4.90 sq.ft.lb
LRC	: 6.2	Duty cycle	: Cont.(S1)
Rated torque	: 71.2 ft.lb	Insulation class	: F
Locked rotor torque	: 220 %	Service factor	: 1.00
Breakdown torque	: 229 %	Temperature rise	: 105 K
Rated speed	: 2950 rpm	Design	: B

Heating constant

Cooling constant

Rev.	Changes Summary	Performed	Checked	Date
Performed by				
Checked by			Page	Revision
Date	12/04/2022		28 / 36	

THERMAL LIMIT CURVE

Three Phase Induction Motor - Squirrel Cage



Customer : _____

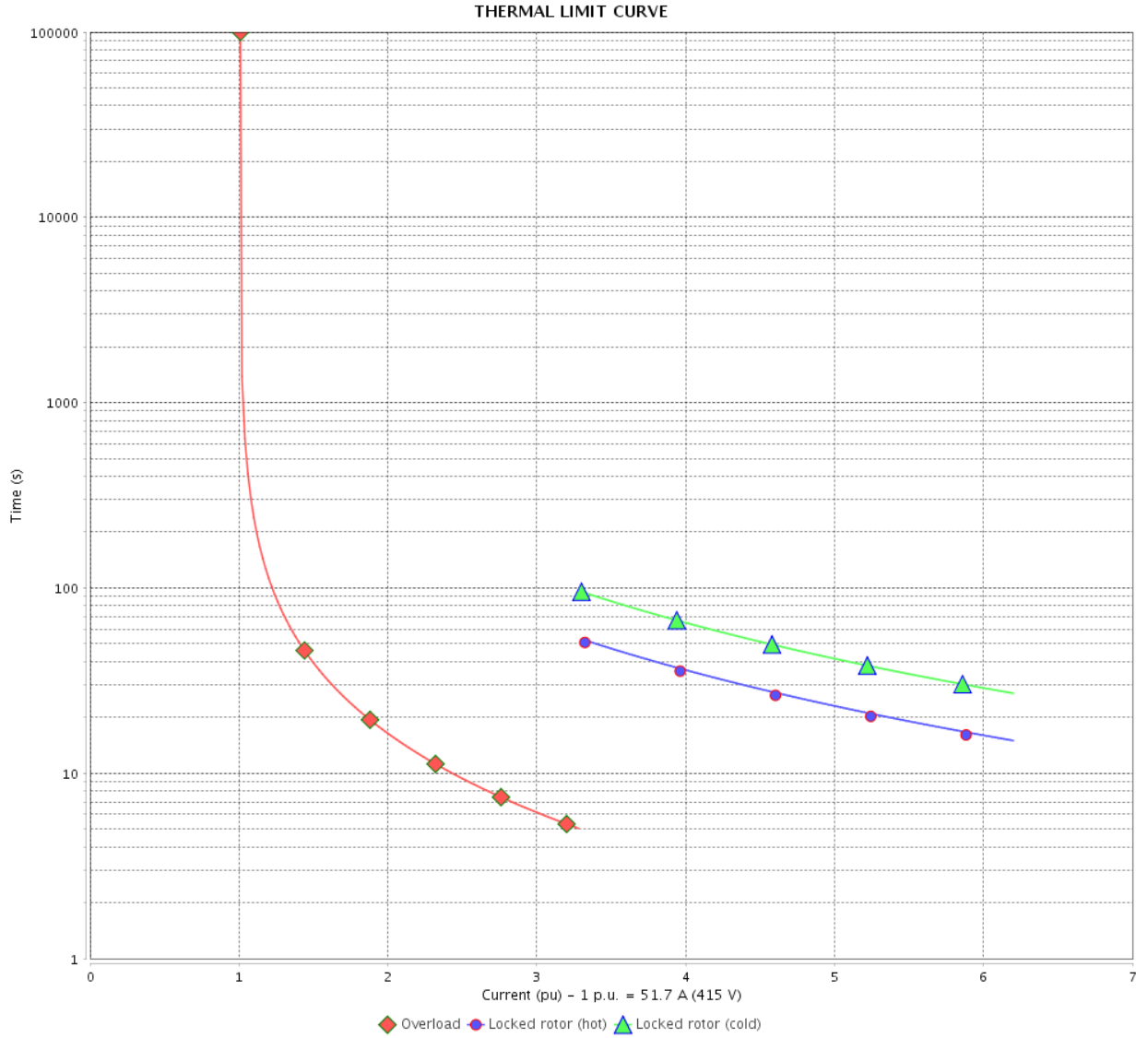

Rev.	Changes Summary	Performed	Checked	Date
Performed by		Page		Revision
Checked by		29 / 36		
Date		12/04/2022		

VFD OPERATION CURVE

Three Phase Induction Motor - Squirrel Cage



Customer :

Product line : NEMA Premium Efficiency Three-Phase

Product code : 12447815

Catalog # : 04036ST3QIE324TS-W22

VFD OPERATION CURVE

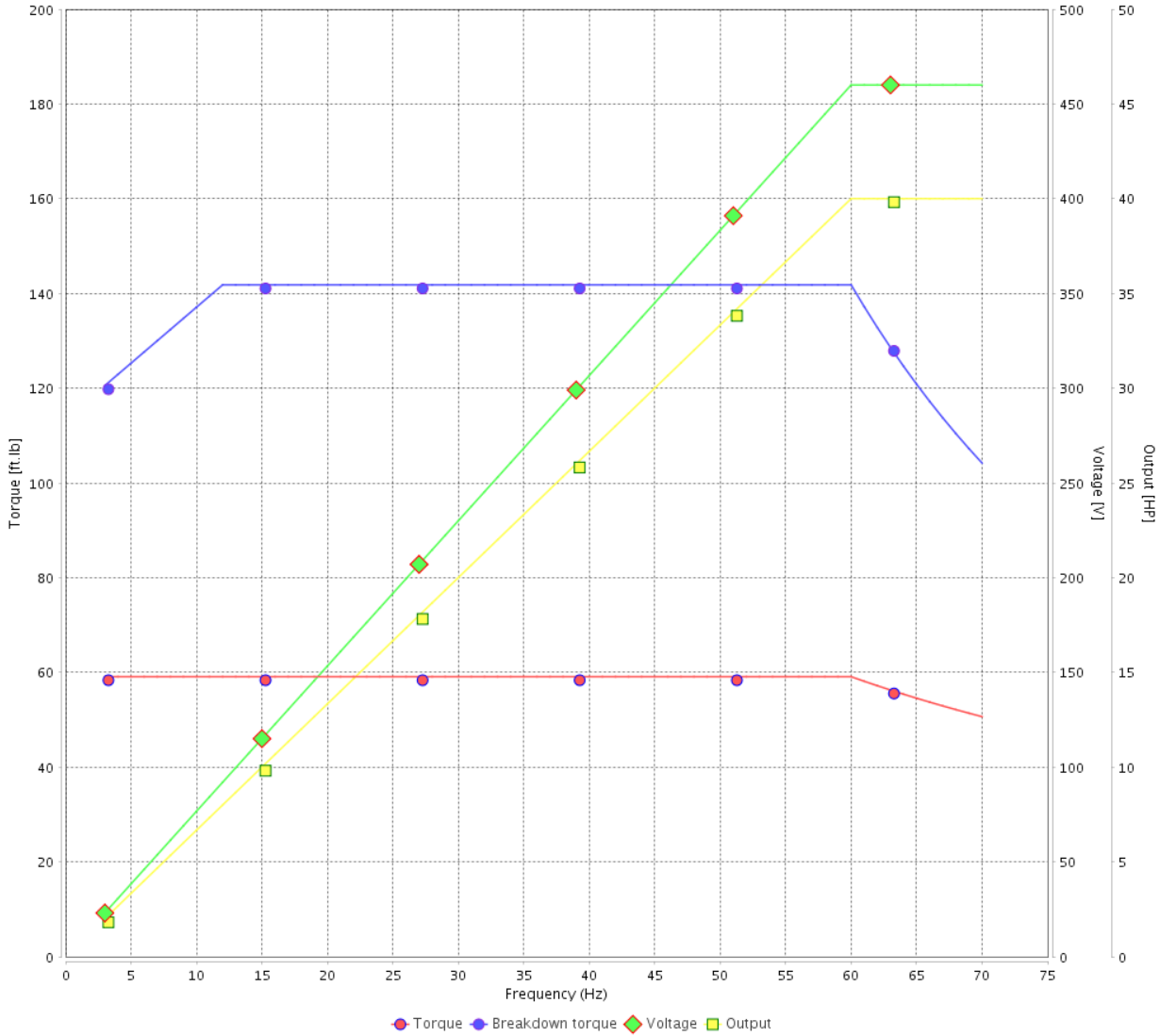

Performance : 460 V 60 Hz 2P

Rated current : 46.3 A
 LRC : 6.3
 Rated torque : 59.1 ft.lb
 Locked rotor torque : 250 %
 Breakdown torque : 240 %
 Rated speed : 3555 rpm

Moment of inertia (J) : 4.90 sq.ft.lb
 Duty cycle : Cont.(S1)
 Insulation class : F
 Service factor : 1.25
 Temperature rise : 80 K
 Design : B

Rev.	Changes Summary	Performed	Checked	Date
Performed by			Page 30 / 36	Revision
Checked by				
Date	12/04/2022			

VFD OPERATION CURVE

Three Phase Induction Motor - Squirrel Cage



Customer :

Product line : NEMA Premium Efficiency Three-Phase

Product code : 12447815

Catalog # : 04036ST3QIE324TS-W22

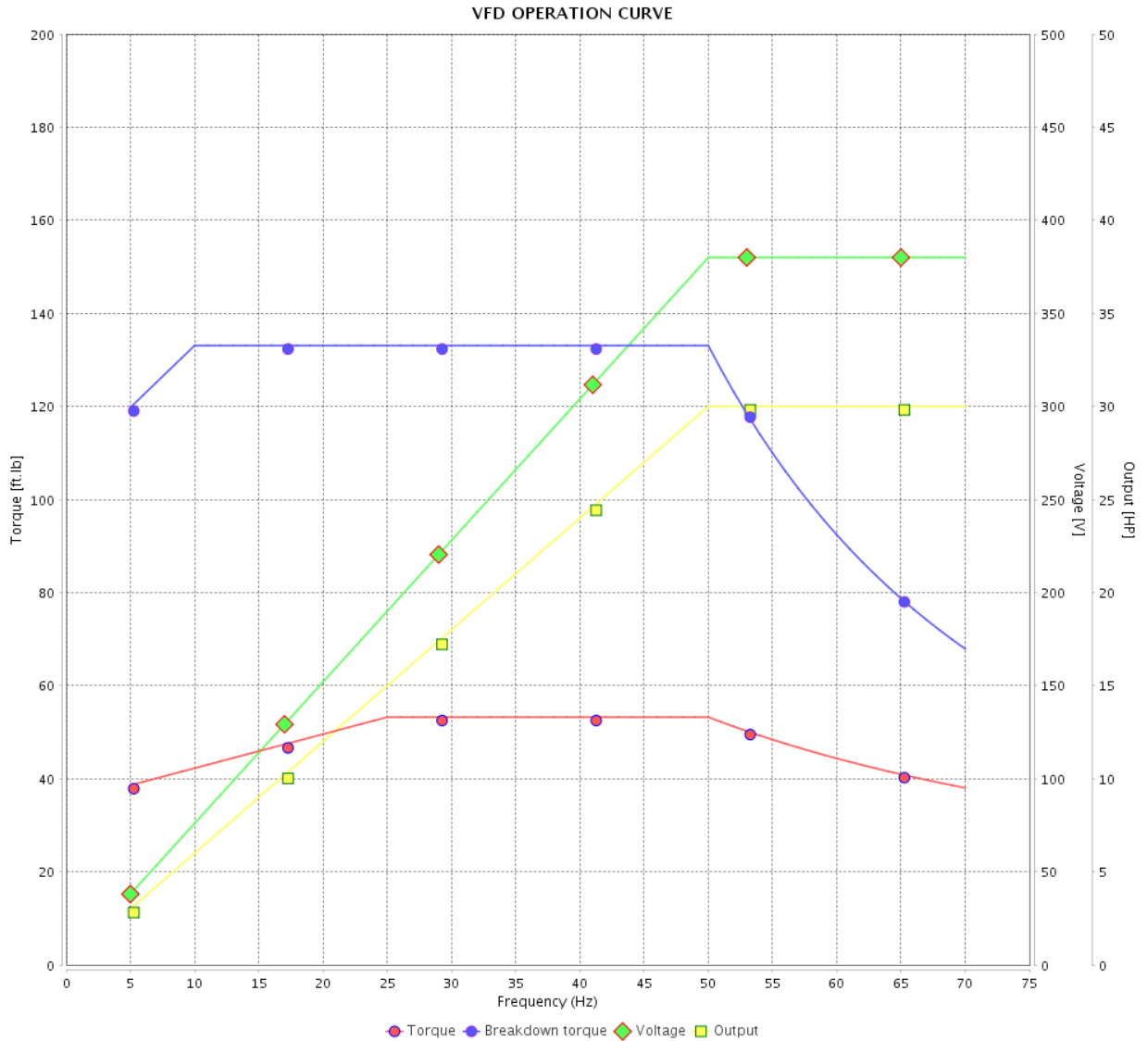

Performance : 380 V 50 Hz 2P IE3

Rated current : 41.0 A
 LRC : 7.2
 Rated torque : 53.2 ft.lb
 Locked rotor torque : 240 %
 Breakdown torque : 250 %
 Rated speed : 2960 rpm

Moment of inertia (J) : 4.90 sq.ft.lb
 Duty cycle : Cont.(S1)
 Insulation class : F
 Service factor : 1.00
 Temperature rise : 80 K
 Design : B

Rev.	Changes Summary	Performed	Checked	Date
Performed by		Page		Revision
Checked by		31 / 36		
Date		12/04/2022		

VFD OPERATION CURVE

Three Phase Induction Motor - Squirrel Cage



Customer :

Product line : NEMA Premium Efficiency Three-Phase

Product code : 12447815

Catalog # : 04036ST3QIE324TS-W22

VFD OPERATION CURVE

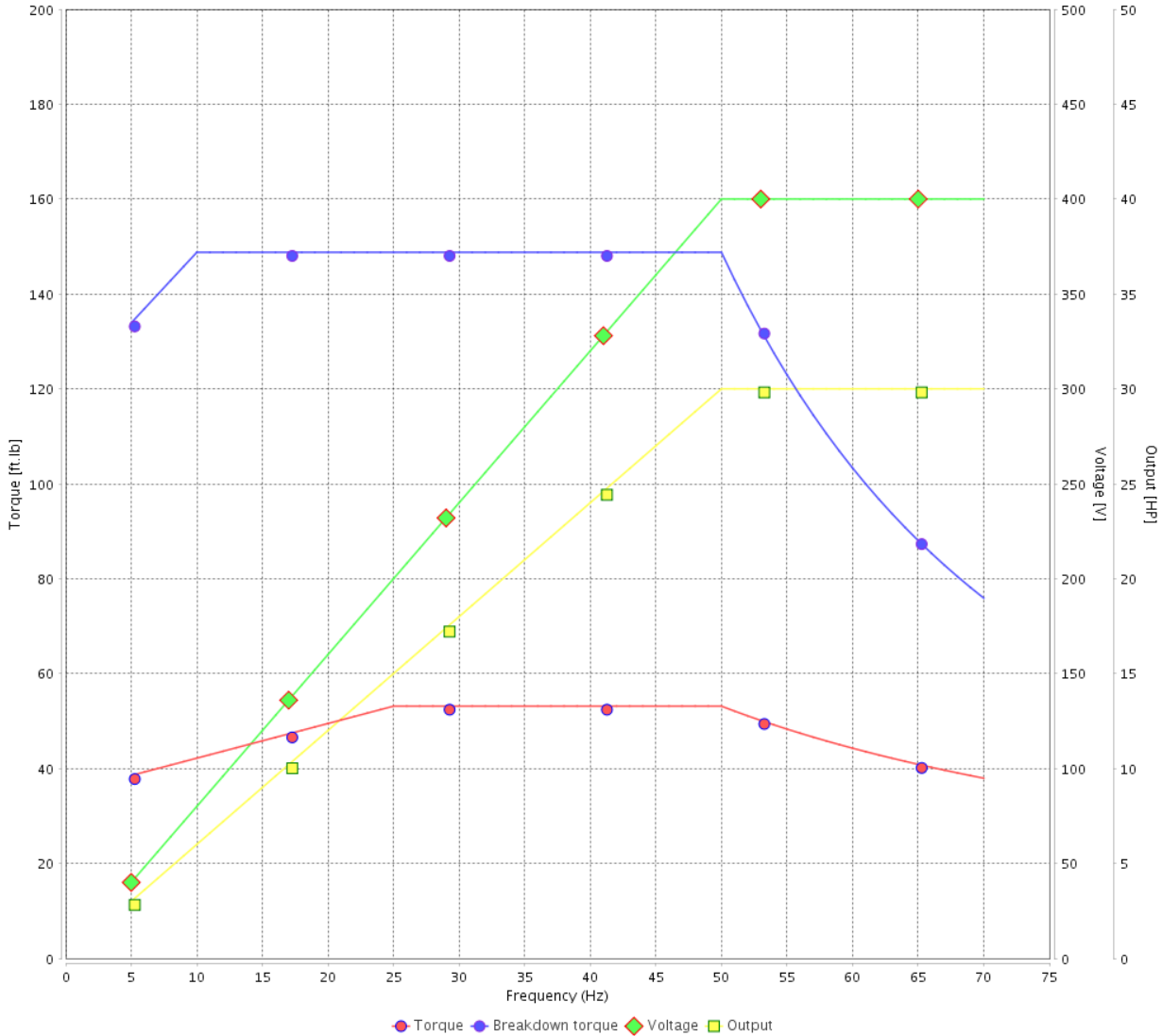

Performance : 400 V 50 Hz 2P IE3

Rated current : 39.4 A
 LRC : 7.5
 Rated torque : 53.1 ft.lb
 Locked rotor torque : 270 %
 Breakdown torque : 280 %
 Rated speed : 2965 rpm

Moment of inertia (J) : 4.90 sq.ft.lb
 Duty cycle : Cont.(S1)
 Insulation class : F
 Service factor : 1.00
 Temperature rise : 80 K
 Design : B

Rev.	Changes Summary	Performed	Checked	Date
Performed by			Page 32 / 36	Revision
Checked by				
Date	12/04/2022			

VFD OPERATION CURVE

Three Phase Induction Motor - Squirrel Cage



Customer :

Product line : NEMA Premium Efficiency Three-Phase

Product code : 12447815

Catalog # : 04036ST3QIE324TS-W22

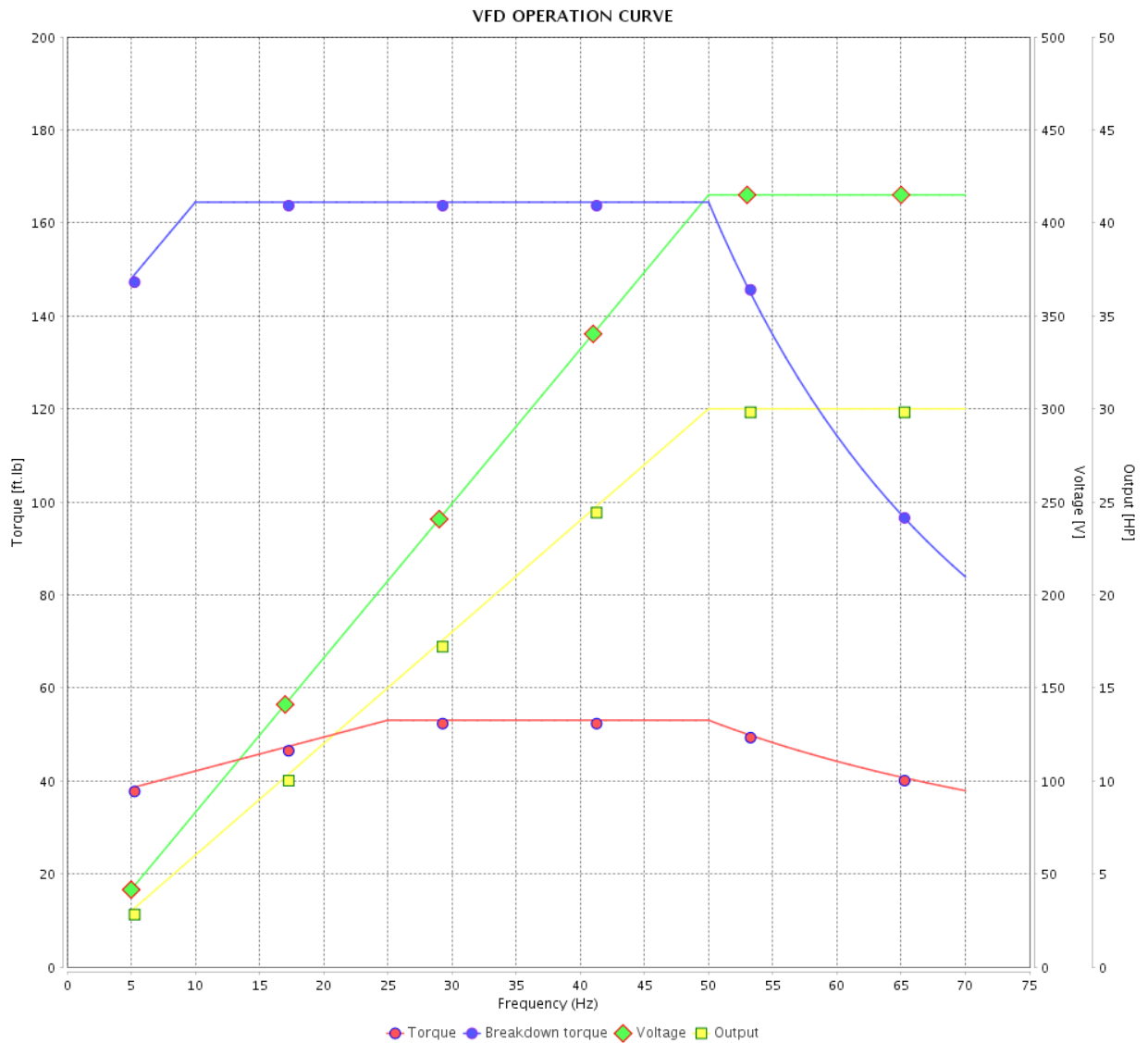

Performance : 415 V 50 Hz 2P IE3

Rated current : 38.4 A
 LRC : 7.6
 Rated torque : 53.0 ft.lb
 Locked rotor torque : 290 %
 Breakdown torque : 310 %
 Rated speed : 2970 rpm

Moment of inertia (J) : 4.90 sq.ft.lb
 Duty cycle : Cont.(S1)
 Insulation class : F
 Service factor : 1.00
 Temperature rise : 80 K
 Design : B

Rev.	Changes Summary	Performed	Checked	Date
Performed by		Page		Revision
Checked by		33 / 36		
Date		12/04/2022		

VFD OPERATION CURVE

Three Phase Induction Motor - Squirrel Cage



Customer :

Product line : NEMA Premium Efficiency Three-Phase

Product code : 12447815

Catalog # : 04036ST3QIE324TS-W22

VFD OPERATION CURVE

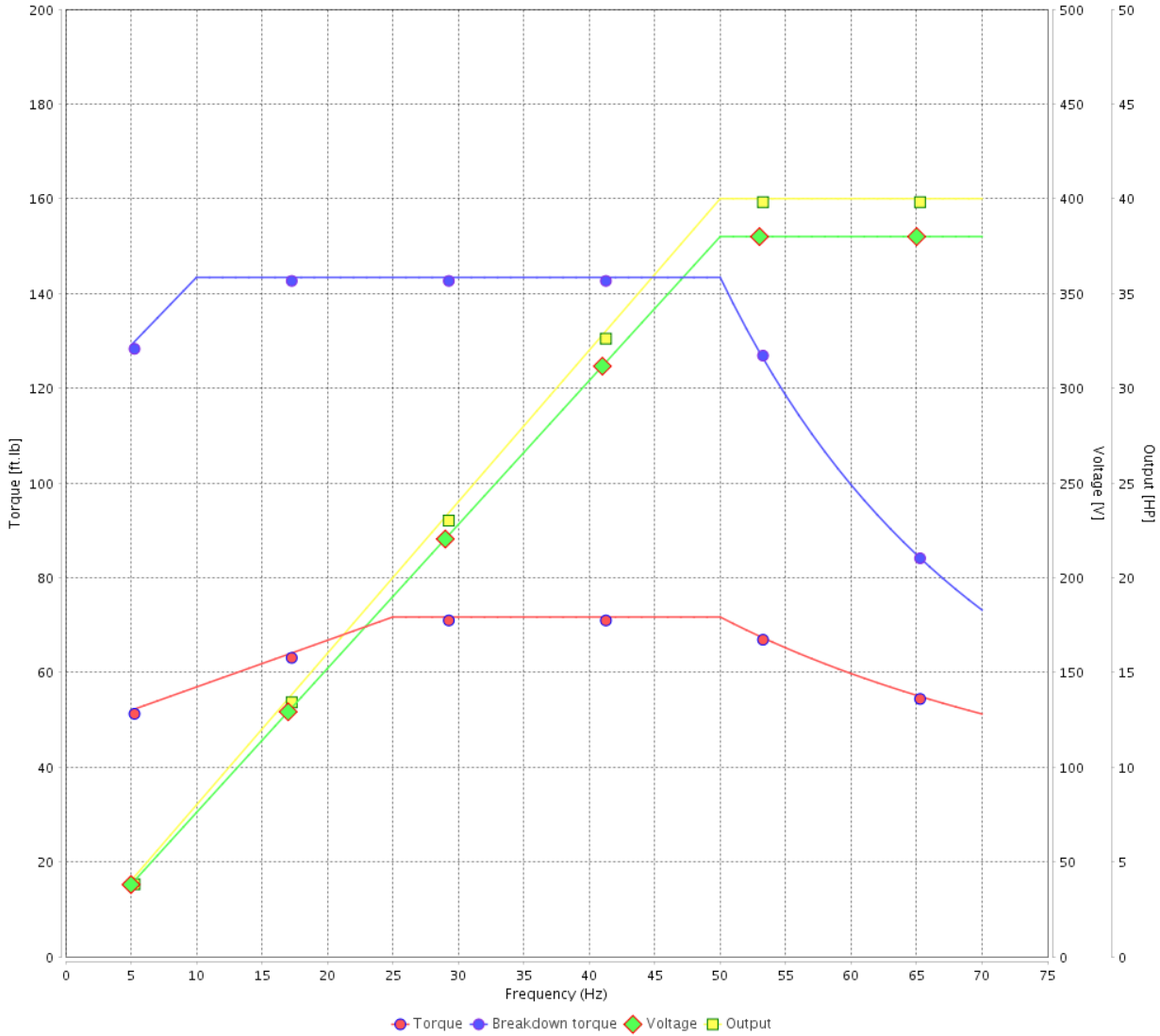

Performance : 380 V 50 Hz 2P IE1

Rated current	: 56.9 A	Moment of inertia (J)	: 4.90 sq.ft.lb
LRC	: 5.0	Duty cycle	: Cont.(S1)
Rated torque	: 71.7 ft.lb	Insulation class	: F
Locked rotor torque	: 180 %	Service factor	: 1.00
Breakdown torque	: 200 %	Temperature rise	: 105 K
Rated speed	: 2930 rpm	Design	: B

Rev.	Changes Summary	Performed	Checked	Date
Performed by		Page		Revision
Checked by		34 / 36		
Date	12/04/2022			

VFD OPERATION CURVE

Three Phase Induction Motor - Squirrel Cage



Customer :

Product line : NEMA Premium Efficiency Three-Phase

Product code : 12447815

Catalog # : 04036ST3QIE324TS-W22

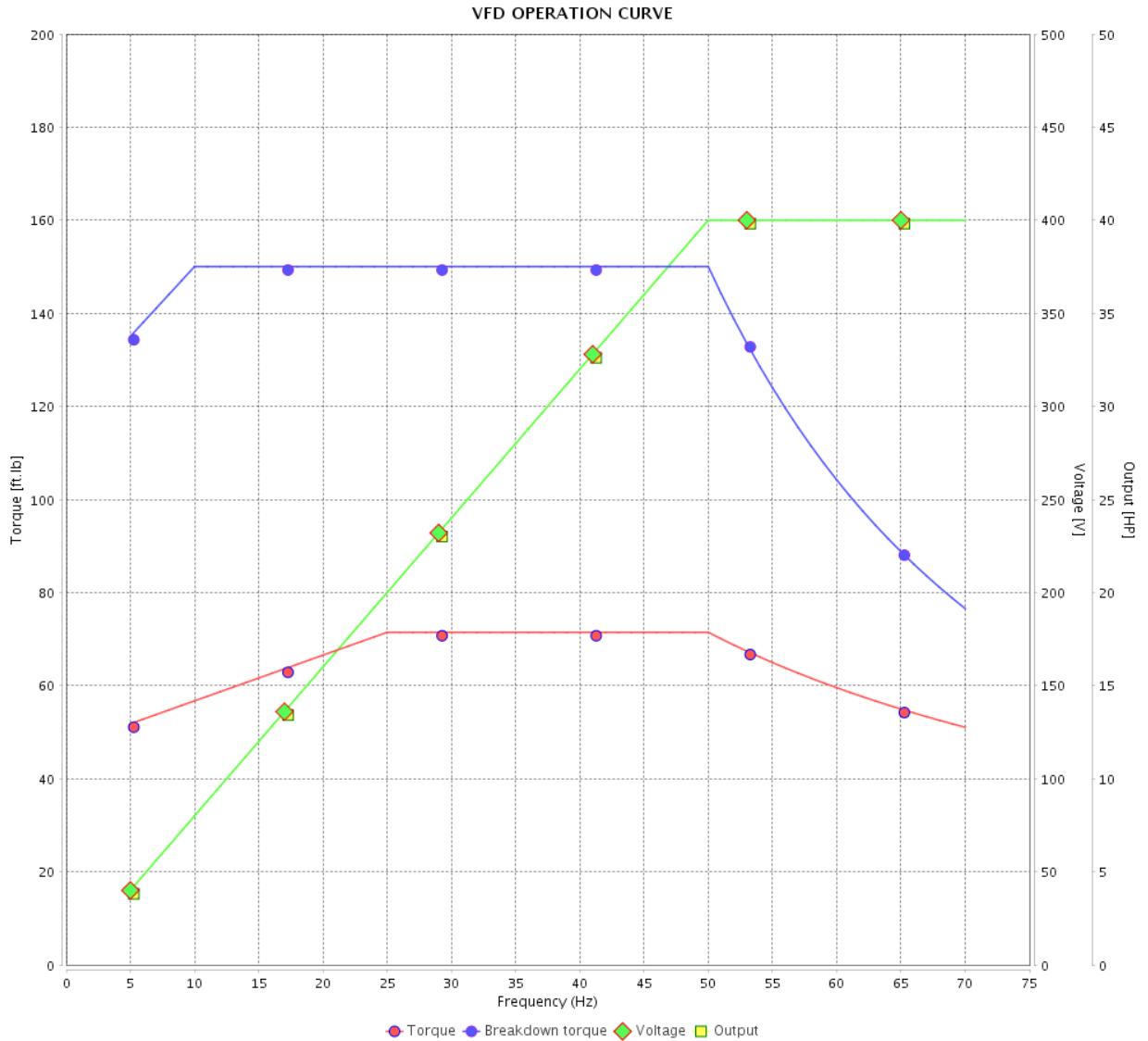

Performance : 400 V 50 Hz 2P IE1

Rated current : 53.7 A
 LRC : 5.6
 Rated torque : 71.4 ft.lb
 Locked rotor torque : 200 %
 Breakdown torque : 210 %
 Rated speed : 2940 rpm

Moment of inertia (J) : 4.90 sq.ft.lb
 Duty cycle : Cont.(S1)
 Insulation class : F
 Service factor : 1.00
 Temperature rise : 105 K
 Design : B

Rev.	Changes Summary	Performed	Checked	Date
Performed by		Page		Revision
Checked by		35 / 36		
Date		12/04/2022		

VFD OPERATION CURVE

Three Phase Induction Motor - Squirrel Cage



Customer :

Product line : NEMA Premium Efficiency Three-Phase

Product code : 12447815

Catalog # : 04036ST3QIE324TS-W22

VFD OPERATION CURVE

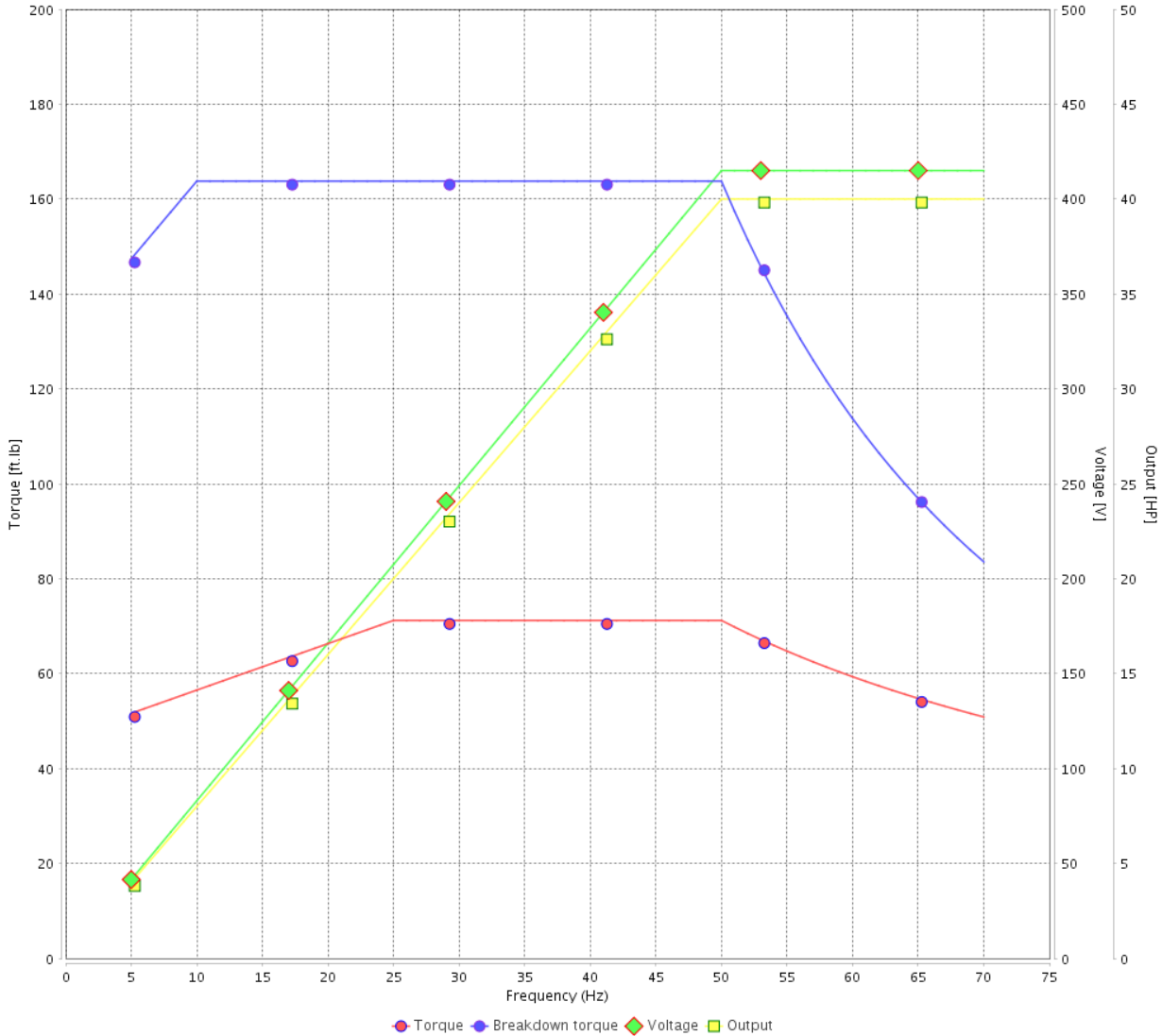

Performance : 415 V 50 Hz 2P IE1

Rated current	: 51.7 A	Moment of inertia (J)	: 4.90 sq.ft.lb
LRC	: 6.2	Duty cycle	: Cont.(S1)
Rated torque	: 71.2 ft.lb	Insulation class	: F
Locked rotor torque	: 220 %	Service factor	: 1.00
Breakdown torque	: 229 %	Temperature rise	: 105 K
Rated speed	: 2950 rpm	Design	: B

Rev.	Changes Summary	Performed	Checked	Date
Performed by			Page 36 / 36	Revision
Checked by				
Date	12/04/2022			

1 2 3 4 5 6

A

B

C

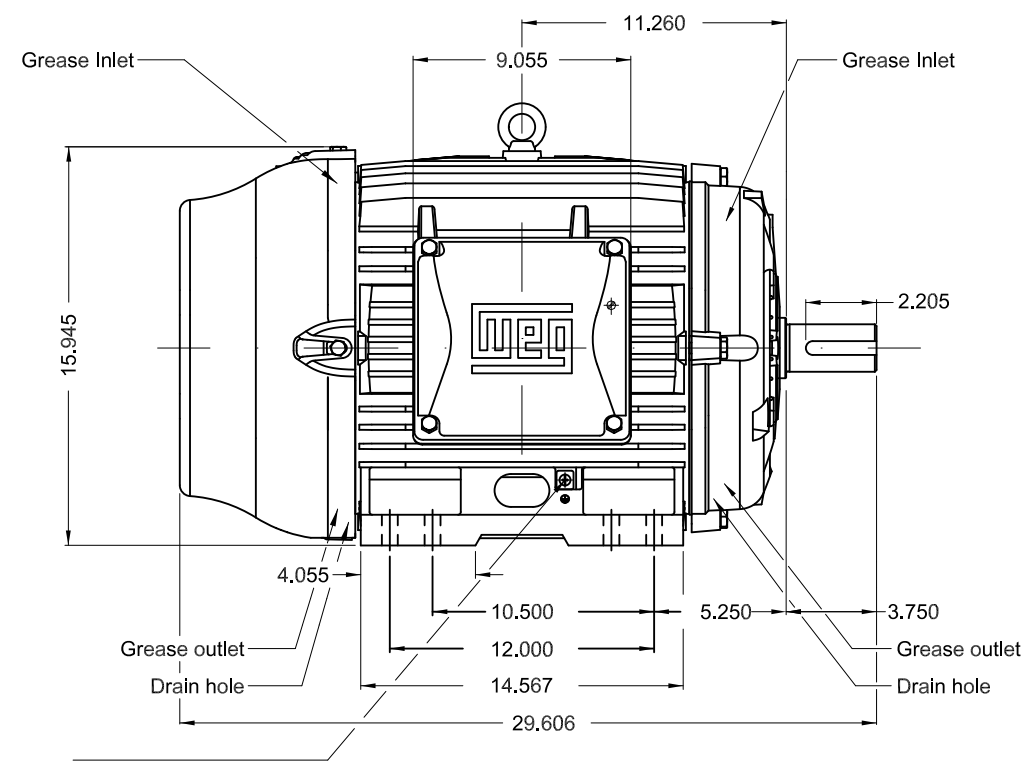
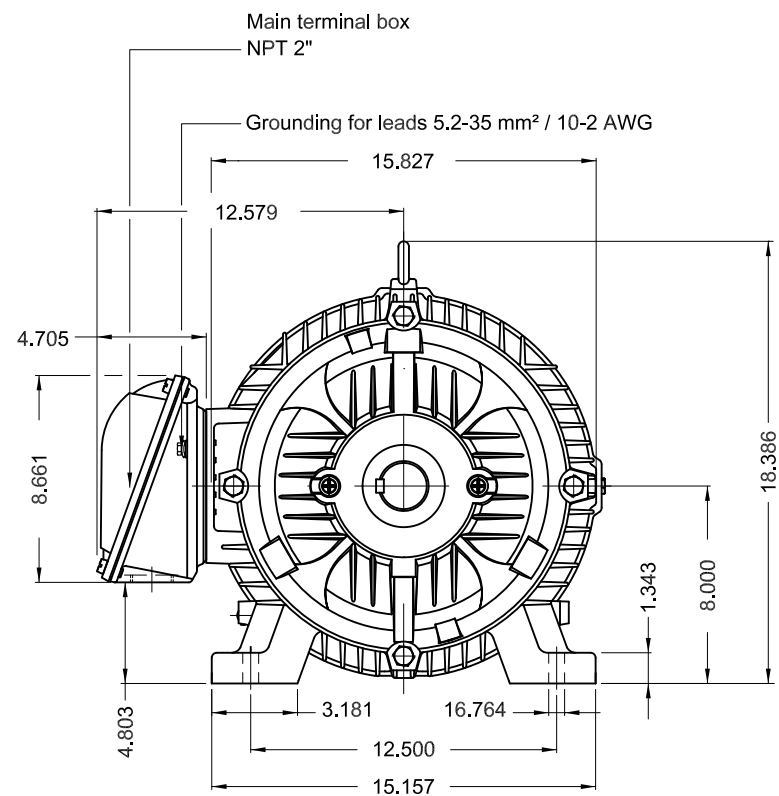

Grounding for leads 5.2-35 mm² / 10-2 AWG

D

E

Without vertical jackscrews
 Color RAL 5009
 Painting plan 202E
 Mounting B3R(D)

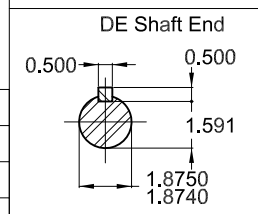

40 HP 02 Poles 60 Hz A

ECM	LOC	SUMMARY OF MODIFICATIONS	EXECUTED	CHECKED	RELEASED	DATE	VER
EXECUTED	PIRWBUSER	THREE PH. MOTOR IEEE 841 W22 PREM. EFF. FRAME 324/6TS IP55 TEFC					
CHECKED							
RELEASED							
REL DT.	WMO	Jaragua do Sul	Product Engineering	SHEET	1 / 1		

PREVIEW
WDD





NEMA
Premium
W22



FOR SAFE AREA
Mod.TE1BFOXON
CC029A



Class I, Div 2, Gr A, B, C and D - T3
Class I, Zone 2, IIC - T3
Class II, Div 2, Gr F and G - T4
For use on PWM: Gr. A, B, C, D and F,
VT 1000:1, CT 20:1, 1.00SF - T3A

MODEL 04036ST3QIE324TS-W22



Inverter Duty Motor
Severe Duty

MADE IN BRAZIL
12447815

PH3 60Hz Fr. 324/6TS 1000m.a.s.l. IP55 TEFC 535lb

V 460

A 46.3

HP 40

kW 30

SF 1.25

SFA 57.9

RPM 3555

PF 0.88

AMB 40°C

INS cl. F DT80K

NEMA NOM EFF 92.4%

DUTY CONT.

DES B Code G

GUARANT. EFF 91.0%

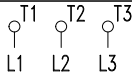

460V



→ 6312-C3 (21g) 60BC03X30

→ 6212-C3 (13g) 60BC02X30



MOBIL POLYREX EM (12000h)

