

# DATA SHEET



## Three Phase Induction Motor - Squirrel Cage

Customer :								
Product line	: NEMA Premium Efficiency Three-Phase	Product code :	11460238					
		Catalog # :	05018ET3E326TS-W22					
Frame	: 324/6TS	Cooling method	: IC411 - TEFC					
Insulation class	: F	Mounting	: F-1					
Duty cycle	: Cont.(S1)	Rotation <sup>1</sup>	: Both (CW and CCW)					
Ambient temperature	: -20°C to +40°C	Starting method	: Direct On Line					
Altitude	: 1000 m.a.s.l.	Approx. weight <sup>2</sup>	: 592 lb					
Protection degree	: IP55	Moment of inertia (J)	: 9.16 sq.ft.lb					
Design	: B							
Output [HP]	50	40	40	40	50	50	50	
Poles	4	4	4	4	4	4	4	
Frequency [Hz]	60	50	50	50	50	50	50	
Rated voltage [V]	230/460	380	400	415	380	400	415	
Rated current [A]	118/59.2	58.7	57.1	56.4	71.6	68.4	66.3	
L. R. Amperes [A]	734/367	376	400	417	372	397	411	
LRC [A]	6.2x(Code G)	6.4x(Code G)	7.0x(Code H)	7.4x(Code J)	5.2x(Code E)	5.8x(Code F)	6.2x(Code G)	
No load current [A]	47.0/23.5	23.0	24.0	25.0	23.0	24.0	25.0	
Rated speed [RPM]	1775	1470	1475	1478	1460	1465	1470	
Slip [%]	1.39	2.00	1.67	1.47	2.67	2.33	2.00	
Rated torque [ft.lb]	148	143	142	142	180	179	179	
Locked rotor torque [%]	229	229	250	260	180	200	210	
Breakdown torque [%]	270	260	300	330	210	240	260	
Service factor	1.25	1.00	1.00	1.00	1.00	1.00	1.00	
Temperature rise	80 K	80 K	80 K	80 K	105 K	105 K	105 K	
Locked rotor time	27s (cold) 15s (hot)	19s (cold) 11s (hot)	19s (cold) 11s (hot)	19s (cold) 11s (hot)	19s (cold) 11s (hot)	19s (cold) 11s (hot)	19s (cold) 11s (hot)	
Noise level <sup>2</sup>	66.0 dB(A)	63.0 dB(A)	63.0 dB(A)	63.0 dB(A)	63.0 dB(A)	63.0 dB(A)	63.0 dB(A)	
Efficiency (%)	25%	92.5	91.9	90.6	90.8	93.3	92.2	91.8
	50%	93.0	92.5	91.5	91.5	93.0	92.4	92.4
	75%	94.1	93.1	92.8	93.0	93.0	93.0	93.0
	100%	94.5	93.6	93.6	93.6	92.4	93.0	93.5
Power Factor	25%	0.42	0.41	0.38	0.35	0.48	0.45	0.42
	50%	0.66	0.64	0.60	0.57	0.72	0.68	0.65
	75%	0.77	0.77	0.73	0.70	0.81	0.79	0.76
	100%	0.83	0.83	0.81	0.79	0.85	0.84	0.83
Bearing type	: 6312 C3	6212 C3	Foundation loads					
Sealing	: V'Ring	V'Ring	Max. traction	: 1486 lb				
Lubrication interval	: 20000 h	20000 h	Max. compression	: 2078 lb				
Lubricant amount	: 21 g	13 g						
Lubricant type	: Mobil Polyrex EM							
Notes								
USABLE @208V 131A SF 1.15 SFA 151A								
This revision replaces and cancel the previous one, which must be eliminated. (1) Looking the motor from the shaft end. (2) Measured at 1m and with tolerance of +3dB(A). (3) Approximate weight subject to changes after manufacturing process. (4) At 100% of full load.				These are average values based on tests with sinusoidal power supply, subject to the tolerances stipulated in NEMA MG-1.				
Rev.	Changes Summary			Performed	Checked	Date		
Performed by								
Checked by					Page	Revision		
Date	12/04/2022				1 / 36			

# TORQUE AND CURRENT VS SPEED CURVE

Three Phase Induction Motor - Squirrel Cage



Customer :

Product line : NEMA Premium Efficiency Three-Phase

Product code : 11460238

Catalog # : 05018ET3E326TS-W22

TORQUE AND CURRENT VS SPEED CURVE

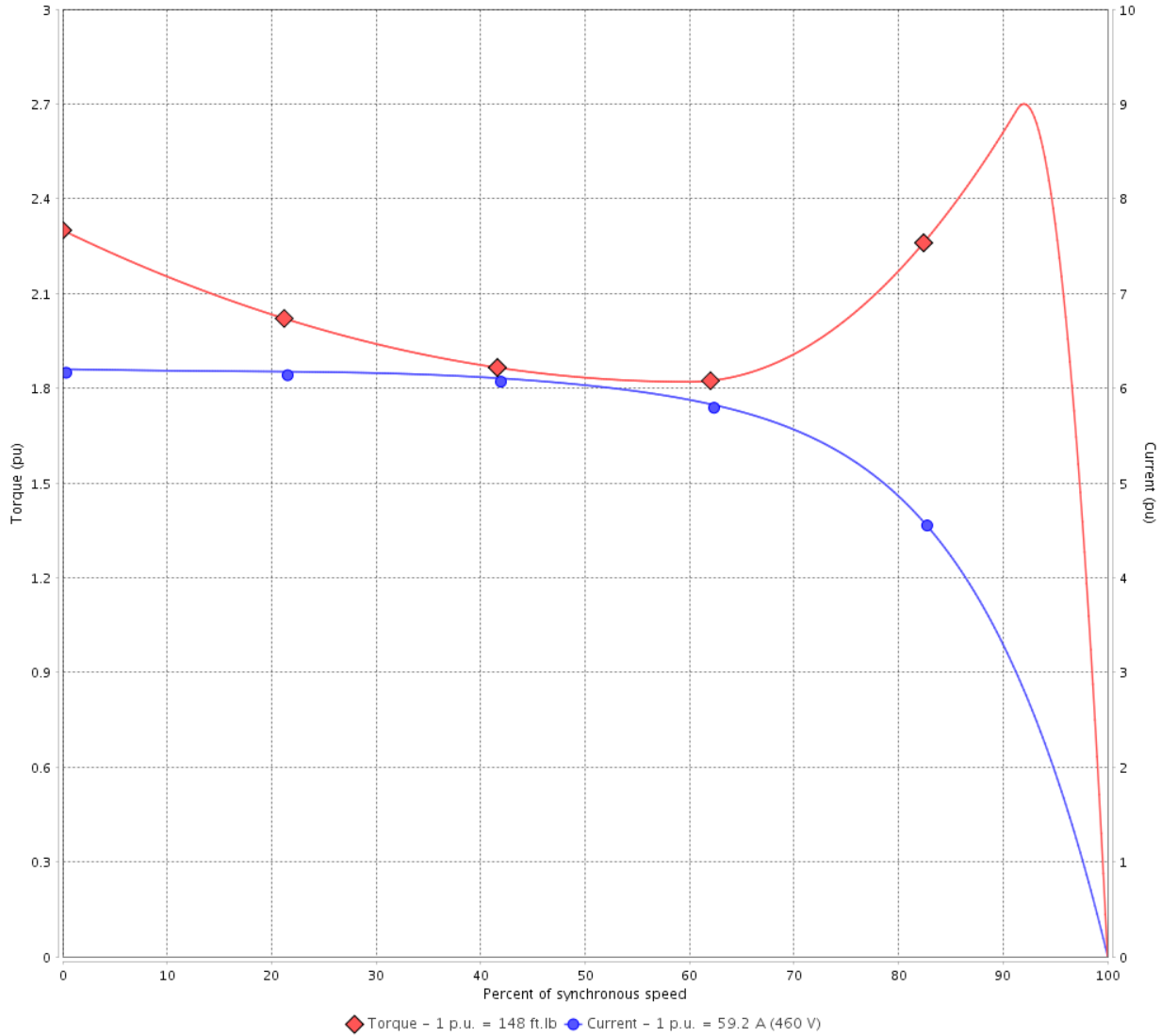

Performance : 230/460 V 60 Hz 4P

Rated current	: 118/59.2 A	Moment of inertia (J)	: 9.16 sq.ft.lb
LRC	: 6.2	Duty cycle	: Cont.(S1)
Rated torque	: 148 ft.lb	Insulation class	: F
Locked rotor torque	: 229 %	Service factor	: 1.25
Breakdown torque	: 270 %	Temperature rise	: 80 K
Rated speed	: 1775 rpm	Design	: B

Locked rotor time : 27s (cold) 15s (hot)

Rev.	Changes Summary	Performed	Checked	Date
Performed by			Page 2 / 36	Revision
Checked by				
Date	12/04/2022			

# TORQUE AND CURRENT VS SPEED CURVE



## Three Phase Induction Motor - Squirrel Cage

Customer :

Product line : NEMA Premium Efficiency Three-Phase

Product code : 11460238

Catalog # : 05018ET3E326TS-W22

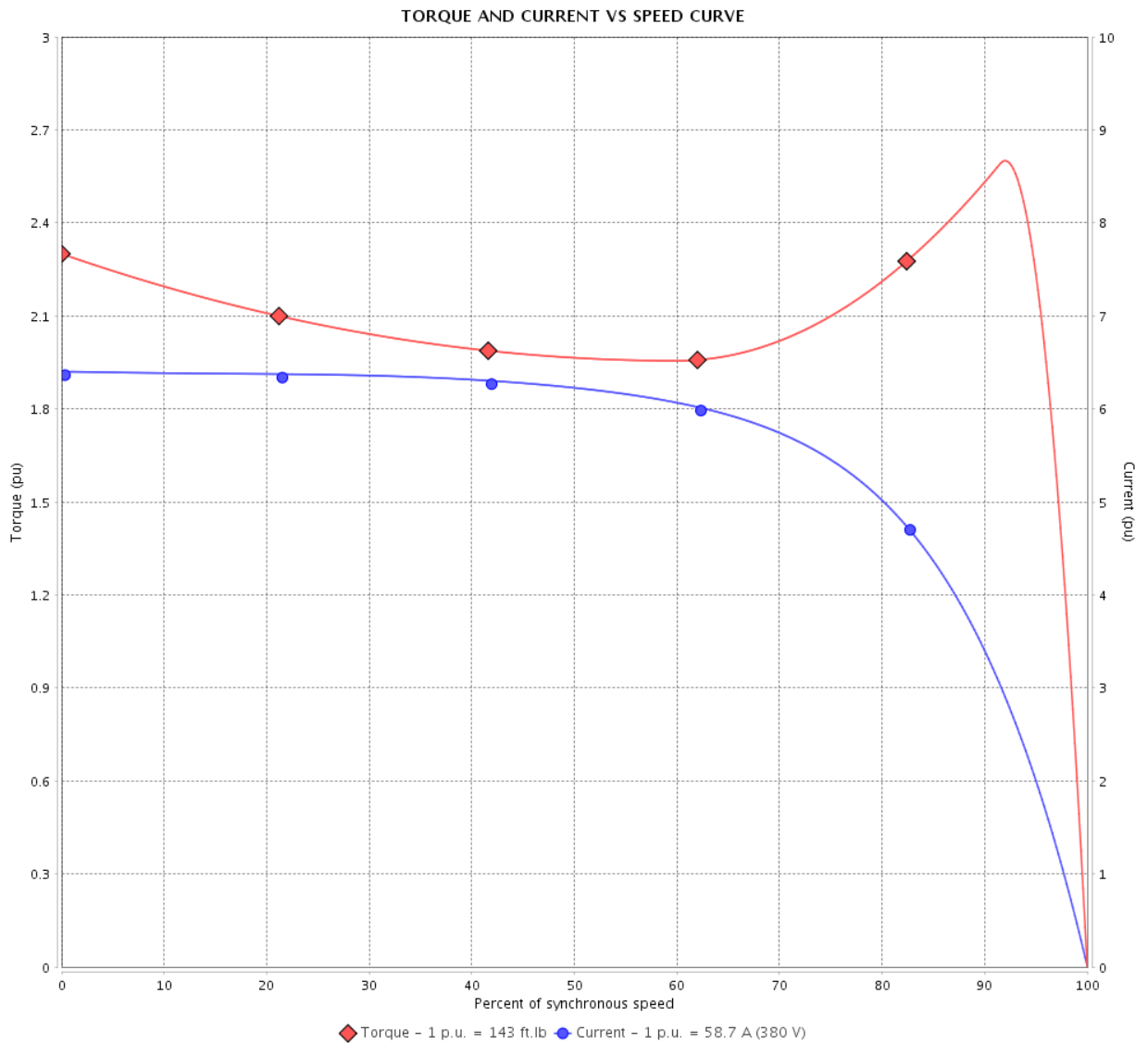

Performance : 380 V 50 Hz 4P IE3

Rated current	: 58.7 A	Moment of inertia (J)	: 9.16 sq.ft.lb
LRC	: 6.4	Duty cycle	: Cont.(S1)
Rated torque	: 143 ft.lb	Insulation class	: F
Locked rotor torque	: 229 %	Service factor	: 1.00
Breakdown torque	: 260 %	Temperature rise	: 80 K
Rated speed	: 1470 rpm	Design	: B

Locked rotor time : 19s (cold) 11s (hot)

Rev.	Changes Summary	Performed	Checked	Date
Performed by			Page 3 / 36	Revision
Checked by				
Date	12/04/2022			

# TORQUE AND CURRENT VS SPEED CURVE

Three Phase Induction Motor - Squirrel Cage



Customer :

Product line : NEMA Premium Efficiency Three-Phase

Product code : 11460238

Catalog # : 05018ET3E326TS-W22

TORQUE AND CURRENT VS SPEED CURVE

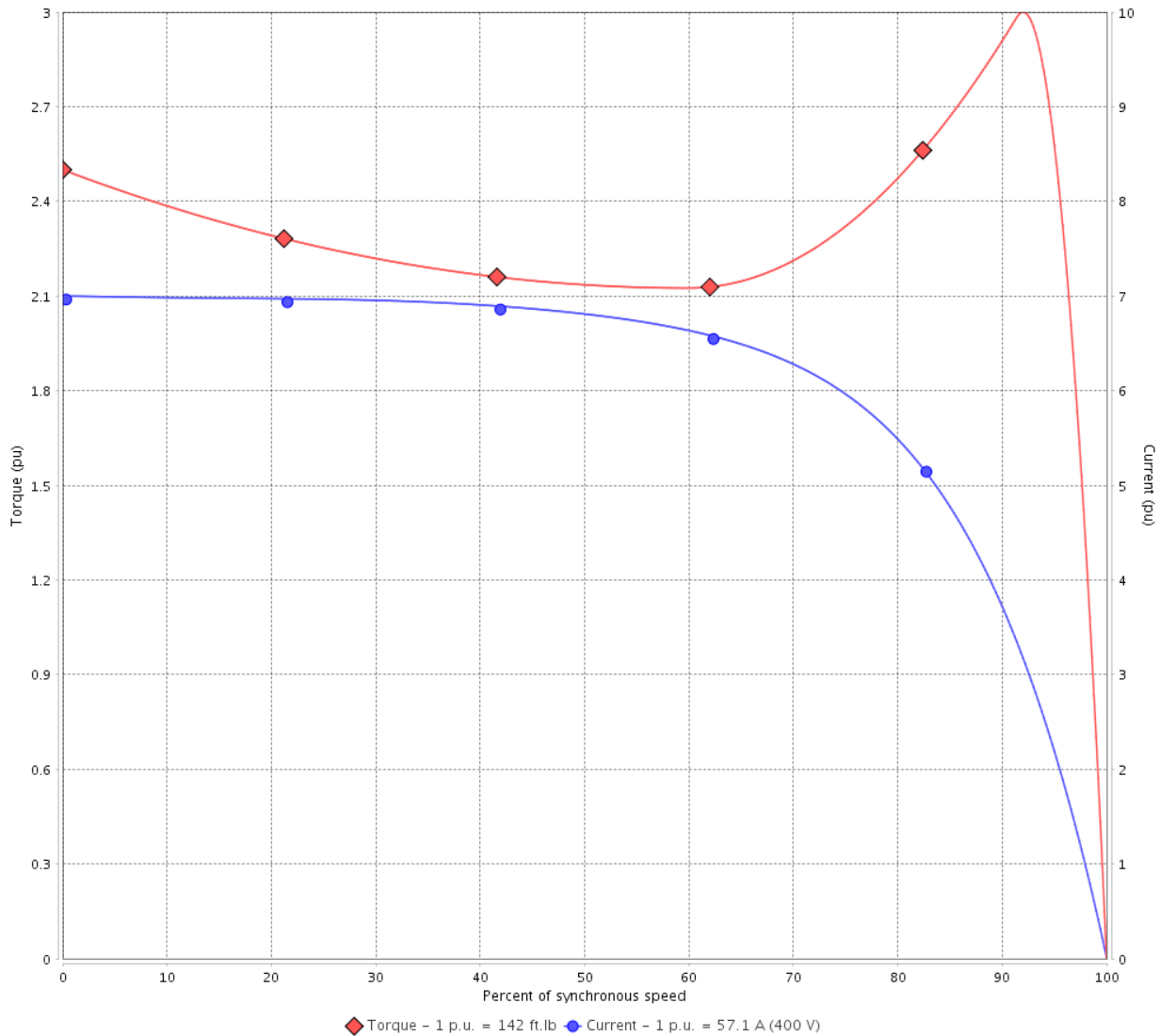

Performance : 400 V 50 Hz 4P IE3

Rated current	: 57.1 A	Moment of inertia (J)	: 9.16 sq.ft.lb
LRC	: 7.0	Duty cycle	: Cont.(S1)
Rated torque	: 142 ft.lb	Insulation class	: F
Locked rotor torque	: 250 %	Service factor	: 1.00
Breakdown torque	: 300 %	Temperature rise	: 80 K
Rated speed	: 1475 rpm	Design	: B

Locked rotor time : 19s (cold) 11s (hot)

Rev.	Changes Summary	Performed	Checked	Date
Performed by			Page 4 / 36	Revision
Checked by				
Date	12/04/2022			

# TORQUE AND CURRENT VS SPEED CURVE



## Three Phase Induction Motor - Squirrel Cage

Customer :

Product line : NEMA Premium Efficiency Three-Phase

Product code : 11460238

Catalog # : 05018ET3E326TS-W22

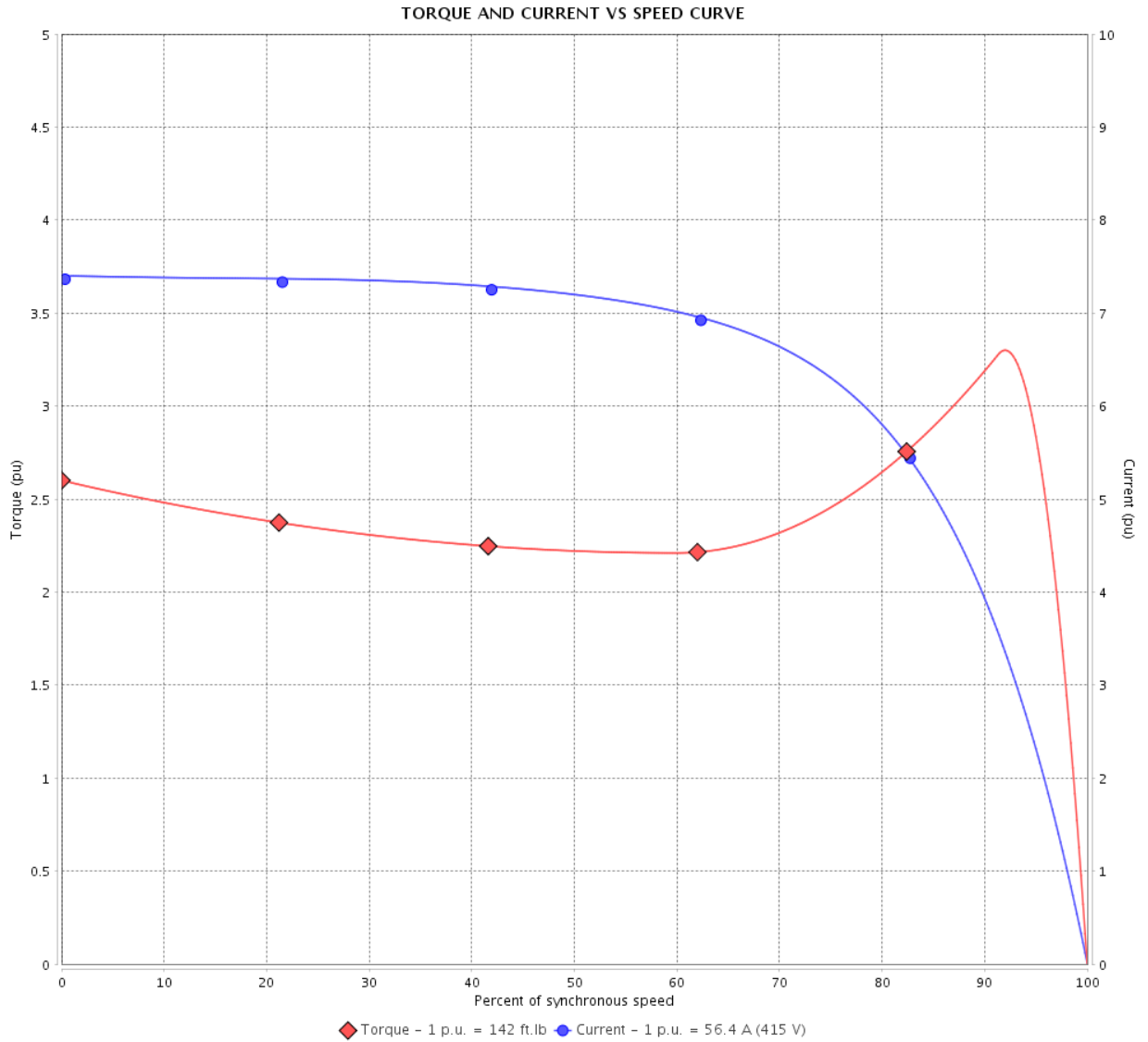

Performance : 415 V 50 Hz 4P IE3

Rated current	: 56.4 A	Moment of inertia (J)	: 9.16 sq.ft.lb
LRC	: 7.4	Duty cycle	: Cont.(S1)
Rated torque	: 142 ft.lb	Insulation class	: F
Locked rotor torque	: 260 %	Service factor	: 1.00
Breakdown torque	: 330 %	Temperature rise	: 80 K
Rated speed	: 1478 rpm	Design	: B

Locked rotor time : 19s (cold) 11s (hot)

Rev.	Changes Summary	Performed	Checked	Date
Performed by			Page 5 / 36	Revision
Checked by				
Date	12/04/2022			

# TORQUE AND CURRENT VS SPEED CURVE

## Three Phase Induction Motor - Squirrel Cage



Customer :

Product line : NEMA Premium Efficiency Three-Phase

Product code : 11460238

Catalog # : 05018ET3E326TS-W22

TORQUE AND CURRENT VS SPEED CURVE

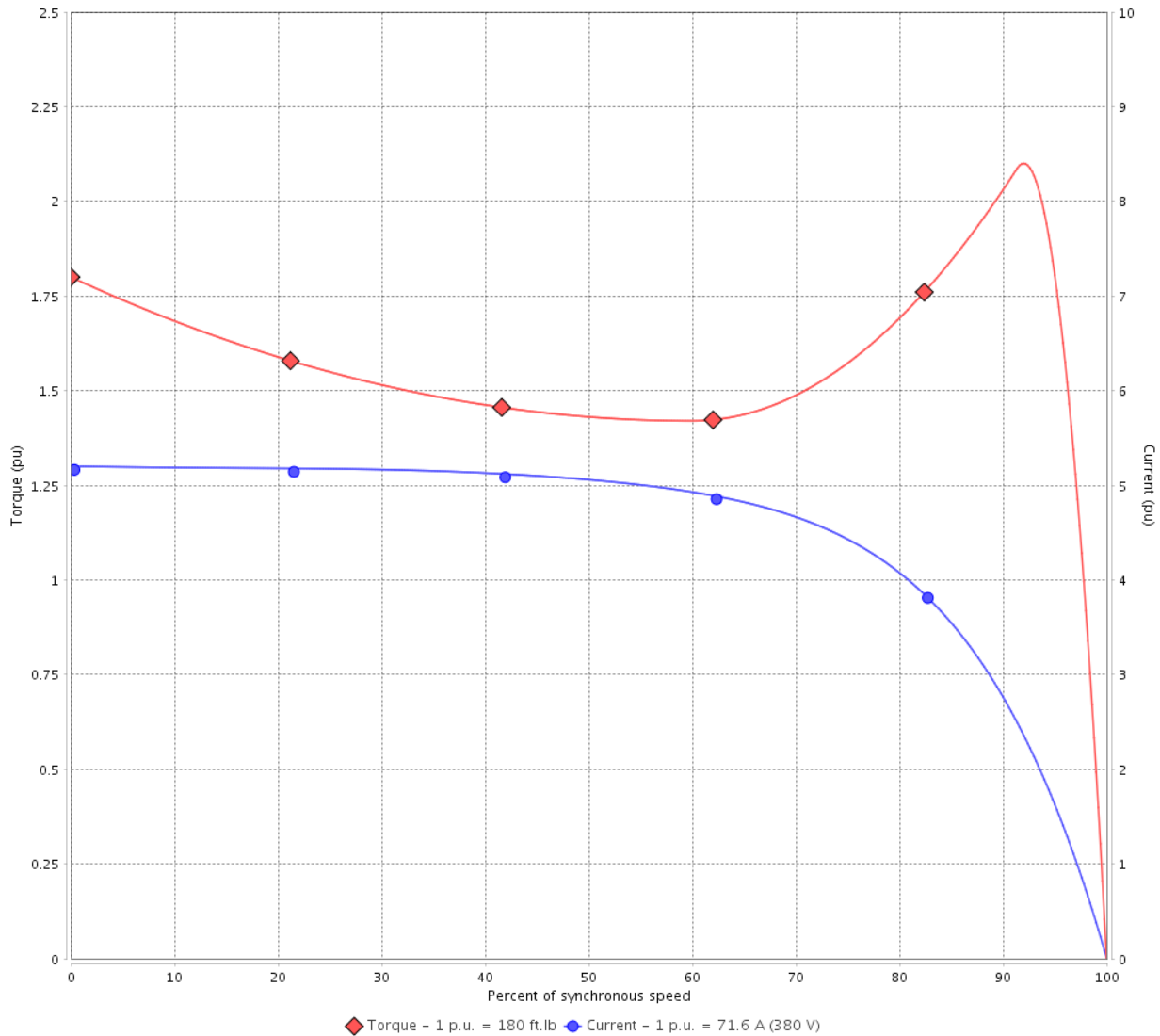

Performance : 380 V 50 Hz 4P IE1

Rated current	: 71.6 A	Moment of inertia (J)	: 9.16 sq.ft.lb
LRC	: 5.2	Duty cycle	: Cont.(S1)
Rated torque	: 180 ft.lb	Insulation class	: F
Locked rotor torque	: 180 %	Service factor	: 1.00
Breakdown torque	: 210 %	Temperature rise	: 105 K
Rated speed	: 1460 rpm	Design	: B

Locked rotor time : 19s (cold) 11s (hot)

Rev.	Changes Summary	Performed	Checked	Date
Performed by			Page 6 / 36	Revision
Checked by				
Date	12/04/2022			

# TORQUE AND CURRENT VS SPEED CURVE



## Three Phase Induction Motor - Squirrel Cage

Customer :

Product line : NEMA Premium Efficiency Three-Phase

Product code : 11460238

Catalog # : 05018ET3E326TS-W22

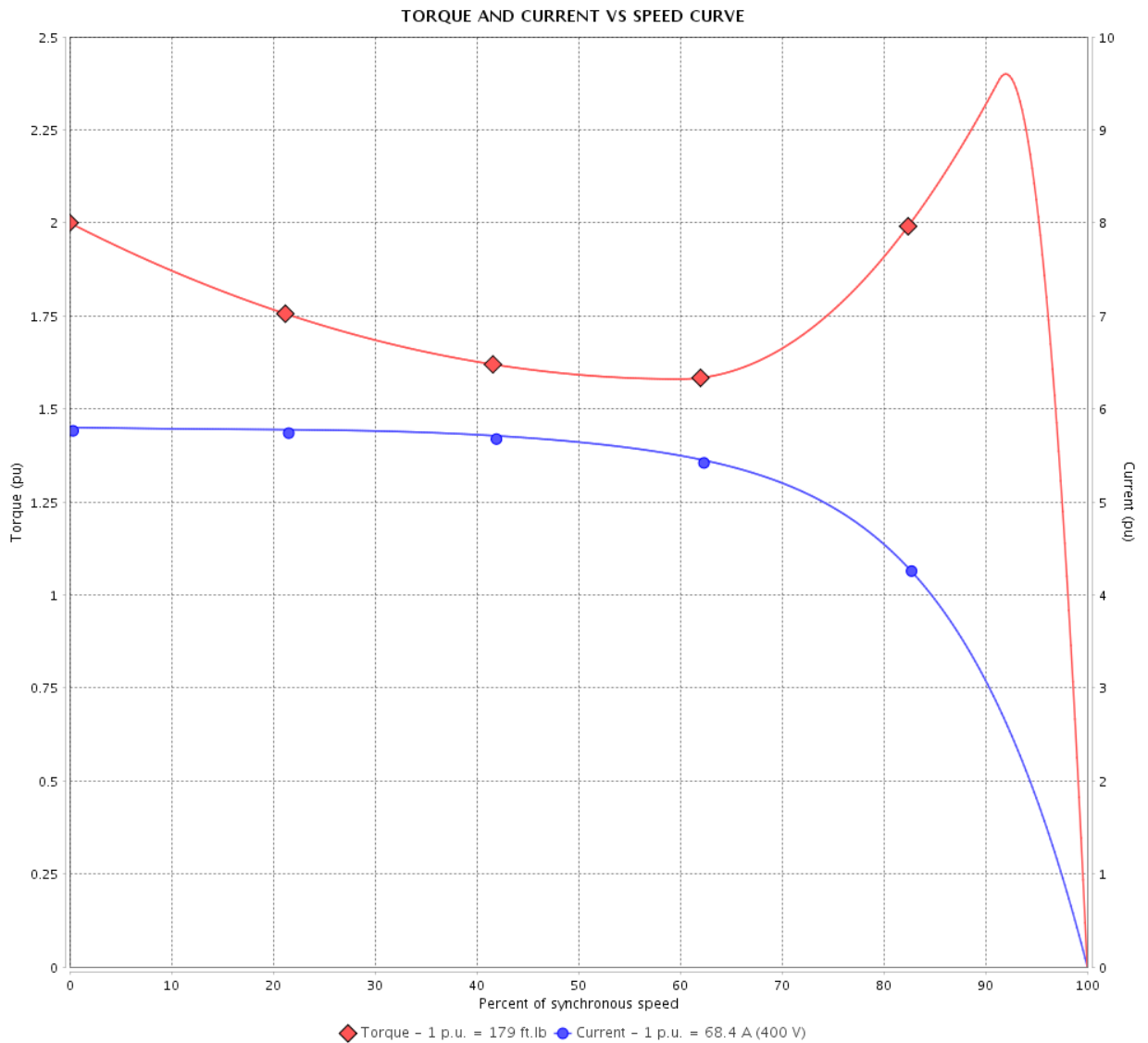

Performance : 400 V 50 Hz 4P IE2

Rated current	: 68.4 A	Moment of inertia (J)	: 9.16 sq.ft.lb
LRC	: 5.8	Duty cycle	: Cont.(S1)
Rated torque	: 179 ft.lb	Insulation class	: F
Locked rotor torque	: 200 %	Service factor	: 1.00
Breakdown torque	: 240 %	Temperature rise	: 105 K
Rated speed	: 1465 rpm	Design	: B

Locked rotor time : 19s (cold) 11s (hot)

Rev.	Changes Summary	Performed	Checked	Date
Performed by			Page	Revision
Checked by			7 / 36	
Date	12/04/2022			

# TORQUE AND CURRENT VS SPEED CURVE

## Three Phase Induction Motor - Squirrel Cage



Customer :

Product line : NEMA Premium Efficiency Three-Phase

Product code : 11460238

Catalog # : 05018ET3E326TS-W22

TORQUE AND CURRENT VS SPEED CURVE

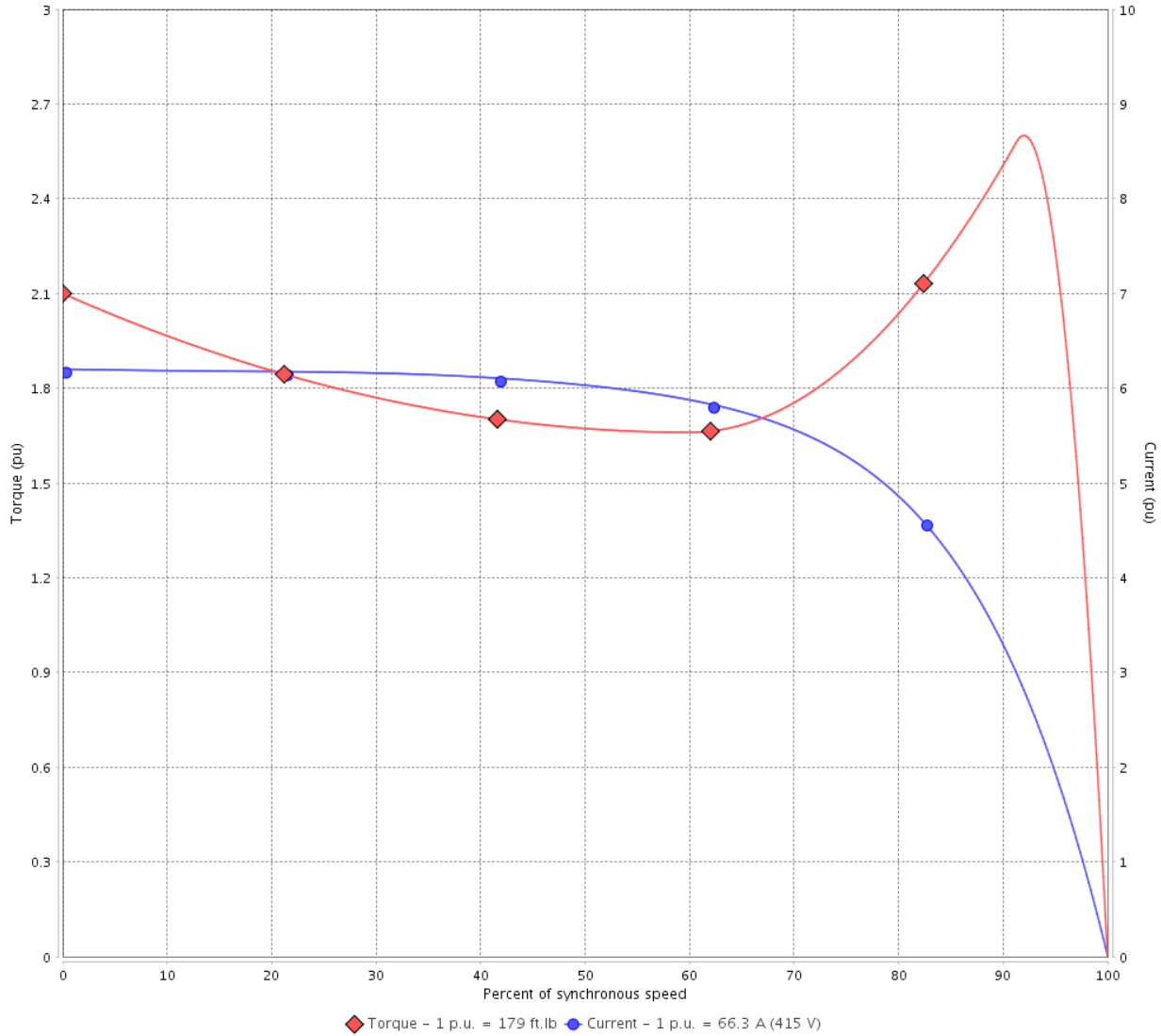

Performance : 415 V 50 Hz 4P IE2

Rated current	: 66.3 A	Moment of inertia (J)	: 9.16 sq.ft.lb
LRC	: 6.2	Duty cycle	: Cont.(S1)
Rated torque	: 179 ft.lb	Insulation class	: F
Locked rotor torque	: 210 %	Service factor	: 1.00
Breakdown torque	: 260 %	Temperature rise	: 105 K
Rated speed	: 1470 rpm	Design	: B

Locked rotor time : 19s (cold) 11s (hot)

Rev.	Changes Summary	Performed	Checked	Date
Performed by			Page 8 / 36	Revision
Checked by				
Date	12/04/2022			



# LOAD PERFORMANCE CURVE

## Three Phase Induction Motor - Squirrel Cage



Customer : \_\_\_\_\_

Product line : NEMA Premium Efficiency Three-Phase

Product code : 11460238

Catalog # : 05018ET3E326TS-W22

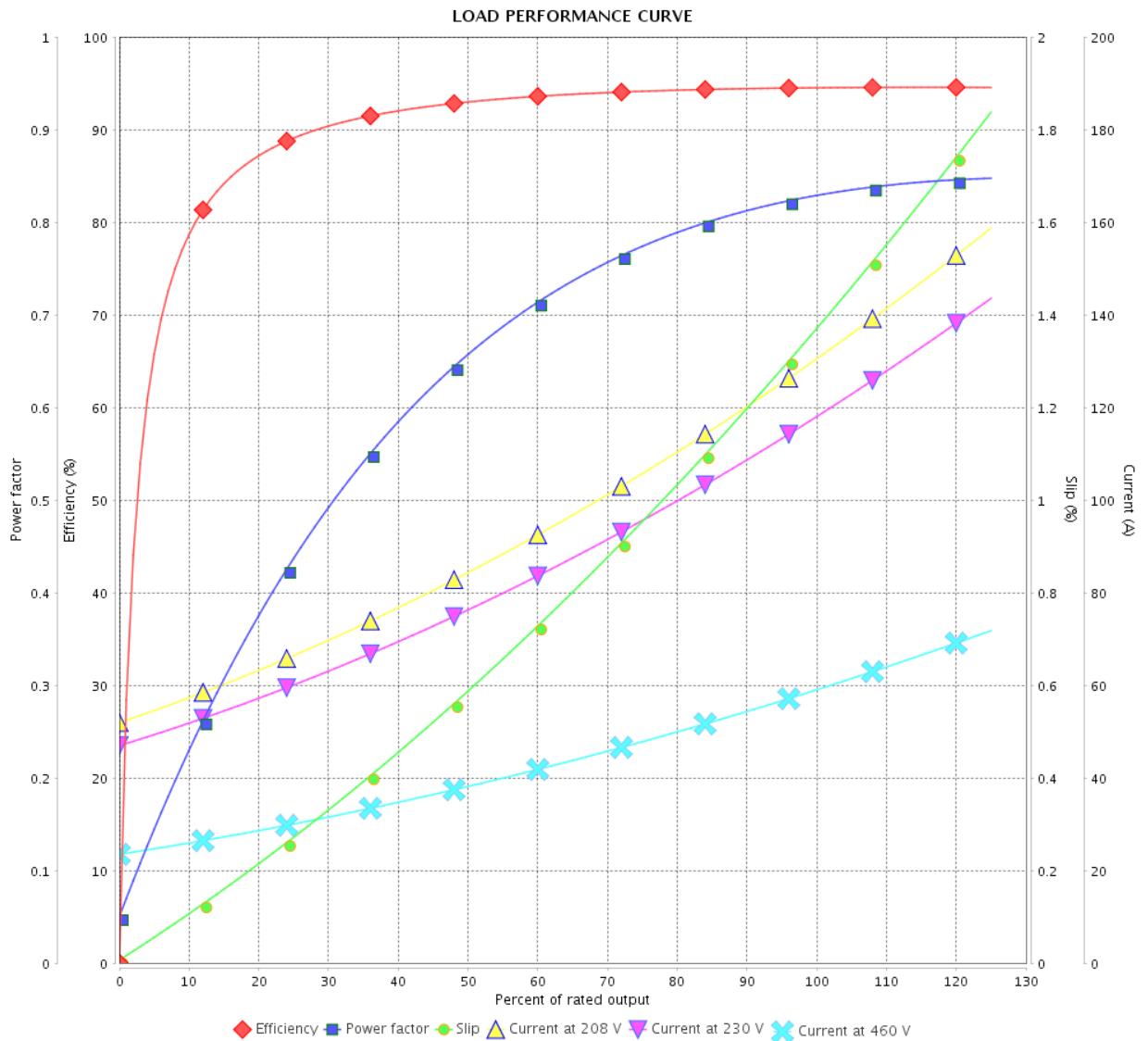

Performance : 230/460 V 60 Hz 4P

Rated current : 118/59.2 A  
 LRC : 6.2  
 Rated torque : 148 ft.lb  
 Locked rotor torque : 229 %  
 Breakdown torque : 270 %  
 Rated speed : 1775 rpm

Moment of inertia (J) : 9.16 sq.ft.lb  
 Duty cycle : Cont.(S1)  
 Insulation class : F  
 Service factor : 1.25  
 Temperature rise : 80 K  
 Design : B

Rev.	Changes Summary	Performed	Checked	Date
Performed by			Page	Revision
Checked by				
Date				

# LOAD PERFORMANCE CURVE

Three Phase Induction Motor - Squirrel Cage



Customer :

Product line : NEMA Premium Efficiency Three-Phase

Product code : 11460238

Catalog # : 05018ET3E326TS-W22

LOAD PERFORMANCE CURVE

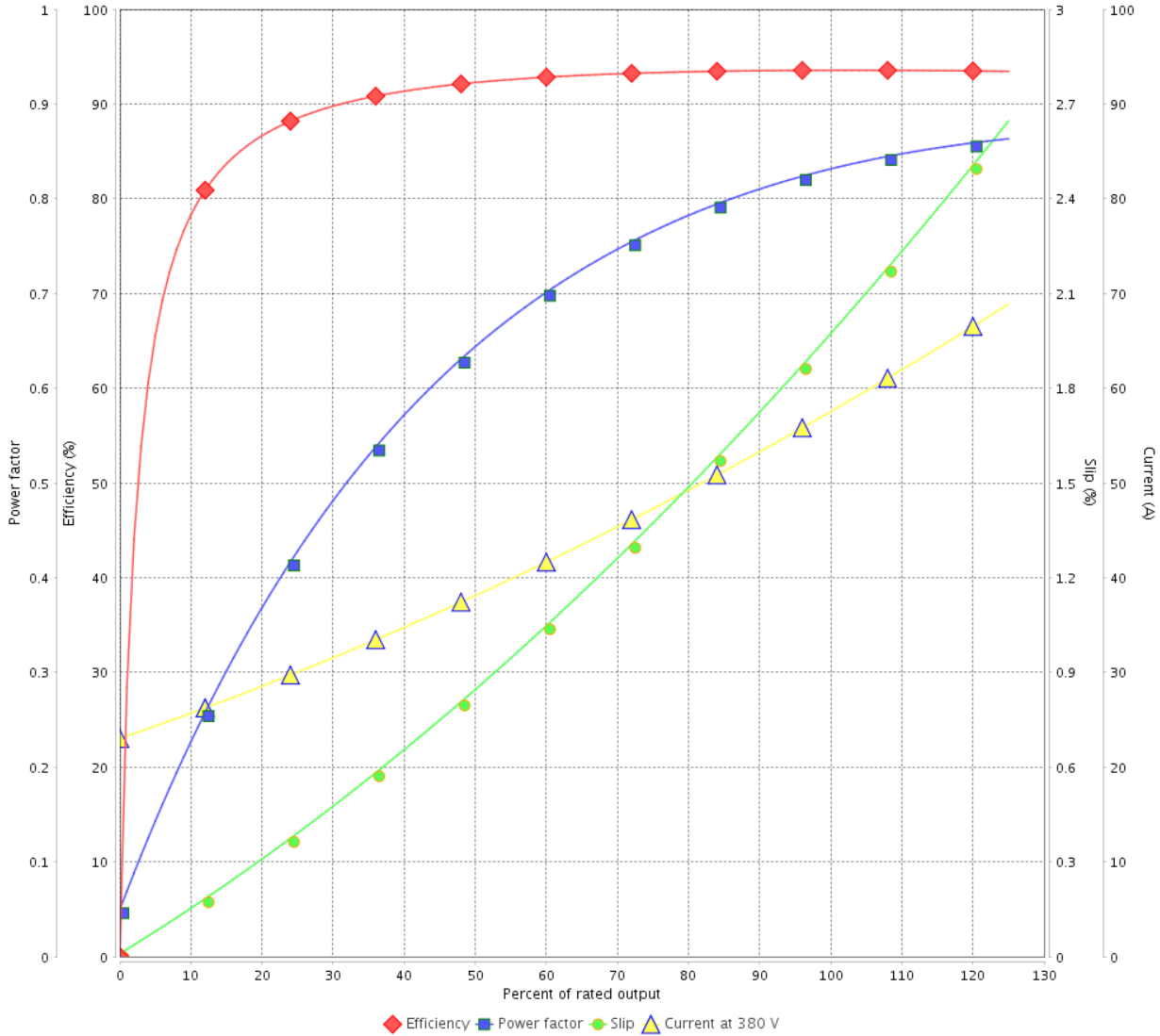

Performance : 380 V 50 Hz 4P IE3

Rated current	: 58.7 A	Moment of inertia (J)	: 9.16 sq.ft.lb
LRC	: 6.4	Duty cycle	: Cont.(S1)
Rated torque	: 143 ft.lb	Insulation class	: F
Locked rotor torque	: 229 %	Service factor	: 1.00
Breakdown torque	: 260 %	Temperature rise	: 80 K
Rated speed	: 1470 rpm	Design	: B

Rev.	Changes Summary	Performed	Checked	Date
Performed by			Page 10 / 36	Revision
Checked by				
Date	12/04/2022			

# LOAD PERFORMANCE CURVE

## Three Phase Induction Motor - Squirrel Cage



Customer : \_\_\_\_\_

Product line : NEMA Premium Efficiency Three-Phase

Product code : 11460238

Catalog # : 05018ET3E326TS-W22

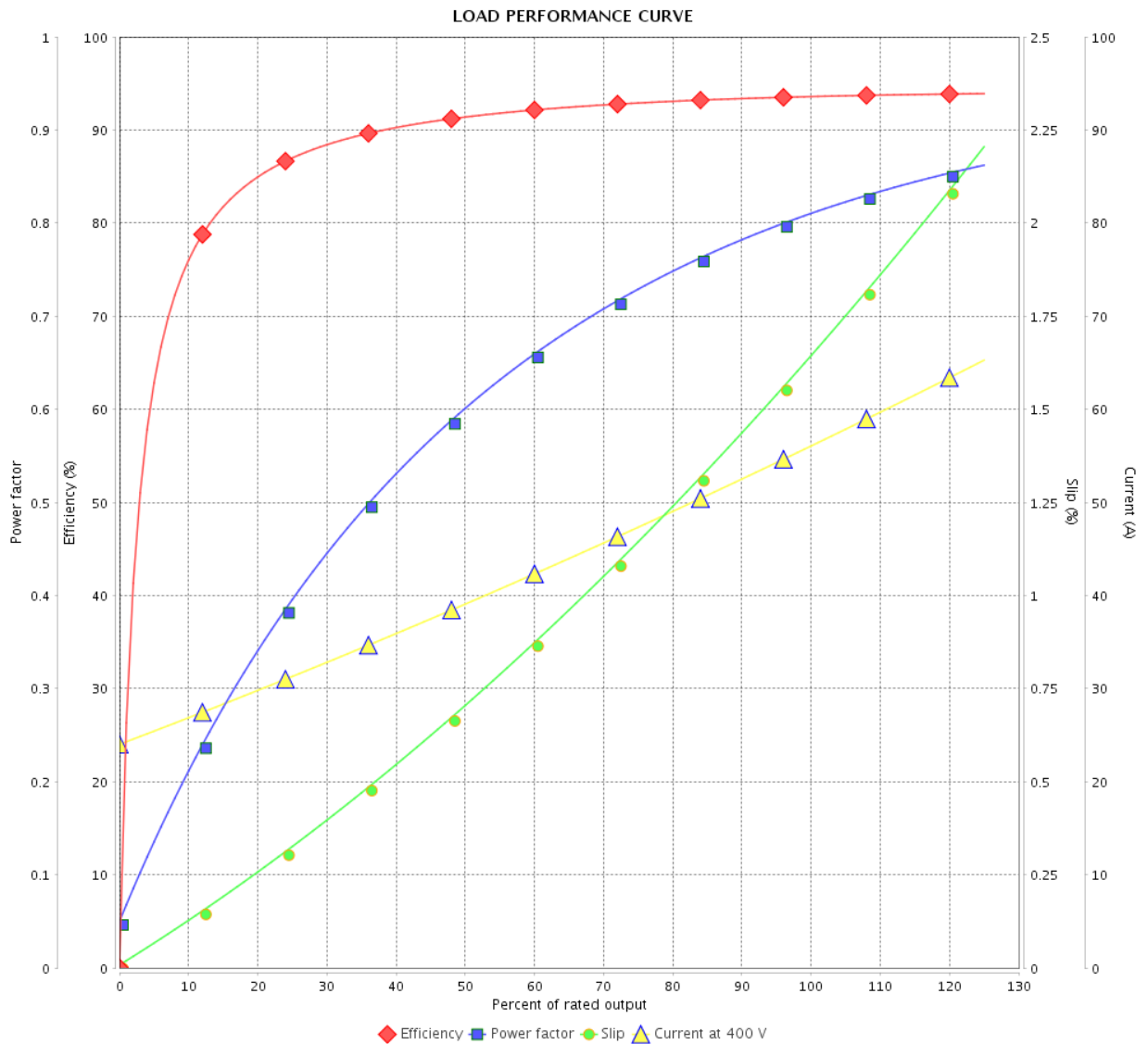

Performance : 400 V 50 Hz 4P IE3

Rated current : 57.1 A  
 LRC : 7.0  
 Rated torque : 142 ft.lb  
 Locked rotor torque : 250 %  
 Breakdown torque : 300 %  
 Rated speed : 1475 rpm

Moment of inertia (J) : 9.16 sq.ft.lb  
 Duty cycle : Cont.(S1)  
 Insulation class : F  
 Service factor : 1.00  
 Temperature rise : 80 K  
 Design : B

Rev.	Changes Summary	Performed	Checked	Date
Performed by		Page		Revision
Checked by		11 / 36		
Date		12/04/2022		

# LOAD PERFORMANCE CURVE

Three Phase Induction Motor - Squirrel Cage



Customer :

Product line : NEMA Premium Efficiency Three-Phase

Product code : 11460238

Catalog # : 05018ET3E326TS-W22

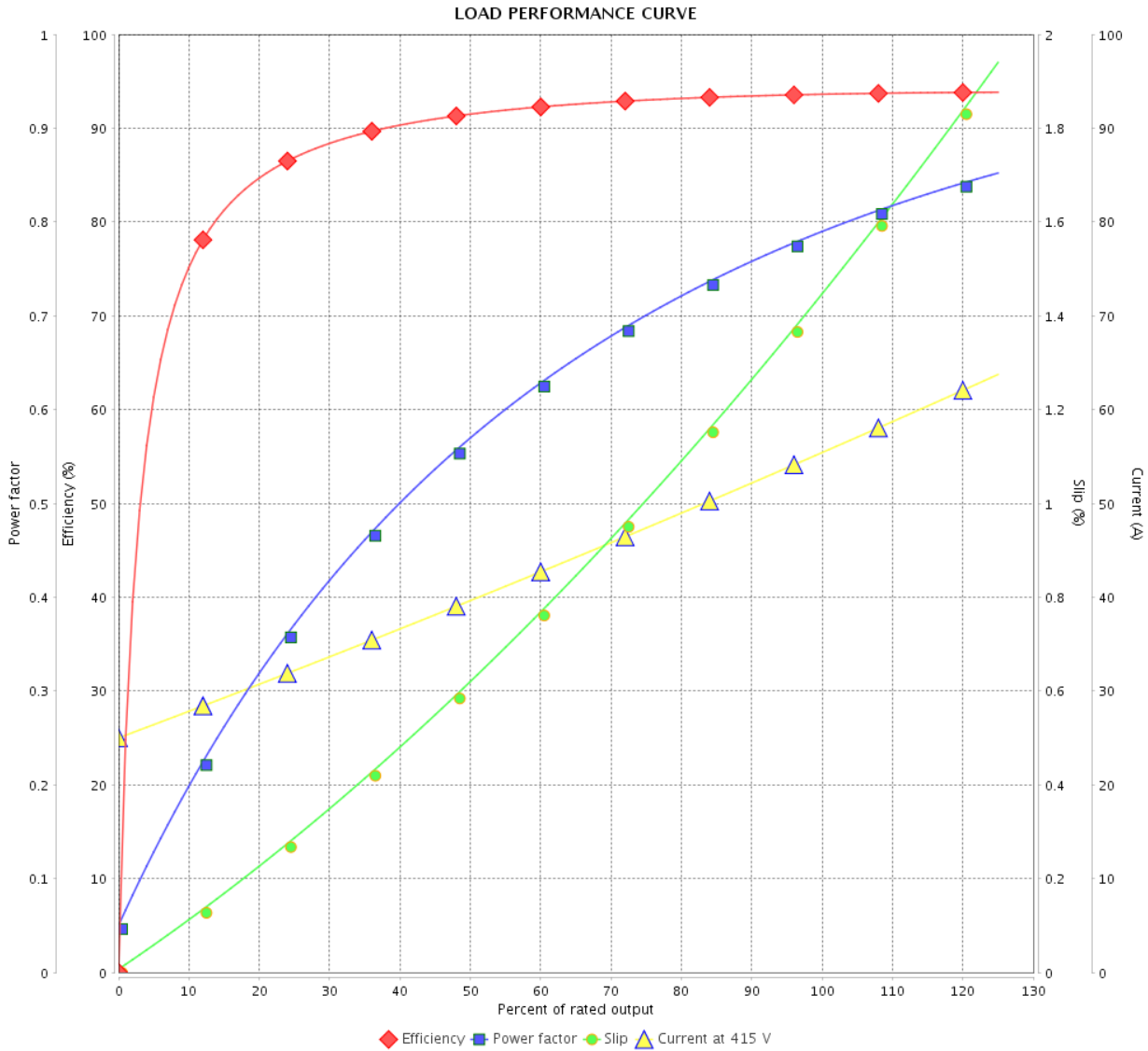

Performance : 415 V 50 Hz 4P IE3

Rated current	: 56.4 A	Moment of inertia (J)	: 9.16 sq.ft.lb
LRC	: 7.4	Duty cycle	: Cont.(S1)
Rated torque	: 142 ft.lb	Insulation class	: F
Locked rotor torque	: 260 %	Service factor	: 1.00
Breakdown torque	: 330 %	Temperature rise	: 80 K
Rated speed	: 1478 rpm	Design	: B

Rev.	Changes Summary	Performed	Checked	Date
Performed by			Page 12 / 36	Revision
Checked by				
Date	12/04/2022			

# LOAD PERFORMANCE CURVE

## Three Phase Induction Motor - Squirrel Cage



Customer : \_\_\_\_\_

Product line : NEMA Premium Efficiency Three-Phase

Product code : 11460238

Catalog # : 05018ET3E326TS-W22

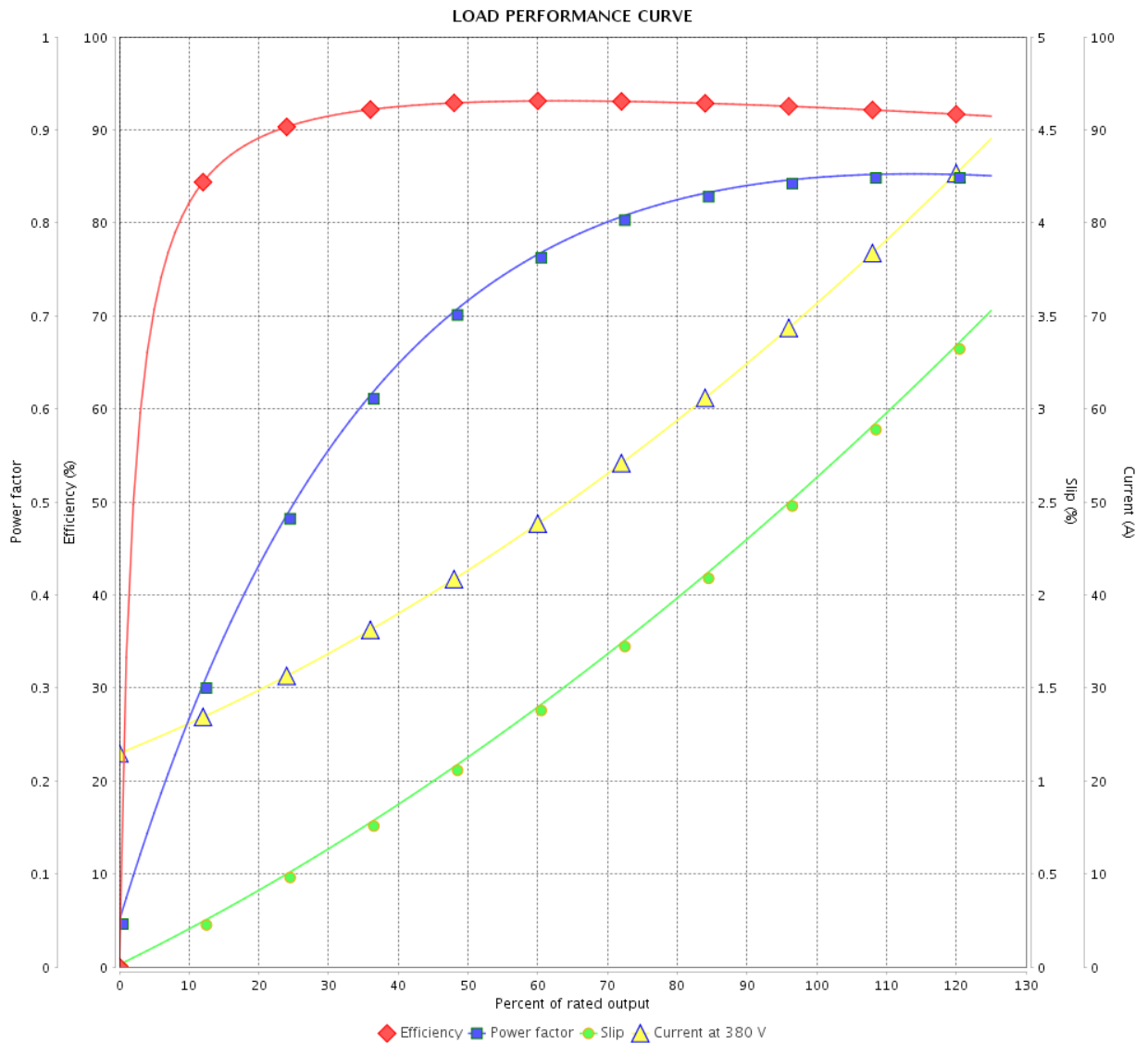

Performance : 380 V 50 Hz 4P IE1

Rated current : 71.6 A  
 LRC : 5.2  
 Rated torque : 180 ft.lb  
 Locked rotor torque : 180 %  
 Breakdown torque : 210 %  
 Rated speed : 1460 rpm

Moment of inertia (J) : 9.16 sq.ft.lb  
 Duty cycle : Cont.(S1)  
 Insulation class : F  
 Service factor : 1.00  
 Temperature rise : 105 K  
 Design : B

Rev.	Changes Summary	Performed	Checked	Date
Performed by		Page		Revision
Checked by		13 / 36		
Date		12/04/2022		

# LOAD PERFORMANCE CURVE

Three Phase Induction Motor - Squirrel Cage



Customer :

Product line : NEMA Premium Efficiency Three-Phase

Product code : 11460238

Catalog # : 05018ET3E326TS-W22

LOAD PERFORMANCE CURVE

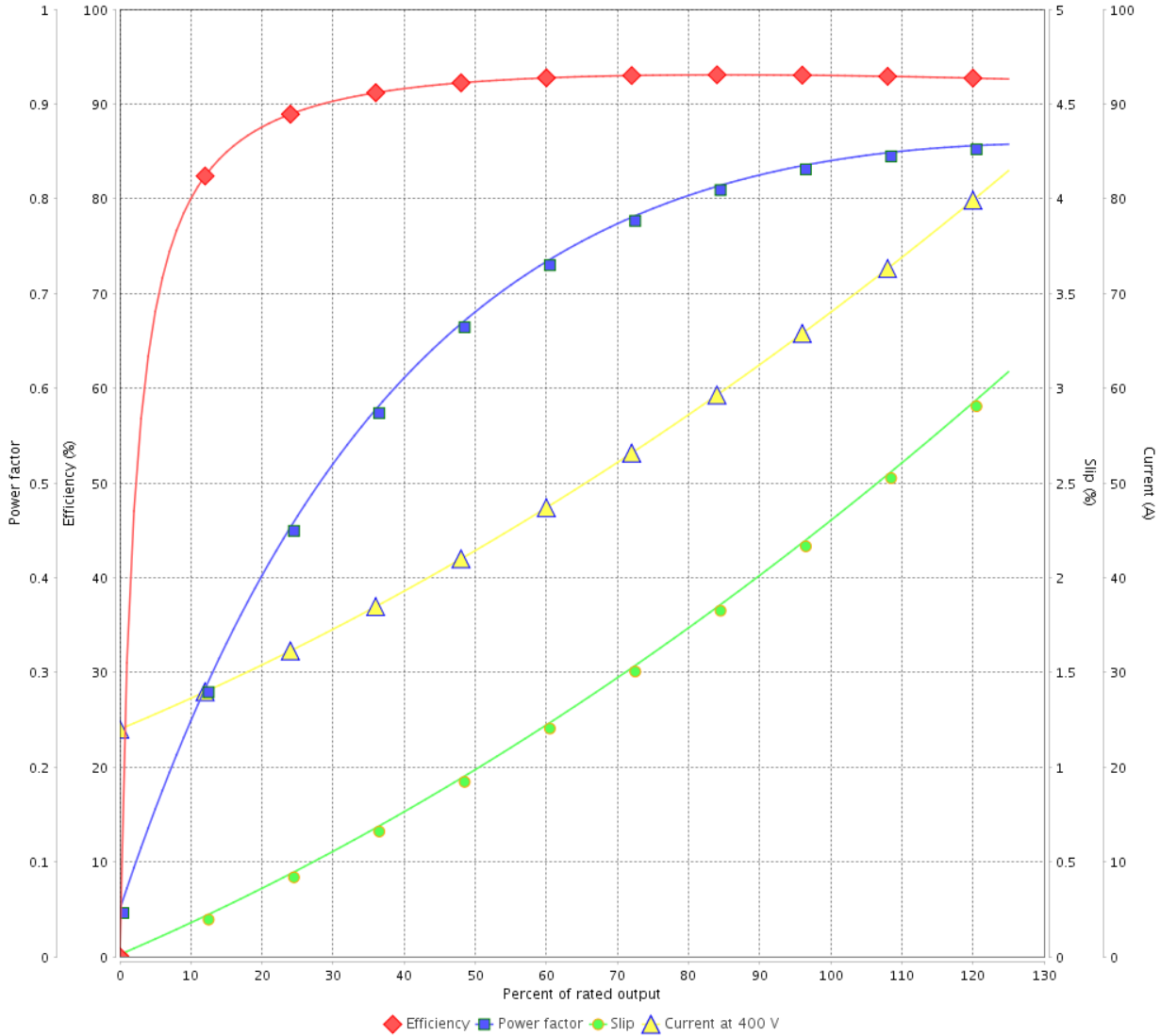

Performance : 400 V 50 Hz 4P IE2

Rated current	: 68.4 A	Moment of inertia (J)	: 9.16 sq.ft.lb
LRC	: 5.8	Duty cycle	: Cont.(S1)
Rated torque	: 179 ft.lb	Insulation class	: F
Locked rotor torque	: 200 %	Service factor	: 1.00
Breakdown torque	: 240 %	Temperature rise	: 105 K
Rated speed	: 1465 rpm	Design	: B

Rev.	Changes Summary	Performed	Checked	Date
Performed by			Page	Revision
Checked by			14 / 36	
Date	12/04/2022			

# LOAD PERFORMANCE CURVE

## Three Phase Induction Motor - Squirrel Cage



Customer : \_\_\_\_\_

Product line : NEMA Premium Efficiency Three-Phase

Product code : 11460238

Catalog # : 05018ET3E326TS-W22

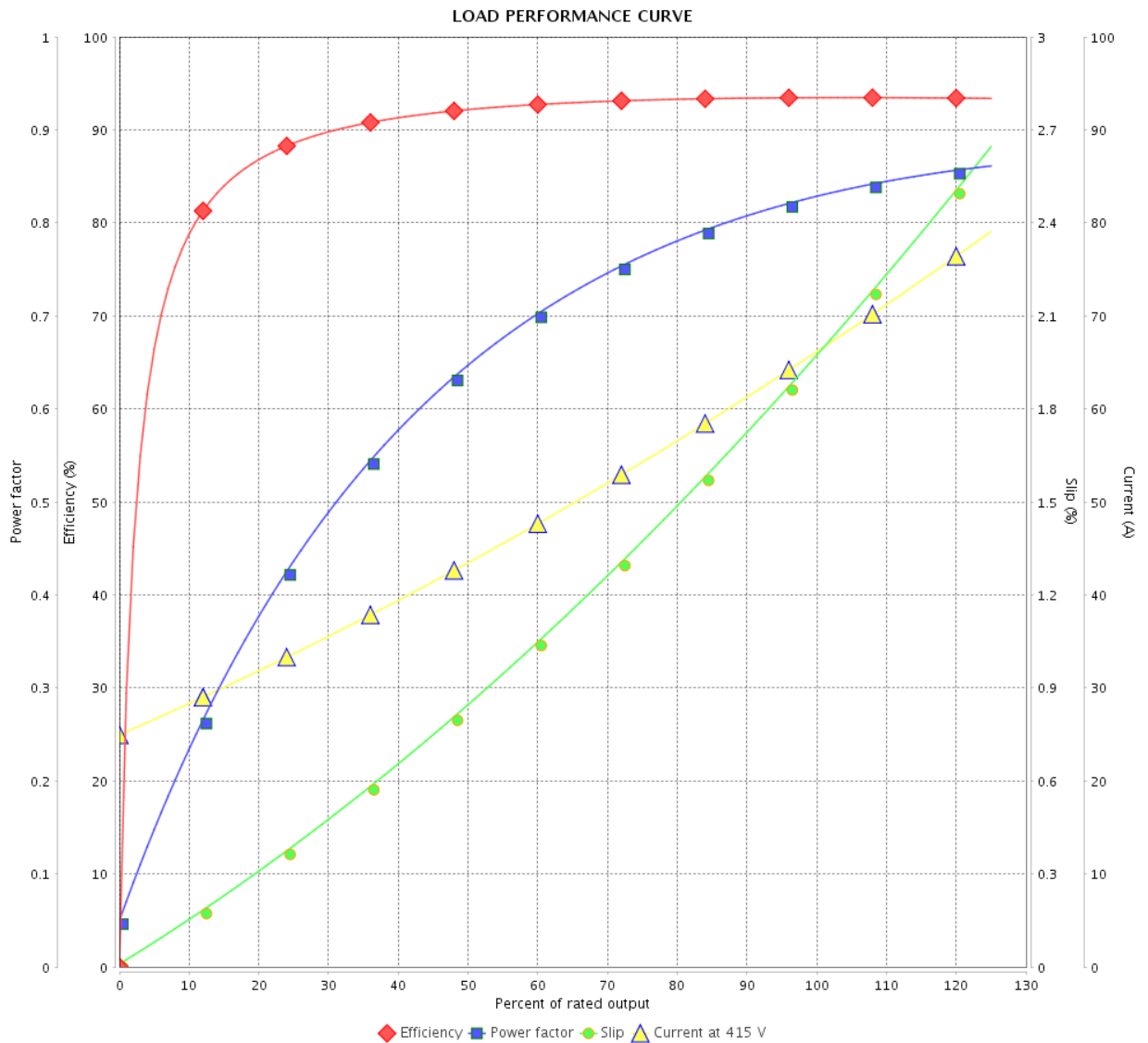

Performance : 415 V 50 Hz 4P IE2

Rated current : 66.3 A  
 LRC : 6.2  
 Rated torque : 179 ft.lb  
 Locked rotor torque : 210 %  
 Breakdown torque : 260 %  
 Rated speed : 1470 rpm

Moment of inertia (J) : 9.16 sq.ft.lb  
 Duty cycle : Cont.(S1)  
 Insulation class : F  
 Service factor : 1.00  
 Temperature rise : 105 K  
 Design : B

Rev.	Changes Summary	Performed	Checked	Date
Performed by		Page		Revision
Checked by		15 / 36		
Date		12/04/2022		

# THERMAL LIMIT CURVE



## Three Phase Induction Motor - Squirrel Cage

Customer :

Product line : NEMA Premium Efficiency Three-Phase  
 Product code : 11460238  
 Catalog # : 05018ET3E326TS-W22

Performance : 230/460 V 60 Hz 4P

Rated current : 118/59.2 A	Moment of inertia (J) : 9.16 sq.ft.lb
LRC : 6.2	Duty cycle : Cont.(S1)
Rated torque : 148 ft.lb	Insulation class : F
Locked rotor torque : 229 %	Service factor : 1.25
Breakdown torque : 270 %	Temperature rise : 80 K
Rated speed : 1775 rpm	Design : B

Heating constant

Cooling constant

Rev.	Changes Summary	Performed	Checked	Date
Performed by			Page 16 / 36	Revision
Checked by				
Date	12/04/2022			



# THERMAL LIMIT CURVE

Three Phase Induction Motor - Squirrel Cage



Customer : \_\_\_\_\_

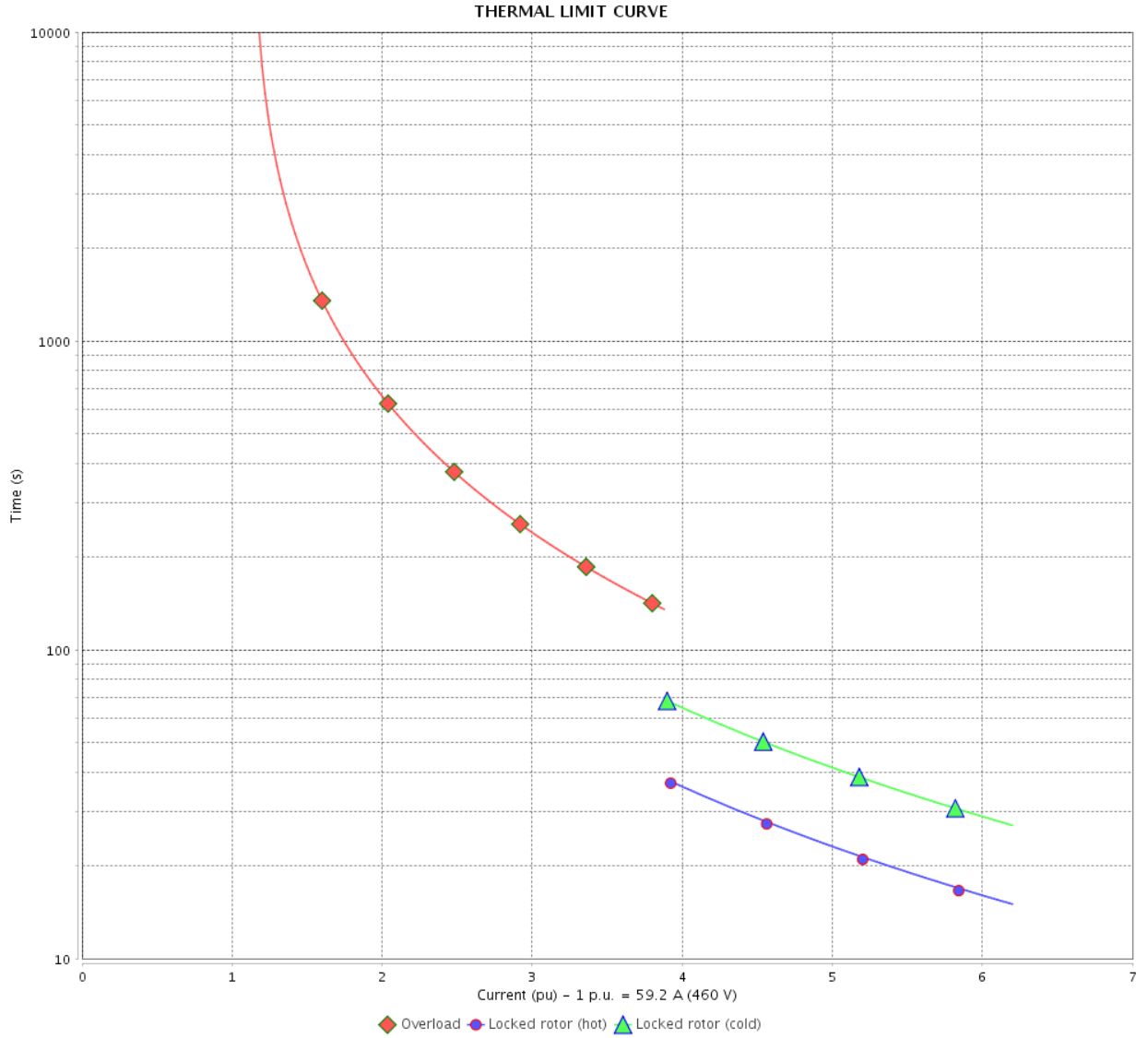

Rev.	Changes Summary	Performed	Checked	Date
Performed by		Page		Revision
Checked by		17 / 36		
Date		12/04/2022		

# THERMAL LIMIT CURVE

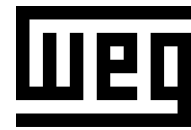

## Three Phase Induction Motor - Squirrel Cage

Customer :

Product line : NEMA Premium Efficiency Three-Phase  
 Product code : 11460238  
 Catalog # : 05018ET3E326TS-W22

Performance : 380 V 50 Hz 4P IE3

Rated current : 58.7 A	Moment of inertia (J) : 9.16 sq.ft.lb
LRC : 6.4	Duty cycle : Cont.(S1)
Rated torque : 143 ft.lb	Insulation class : F
Locked rotor torque : 229 %	Service factor : 1.00
Breakdown torque : 260 %	Temperature rise : 80 K
Rated speed : 1470 rpm	Design : B

Heating constant

Cooling constant

Rev.	Changes Summary	Performed	Checked	Date
Performed by			Page 18 / 36	Revision
Checked by				
Date	12/04/2022			

# THERMAL LIMIT CURVE

Three Phase Induction Motor - Squirrel Cage



Customer : \_\_\_\_\_

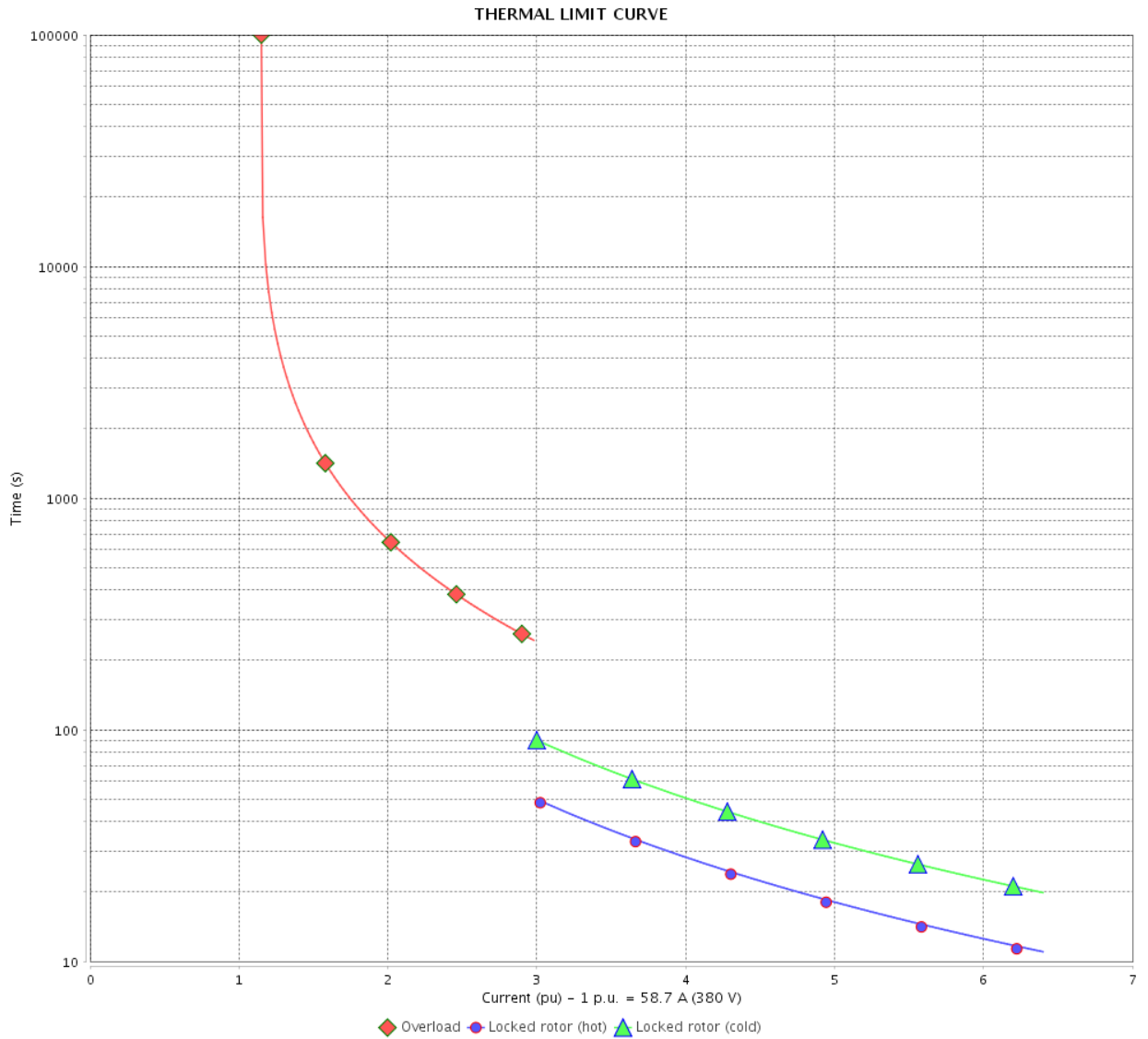

Rev.	Changes Summary	Performed	Checked	Date
Performed by		Page      Revision 19 / 36		
Checked by				
Date				

# THERMAL LIMIT CURVE

## Three Phase Induction Motor - Squirrel Cage



Customer :

Product line : NEMA Premium Efficiency Three-Phase  
Product code : 11460238  
Catalog # : 05018ET3E326TS-W22

Performance : 400 V 50 Hz 4P IE3

Rated current	: 57.1 A	Moment of inertia (J)	: 9.16 sq.ft.lb
LRC	: 7.0	Duty cycle	: Cont.(S1)
Rated torque	: 142 ft.lb	Insulation class	: F
Locked rotor torque	: 250 %	Service factor	: 1.00
Breakdown torque	: 300 %	Temperature rise	: 80 K
Rated speed	: 1475 rpm	Design	: B

Heating constant

Cooling constant

Rev.	Changes Summary	Performed	Checked	Date
Performed by				
Checked by			Page	Revision
Date	12/04/2022		20 / 36	

# THERMAL LIMIT CURVE

Three Phase Induction Motor - Squirrel Cage



Customer : \_\_\_\_\_

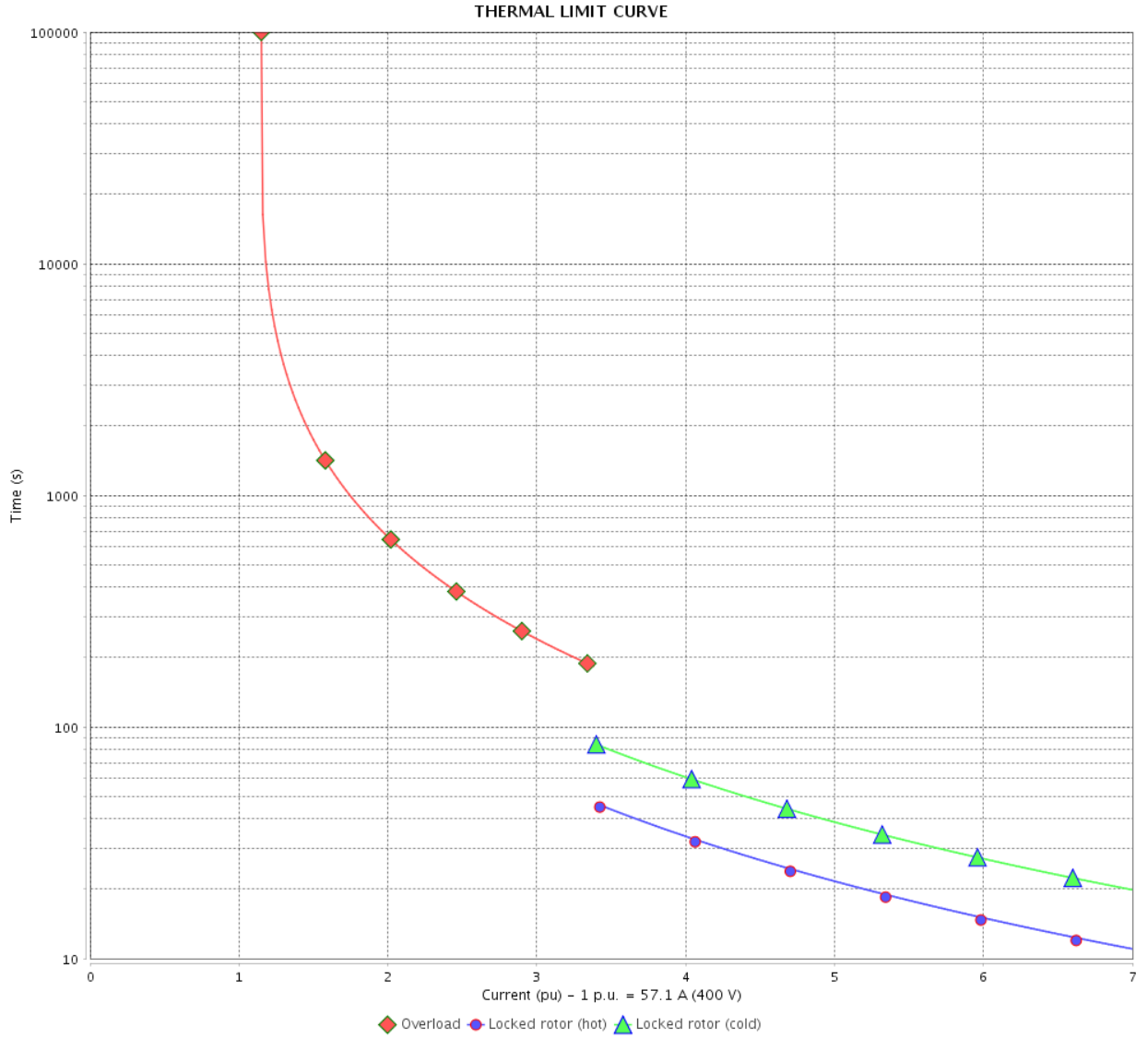

Rev.	Changes Summary	Performed	Checked	Date
Performed by		Page 21 / 36		Revision
Checked by				
Date				

# THERMAL LIMIT CURVE



## Three Phase Induction Motor - Squirrel Cage

Customer :

Product line : NEMA Premium Efficiency Three-Phase  
 Product code : 11460238  
 Catalog # : 05018ET3E326TS-W22

Performance : 415 V 50 Hz 4P IE3

Rated current : 56.4 A	Moment of inertia (J) : 9.16 sq.ft.lb
LRC : 7.4	Duty cycle : Cont.(S1)
Rated torque : 142 ft.lb	Insulation class : F
Locked rotor torque : 260 %	Service factor : 1.00
Breakdown torque : 330 %	Temperature rise : 80 K
Rated speed : 1478 rpm	Design : B

Heating constant

Cooling constant

Rev.	Changes Summary	Performed	Checked	Date
Performed by			Page 22 / 36	Revision
Checked by				
Date	12/04/2022			

# THERMAL LIMIT CURVE

Three Phase Induction Motor - Squirrel Cage



Customer : \_\_\_\_\_

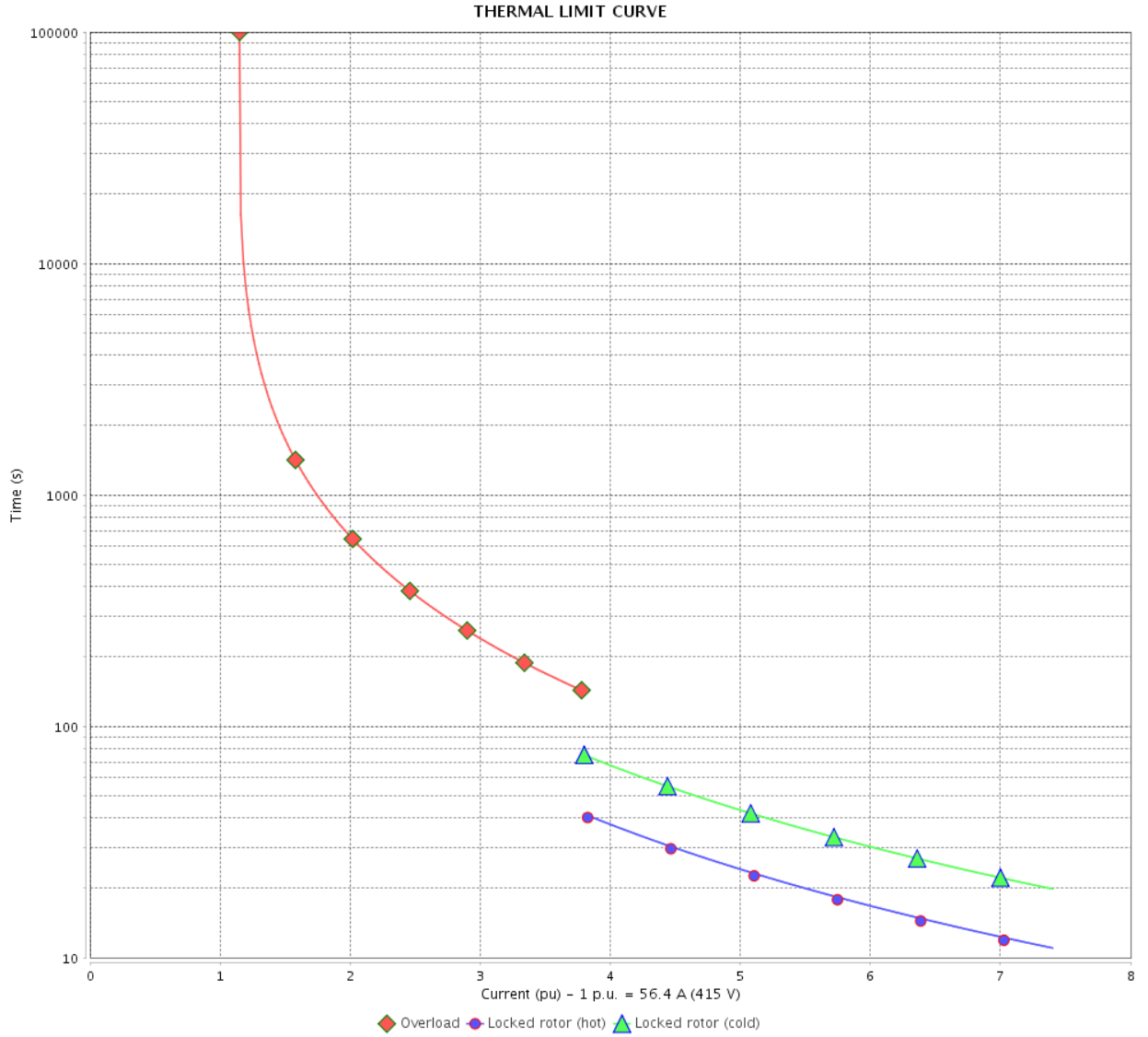

Rev.	Changes Summary	Performed	Checked	Date
Performed by		Page		Revision
Checked by		23 / 36		
Date		12/04/2022		

# THERMAL LIMIT CURVE

## Three Phase Induction Motor - Squirrel Cage



Customer :

Product line : NEMA Premium Efficiency Three-Phase  
Product code : 11460238  
Catalog # : 05018ET3E326TS-W22

Performance : 380 V 50 Hz 4P IE1

Rated current	: 71.6 A	Moment of inertia (J)	: 9.16 sq.ft.lb
LRC	: 5.2	Duty cycle	: Cont.(S1)
Rated torque	: 180 ft.lb	Insulation class	: F
Locked rotor torque	: 180 %	Service factor	: 1.00
Breakdown torque	: 210 %	Temperature rise	: 105 K
Rated speed	: 1460 rpm	Design	: B

Heating constant

Cooling constant

Rev.	Changes Summary	Performed	Checked	Date
Performed by				
Checked by			Page	Revision
Date	12/04/2022		24 / 36	



# THERMAL LIMIT CURVE

Three Phase Induction Motor - Squirrel Cage



Customer : \_\_\_\_\_

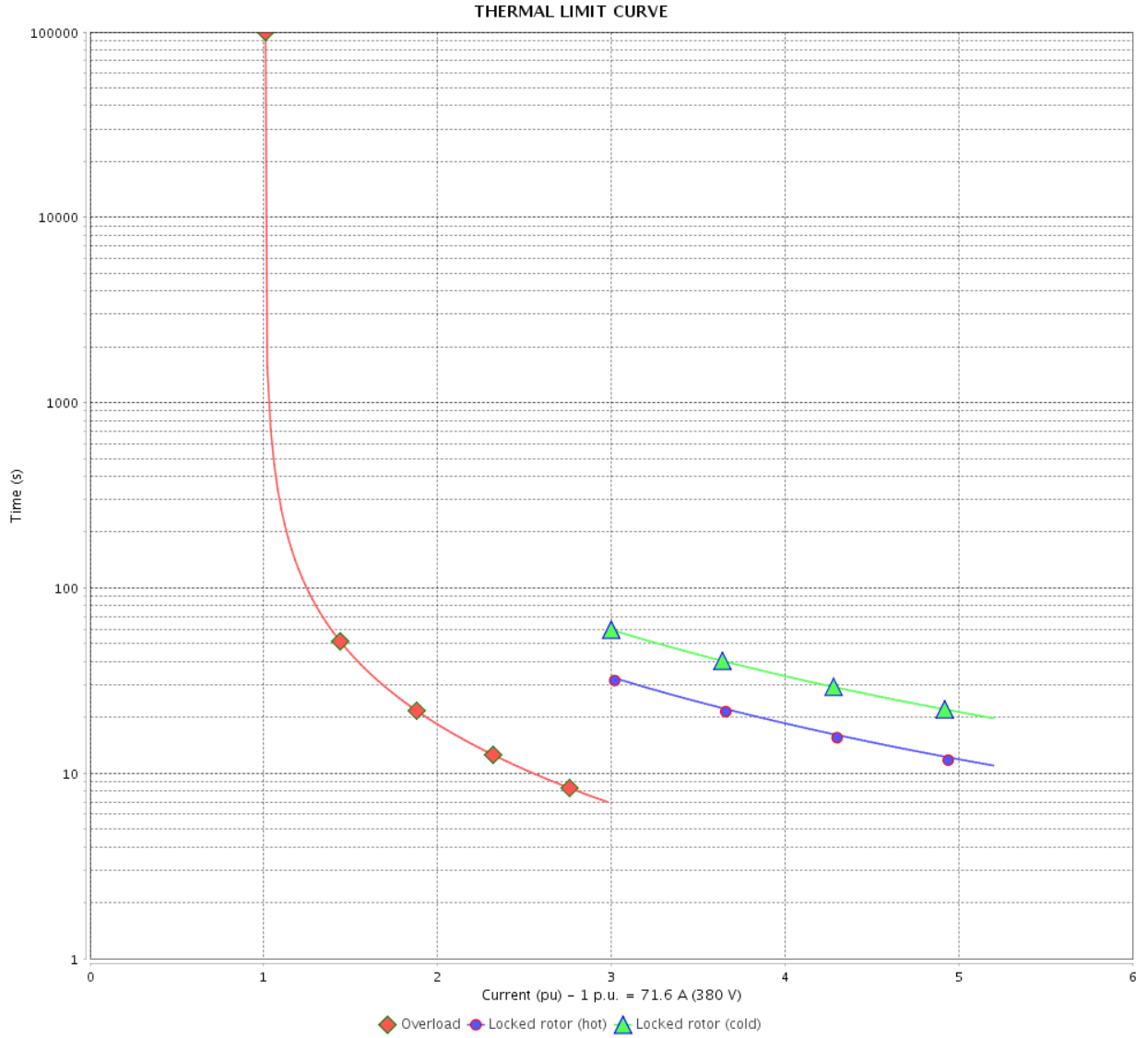

Rev.	Changes Summary	Performed	Checked	Date
Performed by		Page		Revision
Checked by		25 / 36		
Date		12/04/2022		

# THERMAL LIMIT CURVE



## Three Phase Induction Motor - Squirrel Cage

Customer :

Product line : NEMA Premium Efficiency Three-Phase  
Product code : 11460238  
Catalog # : 05018ET3E326TS-W22

Performance : 400 V 50 Hz 4P IE2

Rated current	: 68.4 A	Moment of inertia (J)	: 9.16 sq.ft.lb
LRC	: 5.8	Duty cycle	: Cont.(S1)
Rated torque	: 179 ft.lb	Insulation class	: F
Locked rotor torque	: 200 %	Service factor	: 1.00
Breakdown torque	: 240 %	Temperature rise	: 105 K
Rated speed	: 1465 rpm	Design	: B

Heating constant

Cooling constant

Rev.	Changes Summary	Performed	Checked	Date
Performed by				
Checked by			Page	Revision
Date	12/04/2022		26 / 36	

# THERMAL LIMIT CURVE

Three Phase Induction Motor - Squirrel Cage



Customer : \_\_\_\_\_

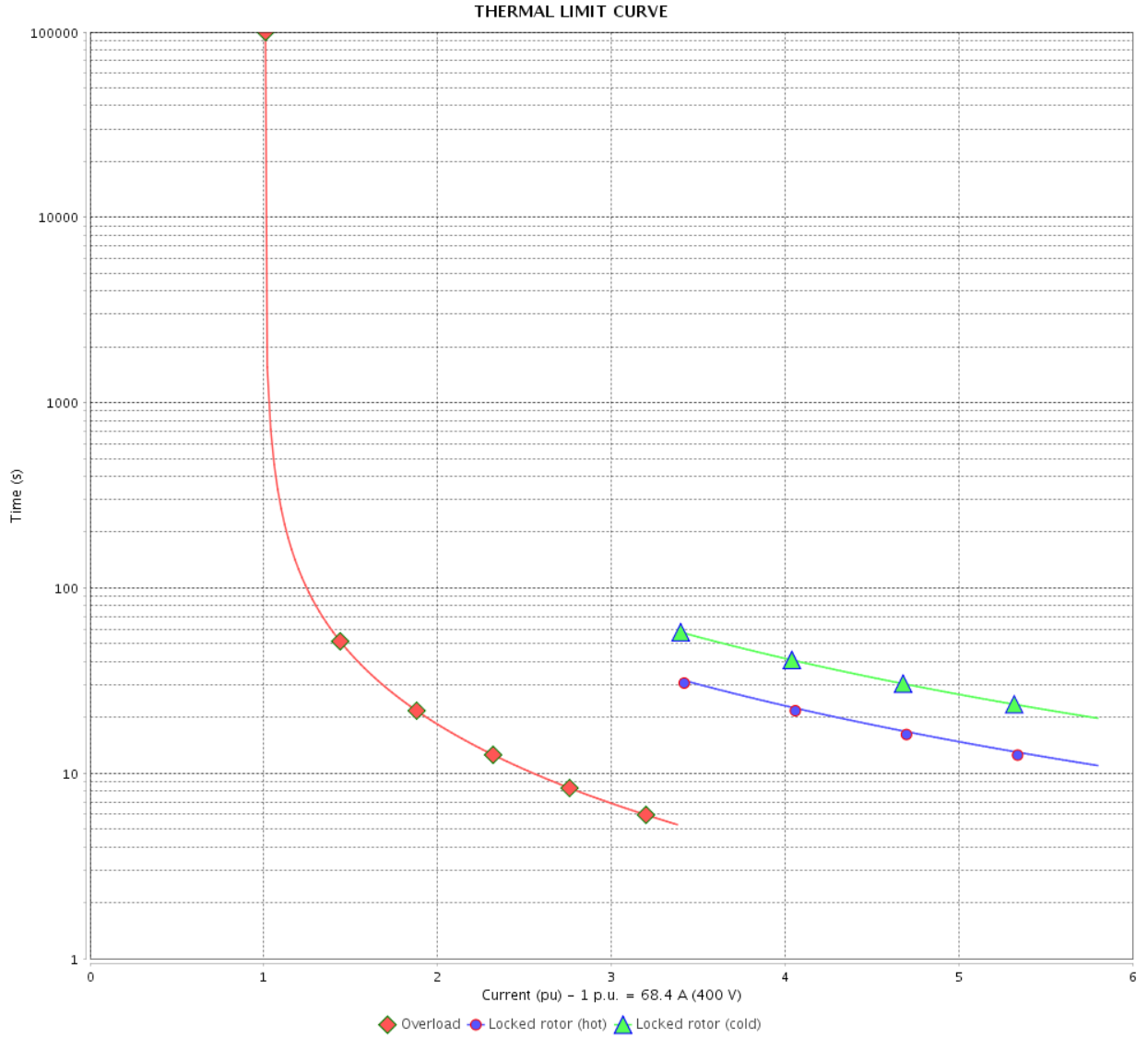

Rev.	Changes Summary	Performed	Checked	Date
Performed by				
Checked by				
Date				
			Page	Revision
			27 / 36	

# THERMAL LIMIT CURVE



## Three Phase Induction Motor - Squirrel Cage

Customer :

Product line : NEMA Premium Efficiency Three-Phase  
 Product code : 11460238  
 Catalog # : 05018ET3E326TS-W22

Performance : 415 V 50 Hz 4P IE2

Rated current : 66.3 A	Moment of inertia (J) : 9.16 sq.ft.lb
LRC : 6.2	Duty cycle : Cont.(S1)
Rated torque : 179 ft.lb	Insulation class : F
Locked rotor torque : 210 %	Service factor : 1.00
Breakdown torque : 260 %	Temperature rise : 105 K
Rated speed : 1470 rpm	Design : B

Heating constant

Cooling constant

Rev.	Changes Summary	Performed	Checked	Date
Performed by			Page 28 / 36	Revision
Checked by				
Date	12/04/2022			

# THERMAL LIMIT CURVE

Three Phase Induction Motor - Squirrel Cage



Customer : \_\_\_\_\_

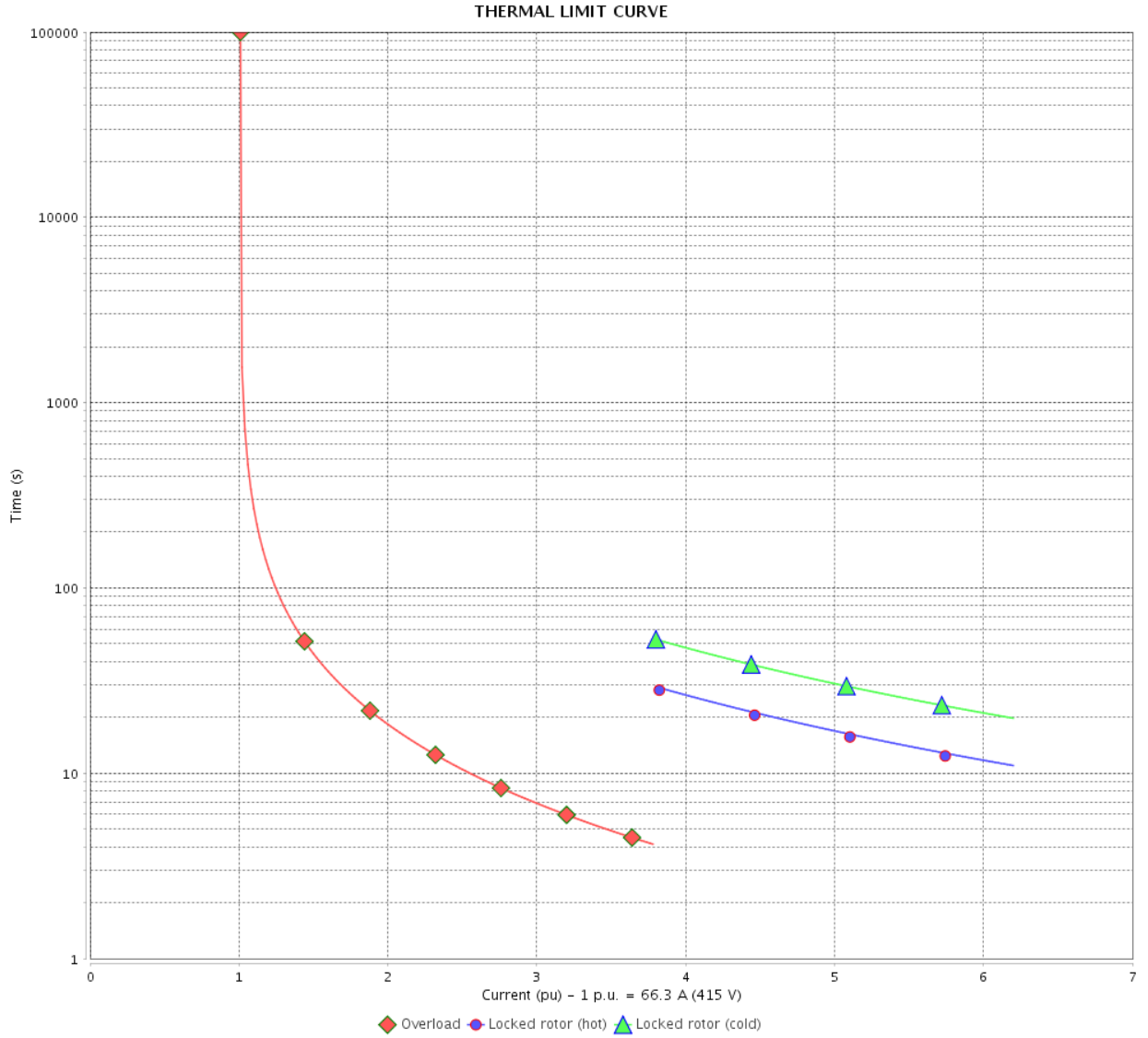

Rev.	Changes Summary	Performed	Checked	Date
Performed by		Page 29 / 36		Revision
Checked by				
Date				

# VFD OPERATION CURVE

Three Phase Induction Motor - Squirrel Cage



Customer :

Product line : NEMA Premium Efficiency Three-Phase

Product code : 11460238

Catalog # : 05018ET3E326TS-W22

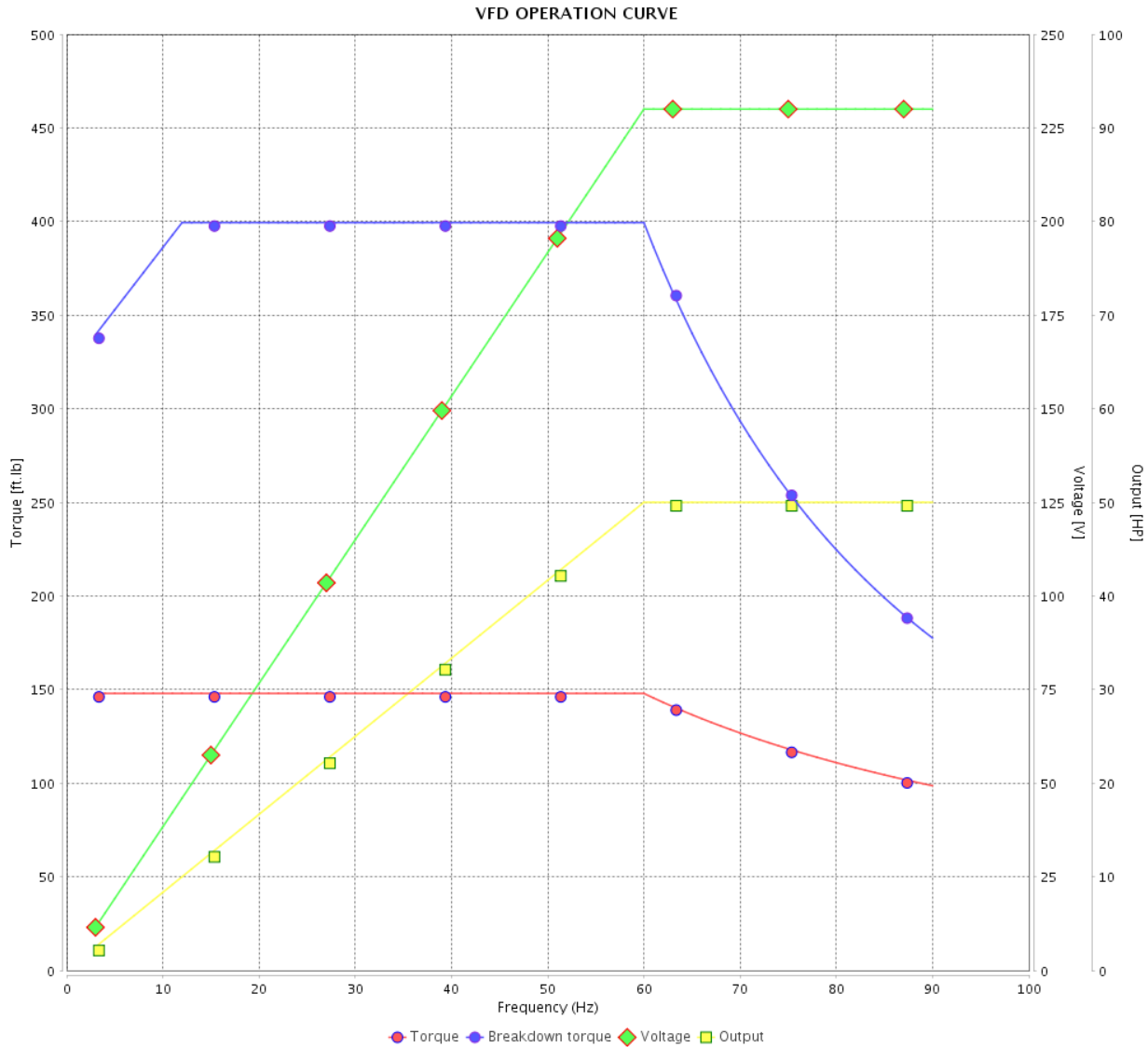

Performance : 230/460 V 60 Hz 4P

Rated current : 118/59.2 A  
 LRC : 6.2  
 Rated torque : 148 ft.lb  
 Locked rotor torque : 229 %  
 Breakdown torque : 270 %  
 Rated speed : 1775 rpm

Moment of inertia (J) : 9.16 sq.ft.lb  
 Duty cycle : Cont.(S1)  
 Insulation class : F  
 Service factor : 1.25  
 Temperature rise : 80 K  
 Design : B

Rev.	Changes Summary	Performed	Checked	Date
Performed by			Page	Revision
Checked by				
Date				

# VFD OPERATION CURVE

Three Phase Induction Motor - Squirrel Cage



Customer :

Product line : NEMA Premium Efficiency Three-Phase

Product code : 11460238

Catalog # : 05018ET3E326TS-W22

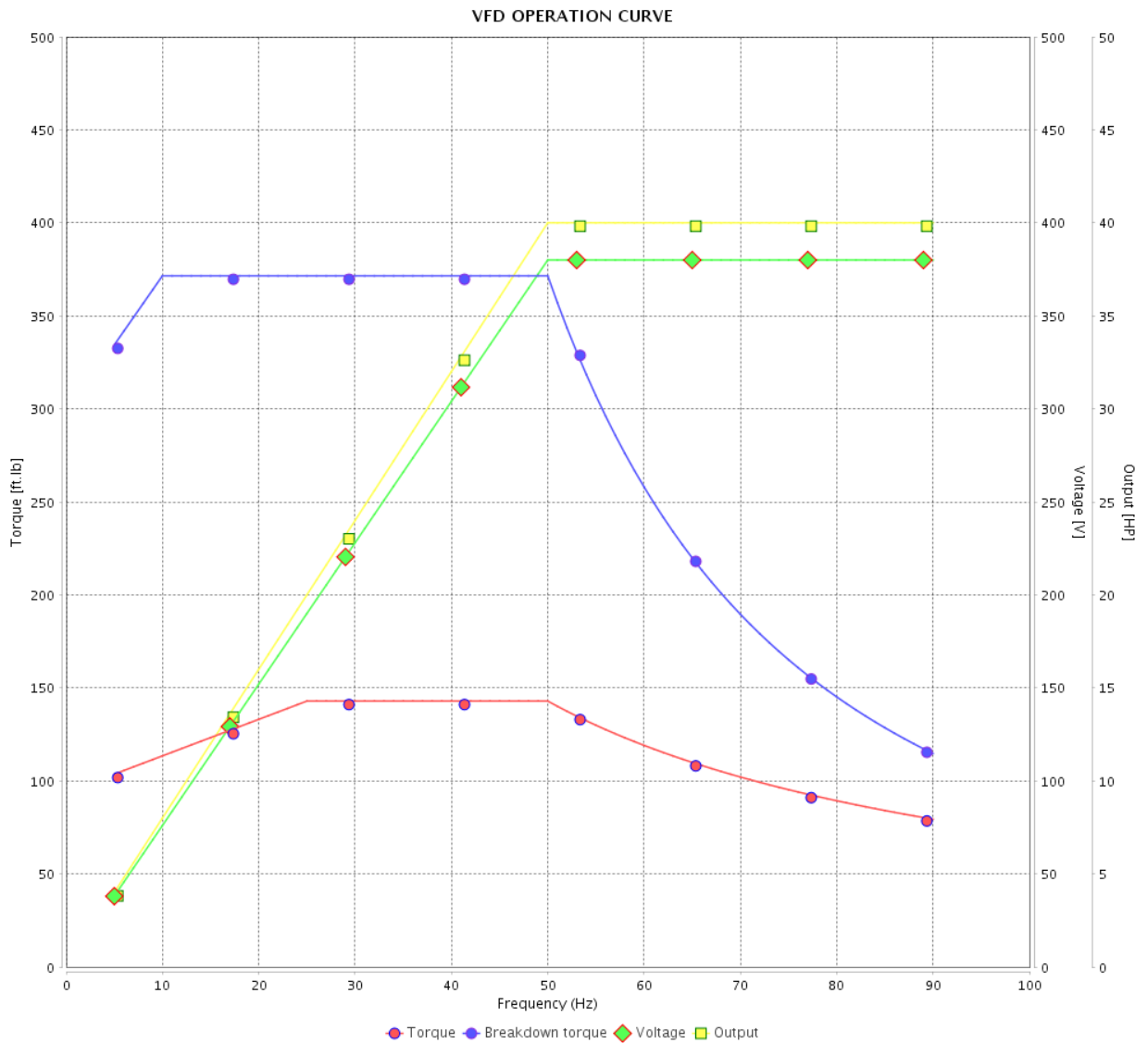

Performance : 380 V 50 Hz 4P IE3

Rated current : 58.7 A  
 LRC : 6.4  
 Rated torque : 143 ft.lb  
 Locked rotor torque : 229 %  
 Breakdown torque : 260 %  
 Rated speed : 1470 rpm

Moment of inertia (J) : 9.16 sq.ft.lb  
 Duty cycle : Cont.(S1)  
 Insulation class : F  
 Service factor : 1.00  
 Temperature rise : 80 K  
 Design : B

Rev.	Changes Summary	Performed	Checked	Date
Performed by		Page		Revision
Checked by		31 / 36		
Date	12/04/2022			

# VFD OPERATION CURVE

Three Phase Induction Motor - Squirrel Cage



Customer :

Product line : NEMA Premium Efficiency Three-Phase

Product code : 11460238

Catalog # : 05018ET3E326TS-W22

VFD OPERATION CURVE

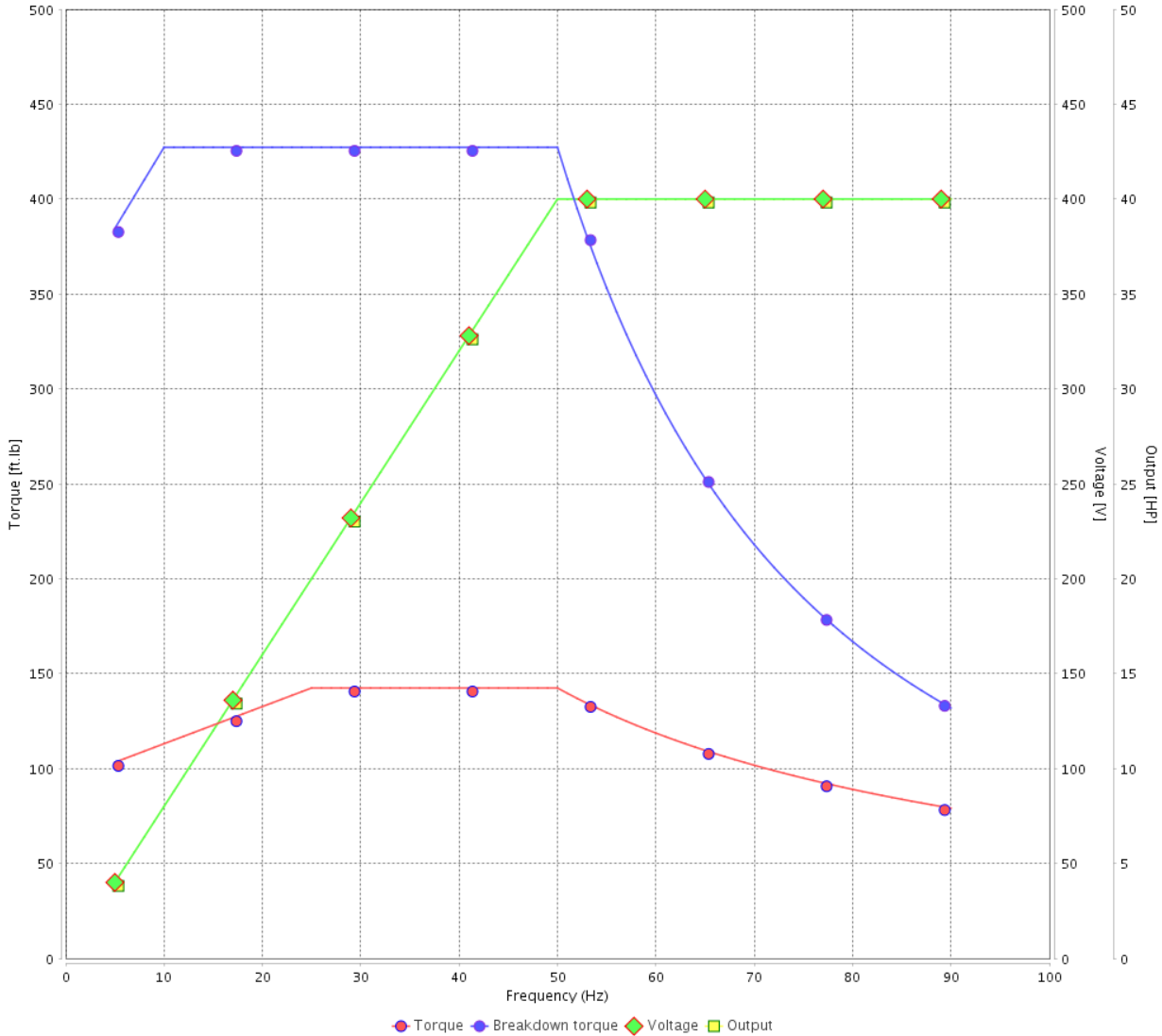

Performance : 400 V 50 Hz 4P IE3

Rated current : 57.1 A  
 LRC : 7.0  
 Rated torque : 142 ft.lb  
 Locked rotor torque : 250 %  
 Breakdown torque : 300 %  
 Rated speed : 1475 rpm

Moment of inertia (J) : 9.16 sq.ft.lb  
 Duty cycle : Cont.(S1)  
 Insulation class : F  
 Service factor : 1.00  
 Temperature rise : 80 K  
 Design : B

Rev.	Changes Summary	Performed	Checked	Date
Performed by			Page 32 / 36	Revision
Checked by				
Date	12/04/2022			



# VFD OPERATION CURVE

## Three Phase Induction Motor - Squirrel Cage



Customer : \_\_\_\_\_

Product line : NEMA Premium Efficiency Three-Phase

Product code : 11460238

Catalog # : 05018ET3E326TS-W22

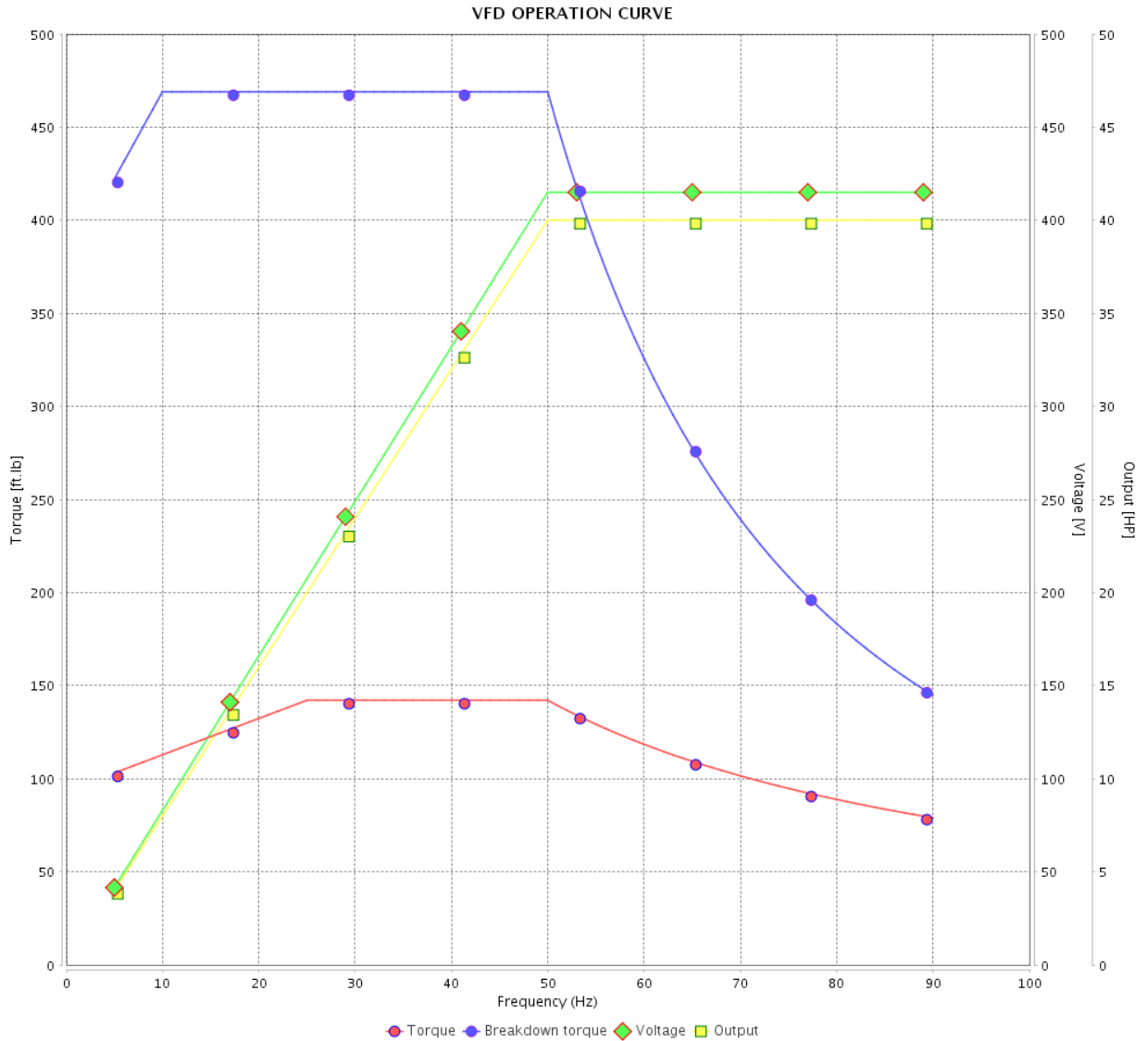

Performance : 415 V 50 Hz 4P IE3

Rated current : 56.4 A  
 LRC : 7.4  
 Rated torque : 142 ft.lb  
 Locked rotor torque : 260 %  
 Breakdown torque : 330 %  
 Rated speed : 1478 rpm

Moment of inertia (J) : 9.16 sq.ft.lb  
 Duty cycle : Cont.(S1)  
 Insulation class : F  
 Service factor : 1.00  
 Temperature rise : 80 K  
 Design : B

Rev.	Changes Summary	Performed	Checked	Date
Performed by			Page 33 / 36	Revision
Checked by				
Date	12/04/2022			

# VFD OPERATION CURVE

Three Phase Induction Motor - Squirrel Cage



Customer :

Product line : NEMA Premium Efficiency Three-Phase

Product code : 11460238

Catalog # : 05018ET3E326TS-W22

VFD OPERATION CURVE

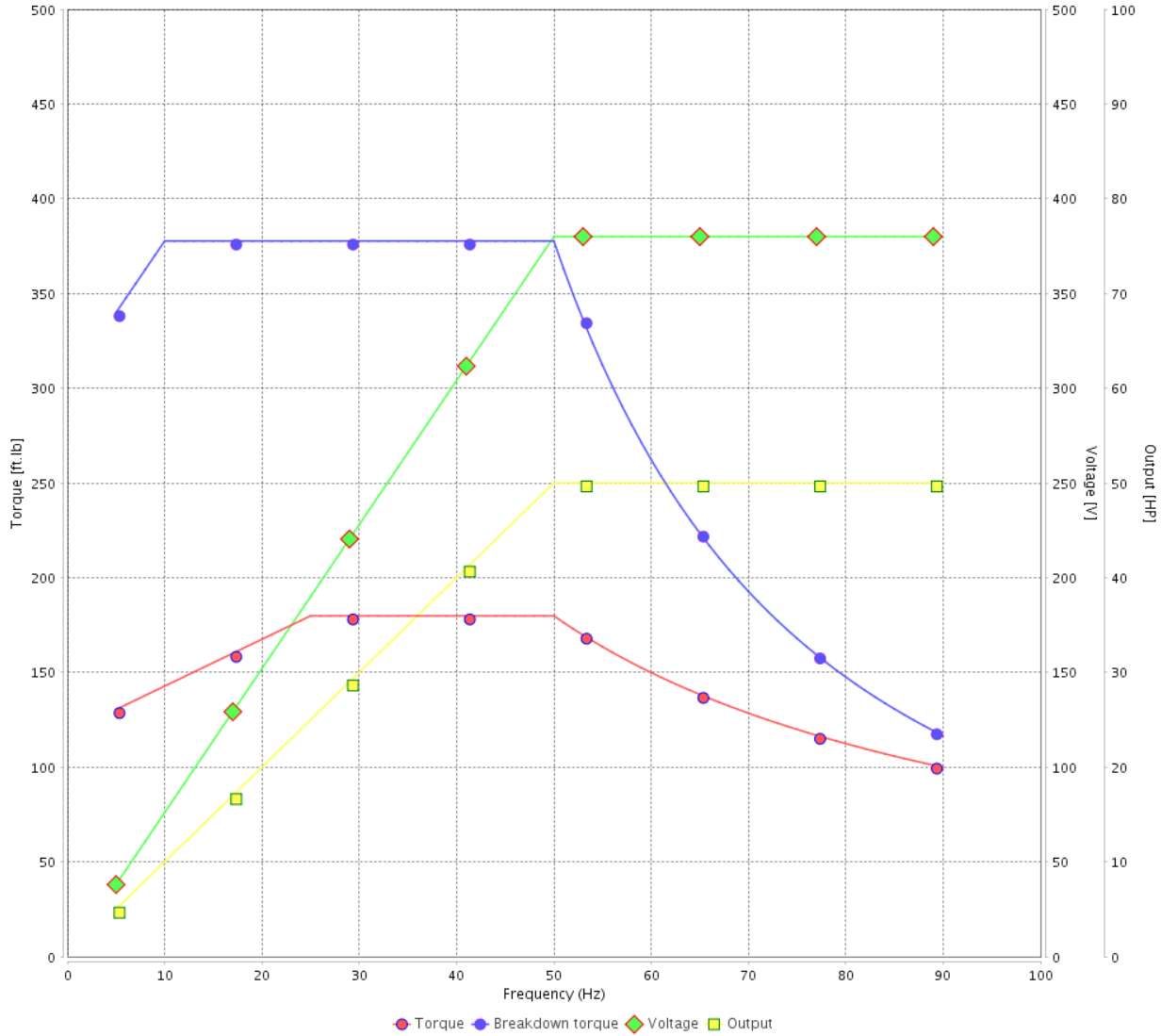

Performance : 380 V 50 Hz 4P IE1

Rated current : 71.6 A  
 LRC : 5.2  
 Rated torque : 180 ft.lb  
 Locked rotor torque : 180 %  
 Breakdown torque : 210 %  
 Rated speed : 1460 rpm

Moment of inertia (J) : 9.16 sq.ft.lb  
 Duty cycle : Cont.(S1)  
 Insulation class : F  
 Service factor : 1.00  
 Temperature rise : 105 K  
 Design : B

Rev.	Changes Summary	Performed	Checked	Date
Performed by			Page	Revision
Checked by				
Date				

# VFD OPERATION CURVE

Three Phase Induction Motor - Squirrel Cage



Customer : \_\_\_\_\_

Product line : NEMA Premium Efficiency Three-Phase

Product code : 11460238

Catalog # : 05018ET3E326TS-W22

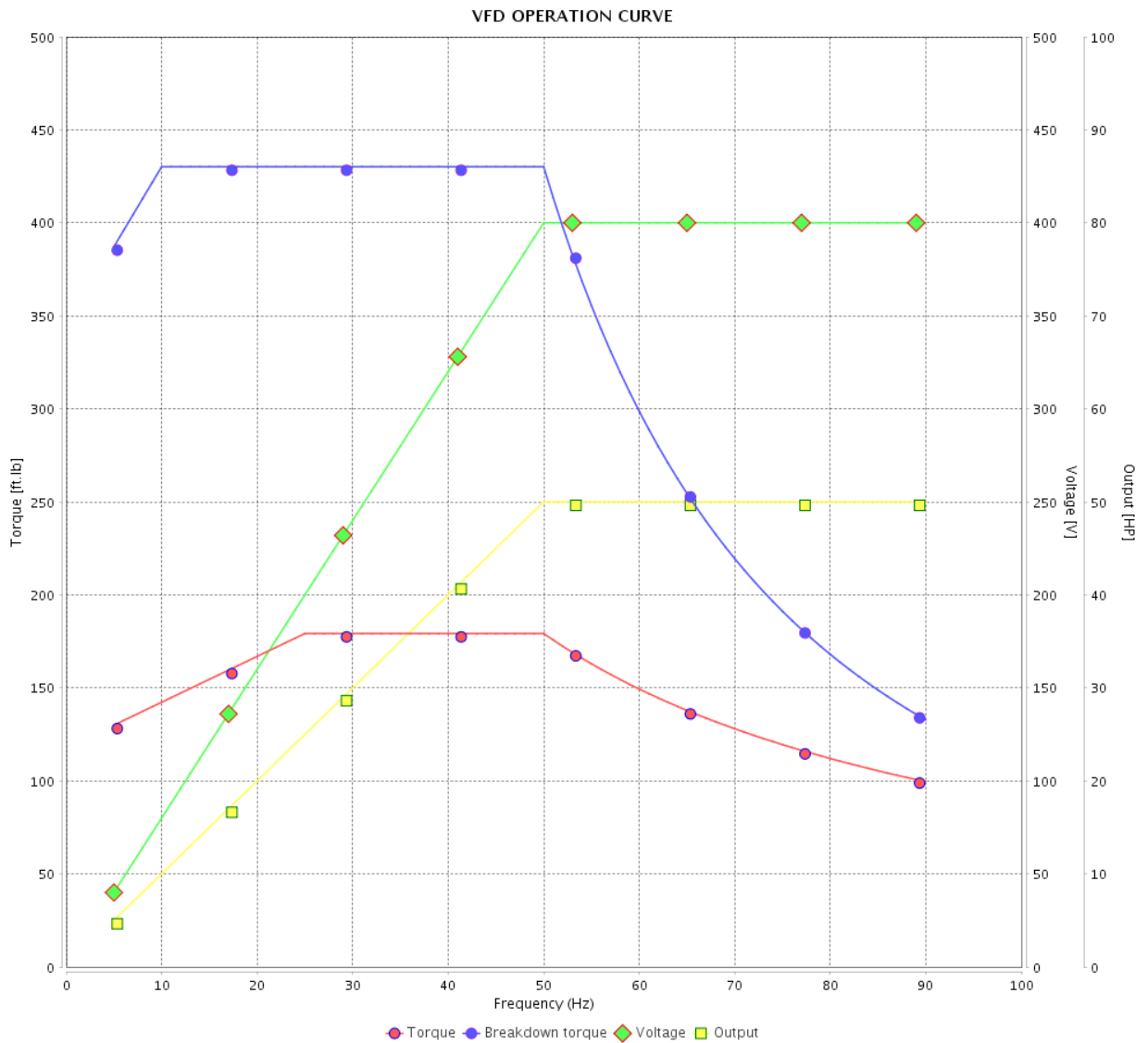

Performance : 400 V 50 Hz 4P IE2

Rated current : 68.4 A  
 LRC : 5.8  
 Rated torque : 179 ft.lb  
 Locked rotor torque : 200 %  
 Breakdown torque : 240 %  
 Rated speed : 1465 rpm

Moment of inertia (J) : 9.16 sq.ft.lb  
 Duty cycle : Cont.(S1)  
 Insulation class : F  
 Service factor : 1.00  
 Temperature rise : 105 K  
 Design : B

Rev.	Changes Summary	Performed	Checked	Date
Performed by		Page		Revision
Checked by		35 / 36		
Date		12/04/2022		

# VFD OPERATION CURVE

Three Phase Induction Motor - Squirrel Cage



Customer :

Product line : NEMA Premium Efficiency Three-Phase

Product code : 11460238

Catalog # : 05018ET3E326TS-W22

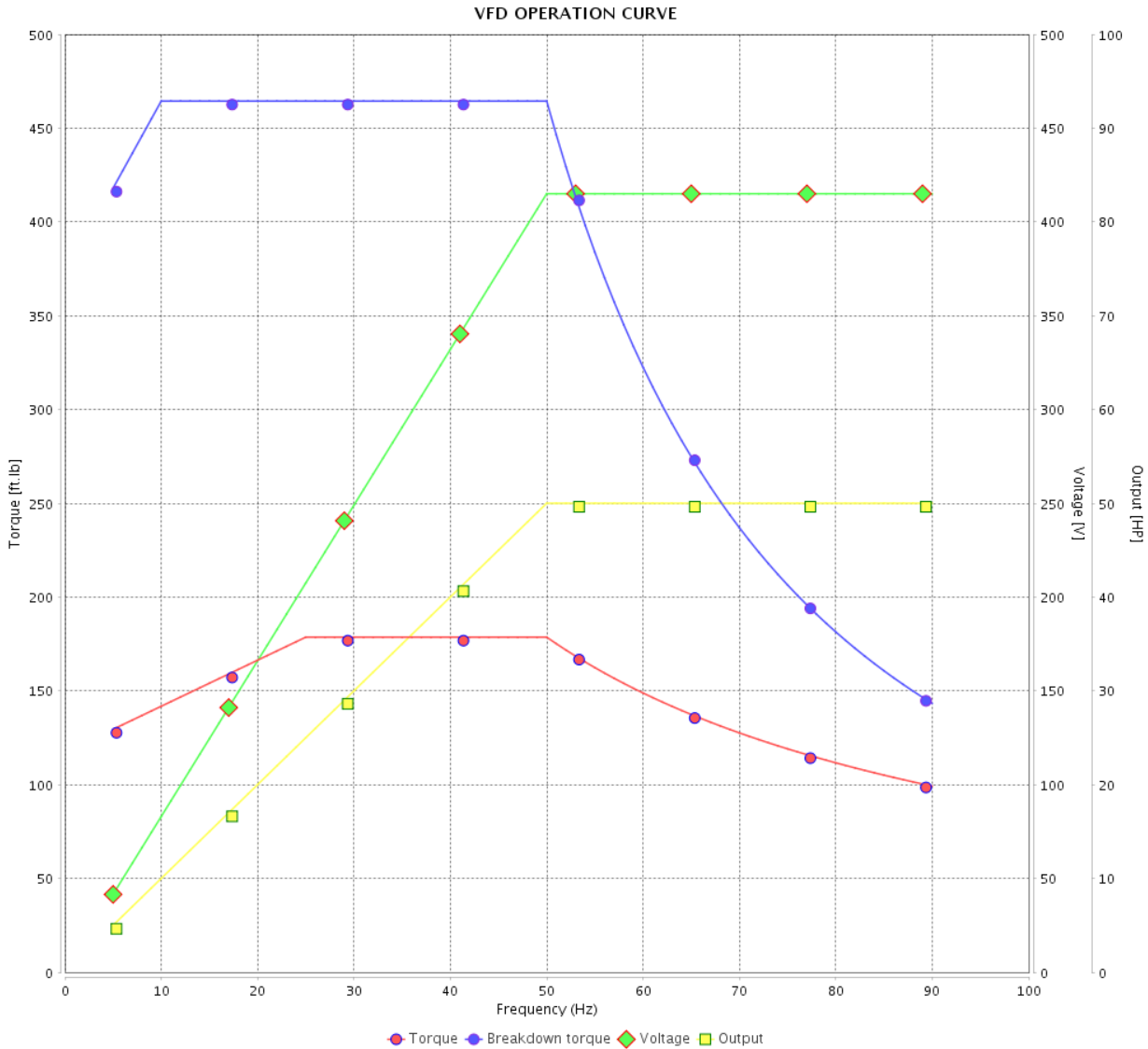

Performance : 415 V 50 Hz 4P IE2

Rated current : 66.3 A  
 LRC : 6.2  
 Rated torque : 179 ft.lb  
 Locked rotor torque : 210 %  
 Breakdown torque : 260 %  
 Rated speed : 1470 rpm

Moment of inertia (J) : 9.16 sq.ft.lb  
 Duty cycle : Cont.(S1)  
 Insulation class : F  
 Service factor : 1.00  
 Temperature rise : 105 K  
 Design : B

Rev.	Changes Summary	Performed	Checked	Date
Performed by			Page 36 / 36	Revision
Checked by				
Date 12/04/2022				

1 2 3 4 5 6

A

B

C

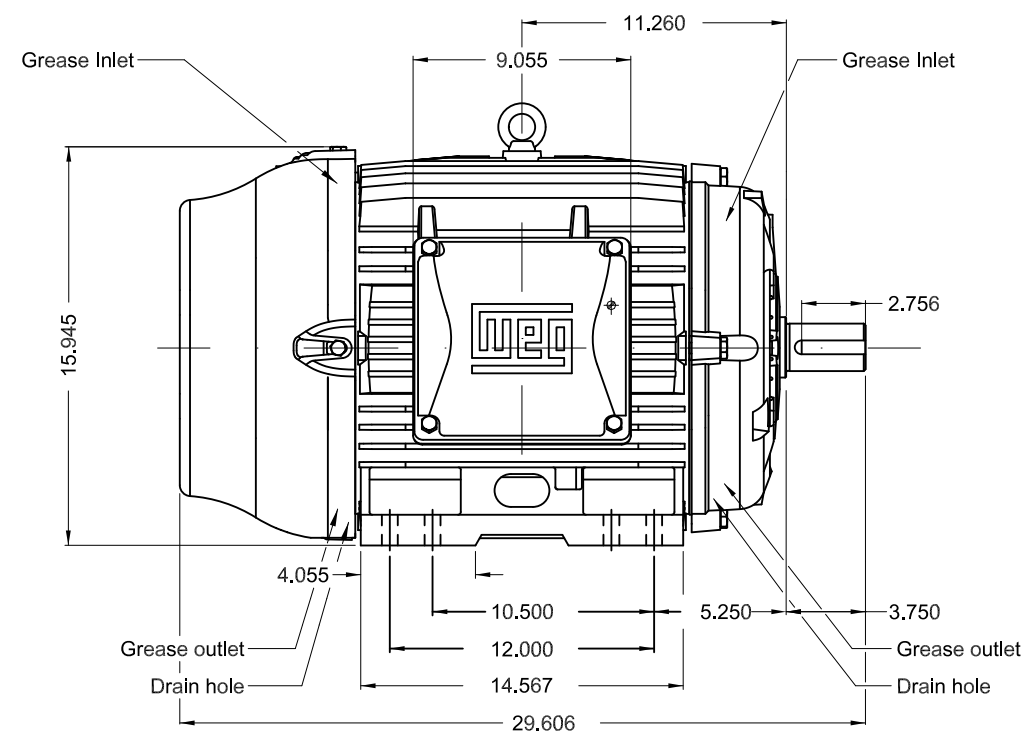
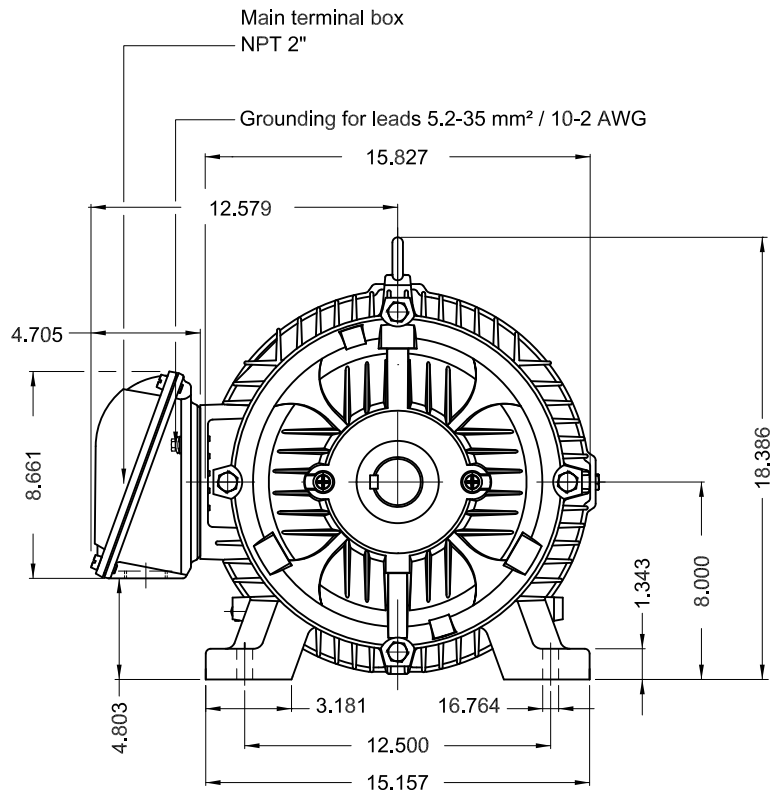

D

E

TS shaft end  
 Color RAL 5009  
 Painting plan 203A  
 Mounting B3R(D)

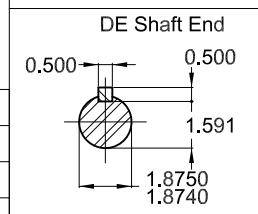

50 HP 04 Poles 60 Hz A

ECM	LOC	SUMMARY OF MODIFICATIONS	EXECUTED	CHECKED	RELEASED	DATE	VER
EXECUTED	PIRWBUSER	THREE PH. MOTOR W22 PREM. EFF.					
CHECKED		FRAME 324/6TS IP55 TEFC					
RELEASED							
REL DT.	WMO	Jaragua do Sul	Product Engineering				

PREVIEW  
 WDD



SHEET 1 / 1

Dimensions in inches XME A3



FOR SAFE AREA  
Mod.TE1BFOXON  
CC029A



For use on 60Hz  
Class I, Div 2, Gr A, B, C and D - T3  
Class I, Zone 2, IIC - T3  
Class II, Div 2, Gr F and G - T4  
For use on PWM: Gr. A, B, C, D and F,  
VT 1000:1, CT 20:1, 1.00SF - T3A

MODEL 05018ET3E326TS-W22

Inverter Duty Motor  
Severe Duty

PH3 60Hz Fr. 324/6TS 1000m.a.s.l. IP55 TEFC 592lb

V 230/460

A 118/59.2

HP 50

kW 37

SF 1.25

SFA 148/74.0

RPM 1775

PF 0.83

AMB 40°C

INS cl. F DT80K

NEMA NOM EFF 94.5%

DUTY CONT.

DES B Code G

USABLE @208V 131A SF 1.15 SFA 151

50HP 37kW 50Hz 380V 71.6A 1460RPM SF 1.00 EFF 92.4% (IE1)

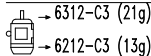
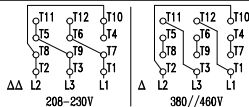

MOBIL POLYREX EM (20000h)



MADE IN BRAZIL  
11460238