

DATA SHEET

Three Phase Induction Motor - Squirrel Cage



Customer							
Product line		: NEMA Premium Efficiency Three-Phase		Product code :		11431306	
				Catalog # :		05036ST3QIE326TS-W22	
Frame		: 324/6TS		Cooling method		: IC411 - TEFC	
Insulation class		: F		Mounting		: F-1	
Duty cycle		: Cont.(S1)		Rotation ¹		: Both (CW and CCW)	
Ambient temperature		: -20°C to +40°C		Starting method		: Direct On Line	
Altitude		: 1000 m.a.s.l.		Approx. weight ²		: 560 lb	
Protection degree		: IP55		Moment of inertia (J)		: 5.75 sq.ft.lb	
Design		: B					
Output [HP]	50	40	40	40	50	50	50
Poles	2	2	2	2	2	2	2
Frequency [Hz]	60	50	50	50	50	50	50
Rated voltage [V]	460	380	400	415	380	400	415
Rated current [A]	56.7	54.9	52.7	51.4	69.4	65.4	63.3
L. R. Amperes [A]	357	362	374	370	361	366	392
LRC [A]	6.3x(Code G)	6.6x(Code G)	7.1x(Code H)	7.2x(Code H)	5.2x(Code E)	5.6x(Code F)	6.2x(Code G)
No load current [A]	14.0	13.0	14.0	15.0	13.0	14.0	15.0
Rated speed [RPM]	3555	2955	2960	2965	2935	2945	2950
Slip [%]	1.25	1.50	1.33	1.17	2.17	1.83	1.67
Rated torque [ft.lb]	73.9	71.1	71.0	70.8	89.5	89.2	89.0
Locked rotor torque [%]	240	240	260	280	190	210	229
Breakdown torque [%]	229	229	250	280	200	200	220
Service factor	1.25	1.00	1.00	1.00	1.00	1.00	1.00
Temperature rise	80 K	80 K	80 K	80 K	105 K	105 K	105 K
Locked rotor time	63s (cold)	68s (cold)	64s (cold)	61s (cold)	37s (cold)	43s (cold)	43s (cold)
	35s (hot)	38s (hot)	36s (hot)	34s (hot)	21s (hot)	24s (hot)	24s (hot)
Noise level ²	76.0 dB(A)	72.0 dB(A)	72.0 dB(A)	72.0 dB(A)	72.0 dB(A)	72.0 dB(A)	72.0 dB(A)
Efficiency (%)	25%	92.9	92.3	91.6	91.9	94.2	93.4
	50%	93.0	92.8	92.2	92.2	93.0	93.0
	75%	93.0	92.9	92.8	93.1	92.4	93.0
	100%	93.0	93.3	93.3	93.3	91.0	92.4
Power Factor	25%	0.58	0.58	0.55	0.52	0.65	0.59
	50%	0.81	0.80	0.77	0.76	0.85	0.82
	75%	0.87	0.87	0.85	0.84	0.88	0.86
	100%	0.88	0.89	0.88	0.87	0.89	0.88
Bearing type	: Drive end Non drive end		Foundation loads				
	: 6312 C3 6212 C3		Max. traction : 471 lb				
	: Inpro/Seal Inpro/Seal		Max. compression : 1031 lb				
	: 12000 h 15000 h						
	: 21 g 13 g						
Lubricant type		: Mobil Polyrex EM					
Notes							
This revision replaces and cancel the previous one, which must be eliminated. (1) Looking the motor from the shaft end. (2) Measured at 1m and with tolerance of +3dB(A). (3) Approximate weight subject to changes after manufacturing process. (4) At 100% of full load.				These are average values based on tests with sinusoidal power supply, subject to the tolerances stipulated in NEMA MG-1.			
Rev.	Changes Summary			Performed	Checked	Date	
Performed by							
Checked by					Page	Revision	
Date	12/04/2022				1 / 36		

TORQUE AND CURRENT VS SPEED CURVE

Three Phase Induction Motor - Squirrel Cage



Customer :

Product line : NEMA Premium Efficiency Three-Phase

Product code : 11431306

Catalog # : 05036ST3QIE326TS-W22

TORQUE AND CURRENT VS SPEED CURVE

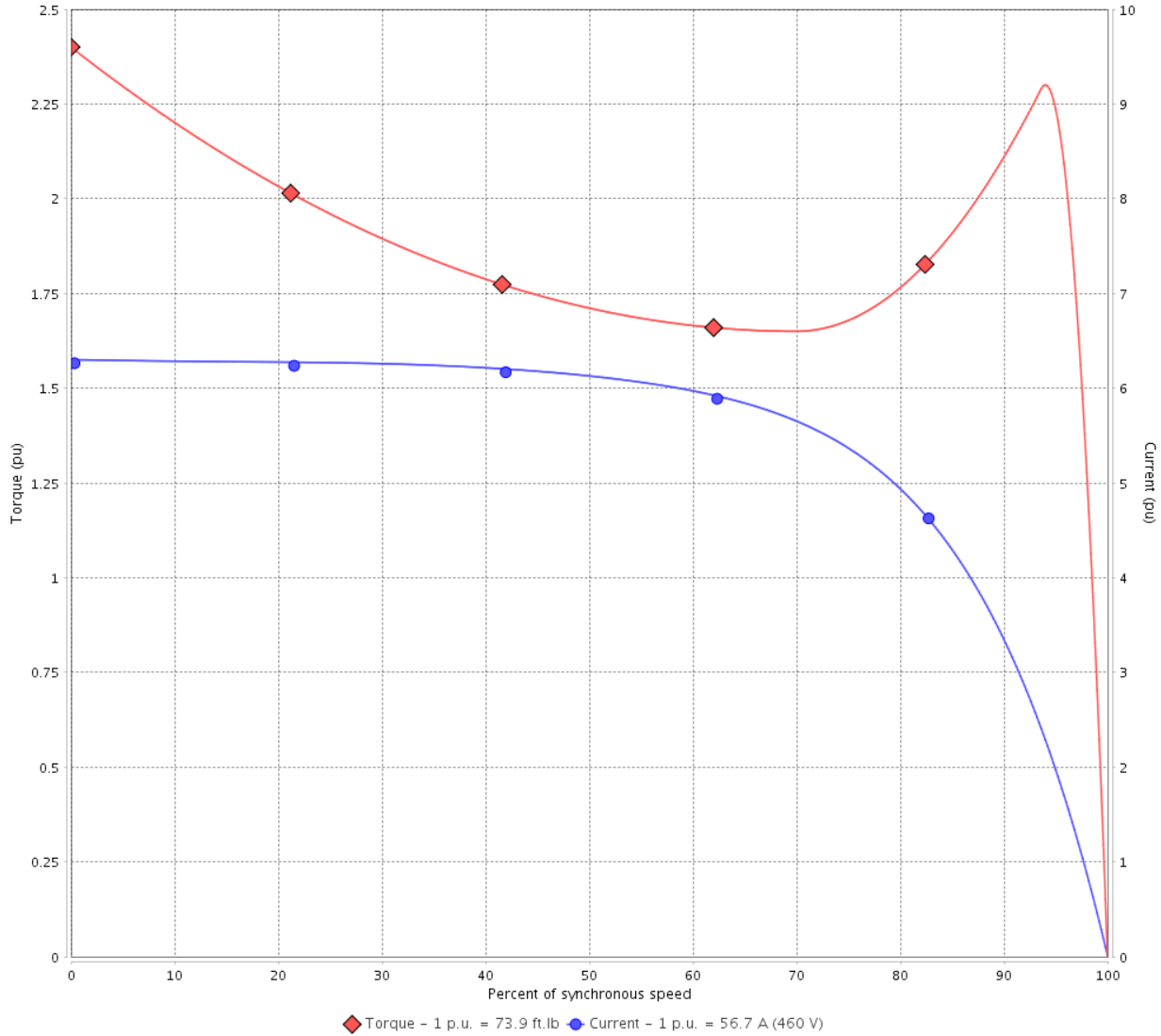

Performance : 460 V 60 Hz 2P

Rated current	: 56.7 A	Moment of inertia (J)	: 5.75 sq.ft.lb
LRC	: 6.3	Duty cycle	: Cont.(S1)
Rated torque	: 73.9 ft.lb	Insulation class	: F
Locked rotor torque	: 240 %	Service factor	: 1.25
Breakdown torque	: 229 %	Temperature rise	: 80 K
Rated speed	: 3555 rpm	Design	: B

Locked rotor time : 63s (cold) 35s (hot)

Rev.	Changes Summary	Performed	Checked	Date
Performed by			Page 2 / 36	Revision
Checked by				
Date	12/04/2022			

TORQUE AND CURRENT VS SPEED CURVE



Three Phase Induction Motor - Squirrel Cage

Customer :

Product line : NEMA Premium Efficiency Three-Phase

Product code : 11431306

Catalog # : 05036ST3QIE326TS-W22

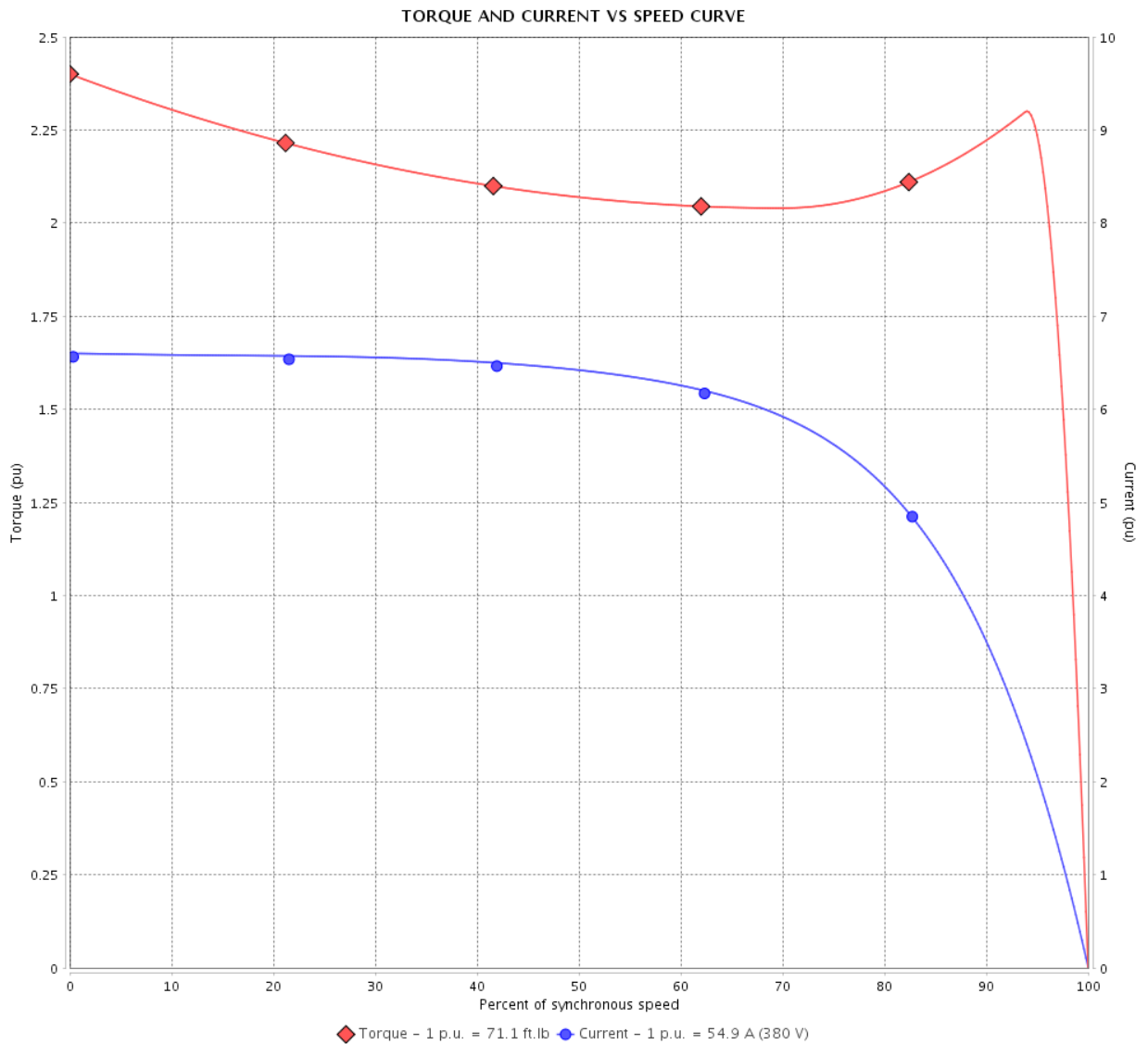

Performance : 380 V 50 Hz 2P IE3

Rated current	: 54.9 A	Moment of inertia (J)	: 5.75 sq.ft.lb
LRC	: 6.6	Duty cycle	: Cont.(S1)
Rated torque	: 71.1 ft.lb	Insulation class	: F
Locked rotor torque	: 240 %	Service factor	: 1.00
Breakdown torque	: 229 %	Temperature rise	: 80 K
Rated speed	: 2955 rpm	Design	: B

Locked rotor time : 68s (cold) 38s (hot)

Rev.	Changes Summary	Performed	Checked	Date
Performed by			Page 3 / 36	Revision
Checked by				
Date	12/04/2022			

TORQUE AND CURRENT VS SPEED CURVE

Three Phase Induction Motor - Squirrel Cage



Customer :

Product line : NEMA Premium Efficiency Three-Phase

Product code : 11431306

Catalog # : 05036ST3QIE326TS-W22

TORQUE AND CURRENT VS SPEED CURVE

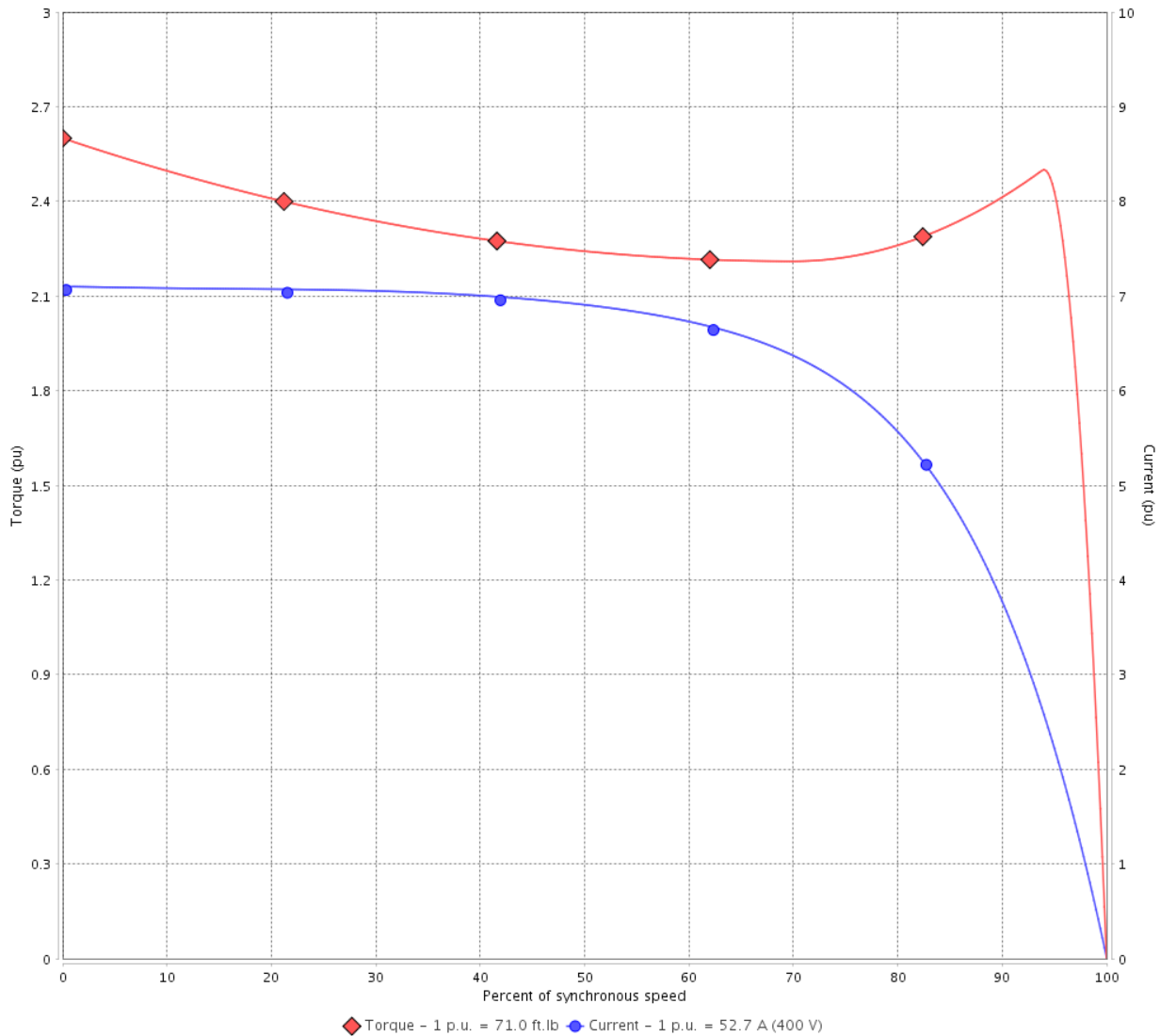

Performance : 400 V 50 Hz 2P IE3

Rated current	: 52.7 A	Moment of inertia (J)	: 5.75 sq.ft.lb
LRC	: 7.1	Duty cycle	: Cont.(S1)
Rated torque	: 71.0 ft.lb	Insulation class	: F
Locked rotor torque	: 260 %	Service factor	: 1.00
Breakdown torque	: 250 %	Temperature rise	: 80 K
Rated speed	: 2960 rpm	Design	: B

Locked rotor time : 64s (cold) 36s (hot)

Rev.	Changes Summary	Performed	Checked	Date
Performed by			Page 4 / 36	Revision
Checked by				
Date	12/04/2022			

TORQUE AND CURRENT VS SPEED CURVE



Three Phase Induction Motor - Squirrel Cage

Customer :

Product line : NEMA Premium Efficiency Three-Phase

Product code : 11431306

Catalog # : 05036ST3QIE326TS-W22

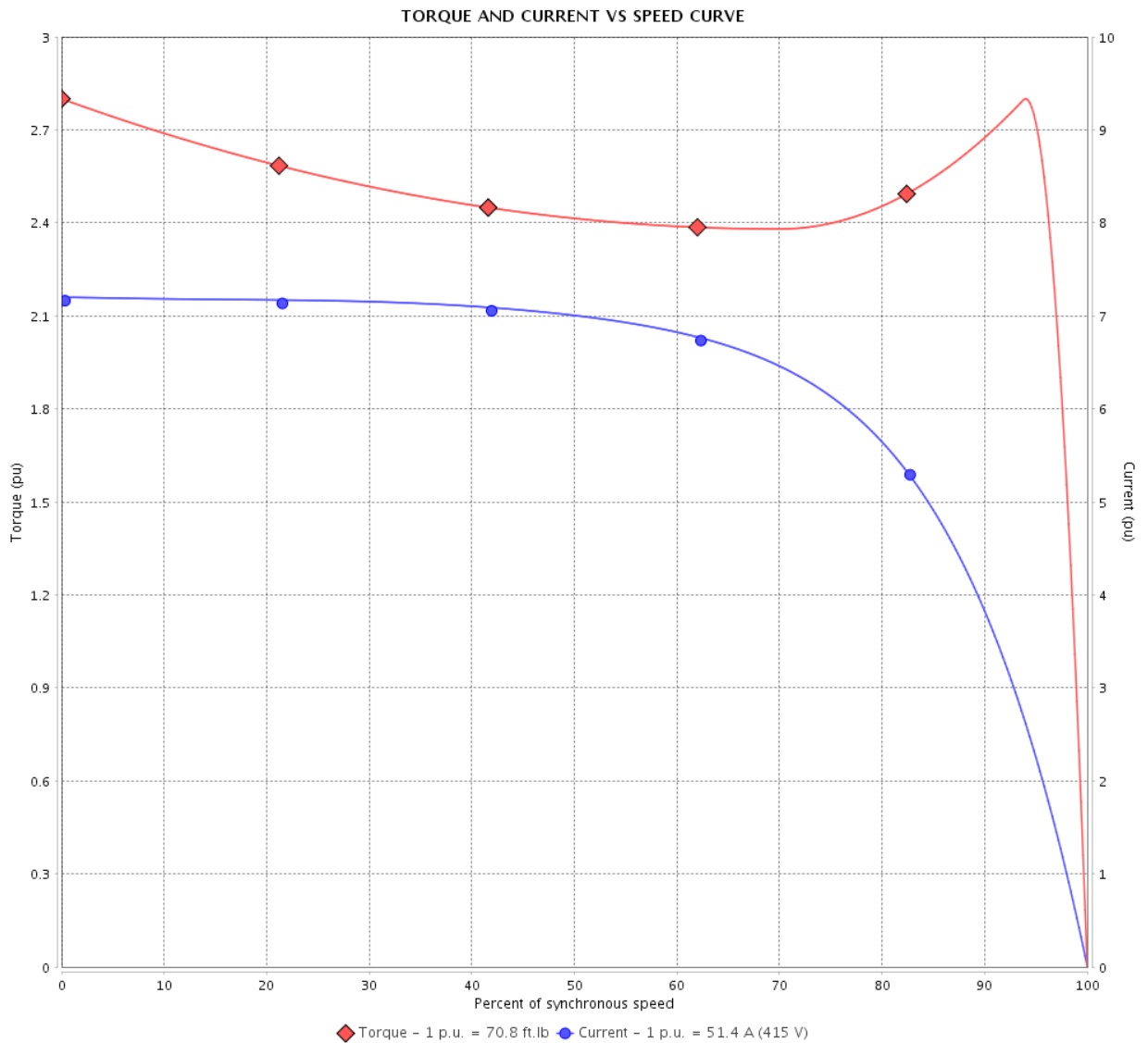

Performance : 415 V 50 Hz 2P IE3

Rated current	: 51.4 A	Moment of inertia (J)	: 5.75 sq.ft.lb
LRC	: 7.2	Duty cycle	: Cont.(S1)
Rated torque	: 70.8 ft.lb	Insulation class	: F
Locked rotor torque	: 280 %	Service factor	: 1.00
Breakdown torque	: 280 %	Temperature rise	: 80 K
Rated speed	: 2965 rpm	Design	: B

Locked rotor time : 61s (cold) 34s (hot)

Rev.	Changes Summary	Performed	Checked	Date
Performed by		Page		Revision
Checked by		5 / 36		
Date	12/04/2022			

TORQUE AND CURRENT VS SPEED CURVE

Three Phase Induction Motor - Squirrel Cage



Customer :

Product line : NEMA Premium Efficiency Three-Phase

Product code : 11431306

Catalog # : 05036ST3QIE326TS-W22

TORQUE AND CURRENT VS SPEED CURVE

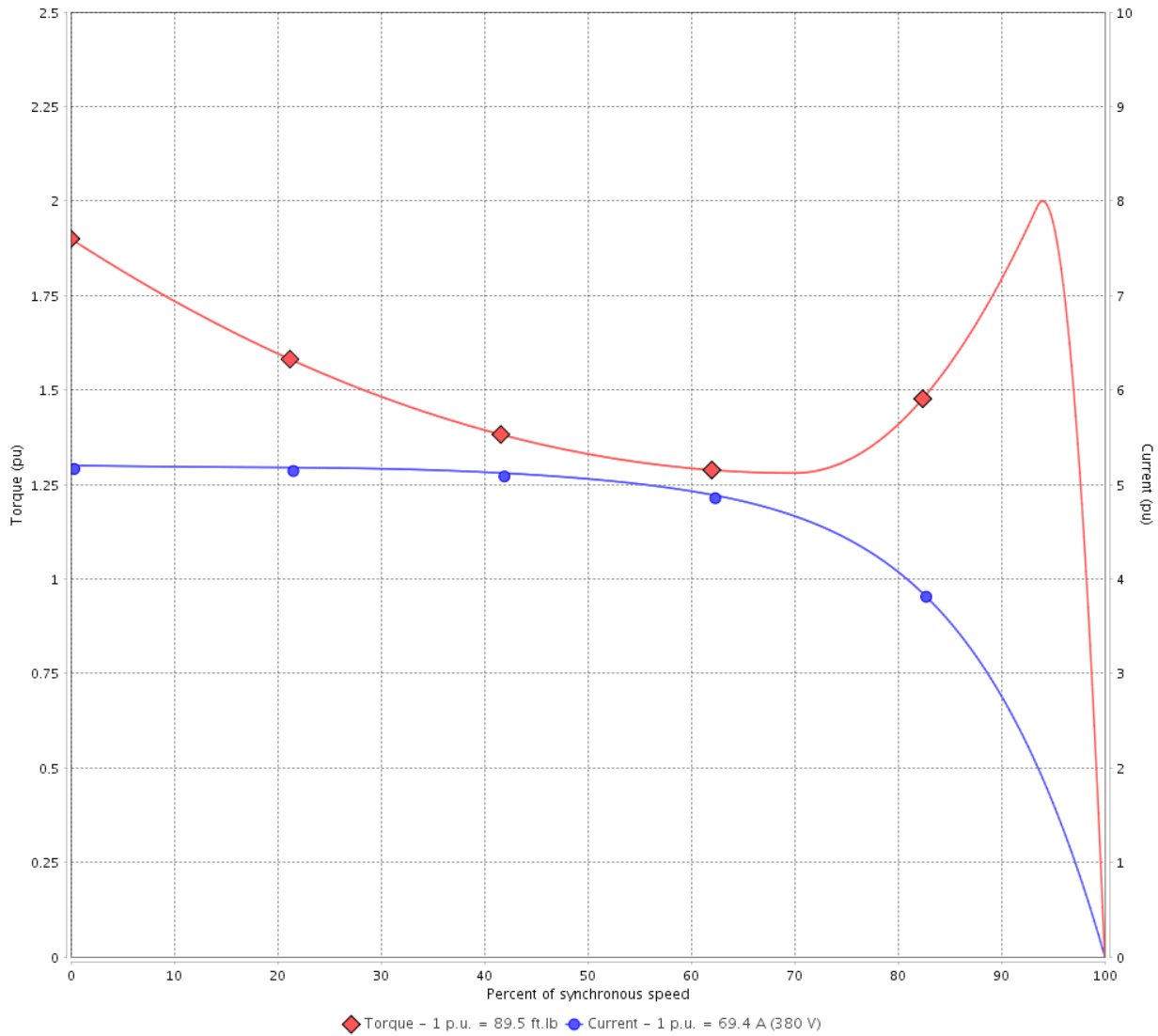

Performance : 380 V 50 Hz 2P

Rated current	: 69.4 A	Moment of inertia (J)	: 5.75 sq.ft.lb
LRC	: 5.2	Duty cycle	: Cont.(S1)
Rated torque	: 89.5 ft.lb	Insulation class	: F
Locked rotor torque	: 190 %	Service factor	: 1.00
Breakdown torque	: 200 %	Temperature rise	: 105 K
Rated speed	: 2935 rpm	Design	: B

Locked rotor time : 37s (cold) 21s (hot)

Rev.	Changes Summary	Performed	Checked	Date
Performed by			Page 6 / 36	Revision
Checked by				
Date	12/04/2022			

TORQUE AND CURRENT VS SPEED CURVE



Three Phase Induction Motor - Squirrel Cage

Customer :

Product line : NEMA Premium Efficiency Three-Phase

Product code : 11431306

Catalog # : 05036ST3QIE326TS-W22

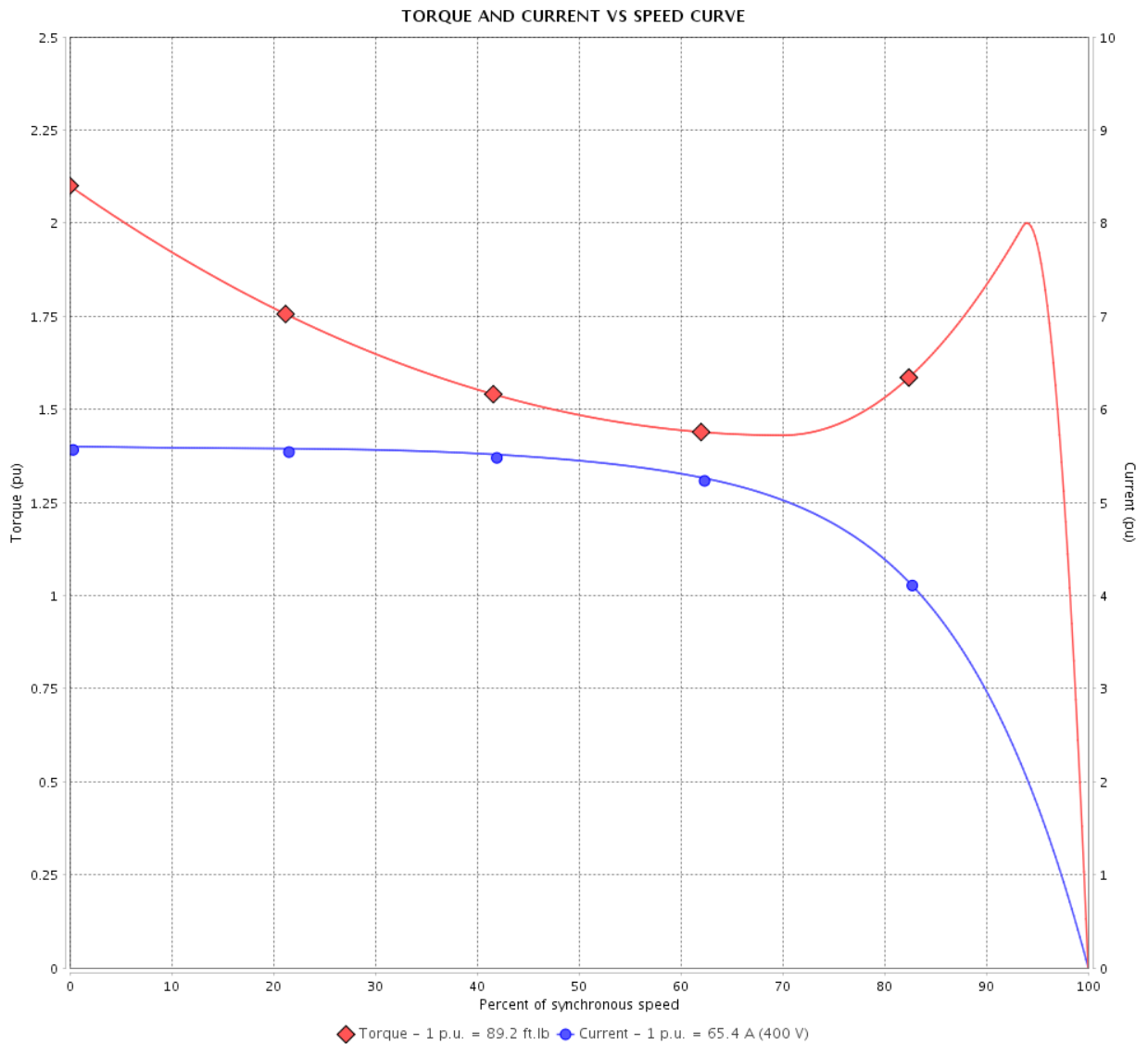

Performance : 400 V 50 Hz 2P IE1

Rated current	: 65.4 A	Moment of inertia (J)	: 5.75 sq.ft.lb
LRC	: 5.6	Duty cycle	: Cont.(S1)
Rated torque	: 89.2 ft.lb	Insulation class	: F
Locked rotor torque	: 210 %	Service factor	: 1.00
Breakdown torque	: 200 %	Temperature rise	: 105 K
Rated speed	: 2945 rpm	Design	: B

Locked rotor time : 43s (cold) 24s (hot)

Rev.	Changes Summary	Performed	Checked	Date
Performed by			Page 7 / 36	Revision
Checked by				
Date	12/04/2022			

TORQUE AND CURRENT VS SPEED CURVE

Three Phase Induction Motor - Squirrel Cage



Customer :

Product line : NEMA Premium Efficiency Three-Phase

Product code : 11431306

Catalog # : 05036ST3QIE326TS-W22

TORQUE AND CURRENT VS SPEED CURVE

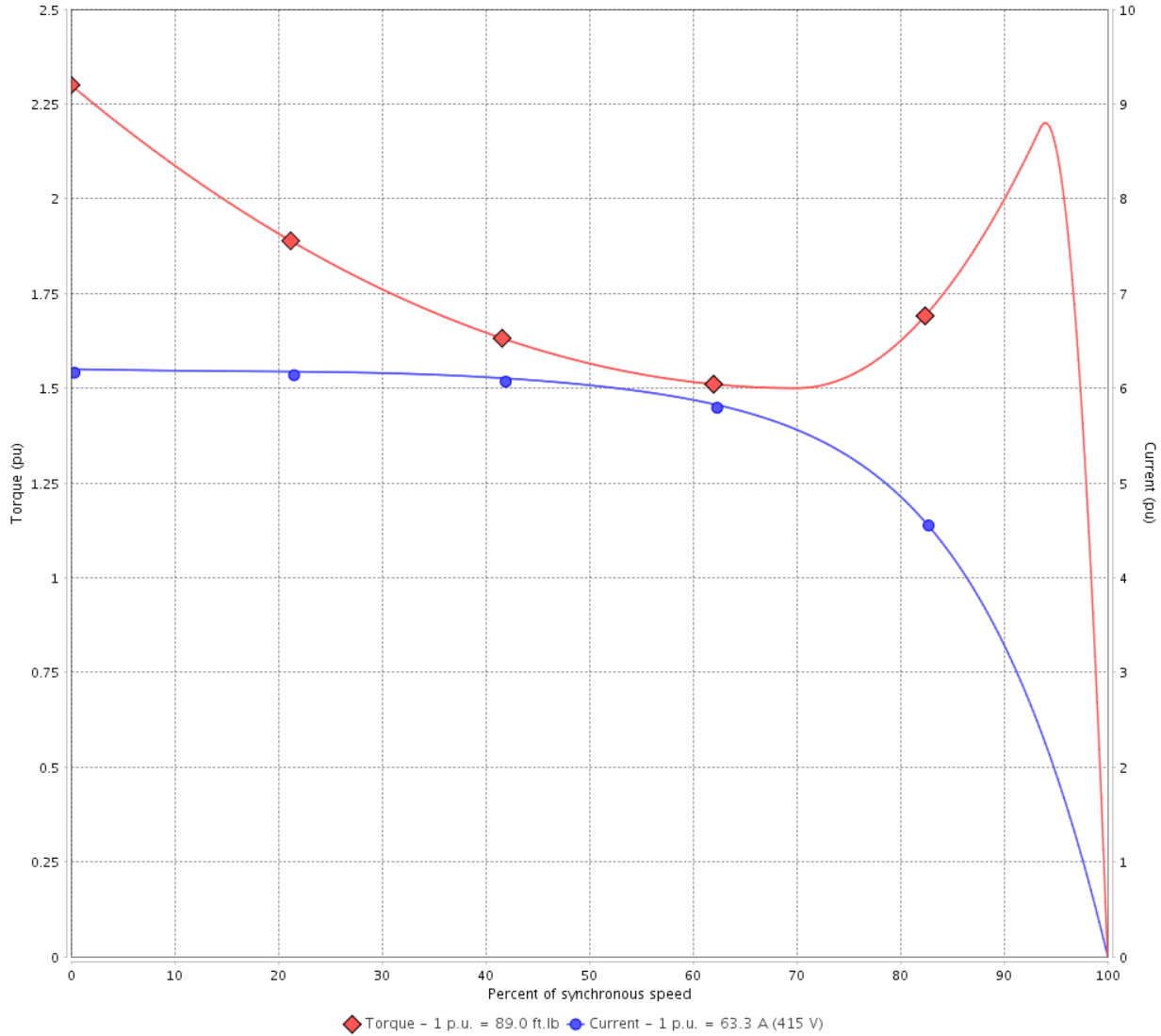

Performance : 415 V 50 Hz 2P IE1

Rated current	: 63.3 A	Moment of inertia (J)	: 5.75 sq.ft.lb
LRC	: 6.2	Duty cycle	: Cont.(S1)
Rated torque	: 89.0 ft.lb	Insulation class	: F
Locked rotor torque	: 229 %	Service factor	: 1.00
Breakdown torque	: 220 %	Temperature rise	: 105 K
Rated speed	: 2950 rpm	Design	: B

Locked rotor time : 43s (cold) 24s (hot)

Rev.	Changes Summary	Performed	Checked	Date
Performed by			Page 8 / 36	Revision
Checked by				
Date	12/04/2022			

LOAD PERFORMANCE CURVE

Three Phase Induction Motor - Squirrel Cage



Customer : _____

Product line : NEMA Premium Efficiency Three-Phase

Product code : 11431306

Catalog # : 05036ST3QIE326TS-W22

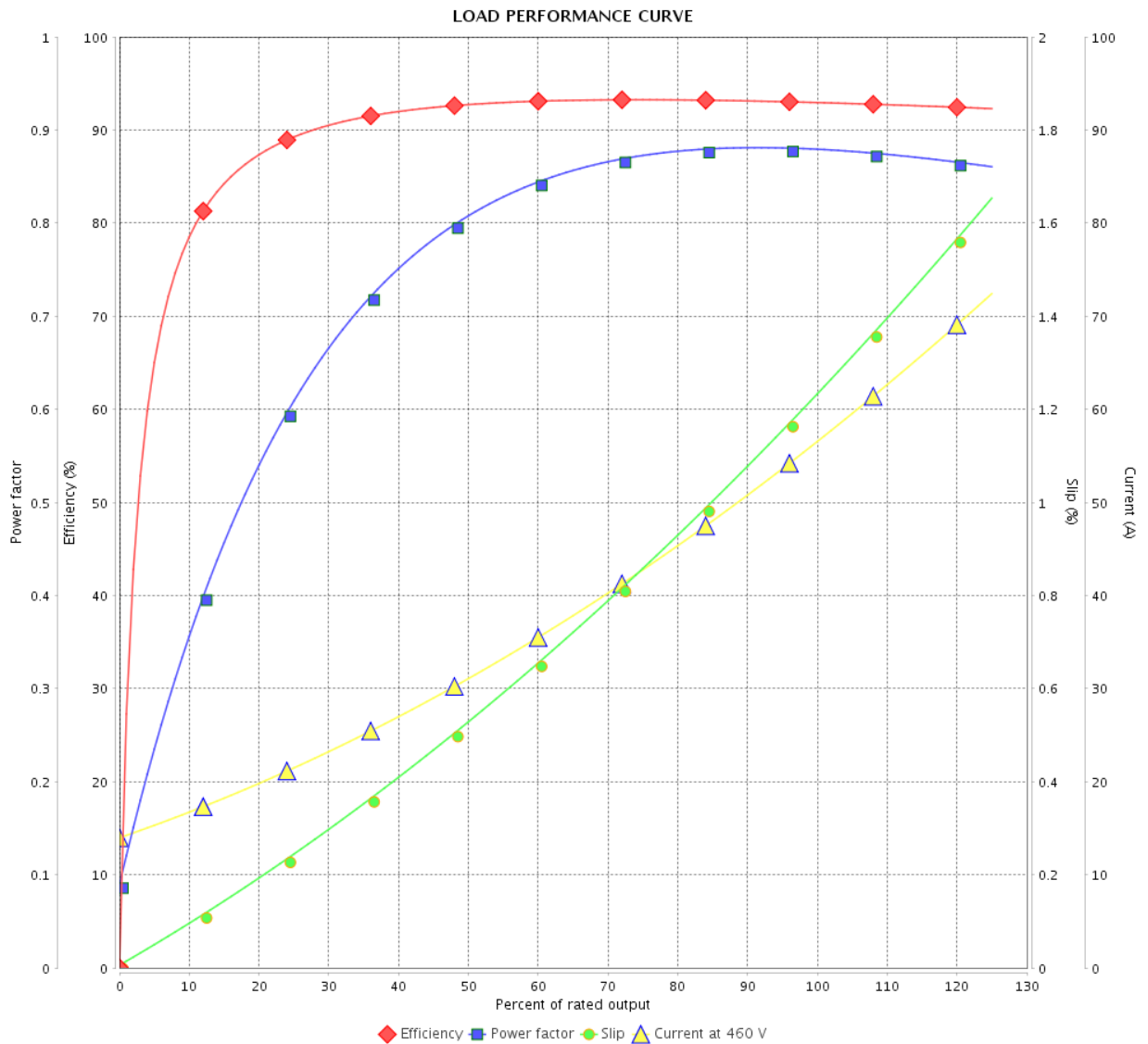

Performance : 460 V 60 Hz 2P

Rated current : 56.7 A
 LRC : 6.3
 Rated torque : 73.9 ft.lb
 Locked rotor torque : 240 %
 Breakdown torque : 229 %
 Rated speed : 3555 rpm

Moment of inertia (J) : 5.75 sq.ft.lb
 Duty cycle : Cont.(S1)
 Insulation class : F
 Service factor : 1.25
 Temperature rise : 80 K
 Design : B

Rev.	Changes Summary	Performed	Checked	Date
Performed by			Page	Revision
Checked by				
Date				

LOAD PERFORMANCE CURVE

Three Phase Induction Motor - Squirrel Cage



Customer :

Product line : NEMA Premium Efficiency Three-Phase

Product code : 11431306

Catalog # : 05036ST3QIE326TS-W22

LOAD PERFORMANCE CURVE

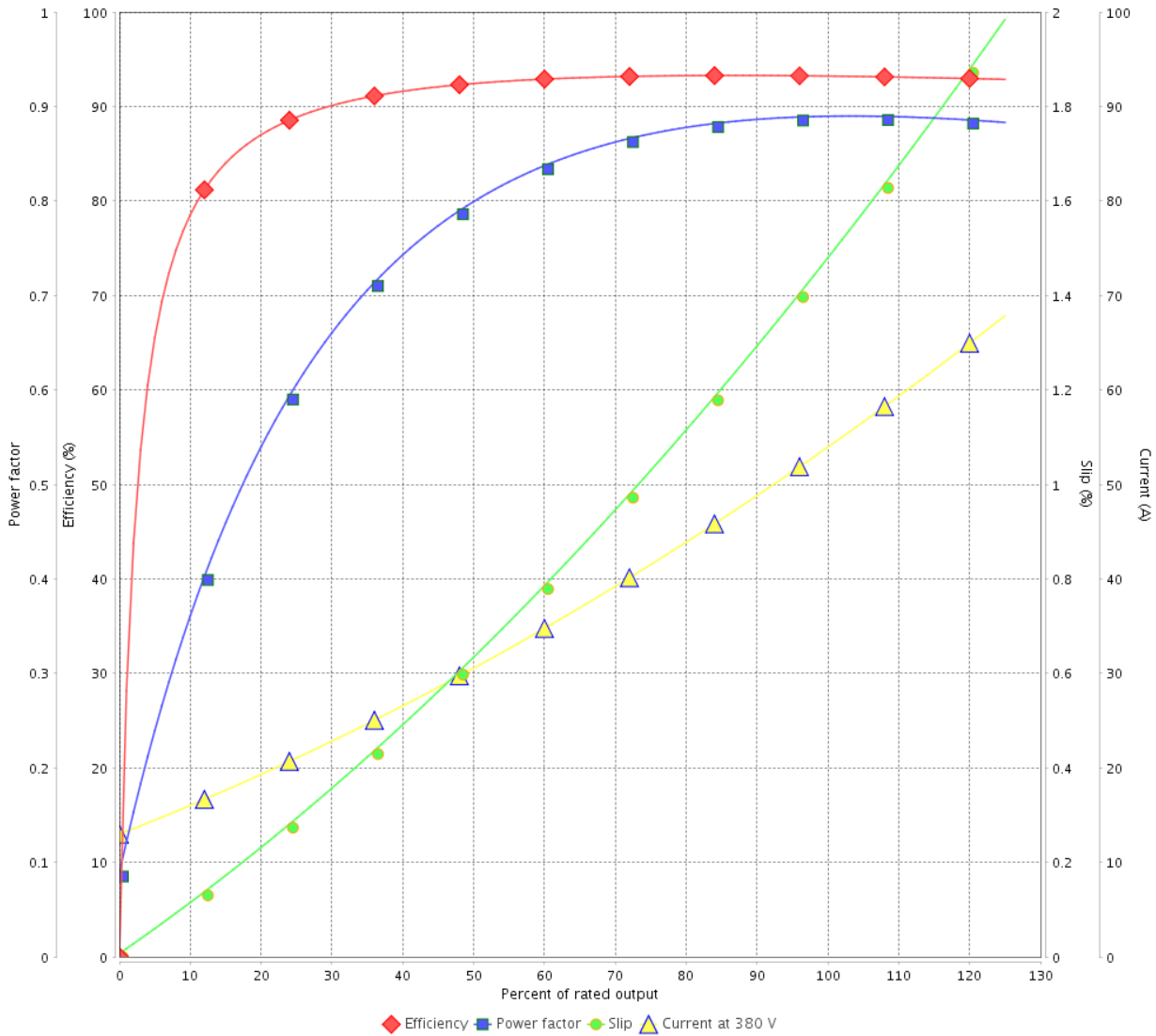

Performance : 380 V 50 Hz 2P IE3

Rated current : 54.9 A
 LRC : 6.6
 Rated torque : 71.1 ft.lb
 Locked rotor torque : 240 %
 Breakdown torque : 229 %
 Rated speed : 2955 rpm

Moment of inertia (J) : 5.75 sq.ft.lb
 Duty cycle : Cont.(S1)
 Insulation class : F
 Service factor : 1.00
 Temperature rise : 80 K
 Design : B

Rev.	Changes Summary	Performed	Checked	Date
Performed by			Page	Revision
Checked by				
Date				

LOAD PERFORMANCE CURVE

Three Phase Induction Motor - Squirrel Cage



Customer : _____

Product line : NEMA Premium Efficiency Three-Phase

Product code : 11431306

Catalog # : 05036ST3QIE326TS-W22

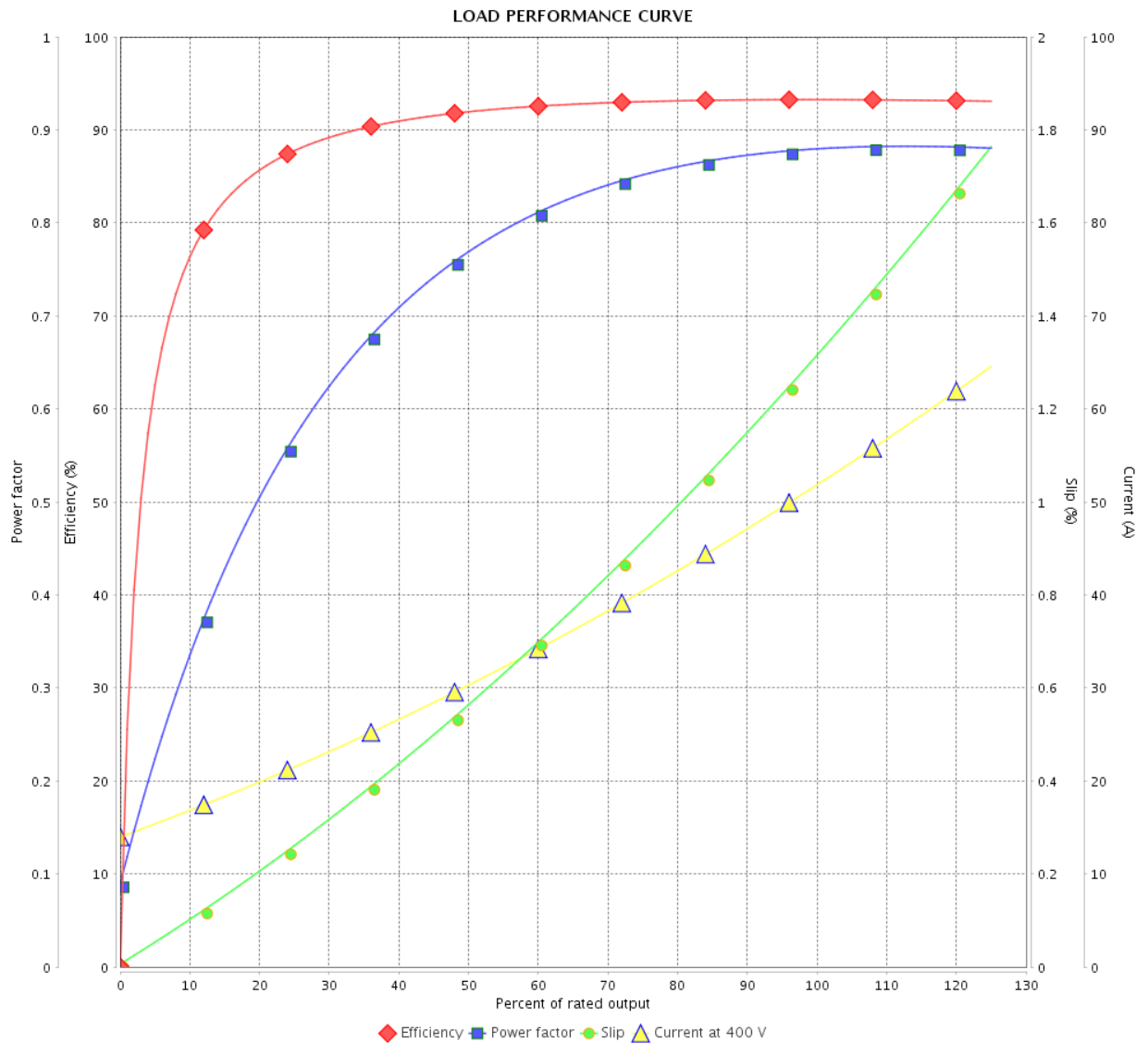

Performance : 400 V 50 Hz 2P IE3

Rated current : 52.7 A
 LRC : 7.1
 Rated torque : 71.0 ft.lb
 Locked rotor torque : 260 %
 Breakdown torque : 250 %
 Rated speed : 2960 rpm

Moment of inertia (J) : 5.75 sq.ft.lb
 Duty cycle : Cont.(S1)
 Insulation class : F
 Service factor : 1.00
 Temperature rise : 80 K
 Design : B

Rev.	Changes Summary	Performed	Checked	Date
Performed by		Page		Revision
Checked by		11 / 36		
Date		12/04/2022		

LOAD PERFORMANCE CURVE

Three Phase Induction Motor - Squirrel Cage



Customer :

Product line : NEMA Premium Efficiency Three-Phase

Product code : 11431306

Catalog # : 05036ST3QIE326TS-W22

LOAD PERFORMANCE CURVE

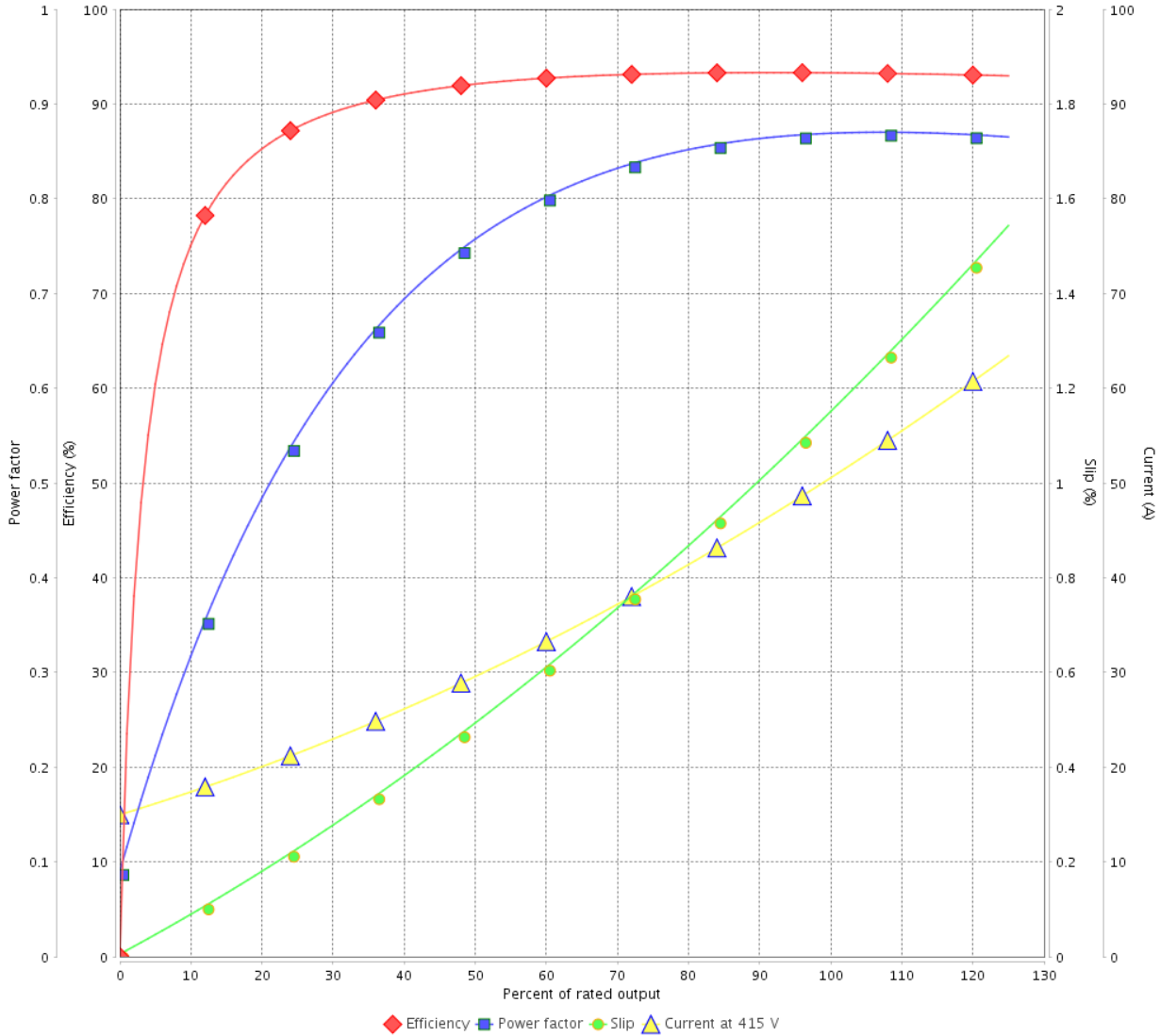

Performance : 415 V 50 Hz 2P IE3

Rated current : 51.4 A
 LRC : 7.2
 Rated torque : 70.8 ft.lb
 Locked rotor torque : 280 %
 Breakdown torque : 280 %
 Rated speed : 2965 rpm

Moment of inertia (J) : 5.75 sq.ft.lb
 Duty cycle : Cont.(S1)
 Insulation class : F
 Service factor : 1.00
 Temperature rise : 80 K
 Design : B

Rev.	Changes Summary	Performed	Checked	Date
Performed by		Page		Revision
Checked by		12 / 36		
Date		12/04/2022		

LOAD PERFORMANCE CURVE

Three Phase Induction Motor - Squirrel Cage



Customer :

Product line : NEMA Premium Efficiency Three-Phase

Product code : 11431306

Catalog # : 05036ST3QIE326TS-W22

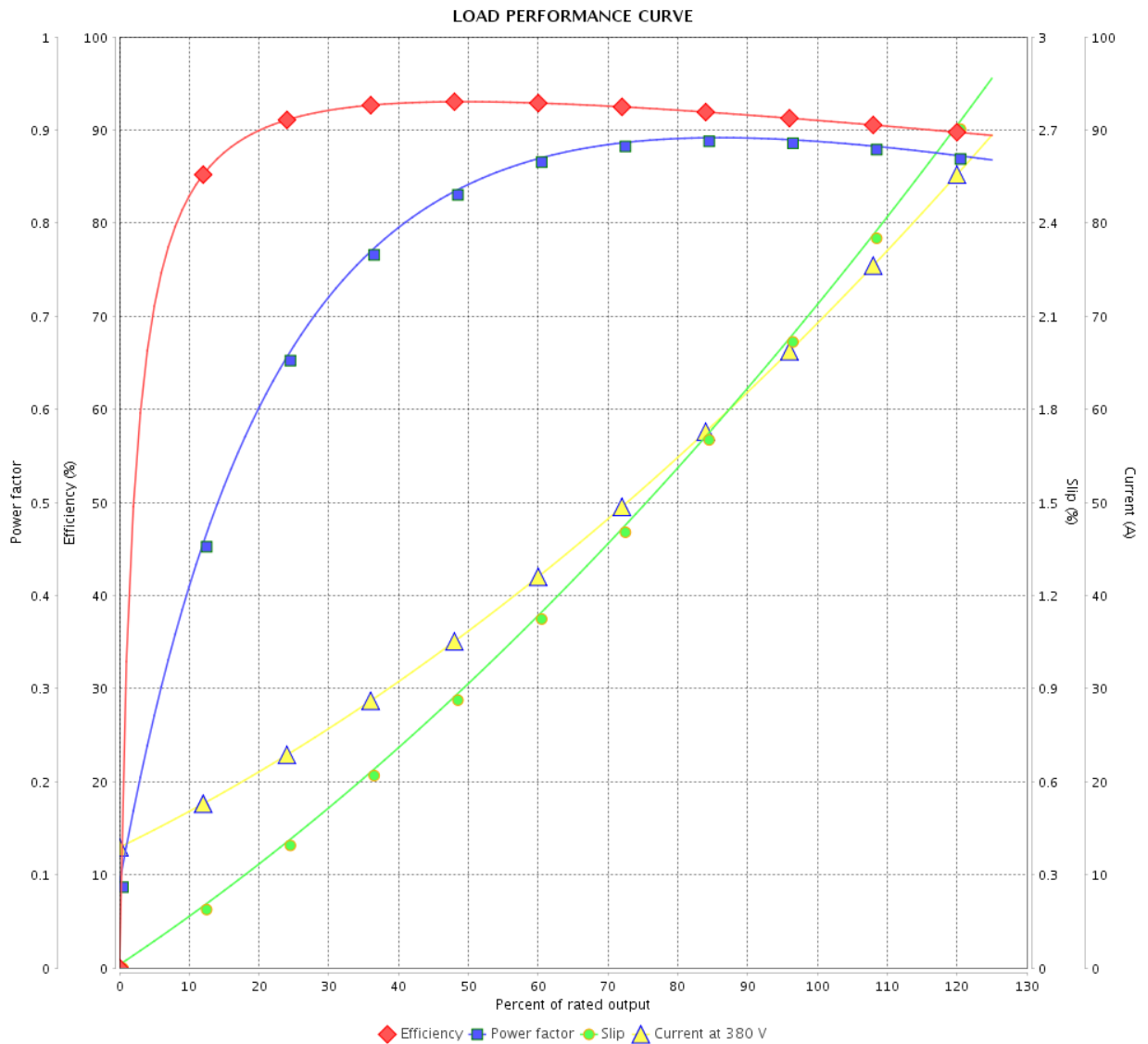

Performance : 380 V 50 Hz 2P

Rated current : 69.4 A
 LRC : 5.2
 Rated torque : 89.5 ft.lb
 Locked rotor torque : 190 %
 Breakdown torque : 200 %
 Rated speed : 2935 rpm

Moment of inertia (J) : 5.75 sq.ft.lb
 Duty cycle : Cont.(S1)
 Insulation class : F
 Service factor : 1.00
 Temperature rise : 105 K
 Design : B

Rev.	Changes Summary	Performed	Checked	Date
Performed by		Page		Revision
Checked by		13 / 36		
Date		12/04/2022		

LOAD PERFORMANCE CURVE

Three Phase Induction Motor - Squirrel Cage



Customer :

Product line : NEMA Premium Efficiency Three-Phase

Product code : 11431306

Catalog # : 05036ST3QIE326TS-W22

LOAD PERFORMANCE CURVE

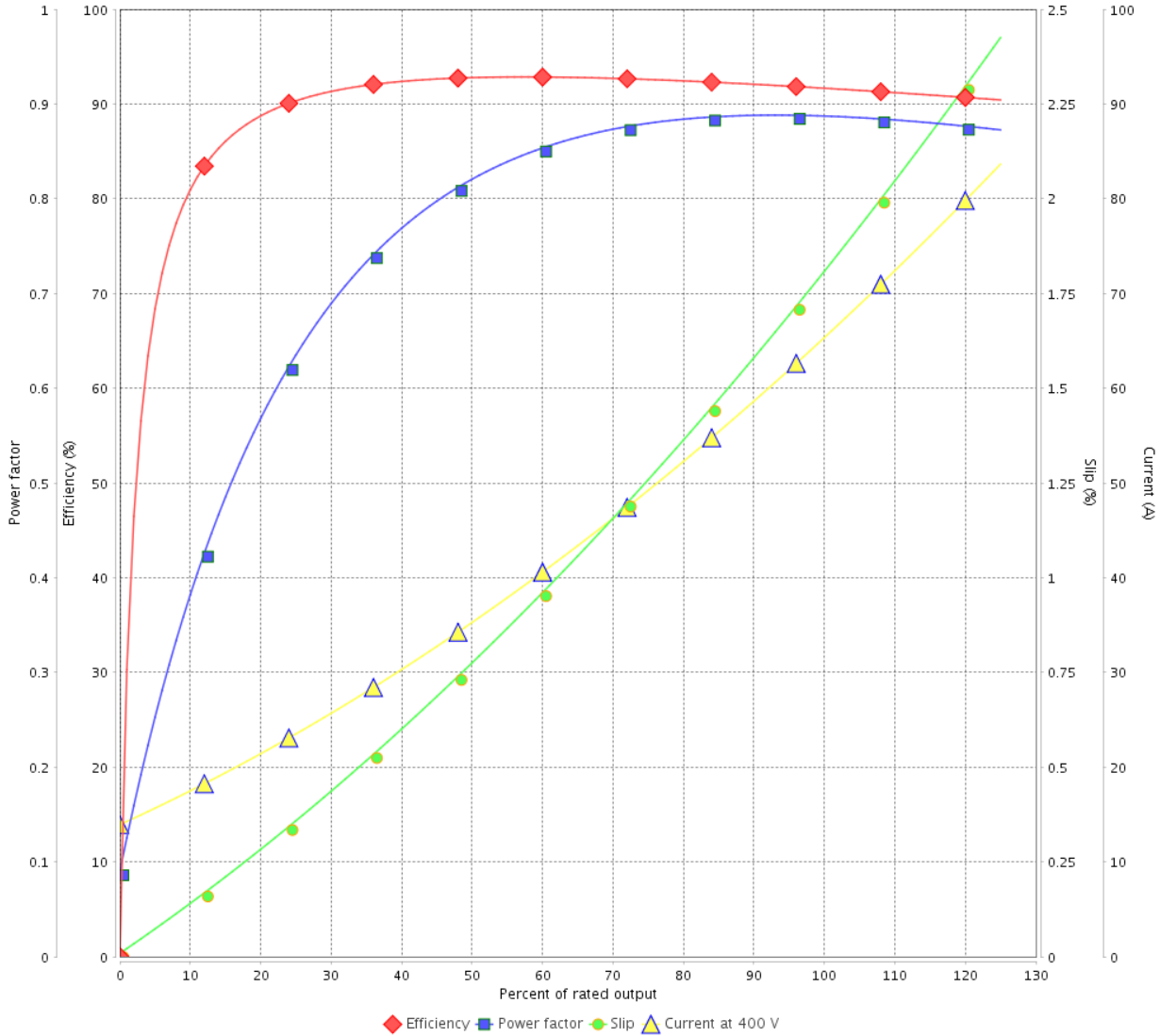

Performance : 400 V 50 Hz 2P IE1

Rated current : 65.4 A
 LRC : 5.6
 Rated torque : 89.2 ft.lb
 Locked rotor torque : 210 %
 Breakdown torque : 200 %
 Rated speed : 2945 rpm

Moment of inertia (J) : 5.75 sq.ft.lb
 Duty cycle : Cont.(S1)
 Insulation class : F
 Service factor : 1.00
 Temperature rise : 105 K
 Design : B

Rev.	Changes Summary	Performed	Checked	Date
Performed by			Page 14 / 36	Revision
Checked by				
Date	12/04/2022			

LOAD PERFORMANCE CURVE

Three Phase Induction Motor - Squirrel Cage



Customer : _____

Product line : NEMA Premium Efficiency Three-Phase

Product code : 11431306

Catalog # : 05036ST3QIE326TS-W22

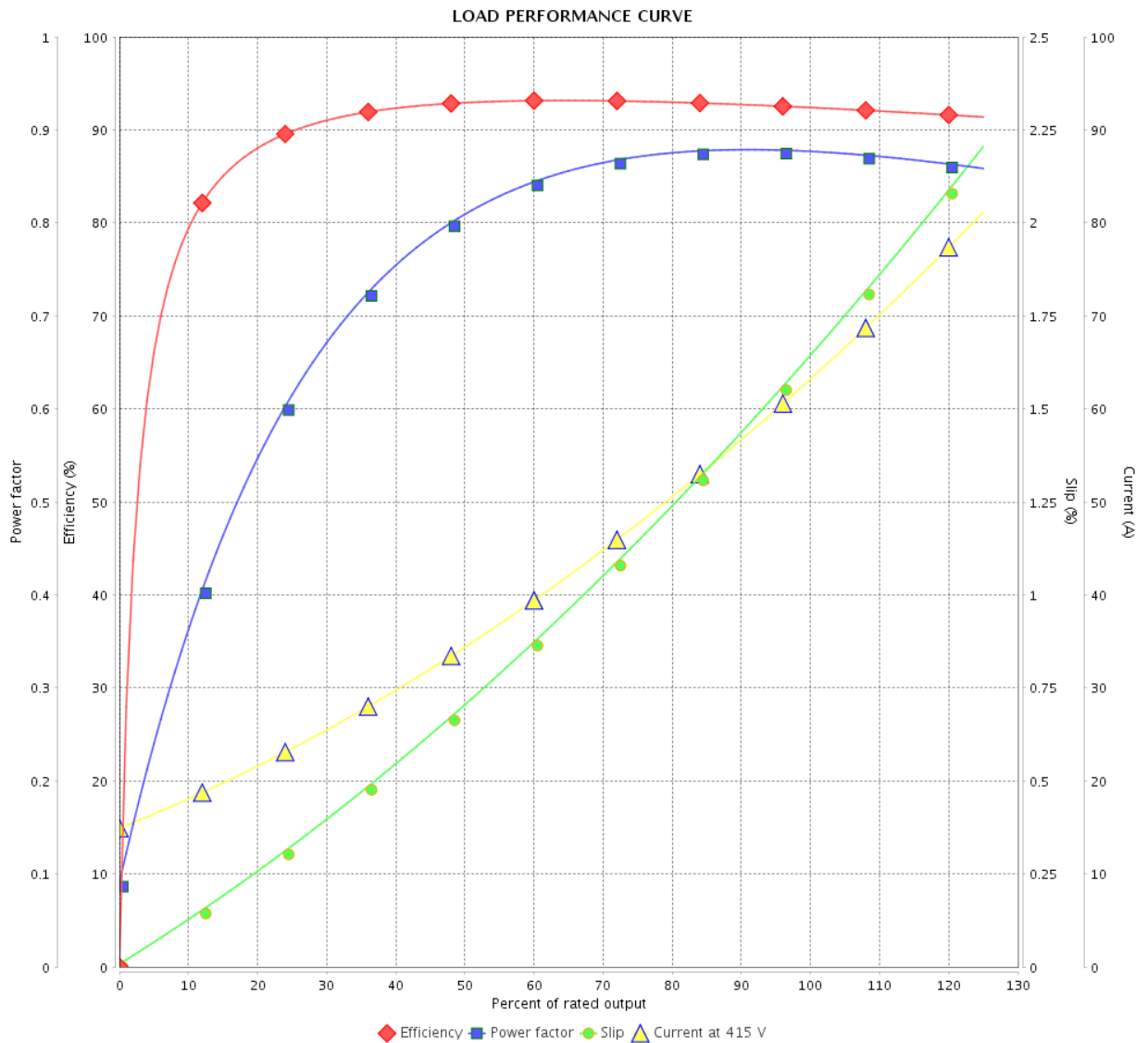

Performance : 415 V 50 Hz 2P IE1

Rated current : 63.3 A
 LRC : 6.2
 Rated torque : 89.0 ft.lb
 Locked rotor torque : 229 %
 Breakdown torque : 220 %
 Rated speed : 2950 rpm

Moment of inertia (J) : 5.75 sq.ft.lb
 Duty cycle : Cont.(S1)
 Insulation class : F
 Service factor : 1.00
 Temperature rise : 105 K
 Design : B

Rev.	Changes Summary	Performed	Checked	Date
Performed by		Page		Revision
Checked by		15 / 36		
Date		12/04/2022		

THERMAL LIMIT CURVE



Three Phase Induction Motor - Squirrel Cage

Customer :

Product line : NEMA Premium Efficiency Three-Phase
Product code : 11431306
Catalog # : 05036ST3QIE326TS-W22

Performance : 460 V 60 Hz 2P

Rated current	: 56.7 A	Moment of inertia (J)	: 5.75 sq.ft.lb
LRC	: 6.3	Duty cycle	: Cont.(S1)
Rated torque	: 73.9 ft.lb	Insulation class	: F
Locked rotor torque	: 240 %	Service factor	: 1.25
Breakdown torque	: 229 %	Temperature rise	: 80 K
Rated speed	: 3555 rpm	Design	: B

Heating constant

Cooling constant

Rev.	Changes Summary	Performed	Checked	Date
Performed by				
Checked by			Page	Revision
Date	12/04/2022		16 / 36	

THERMAL LIMIT CURVE

Three Phase Induction Motor - Squirrel Cage



Customer : _____

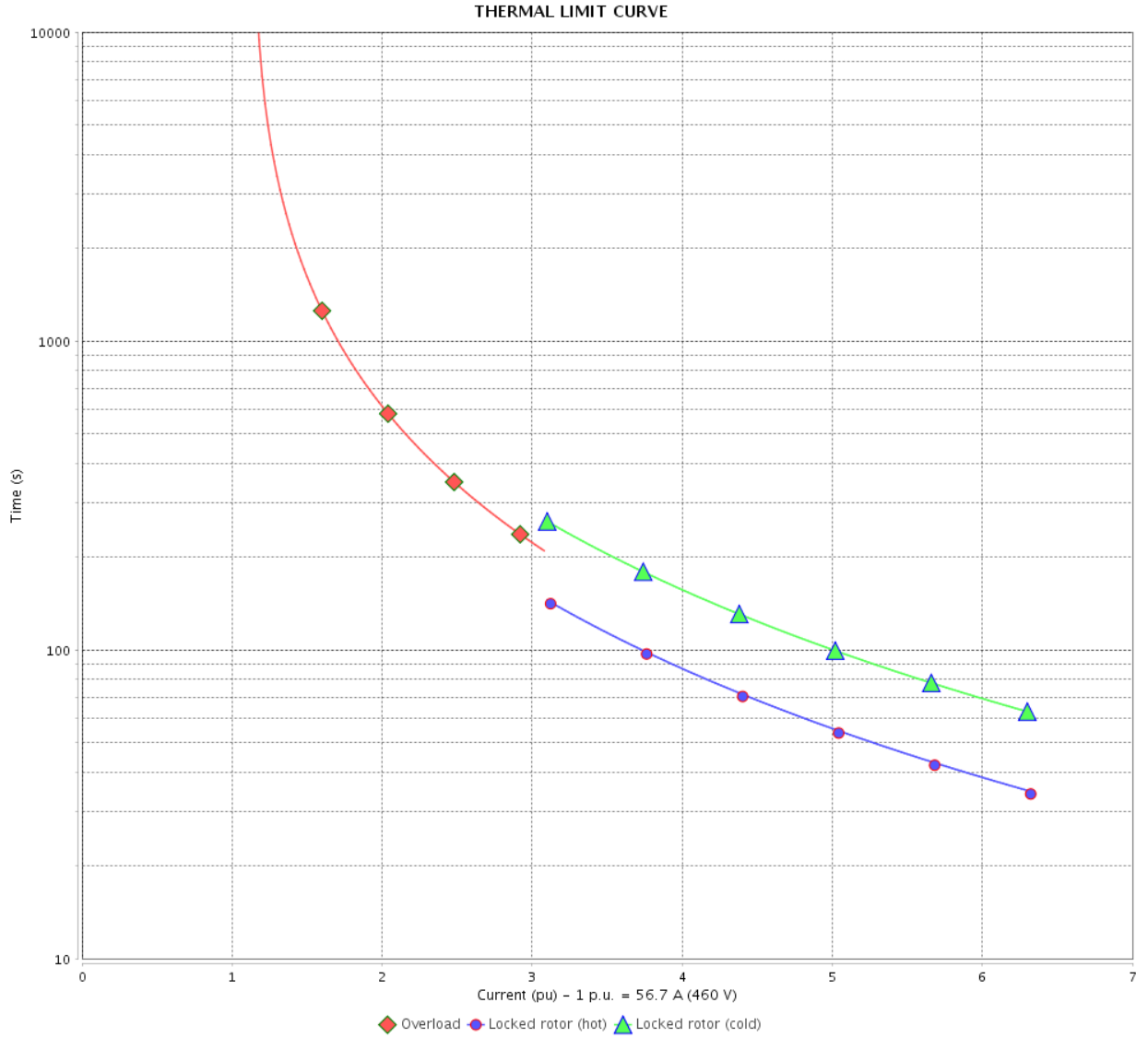

Rev.	Changes Summary	Performed	Checked	Date
Performed by		Page		Revision
Checked by		17 / 36		
Date		12/04/2022		

THERMAL LIMIT CURVE



Three Phase Induction Motor - Squirrel Cage

Customer :

Product line : NEMA Premium Efficiency Three-Phase
 Product code : 11431306
 Catalog # : 05036ST3QIE326TS-W22

Performance : 380 V 50 Hz 2P IE3

Rated current : 54.9 A	Moment of inertia (J) : 5.75 sq.ft.lb
LRC : 6.6	Duty cycle : Cont.(S1)
Rated torque : 71.1 ft.lb	Insulation class : F
Locked rotor torque : 240 %	Service factor : 1.00
Breakdown torque : 229 %	Temperature rise : 80 K
Rated speed : 2955 rpm	Design : B

Heating constant

Cooling constant

Rev.	Changes Summary	Performed	Checked	Date
Performed by			Page 18 / 36	Revision
Checked by				
Date	12/04/2022			

THERMAL LIMIT CURVE

Three Phase Induction Motor - Squirrel Cage



Customer : _____

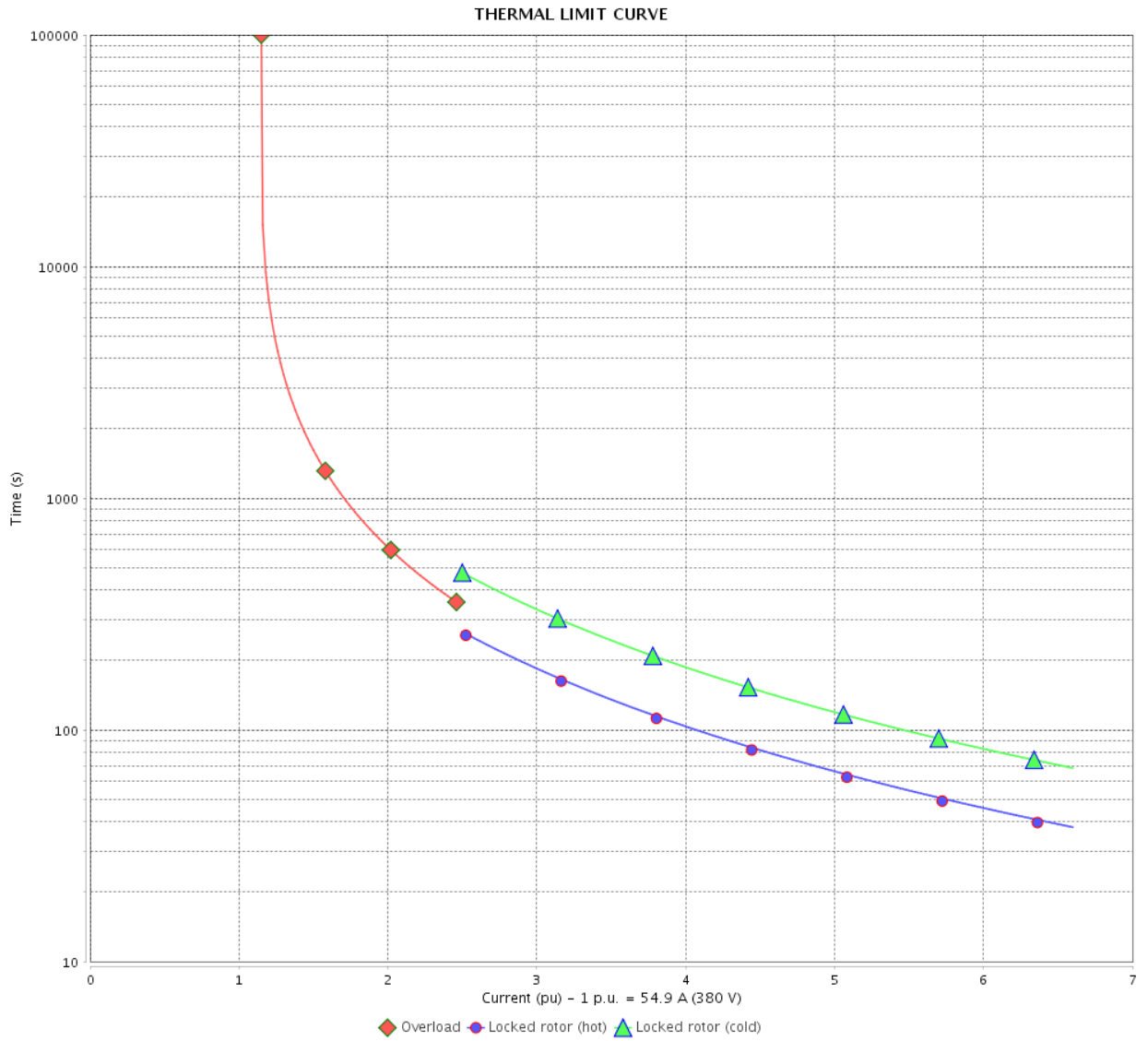

Rev.	Changes Summary	Performed	Checked	Date
Performed by		Page 19 / 36		Revision
Checked by				
Date				

THERMAL LIMIT CURVE

Three Phase Induction Motor - Squirrel Cage



Customer :

Product line : NEMA Premium Efficiency Three-Phase
Product code : 11431306
Catalog # : 05036ST3QIE326TS-W22

Performance : 400 V 50 Hz 2P IE3

Rated current	: 52.7 A	Moment of inertia (J)	: 5.75 sq.ft.lb
LRC	: 7.1	Duty cycle	: Cont.(S1)
Rated torque	: 71.0 ft.lb	Insulation class	: F
Locked rotor torque	: 260 %	Service factor	: 1.00
Breakdown torque	: 250 %	Temperature rise	: 80 K
Rated speed	: 2960 rpm	Design	: B

Heating constant

Cooling constant

Rev.	Changes Summary	Performed	Checked	Date
Performed by				
Checked by			Page	Revision
Date	12/04/2022		20 / 36	

THERMAL LIMIT CURVE

Three Phase Induction Motor - Squirrel Cage



Customer : _____

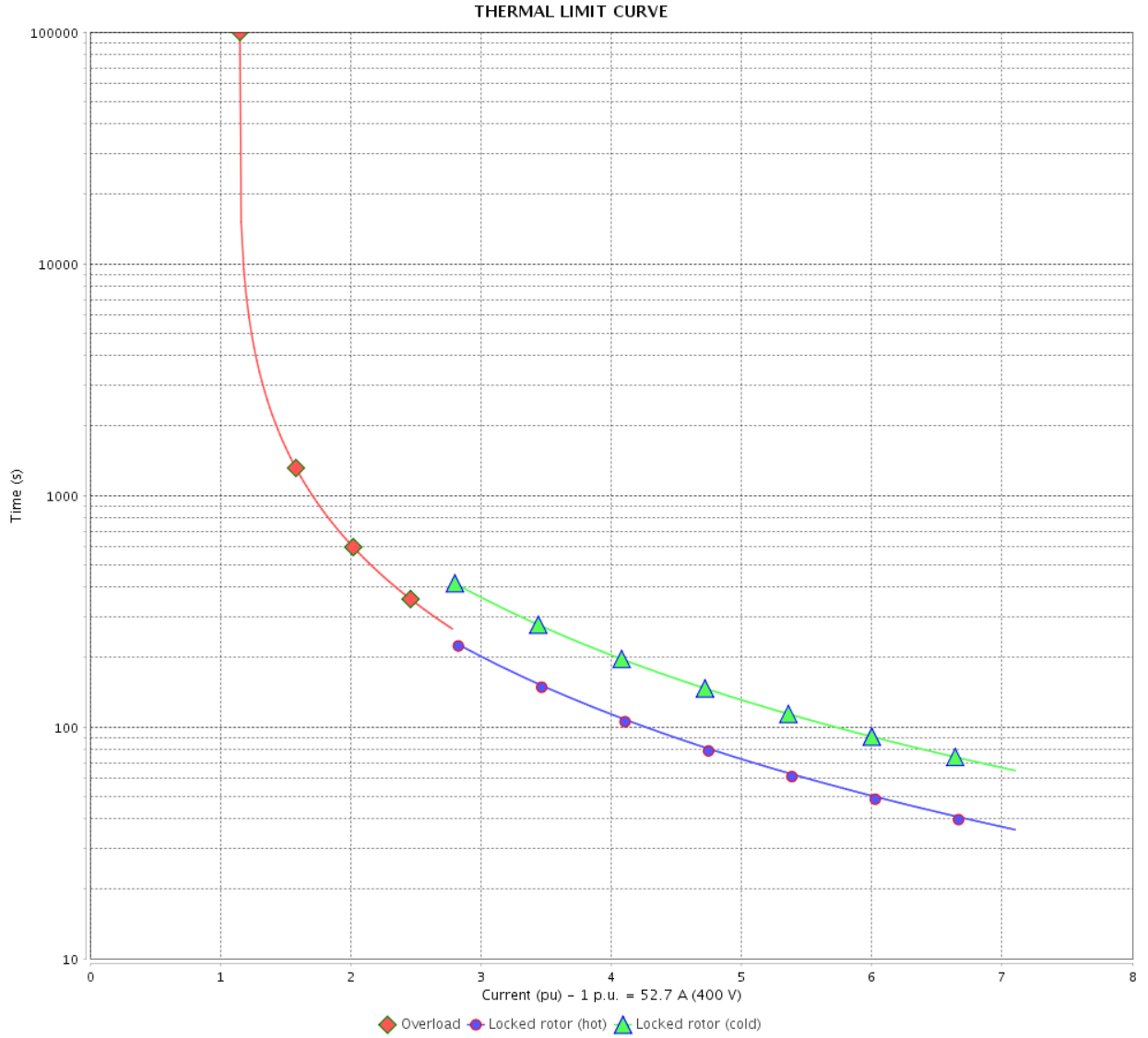

Rev.	Changes Summary	Performed	Checked	Date
Performed by		Page 21 / 36		Revision
Checked by				
Date				

THERMAL LIMIT CURVE



Three Phase Induction Motor - Squirrel Cage

Customer :

Product line : NEMA Premium Efficiency Three-Phase
Product code : 11431306
Catalog # : 05036ST3QIE326TS-W22

Performance : 415 V 50 Hz 2P IE3

Rated current	: 51.4 A	Moment of inertia (J)	: 5.75 sq.ft.lb
LRC	: 7.2	Duty cycle	: Cont.(S1)
Rated torque	: 70.8 ft.lb	Insulation class	: F
Locked rotor torque	: 280 %	Service factor	: 1.00
Breakdown torque	: 280 %	Temperature rise	: 80 K
Rated speed	: 2965 rpm	Design	: B

Heating constant

Cooling constant

Rev.	Changes Summary	Performed	Checked	Date
Performed by				
Checked by			Page	Revision
Date	12/04/2022		22 / 36	

THERMAL LIMIT CURVE

Three Phase Induction Motor - Squirrel Cage



Customer : _____

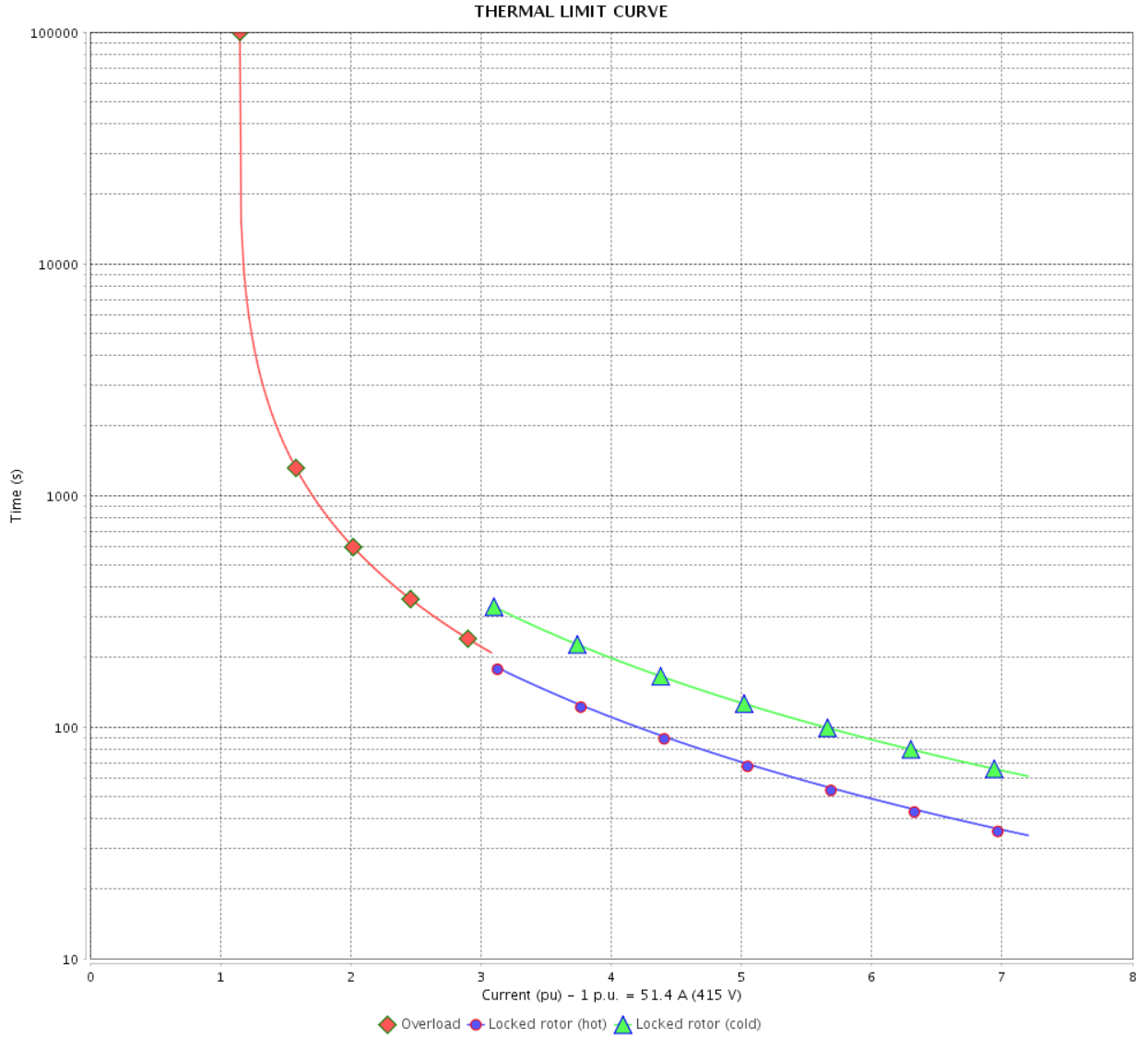

Rev.	Changes Summary	Performed	Checked	Date
Performed by		Page 23 / 36		Revision
Checked by				
Date				

THERMAL LIMIT CURVE

Three Phase Induction Motor - Squirrel Cage



Customer :

Product line : NEMA Premium Efficiency Three-Phase
Product code : 11431306
Catalog # : 05036ST3QIE326TS-W22

Performance : 380 V 50 Hz 2P

Rated current	: 69.4 A	Moment of inertia (J)	: 5.75 sq.ft.lb
LRC	: 5.2	Duty cycle	: Cont.(S1)
Rated torque	: 89.5 ft.lb	Insulation class	: F
Locked rotor torque	: 190 %	Service factor	: 1.00
Breakdown torque	: 200 %	Temperature rise	: 105 K
Rated speed	: 2935 rpm	Design	: B

Heating constant

Cooling constant

Rev.	Changes Summary	Performed	Checked	Date
Performed by				
Checked by			Page	Revision
Date	12/04/2022		24 / 36	

THERMAL LIMIT CURVE

Three Phase Induction Motor - Squirrel Cage



Customer : _____

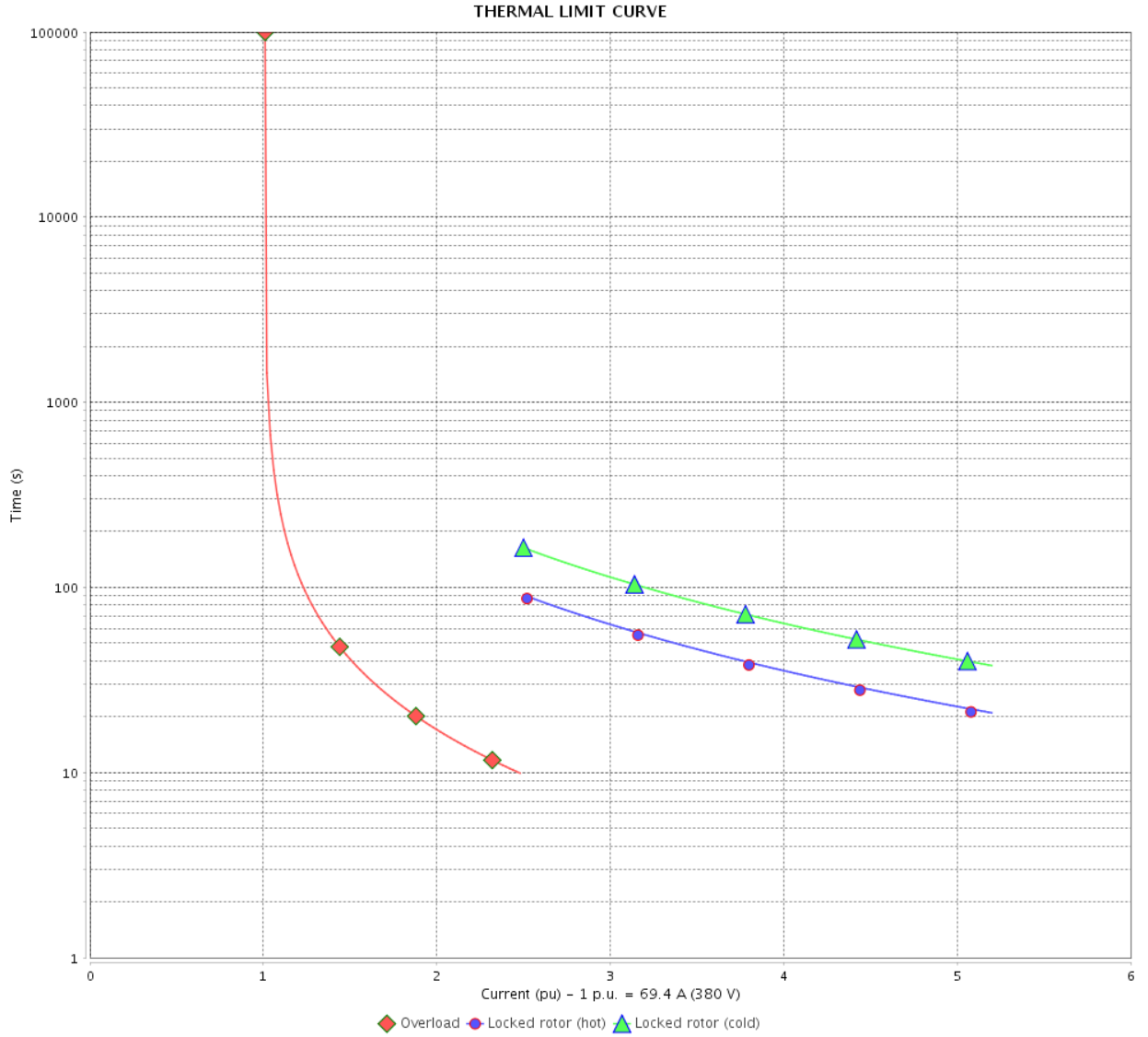

Rev.	Changes Summary	Performed	Checked	Date
Performed by		Page		Revision
Checked by				
Date				

THERMAL LIMIT CURVE



Three Phase Induction Motor - Squirrel Cage

Customer :

Product line : NEMA Premium Efficiency Three-Phase
 Product code : 11431306
 Catalog # : 05036ST3QIE326TS-W22

Performance : 400 V 50 Hz 2P IE1

Rated current : 65.4 A	Moment of inertia (J) : 5.75 sq.ft.lb
LRC : 5.6	Duty cycle : Cont.(S1)
Rated torque : 89.2 ft.lb	Insulation class : F
Locked rotor torque : 210 %	Service factor : 1.00
Breakdown torque : 200 %	Temperature rise : 105 K
Rated speed : 2945 rpm	Design : B

Heating constant

Cooling constant

Rev.	Changes Summary	Performed	Checked	Date
Performed by			Page	Revision
Checked by				
Date				

THERMAL LIMIT CURVE

Three Phase Induction Motor - Squirrel Cage



Customer : _____

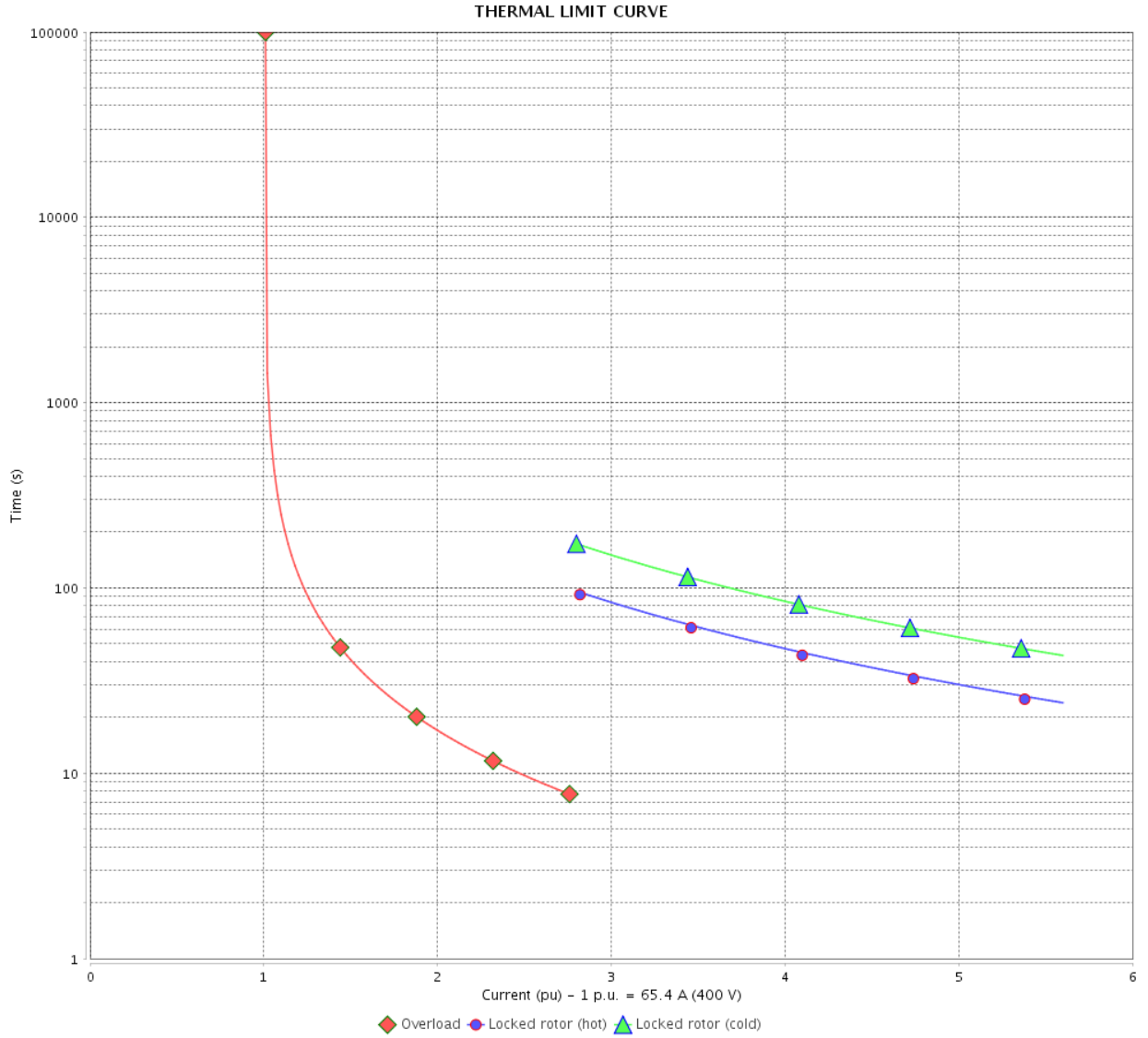

Rev.	Changes Summary	Performed	Checked	Date
Performed by		Page		Revision
Checked by		27 / 36		
Date		12/04/2022		

THERMAL LIMIT CURVE



Three Phase Induction Motor - Squirrel Cage

Customer :

Product line : NEMA Premium Efficiency Three-Phase
Product code : 11431306
Catalog # : 05036ST3QIE326TS-W22

Performance : 415 V 50 Hz 2P IE1

Rated current	: 63.3 A	Moment of inertia (J)	: 5.75 sq.ft.lb
LRC	: 6.2	Duty cycle	: Cont.(S1)
Rated torque	: 89.0 ft.lb	Insulation class	: F
Locked rotor torque	: 229 %	Service factor	: 1.00
Breakdown torque	: 220 %	Temperature rise	: 105 K
Rated speed	: 2950 rpm	Design	: B

Heating constant

Cooling constant

Rev.	Changes Summary	Performed	Checked	Date
Performed by				
Checked by			Page	Revision
Date	12/04/2022		28 / 36	

THERMAL LIMIT CURVE

Three Phase Induction Motor - Squirrel Cage



Customer : _____

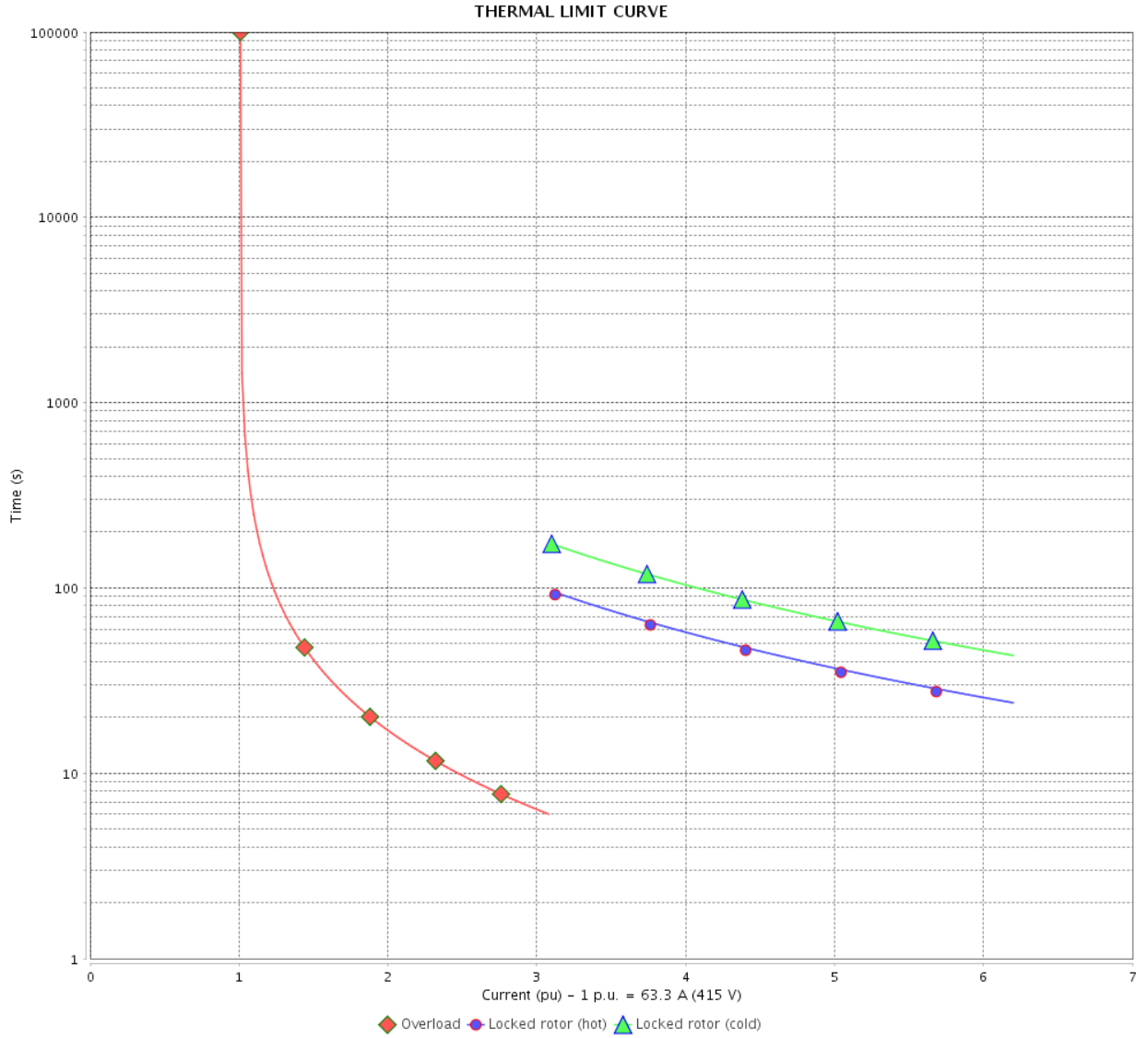

Rev.	Changes Summary	Performed	Checked	Date
Performed by		Page		Revision
Checked by		29 / 36		
Date		12/04/2022		

VFD OPERATION CURVE

Three Phase Induction Motor - Squirrel Cage



Customer :

Product line : NEMA Premium Efficiency Three-Phase

Product code : 11431306

Catalog # : 05036ST3QIE326TS-W22

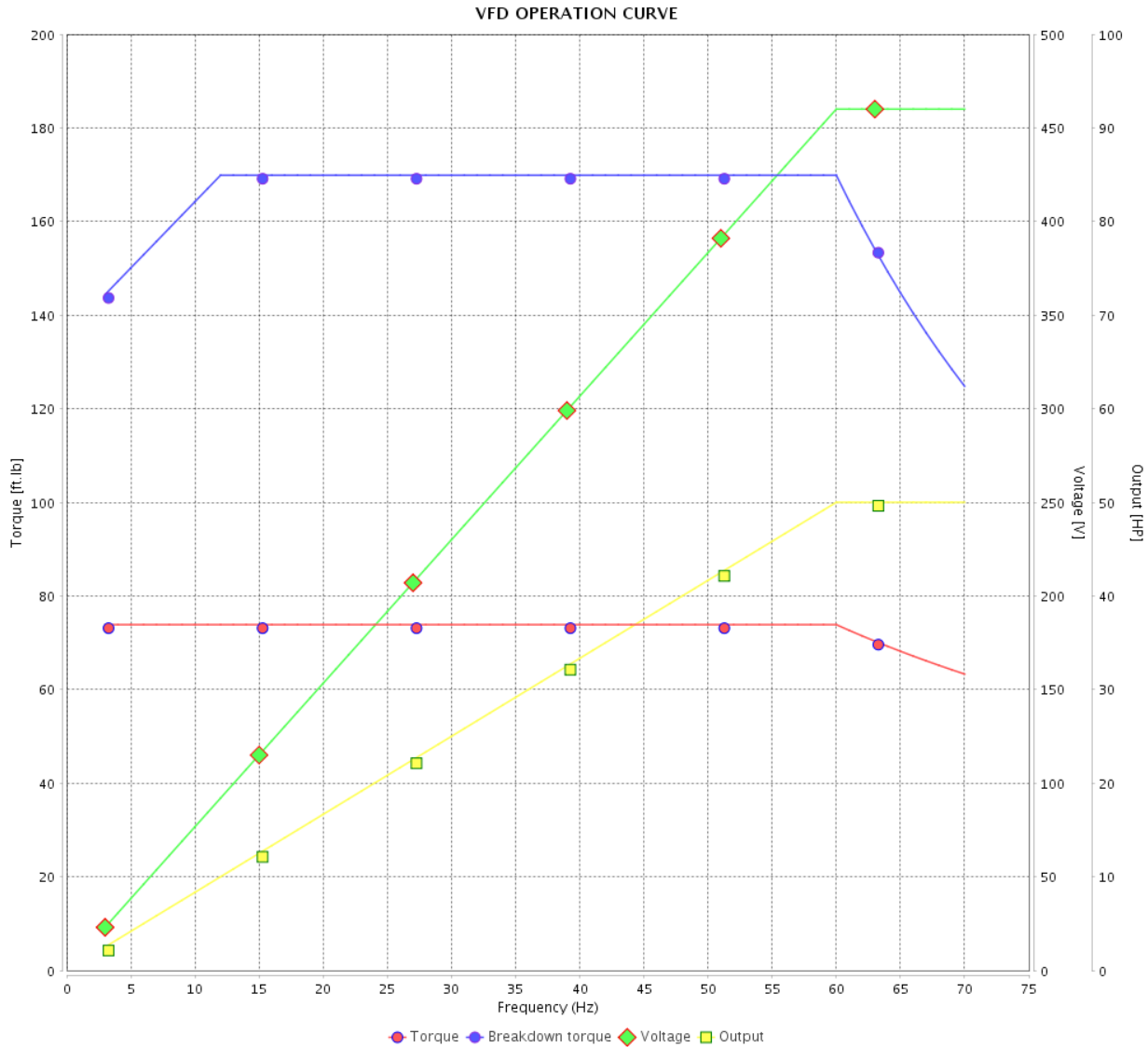

Performance : 460 V 60 Hz 2P

Rated current : 56.7 A
 LRC : 6.3
 Rated torque : 73.9 ft.lb
 Locked rotor torque : 240 %
 Breakdown torque : 229 %
 Rated speed : 3555 rpm

Moment of inertia (J) : 5.75 sq.ft.lb
 Duty cycle : Cont.(S1)
 Insulation class : F
 Service factor : 1.25
 Temperature rise : 80 K
 Design : B

Rev.	Changes Summary	Performed	Checked	Date
Performed by			Page	Revision
Checked by				
Date				

VFD OPERATION CURVE

Three Phase Induction Motor - Squirrel Cage



Customer :

Product line : NEMA Premium Efficiency Three-Phase

Product code : 11431306

Catalog # : 05036ST3QIE326TS-W22

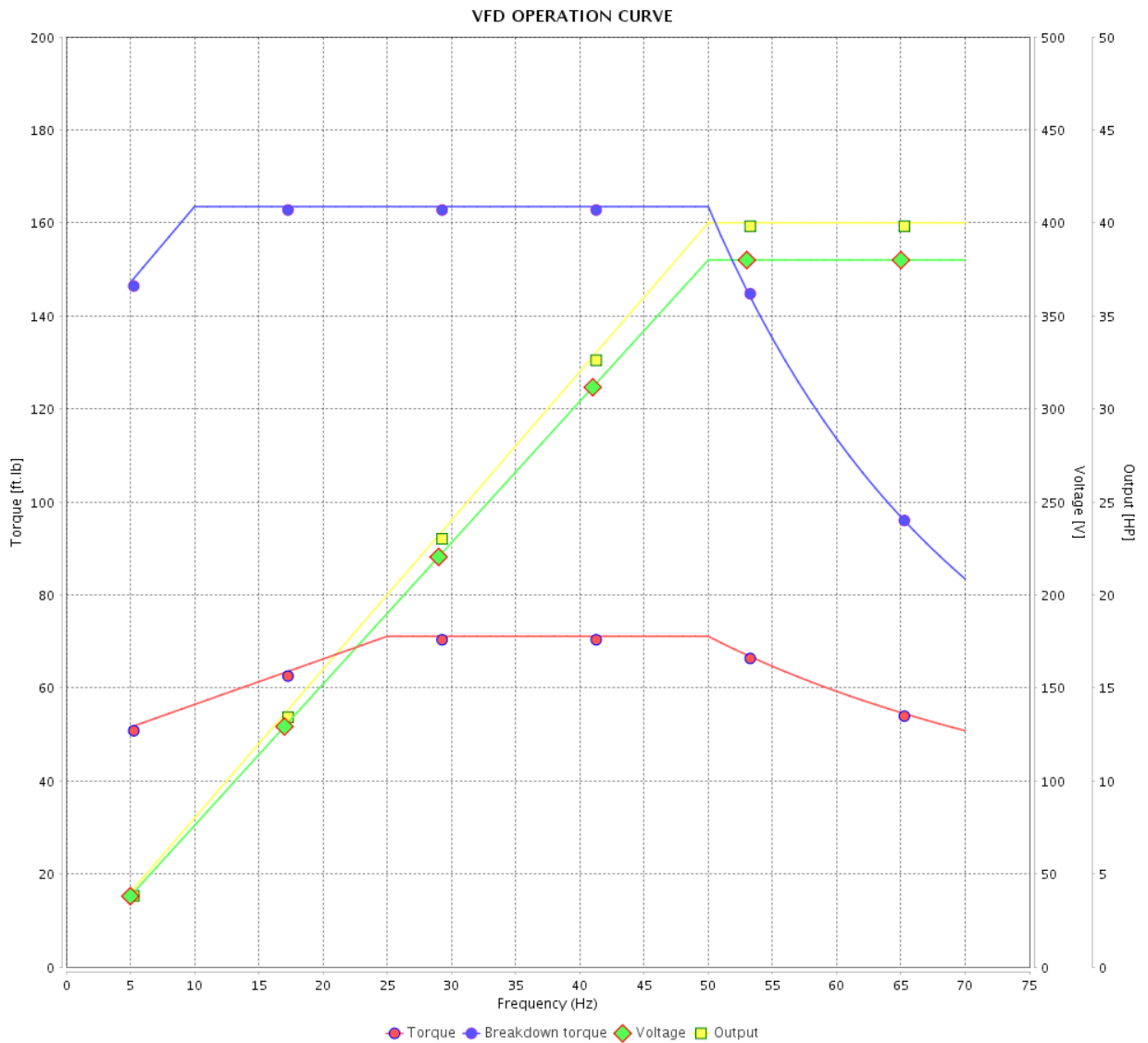

Performance : 380 V 50 Hz 2P IE3

Rated current : 54.9 A
 LRC : 6.6
 Rated torque : 71.1 ft.lb
 Locked rotor torque : 240 %
 Breakdown torque : 229 %
 Rated speed : 2955 rpm

Moment of inertia (J) : 5.75 sq.ft.lb
 Duty cycle : Cont.(S1)
 Insulation class : F
 Service factor : 1.00
 Temperature rise : 80 K
 Design : B

Rev.	Changes Summary	Performed	Checked	Date
Performed by		Page		Revision
Checked by		31 / 36		
Date	12/04/2022			

VFD OPERATION CURVE

Three Phase Induction Motor - Squirrel Cage



Customer :

Product line : NEMA Premium Efficiency Three-Phase

Product code : 11431306

Catalog # : 05036ST3QIE326TS-W22

VFD OPERATION CURVE

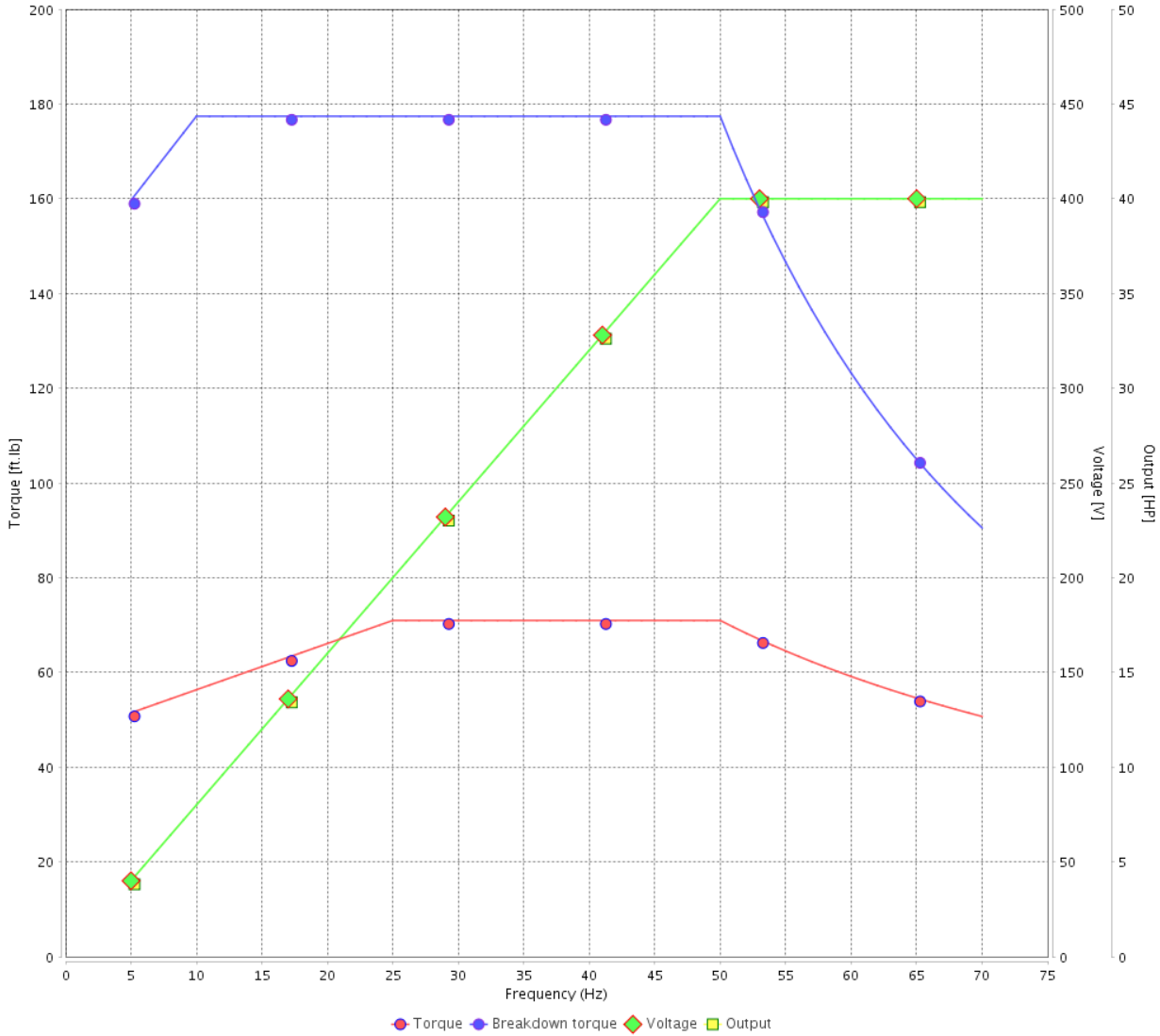

Performance : 400 V 50 Hz 2P IE3

Rated current : 52.7 A
 LRC : 7.1
 Rated torque : 71.0 ft.lb
 Locked rotor torque : 260 %
 Breakdown torque : 250 %
 Rated speed : 2960 rpm

Moment of inertia (J) : 5.75 sq.ft.lb
 Duty cycle : Cont.(S1)
 Insulation class : F
 Service factor : 1.00
 Temperature rise : 80 K
 Design : B

Rev.	Changes Summary	Performed	Checked	Date
Performed by			Page	Revision
Checked by				
Date				
			32 / 36	

VFD OPERATION CURVE

Three Phase Induction Motor - Squirrel Cage



Customer :

Product line : NEMA Premium Efficiency Three-Phase

Product code : 11431306

Catalog # : 05036ST3QIE326TS-W22

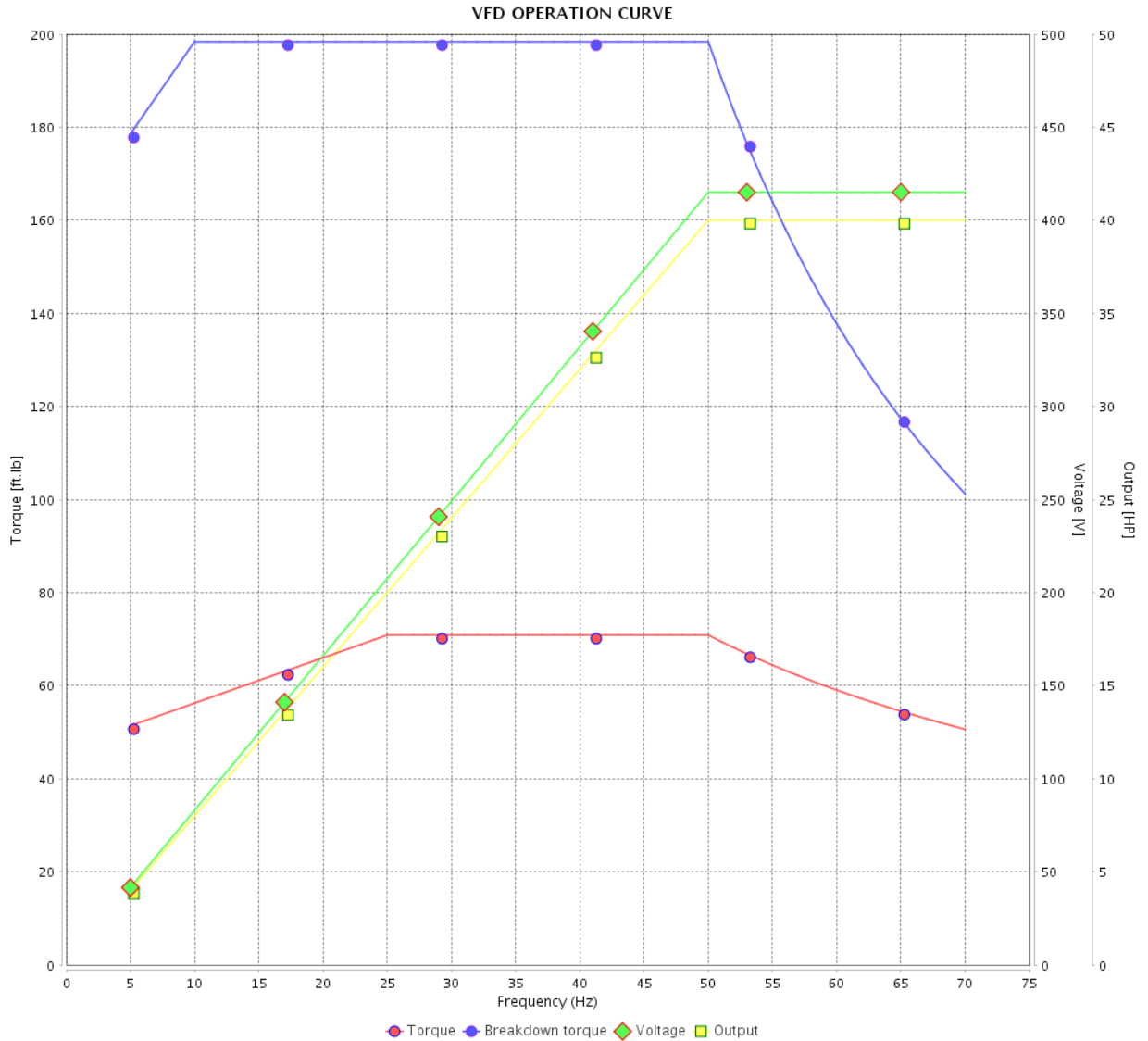

Performance : 415 V 50 Hz 2P IE3

Rated current : 51.4 A
 LRC : 7.2
 Rated torque : 70.8 ft.lb
 Locked rotor torque : 280 %
 Breakdown torque : 280 %
 Rated speed : 2965 rpm

Moment of inertia (J) : 5.75 sq.ft.lb
 Duty cycle : Cont.(S1)
 Insulation class : F
 Service factor : 1.00
 Temperature rise : 80 K
 Design : B

Rev.	Changes Summary	Performed	Checked	Date
Performed by			Page	Revision
Checked by			33 / 36	
Date	12/04/2022			

VFD OPERATION CURVE

Three Phase Induction Motor - Squirrel Cage



Customer :

Product line : NEMA Premium Efficiency Three-Phase

Product code : 11431306

Catalog # : 05036ST3QIE326TS-W22

VFD OPERATION CURVE

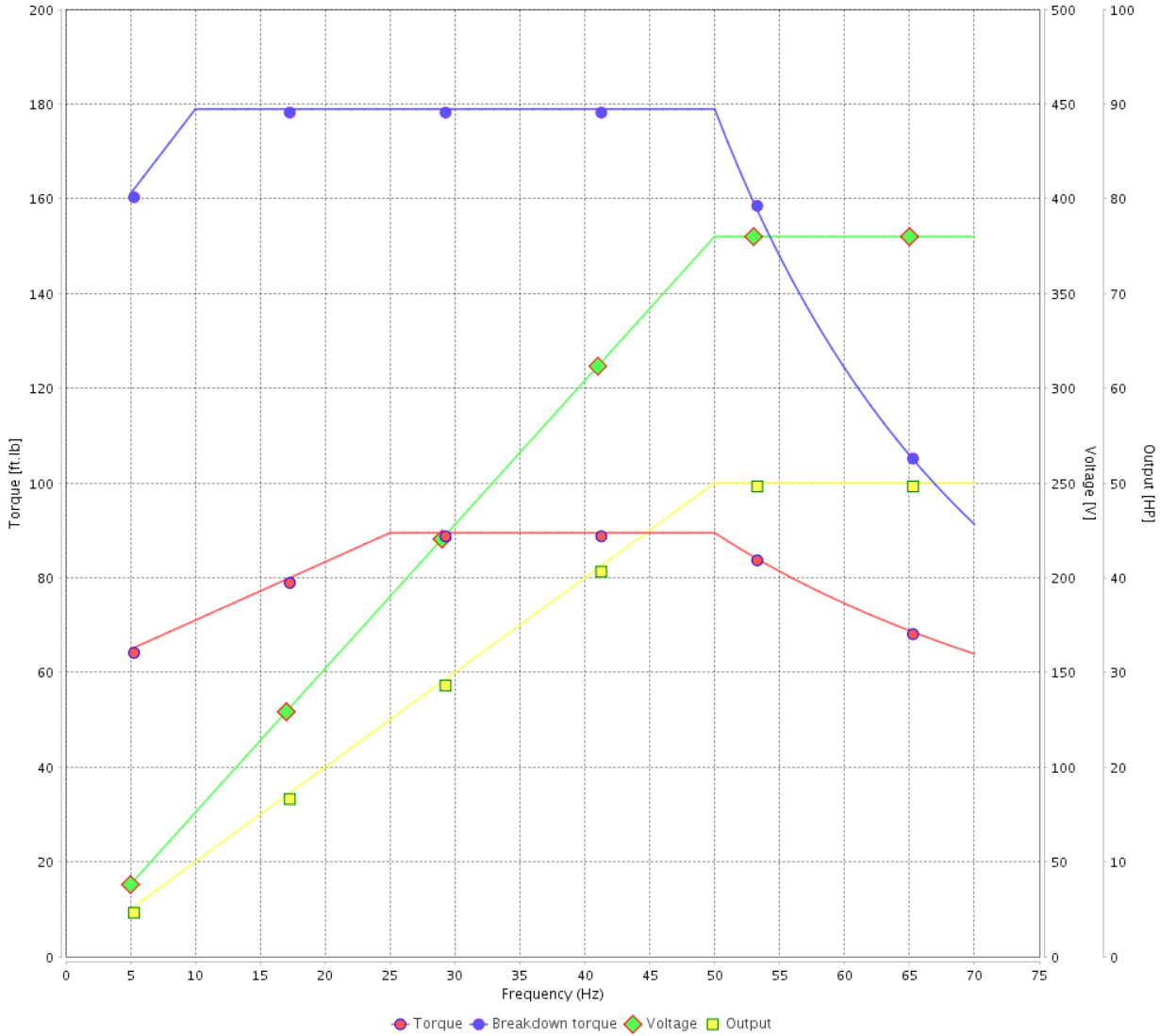

Performance : 380 V 50 Hz 2P

Rated current : 69.4 A
 LRC : 5.2
 Rated torque : 89.5 ft.lb
 Locked rotor torque : 190 %
 Breakdown torque : 200 %
 Rated speed : 2935 rpm

Moment of inertia (J) : 5.75 sq.ft.lb
 Duty cycle : Cont.(S1)
 Insulation class : F
 Service factor : 1.00
 Temperature rise : 105 K
 Design : B

Rev.	Changes Summary	Performed	Checked	Date
Performed by			Page	Revision
Checked by				
Date				
			34 / 36	

VFD OPERATION CURVE

Three Phase Induction Motor - Squirrel Cage



Customer : _____

Product line : NEMA Premium Efficiency Three-Phase Product code : 11431306
 Catalog # : 05036ST3QIE326TS-W22

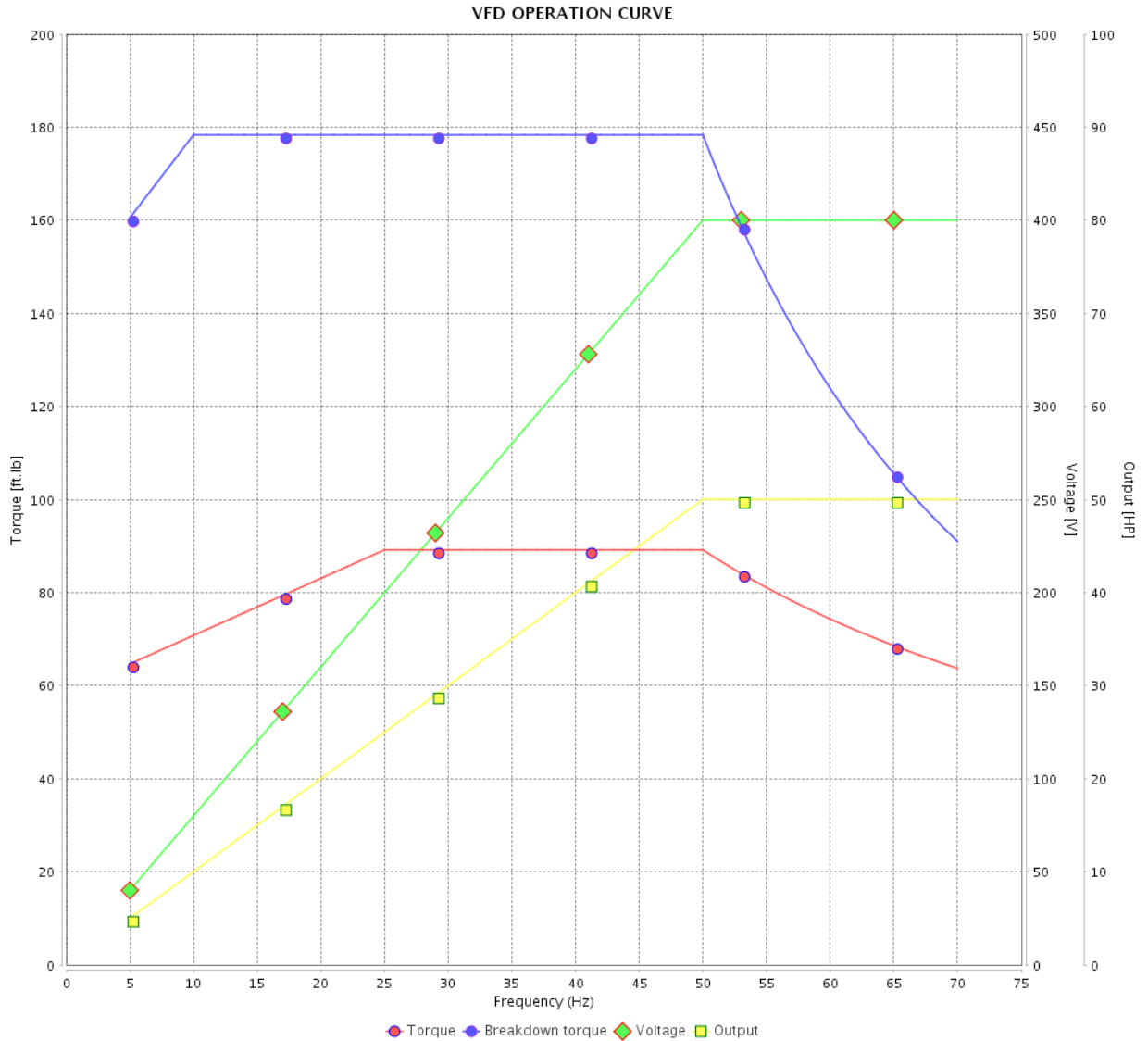

Performance : 400 V 50 Hz 2P IE1

Rated current	: 65.4 A	Moment of inertia (J)	: 5.75 sq.ft.lb
LRC	: 5.6	Duty cycle	: Cont.(S1)
Rated torque	: 89.2 ft.lb	Insulation class	: F
Locked rotor torque	: 210 %	Service factor	: 1.00
Breakdown torque	: 200 %	Temperature rise	: 105 K
Rated speed	: 2945 rpm	Design	: B

Rev.	Changes Summary	Performed	Checked	Date
Performed by		Page		Revision
Checked by		35 / 36		
Date	12/04/2022			

VFD OPERATION CURVE

Three Phase Induction Motor - Squirrel Cage



Customer :

Product line : NEMA Premium Efficiency Three-Phase

Product code : 11431306

Catalog # : 05036ST3QIE326TS-W22

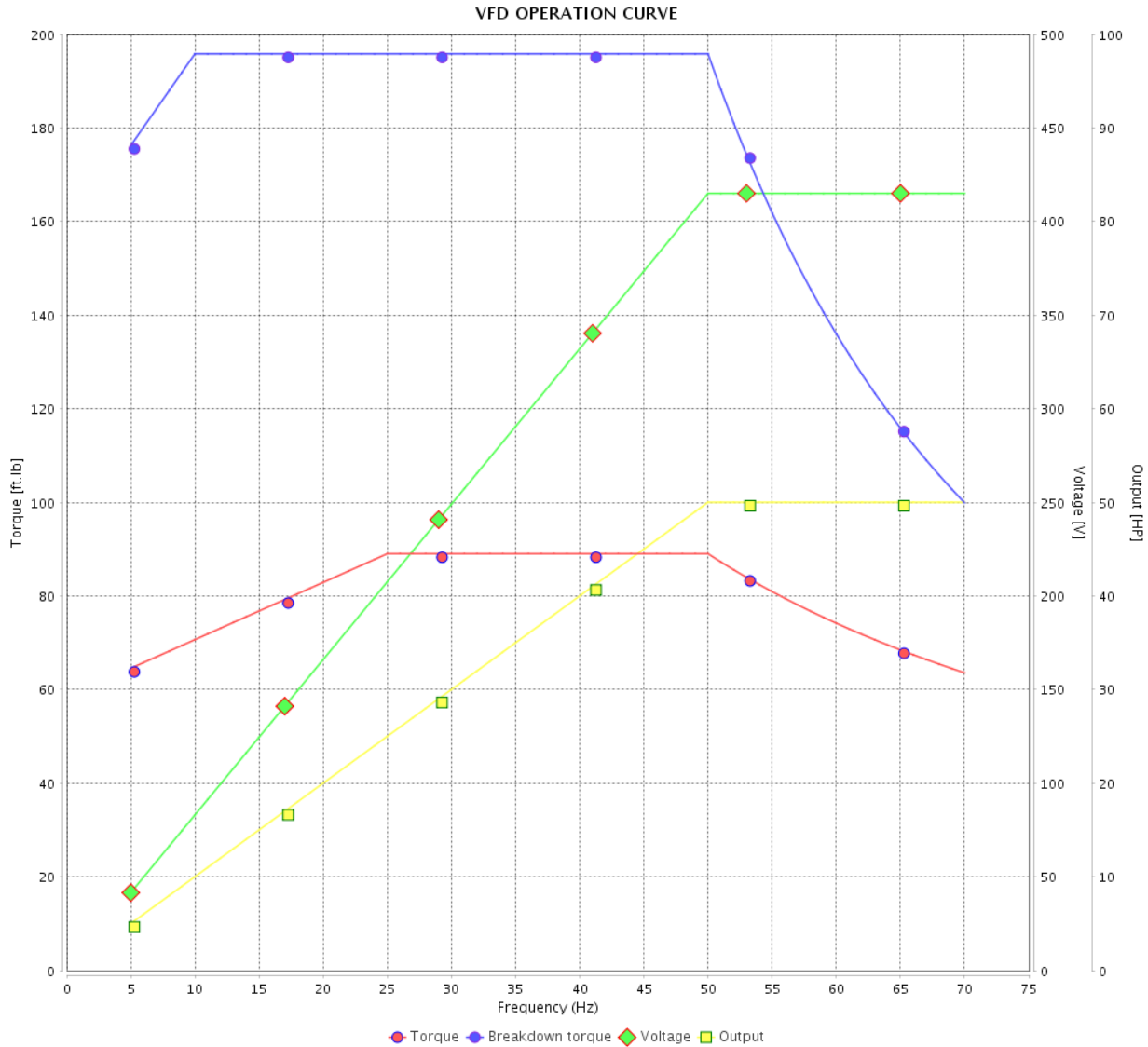

Performance : 415 V 50 Hz 2P IE1

Rated current	: 63.3 A	Moment of inertia (J)	: 5.75 sq.ft.lb
LRC	: 6.2	Duty cycle	: Cont.(S1)
Rated torque	: 89.0 ft.lb	Insulation class	: F
Locked rotor torque	: 229 %	Service factor	: 1.00
Breakdown torque	: 220 %	Temperature rise	: 105 K
Rated speed	: 2950 rpm	Design	: B

Rev.	Changes Summary	Performed	Checked	Date
Performed by		Page		Revision
Checked by		36 / 36		
Date	12/04/2022			

1 2 3 4 5 6

A

B

C

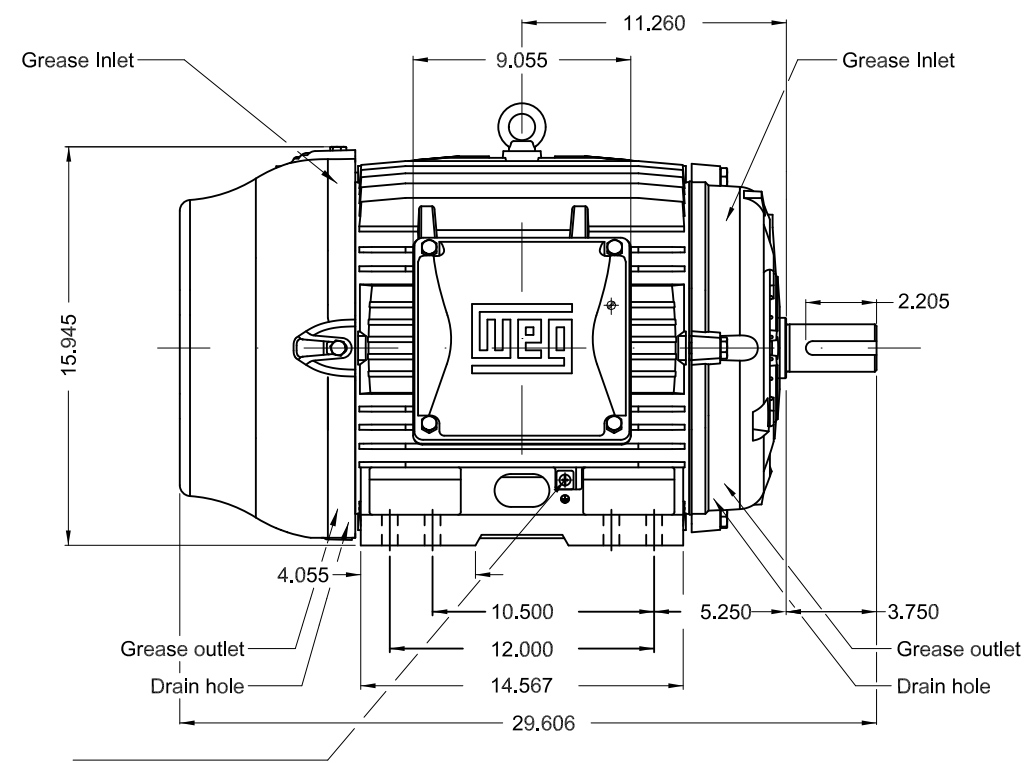
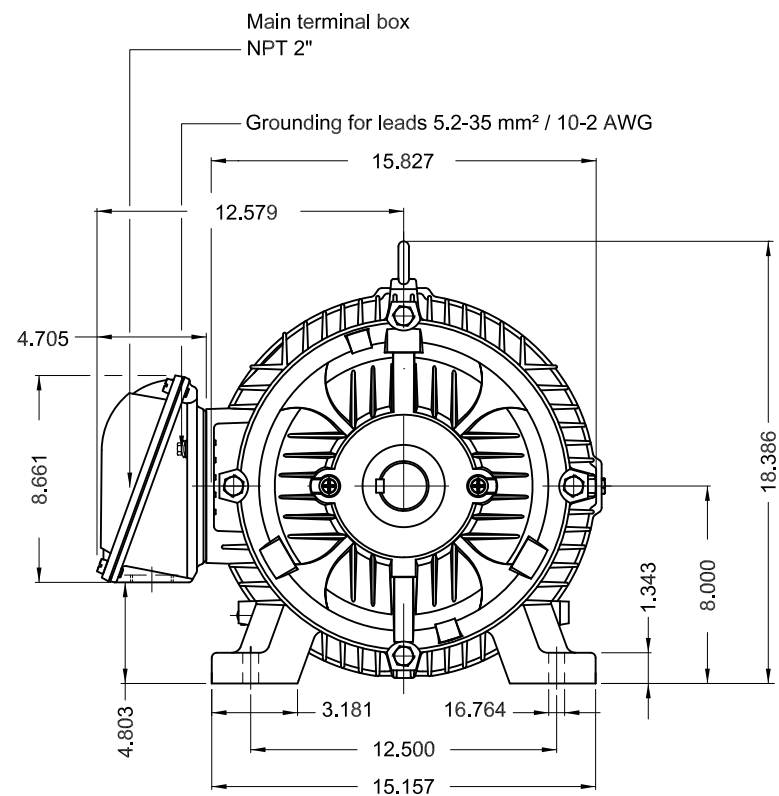

Grounding for leads 5.2-35 mm² / 10-2 AWG

D

E

Color RAL 5009
 Painting plan 202E
 Mounting NEMA F-1
 Mounting B3R(D)

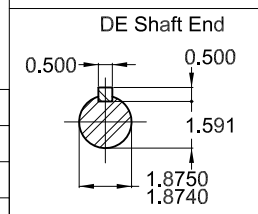

50 HP 02 Poles 60 Hz A

ECM	LOC	SUMMARY OF MODIFICATIONS	EXECUTED	CHECKED	RELEASED	DATE	VER
EXECUTED	PIRWBUSER	THREE PH. MOTOR IEEE 841 W22 PREM. EFF.					
CHECKED		FRAME 324/6TS IP55 TEFC					
RELEASED							
REL DT.	WMO	Jaragua do Sul	Product Engineering	SHEET	1 / 1		

PREVIEW
WDD





NEMA
Premium
W22



FOR SAFE AREA
Mod.TE1BFOXON
CC029A



Class I, Div 2, Gr A, B, C and D - T3
Class I, Zone 2, IIC - T3
Class II, Div 2, Gr F and G - T4
For use on PWM: Gr. A, B, C, D and F,
VT 1000:1, CT 20:1, 1.00SF - T3A

MODEL 05036ST3QIE326TS-W22



Inverter Duty Motor
Severe Duty

MADE IN BRAZIL
11431306

PH3 60Hz Fr. 324/6TS 1000m.a.s.l. IP55 TEFC 560lb

V 460

A 56.7

HP 50

kW 37

SF 1.25

SFA 70.9

RPM 3555

PF 0.88

AMB 40°C

INS cl. F DT80K

NEMA NOM EFF 93.0%

DUTY CONT.

DES B Code G

GUARANT. EFF 91.7%

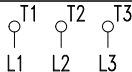

460V



→ 6312-C3 (21g) 60BC03X30

→ 6212-C3 (13g) 60BC02X30



MOBIL POLYREX EM (12000h)

