

# DATA SHEET

## Three Phase Induction Motor - Squirrel Cage



Customer :					
Product line	: W40 JM Pump NEMA Premium Efficiency Three-Phase	Product code :	14484972		
		Catalog # :	06036OT3E326JM-W40		
Frame	: 324/6JM	Cooling method	: IC01 - ODP		
Insulation class	: F	Mounting	: F-1		
Duty cycle	: Cont.(S1)	Rotation <sup>1</sup>	: Both (CW and CCW)		
Ambient temperature	: -20°C to +40°C	Starting method	: Direct On Line		
Altitude	: 1000 m.a.s.l.	Approx. weight <sup>2</sup>	: 488 lb		
Protection degree	: IP23	Moment of inertia (J)	: 3.82 sq.ft.lb		
Design	: B				
Output [HP]	60	50	50	50	
Poles	2	2	2	2	
Frequency [Hz]	60	50	50	50	
Rated voltage [V]	230/460	380	400	415	
Rated current [A]	142/71.0	69.8	68.7	69.5	
L. R. Amperes [A]	895/447	482	460	473	
LRC [A]	6.3x(Code G)	6.9x(Code H)	6.7x(Code H)	6.8x(Code H)	
No load current [A]	50.0/25.0	23.0	27.0	30.0	
Rated speed [RPM]	3560	2960	2960	2965	
Slip [%]	1.11	1.33	1.33	1.17	
Rated torque [ft.lb]	88.5	88.7	88.7	88.6	
Locked rotor torque [%]	220	220	240	260	
Breakdown torque [%]	229	229	250	270	
Service factor	1.25	1.00	1.00	1.00	
Temperature rise	80 K	80 K	80 K	80 K	
Locked rotor time	27s (cold) 15s (hot)	28s (cold) 16s (hot)	25s (cold) 14s (hot)	23s (cold) 13s (hot)	
Noise level <sup>2</sup>	75.0 dB(A)				
Efficiency (%)	25%	91.7	88.9	89.0	89.2
	50%	92.4	90.5	90.6	90.7
	75%	93.0	92.0	92.1	92.2
	100%	93.6	93.7	93.7	93.7
Power Factor	25%	0.48	0.50	0.43	0.38
	50%	0.73	0.73	0.67	0.60
	75%	0.82	0.82	0.77	0.72
	100%	0.85	0.86	0.83	0.79
Bearing type	: Drive end 6312 Z C3 Non drive end 6211 Z C3	Foundation loads			
Sealing	: Without Without Bearing Seal Bearing Seal	Max. traction Max. compression			
Lubrication interval	: 19658 h 20000 h				
Lubricant amount	: 21 g 11 g				
Lubricant type	: Mobil Polyrex EM				
Notes USABLE @208V 157A SF 1.15 SFA 181A					
This revision replaces and cancel the previous one, which must be eliminated. (1) Looking the motor from the shaft end. (2) Measured at 1m and with tolerance of +3dB(A). (3) Approximate weight subject to changes after manufacturing process. (4) At 100% of full load.			These are average values based on tests with sinusoidal power supply, subject to the tolerances stipulated in NEMA MG-1.		
Rev.	Changes Summary		Performed	Checked	Date
Performed by					
Checked by				Page	Revision
Date	13/04/2022			1 / 21	

# TORQUE AND CURRENT VS SPEED CURVE

Three Phase Induction Motor - Squirrel Cage



Customer :

Product line : W40 JM Pump NEMA Premium Efficiency Three-Phase

Product code : 14484972

Catalog # : 06036OT3E326JM-W40

TORQUE AND CURRENT VS SPEED CURVE

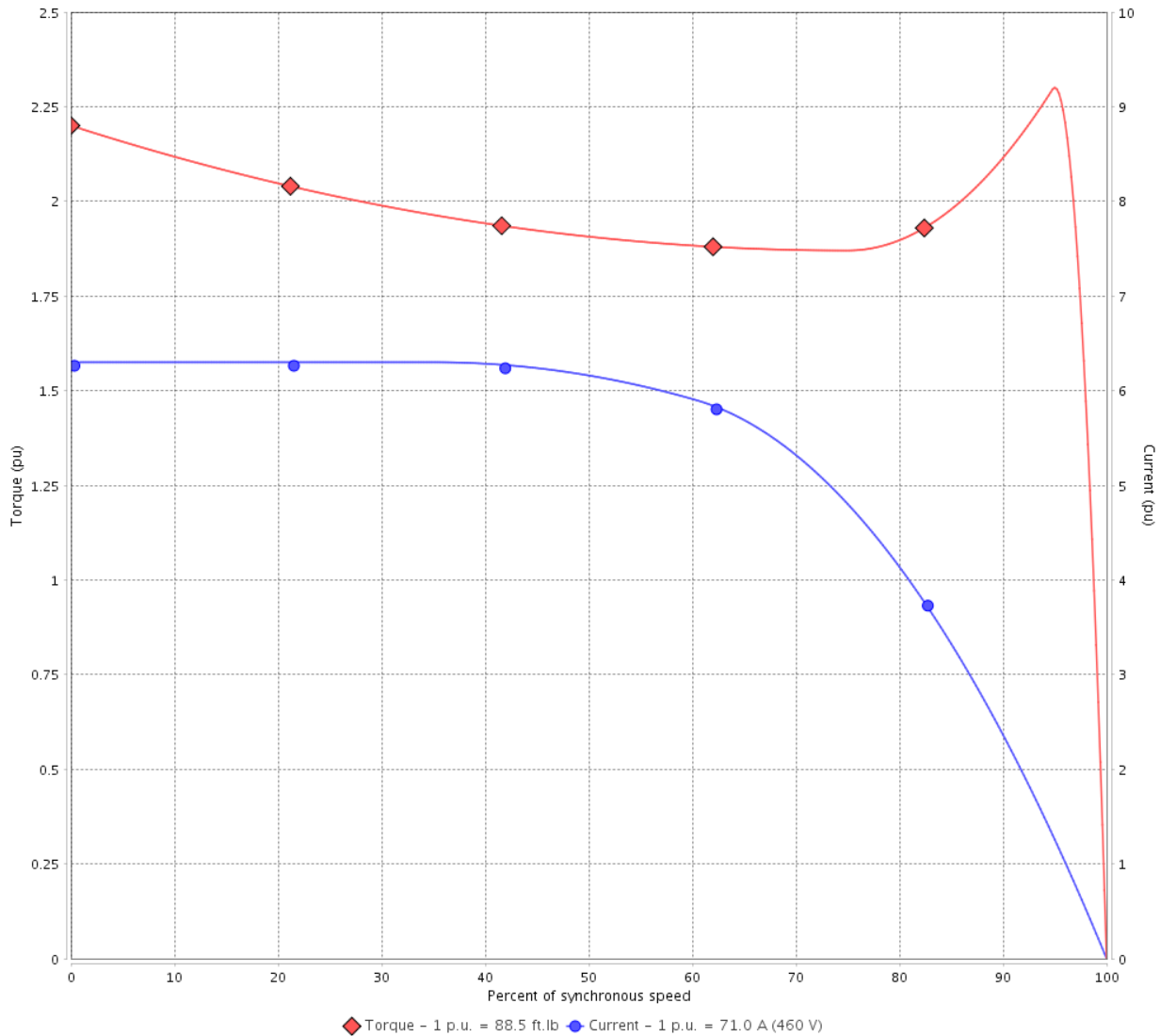

Performance : 230/460 V 60 Hz 2P

Rated current	: 142/71.0 A	Moment of inertia (J)	: 3.82 sq.ft.lb
LRC	: 6.3	Duty cycle	: Cont.(S1)
Rated torque	: 88.5 ft.lb	Insulation class	: F
Locked rotor torque	: 220 %	Service factor	: 1.25
Breakdown torque	: 229 %	Temperature rise	: 80 K
Rated speed	: 3560 rpm	Design	: B

Locked rotor time : 27s (cold) 15s (hot)

Rev.	Changes Summary	Performed	Checked	Date
Performed by			Page 2 / 21	Revision
Checked by				
Date	13/04/2022			

# TORQUE AND CURRENT VS SPEED CURVE



## Three Phase Induction Motor - Squirrel Cage

Customer :

Product line : W40 JM Pump NEMA Premium Efficiency Three-Phase

Product code : 14484972

Catalog # : 06036OT3E326JM-W40

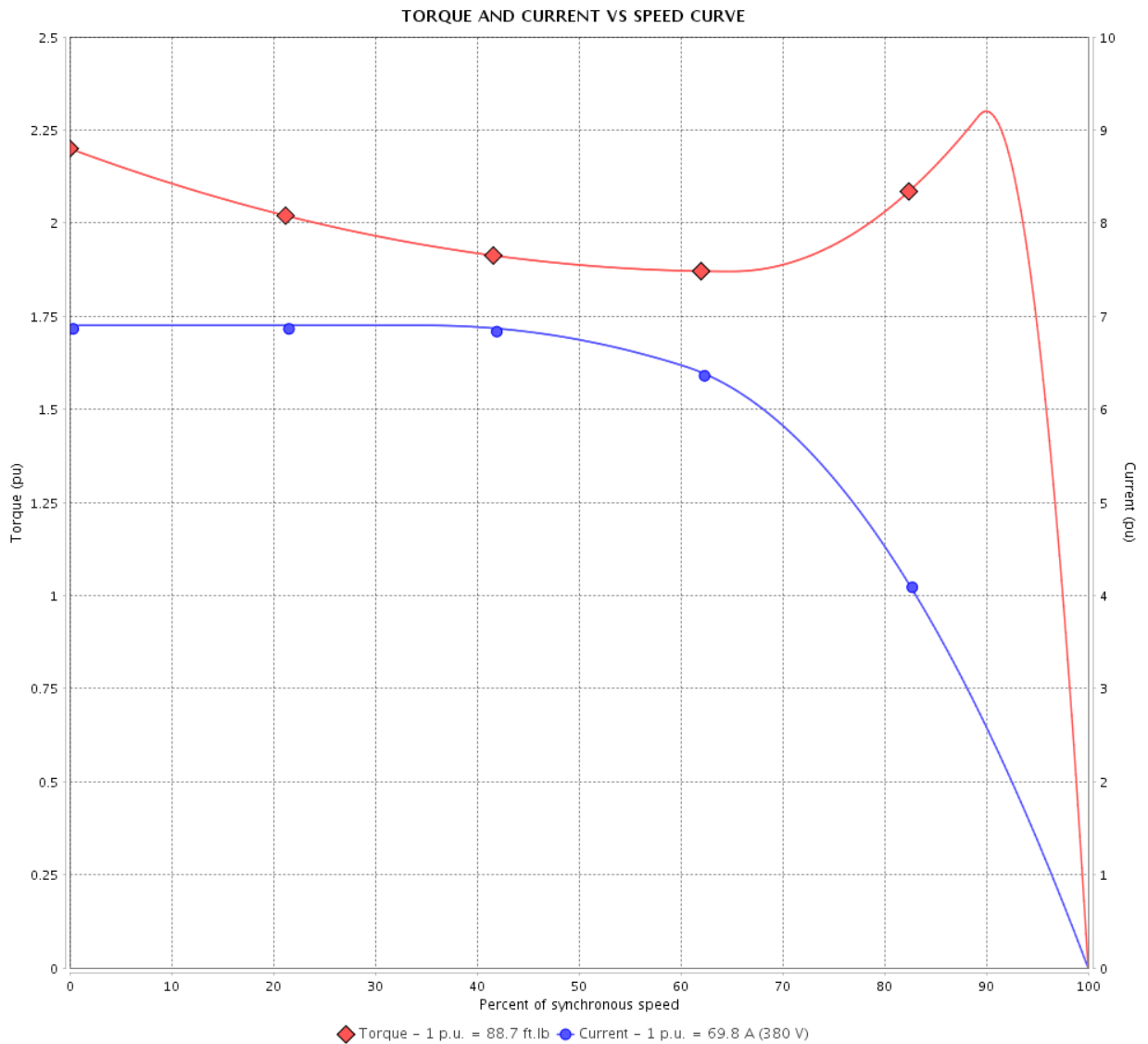

Performance : 380 V 50 Hz 2P IE3

Rated current : 69.8 A  
 LRC : 6.9  
 Rated torque : 88.7 ft.lb  
 Locked rotor torque : 220 %  
 Breakdown torque : 229 %  
 Rated speed : 2960 rpm

Moment of inertia (J) : 3.82 sq.ft.lb  
 Duty cycle : Cont.(S1)  
 Insulation class : F  
 Service factor : 1.00  
 Temperature rise : 80 K  
 Design : B

Locked rotor time : 28s (cold) 16s (hot)

Rev.	Changes Summary	Performed	Checked	Date
Performed by			Page 3 / 21	Revision
Checked by				
Date	13/04/2022			

# TORQUE AND CURRENT VS SPEED CURVE

## Three Phase Induction Motor - Squirrel Cage



Customer :

Product line : W40 JM Pump NEMA Premium Efficiency Three-Phase

Product code : 14484972

Catalog # : 06036OT3E326JM-W40

TORQUE AND CURRENT VS SPEED CURVE

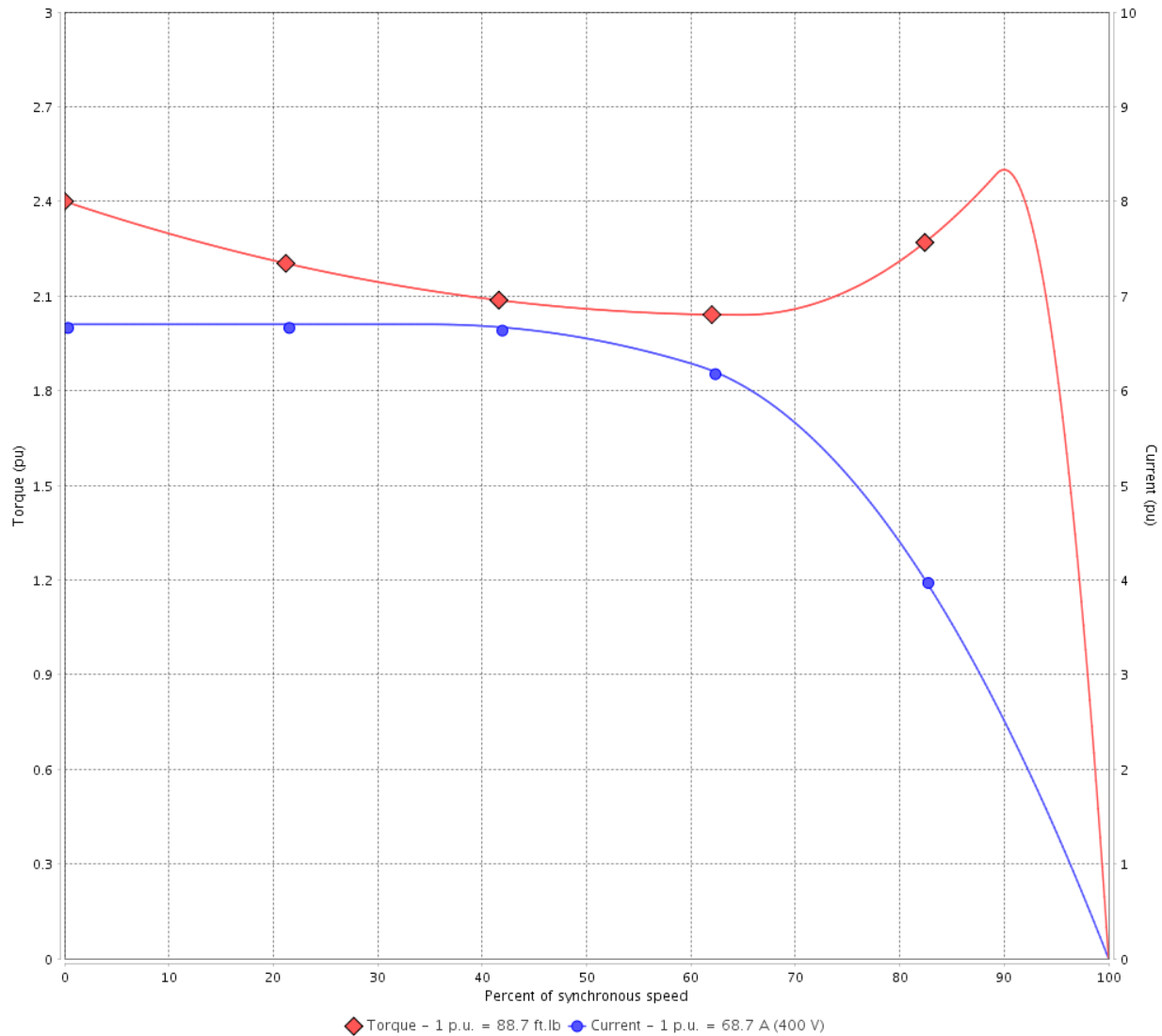

Performance : 400 V 50 Hz 2P IE3

Rated current	: 68.7 A	Moment of inertia (J)	: 3.82 sq.ft.lb
LRC	: 6.7	Duty cycle	: Cont.(S1)
Rated torque	: 88.7 ft.lb	Insulation class	: F
Locked rotor torque	: 240 %	Service factor	: 1.00
Breakdown torque	: 250 %	Temperature rise	: 80 K
Rated speed	: 2960 rpm	Design	: B

Locked rotor time : 25s (cold) 14s (hot)

Rev.	Changes Summary	Performed	Checked	Date
Performed by			Page 4 / 21	Revision
Checked by				
Date	13/04/2022			

# TORQUE AND CURRENT VS SPEED CURVE



## Three Phase Induction Motor - Squirrel Cage

Customer :

Product line : W40 JM Pump NEMA Premium Efficiency Three-Phase

Product code : 14484972

Catalog # : 06036OT3E326JM-W40

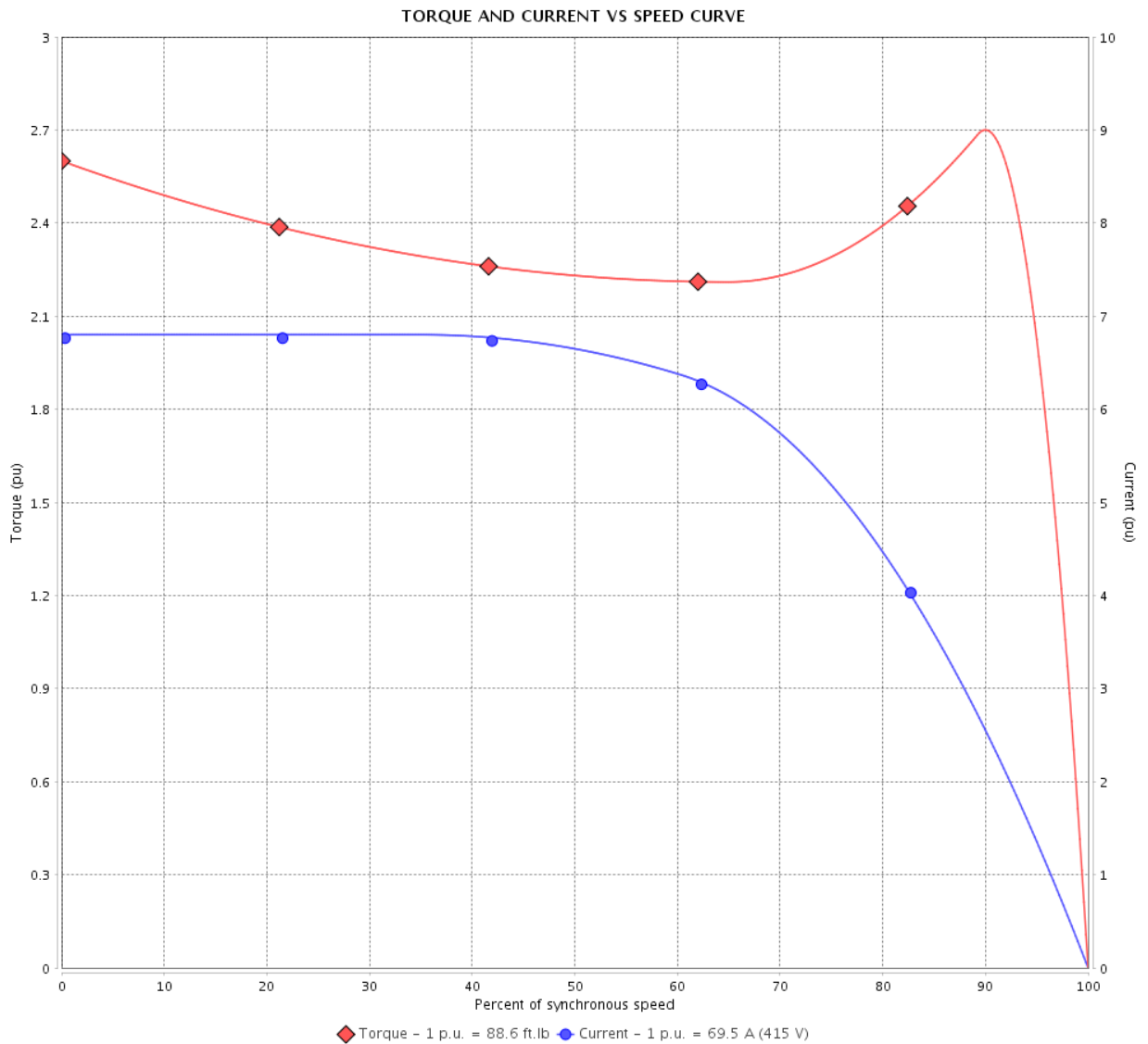

Performance : 415 V 50 Hz 2P IE3

Rated current	: 69.5 A	Moment of inertia (J)	: 3.82 sq.ft.lb
LRC	: 6.8	Duty cycle	: Cont.(S1)
Rated torque	: 88.6 ft.lb	Insulation class	: F
Locked rotor torque	: 260 %	Service factor	: 1.00
Breakdown torque	: 270 %	Temperature rise	: 80 K
Rated speed	: 2965 rpm	Design	: B

Locked rotor time : 23s (cold) 13s (hot)

Rev.	Changes Summary	Performed	Checked	Date
Performed by			Page 5 / 21	Revision
Checked by				
Date	13/04/2022			

# LOAD PERFORMANCE CURVE

Three Phase Induction Motor - Squirrel Cage



Customer :

Product line : W40 JM Pump NEMA Premium Efficiency Three-Phase

Product code : 14484972

Catalog # : 06036OT3E326JM-W40

LOAD PERFORMANCE CURVE

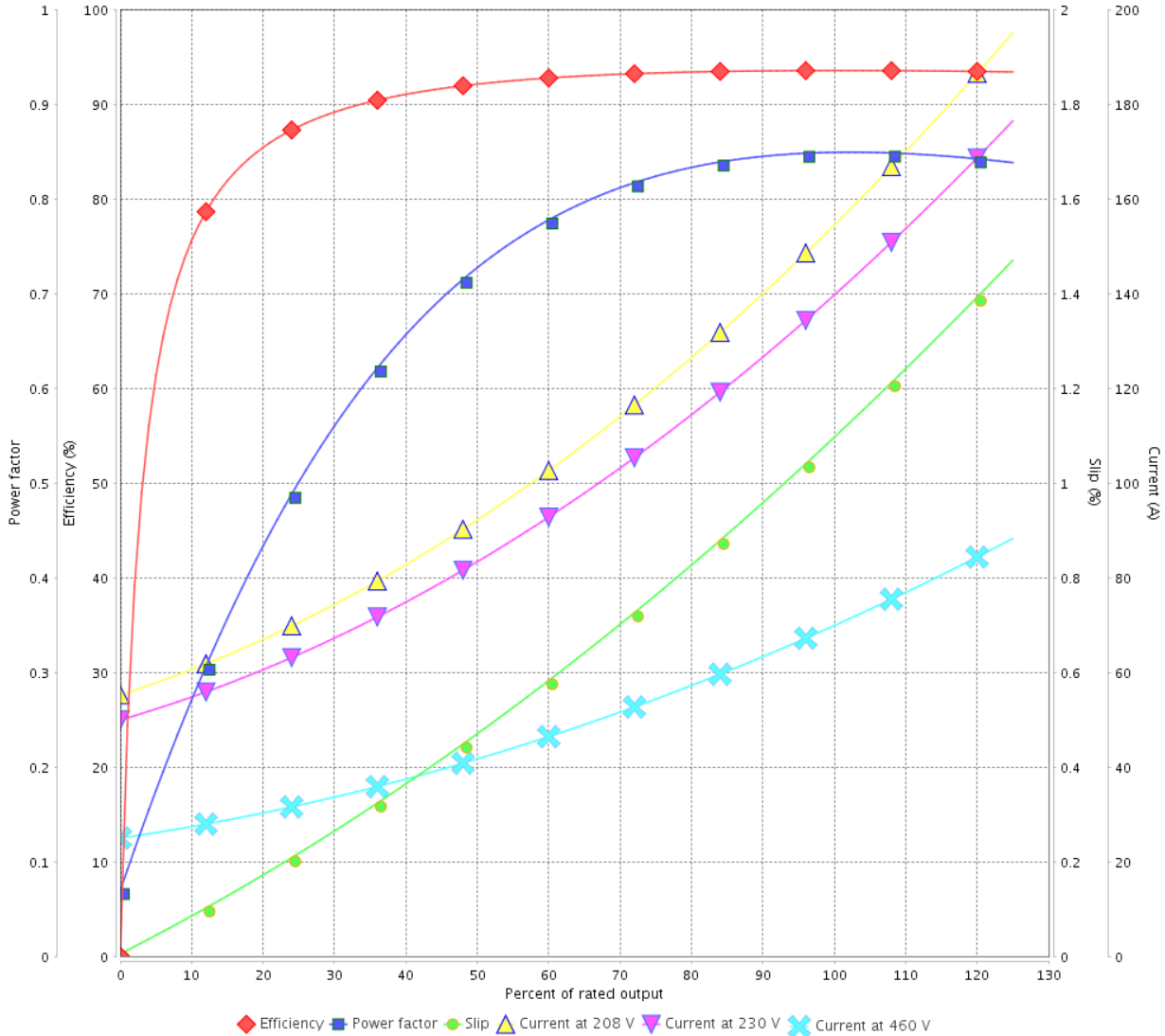

Performance : 230/460 V 60 Hz 2P

Rated current : 142/71.0 A  
 LRC : 6.3  
 Rated torque : 88.5 ft.lb  
 Locked rotor torque : 220 %  
 Breakdown torque : 229 %  
 Rated speed : 3560 rpm

Moment of inertia (J) : 3.82 sq.ft.lb  
 Duty cycle : Cont.(S1)  
 Insulation class : F  
 Service factor : 1.25  
 Temperature rise : 80 K  
 Design : B

Rev.	Changes Summary	Performed	Checked	Date
Performed by			Page 6 / 21	Revision
Checked by				
Date	13/04/2022			

# LOAD PERFORMANCE CURVE

## Three Phase Induction Motor - Squirrel Cage



Customer :

Product line : W40 JM Pump NEMA Premium Efficiency Three-Phase

Product code : 14484972

Catalog # : 06036OT3E326JM-W40

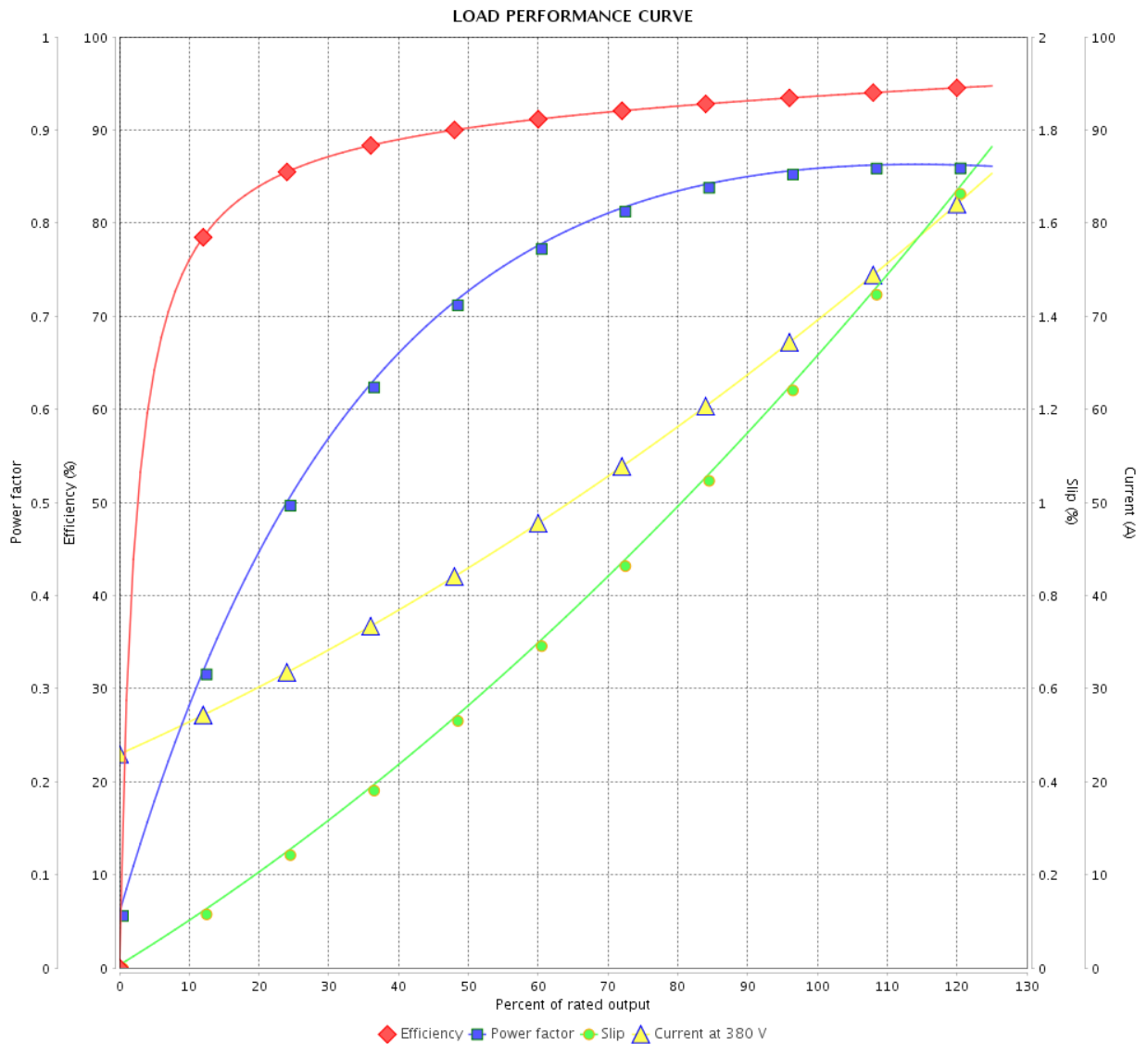

Performance : 380 V 50 Hz 2P IE3

Rated current : 69.8 A  
 LRC : 6.9  
 Rated torque : 88.7 ft.lb  
 Locked rotor torque : 220 %  
 Breakdown torque : 229 %  
 Rated speed : 2960 rpm

Moment of inertia (J) : 3.82 sq.ft.lb  
 Duty cycle : Cont.(S1)  
 Insulation class : F  
 Service factor : 1.00  
 Temperature rise : 80 K  
 Design : B

Rev.	Changes Summary	Performed	Checked	Date
Performed by			Page	Revision
Checked by				
Date				

# LOAD PERFORMANCE CURVE

Three Phase Induction Motor - Squirrel Cage



Customer :

Product line : W40 JM Pump NEMA Premium Efficiency Three-Phase

Product code : 14484972

Catalog # : 06036OT3E326JM-W40

LOAD PERFORMANCE CURVE

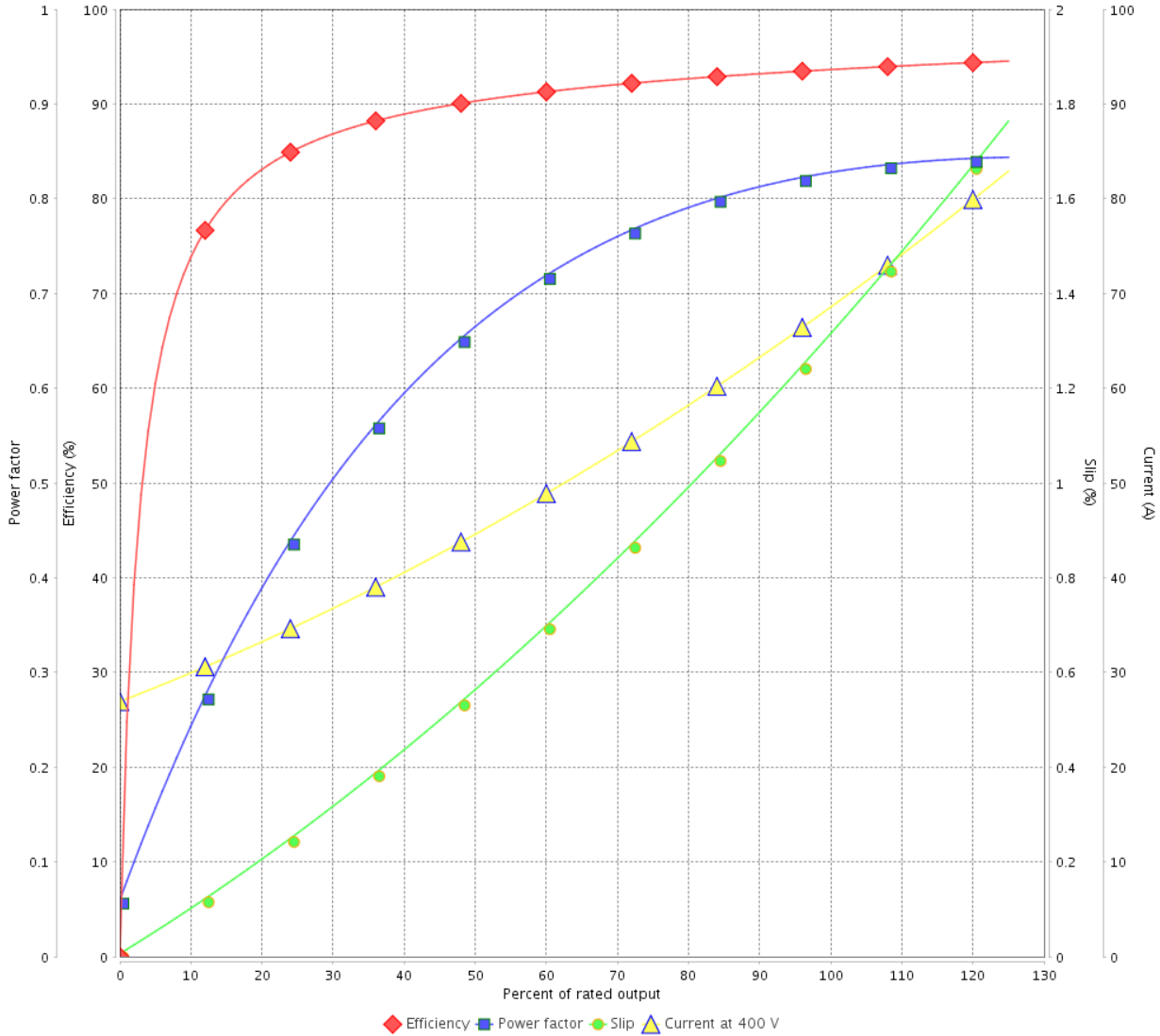

Performance : 400 V 50 Hz 2P IE3

Rated current : 68.7 A  
 LRC : 6.7  
 Rated torque : 88.7 ft.lb  
 Locked rotor torque : 240 %  
 Breakdown torque : 250 %  
 Rated speed : 2960 rpm

Moment of inertia (J) : 3.82 sq.ft.lb  
 Duty cycle : Cont.(S1)  
 Insulation class : F  
 Service factor : 1.00  
 Temperature rise : 80 K  
 Design : B

Rev.	Changes Summary	Performed	Checked	Date
Performed by			Page	Revision
Checked by			8 / 21	
Date	13/04/2022			



# LOAD PERFORMANCE CURVE

## Three Phase Induction Motor - Squirrel Cage



Customer :

Product line : W40 JM Pump NEMA Premium Efficiency Three-Phase

Product code : 14484972

Catalog # : 06036OT3E326JM-W40

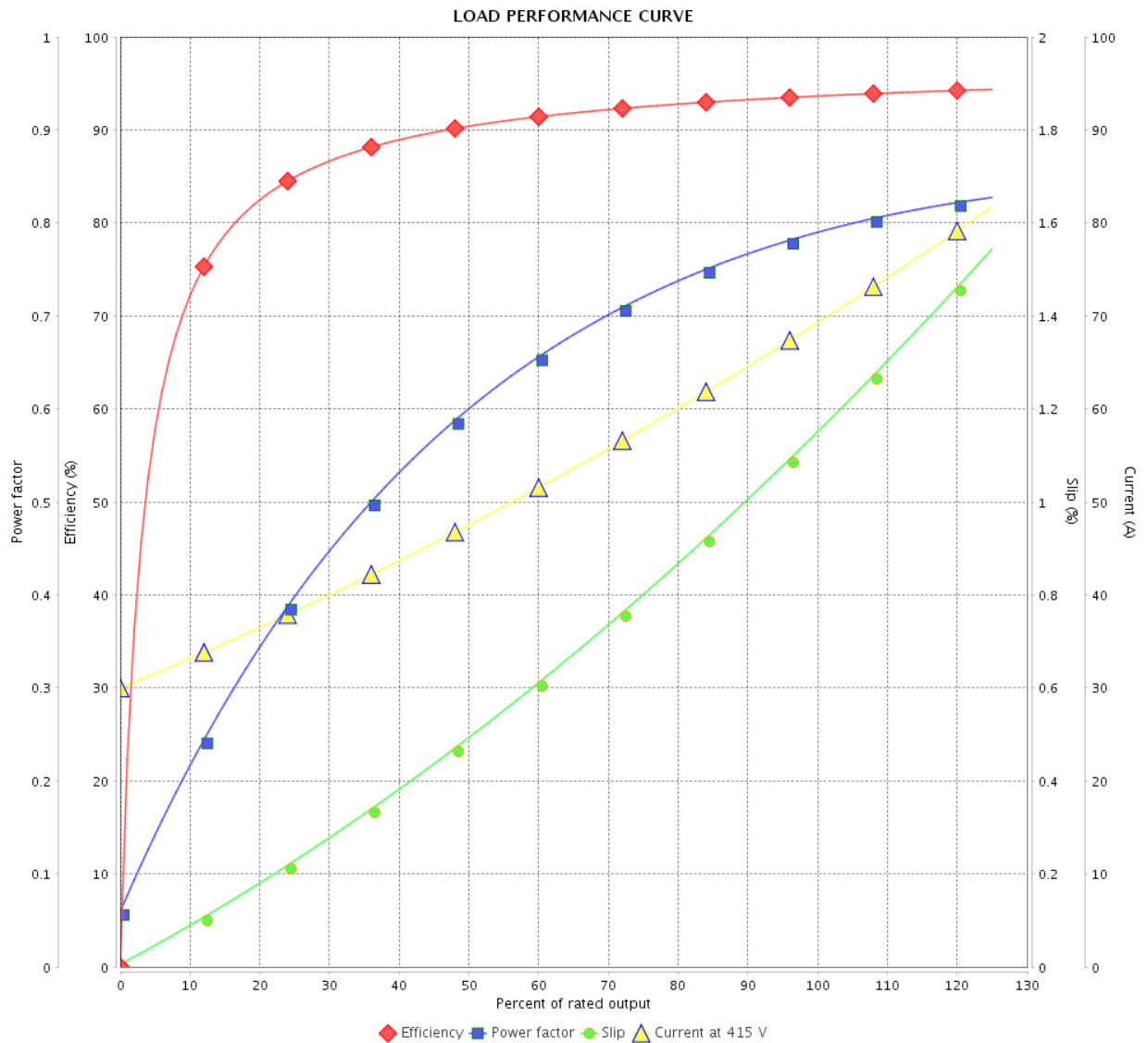

Performance : 415 V 50 Hz 2P IE3

Rated current : 69.5 A  
 LRC : 6.8  
 Rated torque : 88.6 ft.lb  
 Locked rotor torque : 260 %  
 Breakdown torque : 270 %  
 Rated speed : 2965 rpm

Moment of inertia (J) : 3.82 sq.ft.lb  
 Duty cycle : Cont.(S1)  
 Insulation class : F  
 Service factor : 1.00  
 Temperature rise : 80 K  
 Design : B

Rev.	Changes Summary	Performed	Checked	Date
Performed by		Page		Revision
Checked by		9 / 21		
Date		13/04/2022		

# THERMAL LIMIT CURVE



## Three Phase Induction Motor - Squirrel Cage

Customer :

Product line : W40 JM Pump NEMA Premium  
Efficiency Three-Phase

Product code : 14484972

Catalog # : 06036OT3E326JM-W40

Performance : 230/460 V 60 Hz 2P

Rated current : 142/71.0 A  
LRC : 6.3  
Rated torque : 88.5 ft.lb  
Locked rotor torque : 220 %  
Breakdown torque : 229 %  
Rated speed : 3560 rpm

Moment of inertia (J) : 3.82 sq.ft.lb  
Duty cycle : Cont.(S1)  
Insulation class : F  
Service factor : 1.25  
Temperature rise : 80 K  
Design : B

Heating constant

Cooling constant

Rev.	Changes Summary	Performed	Checked	Date
Performed by				
Checked by			Page	Revision
Date	13/04/2022		10 / 21	

# THERMAL LIMIT CURVE

Three Phase Induction Motor - Squirrel Cage



Customer : \_\_\_\_\_

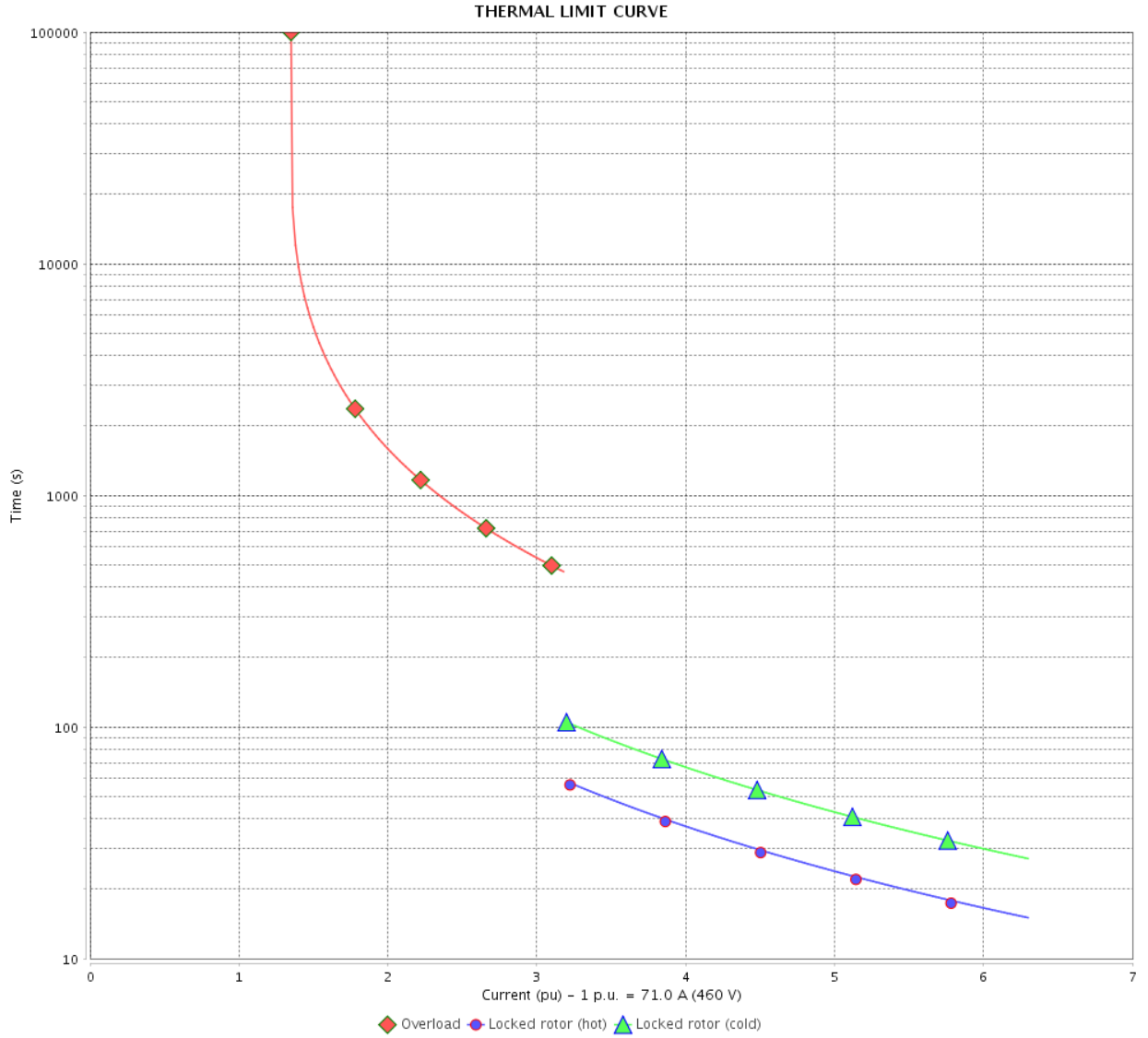

Rev.	Changes Summary	Performed	Checked	Date
Performed by		Page		Revision
Checked by		11 / 21		
Date		13/04/2022		

# THERMAL LIMIT CURVE



## Three Phase Induction Motor - Squirrel Cage

Customer :

Product line : W40 JM Pump NEMA Premium  
Efficiency Three-Phase

Product code : 14484972

Catalog # : 06036OT3E326JM-W40

Performance : 380 V 50 Hz 2P IE3

Rated current	: 69.8 A	Moment of inertia (J)	: 3.82 sq.ft.lb
LRC	: 6.9	Duty cycle	: Cont.(S1)
Rated torque	: 88.7 ft.lb	Insulation class	: F
Locked rotor torque	: 220 %	Service factor	: 1.00
Breakdown torque	: 229 %	Temperature rise	: 80 K
Rated speed	: 2960 rpm	Design	: B

Heating constant

Cooling constant

Rev.	Changes Summary	Performed	Checked	Date
Performed by				
Checked by			Page	Revision
Date	13/04/2022		12 / 21	

# THERMAL LIMIT CURVE

Three Phase Induction Motor - Squirrel Cage



Customer : \_\_\_\_\_

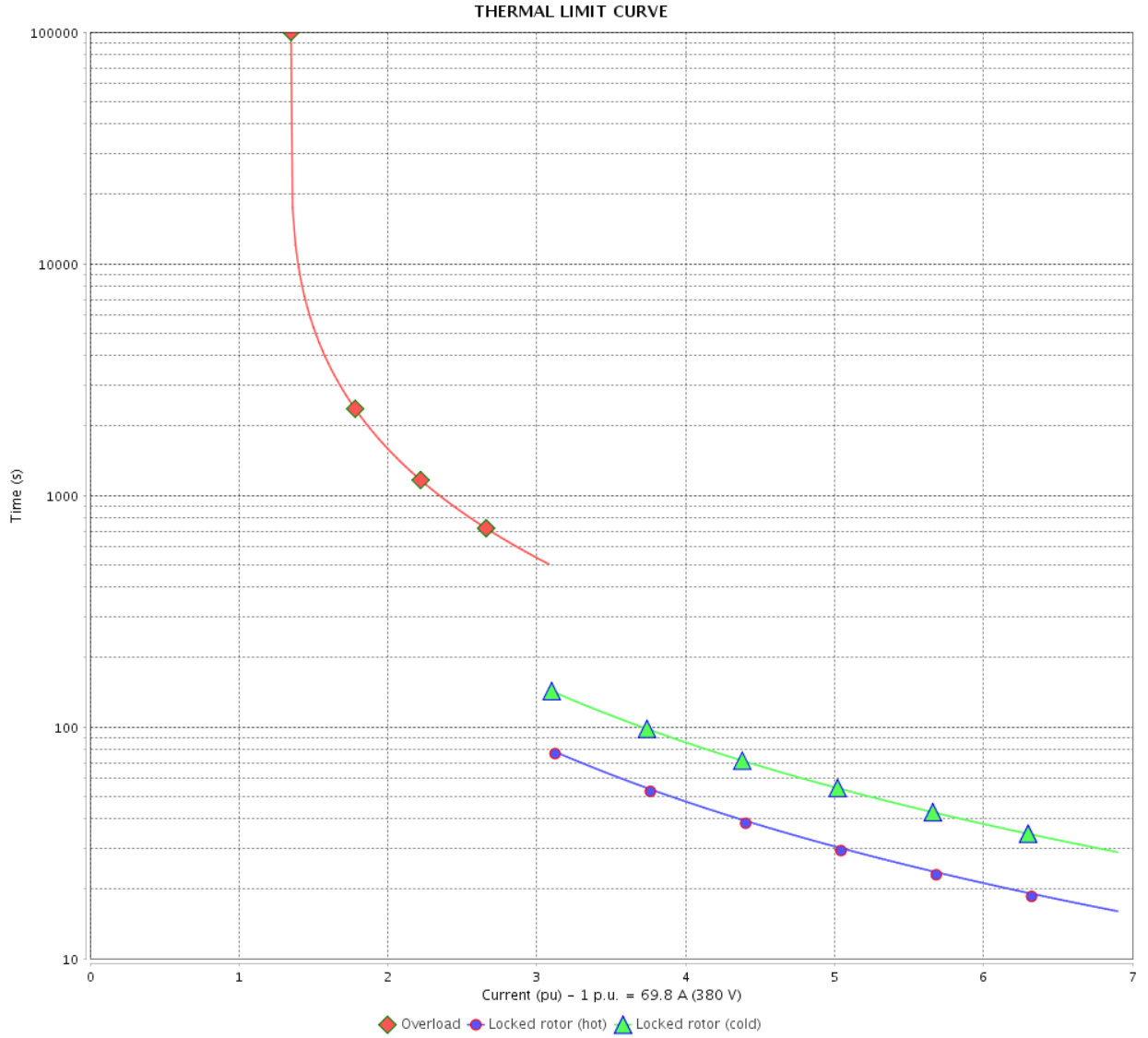

Rev.	Changes Summary	Performed	Checked	Date
Performed by		Page		Revision
Checked by		13 / 21		
Date		13/04/2022		

# THERMAL LIMIT CURVE



## Three Phase Induction Motor - Squirrel Cage

Customer :

Product line : W40 JM Pump NEMA Premium  
Efficiency Three-Phase

Product code : 14484972

Catalog # : 06036OT3E326JM-W40

Performance : 400 V 50 Hz 2P IE3

Rated current	: 68.7 A	Moment of inertia (J)	: 3.82 sq.ft.lb
LRC	: 6.7	Duty cycle	: Cont.(S1)
Rated torque	: 88.7 ft.lb	Insulation class	: F
Locked rotor torque	: 240 %	Service factor	: 1.00
Breakdown torque	: 250 %	Temperature rise	: 80 K
Rated speed	: 2960 rpm	Design	: B

Heating constant

Cooling constant

Rev.	Changes Summary	Performed	Checked	Date
Performed by				
Checked by			Page	Revision
Date	13/04/2022		14 / 21	

# THERMAL LIMIT CURVE

Three Phase Induction Motor - Squirrel Cage



Customer : \_\_\_\_\_

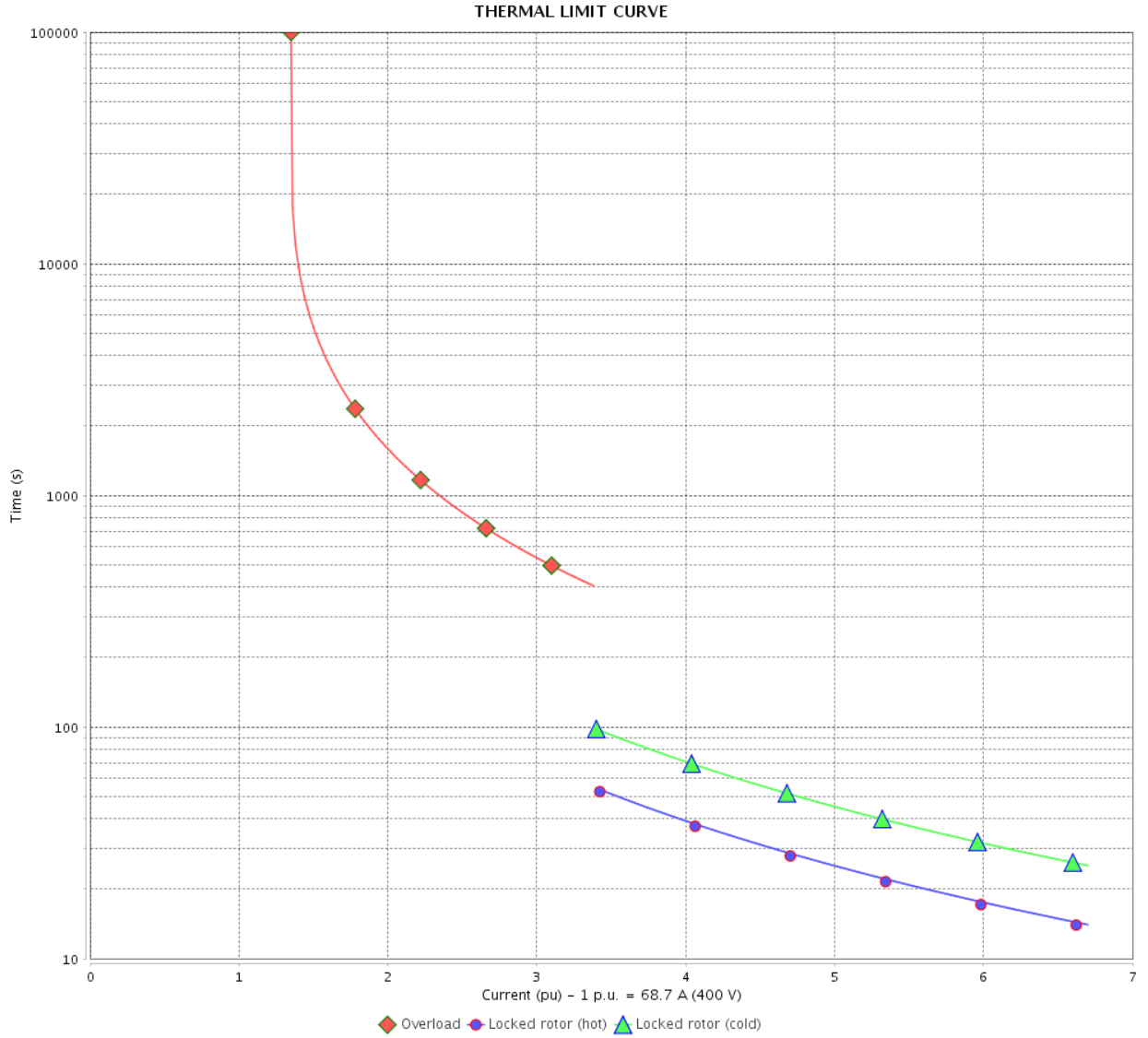

Rev.	Changes Summary	Performed	Checked	Date
Performed by		Page		Revision
Checked by		15 / 21		
Date		13/04/2022		

# THERMAL LIMIT CURVE



## Three Phase Induction Motor - Squirrel Cage

Customer :

Product line : W40 JM Pump NEMA Premium  
Efficiency Three-Phase

Product code : 14484972

Catalog # : 06036OT3E326JM-W40

Performance : 415 V 50 Hz 2P IE3

Rated current : 69.5 A	Moment of inertia (J) : 3.82 sq.ft.lb
LRC : 6.8	Duty cycle : Cont.(S1)
Rated torque : 88.6 ft.lb	Insulation class : F
Locked rotor torque : 260 %	Service factor : 1.00
Breakdown torque : 270 %	Temperature rise : 80 K
Rated speed : 2965 rpm	Design : B

Heating constant

Cooling constant

Rev.	Changes Summary	Performed	Checked	Date
Performed by			Page 16 / 21	Revision
Checked by				
Date	13/04/2022			



# THERMAL LIMIT CURVE

Three Phase Induction Motor - Squirrel Cage



Customer : \_\_\_\_\_

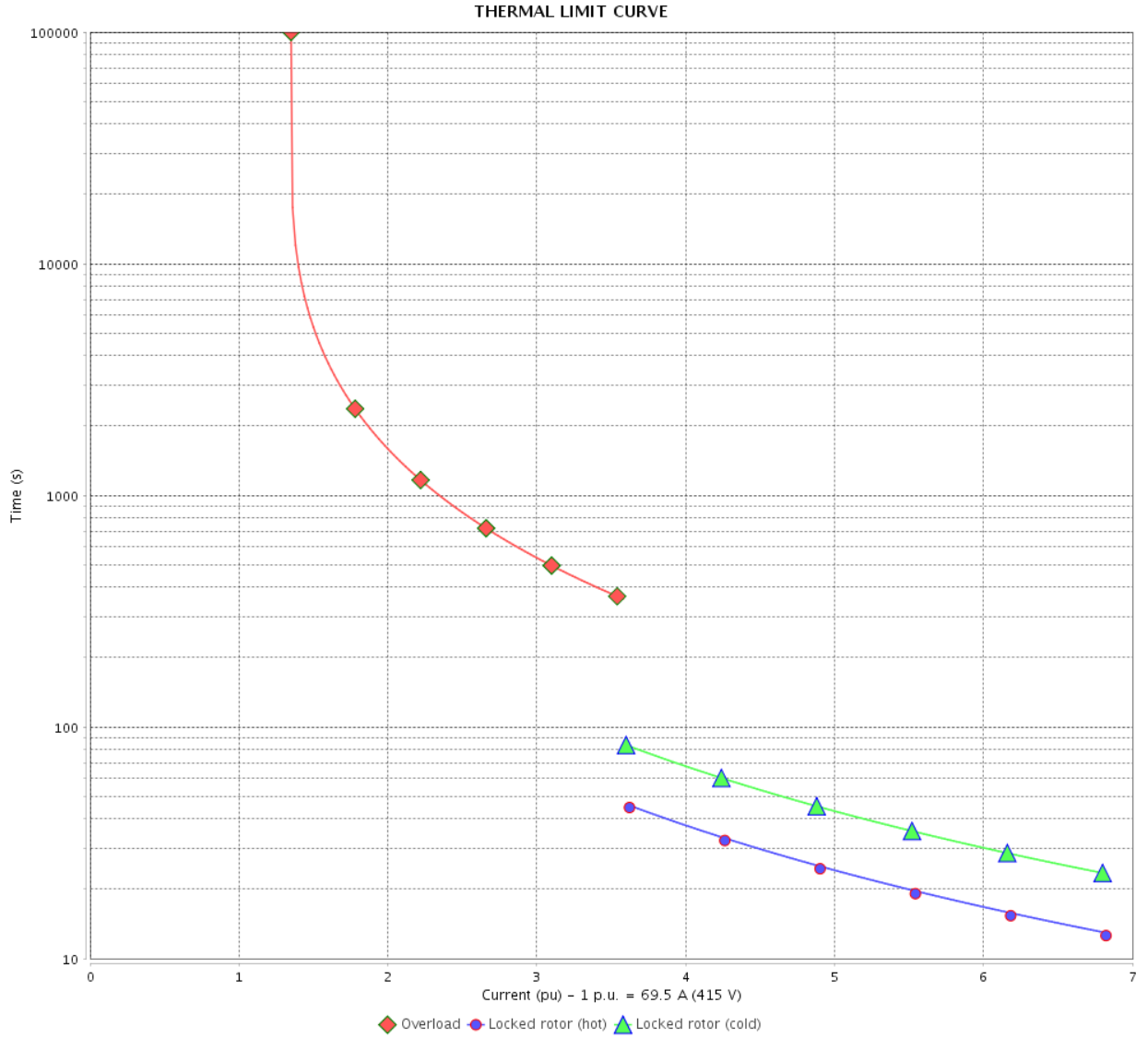

Rev.	Changes Summary	Performed	Checked	Date
Performed by		Page 17 / 21		Revision
Checked by				
Date				

# VFD OPERATION CURVE

Three Phase Induction Motor - Squirrel Cage



Customer :

Product line : W40 JM Pump NEMA Premium Efficiency Three-Phase

Product code : 14484972

Catalog # : 06036OT3E326JM-W40

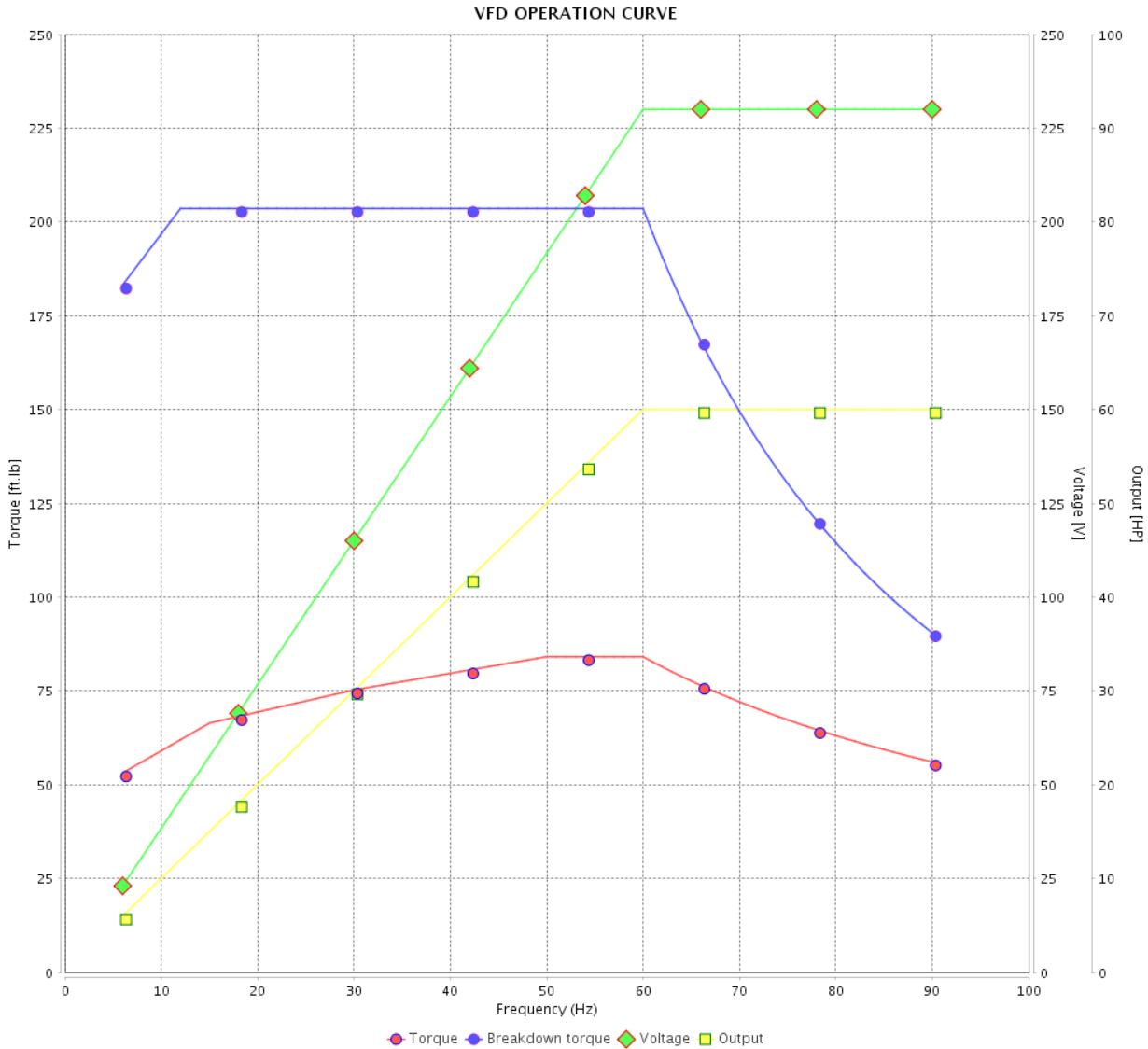

Performance : 230/460 V 60 Hz 2P

Rated current : 142/71.0 A  
 LRC : 6.3  
 Rated torque : 88.5 ft.lb  
 Locked rotor torque : 220 %  
 Breakdown torque : 229 %  
 Rated speed : 3560 rpm

Moment of inertia (J) : 3.82 sq.ft.lb  
 Duty cycle : Cont.(S1)  
 Insulation class : F  
 Service factor : 1.25  
 Temperature rise : 80 K  
 Design : B

Rev.	Changes Summary	Performed	Checked	Date
Performed by			Page 18 / 21	Revision
Checked by				
Date	13/04/2022			

# VFD OPERATION CURVE

## Three Phase Induction Motor - Squirrel Cage



Customer :

Product line : W40 JM Pump NEMA Premium Efficiency Three-Phase

Product code : 14484972

Catalog # : 06036OT3E326JM-W40

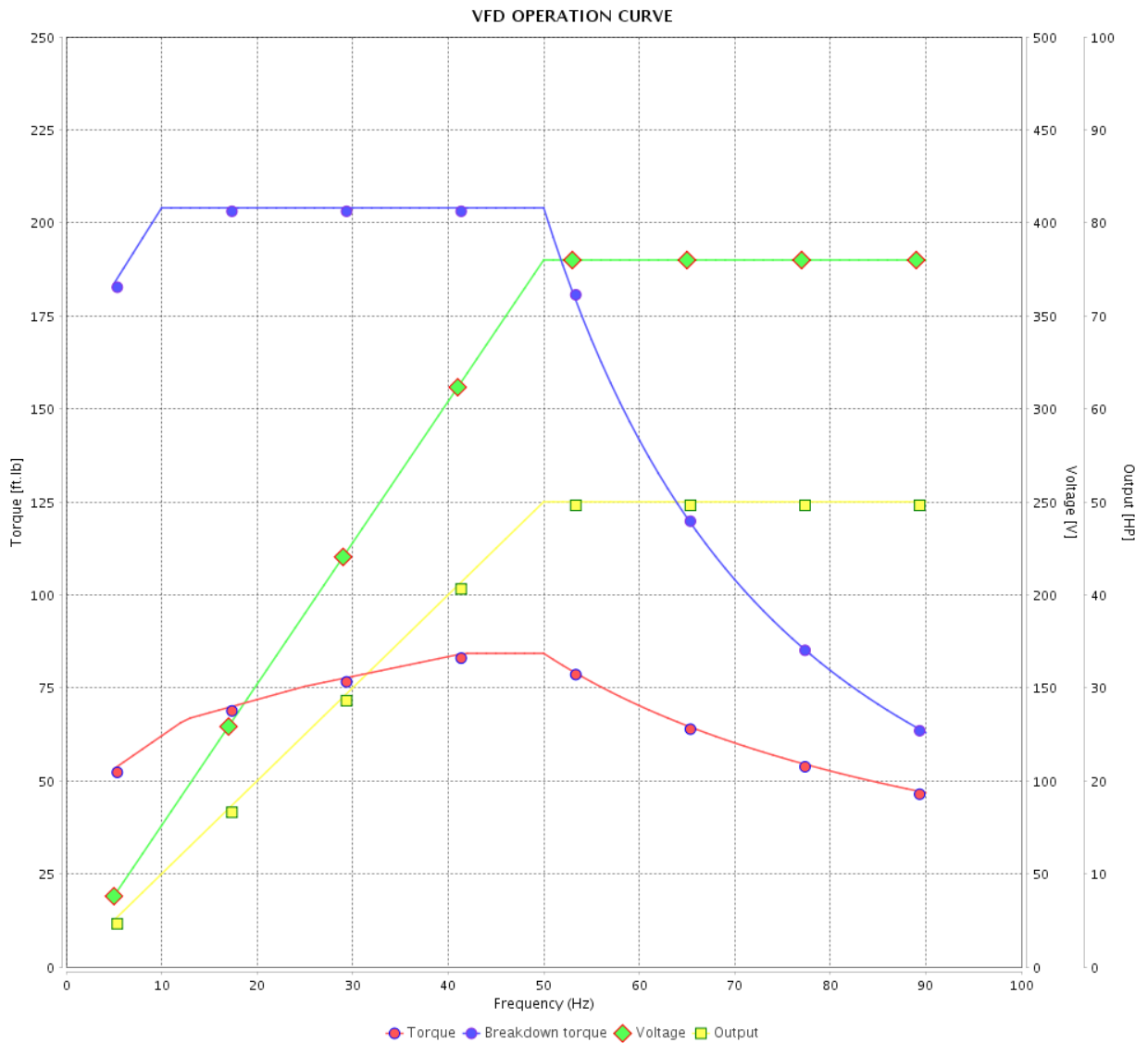

Performance : 380 V 50 Hz 2P IE3

Rated current : 69.8 A  
 LRC : 6.9  
 Rated torque : 88.7 ft.lb  
 Locked rotor torque : 220 %  
 Breakdown torque : 229 %  
 Rated speed : 2960 rpm

Moment of inertia (J) : 3.82 sq.ft.lb  
 Duty cycle : Cont.(S1)  
 Insulation class : F  
 Service factor : 1.00  
 Temperature rise : 80 K  
 Design : B

Rev.	Changes Summary	Performed	Checked	Date
Performed by			Page 19 / 21	Revision
Checked by				
Date	13/04/2022			

# VFD OPERATION CURVE

Three Phase Induction Motor - Squirrel Cage



Customer :

Product line : W40 JM Pump NEMA Premium Efficiency Three-Phase

Product code : 14484972

Catalog # : 06036OT3E326JM-W40

VFD OPERATION CURVE

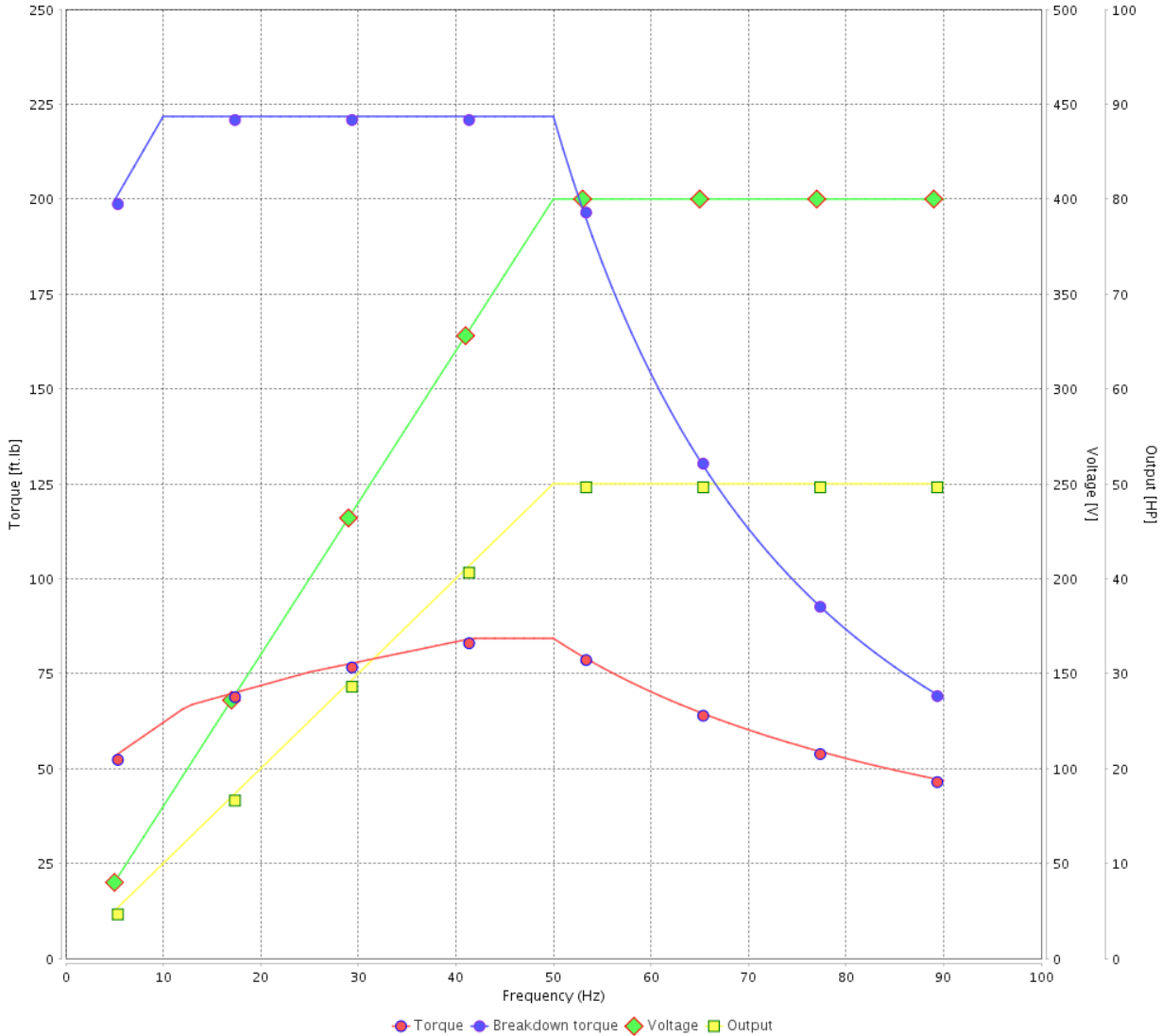

Performance : 400 V 50 Hz 2P IE3

Rated current : 68.7 A  
 LRC : 6.7  
 Rated torque : 88.7 ft.lb  
 Locked rotor torque : 240 %  
 Breakdown torque : 250 %  
 Rated speed : 2960 rpm

Moment of inertia (J) : 3.82 sq.ft.lb  
 Duty cycle : Cont.(S1)  
 Insulation class : F  
 Service factor : 1.00  
 Temperature rise : 80 K  
 Design : B

Rev.	Changes Summary	Performed	Checked	Date
Performed by			Page	Revision
Checked by				
Date				

# VFD OPERATION CURVE

Three Phase Induction Motor - Squirrel Cage



Customer :

Product line : W40 JM Pump NEMA Premium Efficiency Three-Phase

Product code : 14484972

Catalog # : 06036OT3E326JM-W40

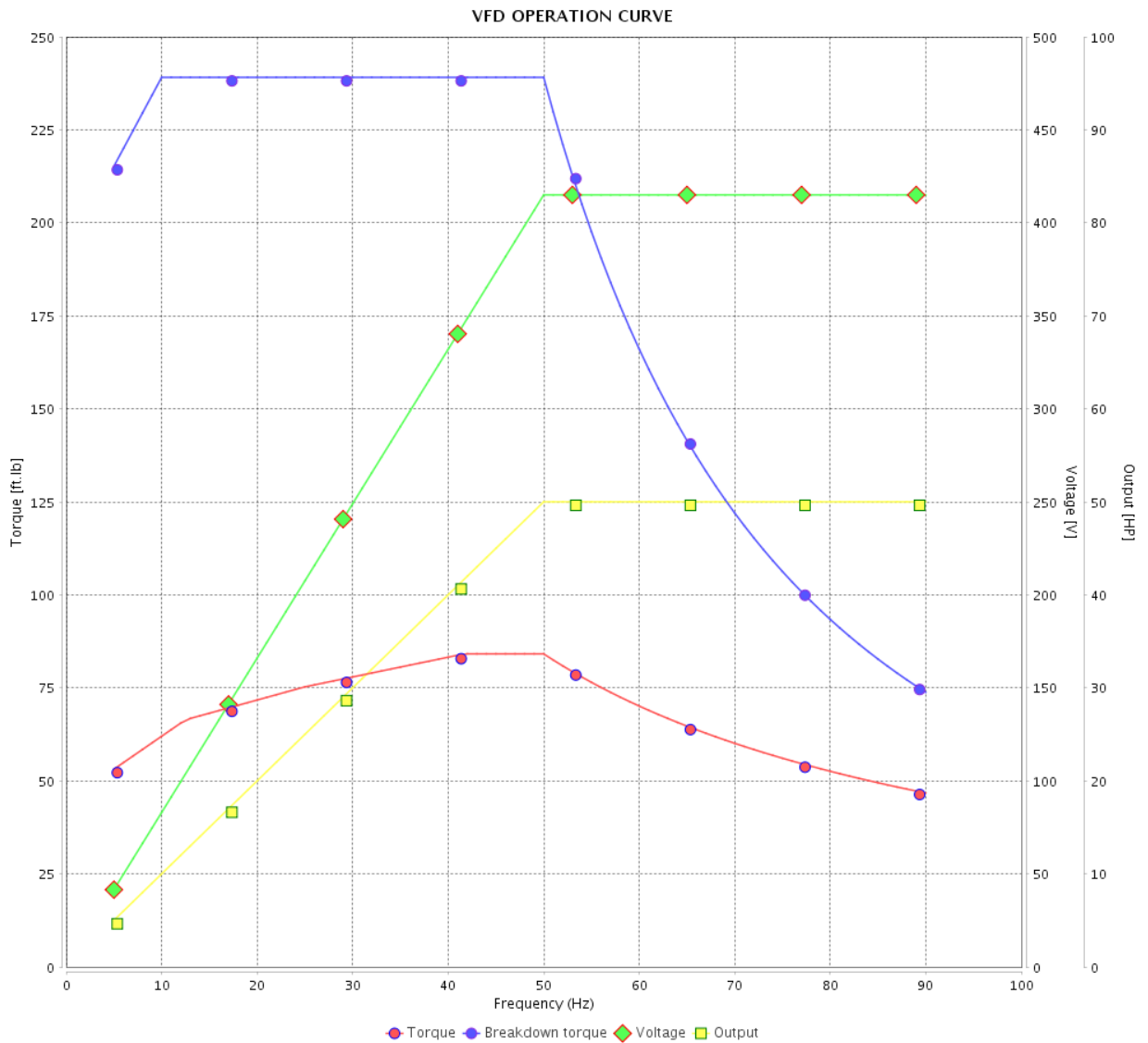

Performance : 415 V 50 Hz 2P IE3

Rated current : 69.5 A  
 LRC : 6.8  
 Rated torque : 88.6 ft.lb  
 Locked rotor torque : 260 %  
 Breakdown torque : 270 %  
 Rated speed : 2965 rpm

Moment of inertia (J) : 3.82 sq.ft.lb  
 Duty cycle : Cont.(S1)  
 Insulation class : F  
 Service factor : 1.00  
 Temperature rise : 80 K  
 Design : B

Rev.	Changes Summary	Performed	Checked	Date
Performed by				Page 21 / 21
Checked by				
Date	13/04/2022			

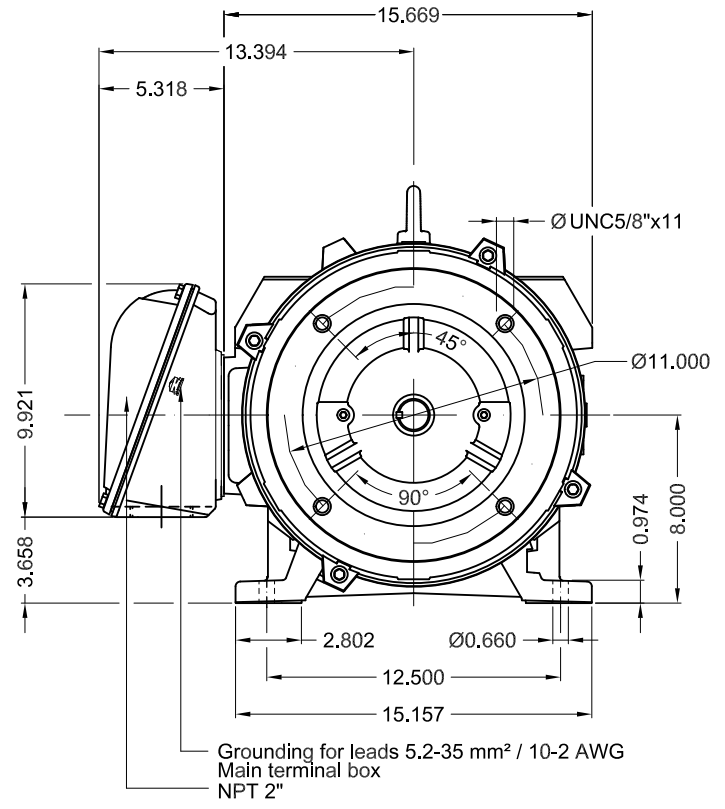

Grounding for leads 5.2-35 mm<sup>2</sup> / 10-2 AWG  
Main terminal box  
NPT 2"

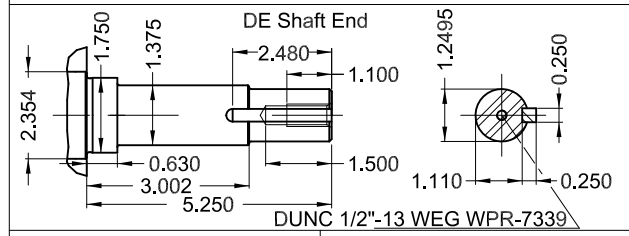
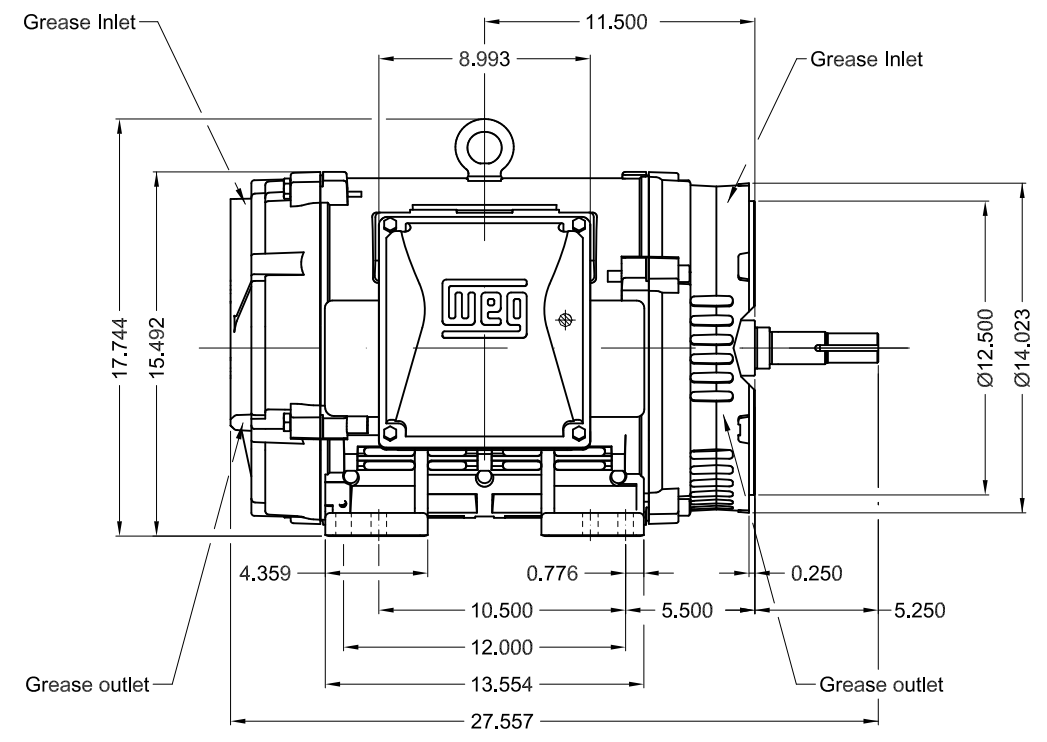

60 HP 02 Poles 60 Hz A

1:8

ECM	LOC	SUMMARY OF MODIFICATIONS	EXECUTED	CHECKED	RELEASED	DATE	VER
EXECUTED	PIRWBUSER	THREE PH. MOTOR W40 CLOSE COUPLED PUMP JM TYPE PREM-EST.					
CHECKED		FRAME 324/6JM IP23 ODP					
RELEASED							
REL DT.	WMO	Jaragua do Sul	Product Engineering	WDD	SHEET	1 / 1	

Color RAL 5009  
Painting plan 203A  
Mounting NEMA F-1  
Mounting B34R(D)

PREVIEW



**WEG** **W40 NEMA**  
**CC029A Premium**  
*Inverter Duty Motor*



IEC 60034-1  
 MOD.T01#FOXON



For 60Hz use on PWM, VT 1000:1, CT 3:1, 1.0SF

MODEL 060360T3E326JM-W40  
 MADE IN BRAZIL  
 14484972

PH 3	FR 324/6JM	HP(kW) 60.0(45.0)	Hz 60
V 230/460	A 142/71.0	RPM 3560	DES B
NEMA NOM EFF 93.6 %	INS. CL. F $\Delta$ T 80 K	IP23	
ENCL ODP	DUTY CONT.	AMB. 40°C	
CODE G	PF 0.85	SF 1.25	SFA 178/88.8
USABLE @208V 157 A	SF 1.15	SFA 181	
50HP 37kW 50Hz 380V 69.8A 2960RPM SF1.00 EFF 93.7% (IE3)	ALT 1000 m.a.s.l.	476 Lbs	

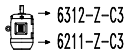
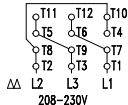

MOBIL POLYREX EM  
 21 g 19658 h