

DATA SHEET



Three Phase Induction Motor - Squirrel Cage

Customer :								
Product line		: NEMA Premium Efficiency Three-Phase			Product code :		12076589	
					Catalog # :		07518ET3E365TC-W22	
Frame : 364/5TC Insulation class : F Duty cycle : Cont.(S1) Ambient temperature : -20°C to +40°C Altitude : 1000 m.a.s.l. Protection degree : IP55 Design : B				Cooling method : IC411 - TEFC Mounting : F-1 Rotation ¹ : Both (CW and CCW) Starting method : Direct On Line Approx. weight ² : 953 lb Moment of inertia (J) : 23.3 sq.ft.lb				
Output [HP]	75	60	60	60	75	75	75	
Poles	4	4	4	4	4	4	4	
Frequency [Hz]	60	50	50	50	50	50	50	
Rated voltage [V]	230/460	380	400	415	380	400	415	
Rated current [A]	174/87.2	88.5	84.9	82.7	106	102	98.7	
L. R. Amperes [A]	1116/558	620	637	662	541	571	602	
LRC [A]	6.4x(Code G)	7.0x(Code H)	7.5x(Code J)	8.0x(Code J)	5.1x(Code E)	5.6x(Code F)	6.1x(Code G)	
No load current [A]	66.0/33.0	33.0	35.0	38.0	33.0	35.0	38.0	
Rated speed [RPM]	1780	1480	1480	1485	1470	1475	1480	
Slip [%]	1.11	1.33	1.33	1.00	2.00	1.67	1.33	
Rated torque [ft.lb]	221	213	213	212	268	267	266	
Locked rotor torque [%]	240	210	240	260	170	200	210	
Breakdown torque [%]	260	250	280	310	200	220	240	
Service factor	1.25	1.00	1.00	1.00	1.00	1.00	1.00	
Temperature rise	80 K	80 K	80 K	80 K	105 K	105 K	105 K	
Locked rotor time	25s (cold)	18s (cold)	18s (cold)	18s (cold)	18s (cold)	18s (cold)	18s (cold)	
	14s (hot)	10s (hot)	10s (hot)	10s (hot)	10s (hot)	10s (hot)	10s (hot)	
Noise level ²	67.0 dB(A)	63.0 dB(A)	63.0 dB(A)	63.0 dB(A)	63.0 dB(A)	63.0 dB(A)	63.0 dB(A)	
Efficiency (%)	25%							
	50%	94.5	93.7	93.6	93.5	94.5	94.1	
	75%	95.0	94.2	94.2	94.2	94.1	94.5	
	100%	95.4	94.2	94.4	94.6	93.6	94.5	
Power Factor	25%							
	50%	0.68	0.68	0.64	0.61	0.75	0.67	
	75%	0.78	0.78	0.75	0.73	0.82	0.78	
	100%	0.83	0.82	0.81	0.80	0.84	0.82	
Bearing type		Drive end : 6314 C3	Non drive end : 6314 C3	Foundation loads				
Sealing		: WSeal	: WSeal	Max. traction		: 1710 lb		
Lubrication interval		: 12000 h	: 12000 h	Max. compression		: 2663 lb		
Lubricant amount		: 27 g	: 27 g					
Lubricant type		: Mobil Polyrex EM						
Notes USABLE @208V 186A SF 1.10 SFA 205A								
This revision replaces and cancel the previous one, which must be eliminated. (1) Looking the motor from the shaft end. (2) Measured at 1m and with tolerance of +3dB(A). (3) Approximate weight subject to changes after manufacturing process. (4) At 100% of full load.				These are average values based on tests with sinusoidal power supply, subject to the tolerances stipulated in NEMA MG-1.				
Rev.	Changes Summary			Performed	Checked	Date		
Performed by								
Checked by					Page	Revision		
Date	13/04/2022				1 / 36			

TORQUE AND CURRENT VS SPEED CURVE

Three Phase Induction Motor - Squirrel Cage



Customer :

Product line : NEMA Premium Efficiency Three-Phase

Product code : 12076589

Catalog # : 07518ET3E365TC-W22

TORQUE AND CURRENT VS SPEED CURVE

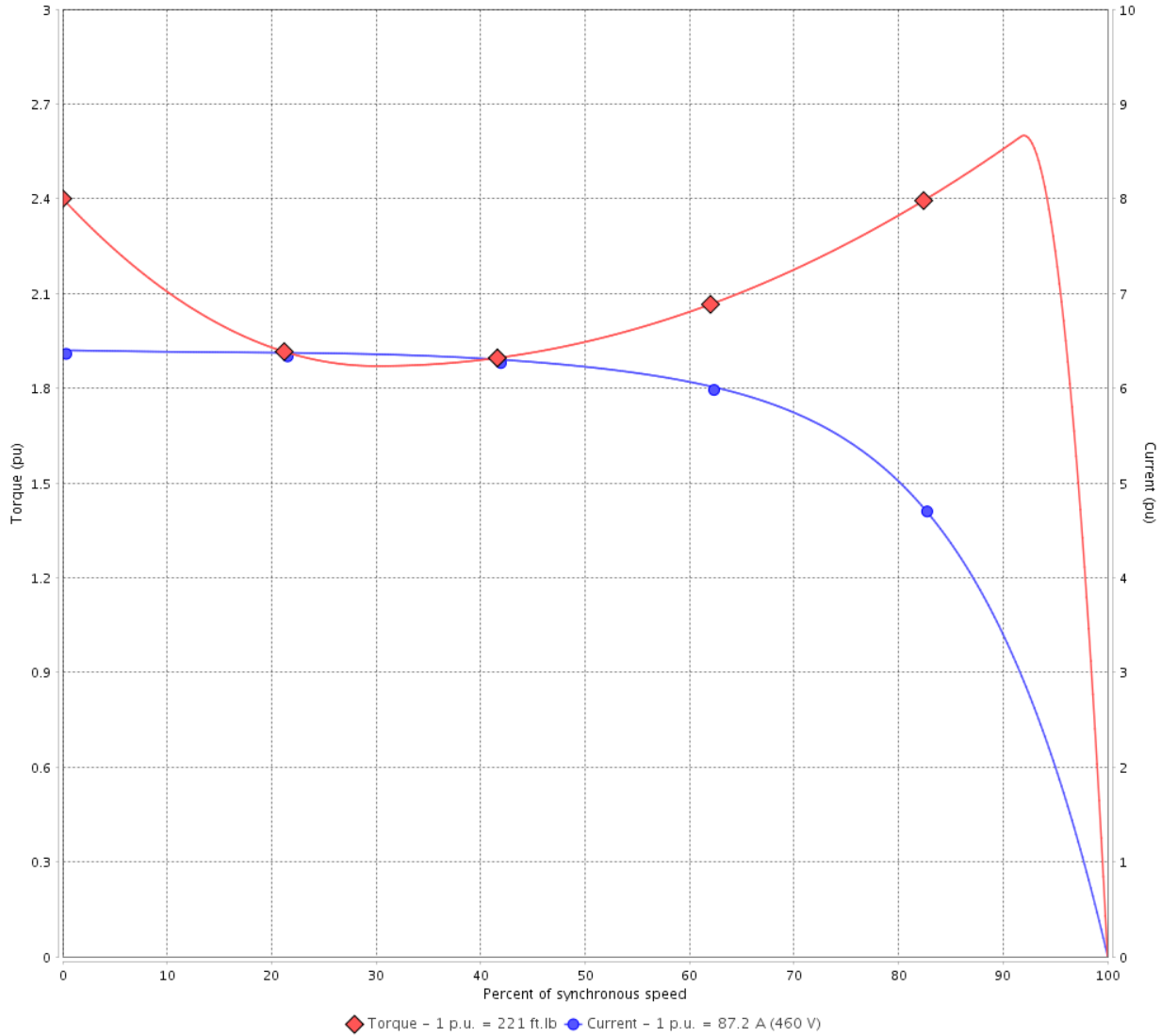

Performance : 230/460 V 60 Hz 4P

Rated current	: 174/87.2 A	Moment of inertia (J)	: 23.3 sq.ft.lb
LRC	: 6.4	Duty cycle	: Cont.(S1)
Rated torque	: 221 ft.lb	Insulation class	: F
Locked rotor torque	: 240 %	Service factor	: 1.25
Breakdown torque	: 260 %	Temperature rise	: 80 K
Rated speed	: 1780 rpm	Design	: B

Locked rotor time : 25s (cold) 14s (hot)

Rev.	Changes Summary	Performed	Checked	Date
Performed by			Page 2 / 36	Revision
Checked by				
Date	13/04/2022			

TORQUE AND CURRENT VS SPEED CURVE



Three Phase Induction Motor - Squirrel Cage

Customer :

Product line : NEMA Premium Efficiency Three-Phase

Product code : 12076589

Catalog # : 07518ET3E365TC-W22

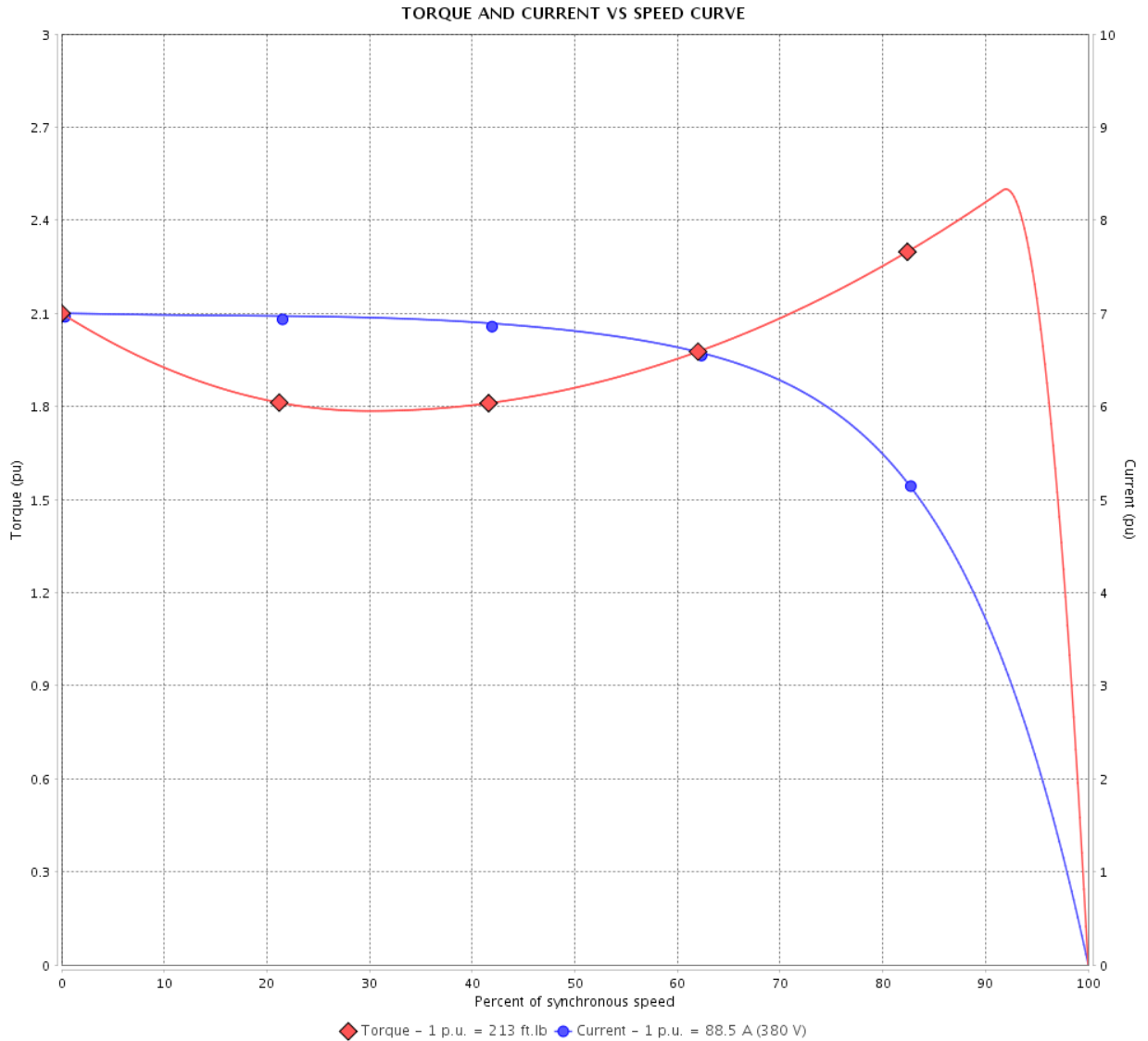

Performance : 380 V 50 Hz 4P IE3

Rated current	: 88.5 A	Moment of inertia (J)	: 23.3 sq.ft.lb
LRC	: 7.0	Duty cycle	: Cont.(S1)
Rated torque	: 213 ft.lb	Insulation class	: F
Locked rotor torque	: 210 %	Service factor	: 1.00
Breakdown torque	: 250 %	Temperature rise	: 80 K
Rated speed	: 1480 rpm	Design	: B

Locked rotor time : 18s (cold) 10s (hot)

Rev.	Changes Summary	Performed	Checked	Date
Performed by			Page 3 / 36	Revision
Checked by				
Date	13/04/2022			

TORQUE AND CURRENT VS SPEED CURVE

Three Phase Induction Motor - Squirrel Cage



Customer :

Product line : NEMA Premium Efficiency Three-Phase

Product code : 12076589

Catalog # : 07518ET3E365TC-W22

TORQUE AND CURRENT VS SPEED CURVE

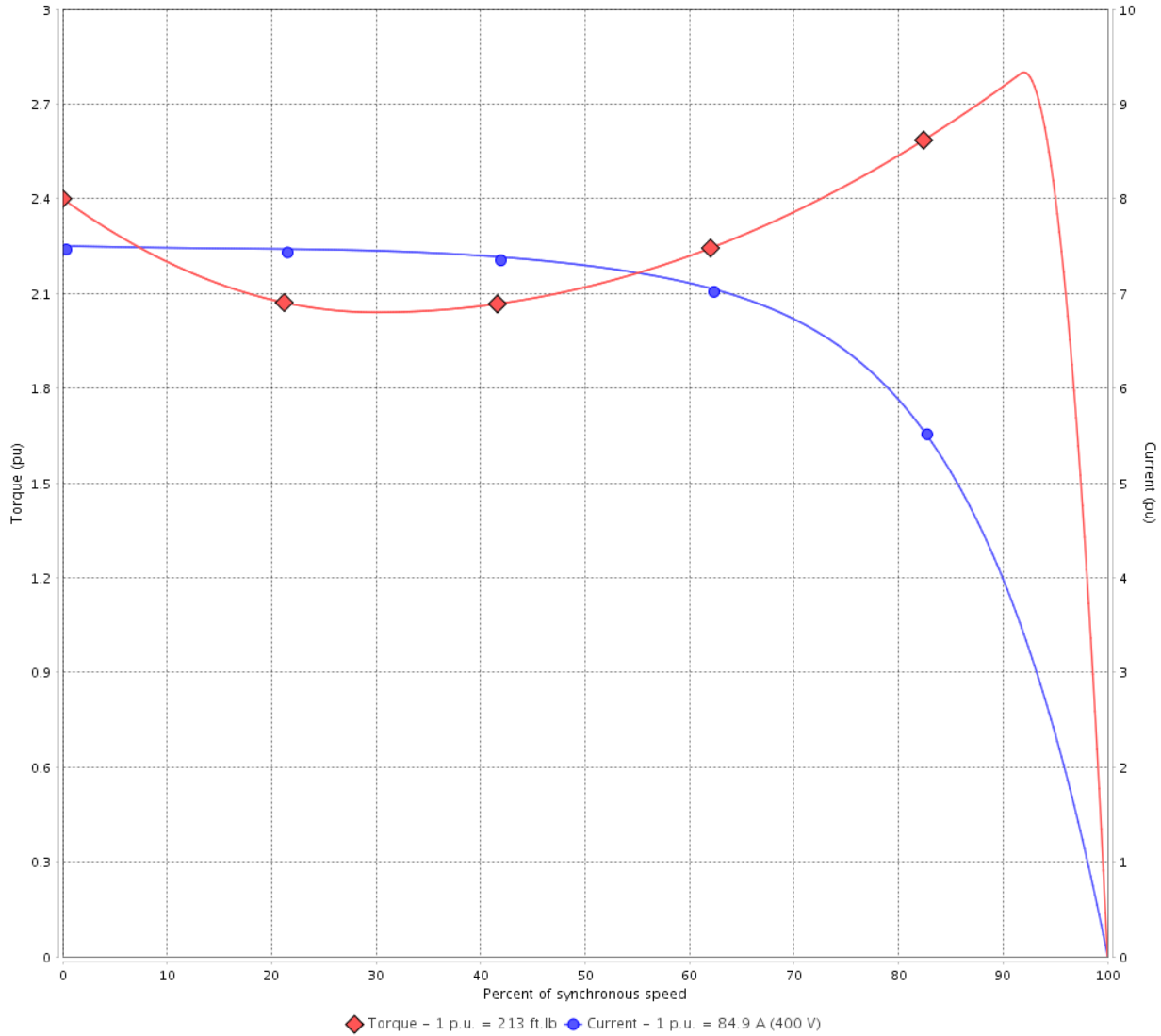

Performance : 400 V 50 Hz 4P IE3

Rated current	: 84.9 A	Moment of inertia (J)	: 23.3 sq.ft.lb
LRC	: 7.5	Duty cycle	: Cont.(S1)
Rated torque	: 213 ft.lb	Insulation class	: F
Locked rotor torque	: 240 %	Service factor	: 1.00
Breakdown torque	: 280 %	Temperature rise	: 80 K
Rated speed	: 1480 rpm	Design	: B

Locked rotor time : 18s (cold) 10s (hot)

Rev.	Changes Summary	Performed	Checked	Date
Performed by			Page 4 / 36	Revision
Checked by				
Date	13/04/2022			

TORQUE AND CURRENT VS SPEED CURVE



Three Phase Induction Motor - Squirrel Cage

Customer :

Product line : NEMA Premium Efficiency Three-Phase

Product code : 12076589

Catalog # : 07518ET3E365TC-W22

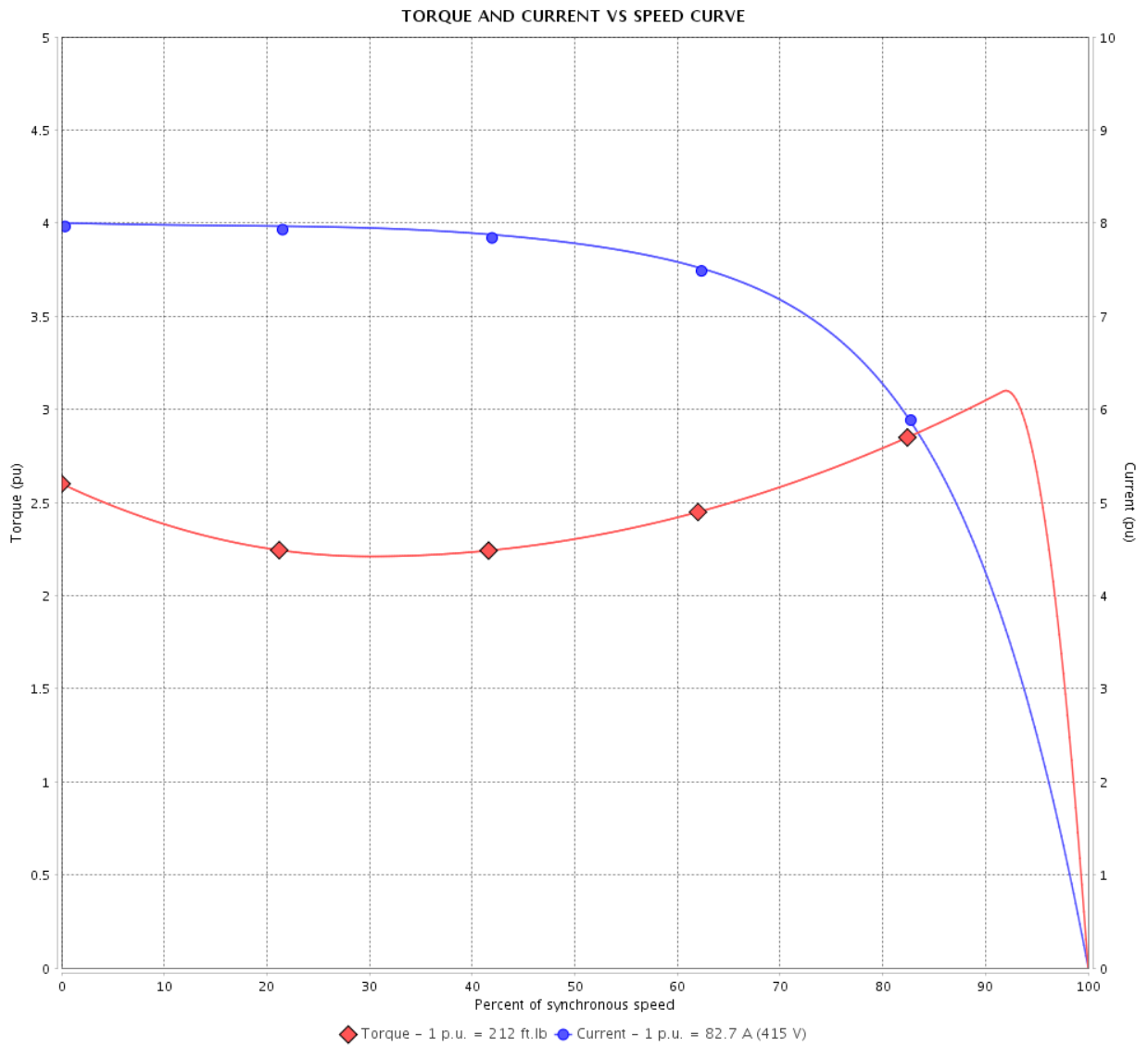

Performance : 415 V 50 Hz 4P IE3

Rated current : 82.7 A
 LRC : 8.0
 Rated torque : 212 ft.lb
 Locked rotor torque : 260 %
 Breakdown torque : 310 %
 Rated speed : 1485 rpm

Moment of inertia (J) : 23.3 sq.ft.lb
 Duty cycle : Cont.(S1)
 Insulation class : F
 Service factor : 1.00
 Temperature rise : 80 K
 Design : B

Locked rotor time : 18s (cold) 10s (hot)

Rev.	Changes Summary	Performed	Checked	Date
Performed by			Page 5 / 36	Revision
Checked by				
Date	13/04/2022			

TORQUE AND CURRENT VS SPEED CURVE

Three Phase Induction Motor - Squirrel Cage



Customer :

Product line : NEMA Premium Efficiency Three-Phase

Product code : 12076589

Catalog # : 07518ET3E365TC-W22

TORQUE AND CURRENT VS SPEED CURVE

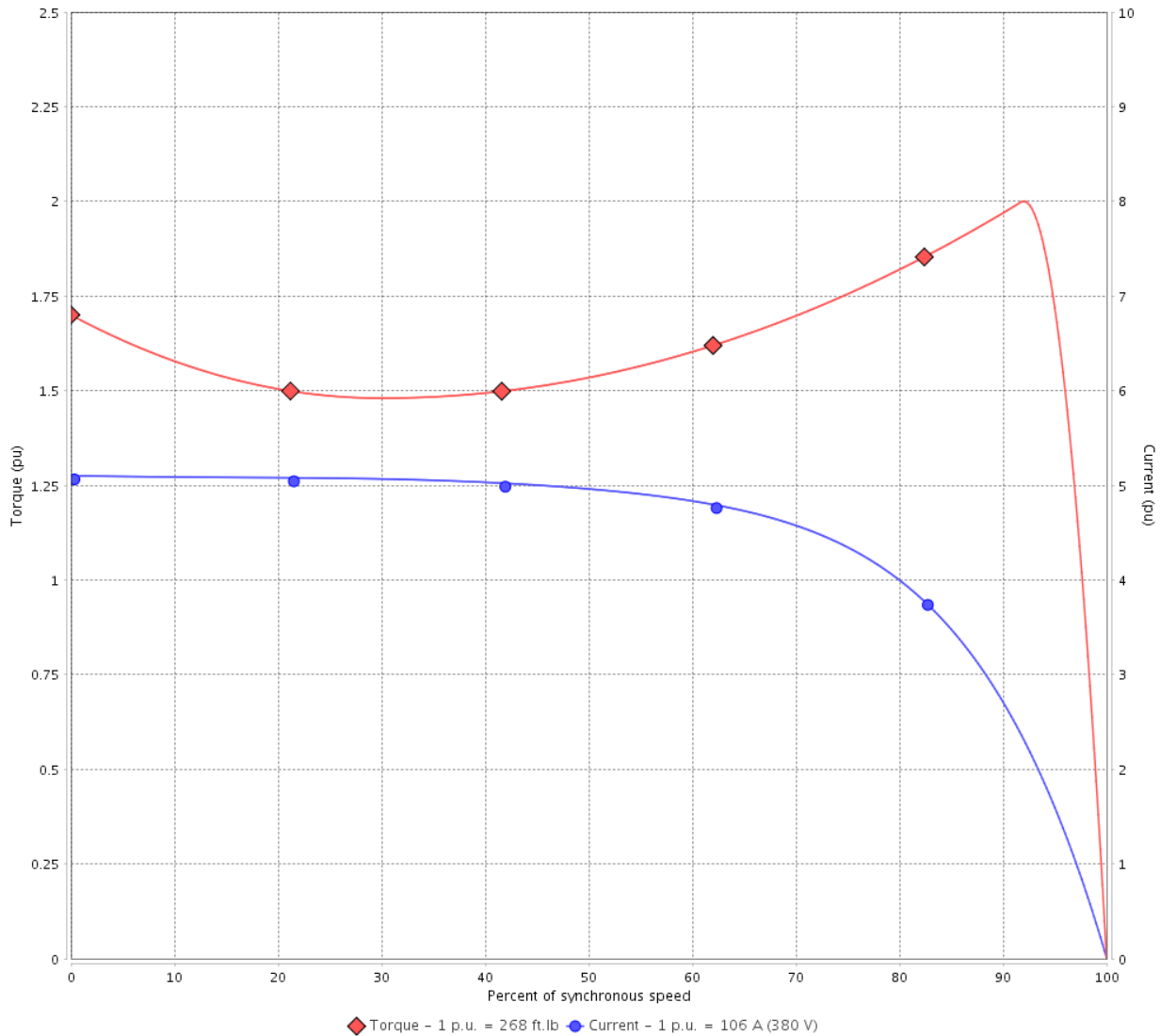

Performance : 380 V 50 Hz 4P IE2

Rated current	: 106 A	Moment of inertia (J)	: 23.3 sq.ft.lb
LRC	: 5.1	Duty cycle	: Cont.(S1)
Rated torque	: 268 ft.lb	Insulation class	: F
Locked rotor torque	: 170 %	Service factor	: 1.00
Breakdown torque	: 200 %	Temperature rise	: 105 K
Rated speed	: 1470 rpm	Design	: B

Locked rotor time : 18s (cold) 10s (hot)

Rev.	Changes Summary	Performed	Checked	Date
Performed by			Page 6 / 36	Revision
Checked by				
Date	13/04/2022			

TORQUE AND CURRENT VS SPEED CURVE



Three Phase Induction Motor - Squirrel Cage

Customer :

Product line : NEMA Premium Efficiency Three-Phase

Product code : 12076589

Catalog # : 07518ET3E365TC-W22

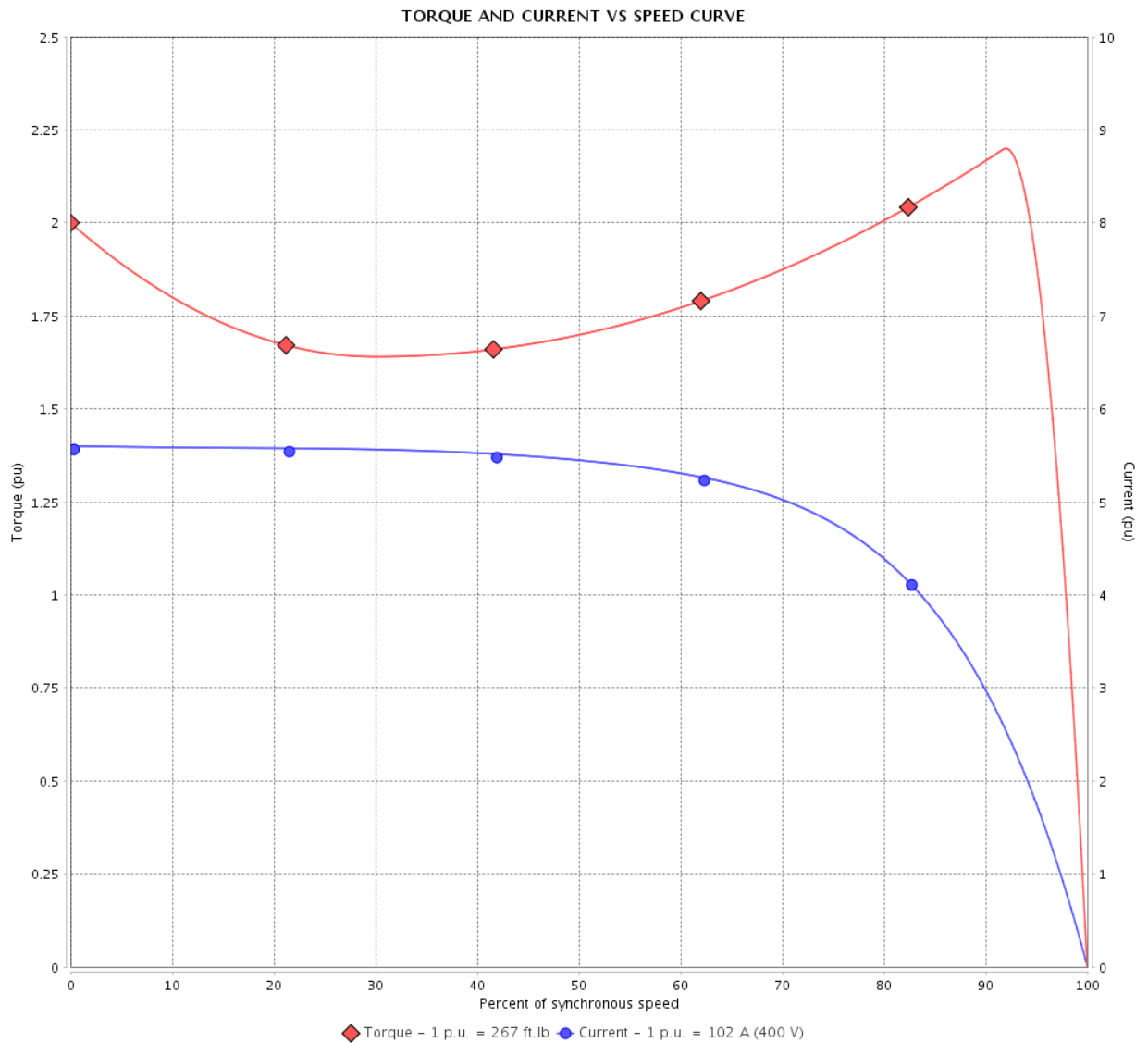

Performance : 400 V 50 Hz 4P IE2

Rated current	: 102 A	Moment of inertia (J)	: 23.3 sq.ft.lb
LRC	: 5.6	Duty cycle	: Cont.(S1)
Rated torque	: 267 ft.lb	Insulation class	: F
Locked rotor torque	: 200 %	Service factor	: 1.00
Breakdown torque	: 220 %	Temperature rise	: 105 K
Rated speed	: 1475 rpm	Design	: B

Locked rotor time : 18s (cold) 10s (hot)

Rev.	Changes Summary	Performed	Checked	Date
Performed by			Page 7 / 36	Revision
Checked by				
Date	13/04/2022			

TORQUE AND CURRENT VS SPEED CURVE

Three Phase Induction Motor - Squirrel Cage



Customer :

Product line : NEMA Premium Efficiency Three-Phase

Product code : 12076589

Catalog # : 07518ET3E365TC-W22

TORQUE AND CURRENT VS SPEED CURVE

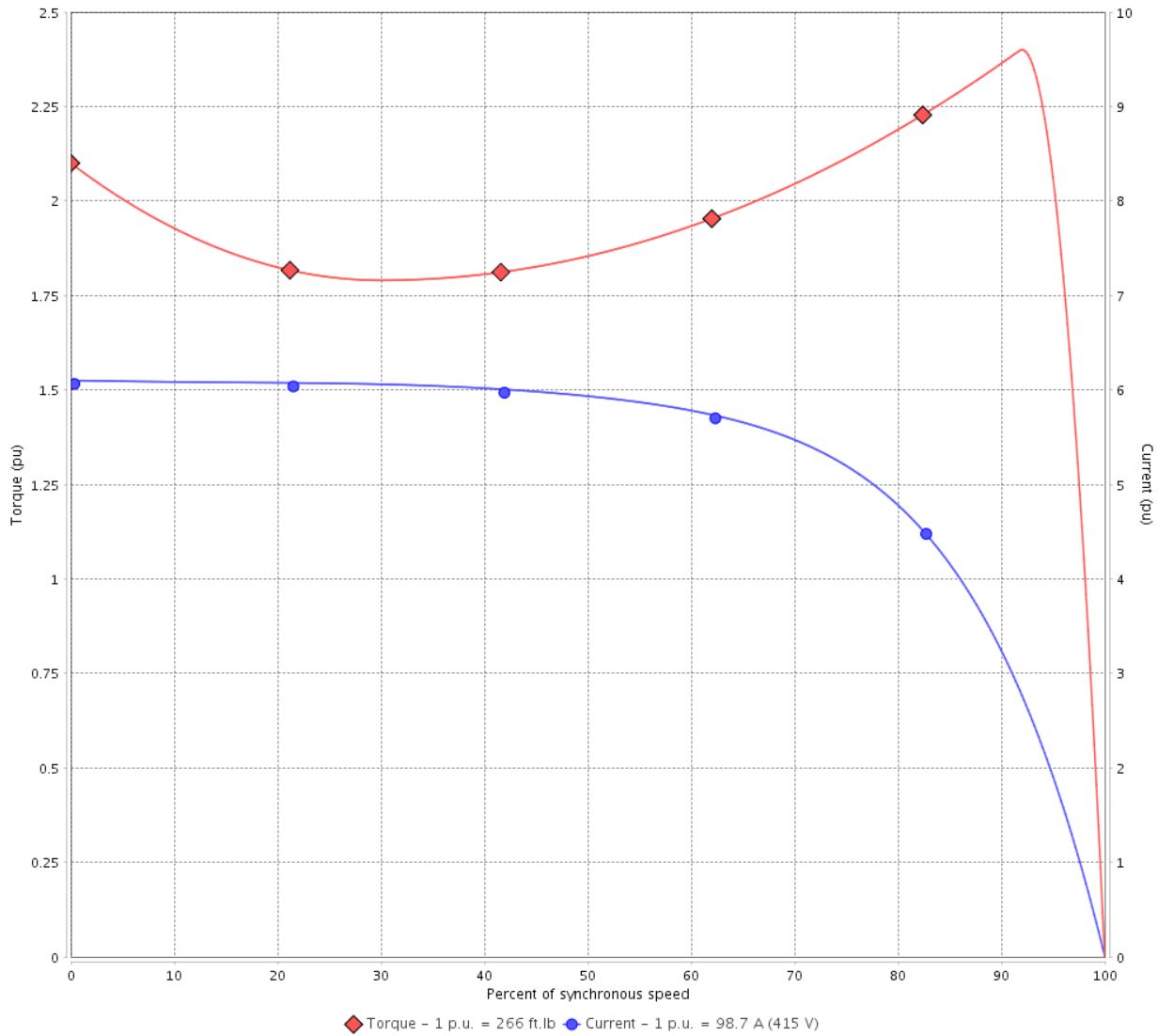

Performance : 415 V 50 Hz 4P IE2

Rated current	: 98.7 A	Moment of inertia (J)	: 23.3 sq.ft.lb
LRC	: 6.1	Duty cycle	: Cont.(S1)
Rated torque	: 266 ft.lb	Insulation class	: F
Locked rotor torque	: 210 %	Service factor	: 1.00
Breakdown torque	: 240 %	Temperature rise	: 105 K
Rated speed	: 1480 rpm	Design	: B

Locked rotor time : 18s (cold) 10s (hot)

Rev.	Changes Summary	Performed	Checked	Date
Performed by			Page	Revision
Checked by				
Date	13/04/2022			
			8 / 36	

LOAD PERFORMANCE CURVE

Three Phase Induction Motor - Squirrel Cage



Customer :

Product line : NEMA Premium Efficiency Three-Phase

Product code : 12076589

Catalog # : 07518ET3E365TC-W22

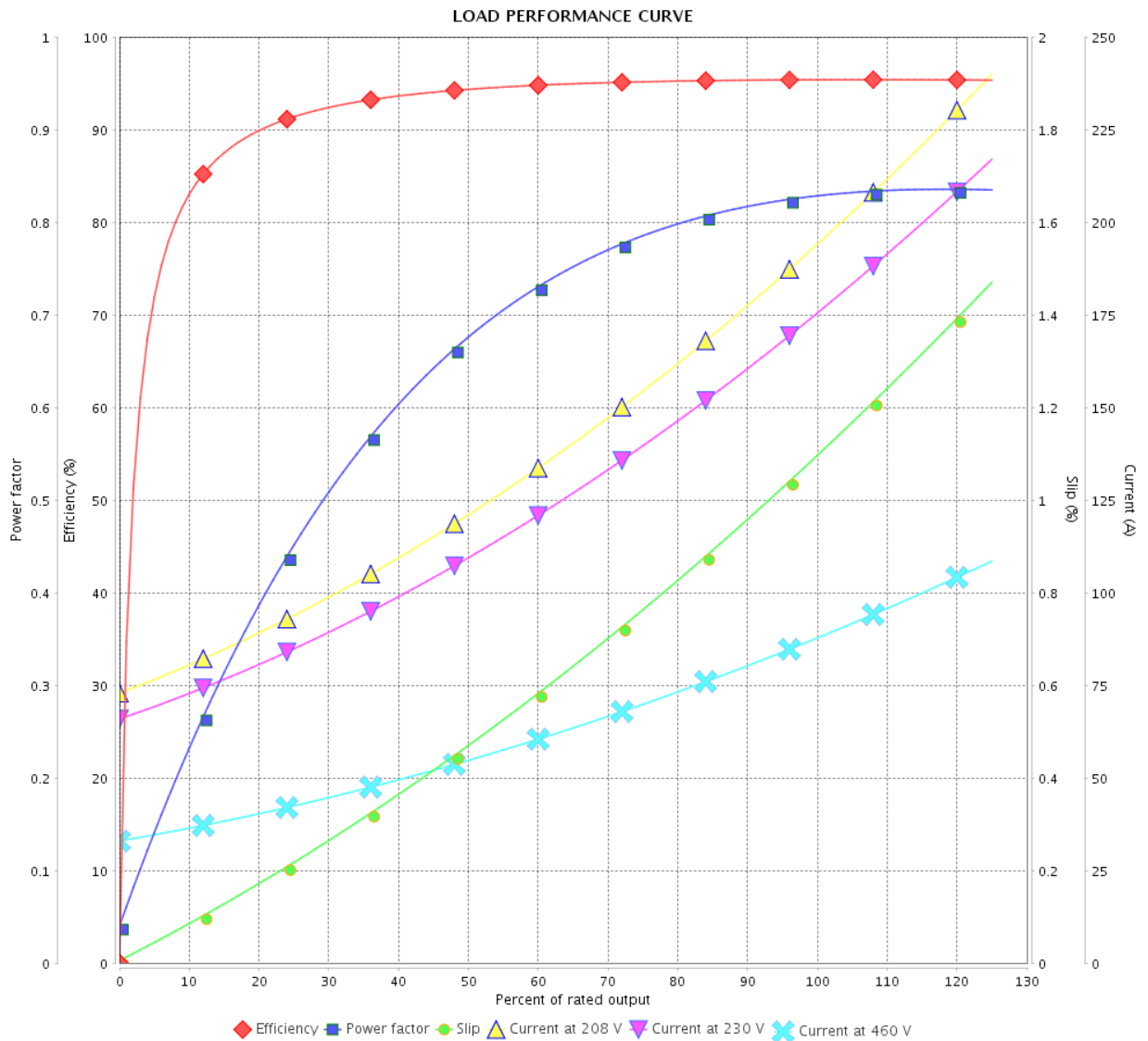

Performance : 230/460 V 60 Hz 4P

Rated current : 174/87.2 A
 LRC : 6.4
 Rated torque : 221 ft.lb
 Locked rotor torque : 240 %
 Breakdown torque : 260 %
 Rated speed : 1780 rpm

Moment of inertia (J) : 23.3 sq.ft.lb
 Duty cycle : Cont.(S1)
 Insulation class : F
 Service factor : 1.25
 Temperature rise : 80 K
 Design : B

Rev.	Changes Summary	Performed	Checked	Date
Performed by		Page		Revision
Checked by		9 / 36		
Date		13/04/2022		

LOAD PERFORMANCE CURVE

Three Phase Induction Motor - Squirrel Cage



Customer :

Product line : NEMA Premium Efficiency Three-Phase

Product code : 12076589

Catalog # : 07518ET3E365TC-W22

LOAD PERFORMANCE CURVE

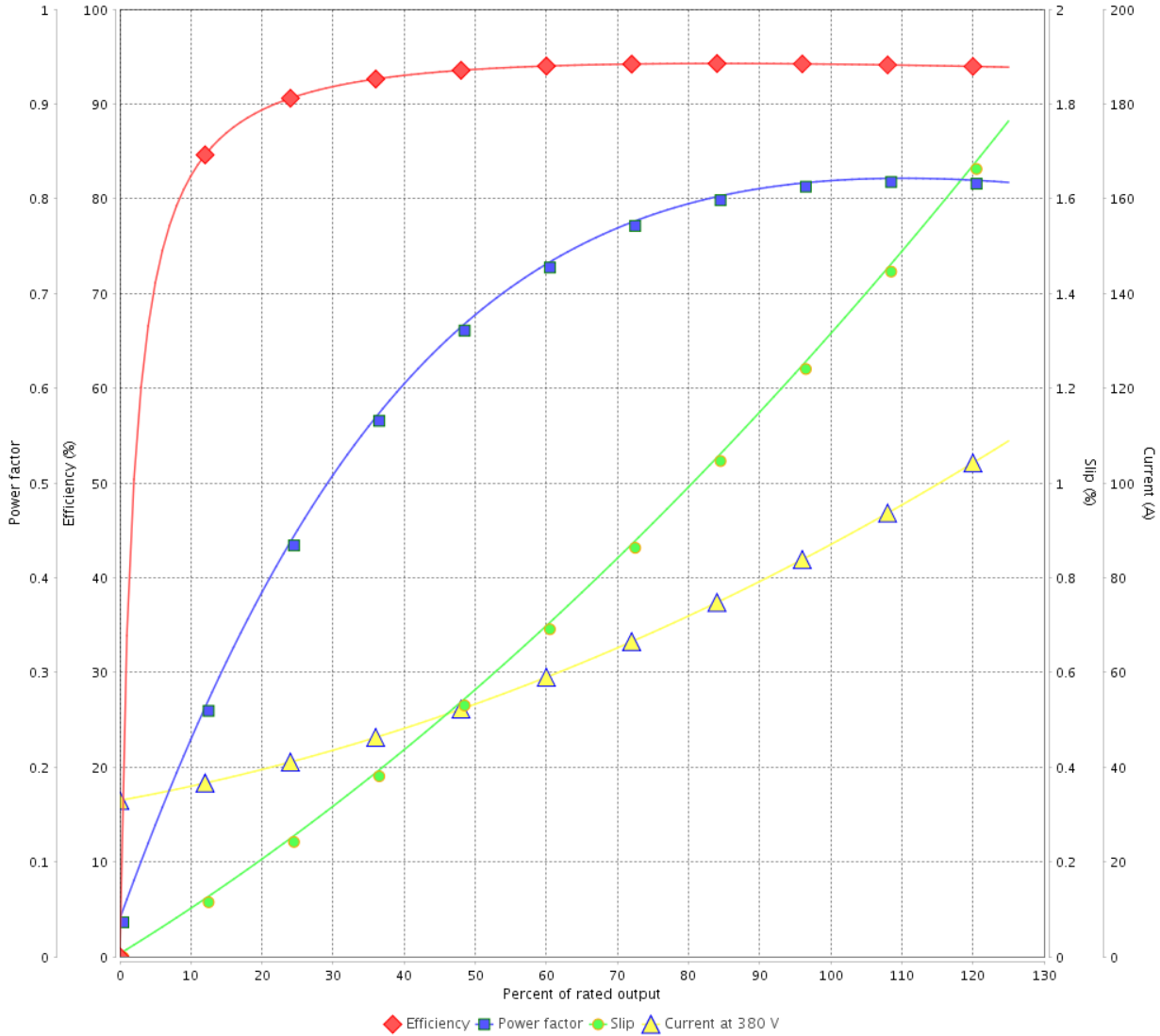

Performance : 380 V 50 Hz 4P IE3

Rated current : 88.5 A
 LRC : 7.0
 Rated torque : 213 ft.lb
 Locked rotor torque : 210 %
 Breakdown torque : 250 %
 Rated speed : 1480 rpm

Moment of inertia (J) : 23.3 sq.ft.lb
 Duty cycle : Cont.(S1)
 Insulation class : F
 Service factor : 1.00
 Temperature rise : 80 K
 Design : B

Rev.	Changes Summary	Performed	Checked	Date
Performed by			Page	Revision
Checked by			10 / 36	
Date	13/04/2022			

LOAD PERFORMANCE CURVE

Three Phase Induction Motor - Squirrel Cage



Customer :

Product line : NEMA Premium Efficiency Three-Phase

Product code : 12076589

Catalog # : 07518ET3E365TC-W22

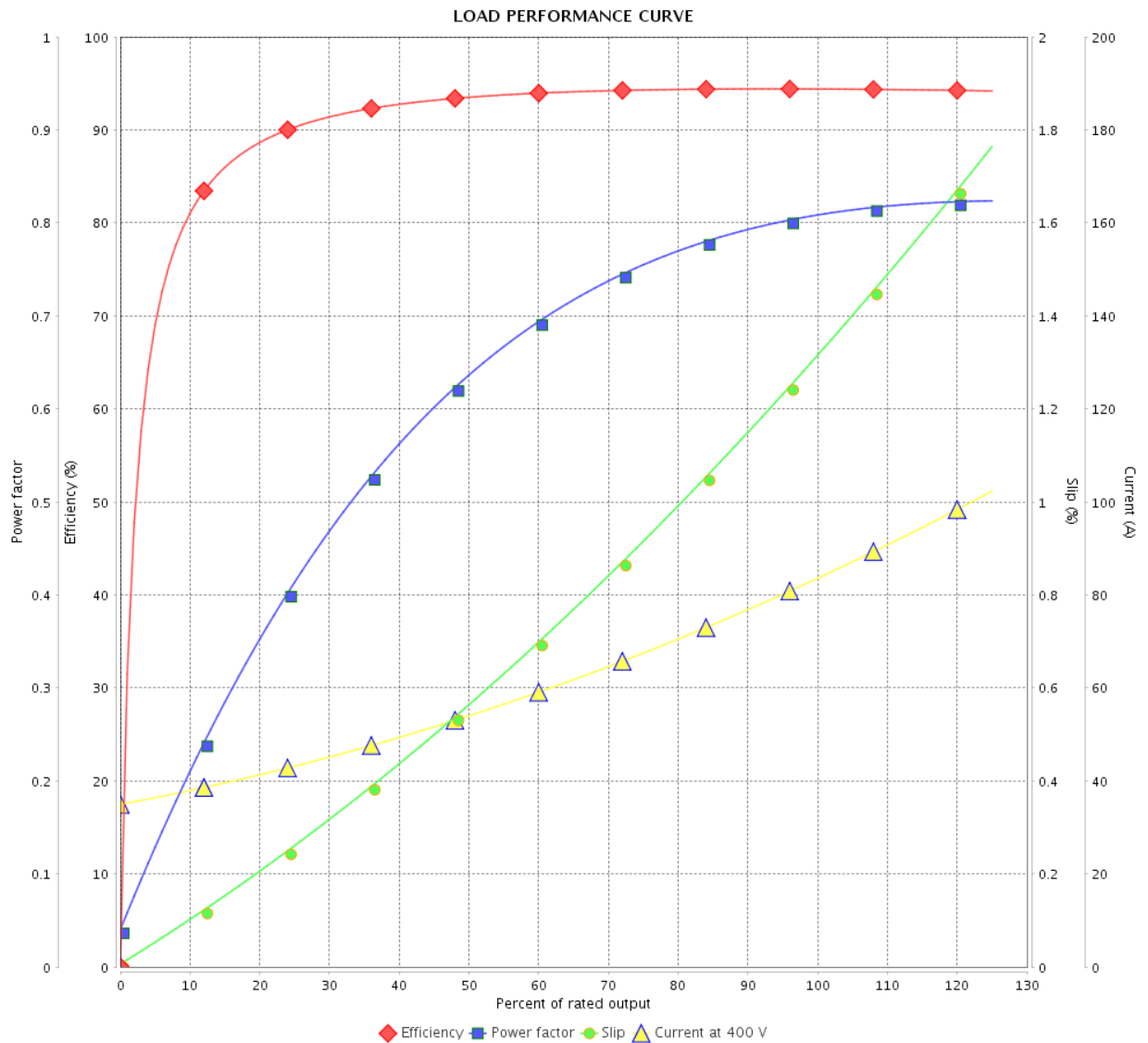

Performance : 400 V 50 Hz 4P IE3

Rated current : 84.9 A
 LRC : 7.5
 Rated torque : 213 ft.lb
 Locked rotor torque : 240 %
 Breakdown torque : 280 %
 Rated speed : 1480 rpm

Moment of inertia (J) : 23.3 sq.ft.lb
 Duty cycle : Cont.(S1)
 Insulation class : F
 Service factor : 1.00
 Temperature rise : 80 K
 Design : B

Rev.	Changes Summary	Performed	Checked	Date
Performed by			Page	Revision
Checked by				
Date				
			11 / 36	

LOAD PERFORMANCE CURVE

Three Phase Induction Motor - Squirrel Cage



Customer :

Product line : NEMA Premium Efficiency Three-Phase

Product code : 12076589

Catalog # : 07518ET3E365TC-W22

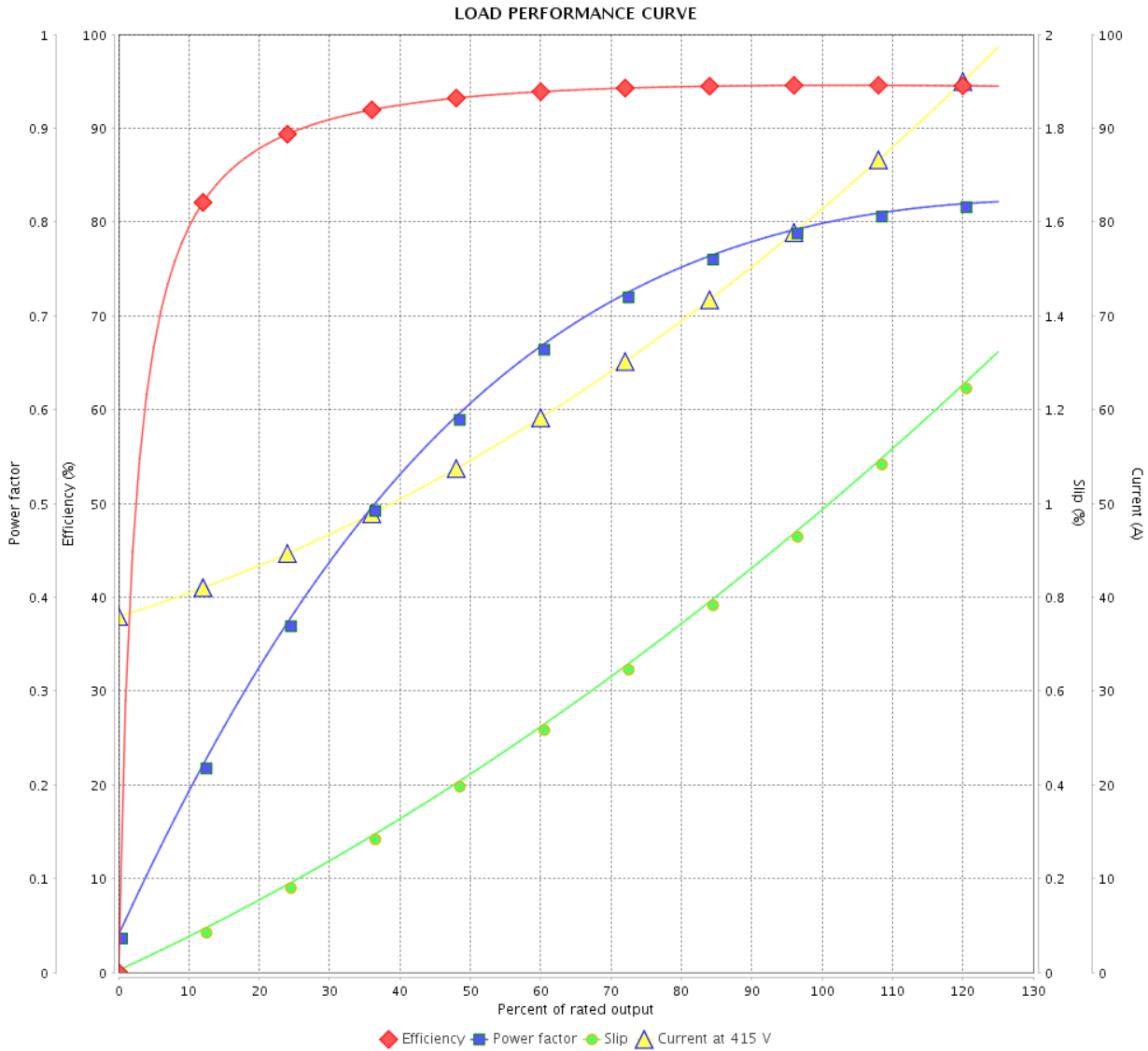

Performance : 415 V 50 Hz 4P IE3

Rated current	: 82.7 A	Moment of inertia (J)	: 23.3 sq.ft.lb
LRC	: 8.0	Duty cycle	: Cont.(S1)
Rated torque	: 212 ft.lb	Insulation class	: F
Locked rotor torque	: 260 %	Service factor	: 1.00
Breakdown torque	: 310 %	Temperature rise	: 80 K
Rated speed	: 1485 rpm	Design	: B

Rev.	Changes Summary	Performed	Checked	Date
Performed by			Page	Revision
Checked by			12 / 36	
Date	13/04/2022			

LOAD PERFORMANCE CURVE

Three Phase Induction Motor - Squirrel Cage



Customer :

Product line : NEMA Premium Efficiency Three-Phase

Product code : 12076589

Catalog # : 07518ET3E365TC-W22

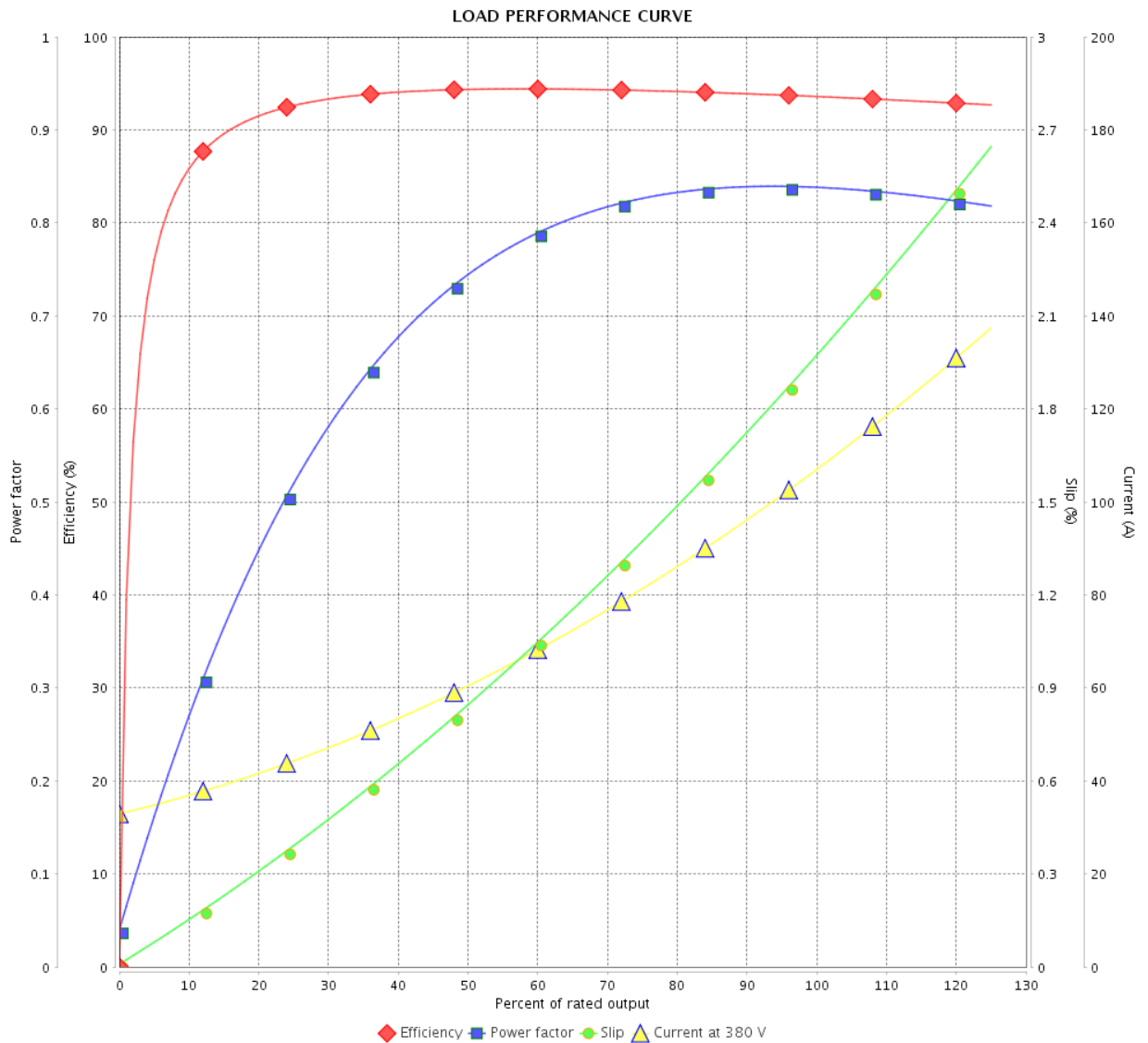

Performance : 380 V 50 Hz 4P IE2

Rated current : 106 A
 LRC : 5.1
 Rated torque : 268 ft.lb
 Locked rotor torque : 170 %
 Breakdown torque : 200 %
 Rated speed : 1470 rpm

Moment of inertia (J) : 23.3 sq.ft.lb
 Duty cycle : Cont.(S1)
 Insulation class : F
 Service factor : 1.00
 Temperature rise : 105 K
 Design : B

Rev.	Changes Summary	Performed	Checked	Date
Performed by		Page		Revision
Checked by		13 / 36		
Date		13/04/2022		

LOAD PERFORMANCE CURVE

Three Phase Induction Motor - Squirrel Cage



Customer : _____

Product line : NEMA Premium Efficiency Three-Phase

Product code : 12076589

Catalog # : 07518ET3E365TC-W22

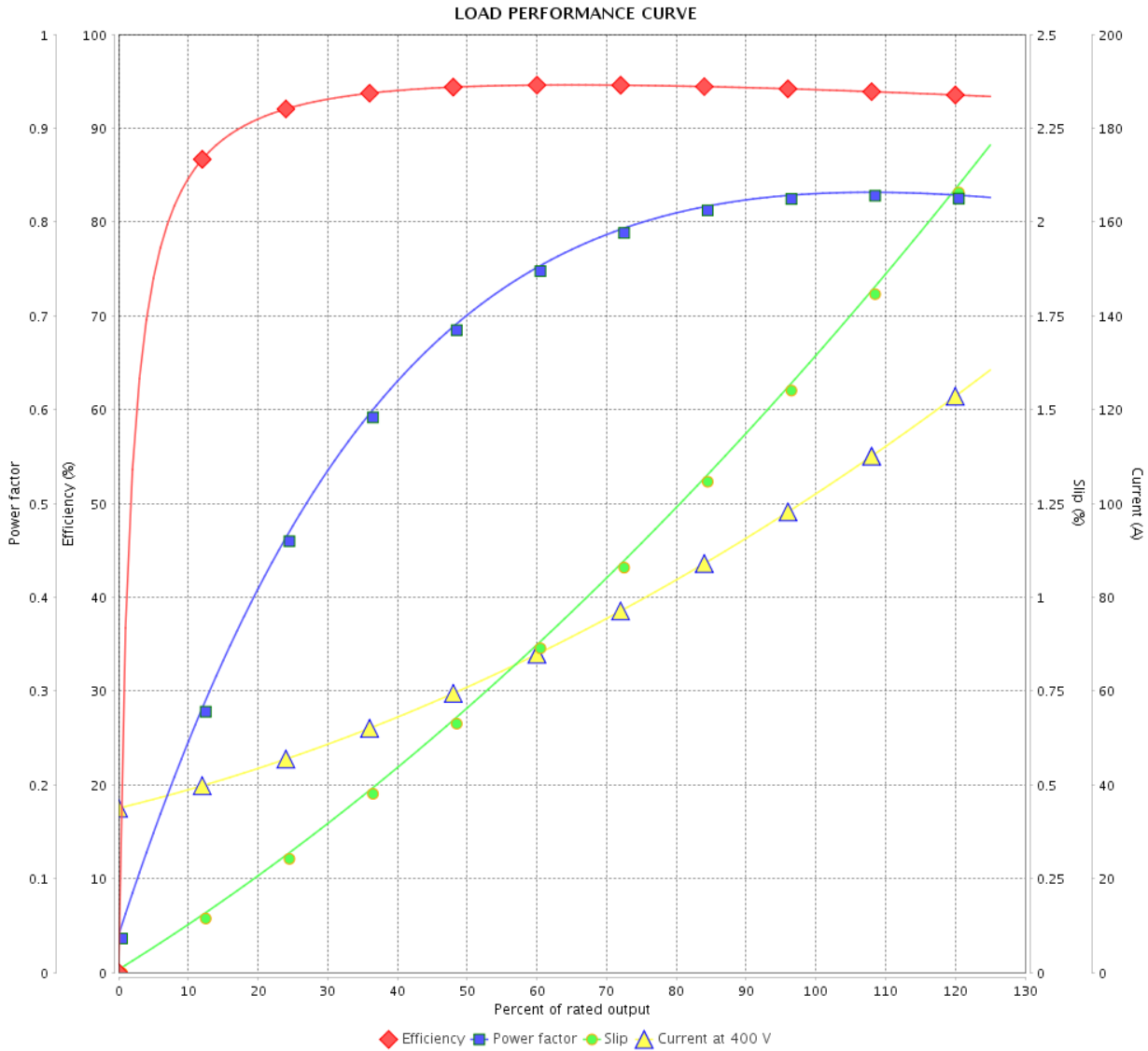

Performance : 400 V 50 Hz 4P IE2

Rated current : 102 A
 LRC : 5.6
 Rated torque : 267 ft.lb
 Locked rotor torque : 200 %
 Breakdown torque : 220 %
 Rated speed : 1475 rpm

Moment of inertia (J) : 23.3 sq.ft.lb
 Duty cycle : Cont.(S1)
 Insulation class : F
 Service factor : 1.00
 Temperature rise : 105 K
 Design : B

Rev.	Changes Summary	Performed	Checked	Date
Performed by		Page		Revision
Checked by		14 / 36		
Date		13/04/2022		

LOAD PERFORMANCE CURVE

Three Phase Induction Motor - Squirrel Cage



Customer : _____

Product line : NEMA Premium Efficiency Three-Phase

Product code : 12076589

Catalog # : 07518ET3E365TC-W22

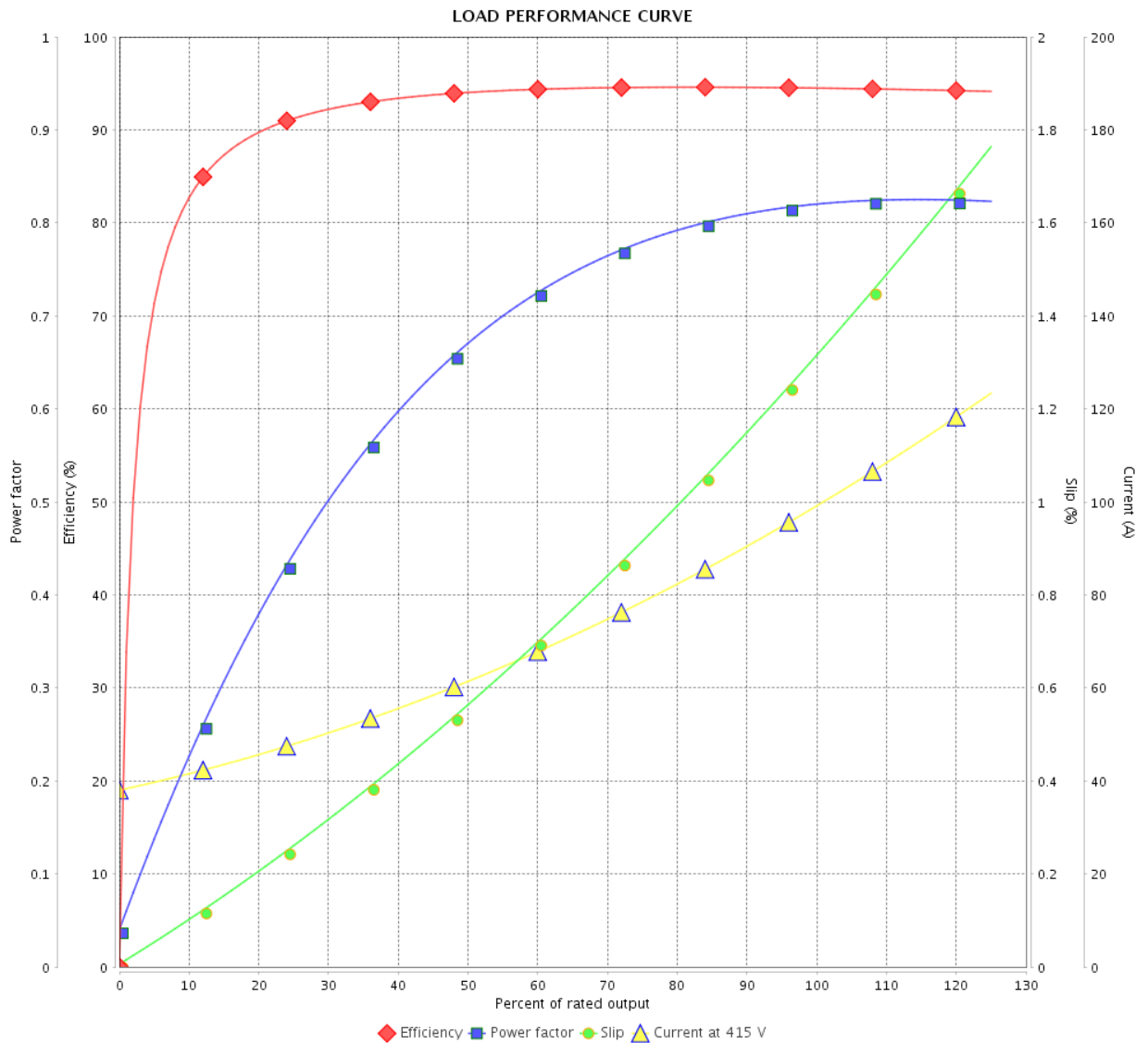

Performance : 415 V 50 Hz 4P IE2

Rated current : 98.7 A
 LRC : 6.1
 Rated torque : 266 ft.lb
 Locked rotor torque : 210 %
 Breakdown torque : 240 %
 Rated speed : 1480 rpm

Moment of inertia (J) : 23.3 sq.ft.lb
 Duty cycle : Cont.(S1)
 Insulation class : F
 Service factor : 1.00
 Temperature rise : 105 K
 Design : B

Rev.	Changes Summary	Performed	Checked	Date
Performed by		Page		Revision
Checked by		15 / 36		
Date		13/04/2022		

THERMAL LIMIT CURVE



Three Phase Induction Motor - Squirrel Cage

Customer :

Product line : NEMA Premium Efficiency Three-Phase
 Product code : 12076589
 Catalog # : 07518ET3E365TC-W22

Performance : 230/460 V 60 Hz 4P

Rated current : 174/87.2 A	Moment of inertia (J) : 23.3 sq.ft.lb
LRC : 6.4	Duty cycle : Cont.(S1)
Rated torque : 221 ft.lb	Insulation class : F
Locked rotor torque : 240 %	Service factor : 1.25
Breakdown torque : 260 %	Temperature rise : 80 K
Rated speed : 1780 rpm	Design : B

Heating constant

Cooling constant

Rev.	Changes Summary	Performed	Checked	Date
Performed by			Page 16 / 36	Revision
Checked by				
Date	13/04/2022			

THERMAL LIMIT CURVE

Three Phase Induction Motor - Squirrel Cage



Customer : _____

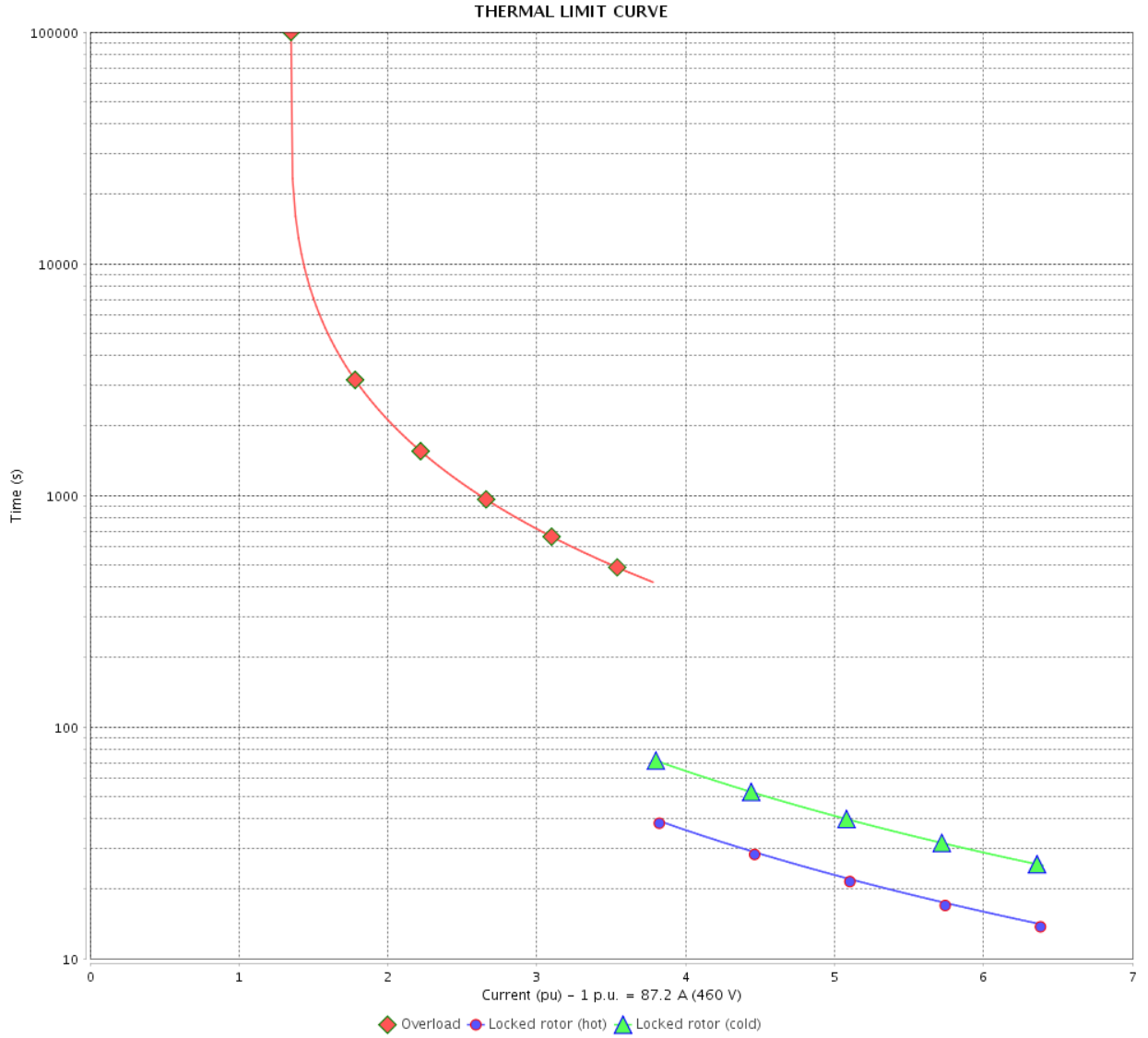

Rev.	Changes Summary	Performed	Checked	Date
Performed by		Page 17 / 36		Revision
Checked by				
Date				

THERMAL LIMIT CURVE

Three Phase Induction Motor - Squirrel Cage



Customer :

Product line : NEMA Premium Efficiency Three-Phase
Product code : 12076589
Catalog # : 07518ET3E365TC-W22

Performance : 380 V 50 Hz 4P IE3

Rated current	: 88.5 A	Moment of inertia (J)	: 23.3 sq.ft.lb
LRC	: 7.0	Duty cycle	: Cont.(S1)
Rated torque	: 213 ft.lb	Insulation class	: F
Locked rotor torque	: 210 %	Service factor	: 1.00
Breakdown torque	: 250 %	Temperature rise	: 80 K
Rated speed	: 1480 rpm	Design	: B

Heating constant

Cooling constant

Rev.	Changes Summary	Performed	Checked	Date
Performed by				
Checked by			Page	Revision
Date	13/04/2022		18 / 36	

THERMAL LIMIT CURVE

Three Phase Induction Motor - Squirrel Cage



Customer : _____

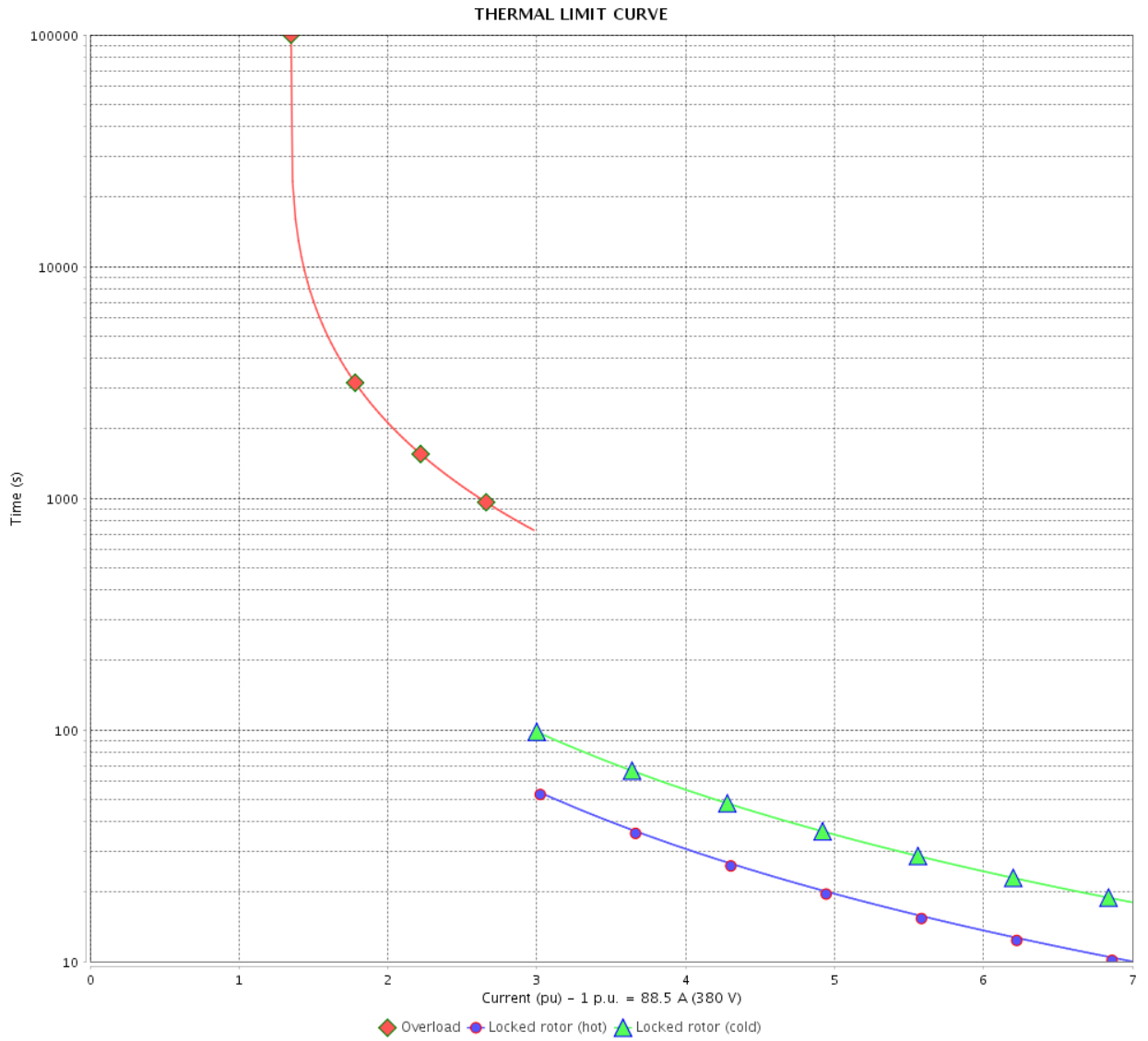

Rev.	Changes Summary	Performed	Checked	Date
Performed by		Page		Revision
Checked by		19 / 36		
Date		13/04/2022		

THERMAL LIMIT CURVE



Three Phase Induction Motor - Squirrel Cage

Customer :

Product line : NEMA Premium Efficiency Three-Phase
Product code : 12076589
Catalog # : 07518ET3E365TC-W22

Performance : 400 V 50 Hz 4P IE3

Rated current	: 84.9 A	Moment of inertia (J)	: 23.3 sq.ft.lb
LRC	: 7.5	Duty cycle	: Cont.(S1)
Rated torque	: 213 ft.lb	Insulation class	: F
Locked rotor torque	: 240 %	Service factor	: 1.00
Breakdown torque	: 280 %	Temperature rise	: 80 K
Rated speed	: 1480 rpm	Design	: B

Heating constant

Cooling constant

Rev.	Changes Summary	Performed	Checked	Date
Performed by				
Checked by			Page	Revision
Date	13/04/2022		20 / 36	

THERMAL LIMIT CURVE

Three Phase Induction Motor - Squirrel Cage



Customer : _____

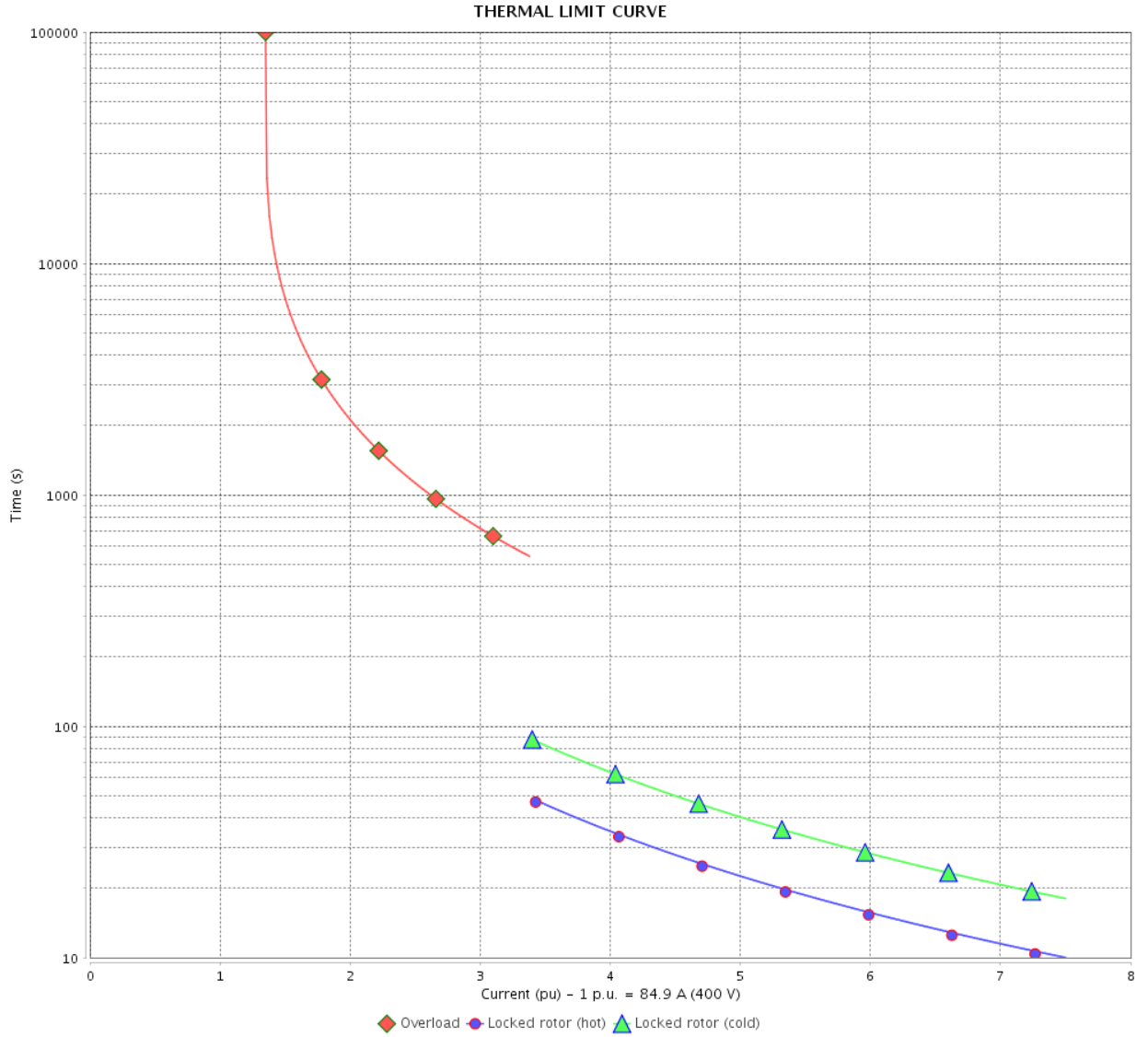

Rev.	Changes Summary	Performed	Checked	Date
Performed by		Page 21 / 36		Revision
Checked by				
Date				

THERMAL LIMIT CURVE

Three Phase Induction Motor - Squirrel Cage



Customer :

Product line : NEMA Premium Efficiency Three-Phase
Product code : 12076589
Catalog # : 07518ET3E365TC-W22

Performance : 415 V 50 Hz 4P IE3

Rated current	: 82.7 A	Moment of inertia (J)	: 23.3 sq.ft.lb
LRC	: 8.0	Duty cycle	: Cont.(S1)
Rated torque	: 212 ft.lb	Insulation class	: F
Locked rotor torque	: 260 %	Service factor	: 1.00
Breakdown torque	: 310 %	Temperature rise	: 80 K
Rated speed	: 1485 rpm	Design	: B

Heating constant

Cooling constant

Rev.	Changes Summary	Performed	Checked	Date
Performed by				
Checked by			Page	Revision
Date	13/04/2022		22 / 36	

THERMAL LIMIT CURVE

Three Phase Induction Motor - Squirrel Cage



Customer : _____

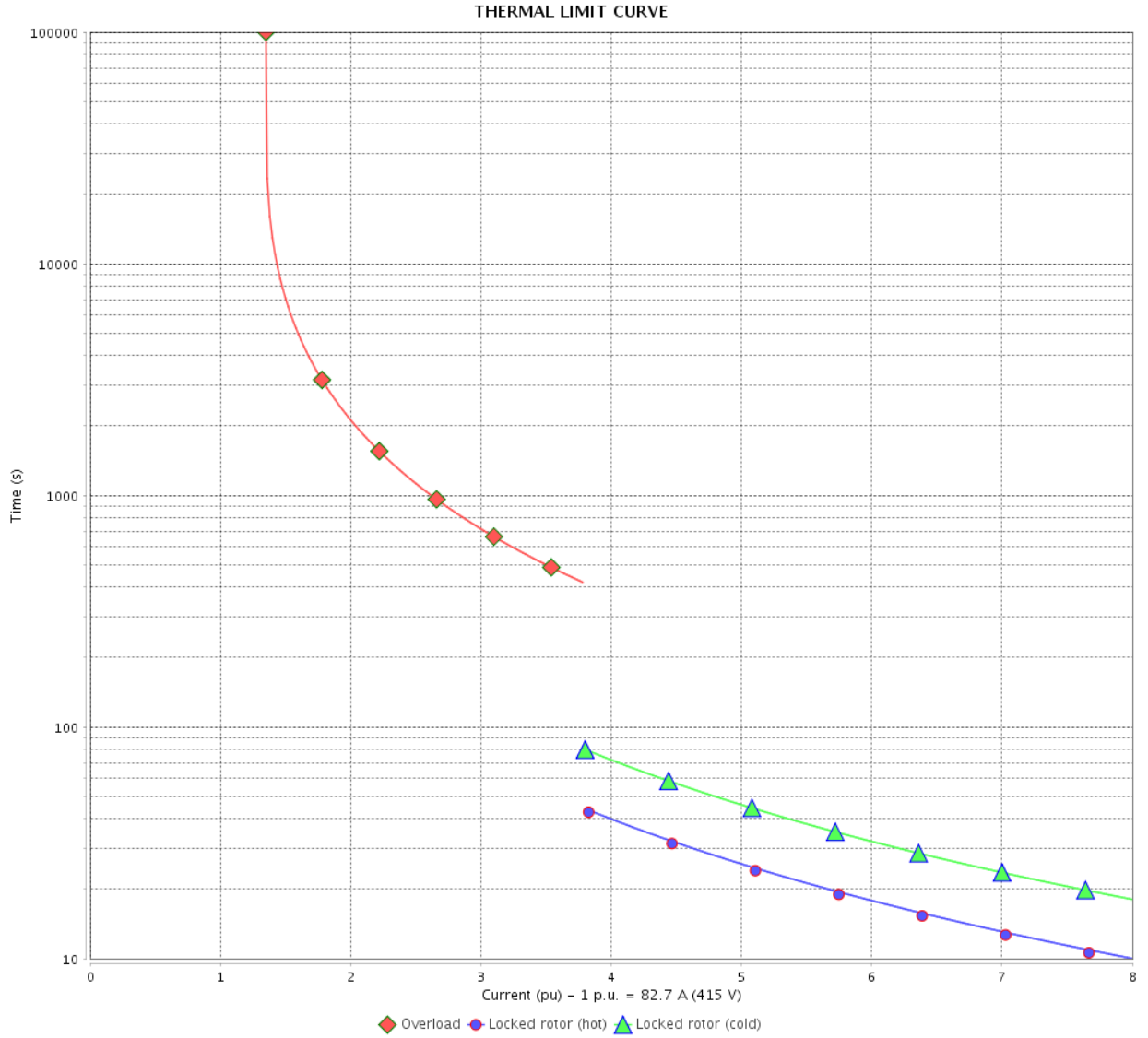

Rev.	Changes Summary	Performed	Checked	Date
Performed by		Page 23 / 36		Revision
Checked by				
Date				

THERMAL LIMIT CURVE



Three Phase Induction Motor - Squirrel Cage

Customer :

Product line : NEMA Premium Efficiency Three-Phase
Product code : 12076589
Catalog # : 07518ET3E365TC-W22

Performance : 380 V 50 Hz 4P IE2

Rated current	: 106 A	Moment of inertia (J)	: 23.3 sq.ft.lb
LRC	: 5.1	Duty cycle	: Cont.(S1)
Rated torque	: 268 ft.lb	Insulation class	: F
Locked rotor torque	: 170 %	Service factor	: 1.00
Breakdown torque	: 200 %	Temperature rise	: 105 K
Rated speed	: 1470 rpm	Design	: B

Heating constant

Cooling constant

Rev.	Changes Summary	Performed	Checked	Date
Performed by				
Checked by			Page	Revision
Date	13/04/2022		24 / 36	

THERMAL LIMIT CURVE

Three Phase Induction Motor - Squirrel Cage



Customer : _____

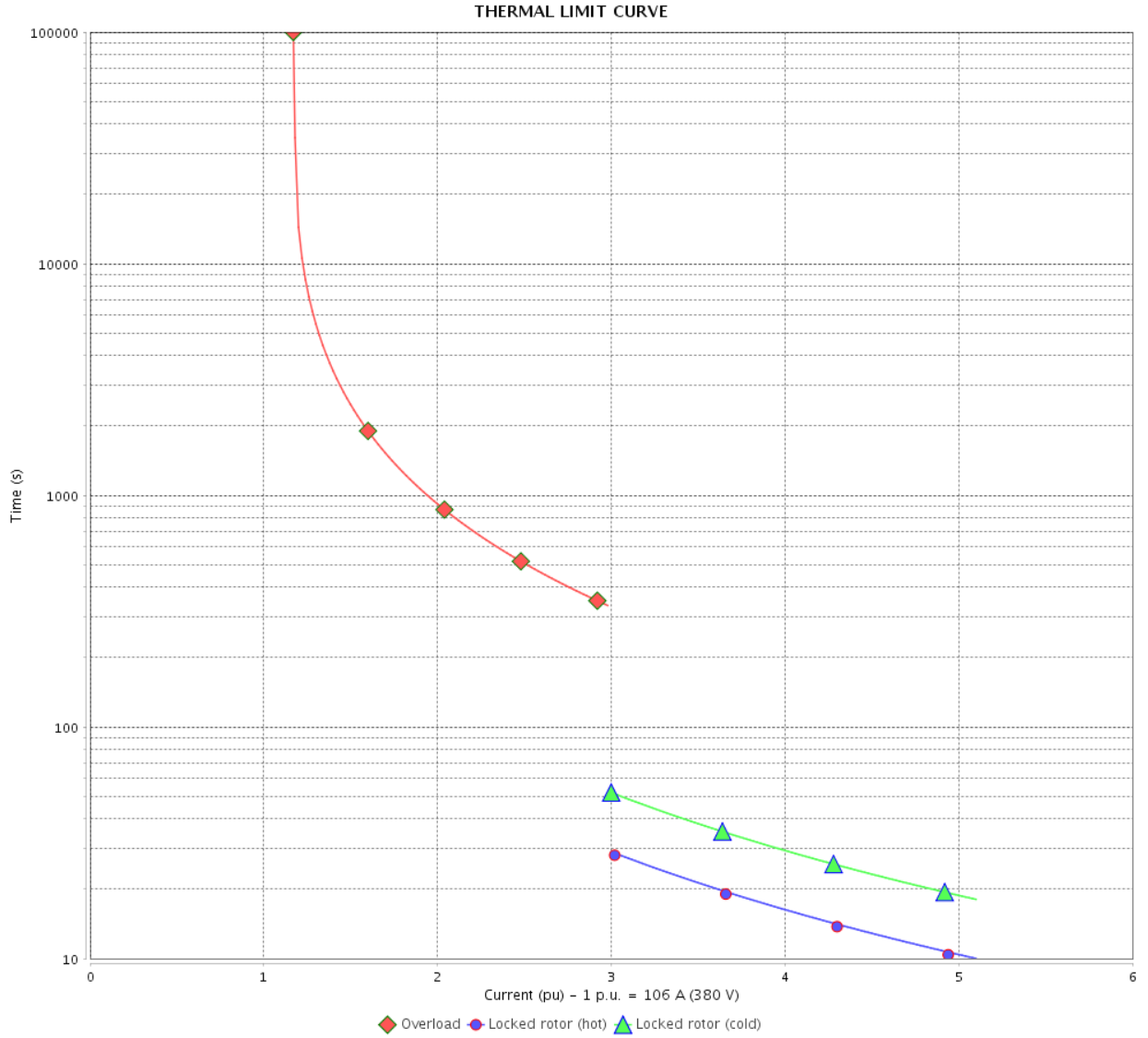

Rev.	Changes Summary	Performed	Checked	Date
Performed by		Page 25 / 36 Revision		
Checked by				
Date				

THERMAL LIMIT CURVE



Three Phase Induction Motor - Squirrel Cage

Customer :

Product line : NEMA Premium Efficiency Three-Phase
Product code : 12076589
Catalog # : 07518ET3E365TC-W22

Performance : 400 V 50 Hz 4P IE2

Rated current	: 102 A	Moment of inertia (J)	: 23.3 sq.ft.lb
LRC	: 5.6	Duty cycle	: Cont.(S1)
Rated torque	: 267 ft.lb	Insulation class	: F
Locked rotor torque	: 200 %	Service factor	: 1.00
Breakdown torque	: 220 %	Temperature rise	: 105 K
Rated speed	: 1475 rpm	Design	: B

Heating constant

Cooling constant

Rev.	Changes Summary	Performed	Checked	Date
Performed by				
Checked by			Page	Revision
Date	13/04/2022		26 / 36	

THERMAL LIMIT CURVE

Three Phase Induction Motor - Squirrel Cage



Customer : _____

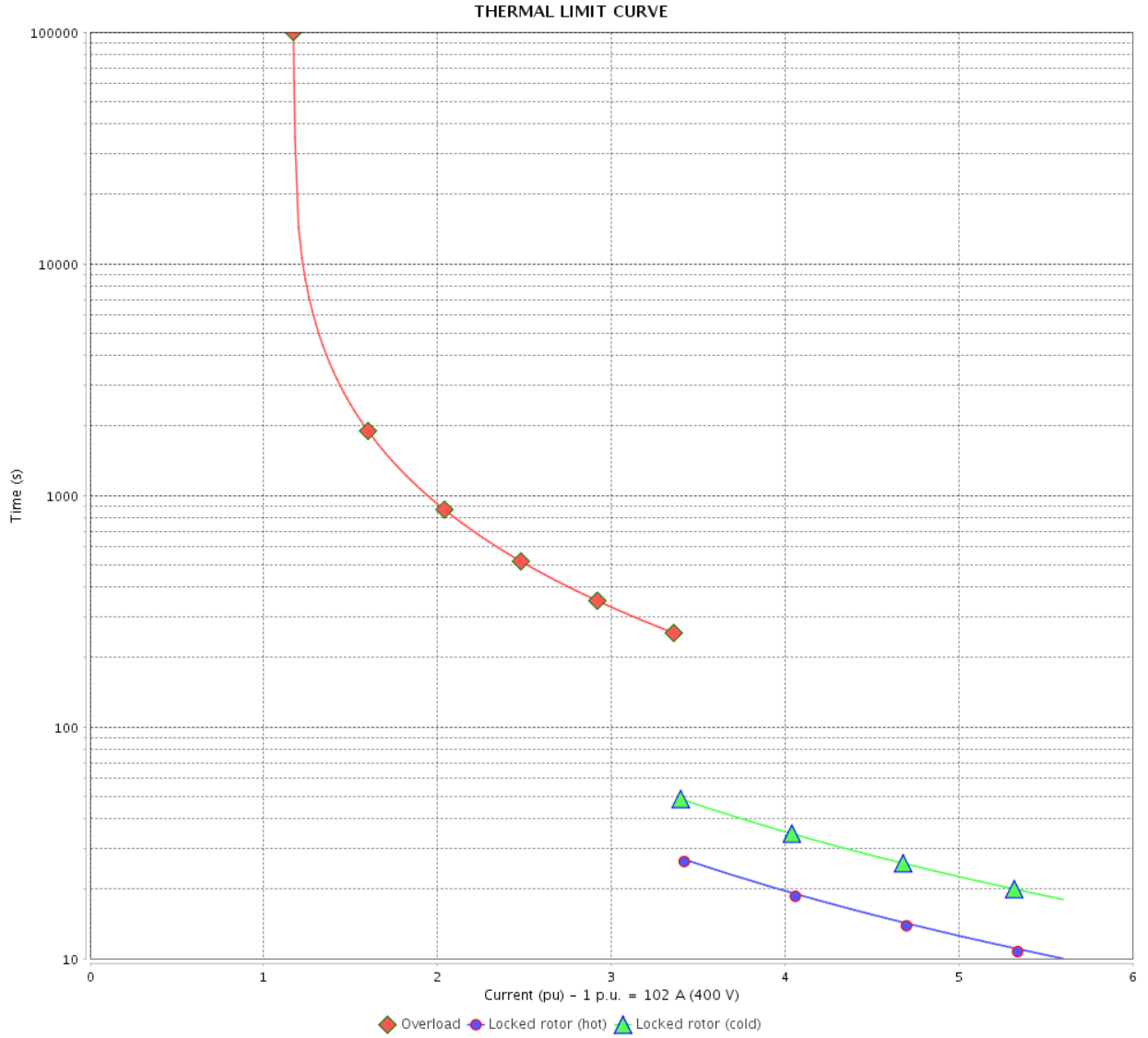

Rev.	Changes Summary	Performed	Checked	Date
Performed by		Page 27 / 36		Revision
Checked by				
Date				

THERMAL LIMIT CURVE

Three Phase Induction Motor - Squirrel Cage



Customer :

Product line : NEMA Premium Efficiency Three-Phase
Product code : 12076589
Catalog # : 07518ET3E365TC-W22

Performance : 415 V 50 Hz 4P IE2

Rated current	: 98.7 A	Moment of inertia (J)	: 23.3 sq.ft.lb
LRC	: 6.1	Duty cycle	: Cont.(S1)
Rated torque	: 266 ft.lb	Insulation class	: F
Locked rotor torque	: 210 %	Service factor	: 1.00
Breakdown torque	: 240 %	Temperature rise	: 105 K
Rated speed	: 1480 rpm	Design	: B

Heating constant

Cooling constant

Rev.	Changes Summary	Performed	Checked	Date
Performed by				
Checked by			Page	Revision
Date	13/04/2022		28 / 36	

THERMAL LIMIT CURVE

Three Phase Induction Motor - Squirrel Cage



Customer : _____

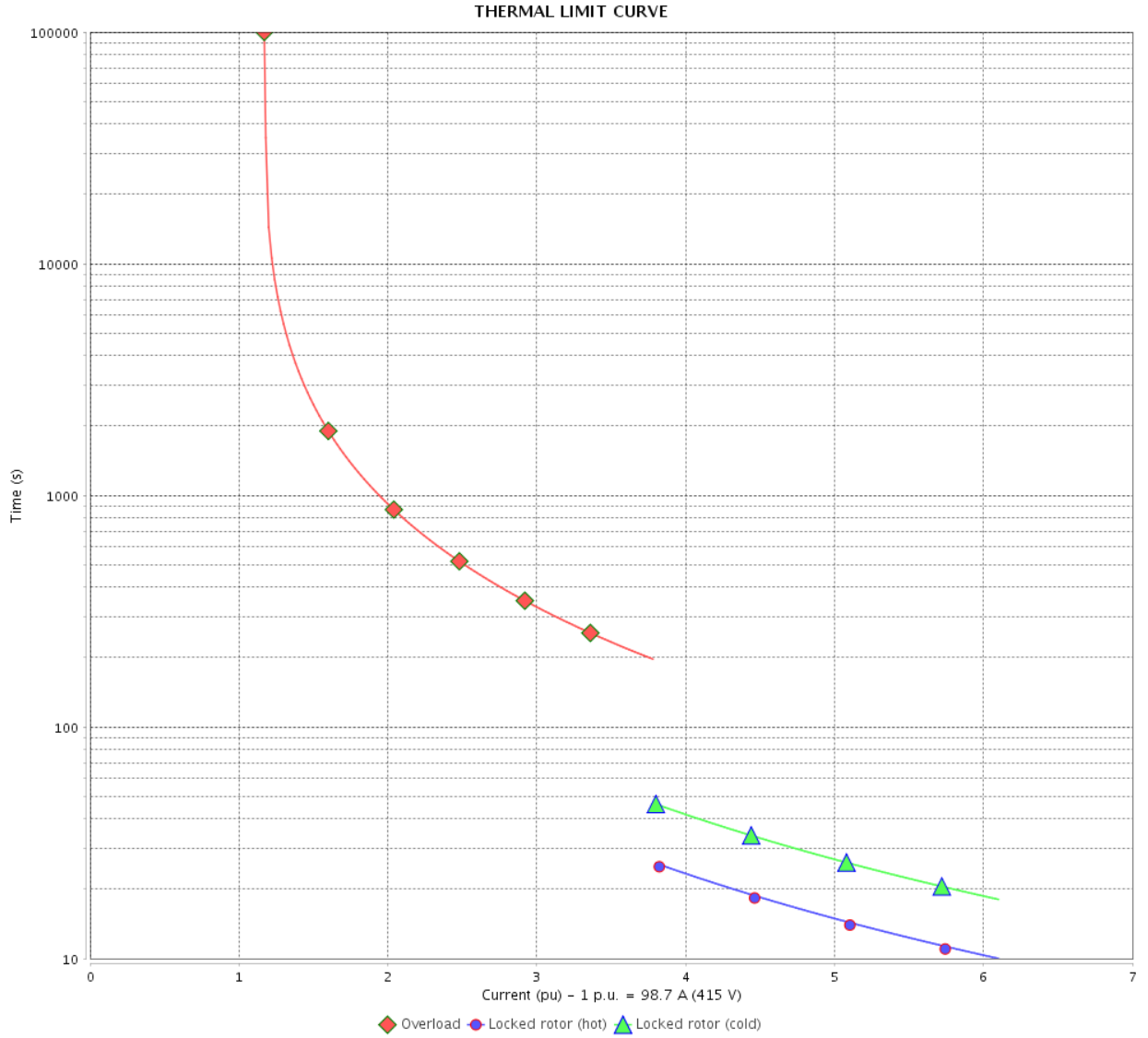

Rev.	Changes Summary	Performed	Checked	Date
Performed by		Page 29 / 36		Revision
Checked by				
Date				

VFD OPERATION CURVE

Three Phase Induction Motor - Squirrel Cage



Customer :

Product line : NEMA Premium Efficiency Three-Phase

Product code : 12076589

Catalog # : 07518ET3E365TC-W22

VFD OPERATION CURVE

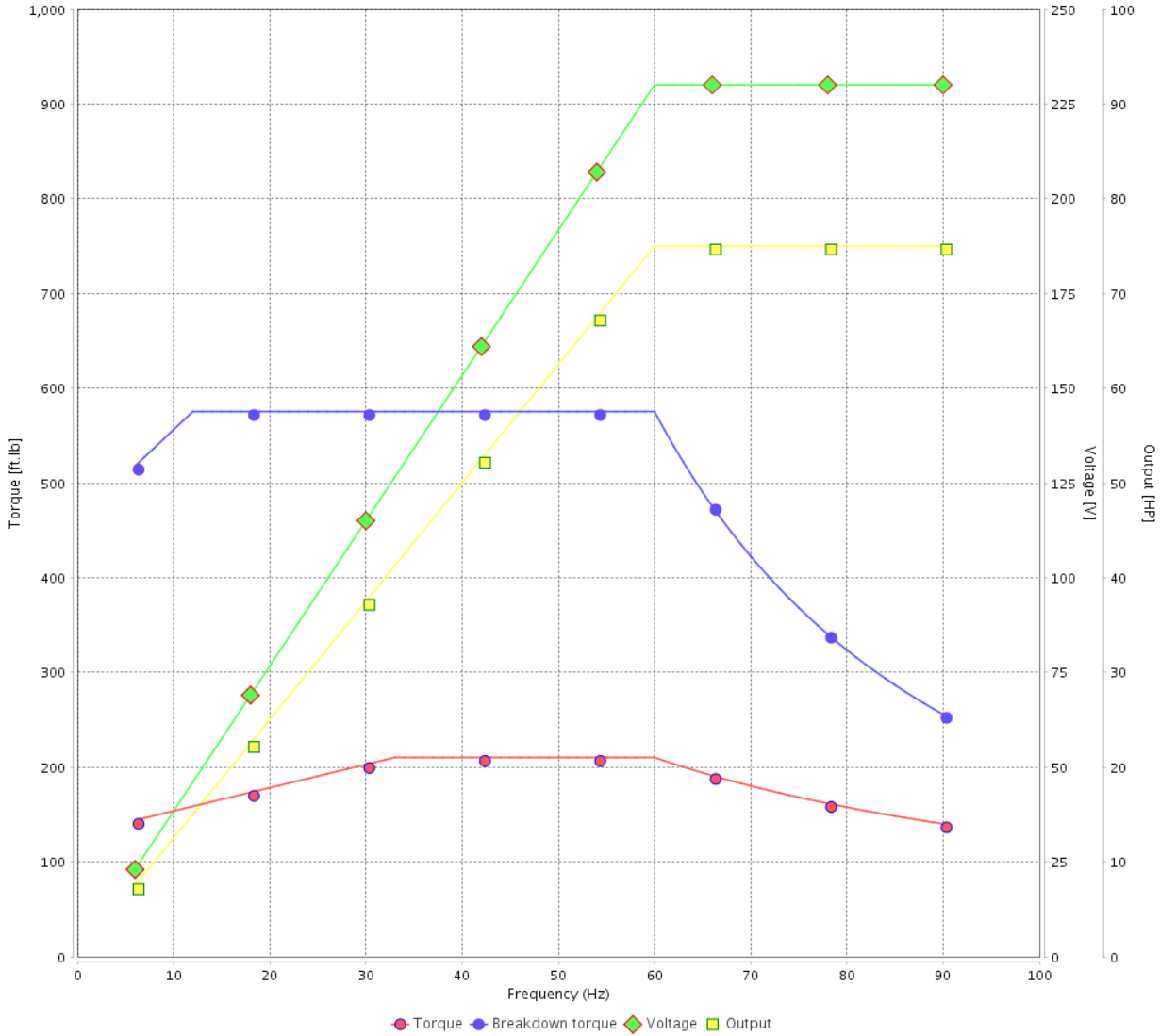

Performance : 230/460 V 60 Hz 4P

Rated current : 174/87.2 A
 LRC : 6.4
 Rated torque : 221 ft.lb
 Locked rotor torque : 240 %
 Breakdown torque : 260 %
 Rated speed : 1780 rpm

Moment of inertia (J) : 23.3 sq.ft.lb
 Duty cycle : Cont.(S1)
 Insulation class : F
 Service factor : 1.25
 Temperature rise : 80 K
 Design : B

Rev.	Changes Summary	Performed	Checked	Date
Performed by			Page 30 / 36	Revision
Checked by				
Date	13/04/2022			

VFD OPERATION CURVE

Three Phase Induction Motor - Squirrel Cage



Customer :

Product line : NEMA Premium Efficiency Three-Phase
 Product code : 12076589
 Catalog # : 07518ET3E365TC-W22

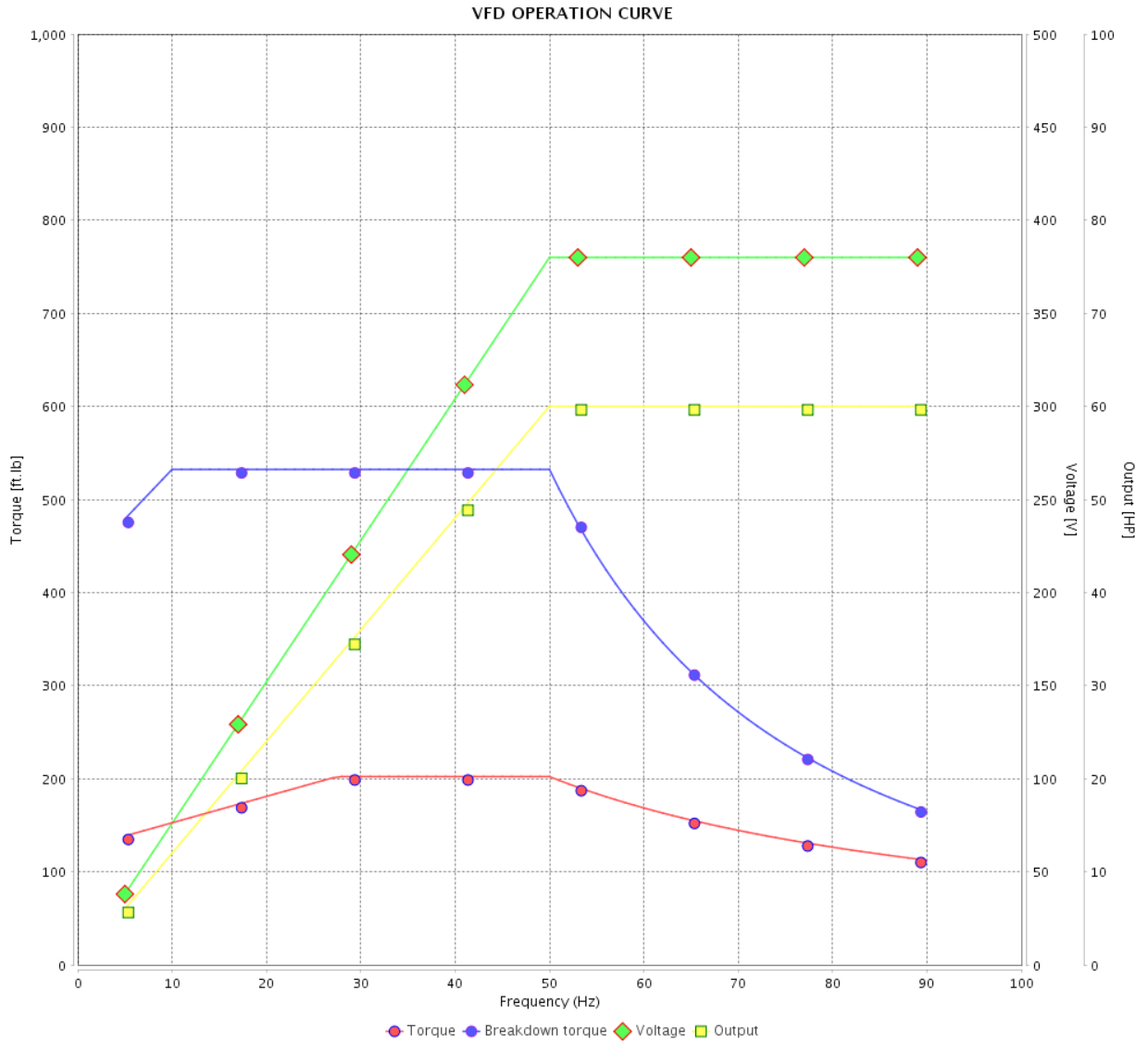

Performance : 380 V 50 Hz 4P IE3

Rated current : 88.5 A	Moment of inertia (J) : 23.3 sq.ft.lb
LRC : 7.0	Duty cycle : Cont.(S1)
Rated torque : 213 ft.lb	Insulation class : F
Locked rotor torque : 210 %	Service factor : 1.00
Breakdown torque : 250 %	Temperature rise : 80 K
Rated speed : 1480 rpm	Design : B

Rev.	Changes Summary	Performed	Checked	Date
Performed by		Page		Revision
Checked by		31 / 36		
Date		13/04/2022		

VFD OPERATION CURVE

Three Phase Induction Motor - Squirrel Cage



Customer : _____

Product line : NEMA Premium Efficiency Three-Phase

Product code : 12076589

Catalog # : 07518ET3E365TC-W22

VFD OPERATION CURVE

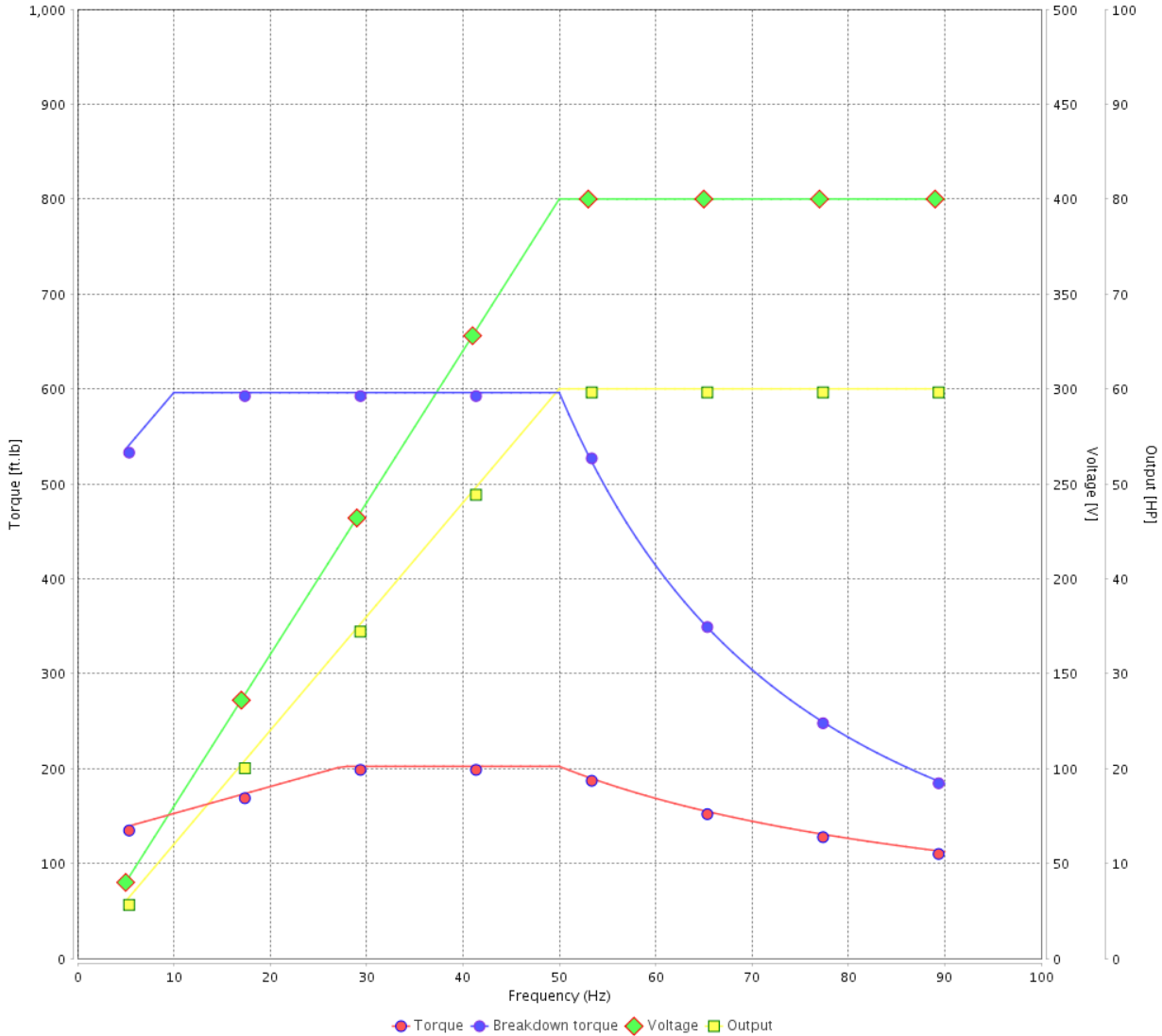

Performance : 400 V 50 Hz 4P IE3

Rated current : 84.9 A
 LRC : 7.5
 Rated torque : 213 ft.lb
 Locked rotor torque : 240 %
 Breakdown torque : 280 %
 Rated speed : 1480 rpm

Moment of inertia (J) : 23.3 sq.ft.lb
 Duty cycle : Cont.(S1)
 Insulation class : F
 Service factor : 1.00
 Temperature rise : 80 K
 Design : B

Rev.	Changes Summary	Performed	Checked	Date
Performed by			Page 32 / 36	Revision
Checked by				
Date	13/04/2022			

VFD OPERATION CURVE

Three Phase Induction Motor - Squirrel Cage



Customer :

Product line : NEMA Premium Efficiency Three-Phase

Product code : 12076589

Catalog # : 07518ET3E365TC-W22

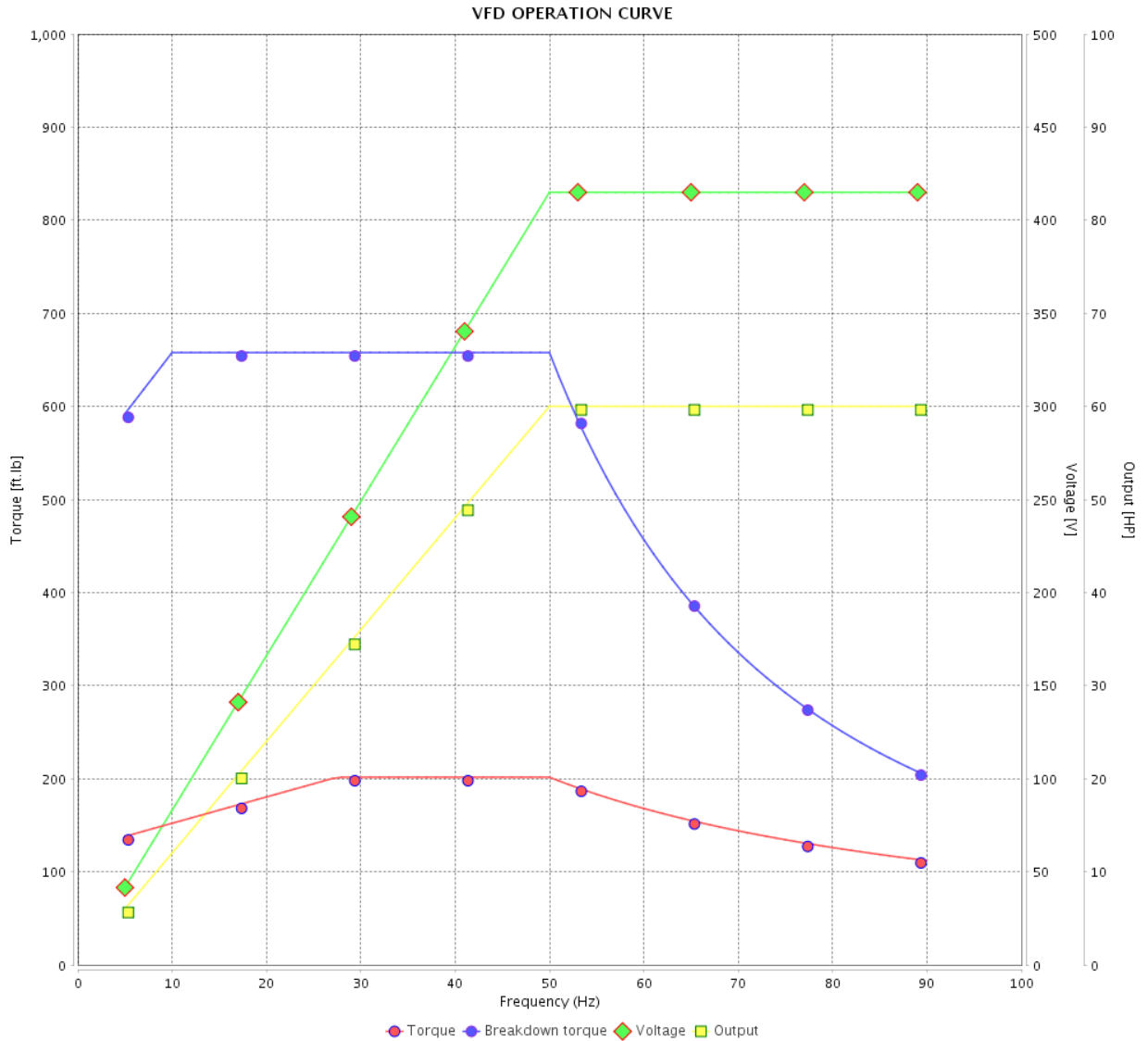

Performance : 415 V 50 Hz 4P IE3

Rated current : 82.7 A
 LRC : 8.0
 Rated torque : 212 ft.lb
 Locked rotor torque : 260 %
 Breakdown torque : 310 %
 Rated speed : 1485 rpm

Moment of inertia (J) : 23.3 sq.ft.lb
 Duty cycle : Cont.(S1)
 Insulation class : F
 Service factor : 1.00
 Temperature rise : 80 K
 Design : B

Rev.	Changes Summary	Performed	Checked	Date
Performed by			Page 33 / 36	Revision
Checked by				
Date	13/04/2022			

VFD OPERATION CURVE

Three Phase Induction Motor - Squirrel Cage



Customer :

Product line : NEMA Premium Efficiency Three-Phase

Product code : 12076589

Catalog # : 07518ET3E365TC-W22

VFD OPERATION CURVE

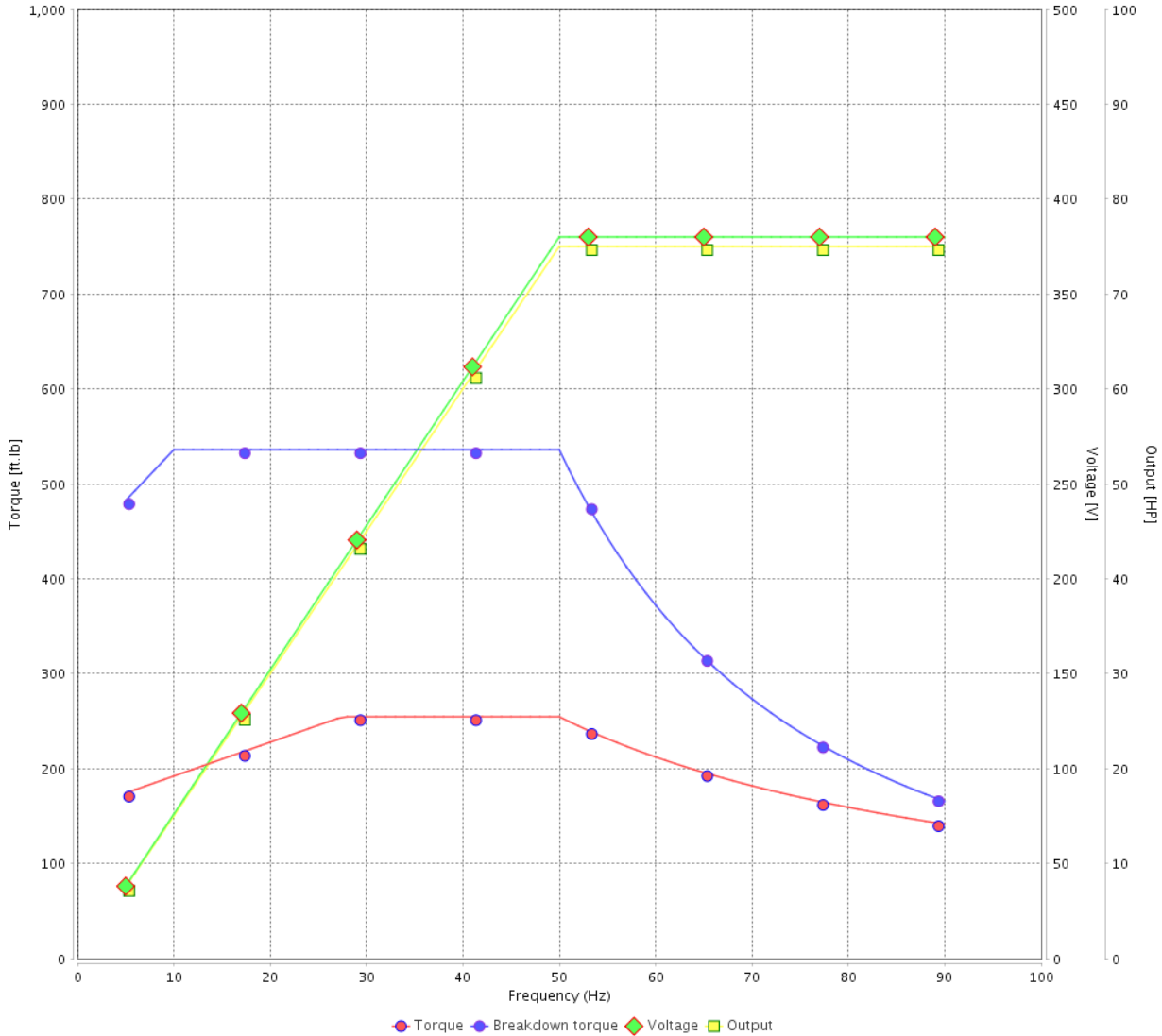

Performance : 380 V 50 Hz 4P IE2

Rated current : 106 A
 LRC : 5.1
 Rated torque : 268 ft.lb
 Locked rotor torque : 170 %
 Breakdown torque : 200 %
 Rated speed : 1470 rpm

Moment of inertia (J) : 23.3 sq.ft.lb
 Duty cycle : Cont.(S1)
 Insulation class : F
 Service factor : 1.00
 Temperature rise : 105 K
 Design : B

Rev.	Changes Summary	Performed	Checked	Date
Performed by			Page 34 / 36	Revision
Checked by				
Date	13/04/2022			

VFD OPERATION CURVE

Three Phase Induction Motor - Squirrel Cage



Customer :

Product line : NEMA Premium Efficiency Three-Phase

Product code : 12076589

Catalog # : 07518ET3E365TC-W22

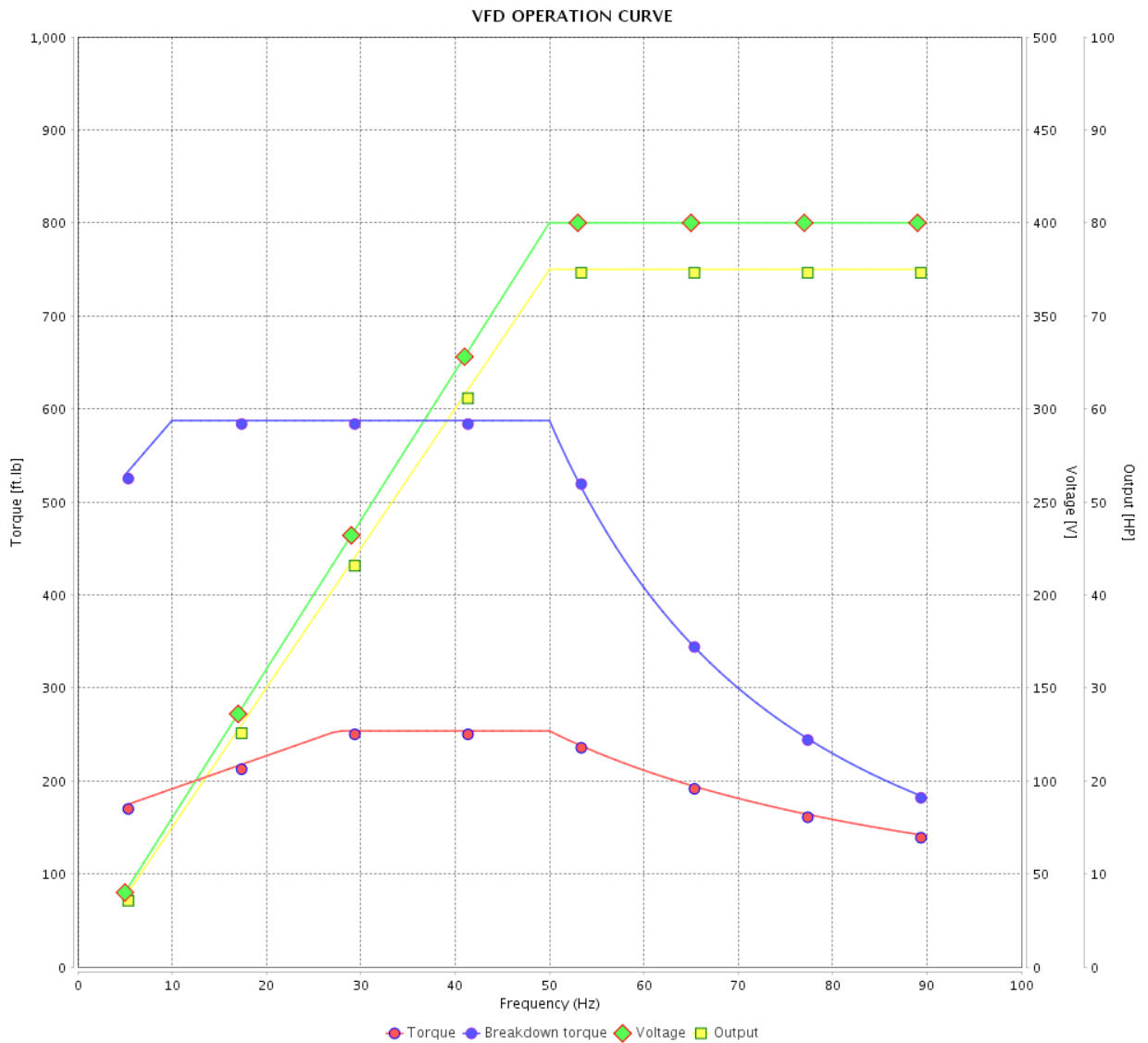

Performance : 400 V 50 Hz 4P IE2

Rated current : 102 A
 LRC : 5.6
 Rated torque : 267 ft.lb
 Locked rotor torque : 200 %
 Breakdown torque : 220 %
 Rated speed : 1475 rpm

Moment of inertia (J) : 23.3 sq.ft.lb
 Duty cycle : Cont.(S1)
 Insulation class : F
 Service factor : 1.00
 Temperature rise : 105 K
 Design : B

Rev.	Changes Summary	Performed	Checked	Date
Performed by			Page 35 / 36	Revision
Checked by				
Date	13/04/2022			

VFD OPERATION CURVE

Three Phase Induction Motor - Squirrel Cage



Customer :

Product line : NEMA Premium Efficiency Three-Phase

Product code : 12076589

Catalog # : 07518ET3E365TC-W22

VFD OPERATION CURVE

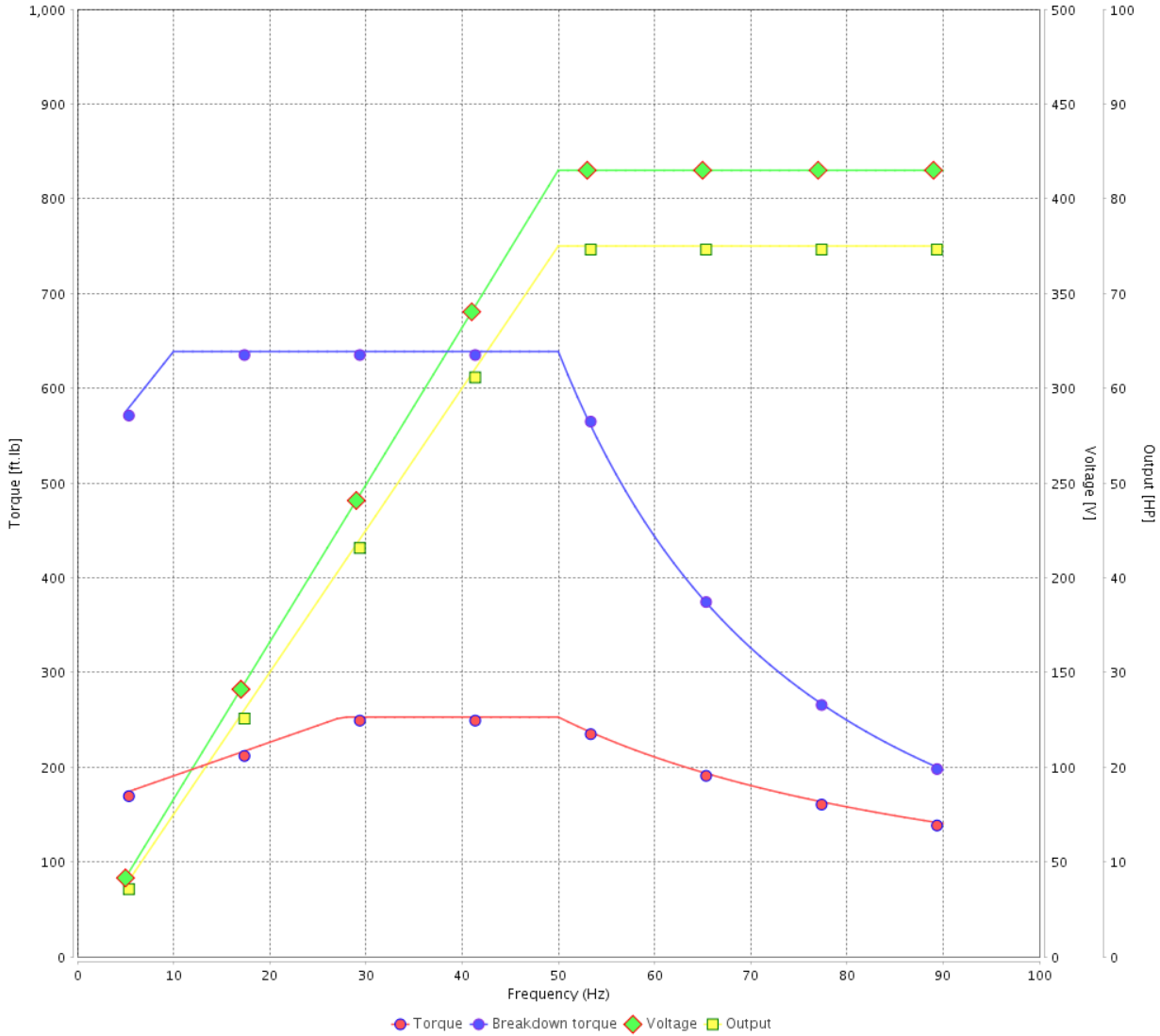

Performance : 415 V 50 Hz 4P IE2

Rated current : 98.7 A
 LRC : 6.1
 Rated torque : 266 ft.lb
 Locked rotor torque : 210 %
 Breakdown torque : 240 %
 Rated speed : 1480 rpm

Moment of inertia (J) : 23.3 sq.ft.lb
 Duty cycle : Cont.(S1)
 Insulation class : F
 Service factor : 1.00
 Temperature rise : 105 K
 Design : B

Rev.	Changes Summary	Performed	Checked	Date
Performed by		Page		Revision
Checked by		36 / 36		
Date	13/04/2022			

1 2 3 4 5 6

A

B

C

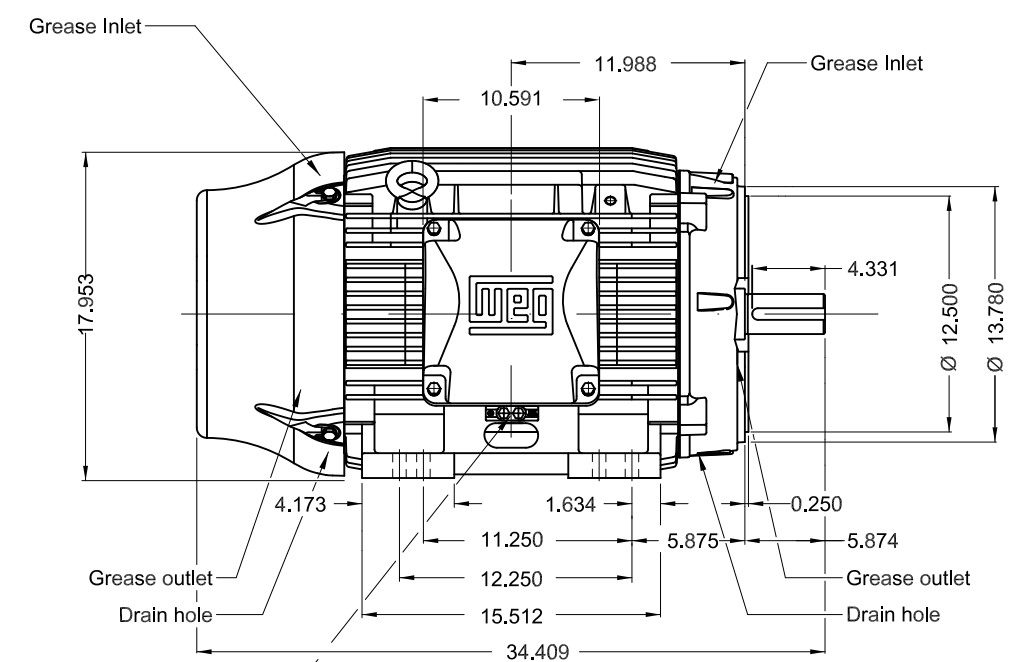
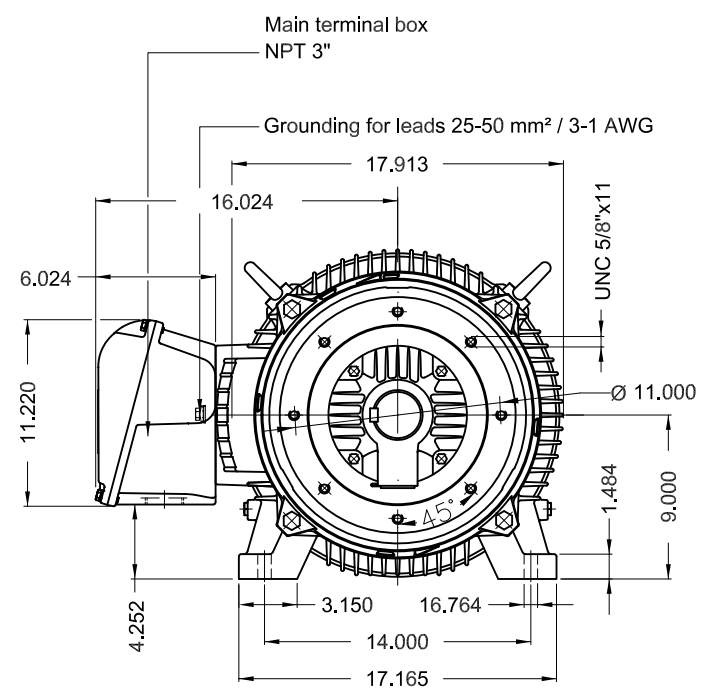

Grounding for leads 25-185 mm² / 3AWG-350MCM

D

E

Without vertical jackscrews
 Color RAL 5009
 Painting plan 203A
 Mounting B34R(D)

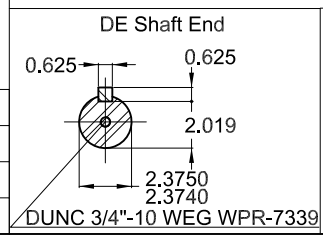

75 HP 04 Poles 60 Hz A

ECM	LOC	SUMMARY OF MODIFICATIONS	EXECUTED	CHECKED	RELEASED	DATE	VER
EXECUTED	PIRWBUSER	THREE PH. MOTOR W22 PREM. EFF.					
CHECKED		FRAME 364/5TC IP55 TEFC					
RELEASED							
REL DT.	WMO	Jaragua do Sul	Product Engineering	SHEET	1 / 1		

PREVIEW
 WDD



MADE IN MEXICO
12076589



FOR SAFE AREA
Mod.TE1BFOXON
CC029A





For use on 60Hz
Class I, Div 2, Gr A, B, C and D - T3
Class I, Zone 2, IIC - T3
Class II, Div 2, Gr F and G - T4
For use on PWM: Gr. A, B, C, D and F,
VT 1000:1, CT 20:1, 1.00SF - T3A

MODEL 07518ET3E365TC-W22

Inverter Duty Motor
Severe Duty

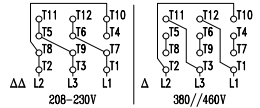
PH3	60Hz	Fr. 364/5TC	1000m.a.s.l.	IP55	TEFC	953lb
V	230/460			A	174/87.2	
HP	75			kW	55	
SF	1.25			SFA	218/109	
RPM	1780			PF	0.83	
AMB	40°C			INS cl.	F DT80K	NEMA NOM EFF 95.4%
DUTY CONT.				DES B	Code G	
USABLE @208V	186A	SF 1.10	SFA 205			
75HP	55kW	50Hz	380V	106A	1470RPM	SF 1.00 EFF 93.6% (IE2)



 → 6314-C3 (27g)
 → 6314-C3 (27g)

 MOBIL POLYREX EM (12000h)