

DATA SHEET

Three Phase Induction Motor - Squirrel Cage



Customer :					
Product line		: W40 NEMA Premium Efficiency Three-Phase	Product code :	14046018	
			Catalog # :	10012OT3G444T-W40	
Frame		: 444/5T	Cooling method : IC01 - ODP		
Insulation class		: F	Mounting : F-1		
Duty cycle		: Cont.(S1)	Rotation ¹ : Both (CW and CCW)		
Ambient temperature		: -20°C to +40°C	Starting method : Direct On Line		
Altitude		: 1000 m.a.s.l.	Approx. weight ² : 1337 lb		
Protection degree		: IP23	Moment of inertia (J) : 60.6 sq.ft.lb		
Design		: B			
Output [HP]	100	75	75	75	
Poles	6	6	6	6	
Frequency [Hz]	60	50	50	50	
Rated voltage [V]	460	380	400	415	
Rated current [A]	127	115	112	111	
L. R. Amperes [A]	775	794	773	799	
LRC [A]	6.1x(Code G)	6.9x(Code H)	6.9x(Code J)	7.2x(Code J)	
No load current [A]	56.5	55.8	60.2	63.7	
Rated speed [RPM]	1190	990	990	990	
Slip [%]	0.83	1.00	1.00	1.00	
Rated torque [ft.lb]	441	398	398	398	
Locked rotor torque [%]	200	220	240	260	
Breakdown torque [%]	250	250	270	290	
Service factor	1.25	1.00	1.00	1.00	
Temperature rise	80 K	80 K	80 K	80 K	
Locked rotor time	23s (cold) 13s (hot)	25s (cold) 14s (hot)	25s (cold) 14s (hot)	23s (cold) 13s (hot)	
Noise level ²	69.0 dB(A)				
Efficiency (%)	25%	94.4	93.6	92.8	
	50%	94.5	93.7	93.0	
	75%	95.0	94.1	94.1	
	100%	95.0	94.1	94.1	
Power Factor	25%	0.37	0.34	0.31	
	50%	0.61	0.56	0.53	
	75%	0.71	0.69	0.65	
	100%	0.78	0.77	0.75	
Bearing type		Drive end : 6319 C3 Non drive end : 6314 C3	Foundation loads		
Sealing		Without Bearing Seal	Max. traction : 2407 lb Max. compression : 3744 lb		
Lubrication interval		20000 h	20000 h		
Lubricant amount		45 g	27 g		
Lubricant type		Mobil Polyrex EM			
Notes					
This revision replaces and cancel the previous one, which must be eliminated. (1) Looking the motor from the shaft end. (2) Measured at 1m and with tolerance of +3dB(A). (3) Approximate weight subject to changes after manufacturing process. (4) At 100% of full load.			These are average values based on tests with sinusoidal power supply, subject to the tolerances stipulated in NEMA MG-1.		
Rev.	Changes Summary		Performed	Checked	Date
Performed by					
Checked by				Page	Revision
Date	13/04/2022			1 / 21	

TORQUE AND CURRENT VS SPEED CURVE

Three Phase Induction Motor - Squirrel Cage



Customer :

Product line : W40 NEMA Premium Efficiency
Three-Phase

Product code : 14046018

Catalog # : 100120T3G444T-W40

TORQUE AND CURRENT VS SPEED CURVE

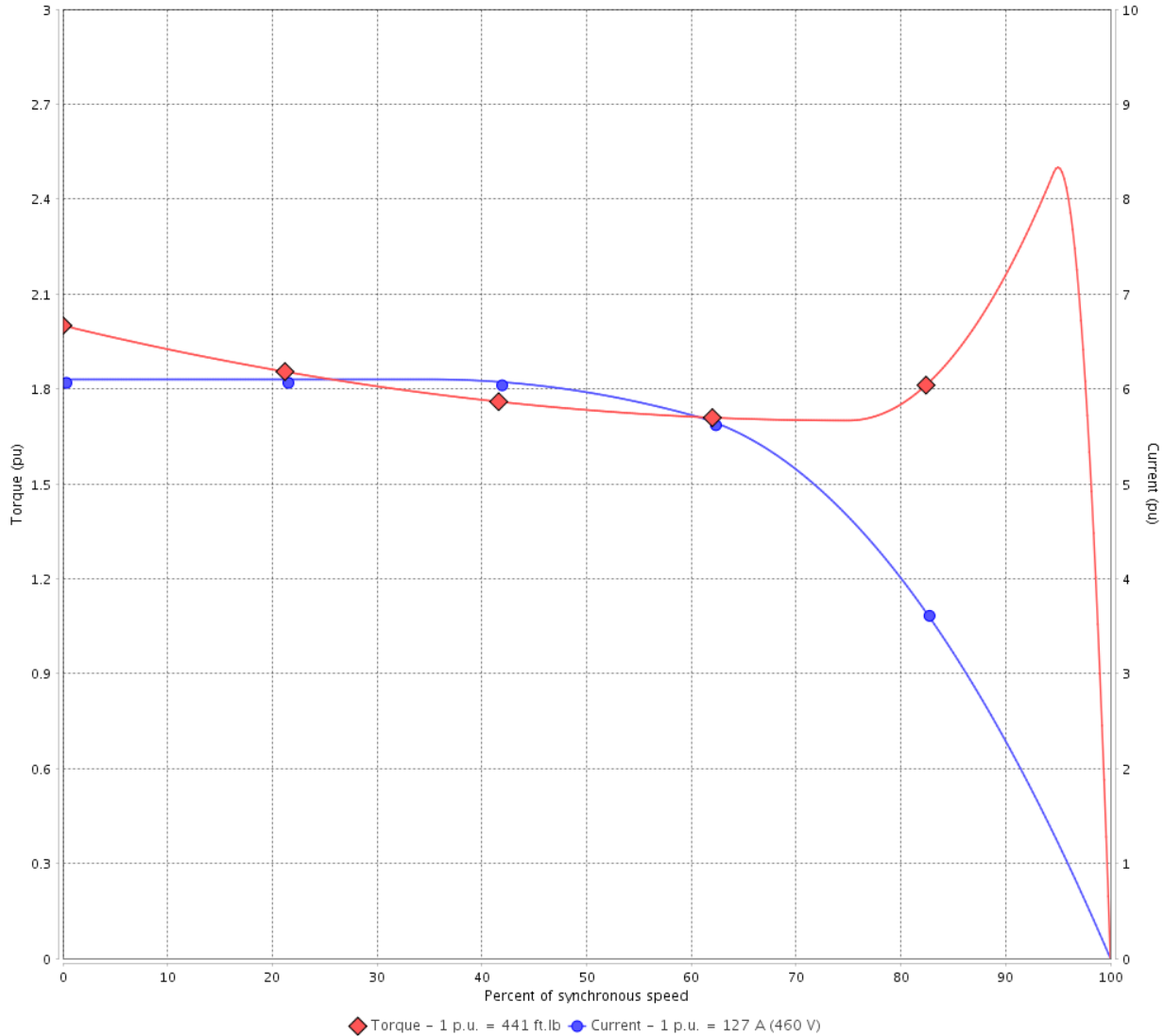

Performance : 460 V 60 Hz 6P

Rated current	: 127 A	Moment of inertia (J)	: 60.6 sq.ft.lb
LRC	: 6.1	Duty cycle	: Cont.(S1)
Rated torque	: 441 ft.lb	Insulation class	: F
Locked rotor torque	: 200 %	Service factor	: 1.25
Breakdown torque	: 250 %	Temperature rise	: 80 K
Rated speed	: 1190 rpm	Design	: B

Locked rotor time : 23s (cold) 13s (hot)

Rev.	Changes Summary	Performed	Checked	Date
Performed by			Page 2 / 21	Revision
Checked by				
Date	13/04/2022			

TORQUE AND CURRENT VS SPEED CURVE



Three Phase Induction Motor - Squirrel Cage

Customer :

Product line : W40 NEMA Premium Efficiency
Three-Phase

Product code : 14046018

Catalog # : 10012OT3G444T-W40

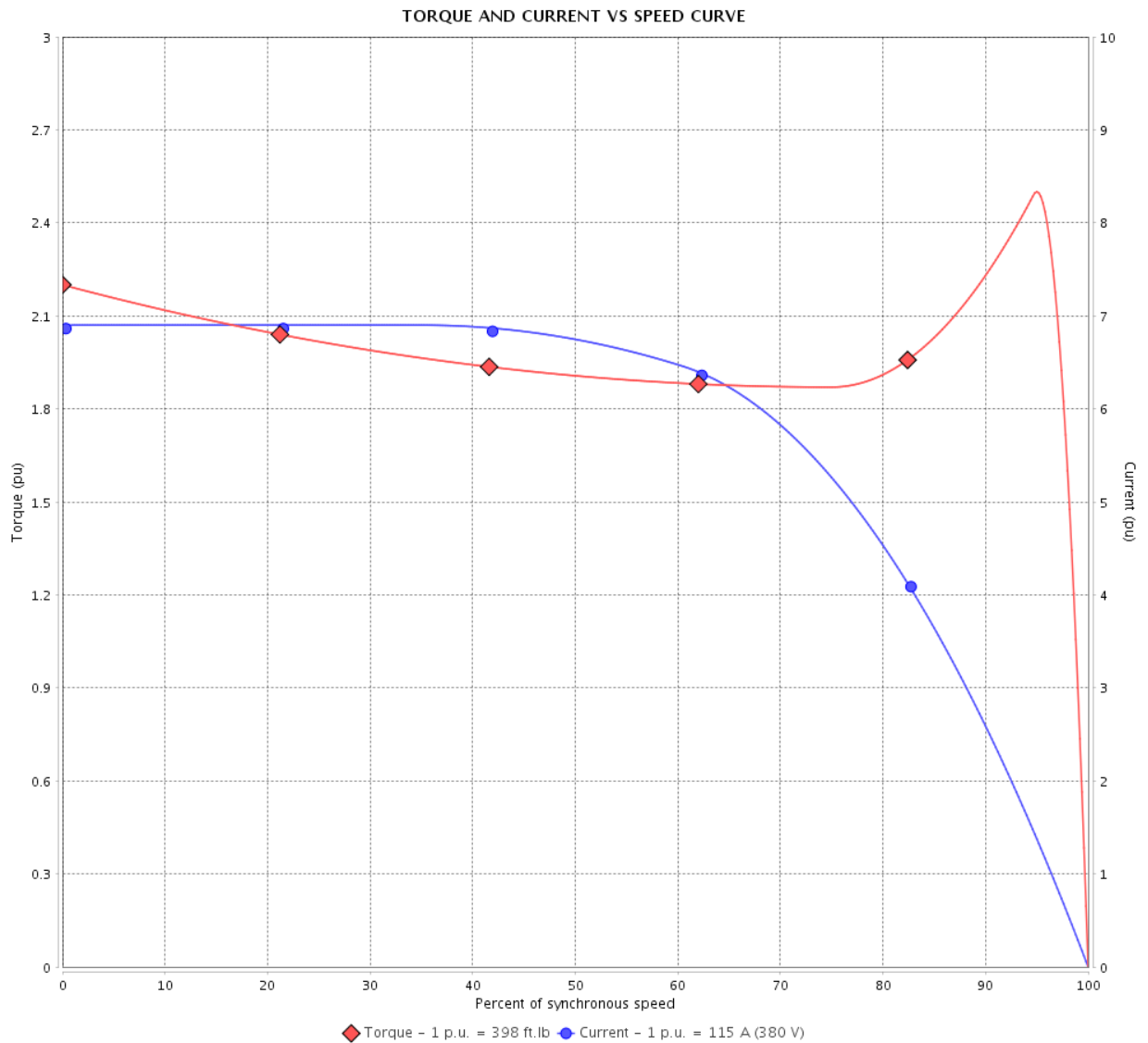

Performance : 380 V 50 Hz 6P IE3

Rated current	: 115 A	Moment of inertia (J)	: 60.6 sq.ft.lb
LRC	: 6.9	Duty cycle	: Cont.(S1)
Rated torque	: 398 ft.lb	Insulation class	: F
Locked rotor torque	: 220 %	Service factor	: 1.00
Breakdown torque	: 250 %	Temperature rise	: 80 K
Rated speed	: 990 rpm	Design	: B

Locked rotor time : 25s (cold) 14s (hot)

Rev.	Changes Summary	Performed	Checked	Date
Performed by			Page 3 / 21	Revision
Checked by				
Date	13/04/2022			

TORQUE AND CURRENT VS SPEED CURVE

Three Phase Induction Motor - Squirrel Cage



Customer :

Product line : W40 NEMA Premium Efficiency
Three-Phase

Product code : 14046018

Catalog # : 10012OT3G444T-W40

TORQUE AND CURRENT VS SPEED CURVE

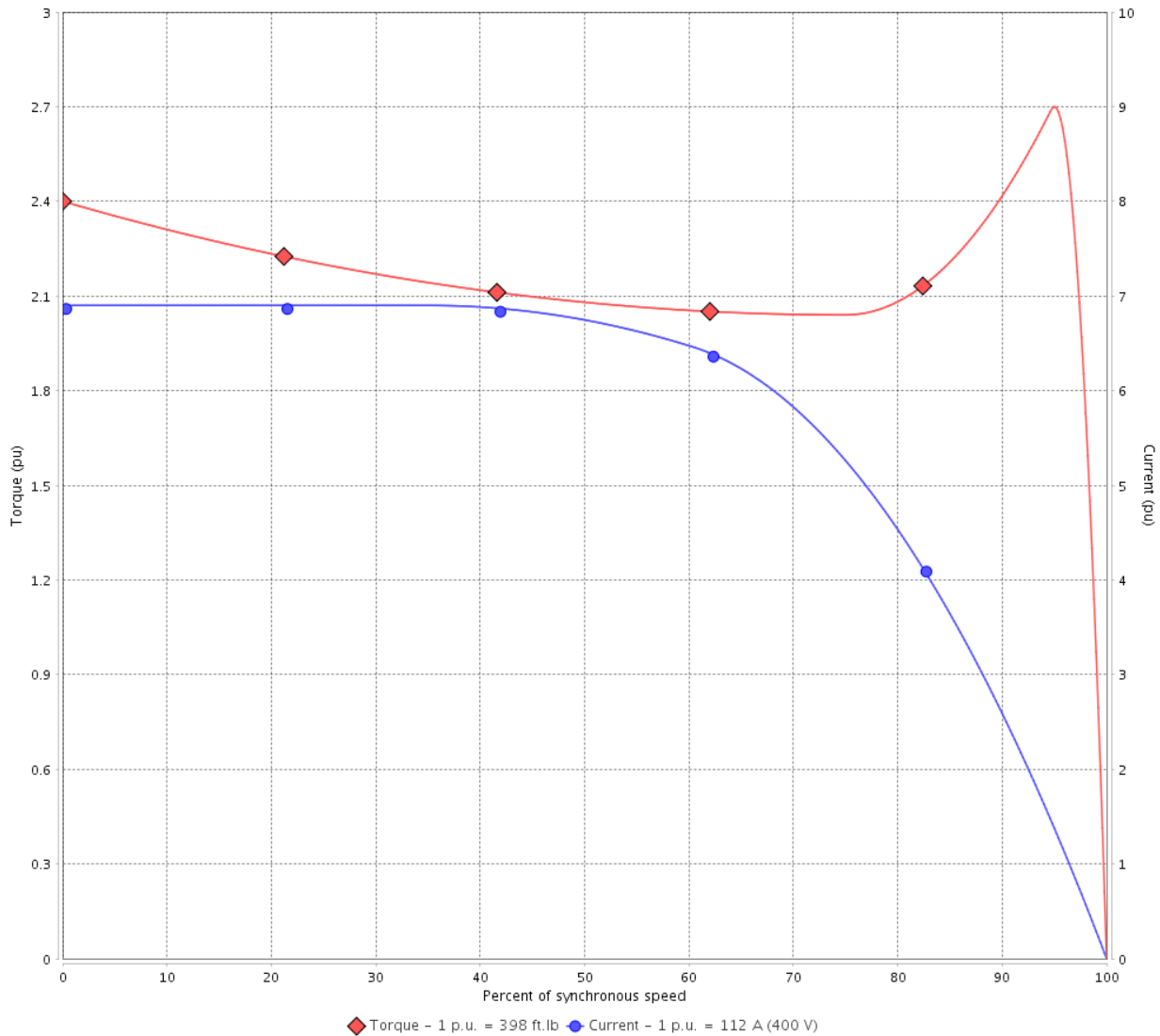

Performance : 400 V 50 Hz 6P IE3

Rated current	: 112 A	Moment of inertia (J)	: 60.6 sq.ft.lb
LRC	: 6.9	Duty cycle	: Cont.(S1)
Rated torque	: 398 ft.lb	Insulation class	: F
Locked rotor torque	: 240 %	Service factor	: 1.00
Breakdown torque	: 270 %	Temperature rise	: 80 K
Rated speed	: 990 rpm	Design	: B

Locked rotor time : 25s (cold) 14s (hot)

Rev.	Changes Summary	Performed	Checked	Date
Performed by			Page 4 / 21	Revision
Checked by				
Date	13/04/2022			

TORQUE AND CURRENT VS SPEED CURVE



Three Phase Induction Motor - Squirrel Cage

Customer :

Product line : W40 NEMA Premium Efficiency
Three-Phase

Product code : 14046018

Catalog # : 10012OT3G444T-W40

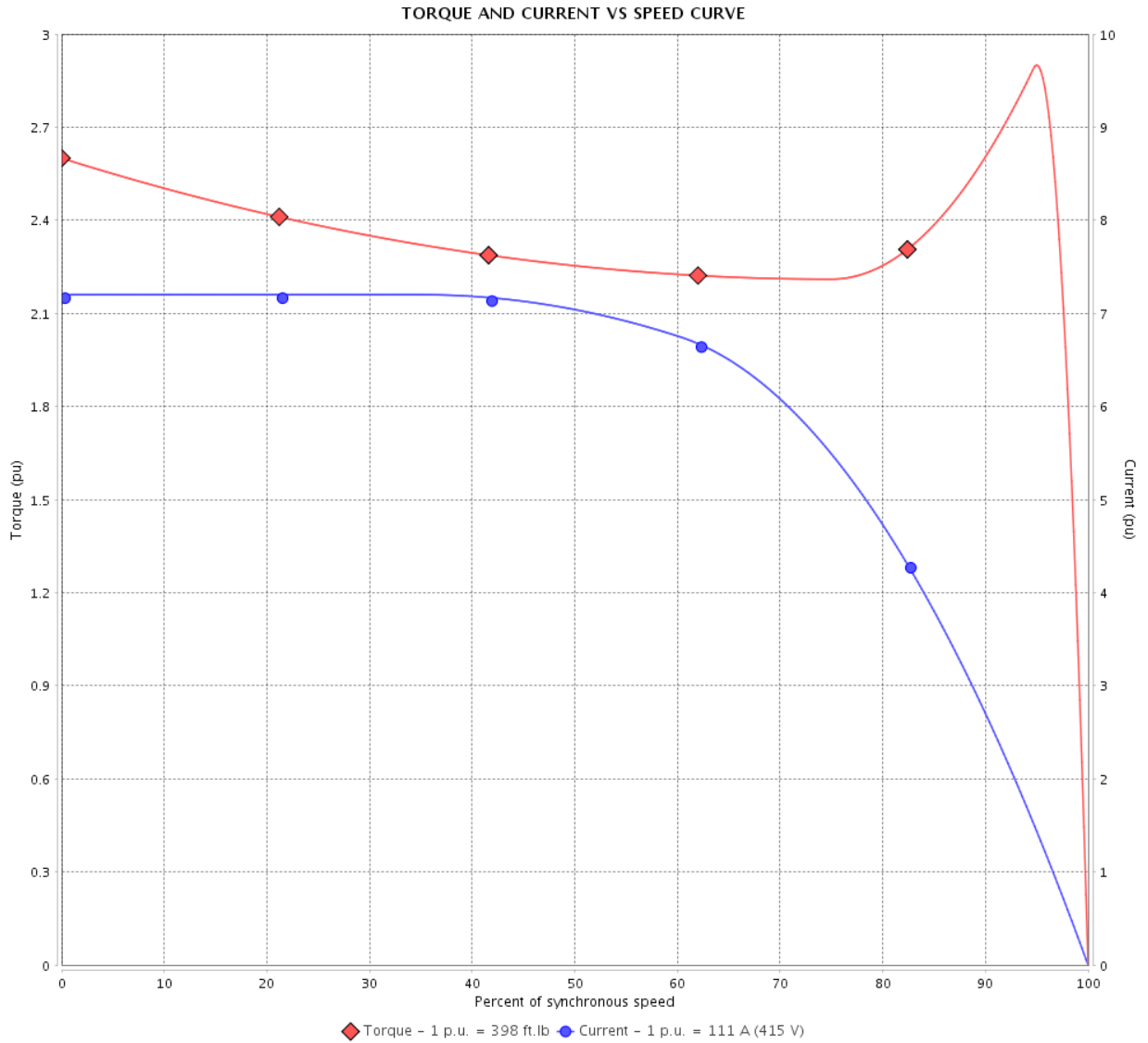

Performance : 415 V 50 Hz 6P IE3

Rated current	: 111 A	Moment of inertia (J)	: 60.6 sq.ft.lb
LRC	: 7.2	Duty cycle	: Cont.(S1)
Rated torque	: 398 ft.lb	Insulation class	: F
Locked rotor torque	: 260 %	Service factor	: 1.00
Breakdown torque	: 290 %	Temperature rise	: 80 K
Rated speed	: 990 rpm	Design	: B

Locked rotor time : 23s (cold) 13s (hot)

Rev.	Changes Summary	Performed	Checked	Date
Performed by			Page 5 / 21	Revision
Checked by				
Date	13/04/2022			

LOAD PERFORMANCE CURVE

Three Phase Induction Motor - Squirrel Cage



Customer :

Product line : W40 NEMA Premium Efficiency
Three-Phase

Product code : 14046018

Catalog # : 100120T3G444T-W40

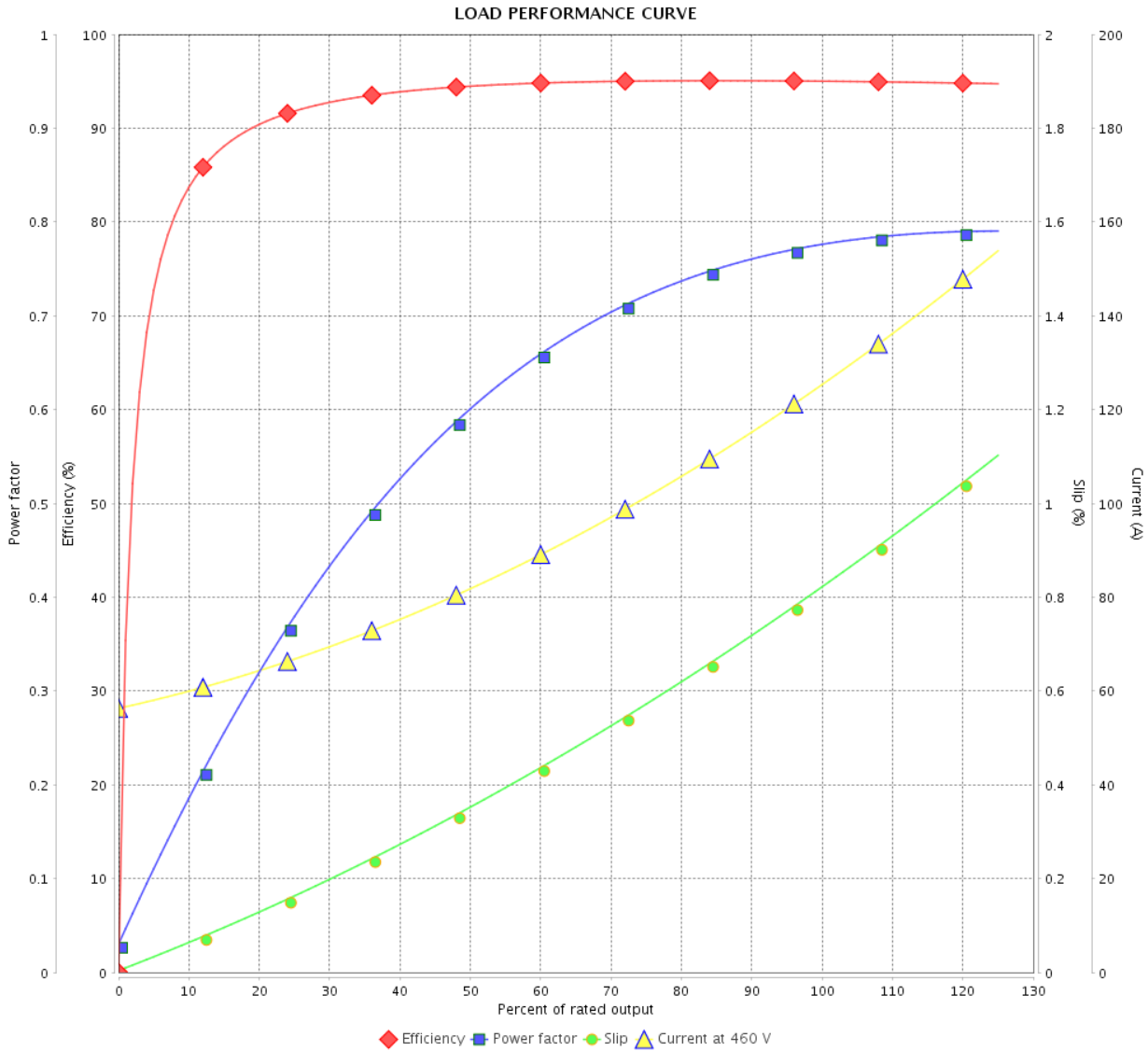

Performance : 460 V 60 Hz 6P

Rated current : 127 A
LRC : 6.1
Rated torque : 441 ft.lb
Locked rotor torque : 200 %
Breakdown torque : 250 %
Rated speed : 1190 rpm

Moment of inertia (J) : 60.6 sq.ft.lb
Duty cycle : Cont.(S1)
Insulation class : F
Service factor : 1.25
Temperature rise : 80 K
Design : B

Rev.	Changes Summary	Performed	Checked	Date
Performed by			Page 6 / 21	Revision
Checked by				
Date	13/04/2022			

LOAD PERFORMANCE CURVE

Three Phase Induction Motor - Squirrel Cage



Customer :

Product line : W40 NEMA Premium Efficiency
Three-Phase

Product code : 14046018

Catalog # : 10012OT3G444T-W40

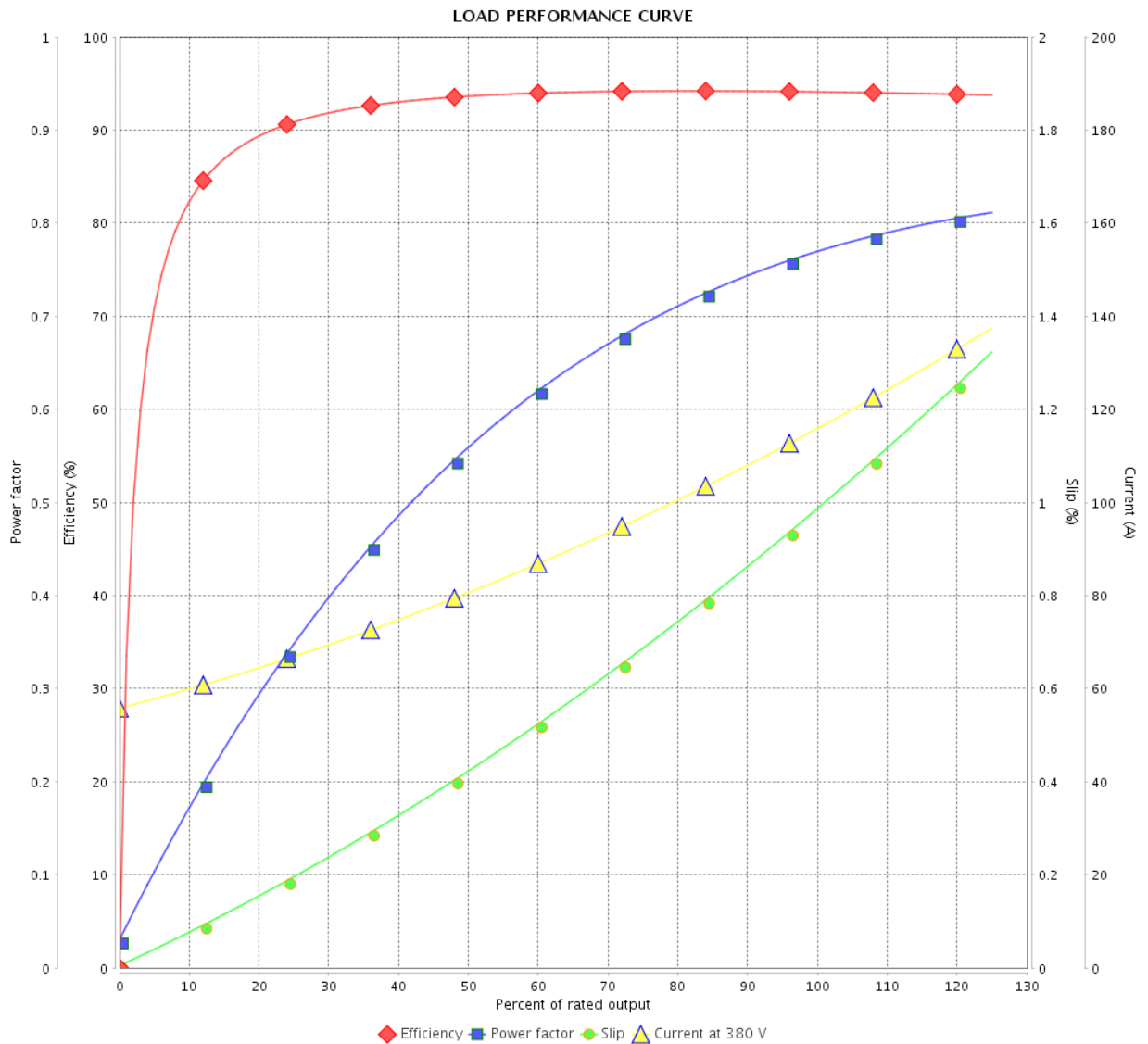

Performance : 380 V 50 Hz 6P IE3

Rated current : 115 A
 LRC : 6.9
 Rated torque : 398 ft.lb
 Locked rotor torque : 220 %
 Breakdown torque : 250 %
 Rated speed : 990 rpm

Moment of inertia (J) : 60.6 sq.ft.lb
 Duty cycle : Cont.(S1)
 Insulation class : F
 Service factor : 1.00
 Temperature rise : 80 K
 Design : B

Rev.	Changes Summary	Performed	Checked	Date
Performed by		Page		Revision
Checked by		7 / 21		
Date		13/04/2022		

LOAD PERFORMANCE CURVE

Three Phase Induction Motor - Squirrel Cage



Customer :

Product line : W40 NEMA Premium Efficiency
Three-Phase

Product code : 14046018

Catalog # : 100120T3G444T-W40

LOAD PERFORMANCE CURVE

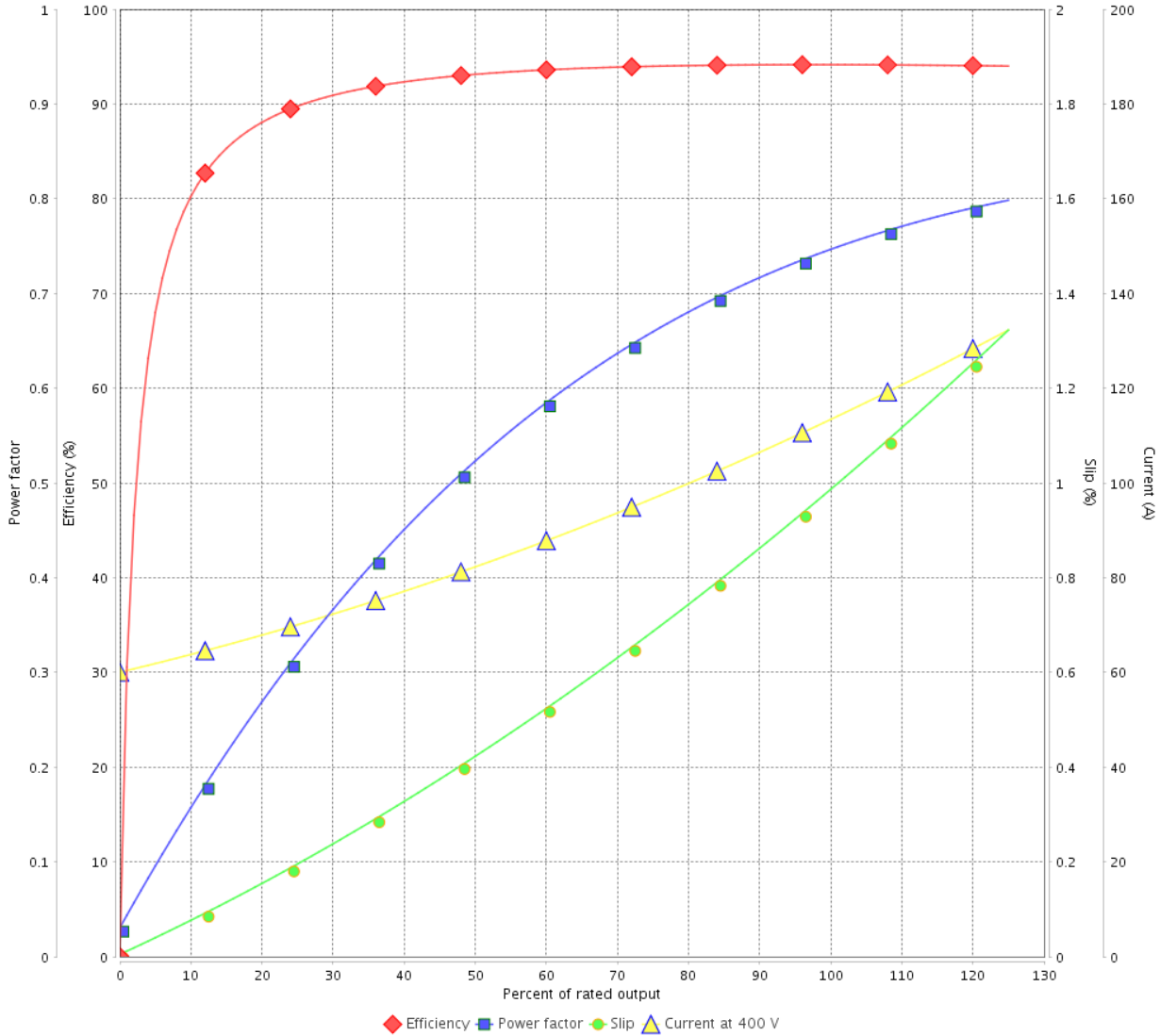

Performance : 400 V 50 Hz 6P IE3

Rated current : 112 A
LRC : 6.9
Rated torque : 398 ft.lb
Locked rotor torque : 240 %
Breakdown torque : 270 %
Rated speed : 990 rpm

Moment of inertia (J) : 60.6 sq.ft.lb
Duty cycle : Cont.(S1)
Insulation class : F
Service factor : 1.00
Temperature rise : 80 K
Design : B

Rev.	Changes Summary	Performed	Checked	Date
Performed by			Page 8 / 21	Revision
Checked by				
Date	13/04/2022			

LOAD PERFORMANCE CURVE

Three Phase Induction Motor - Squirrel Cage



Customer : _____

Product line : W40 NEMA Premium Efficiency
Three-Phase

Product code : 14046018

Catalog # : 10012OT3G444T-W40

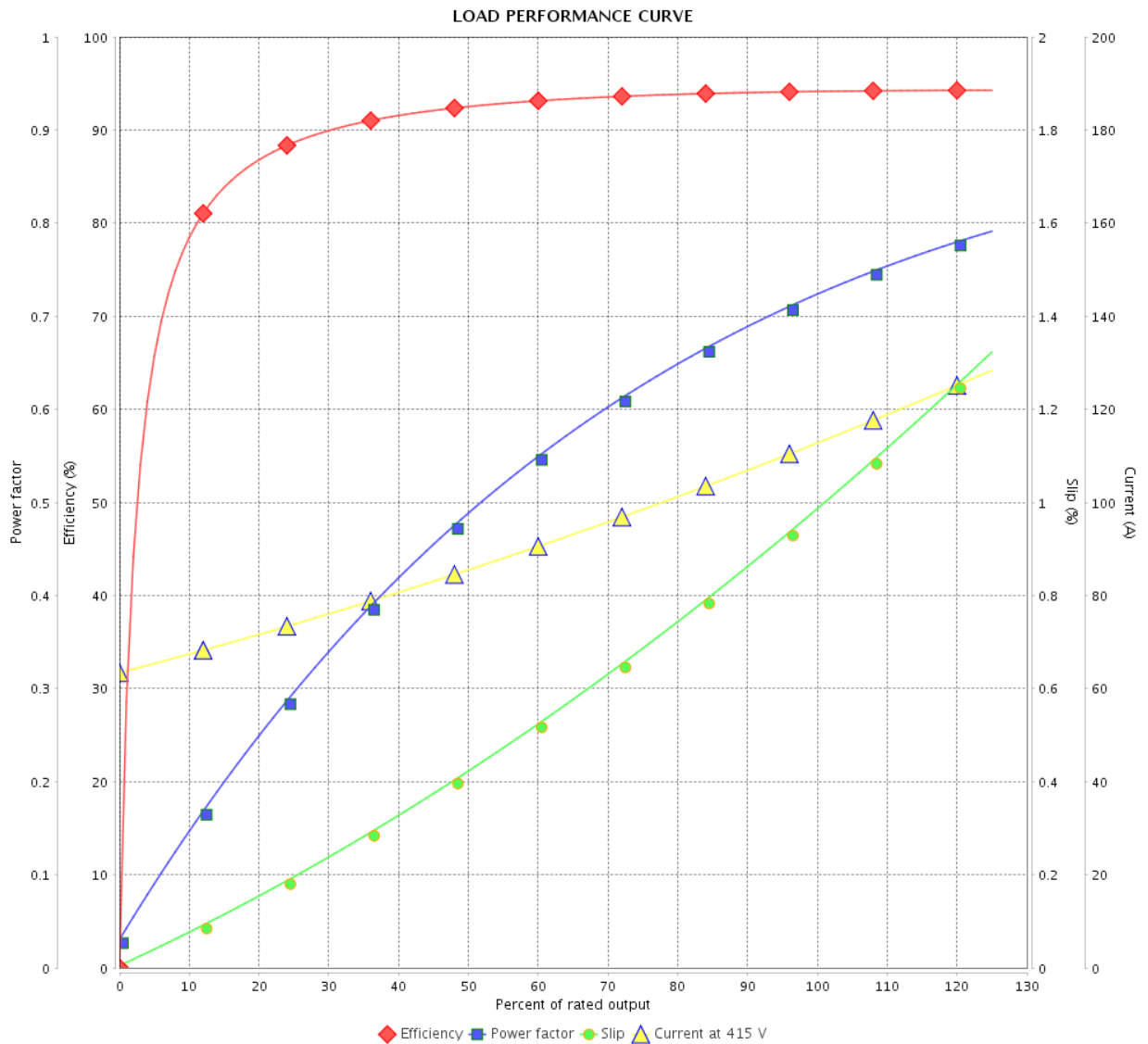

Performance : 415 V 50 Hz 6P IE3

Rated current : 111 A
 LRC : 7.2
 Rated torque : 398 ft.lb
 Locked rotor torque : 260 %
 Breakdown torque : 290 %
 Rated speed : 990 rpm

Moment of inertia (J) : 60.6 sq.ft.lb
 Duty cycle : Cont.(S1)
 Insulation class : F
 Service factor : 1.00
 Temperature rise : 80 K
 Design : B

Rev.	Changes Summary	Performed	Checked	Date
Performed by			Page	Revision
Checked by				
Date				

THERMAL LIMIT CURVE



Three Phase Induction Motor - Squirrel Cage

Customer :

Product line : W40 NEMA Premium Efficiency
Three-Phase

Product code : 14046018

Catalog # : 10012OT3G444T-W40

Performance : 460 V 60 Hz 6P

Rated current	: 127 A	Moment of inertia (J)	: 60.6 sq.ft.lb
LRC	: 6.1	Duty cycle	: Cont.(S1)
Rated torque	: 441 ft.lb	Insulation class	: F
Locked rotor torque	: 200 %	Service factor	: 1.25
Breakdown torque	: 250 %	Temperature rise	: 80 K
Rated speed	: 1190 rpm	Design	: B

Heating constant

Cooling constant

Rev.	Changes Summary	Performed	Checked	Date
Performed by				
Checked by			Page	Revision
Date	13/04/2022		10 / 21	

THERMAL LIMIT CURVE

Three Phase Induction Motor - Squirrel Cage



Customer : _____

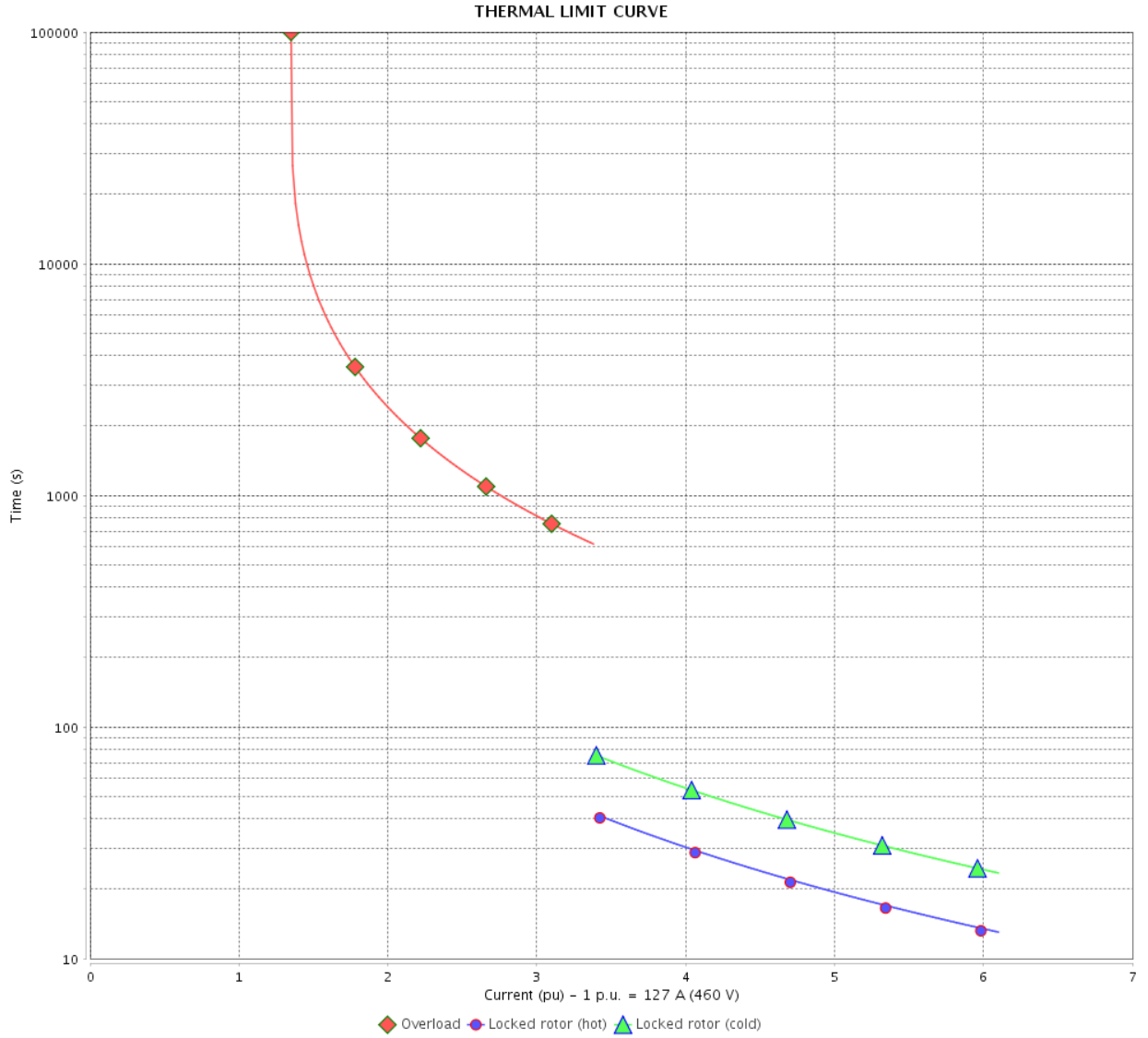

Rev.	Changes Summary	Performed	Checked	Date
Performed by		Page		Revision
Checked by		11 / 21		
Date		13/04/2022		

THERMAL LIMIT CURVE



Three Phase Induction Motor - Squirrel Cage

Customer :

Product line : W40 NEMA Premium Efficiency
Three-Phase

Product code : 14046018

Catalog # : 10012OT3G444T-W40

Performance : 380 V 50 Hz 6P IE3

Rated current	: 115 A	Moment of inertia (J)	: 60.6 sq.ft.lb
LRC	: 6.9	Duty cycle	: Cont.(S1)
Rated torque	: 398 ft.lb	Insulation class	: F
Locked rotor torque	: 220 %	Service factor	: 1.00
Breakdown torque	: 250 %	Temperature rise	: 80 K
Rated speed	: 990 rpm	Design	: B

Heating constant

Cooling constant

Rev.	Changes Summary	Performed	Checked	Date
Performed by				
Checked by			Page	Revision
Date	13/04/2022		12 / 21	

THERMAL LIMIT CURVE

Three Phase Induction Motor - Squirrel Cage



Customer : _____

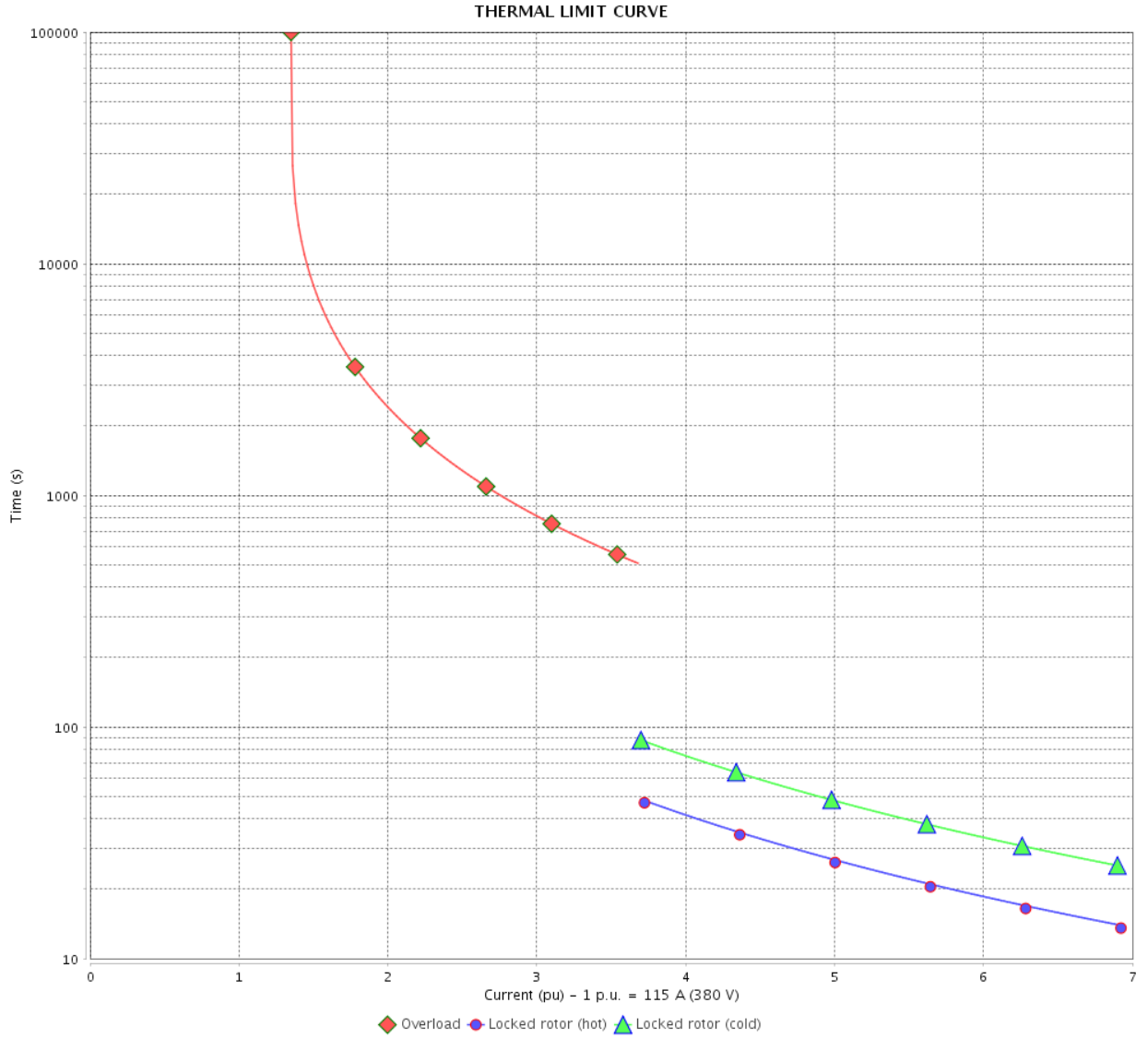

Rev.	Changes Summary	Performed	Checked	Date
Performed by		Page		Revision
Checked by		13 / 21		
Date		13/04/2022		

THERMAL LIMIT CURVE



Three Phase Induction Motor - Squirrel Cage

Customer :

Product line : W40 NEMA Premium Efficiency
Three-Phase

Product code : 14046018

Catalog # : 100120T3G444T-W40

Performance : 400 V 50 Hz 6P IE3

Rated current	: 112 A	Moment of inertia (J)	: 60.6 sq.ft.lb
LRC	: 6.9	Duty cycle	: Cont.(S1)
Rated torque	: 398 ft.lb	Insulation class	: F
Locked rotor torque	: 240 %	Service factor	: 1.00
Breakdown torque	: 270 %	Temperature rise	: 80 K
Rated speed	: 990 rpm	Design	: B

Heating constant

Cooling constant

Rev.	Changes Summary	Performed	Checked	Date
Performed by				
Checked by			Page	Revision
Date	13/04/2022		14 / 21	

THERMAL LIMIT CURVE

Three Phase Induction Motor - Squirrel Cage



Customer : _____

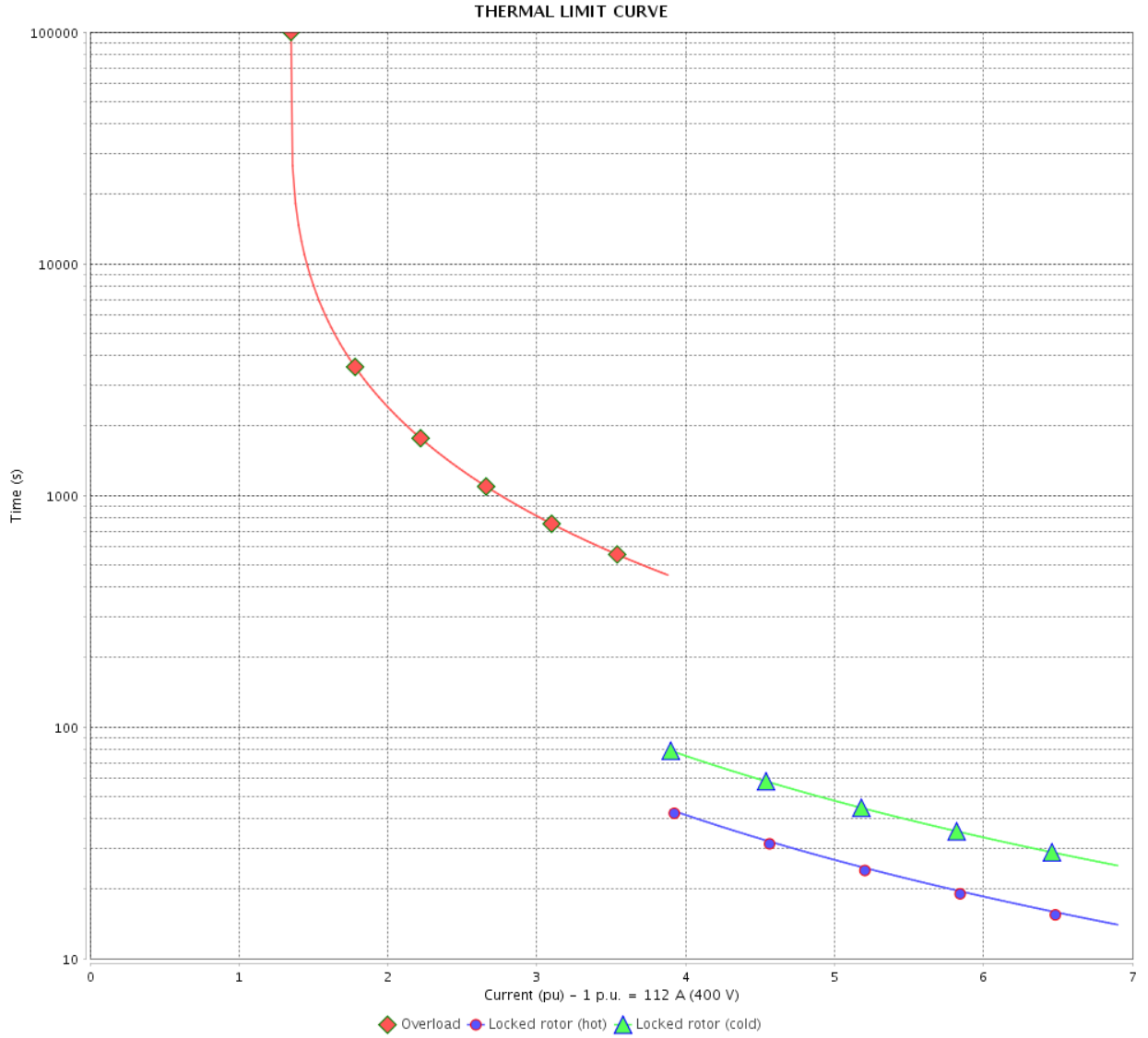

Rev.	Changes Summary	Performed	Checked	Date
Performed by		Page 15 / 21		Revision
Checked by				
Date				

THERMAL LIMIT CURVE

Three Phase Induction Motor - Squirrel Cage



Customer :

Product line : W40 NEMA Premium Efficiency
Three-Phase

Product code : 14046018

Catalog # : 10012OT3G444T-W40

Performance : 415 V 50 Hz 6P IE3

Rated current	: 111 A	Moment of inertia (J)	: 60.6 sq.ft.lb
LRC	: 7.2	Duty cycle	: Cont.(S1)
Rated torque	: 398 ft.lb	Insulation class	: F
Locked rotor torque	: 260 %	Service factor	: 1.00
Breakdown torque	: 290 %	Temperature rise	: 80 K
Rated speed	: 990 rpm	Design	: B

Heating constant

Cooling constant

Rev.	Changes Summary	Performed	Checked	Date
Performed by				
Checked by			Page	Revision
Date	13/04/2022		16 / 21	

THERMAL LIMIT CURVE

Three Phase Induction Motor - Squirrel Cage



Customer : _____

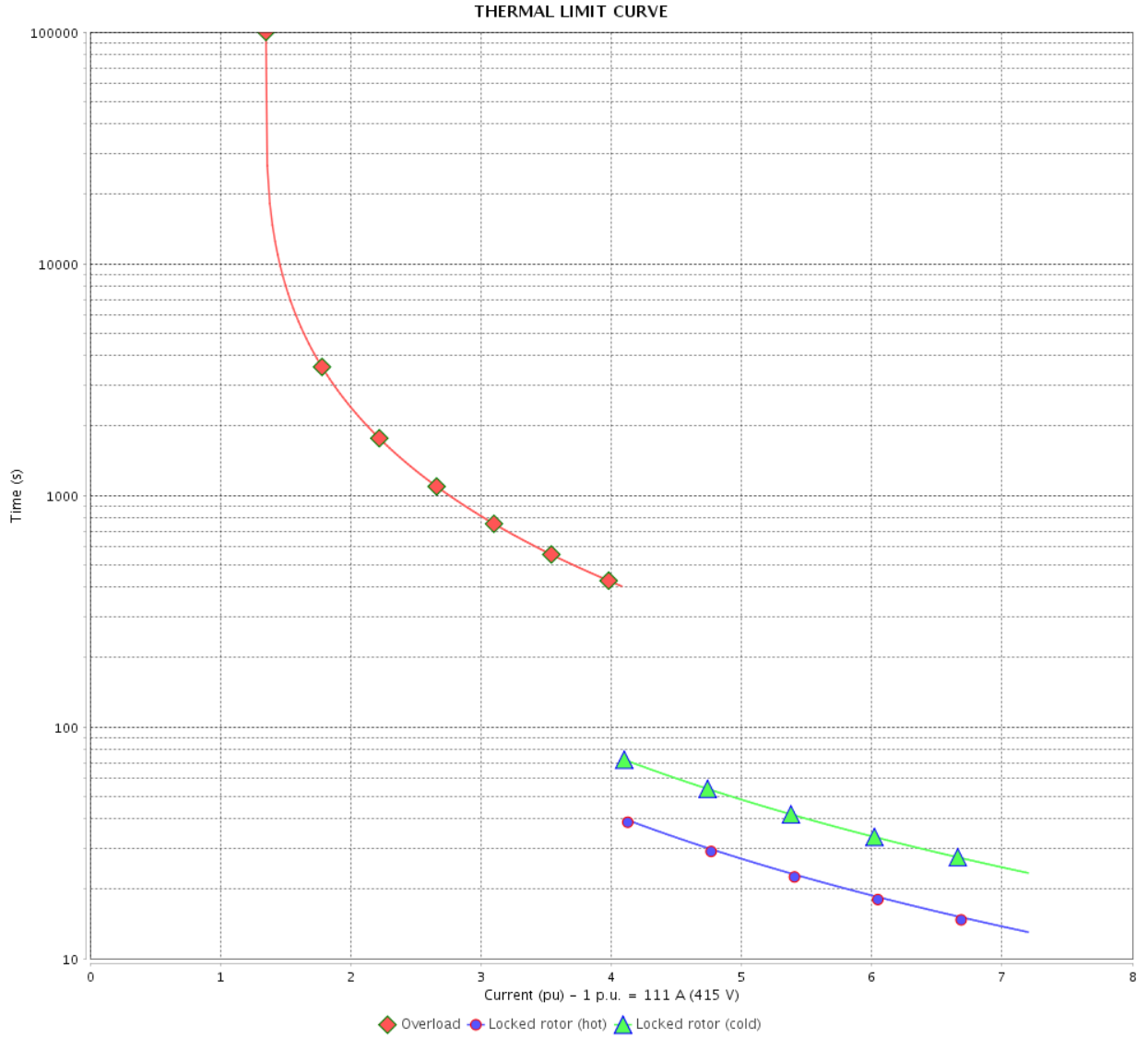

Rev.	Changes Summary	Performed	Checked	Date
Performed by		Page 17 / 21		Revision
Checked by				
Date				

VFD OPERATION CURVE

Three Phase Induction Motor - Squirrel Cage



Customer : _____

Product line : W40 NEMA Premium Efficiency
Three-Phase

Product code : 14046018

Catalog # : 100120T3G444T-W40

VFD OPERATION CURVE

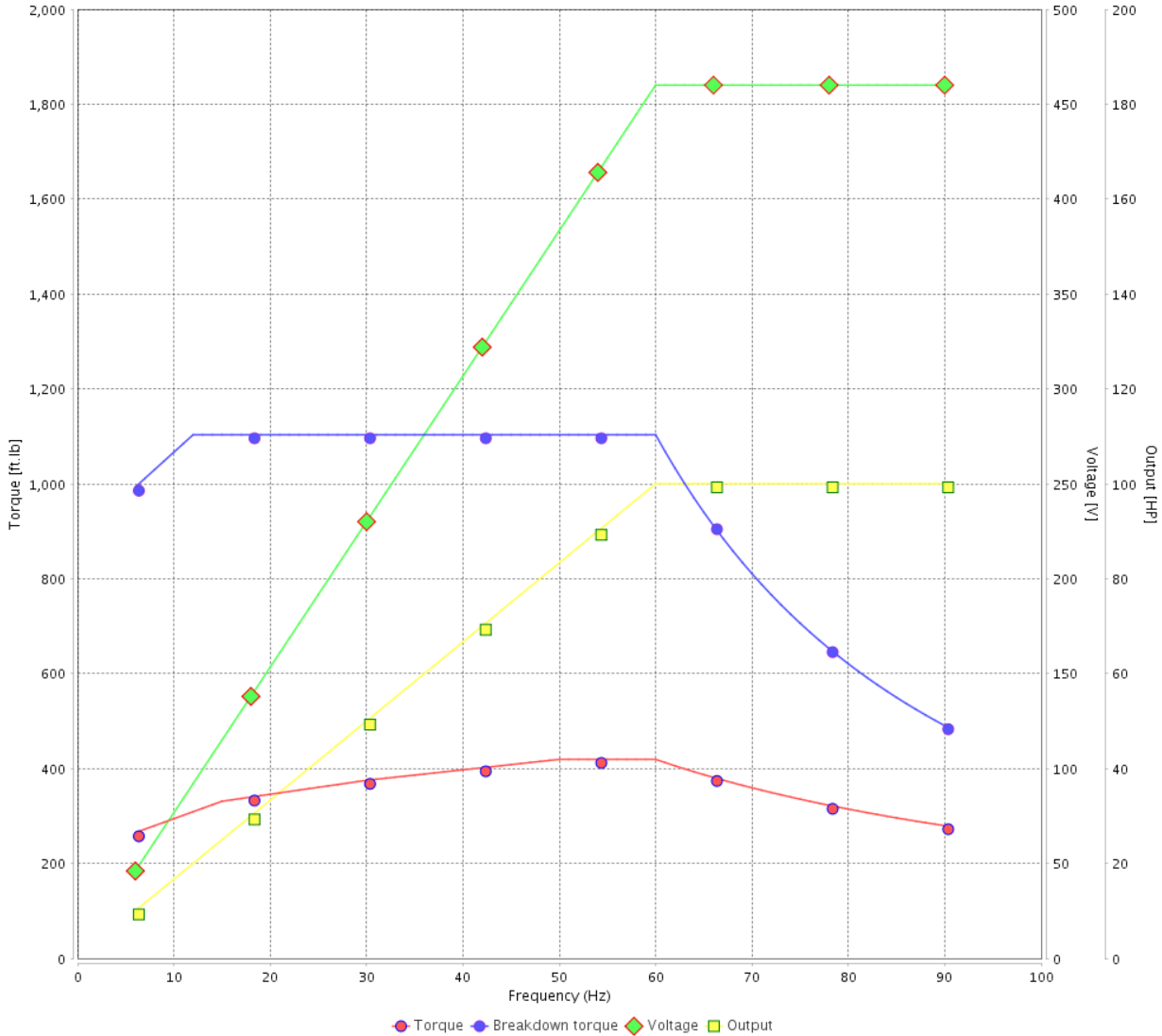

Performance : 460 V 60 Hz 6P

Rated current : 127 A
LRC : 6.1
Rated torque : 441 ft.lb
Locked rotor torque : 200 %
Breakdown torque : 250 %
Rated speed : 1190 rpm

Moment of inertia (J) : 60.6 sq.ft.lb
Duty cycle : Cont.(S1)
Insulation class : F
Service factor : 1.25
Temperature rise : 80 K
Design : B

Rev.	Changes Summary	Performed	Checked	Date
Performed by			Page 18 / 21	Revision
Checked by				
Date	13/04/2022			

VFD OPERATION CURVE

Three Phase Induction Motor - Squirrel Cage



Customer : _____

Product line : W40 NEMA Premium Efficiency
Three-Phase

Product code : 14046018

Catalog # : 10012OT3G444T-W40

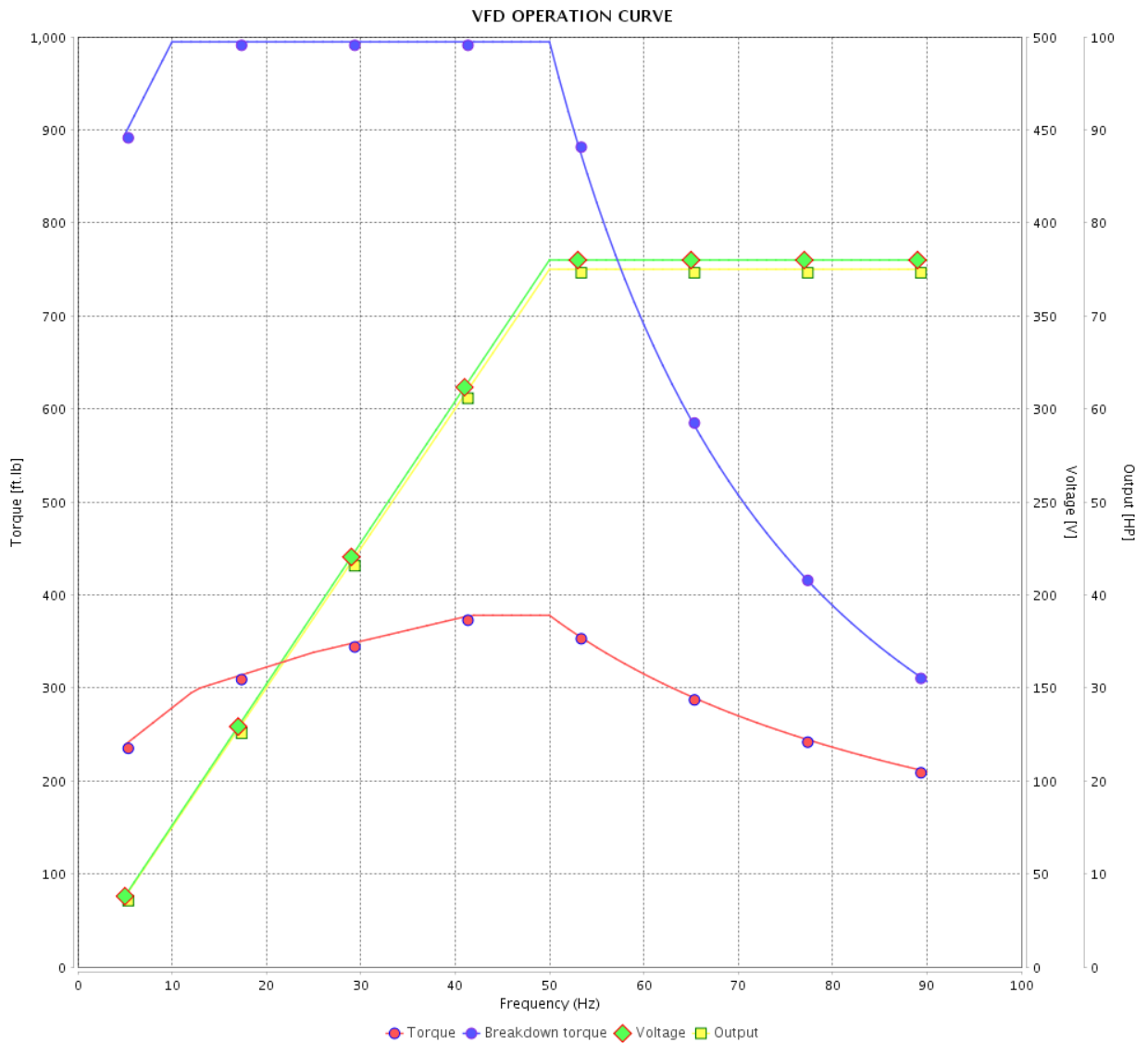

Performance : 380 V 50 Hz 6P IE3

Rated current : 115 A
 LRC : 6.9
 Rated torque : 398 ft.lb
 Locked rotor torque : 220 %
 Breakdown torque : 250 %
 Rated speed : 990 rpm

Moment of inertia (J) : 60.6 sq.ft.lb
 Duty cycle : Cont.(S1)
 Insulation class : F
 Service factor : 1.00
 Temperature rise : 80 K
 Design : B

Rev.	Changes Summary	Performed	Checked	Date
Performed by			Page 19 / 21	Revision
Checked by				
Date	13/04/2022			

VFD OPERATION CURVE

Three Phase Induction Motor - Squirrel Cage



Customer :

Product line : W40 NEMA Premium Efficiency
Three-Phase

Product code : 14046018

Catalog # : 100120T3G444T-W40

VFD OPERATION CURVE

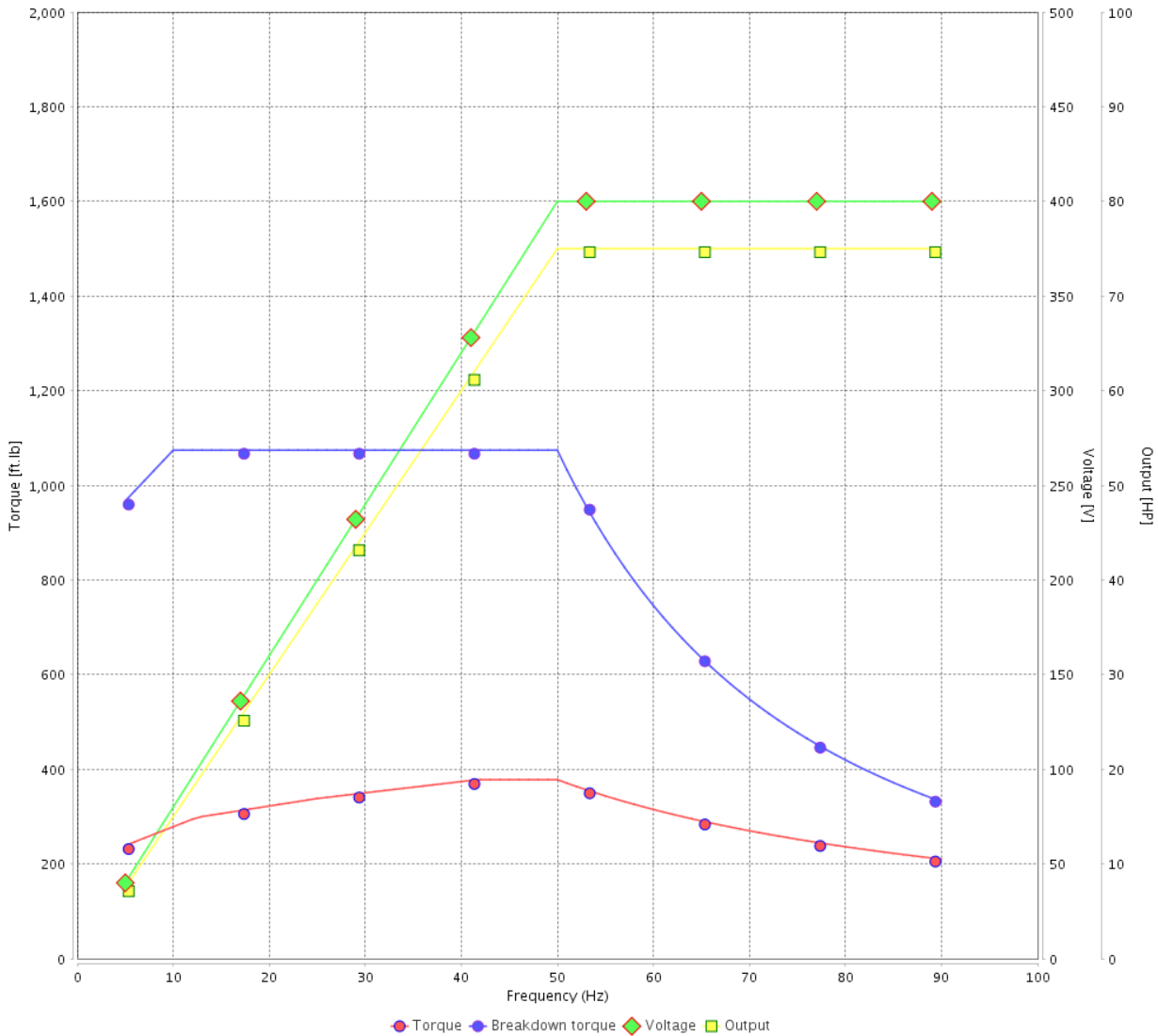

Performance : 400 V 50 Hz 6P IE3

Rated current	: 112 A	Moment of inertia (J)	: 60.6 sq.ft.lb
LRC	: 6.9	Duty cycle	: Cont.(S1)
Rated torque	: 398 ft.lb	Insulation class	: F
Locked rotor torque	: 240 %	Service factor	: 1.00
Breakdown torque	: 270 %	Temperature rise	: 80 K
Rated speed	: 990 rpm	Design	: B

Rev.	Changes Summary	Performed	Checked	Date
Performed by		Page		Revision
Checked by		20 / 21		
Date	13/04/2022			

VFD OPERATION CURVE

Three Phase Induction Motor - Squirrel Cage



Customer :

Product line : W40 NEMA Premium Efficiency
Three-Phase

Product code : 14046018

Catalog # : 10012OT3G444T-W40

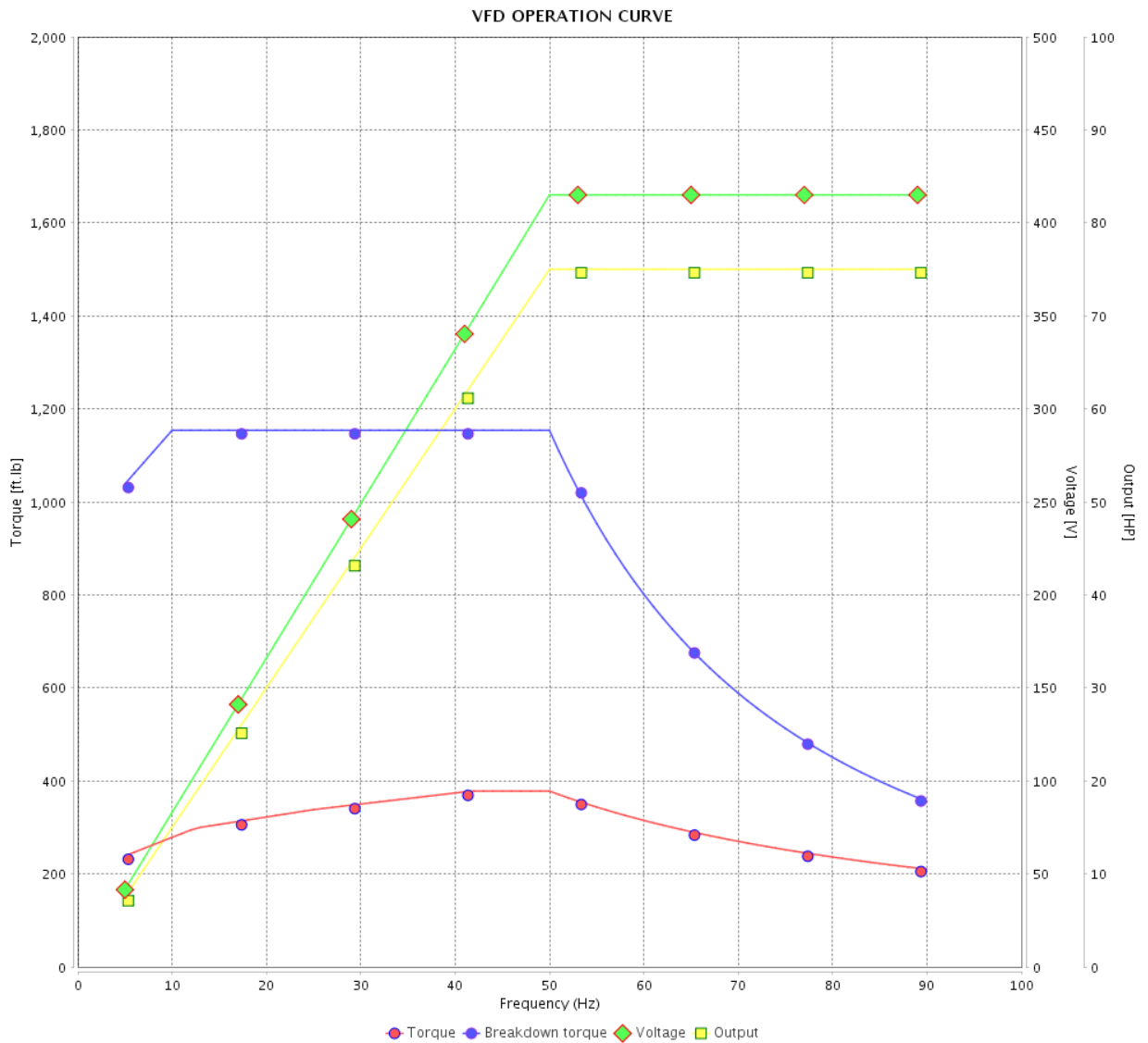

Performance : 415 V 50 Hz 6P IE3

Rated current : 111 A
 LRC : 7.2
 Rated torque : 398 ft.lb
 Locked rotor torque : 260 %
 Breakdown torque : 290 %
 Rated speed : 990 rpm

Moment of inertia (J) : 60.6 sq.ft.lb
 Duty cycle : Cont.(S1)
 Insulation class : F
 Service factor : 1.00
 Temperature rise : 80 K
 Design : B

Rev.	Changes Summary	Performed	Checked	Date
Performed by				Page 21 / 21
Checked by				
Date	13/04/2022			

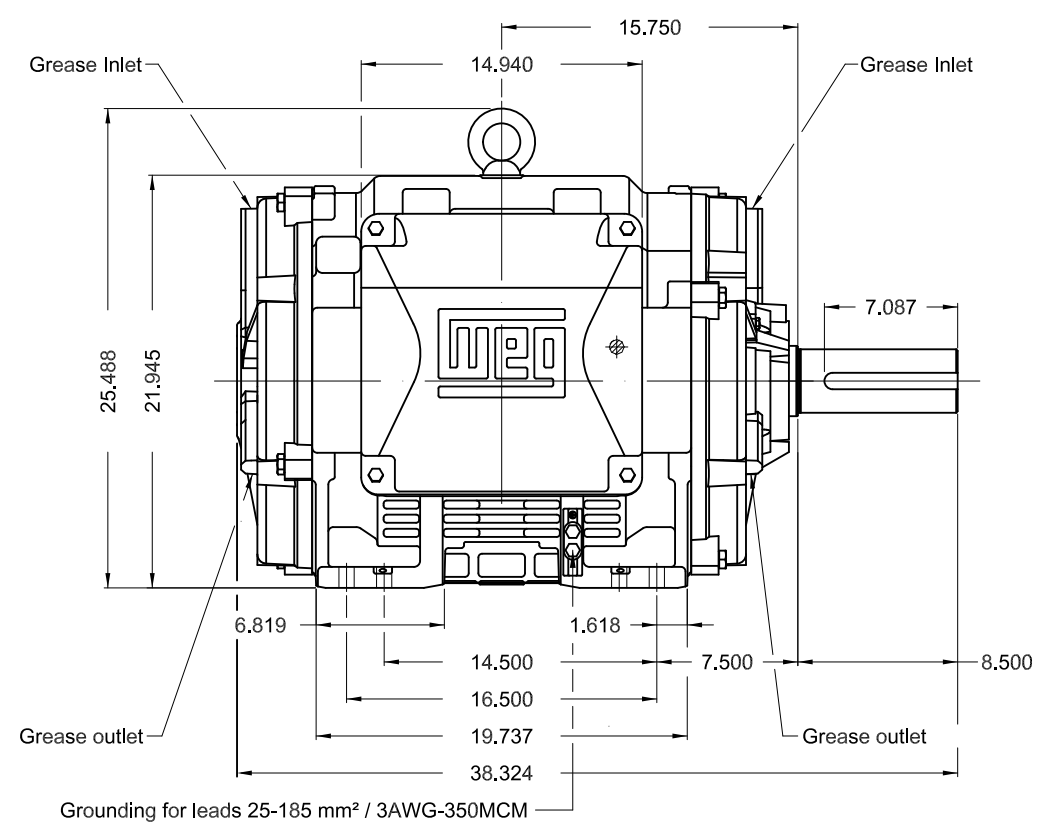
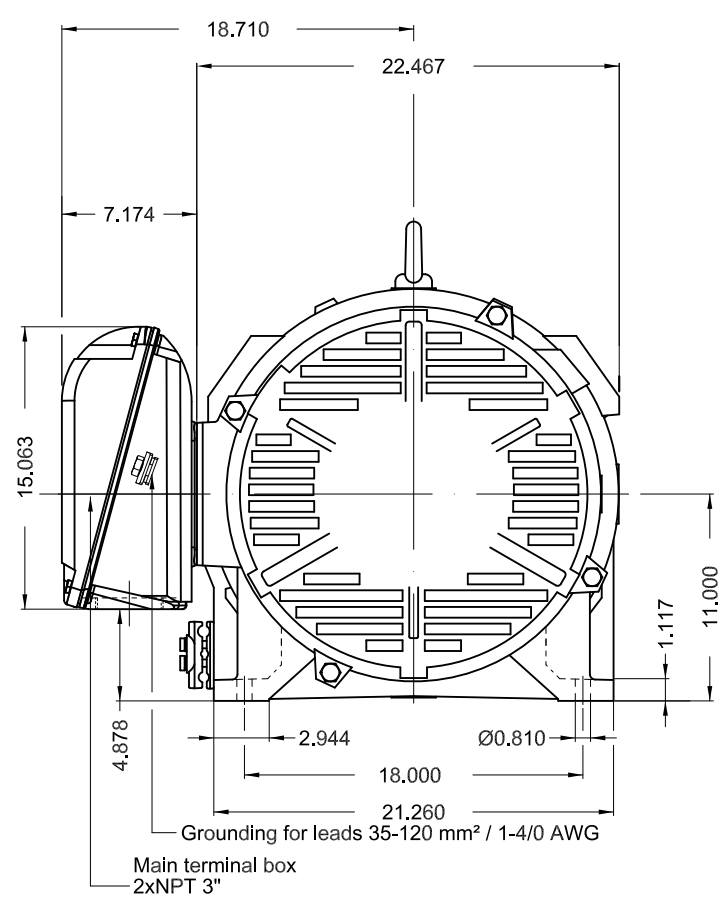

- C3 NDE bearing
- Color RAL 5009
- Painting plan 203A
- Mounting NEMA F-1
- Mounting B3R(D)

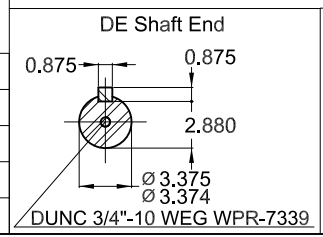

100 HP 06 Poles 60 Hz A

1:10

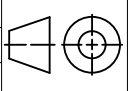
ECM	LOC	SUMMARY OF MODIFICATIONS	EXECUTED	CHECKED	RELEASED	DATE	VER
EXECUTED	PIRWUSER	 THREE PH. MOTOR W40 PREM. EFF. FRAME 444/5T IP23 ODP					
CHECKED							
RELEASED							
REL DT.	WMO	Jaragua do Sul	Product Engineering	SHEET	1 / 1		

PREVIEW
WDD



MODEL 100120T3G444T-W40
MADE IN BRAZIL
14046018

WEG **W40 NEMA**
CC029A Premium
Inverter Duty Motor



IEC 60034-1
MOD.T01#FOXON



For 60Hz use on PWM, VT 1000:1, CT 2:1, 1.0SF

PH 3	FR 444/5T	HP(kW) 100(75)	Hz 60
V 460	A 127	IP23	
NEMA NOM EFF	95.0 %	RPM 1190	
ENCL ODP	DUTY CONT.	INS. CL. F Δ T 80 K	
PF 0.78	DES B	CODE G	AMB. 40°C
SF 1.25	SFA 159	ALT 1000 m.a.s.l.	
75HP 55kW 50Hz 380V 115A 990RPM SF1.00 EFF 94.1% (IE3)			

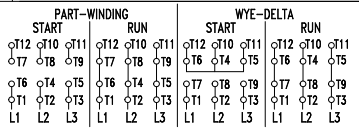

→ 6319-C3(45g) MOBIL POLYREX EM
→ 6314-C3(27g) 20000 h

1336 Lbs