

# DATA SHEET



## Three Phase Induction Motor - Squirrel Cage

Customer :							
Product line	: NEMA Premium Efficiency Three-Phase	Product code :	11356028				
		Catalog # :	10018ET3GRB405T-W22				
Frame	: 404/5T	Cooling method	: IC411 - TEFC				
Insulation class	: F	Mounting	: F-1				
Duty cycle	: Cont.(S1)	Rotation <sup>1</sup>	: Both (CW and CCW)				
Ambient temperature	: -20°C to +40°C	Starting method	: Direct On Line				
Altitude	: 1000 m.a.s.l.	Approx. weight <sup>2</sup>	: 1178 lb				
Protection degree	: IP55	Moment of inertia (J)	: 29.9 sq.ft.lb				
Design	: B						
Output [HP]	100	75	75	75	100	100	100
Poles	4	4	4	4	4	4	4
Frequency [Hz]	60	50	50	50	50	50	50
Rated voltage [V]	460	380	400	415	380	400	415
Rated current [A]	113	102	98.3	95.9	138	131	127
L. R. Amperes [A]	825	785	826	854	814	852	902
LRC [A]	7.3x(Code H)	7.7x(Code H)	8.4x(Code J)	8.9x(Code K)	5.9x(Code F)	6.5x(Code G)	7.1x(Code H)
No load current [A]	38.0	37.6	40.1	42.0	37.6	40.1	42.0
Rated speed [RPM]	1780	1485	1485	1485	1470	1475	1475
Slip [%]	1.11	1.00	1.00	1.00	2.00	1.67	1.67
Rated torque [ft.lb]	295	265	265	265	357	356	356
Locked rotor torque [%]	240	260	280	290	190	210	220
Breakdown torque [%]	260	280	310	330	210	229	250
Service factor	1.25	1.00	1.00	1.00	1.00	1.00	1.00
Temperature rise	80 K	80 K	80 K	80 K	105 K	105 K	105 K
Locked rotor time	23s (cold) 13s (hot)	16s (cold) 9s (hot)	16s (cold) 9s (hot)	16s (cold) 9s (hot)	16s (cold) 9s (hot)	16s (cold) 9s (hot)	16s (cold) 9s (hot)
Noise level <sup>2</sup>	68.0 dB(A)	64.0 dB(A)	64.0 dB(A)	64.0 dB(A)	64.0 dB(A)	64.0 dB(A)	64.0 dB(A)
Efficiency (%)	25%	94.6	93.4	93.3	93.0	94.8	94.4
	50%	95.0	94.0	93.9	93.6	94.5	94.5
	75%	95.0	94.4	94.5	94.5	94.1	94.5
	100%	95.4	95.0	95.0	95.0	93.6	94.1
Power Factor	25%	0.51	0.47	0.44	0.41	0.57	0.51
	50%	0.77	0.72	0.69	0.66	0.82	0.79
	75%	0.84	0.83	0.81	0.79	0.86	0.85
	100%	0.87	0.86	0.85	0.84	0.88	0.87
Bearing type	: NU-316 C3	6314 C3	Foundation loads				
Sealing	: WSeal	WSeal	Max. traction	: 2083 lb			
Lubrication interval	: 7000 h	12000 h	Max. compression	: 3261 lb			
Lubricant amount	: 34 g	27 g					
Lubricant type	: Mobil Polyrex EM						
Notes							
This revision replaces and cancel the previous one, which must be eliminated. (1) Looking the motor from the shaft end. (2) Measured at 1m and with tolerance of +3dB(A). (3) Approximate weight subject to changes after manufacturing process. (4) At 100% of full load.				These are average values based on tests with sinusoidal power supply, subject to the tolerances stipulated in NEMA MG-1.			
Rev.	Changes Summary			Performed	Checked	Date	
Performed by							
Checked by					Page	Revision	
Date	14/04/2022				1 / 36		

# TORQUE AND CURRENT VS SPEED CURVE

Three Phase Induction Motor - Squirrel Cage



Customer :

Product line : NEMA Premium Efficiency Three-Phase

Product code : 11356028

Catalog # : 10018ET3GRB405T-W22

TORQUE AND CURRENT VS SPEED CURVE

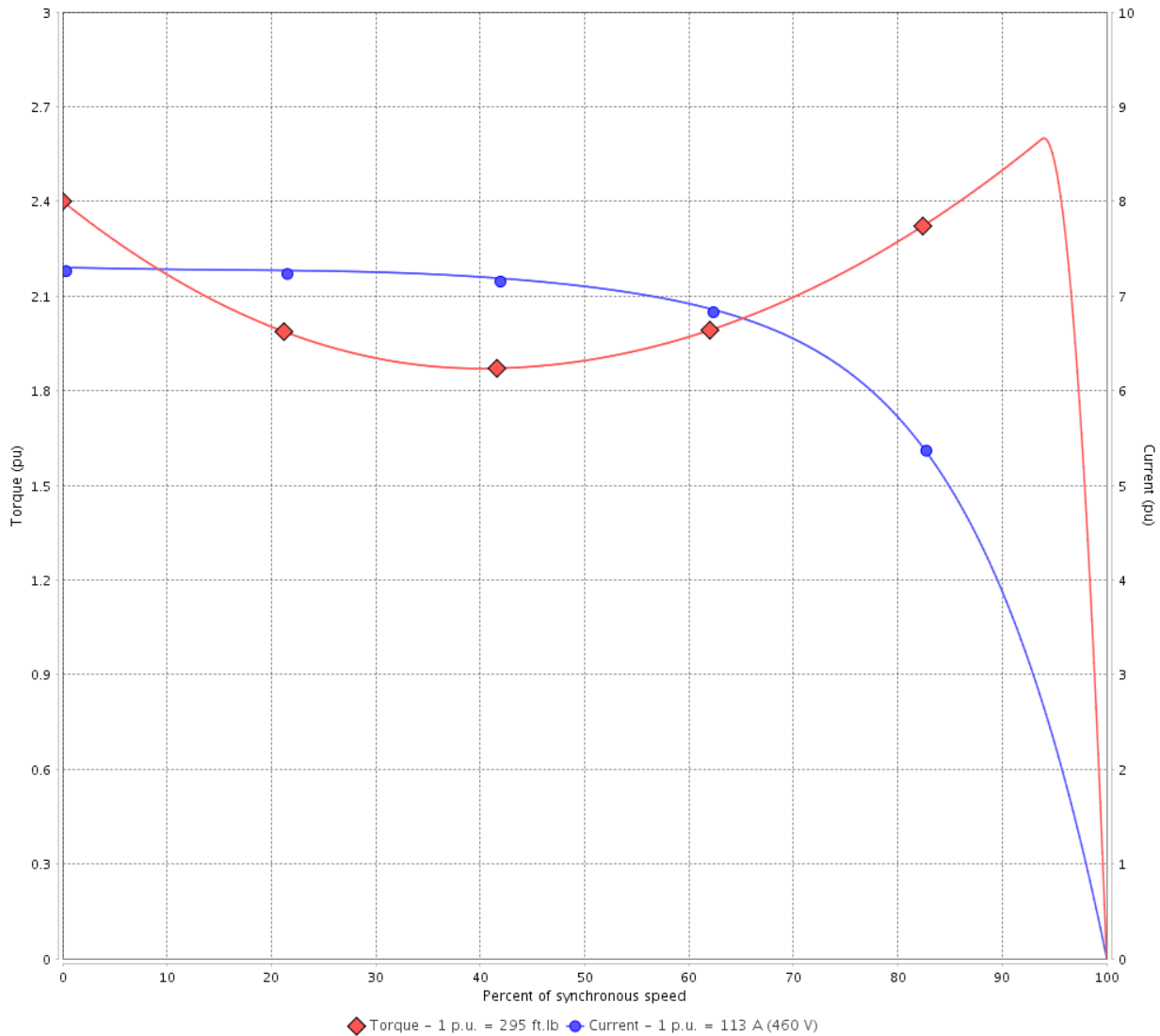

Performance : 460 V 60 Hz 4P

Rated current	: 113 A	Moment of inertia (J)	: 29.9 sq.ft.lb
LRC	: 7.3	Duty cycle	: Cont.(S1)
Rated torque	: 295 ft.lb	Insulation class	: F
Locked rotor torque	: 240 %	Service factor	: 1.25
Breakdown torque	: 260 %	Temperature rise	: 80 K
Rated speed	: 1780 rpm	Design	: B

Locked rotor time : 23s (cold) 13s (hot)

Rev.	Changes Summary	Performed	Checked	Date
Performed by			Page 2 / 36	Revision
Checked by				
Date	14/04/2022			

# TORQUE AND CURRENT VS SPEED CURVE



## Three Phase Induction Motor - Squirrel Cage

Customer :

Product line : NEMA Premium Efficiency Three-Phase

Product code : 11356028

Catalog # : 10018ET3GRB405T-W22

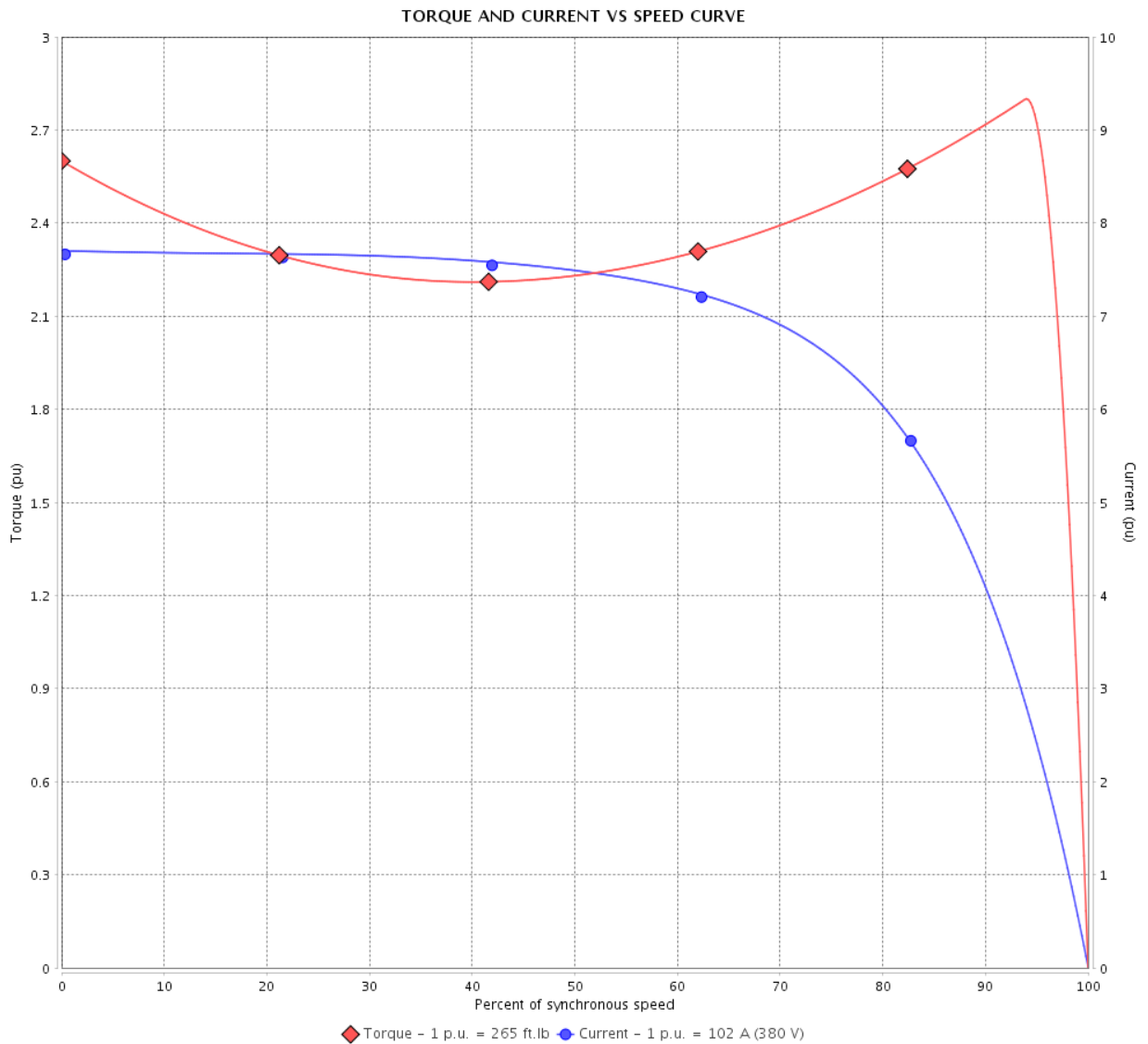

Performance : 380 V 50 Hz 4P IE3

Rated current	: 102 A	Moment of inertia (J)	: 29.9 sq.ft.lb
LRC	: 7.7	Duty cycle	: Cont.(S1)
Rated torque	: 265 ft.lb	Insulation class	: F
Locked rotor torque	: 260 %	Service factor	: 1.00
Breakdown torque	: 280 %	Temperature rise	: 80 K
Rated speed	: 1485 rpm	Design	: B

Locked rotor time : 16s (cold) 9s (hot)

Rev.	Changes Summary	Performed	Checked	Date
Performed by			Page 3 / 36	Revision
Checked by				
Date	14/04/2022			

# TORQUE AND CURRENT VS SPEED CURVE

## Three Phase Induction Motor - Squirrel Cage



Customer :

Product line : NEMA Premium Efficiency Three-Phase

Product code : 11356028

Catalog # : 10018ET3GRB405T-W22

TORQUE AND CURRENT VS SPEED CURVE

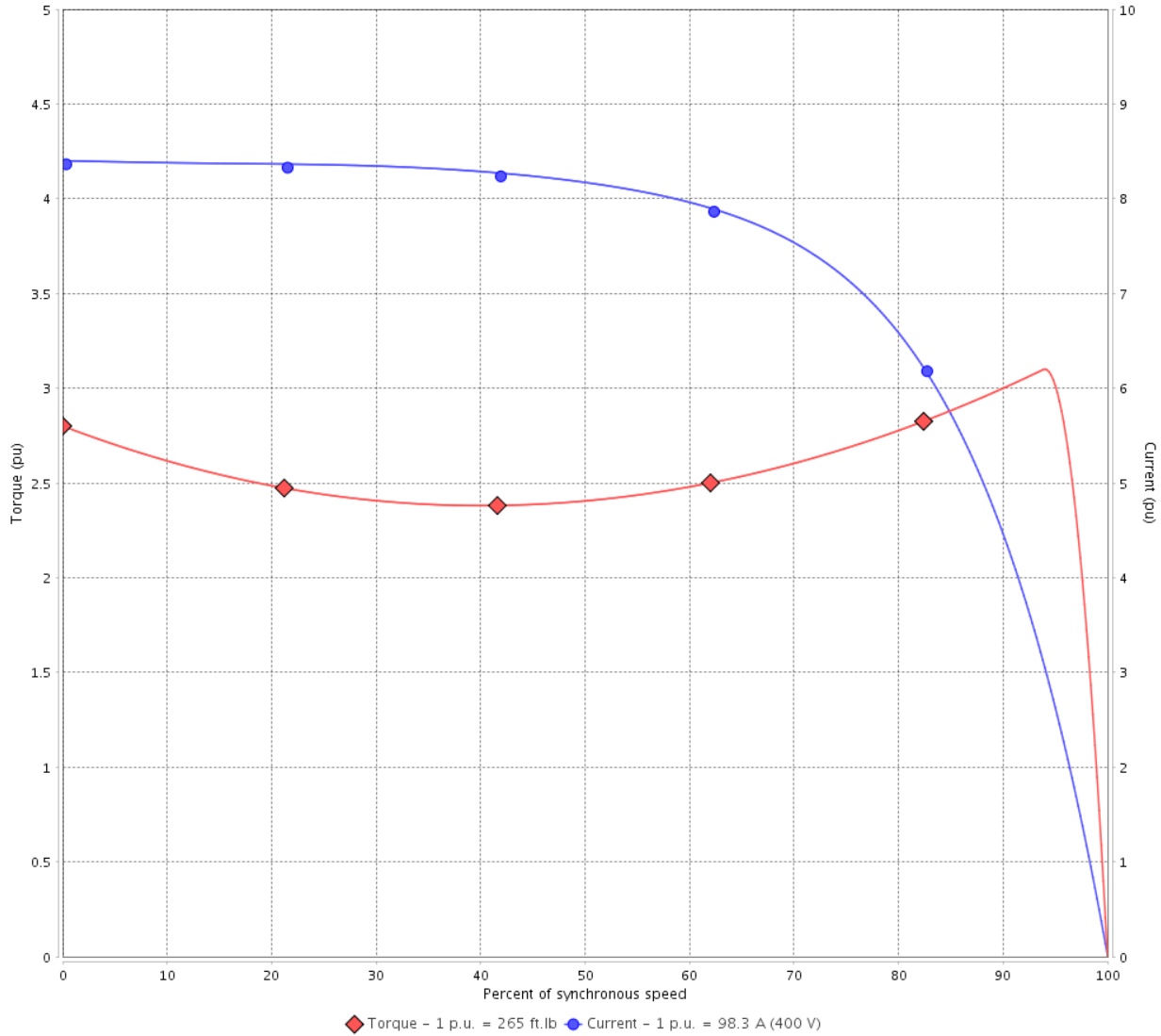

Performance : 400 V 50 Hz 4P IE3

Rated current	: 98.3 A	Moment of inertia (J)	: 29.9 sq.ft.lb
LRC	: 8.4	Duty cycle	: Cont.(S1)
Rated torque	: 265 ft.lb	Insulation class	: F
Locked rotor torque	: 280 %	Service factor	: 1.00
Breakdown torque	: 310 %	Temperature rise	: 80 K
Rated speed	: 1485 rpm	Design	: B

Locked rotor time : 16s (cold) 9s (hot)

Rev.	Changes Summary	Performed	Checked	Date
Performed by			Page 4 / 36	Revision
Checked by				
Date	14/04/2022			

# TORQUE AND CURRENT VS SPEED CURVE



## Three Phase Induction Motor - Squirrel Cage

Customer :

Product line : NEMA Premium Efficiency Three-Phase

Product code : 11356028

Catalog # : 10018ET3GRB405T-W22

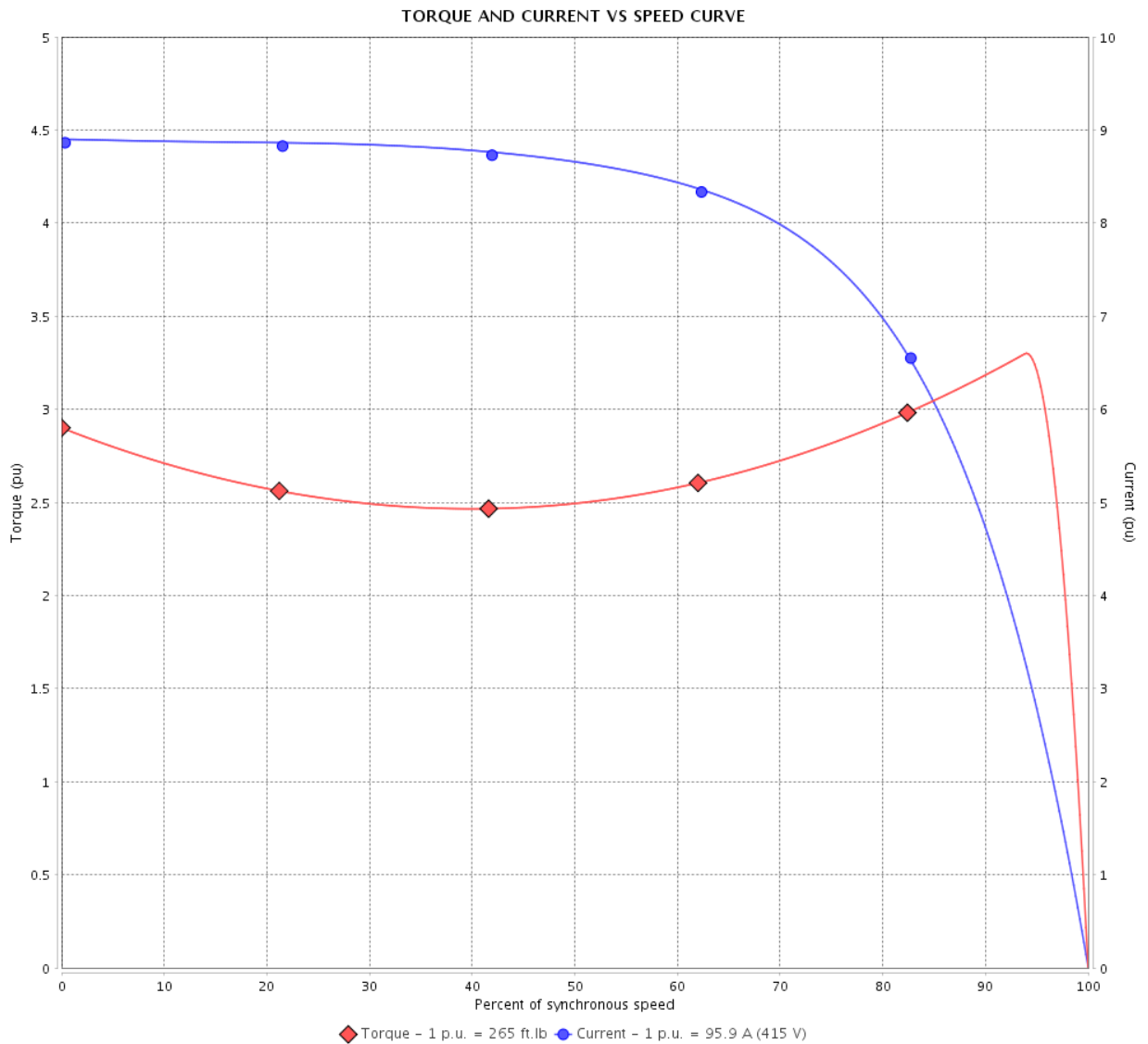

Performance : 415 V 50 Hz 4P IE3

Rated current	: 95.9 A	Moment of inertia (J)	: 29.9 sq.ft.lb
LRC	: 8.9	Duty cycle	: Cont.(S1)
Rated torque	: 265 ft.lb	Insulation class	: F
Locked rotor torque	: 290 %	Service factor	: 1.00
Breakdown torque	: 330 %	Temperature rise	: 80 K
Rated speed	: 1485 rpm	Design	: B

Locked rotor time : 16s (cold) 9s (hot)

Rev.	Changes Summary	Performed	Checked	Date
Performed by			Page 5 / 36	Revision
Checked by				
Date	14/04/2022			

# TORQUE AND CURRENT VS SPEED CURVE

## Three Phase Induction Motor - Squirrel Cage



Customer :

Product line : NEMA Premium Efficiency Three-Phase

Product code : 11356028

Catalog # : 10018ET3GRB405T-W22

TORQUE AND CURRENT VS SPEED CURVE

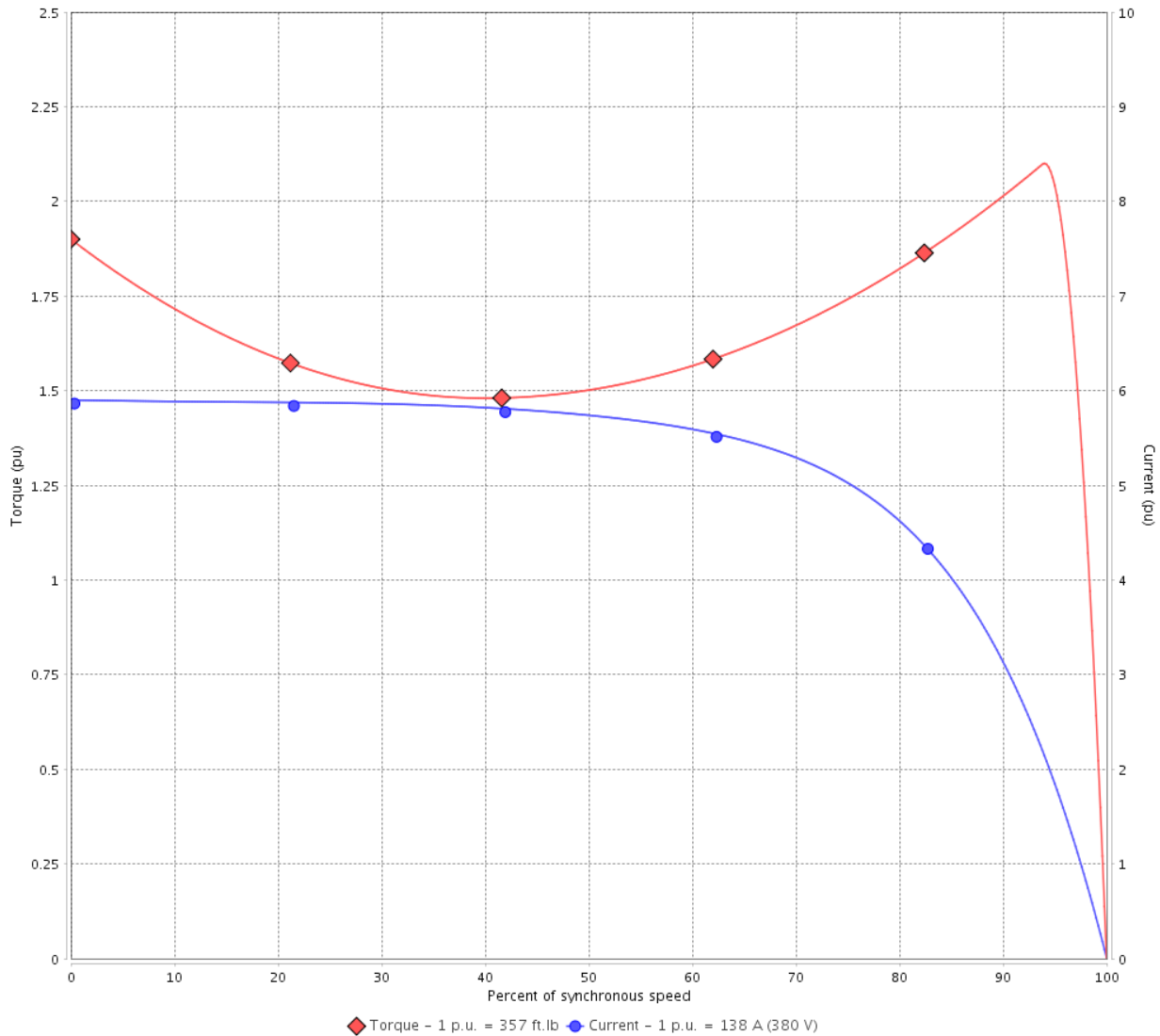

Performance : 380 V 50 Hz 4P IE1

Rated current	: 138 A	Moment of inertia (J)	: 29.9 sq.ft.lb
LRC	: 5.9	Duty cycle	: Cont.(S1)
Rated torque	: 357 ft.lb	Insulation class	: F
Locked rotor torque	: 190 %	Service factor	: 1.00
Breakdown torque	: 210 %	Temperature rise	: 105 K
Rated speed	: 1470 rpm	Design	: B

Locked rotor time : 16s (cold) 9s (hot)

Rev.	Changes Summary	Performed	Checked	Date
Performed by			Page 6 / 36	Revision
Checked by				
Date	14/04/2022			

# TORQUE AND CURRENT VS SPEED CURVE



## Three Phase Induction Motor - Squirrel Cage

Customer :

Product line : NEMA Premium Efficiency Three-Phase

Product code : 11356028

Catalog # : 10018ET3GRB405T-W22

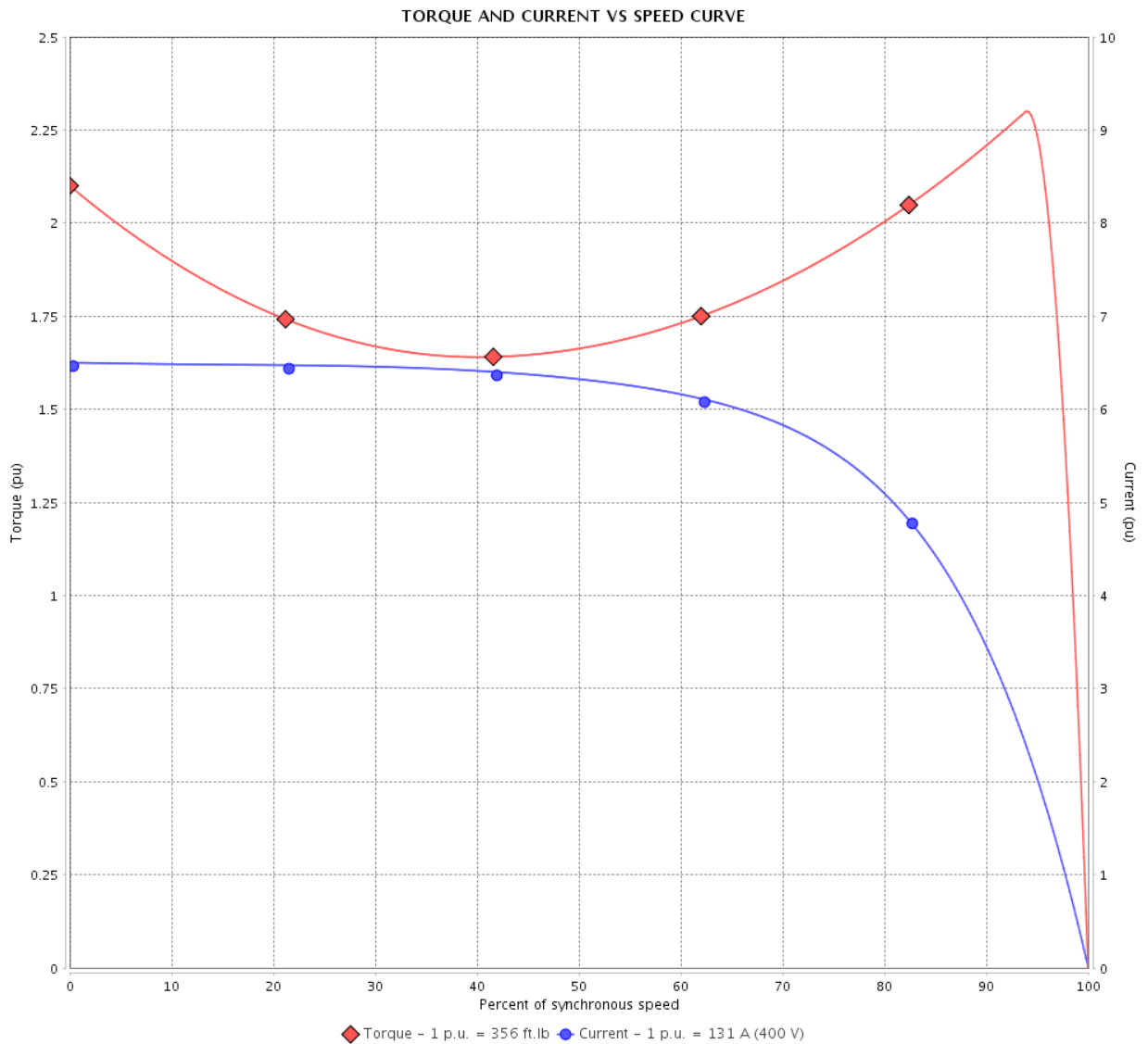

Performance : 400 V 50 Hz 4P IE2

Rated current	: 131 A	Moment of inertia (J)	: 29.9 sq.ft.lb
LRC	: 6.5	Duty cycle	: Cont.(S1)
Rated torque	: 356 ft.lb	Insulation class	: F
Locked rotor torque	: 210 %	Service factor	: 1.00
Breakdown torque	: 229 %	Temperature rise	: 105 K
Rated speed	: 1475 rpm	Design	: B

Locked rotor time : 16s (cold) 9s (hot)

Rev.	Changes Summary	Performed	Checked	Date
Performed by			Page 7 / 36	Revision
Checked by				
Date	14/04/2022			

# TORQUE AND CURRENT VS SPEED CURVE

## Three Phase Induction Motor - Squirrel Cage



Customer :

Product line : NEMA Premium Efficiency Three-Phase

Product code : 11356028

Catalog # : 10018ET3GRB405T-W22

TORQUE AND CURRENT VS SPEED CURVE

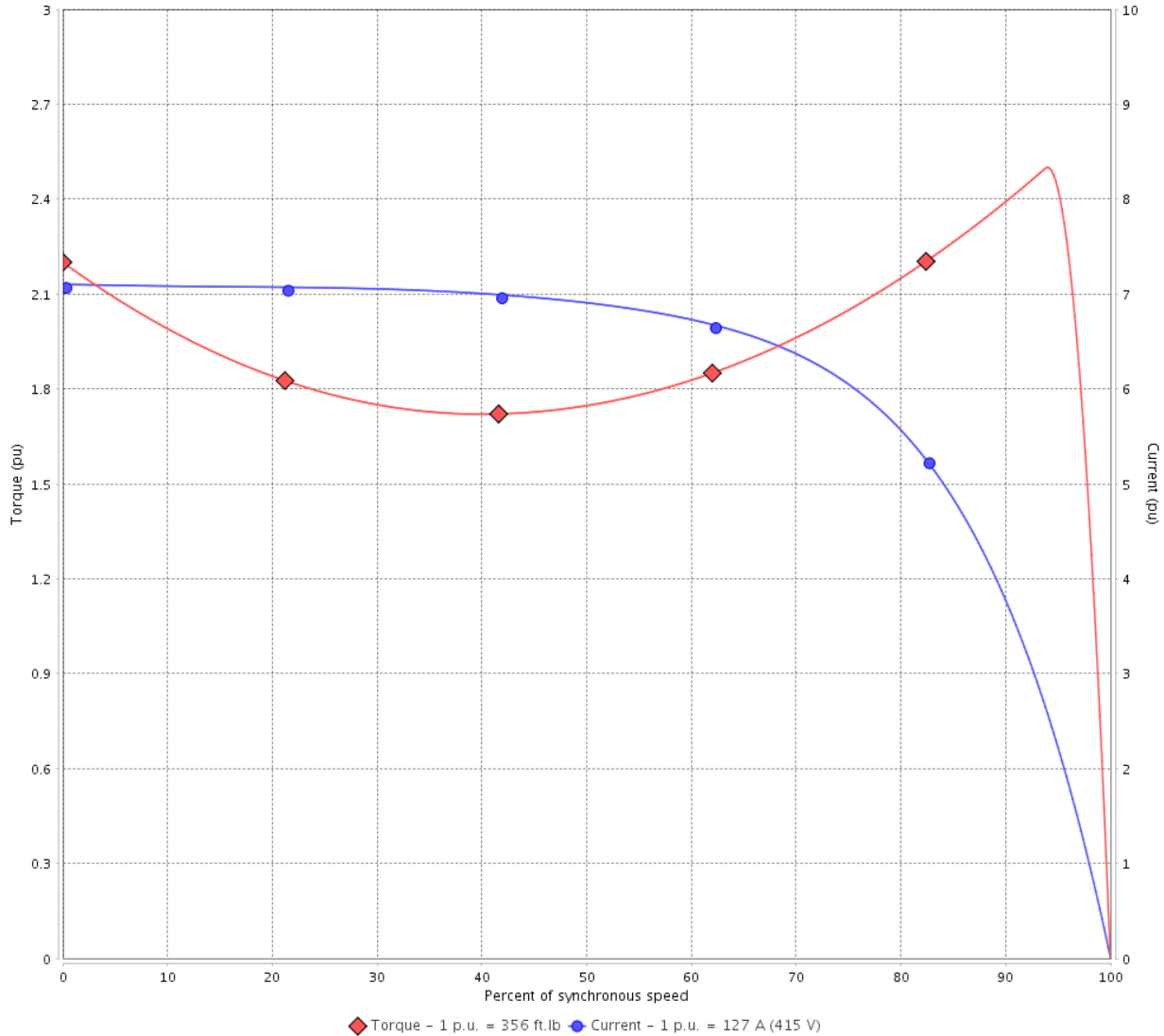

Performance : 415 V 50 Hz 4P IE2

Rated current	: 127 A	Moment of inertia (J)	: 29.9 sq.ft.lb
LRC	: 7.1	Duty cycle	: Cont.(S1)
Rated torque	: 356 ft.lb	Insulation class	: F
Locked rotor torque	: 220 %	Service factor	: 1.00
Breakdown torque	: 250 %	Temperature rise	: 105 K
Rated speed	: 1475 rpm	Design	: B

Locked rotor time : 16s (cold) 9s (hot)

Rev.	Changes Summary	Performed	Checked	Date
Performed by			Page 8 / 36	Revision
Checked by				
Date	14/04/2022			



# LOAD PERFORMANCE CURVE

## Three Phase Induction Motor - Squirrel Cage



Customer : \_\_\_\_\_

Product line : NEMA Premium Efficiency Three-Phase      Product code : 11356028  
 Catalog # : 10018ET3GRB405T-W22

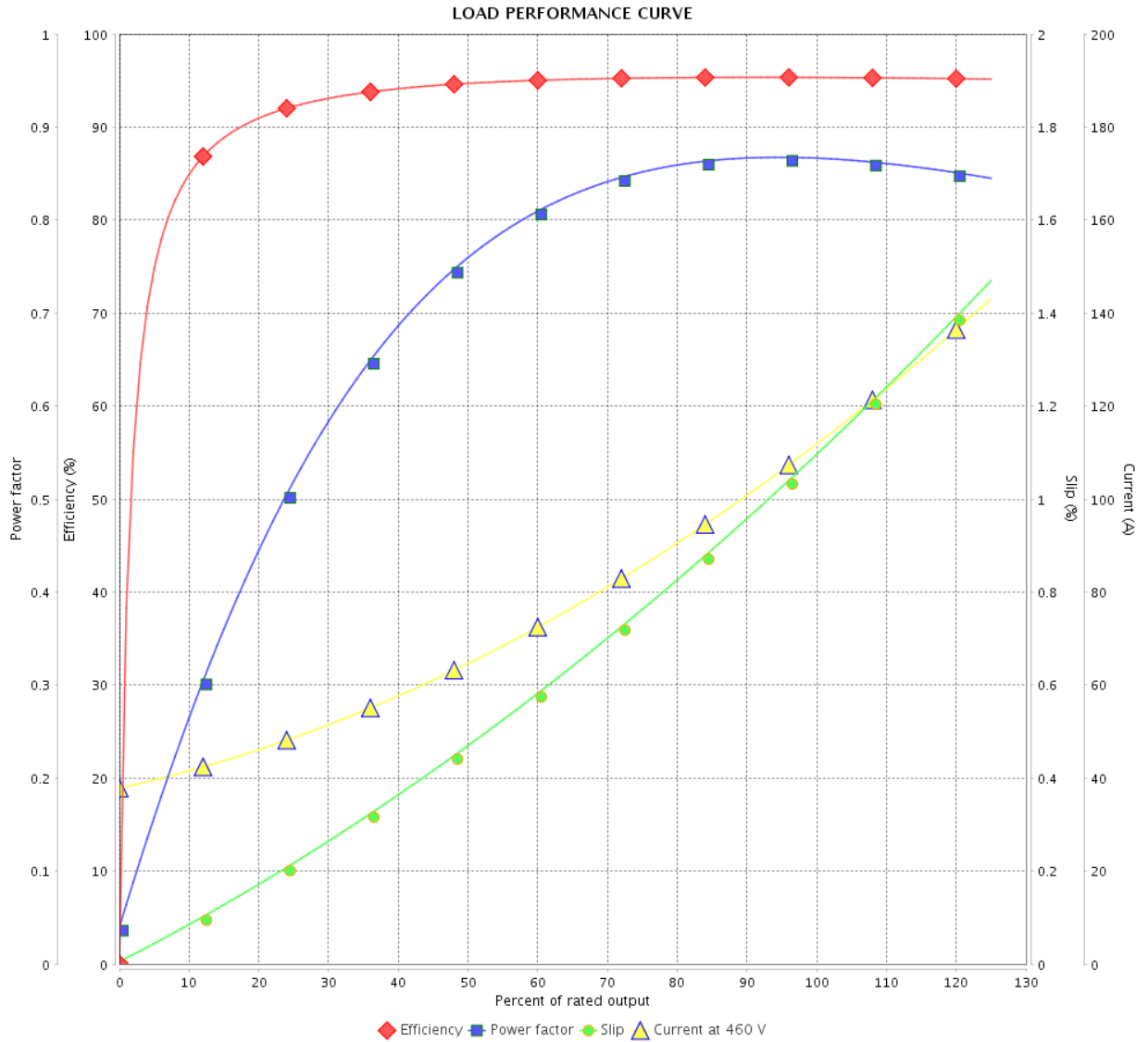

Performance : 460 V 60 Hz 4P

Rated current : 113 A	Moment of inertia (J) : 29.9 sq.ft.lb
LRC : 7.3	Duty cycle : Cont.(S1)
Rated torque : 295 ft.lb	Insulation class : F
Locked rotor torque : 240 %	Service factor : 1.25
Breakdown torque : 260 %	Temperature rise : 80 K
Rated speed : 1780 rpm	Design : B

Rev.	Changes Summary	Performed	Checked	Date
Performed by			Page	Revision
Checked by				
Date				

# LOAD PERFORMANCE CURVE

Three Phase Induction Motor - Squirrel Cage



Customer : \_\_\_\_\_

Product line : NEMA Premium Efficiency Three-Phase

Product code : 11356028

Catalog # : 10018ET3GRB405T-W22

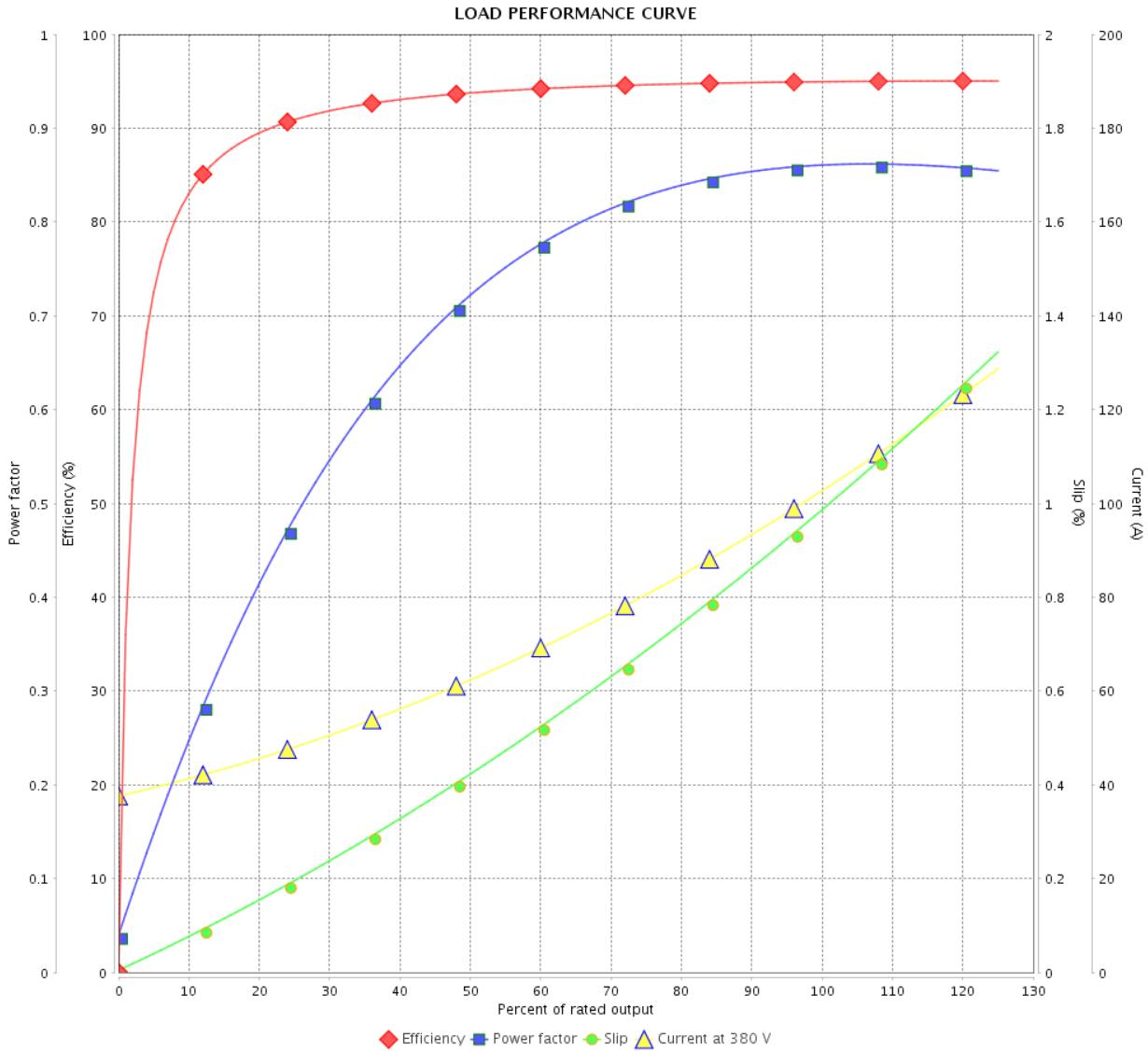

Performance : 380 V 50 Hz 4P IE3

Rated current : 102 A  
 LRC : 7.7  
 Rated torque : 265 ft.lb  
 Locked rotor torque : 260 %  
 Breakdown torque : 280 %  
 Rated speed : 1485 rpm

Moment of inertia (J) : 29.9 sq.ft.lb  
 Duty cycle : Cont.(S1)  
 Insulation class : F  
 Service factor : 1.00  
 Temperature rise : 80 K  
 Design : B

Rev.	Changes Summary	Performed	Checked	Date
Performed by			Page 10 / 36	Revision
Checked by				
Date	14/04/2022			

# LOAD PERFORMANCE CURVE

## Three Phase Induction Motor - Squirrel Cage



Customer : \_\_\_\_\_

Product line : NEMA Premium Efficiency Three-Phase

Product code : 11356028

Catalog # : 10018ET3GRB405T-W22

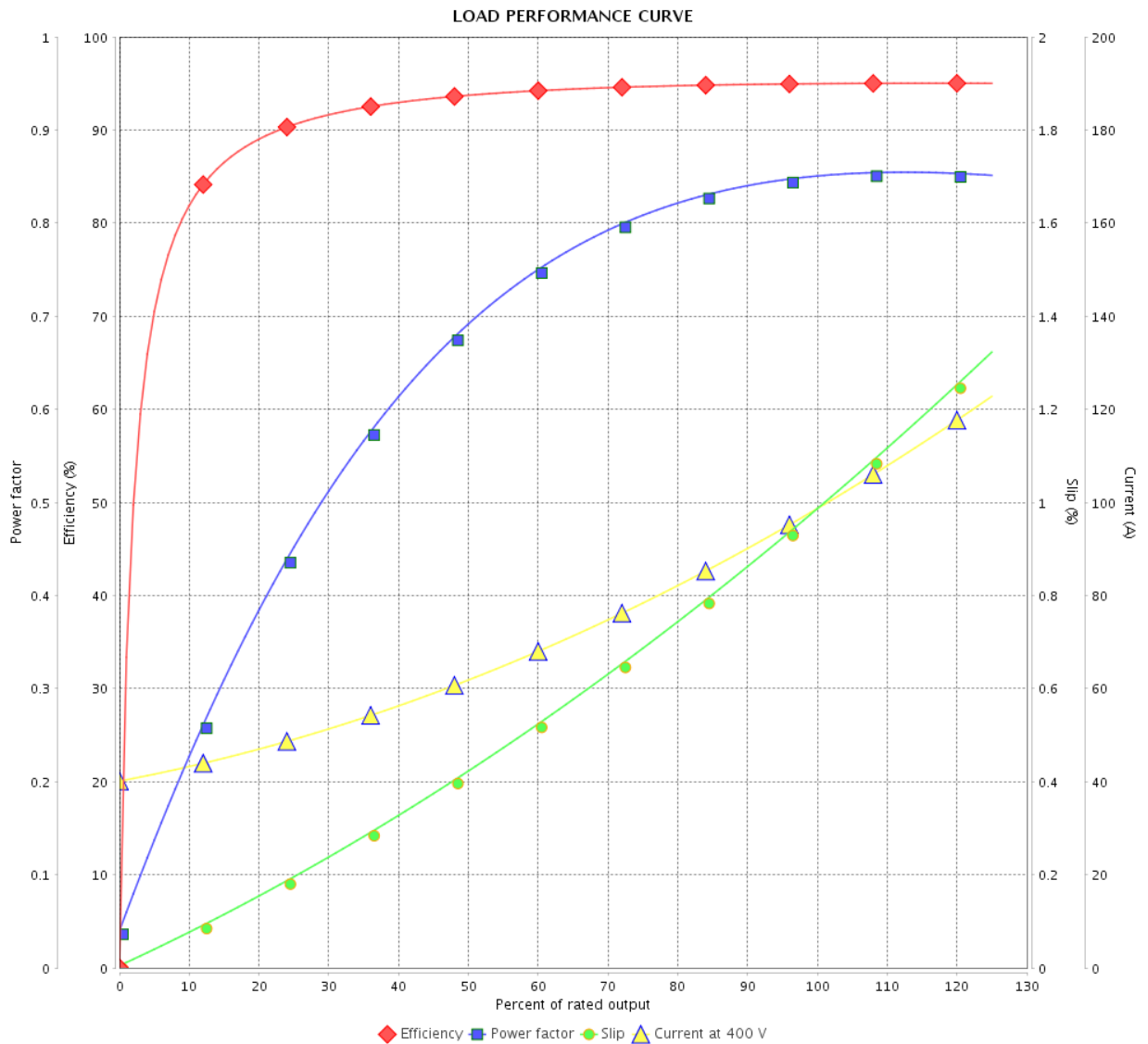

Performance : 400 V 50 Hz 4P IE3

Rated current : 98.3 A  
 LRC : 8.4  
 Rated torque : 265 ft.lb  
 Locked rotor torque : 280 %  
 Breakdown torque : 310 %  
 Rated speed : 1485 rpm

Moment of inertia (J) : 29.9 sq.ft.lb  
 Duty cycle : Cont.(S1)  
 Insulation class : F  
 Service factor : 1.00  
 Temperature rise : 80 K  
 Design : B

Rev.	Changes Summary	Performed	Checked	Date
Performed by		Page		Revision
Checked by		11 / 36		
Date		14/04/2022		

# LOAD PERFORMANCE CURVE

Three Phase Induction Motor - Squirrel Cage



Customer :

Product line : NEMA Premium Efficiency Three-Phase

Product code : 11356028

Catalog # : 10018ET3GRB405T-W22

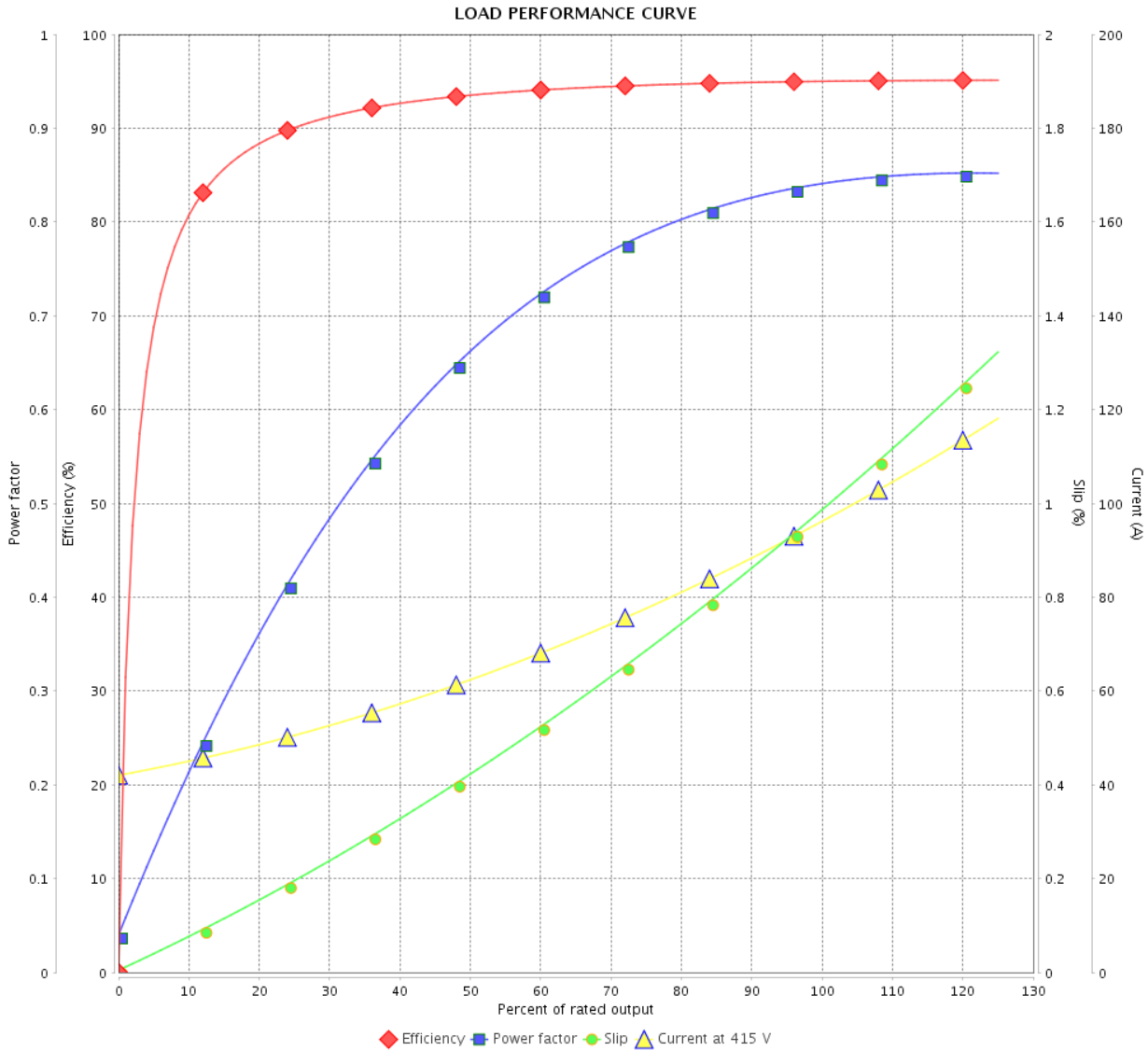

Performance : 415 V 50 Hz 4P IE3

Rated current : 95.9 A  
 LRC : 8.9  
 Rated torque : 265 ft.lb  
 Locked rotor torque : 290 %  
 Breakdown torque : 330 %  
 Rated speed : 1485 rpm

Moment of inertia (J) : 29.9 sq.ft.lb  
 Duty cycle : Cont.(S1)  
 Insulation class : F  
 Service factor : 1.00  
 Temperature rise : 80 K  
 Design : B

Rev.	Changes Summary	Performed	Checked	Date
Performed by		Page		Revision
Checked by		12 / 36		
Date	14/04/2022			

# LOAD PERFORMANCE CURVE

## Three Phase Induction Motor - Squirrel Cage



Customer : \_\_\_\_\_

Product line : NEMA Premium Efficiency Three-Phase

Product code : 11356028

Catalog # : 10018ET3GRB405T-W22

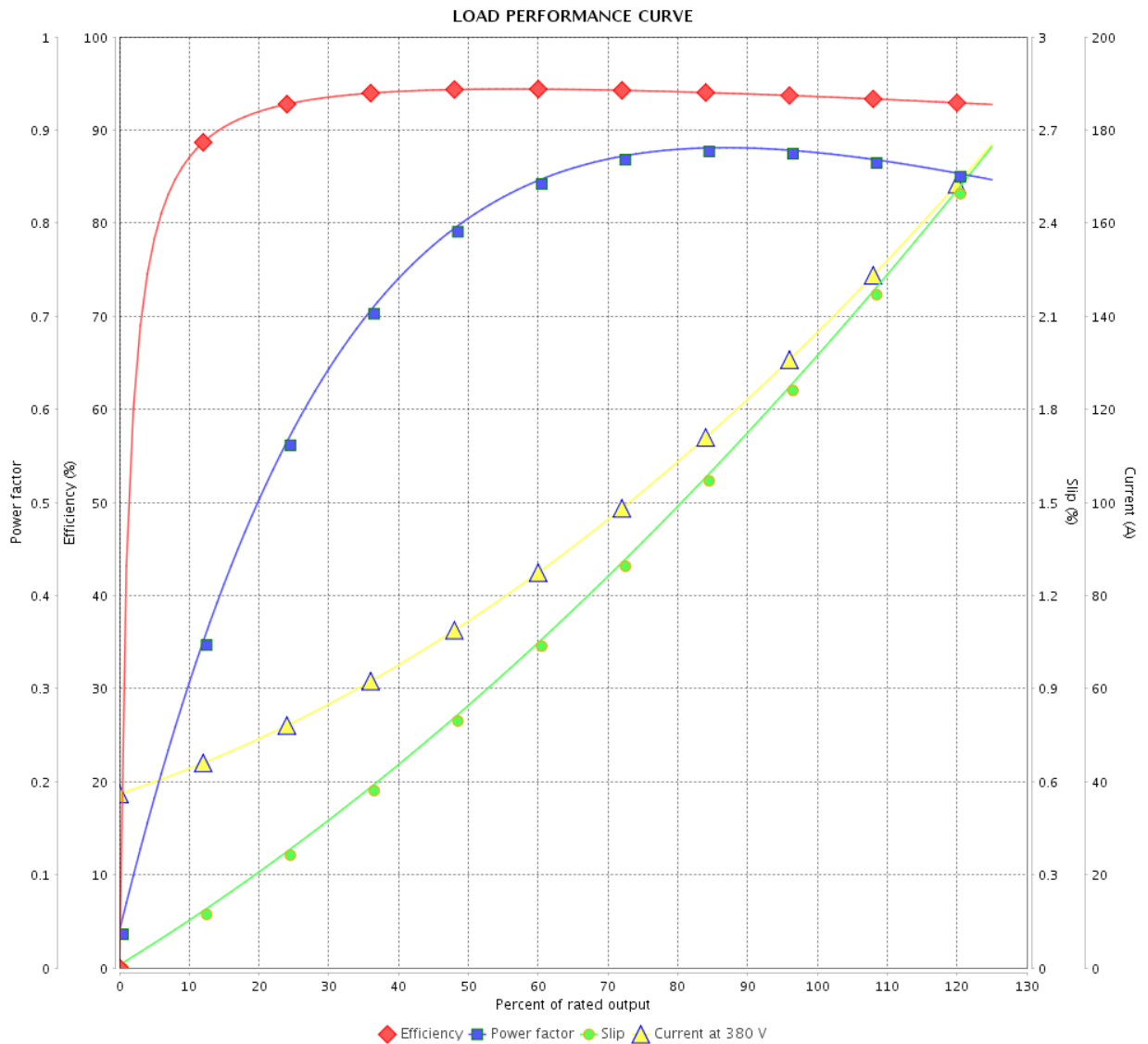

Performance : 380 V 50 Hz 4P IE1

Rated current : 138 A  
 LRC : 5.9  
 Rated torque : 357 ft.lb  
 Locked rotor torque : 190 %  
 Breakdown torque : 210 %  
 Rated speed : 1470 rpm

Moment of inertia (J) : 29.9 sq.ft.lb  
 Duty cycle : Cont.(S1)  
 Insulation class : F  
 Service factor : 1.00  
 Temperature rise : 105 K  
 Design : B

Rev.	Changes Summary	Performed	Checked	Date
Performed by		Page		Revision
Checked by		13 / 36		
Date		14/04/2022		

# LOAD PERFORMANCE CURVE

Three Phase Induction Motor - Squirrel Cage



Customer :

Product line : NEMA Premium Efficiency Three-Phase

Product code : 11356028

Catalog # : 10018ET3GRB405T-W22

LOAD PERFORMANCE CURVE

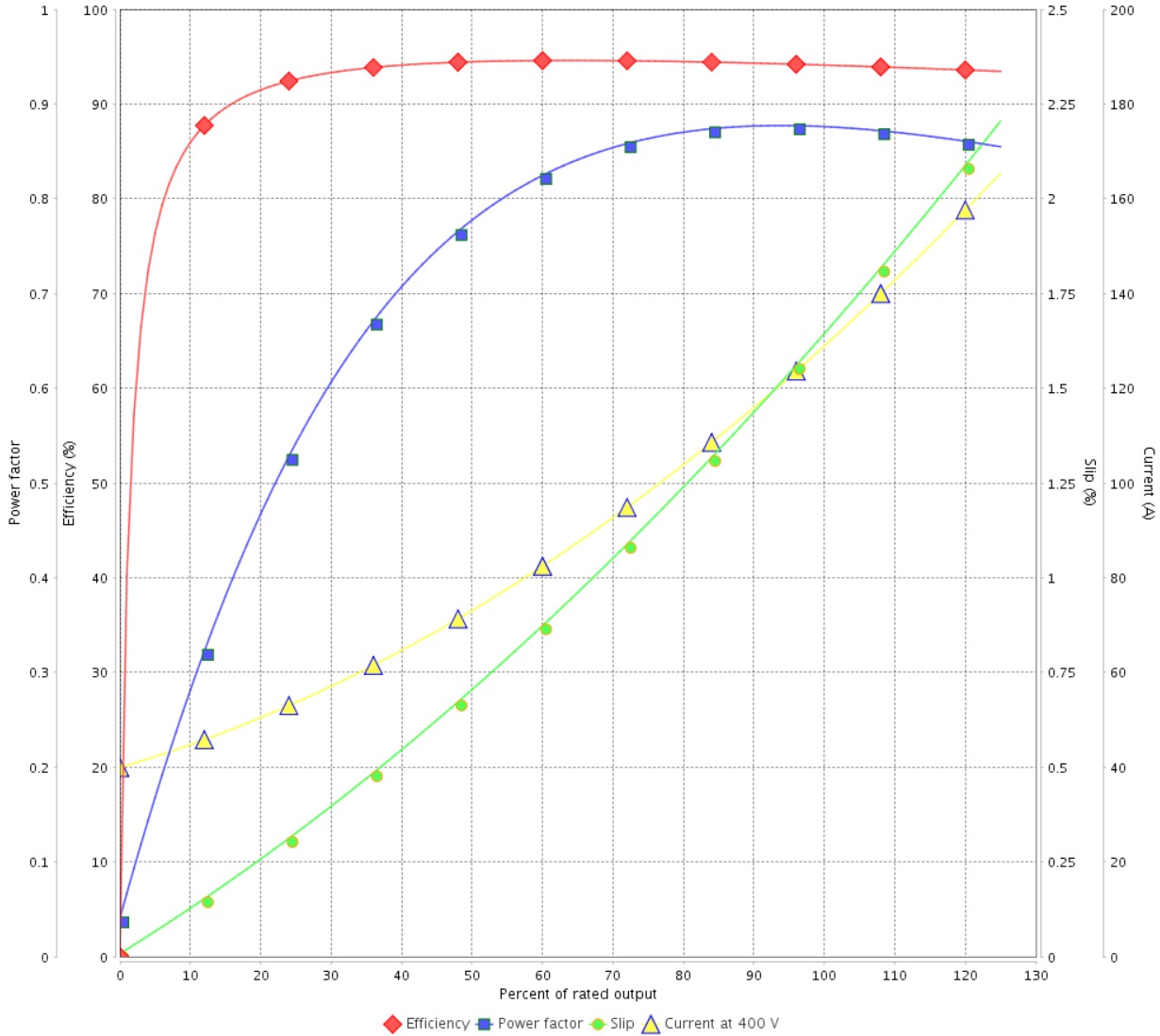

Performance : 400 V 50 Hz 4P IE2

Rated current	: 131 A	Moment of inertia (J)	: 29.9 sq.ft.lb
LRC	: 6.5	Duty cycle	: Cont.(S1)
Rated torque	: 356 ft.lb	Insulation class	: F
Locked rotor torque	: 210 %	Service factor	: 1.00
Breakdown torque	: 229 %	Temperature rise	: 105 K
Rated speed	: 1475 rpm	Design	: B

Rev.	Changes Summary	Performed	Checked	Date
Performed by			Page	Revision
Checked by			14 / 36	
Date	14/04/2022			

# LOAD PERFORMANCE CURVE

## Three Phase Induction Motor - Squirrel Cage



Customer :

Product line : NEMA Premium Efficiency Three-Phase

Product code : 11356028

Catalog # : 10018ET3GRB405T-W22

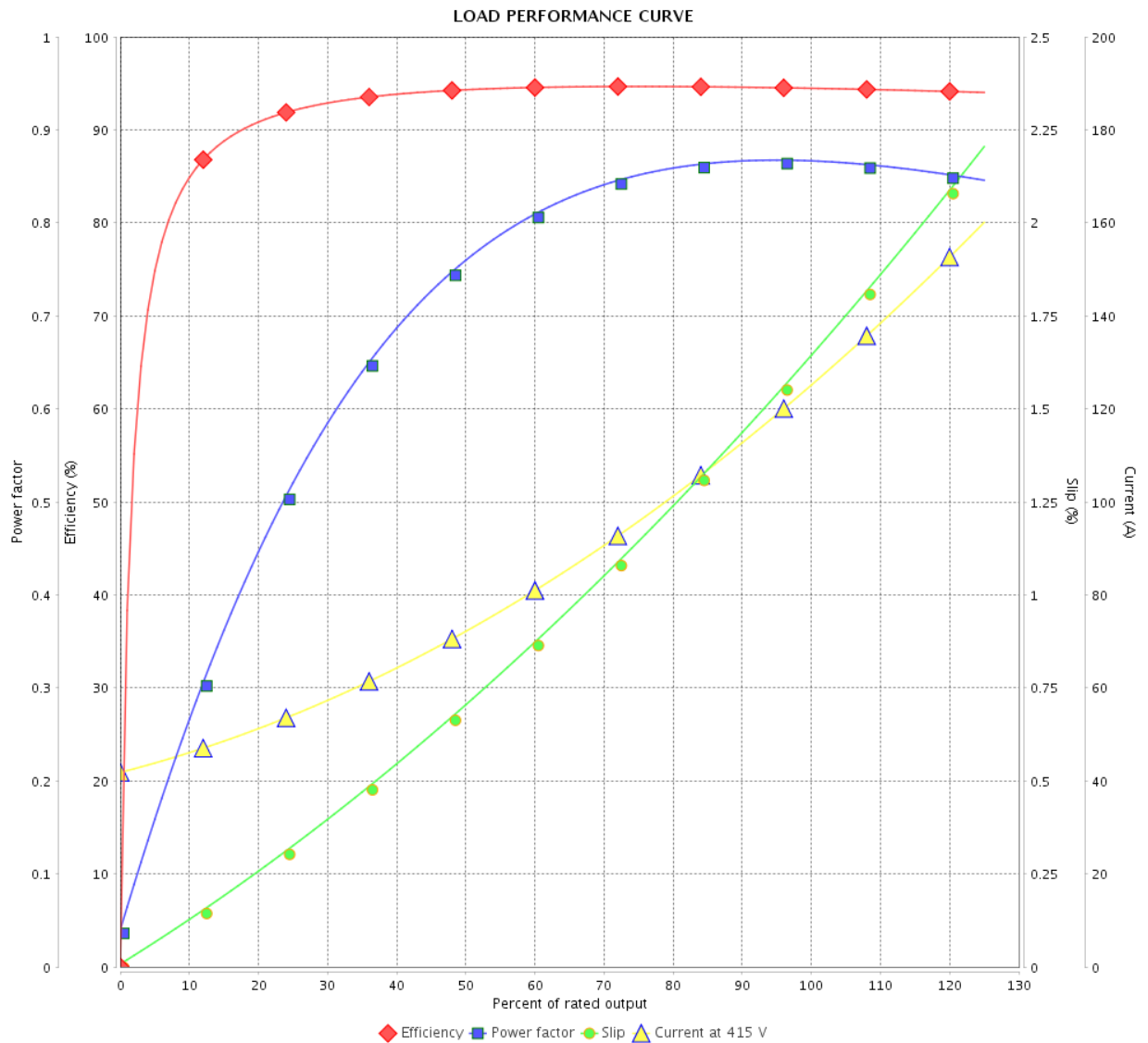

Performance : 415 V 50 Hz 4P IE2

Rated current : 127 A  
 LRC : 7.1  
 Rated torque : 356 ft.lb  
 Locked rotor torque : 220 %  
 Breakdown torque : 250 %  
 Rated speed : 1475 rpm

Moment of inertia (J) : 29.9 sq.ft.lb  
 Duty cycle : Cont.(S1)  
 Insulation class : F  
 Service factor : 1.00  
 Temperature rise : 105 K  
 Design : B

Rev.	Changes Summary	Performed	Checked	Date
Performed by			Page	Revision
Checked by				
Date				
			15 / 36	

# THERMAL LIMIT CURVE

## Three Phase Induction Motor - Squirrel Cage



Customer :

Product line : NEMA Premium Efficiency Three-Phase  
Product code : 11356028  
Catalog # : 10018ET3GRB405T-W22

Performance : 460 V 60 Hz 4P

Rated current	: 113 A	Moment of inertia (J)	: 29.9 sq.ft.lb
LRC	: 7.3	Duty cycle	: Cont.(S1)
Rated torque	: 295 ft.lb	Insulation class	: F
Locked rotor torque	: 240 %	Service factor	: 1.25
Breakdown torque	: 260 %	Temperature rise	: 80 K
Rated speed	: 1780 rpm	Design	: B

Heating constant

Cooling constant

Rev.	Changes Summary	Performed	Checked	Date
Performed by				
Checked by			Page	Revision
Date	14/04/2022		16 / 36	



# THERMAL LIMIT CURVE

Three Phase Induction Motor - Squirrel Cage



Customer : \_\_\_\_\_

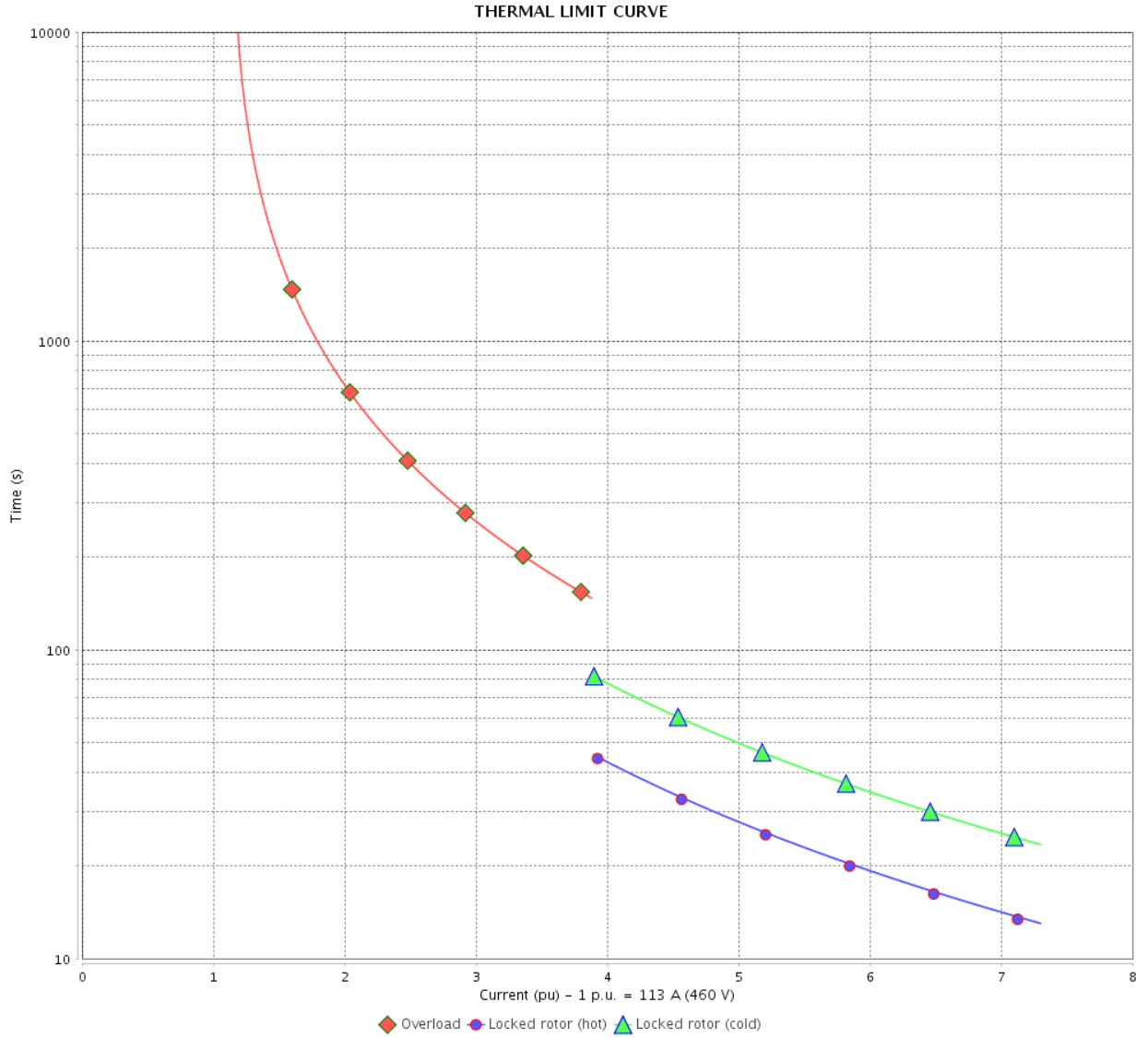

Rev.	Changes Summary	Performed	Checked	Date
Performed by		Page 17 / 36		Revision
Checked by				
Date				

# THERMAL LIMIT CURVE



## Three Phase Induction Motor - Squirrel Cage

Customer :

Product line : NEMA Premium Efficiency Three-Phase  
Product code : 11356028  
Catalog # : 10018ET3GRB405T-W22

Performance : 380 V 50 Hz 4P IE3

Rated current	: 102 A	Moment of inertia (J)	: 29.9 sq.ft.lb
LRC	: 7.7	Duty cycle	: Cont.(S1)
Rated torque	: 265 ft.lb	Insulation class	: F
Locked rotor torque	: 260 %	Service factor	: 1.00
Breakdown torque	: 280 %	Temperature rise	: 80 K
Rated speed	: 1485 rpm	Design	: B

Heating constant

Cooling constant

Rev.	Changes Summary	Performed	Checked	Date
Performed by				
Checked by			Page	Revision
Date	14/04/2022		18 / 36	

# THERMAL LIMIT CURVE

Three Phase Induction Motor - Squirrel Cage



Customer : \_\_\_\_\_

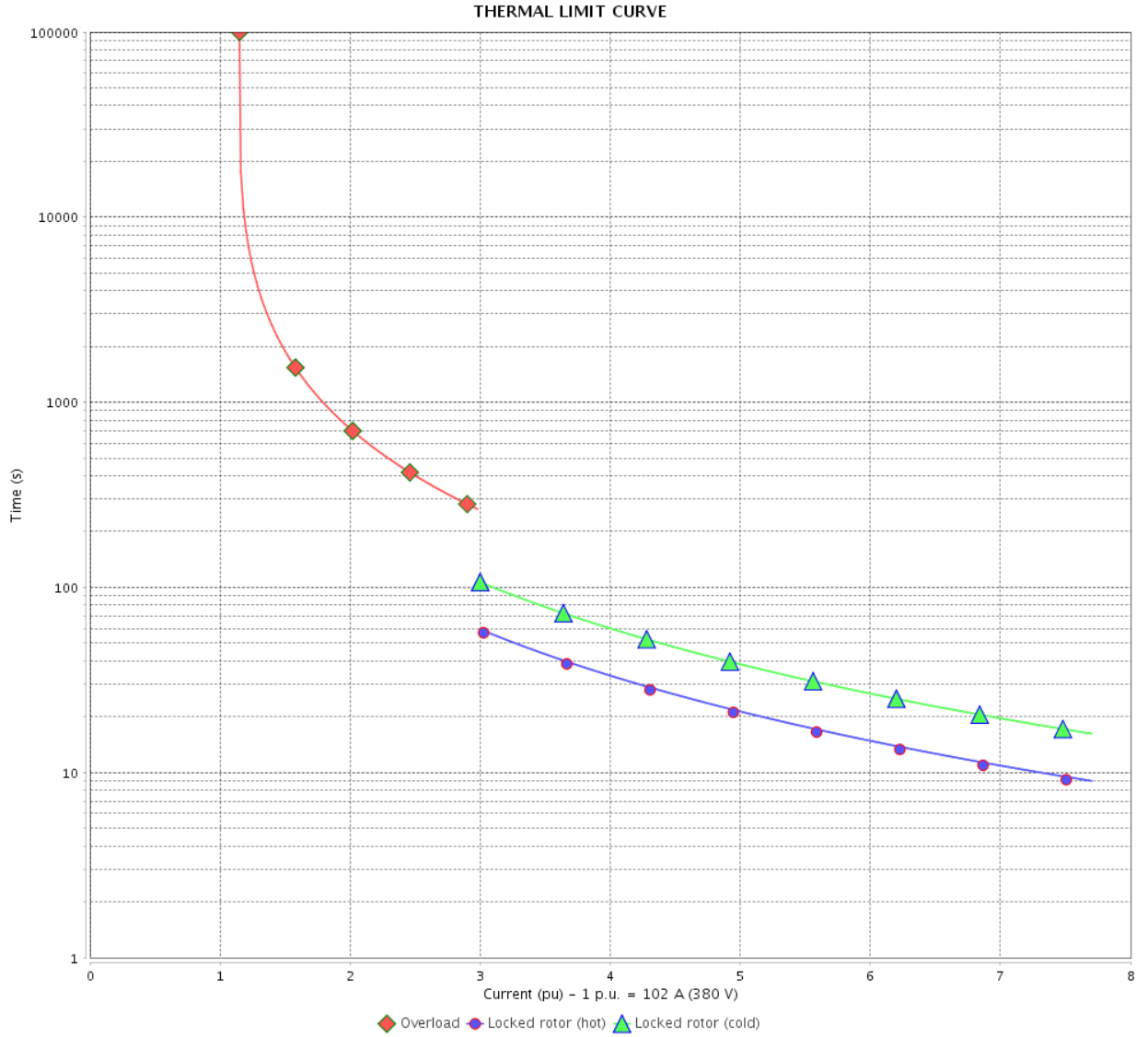

Rev.	Changes Summary	Performed	Checked	Date
Performed by		Page 19 / 36		Revision
Checked by				
Date				

# THERMAL LIMIT CURVE



## Three Phase Induction Motor - Squirrel Cage

Customer :

Product line : NEMA Premium Efficiency Three-Phase  
Product code : 11356028  
Catalog # : 10018ET3GRB405T-W22

Performance : 400 V 50 Hz 4P IE3

Rated current	: 98.3 A	Moment of inertia (J)	: 29.9 sq.ft.lb
LRC	: 8.4	Duty cycle	: Cont.(S1)
Rated torque	: 265 ft.lb	Insulation class	: F
Locked rotor torque	: 280 %	Service factor	: 1.00
Breakdown torque	: 310 %	Temperature rise	: 80 K
Rated speed	: 1485 rpm	Design	: B

Heating constant

Cooling constant

Rev.	Changes Summary	Performed	Checked	Date
Performed by				
Checked by				
Date	14/04/2022		Page 20 / 36	Revision

# THERMAL LIMIT CURVE

Three Phase Induction Motor - Squirrel Cage



Customer : \_\_\_\_\_

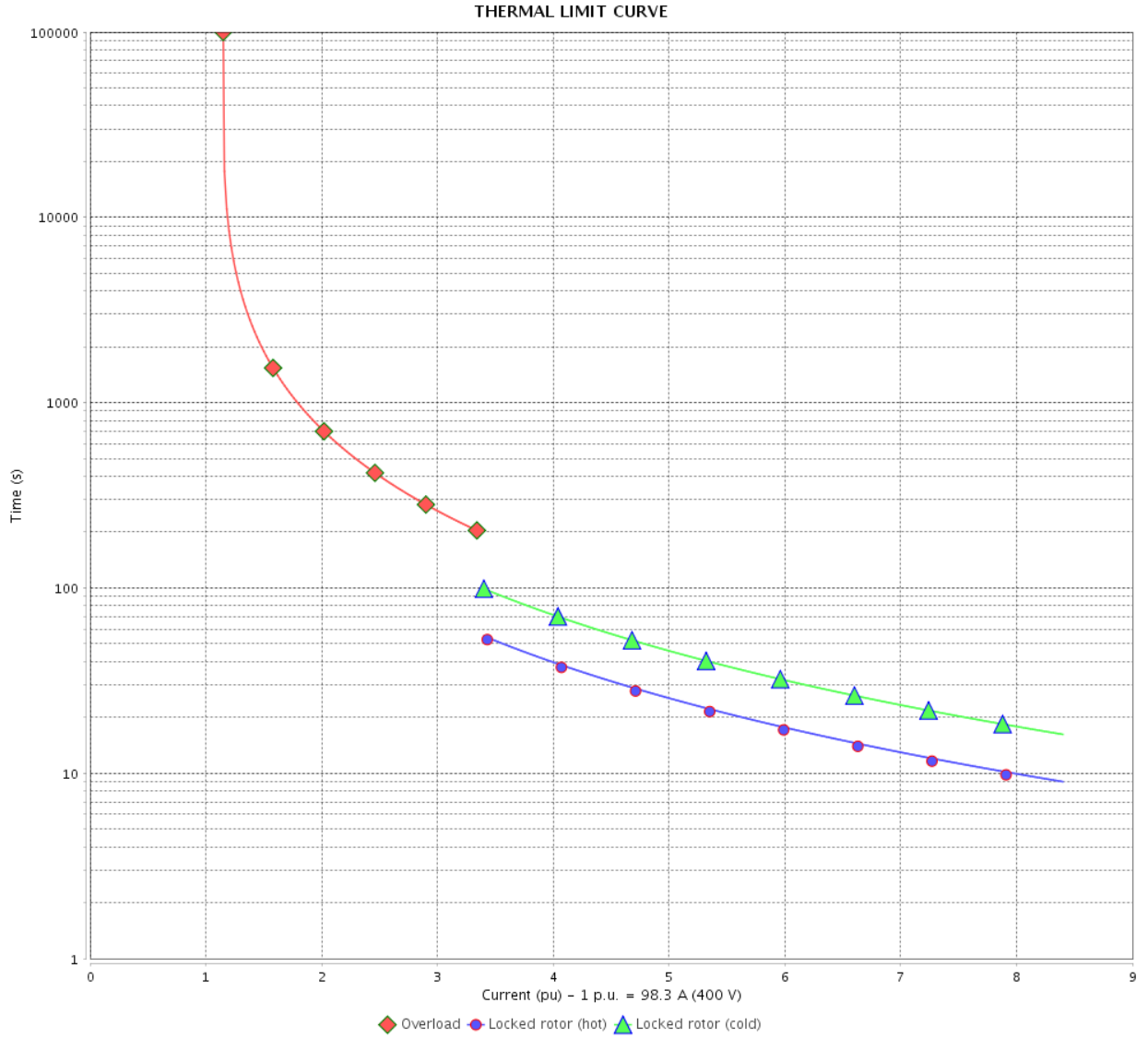

Rev.	Changes Summary	Performed	Checked	Date
Performed by		Page		Revision
Checked by		21 / 36		
Date		14/04/2022		

# THERMAL LIMIT CURVE

## Three Phase Induction Motor - Squirrel Cage



Customer :

Product line : NEMA Premium Efficiency Three-Phase  
Product code : 11356028  
Catalog # : 10018ET3GRB405T-W22

Performance : 415 V 50 Hz 4P IE3

Rated current	: 95.9 A	Moment of inertia (J)	: 29.9 sq.ft.lb
LRC	: 8.9	Duty cycle	: Cont.(S1)
Rated torque	: 265 ft.lb	Insulation class	: F
Locked rotor torque	: 290 %	Service factor	: 1.00
Breakdown torque	: 330 %	Temperature rise	: 80 K
Rated speed	: 1485 rpm	Design	: B

Heating constant

Cooling constant

Rev.	Changes Summary	Performed	Checked	Date
Performed by				
Checked by			Page	Revision
Date	14/04/2022		22 / 36	

# THERMAL LIMIT CURVE

## Three Phase Induction Motor - Squirrel Cage



Customer : \_\_\_\_\_

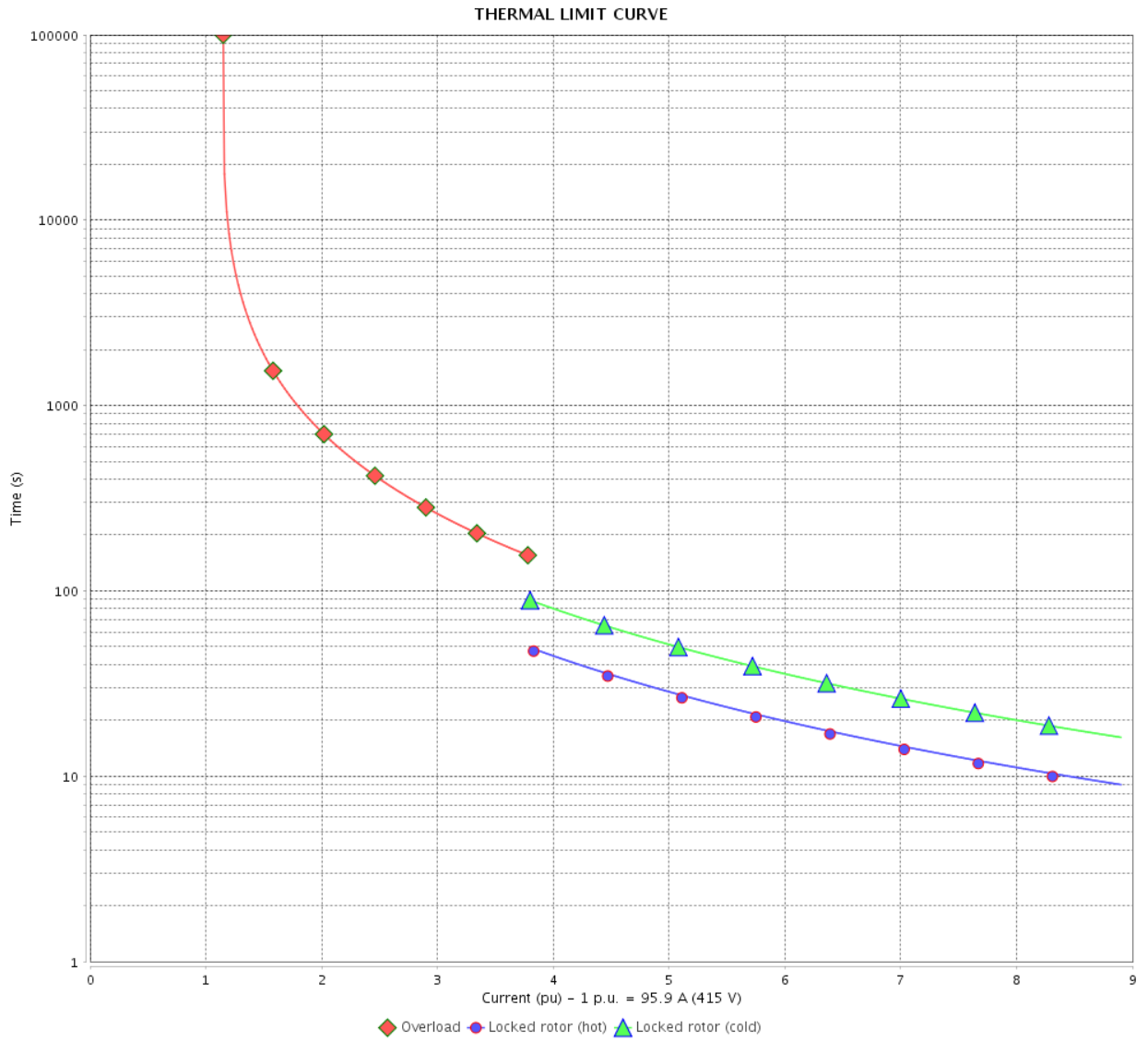

Rev.	Changes Summary	Performed	Checked	Date
Performed by		Page		Revision
Checked by		23 / 36		
Date		14/04/2022		

# THERMAL LIMIT CURVE

## Three Phase Induction Motor - Squirrel Cage



Customer :

Product line : NEMA Premium Efficiency Three-Phase  
Product code : 11356028  
Catalog # : 10018ET3GRB405T-W22

Performance : 380 V 50 Hz 4P IE1

Rated current	: 138 A	Moment of inertia (J)	: 29.9 sq.ft.lb
LRC	: 5.9	Duty cycle	: Cont.(S1)
Rated torque	: 357 ft.lb	Insulation class	: F
Locked rotor torque	: 190 %	Service factor	: 1.00
Breakdown torque	: 210 %	Temperature rise	: 105 K
Rated speed	: 1470 rpm	Design	: B

Heating constant

Cooling constant

Rev.	Changes Summary	Performed	Checked	Date
Performed by				
Checked by			Page	Revision
Date	14/04/2022		24 / 36	



# THERMAL LIMIT CURVE

Three Phase Induction Motor - Squirrel Cage



Customer : \_\_\_\_\_

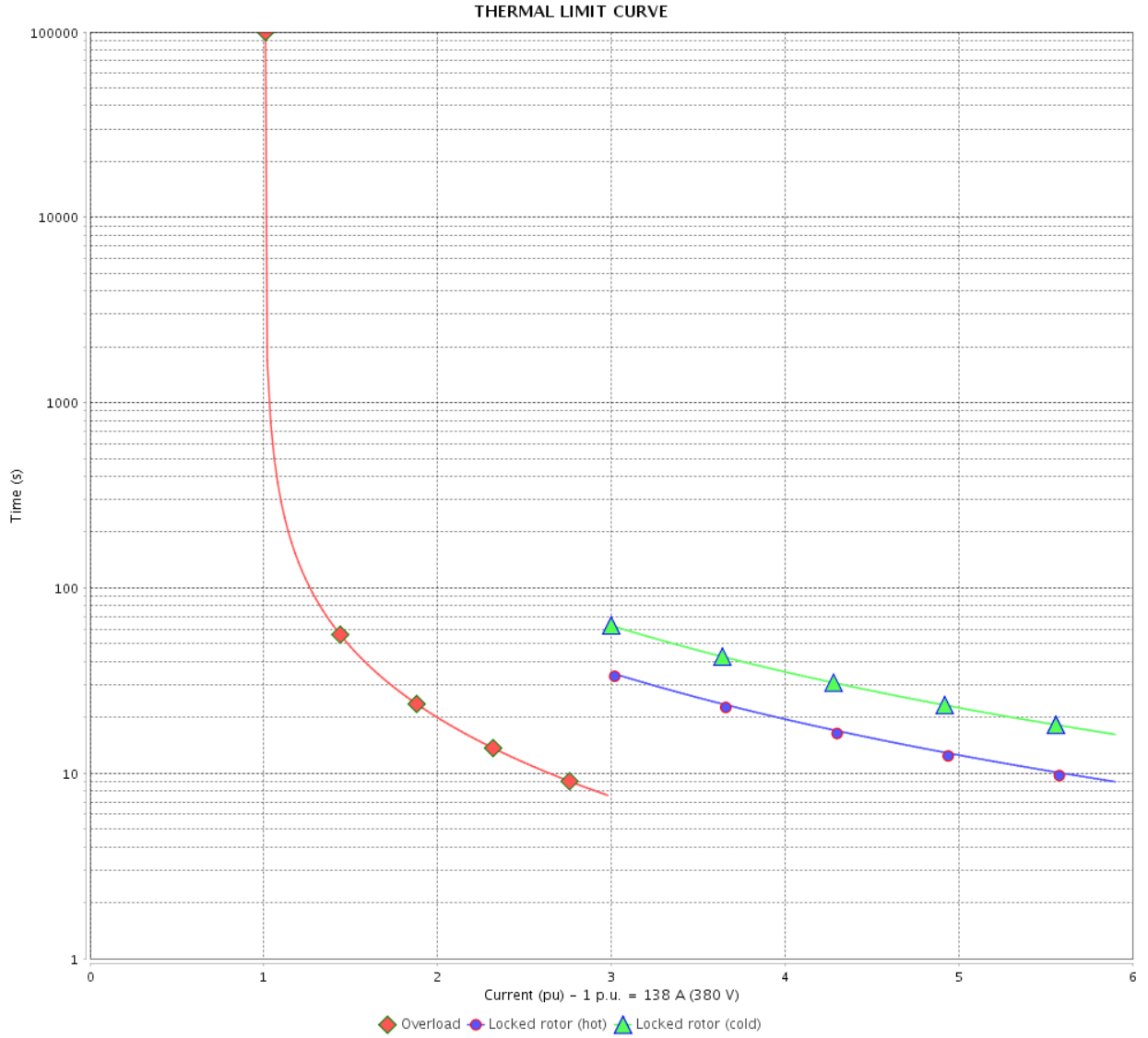

Rev.	Changes Summary	Performed	Checked	Date
Performed by				
Checked by				
Date				
			Page	Revision
			25 / 36	

# THERMAL LIMIT CURVE

## Three Phase Induction Motor - Squirrel Cage



Customer :

Product line : NEMA Premium Efficiency Three-Phase  
Product code : 11356028  
Catalog # : 10018ET3GRB405T-W22

Performance : 400 V 50 Hz 4P IE2

Rated current	: 131 A	Moment of inertia (J)	: 29.9 sq.ft.lb
LRC	: 6.5	Duty cycle	: Cont.(S1)
Rated torque	: 356 ft.lb	Insulation class	: F
Locked rotor torque	: 210 %	Service factor	: 1.00
Breakdown torque	: 229 %	Temperature rise	: 105 K
Rated speed	: 1475 rpm	Design	: B

Heating constant

Cooling constant

Rev.	Changes Summary	Performed	Checked	Date
Performed by				
Checked by				
Date	14/04/2022		Page 26 / 36	Revision

# THERMAL LIMIT CURVE

Three Phase Induction Motor - Squirrel Cage



Customer : \_\_\_\_\_

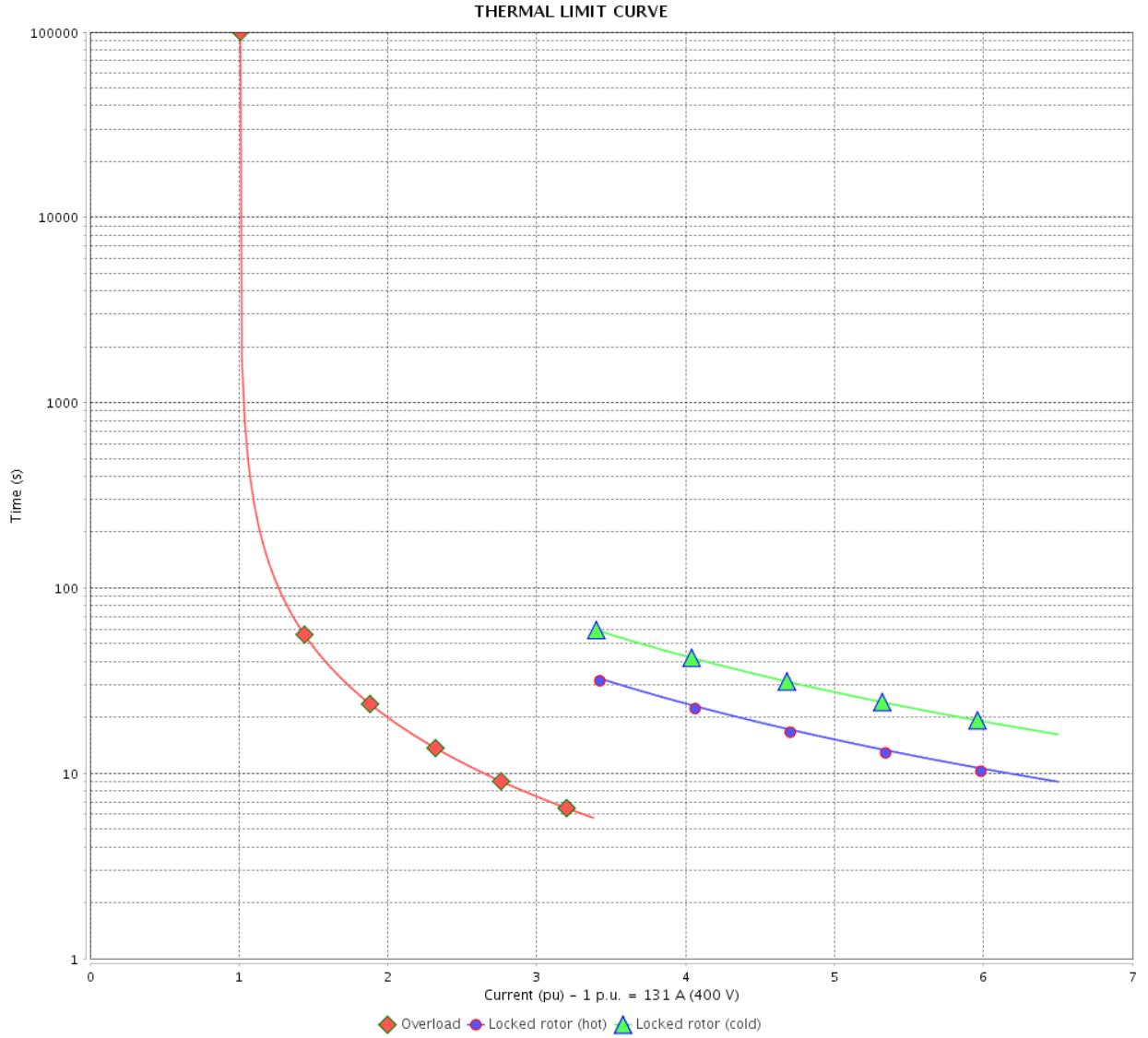

Rev.	Changes Summary	Performed	Checked	Date
Performed by		Page 27 / 36		Revision
Checked by				
Date				

# THERMAL LIMIT CURVE

## Three Phase Induction Motor - Squirrel Cage



Customer :

Product line : NEMA Premium Efficiency Three-Phase  
Product code : 11356028  
Catalog # : 10018ET3GRB405T-W22

Performance : 415 V 50 Hz 4P IE2

Rated current	: 127 A	Moment of inertia (J)	: 29.9 sq.ft.lb
LRC	: 7.1	Duty cycle	: Cont.(S1)
Rated torque	: 356 ft.lb	Insulation class	: F
Locked rotor torque	: 220 %	Service factor	: 1.00
Breakdown torque	: 250 %	Temperature rise	: 105 K
Rated speed	: 1475 rpm	Design	: B

Heating constant

Cooling constant

Rev.	Changes Summary	Performed	Checked	Date
Performed by				
Checked by			Page	Revision
Date	14/04/2022		28 / 36	

# THERMAL LIMIT CURVE

Three Phase Induction Motor - Squirrel Cage



Customer : \_\_\_\_\_

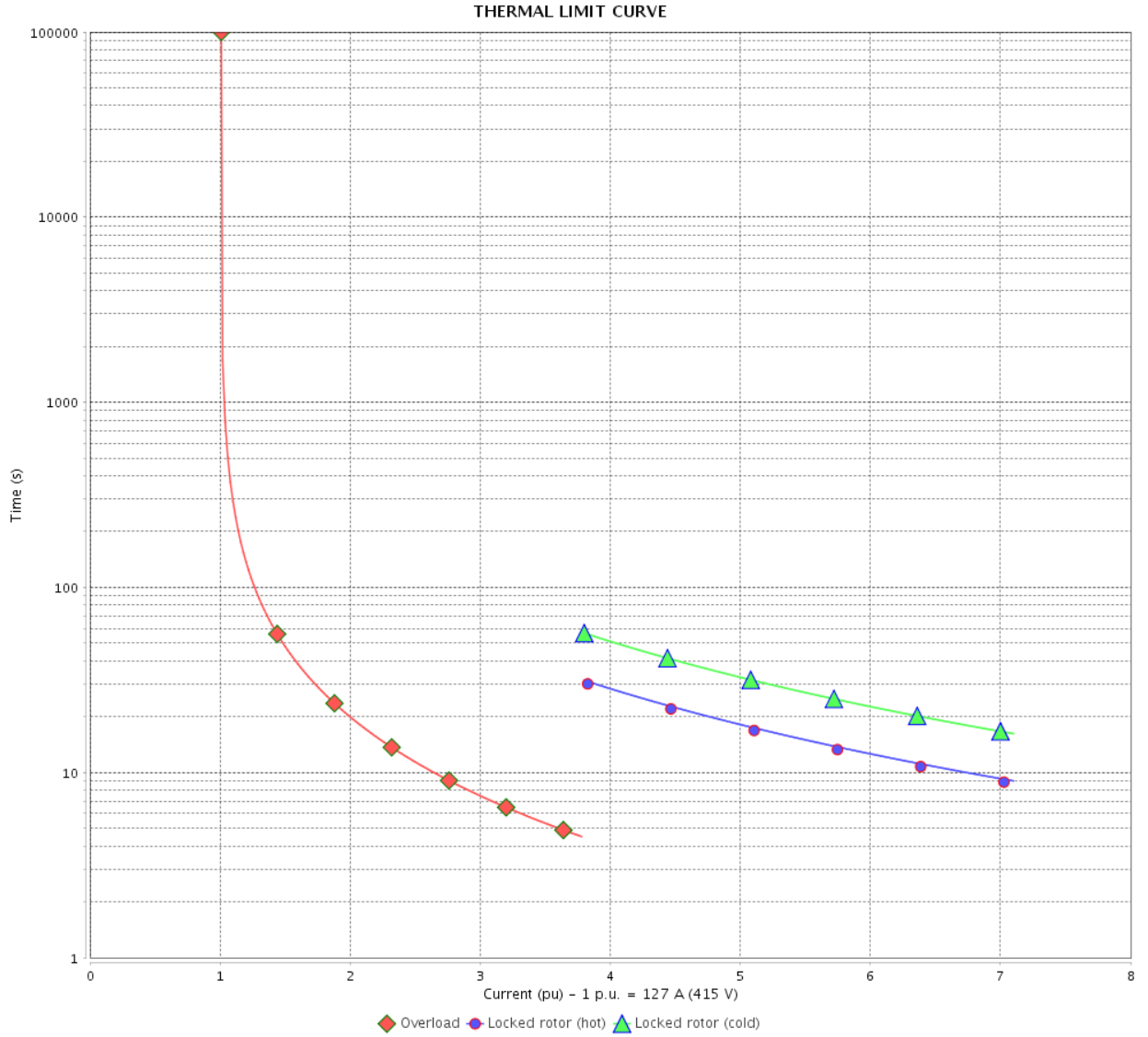

Rev.	Changes Summary	Performed	Checked	Date
Performed by		Page 29 / 36		Revision
Checked by				
Date				

# VFD OPERATION CURVE

Three Phase Induction Motor - Squirrel Cage



Customer :

Product line : NEMA Premium Efficiency Three-Phase

Product code : 11356028

Catalog # : 10018ET3GRB405T-W22

VFD OPERATION CURVE

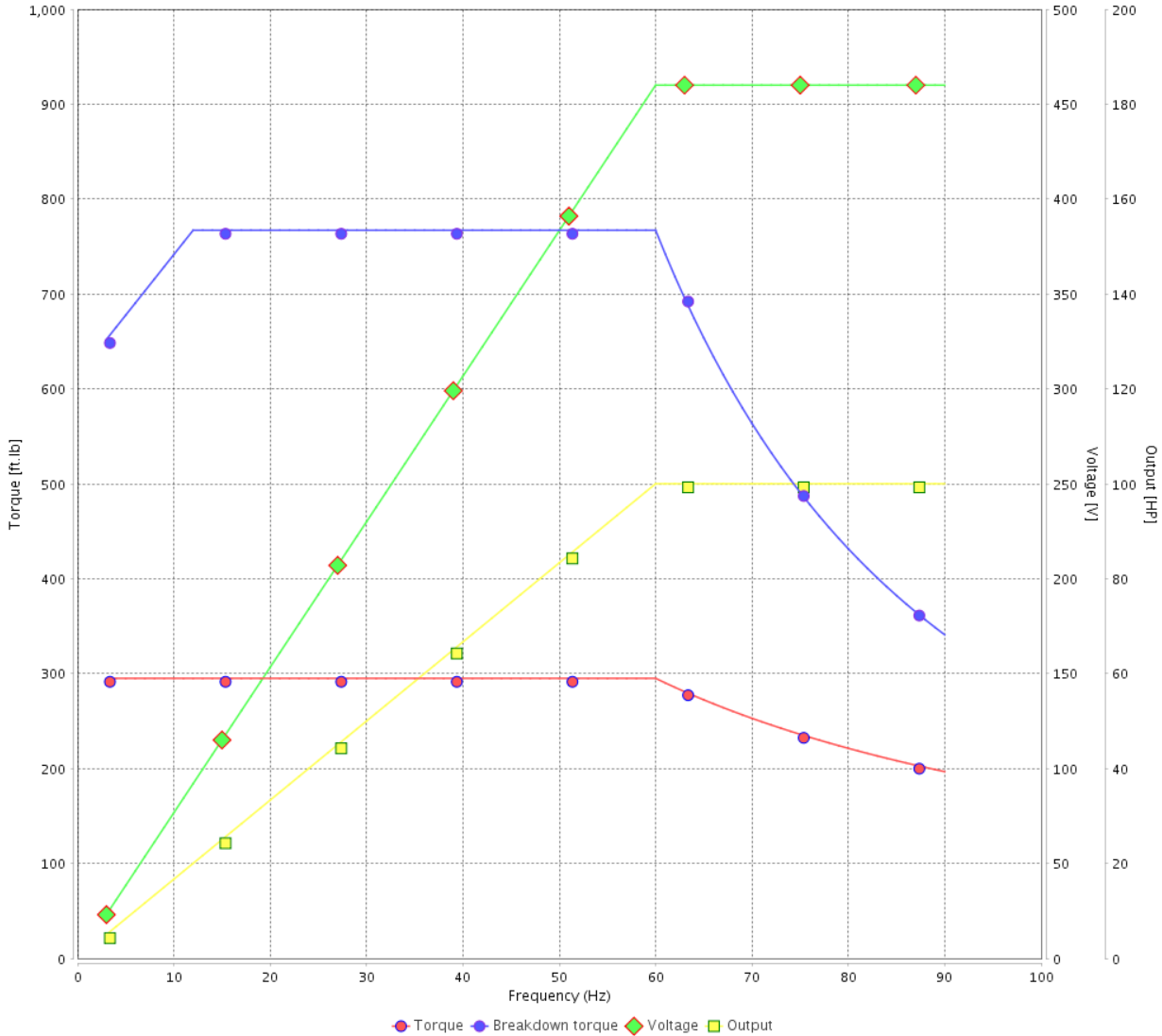

Performance : 460 V 60 Hz 4P

Rated current : 113 A  
 LRC : 7.3  
 Rated torque : 295 ft.lb  
 Locked rotor torque : 240 %  
 Breakdown torque : 260 %  
 Rated speed : 1780 rpm

Moment of inertia (J) : 29.9 sq.ft.lb  
 Duty cycle : Cont.(S1)  
 Insulation class : F  
 Service factor : 1.25  
 Temperature rise : 80 K  
 Design : B

Rev.	Changes Summary	Performed	Checked	Date
Performed by			Page 30 / 36	Revision
Checked by				
Date	14/04/2022			

# VFD OPERATION CURVE

## Three Phase Induction Motor - Squirrel Cage



Customer :

Product line : NEMA Premium Efficiency Three-Phase

Product code : 11356028

Catalog # : 10018ET3GRB405T-W22

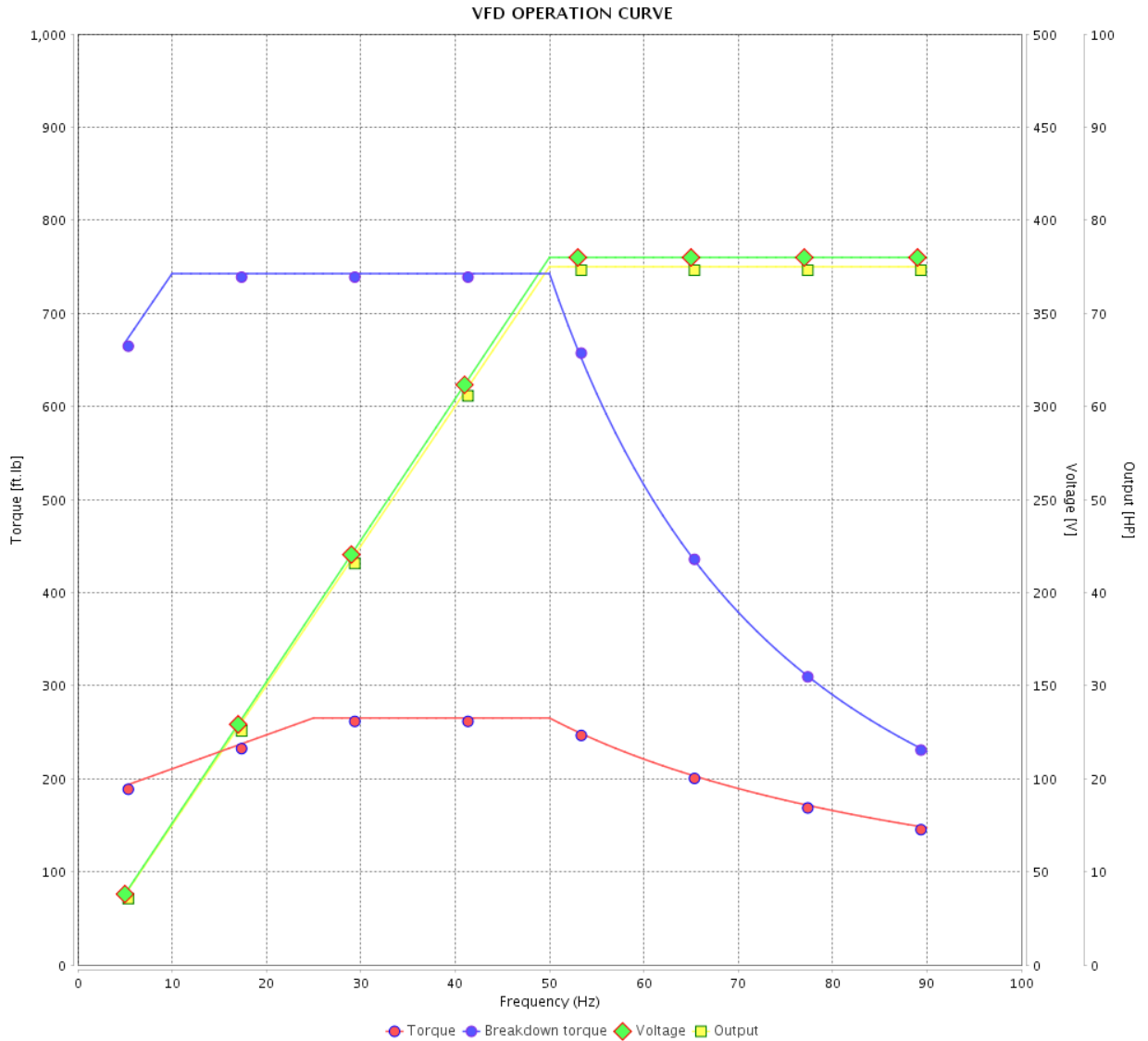

Performance : 380 V 50 Hz 4P IE3

Rated current : 102 A  
 LRC : 7.7  
 Rated torque : 265 ft.lb  
 Locked rotor torque : 260 %  
 Breakdown torque : 280 %  
 Rated speed : 1485 rpm

Moment of inertia (J) : 29.9 sq.ft.lb  
 Duty cycle : Cont.(S1)  
 Insulation class : F  
 Service factor : 1.00  
 Temperature rise : 80 K  
 Design : B

Rev.	Changes Summary	Performed	Checked	Date
Performed by				Page 31 / 36
Checked by				
Date	14/04/2022			
				Revision

# VFD OPERATION CURVE

Three Phase Induction Motor - Squirrel Cage



Customer :

Product line : NEMA Premium Efficiency Three-Phase

Product code : 11356028

Catalog # : 10018ET3GRB405T-W22

VFD OPERATION CURVE

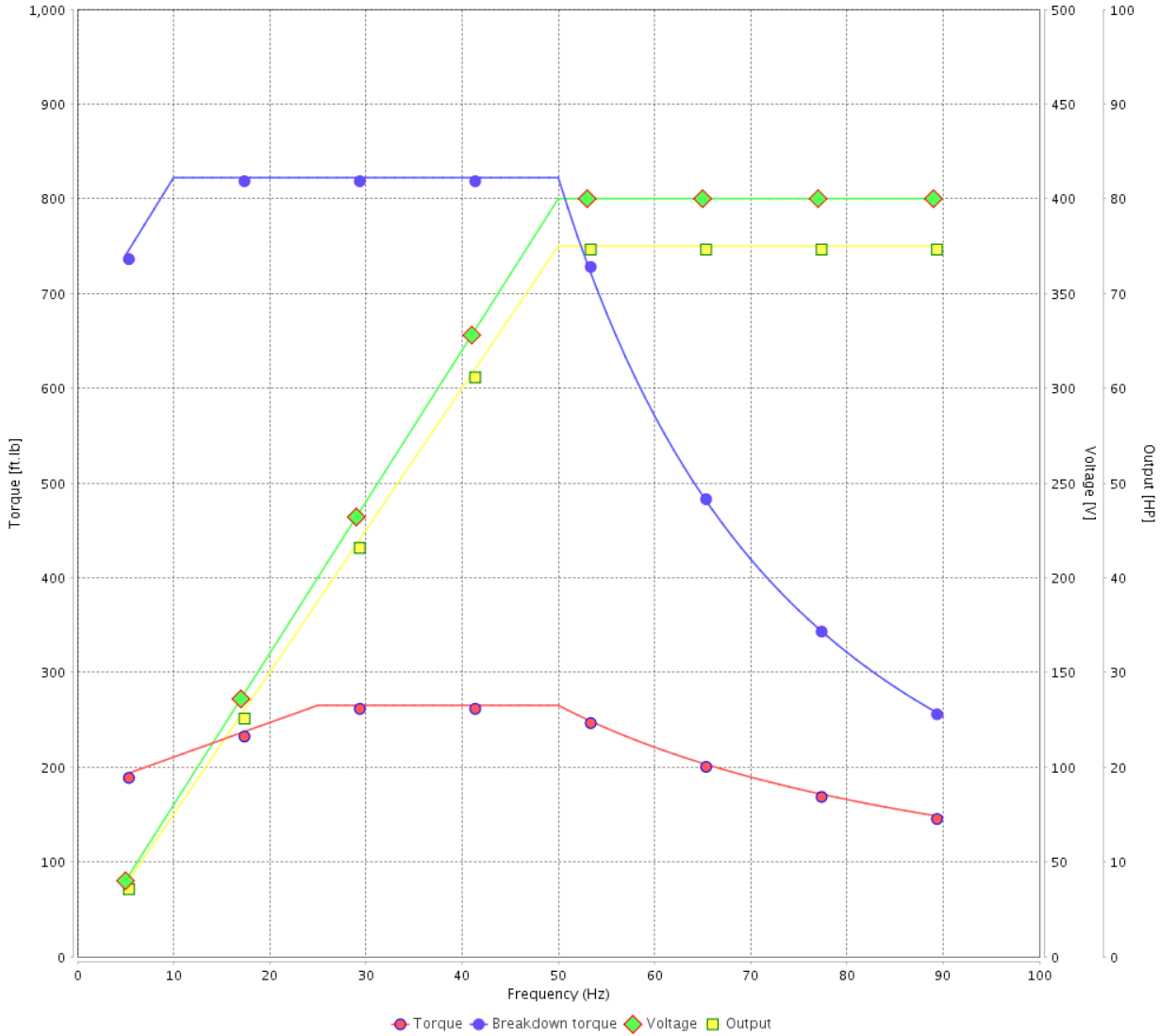

Performance : 400 V 50 Hz 4P IE3

Rated current	: 98.3 A	Moment of inertia (J)	: 29.9 sq.ft.lb
LRC	: 8.4	Duty cycle	: Cont.(S1)
Rated torque	: 265 ft.lb	Insulation class	: F
Locked rotor torque	: 280 %	Service factor	: 1.00
Breakdown torque	: 310 %	Temperature rise	: 80 K
Rated speed	: 1485 rpm	Design	: B

Rev.	Changes Summary	Performed	Checked	Date
Performed by			Page 32 / 36	Revision
Checked by				
Date	14/04/2022			



# VFD OPERATION CURVE

Three Phase Induction Motor - Squirrel Cage



Customer : \_\_\_\_\_

Product line : NEMA Premium Efficiency Three-Phase

Product code : 11356028

Catalog # : 10018ET3GRB405T-W22

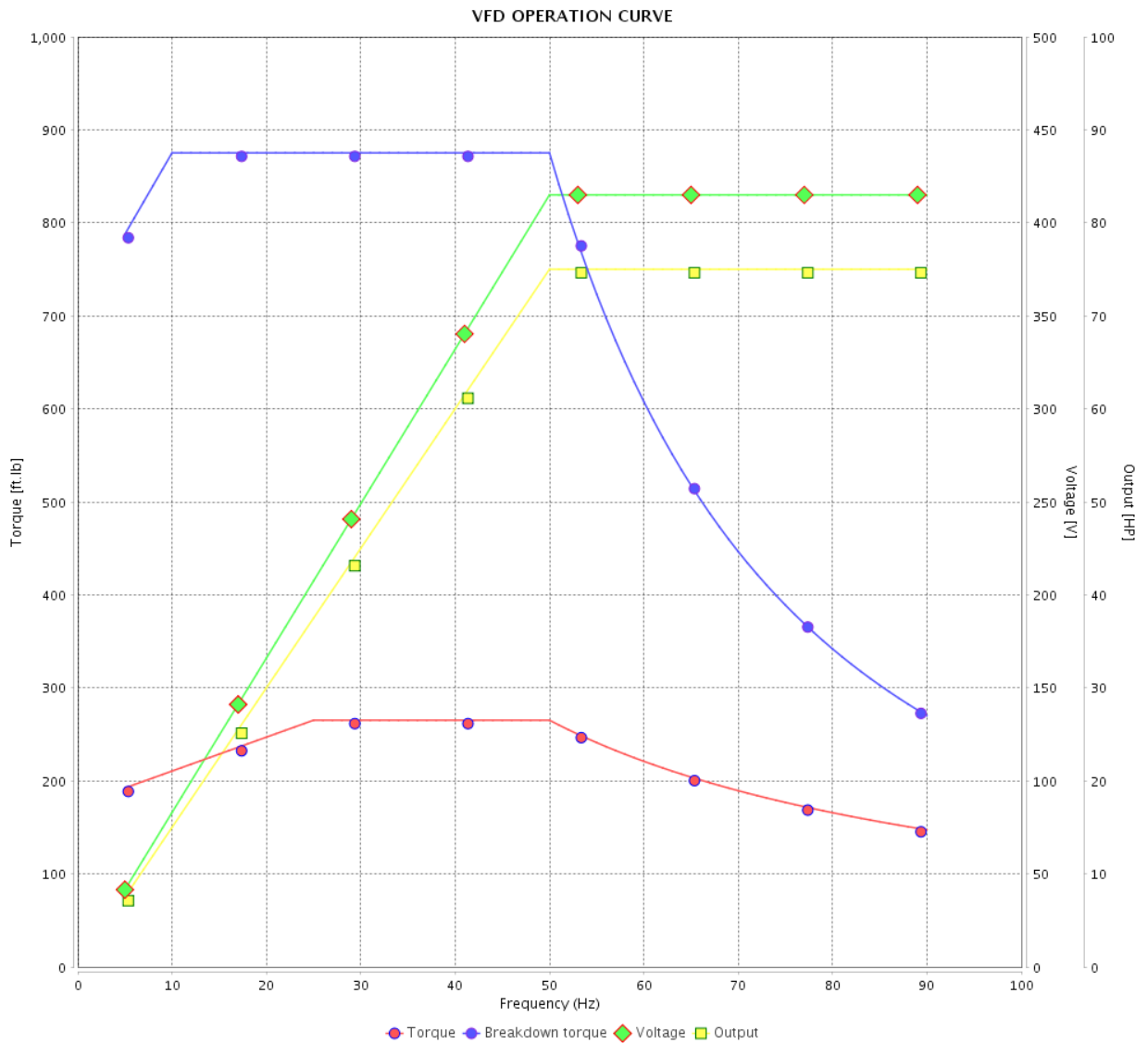

Performance : 415 V 50 Hz 4P IE3

Rated current : 95.9 A  
 LRC : 8.9  
 Rated torque : 265 ft.lb  
 Locked rotor torque : 290 %  
 Breakdown torque : 330 %  
 Rated speed : 1485 rpm

Moment of inertia (J) : 29.9 sq.ft.lb  
 Duty cycle : Cont.(S1)  
 Insulation class : F  
 Service factor : 1.00  
 Temperature rise : 80 K  
 Design : B

Rev.	Changes Summary	Performed	Checked	Date
Performed by		Page		Revision
Checked by		33 / 36		
Date	14/04/2022			

# VFD OPERATION CURVE

Three Phase Induction Motor - Squirrel Cage



Customer :

Product line : NEMA Premium Efficiency Three-Phase

Product code : 11356028

Catalog # : 10018ET3GRB405T-W22

VFD OPERATION CURVE

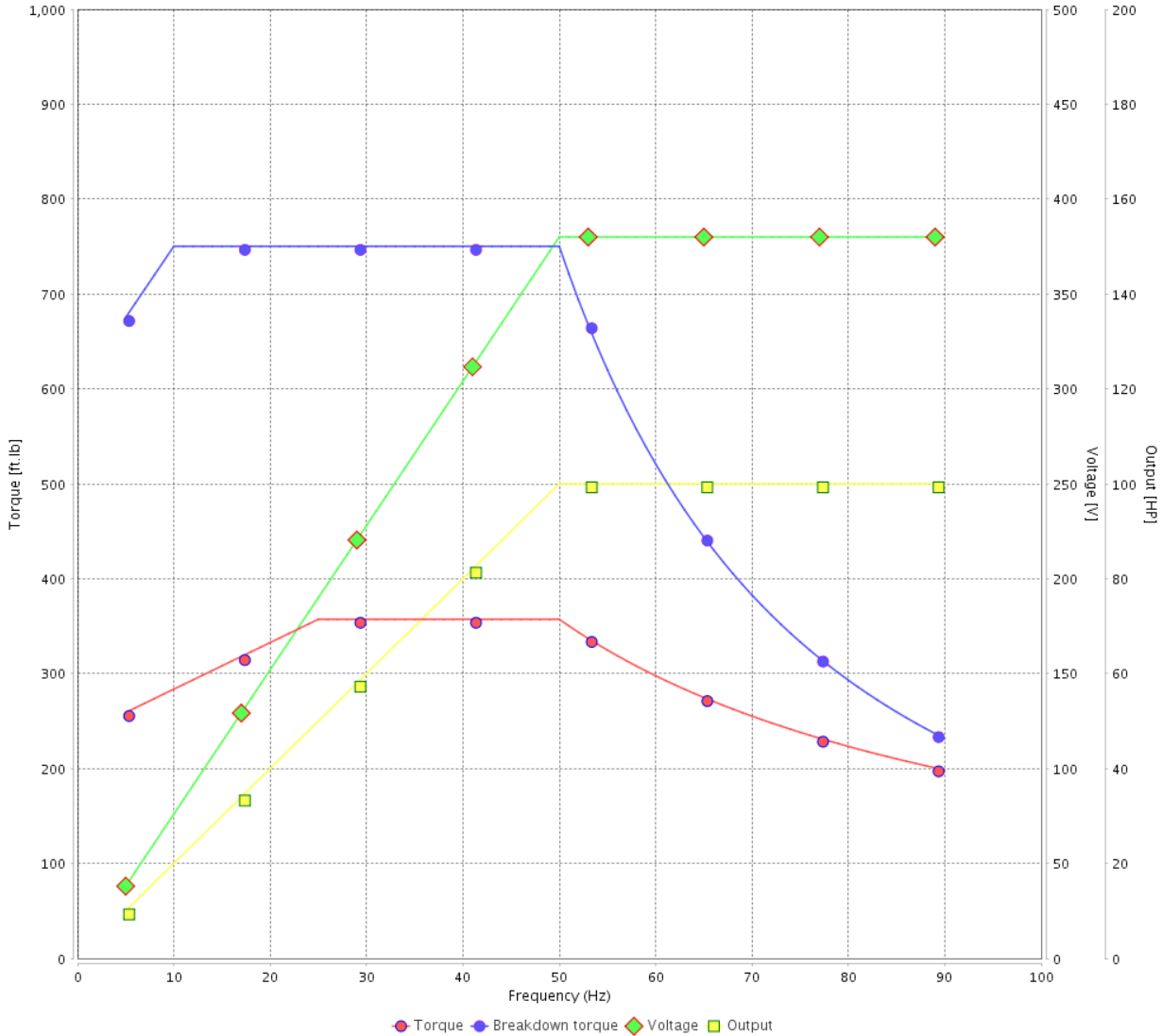

Performance : 380 V 50 Hz 4P IE1

Rated current : 138 A  
 LRC : 5.9  
 Rated torque : 357 ft.lb  
 Locked rotor torque : 190 %  
 Breakdown torque : 210 %  
 Rated speed : 1470 rpm

Moment of inertia (J) : 29.9 sq.ft.lb  
 Duty cycle : Cont.(S1)  
 Insulation class : F  
 Service factor : 1.00  
 Temperature rise : 105 K  
 Design : B

Rev.	Changes Summary	Performed	Checked	Date
Performed by			Page 34 / 36	Revision
Checked by				
Date	14/04/2022			

# VFD OPERATION CURVE

## Three Phase Induction Motor - Squirrel Cage



Customer : \_\_\_\_\_

Product line : NEMA Premium Efficiency Three-Phase

Product code : 11356028

Catalog # : 10018ET3GRB405T-W22

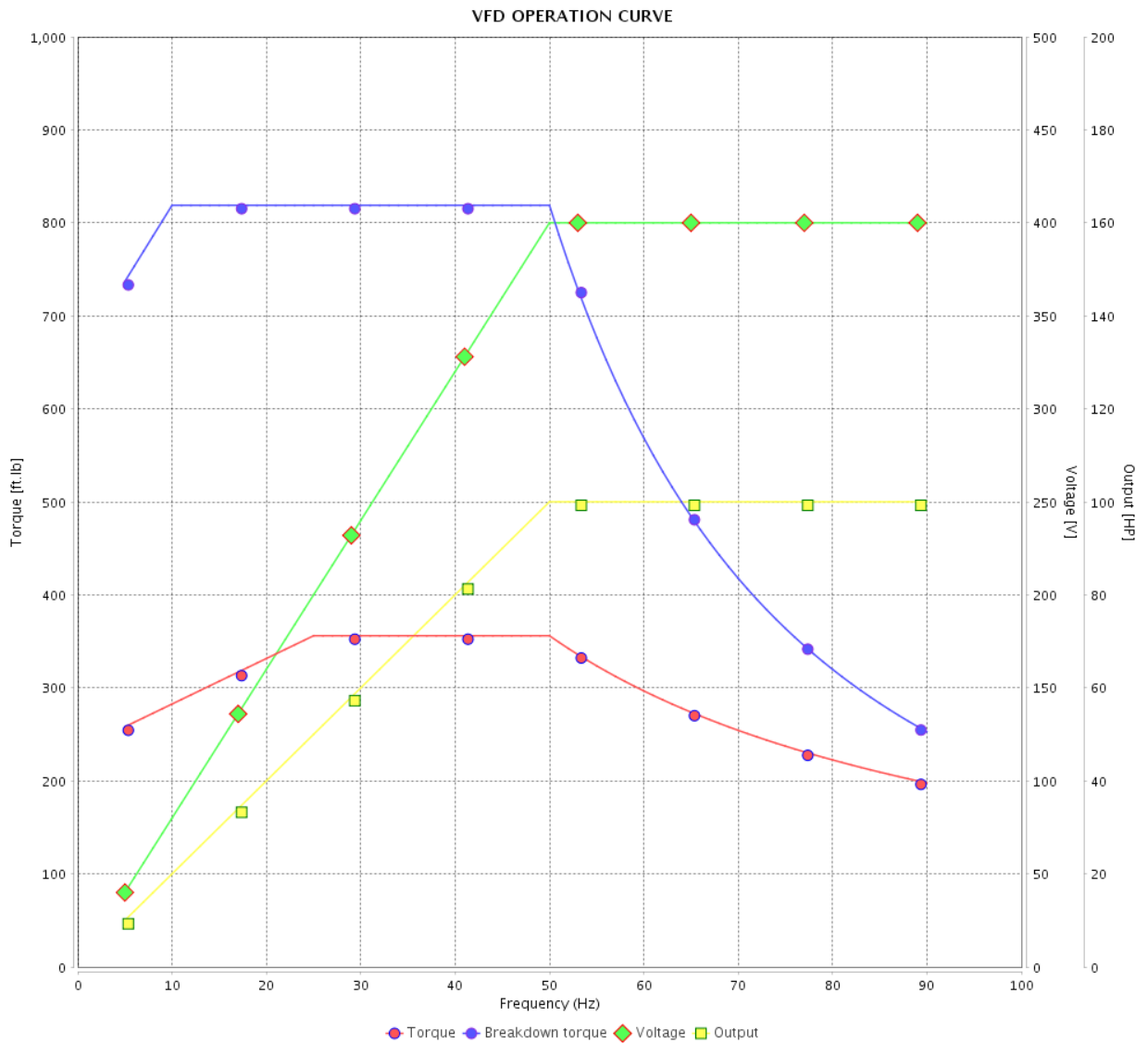

Performance : 400 V 50 Hz 4P IE2

Rated current : 131 A  
 LRC : 6.5  
 Rated torque : 356 ft.lb  
 Locked rotor torque : 210 %  
 Breakdown torque : 229 %  
 Rated speed : 1475 rpm

Moment of inertia (J) : 29.9 sq.ft.lb  
 Duty cycle : Cont.(S1)  
 Insulation class : F  
 Service factor : 1.00  
 Temperature rise : 105 K  
 Design : B

Rev.	Changes Summary	Performed	Checked	Date
Performed by		Page		Revision
Checked by		35 / 36		
Date		14/04/2022		

# VFD OPERATION CURVE

Three Phase Induction Motor - Squirrel Cage



Customer :

Product line : NEMA Premium Efficiency Three-Phase

Product code : 11356028

Catalog # : 10018ET3GRB405T-W22

VFD OPERATION CURVE

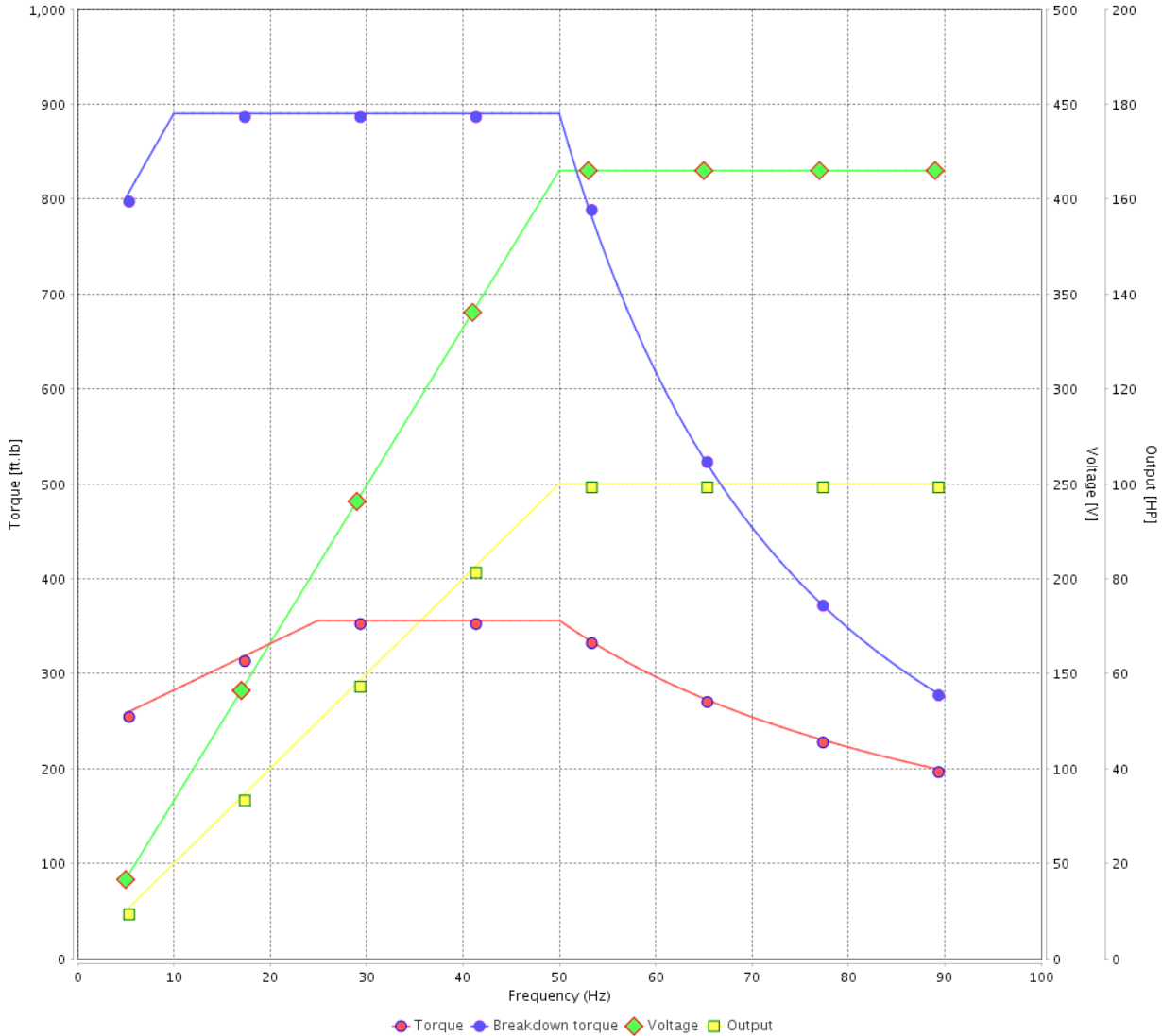

Performance : 415 V 50 Hz 4P IE2

Rated current : 127 A  
 LRC : 7.1  
 Rated torque : 356 ft.lb  
 Locked rotor torque : 220 %  
 Breakdown torque : 250 %  
 Rated speed : 1475 rpm

Moment of inertia (J) : 29.9 sq.ft.lb  
 Duty cycle : Cont.(S1)  
 Insulation class : F  
 Service factor : 1.00  
 Temperature rise : 105 K  
 Design : B

Rev.	Changes Summary	Performed	Checked	Date
Performed by			Page	Revision
Checked by				
Date				

1 2 3 4 5 6

A

B

C

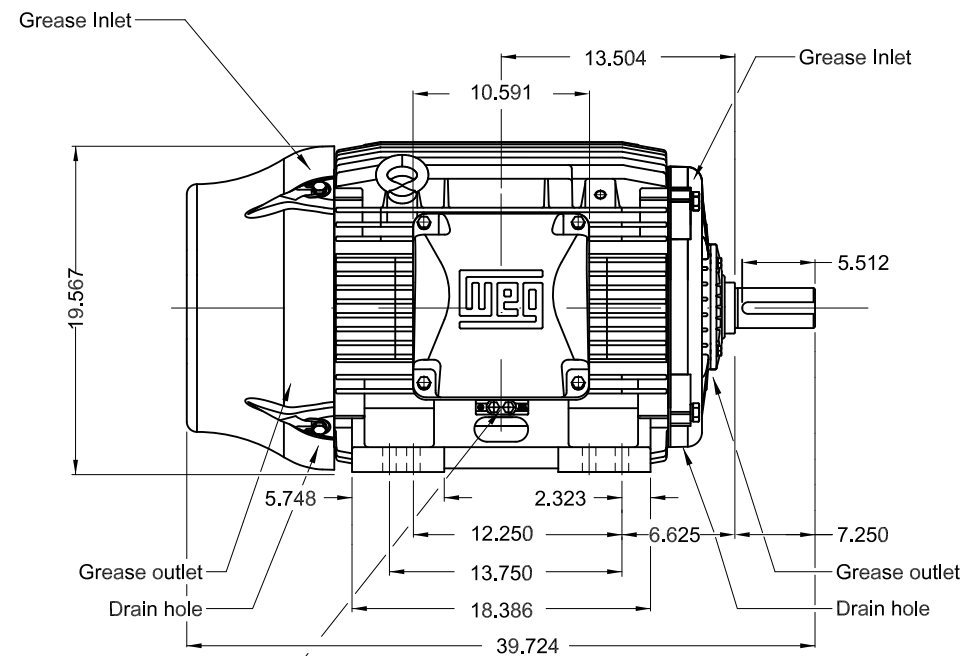
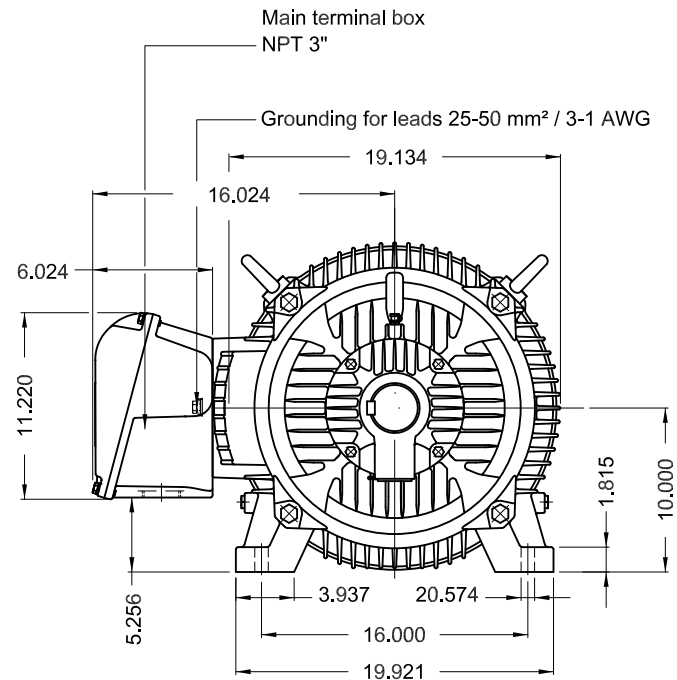

Grounding for leads 25-185 mm² / 3AWG-350MCM

D

E

- DE roller bearing
- Shaft locking device
- Color RAL 5009
- Painting plan 203A
- Mounting B3R(D)

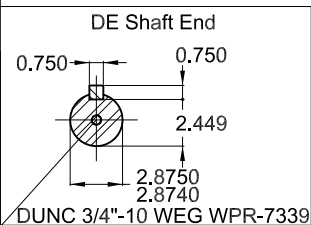

100 HP 04 Poles 60 Hz A

ECM	LOC	SUMMARY OF MODIFICATIONS	EXECUTED	CHECKED	RELEASED	DATE	VER
EXECUTED	PIRBUSER	THREE PH. MOTOR W22 PREM. EFF.					
CHECKED		FRAME 404/5T IP55 TEFC					
RELEASED							
REL DT.	WMO	Jaragua do Sul	Product Engineering	SHEET	1 / 1		

PREVIEW  
WDD



Dimensions in inches

XME A3



**NEMA**  
Premium  
W22



FOR SAFE AREA  
Mod.TE1BFOXON  
CC029A



Class I, Div 2, Gr A, B, C and D - T3  
Class I, Zone 2, IIC - T3  
Class II, Div 2, Gr F and G - T4  
For use on PWM: Gr. A, B, C, D and F,  
VT 1000:1, CT 20:1, 1.00SF - T3A

MODEL 10018ET3GRB405T-W22

Inverter Duty Motor  
Severe Duty

PH3 60Hz Fr. 404/5T 1000m.a.s.l. IP55 TEFC 1173lb

V 460

A 113

HP 100

kW 75

SF 1.25

SFA 141

RPM 1780

PF 0.87

AMB 40°C

INS cl. F DT80K

NEMA NOM EFF 95.4%

DUTY CONT.

DES B Code H

PART-WINDING

WYE-DELTA

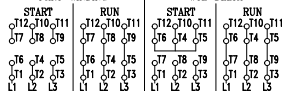

→ NU-316-C3 (34g)

→ 6314-C3 (27g)



MOBIL POLYREX EM (7000h)

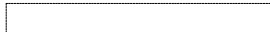

MADE IN MEXICO  
11356028