

DATA SHEET

Three Phase Induction Motor - Squirrel Cage



Customer :					
Product line		: NEMA Premium Efficiency Three-Phase		Product code : 11904016	
				Catalog # : 10036ET3G405JP-W22	
Frame : 404/5JP			Cooling method : IC411 - TEFC		
Insulation class : F			Mounting : F-1		
Duty cycle : Cont.(S1)			Rotation ¹ : Both (CW and CCW)		
Ambient temperature : -20°C to +40°C			Starting method : Direct On Line		
Altitude : 1000 m.a.s.l.			Approx. weight ² : 1111 lb		
Protection degree : IP55			Moment of inertia (J) : 13.2 sq.ft.lb		
Design : B					
Output [HP]	100	75	75	75	
Poles	2	2	2	2	
Frequency [Hz]	60	50	50	50	
Rated voltage [V]	460	380	400	415	
Rated current [A]	112	99.6	94.6	92.2	
L. R. Amperes [A]	728	677	719	756	
LRC [A]	6.5x(Code G)	6.8x(Code G)	7.6x(Code H)	8.2x(Code J)	x(Code)
No load current [A]	26.0	25.7	27.5	29.1	
Rated speed [RPM]	3545	2955	2960	2965	
Slip [%]	1.53	1.50	1.33	1.17	
Rated torque [ft.lb]	148	133	133	133	
Locked rotor torque [%]	240	250	280	300	
Breakdown torque [%]	260	280	310	330	
Service factor	1.25	1.00	1.00	1.00	
Temperature rise	80 K	80 K	80 K	80 K	80 K
Locked rotor time	25s (cold) 14s (hot)	18s (cold) 10s (hot)	18s (cold) 10s (hot)	18s (cold) 10s (hot)	
Noise level ²	79.0 dB(A)	74.0 dB(A)	74.0 dB(A)	74.0 dB(A)	dB(A)
Efficiency (%)	25%	92.8	92.4	92.5	93.1
	50%	93.0	93.0	93.1	93.5
	75%	94.1	93.8	93.8	94.0
	100%	94.1	94.3	94.3	94.3
Power Factor	25%	0.61	0.59	0.55	0.53
	50%	0.83	0.82	0.80	0.78
	75%	0.88	0.88	0.86	0.85
	100%	0.89	0.89	0.89	0.88
Bearing type		Drive end : 6314 C3	Non drive end : 6314 C3	Foundation loads	
Sealing		Lip Seal	Lip Seal	Max. traction : 760 lb	
Lubrication interval		4000 h	4000 h	Max. compression : 1871 lb	
Lubricant amount		27 g	27 g		
Lubricant type		Mobil Polyrex EM			
Notes					
This revision replaces and cancel the previous one, which must be eliminated. (1) Looking the motor from the shaft end. (2) Measured at 1m and with tolerance of +3dB(A). (3) Approximate weight subject to changes after manufacturing process. (4) At 100% of full load.			These are average values based on tests with sinusoidal power supply, subject to the tolerances stipulated in NEMA MG-1.		
Rev.	Changes Summary		Performed	Checked	Date
Performed by					
Checked by				Page	Revision
Date	12/04/2022			1 /	

TORQUE AND CURRENT VS SPEED CURVE

Three Phase Induction Motor - Squirrel Cage



Customer :

Product line : NEMA Premium Efficiency Three-Phase

Product code : 11904016

Catalog # : 10036ET3G405JP-W22

TORQUE AND CURRENT VS SPEED CURVE

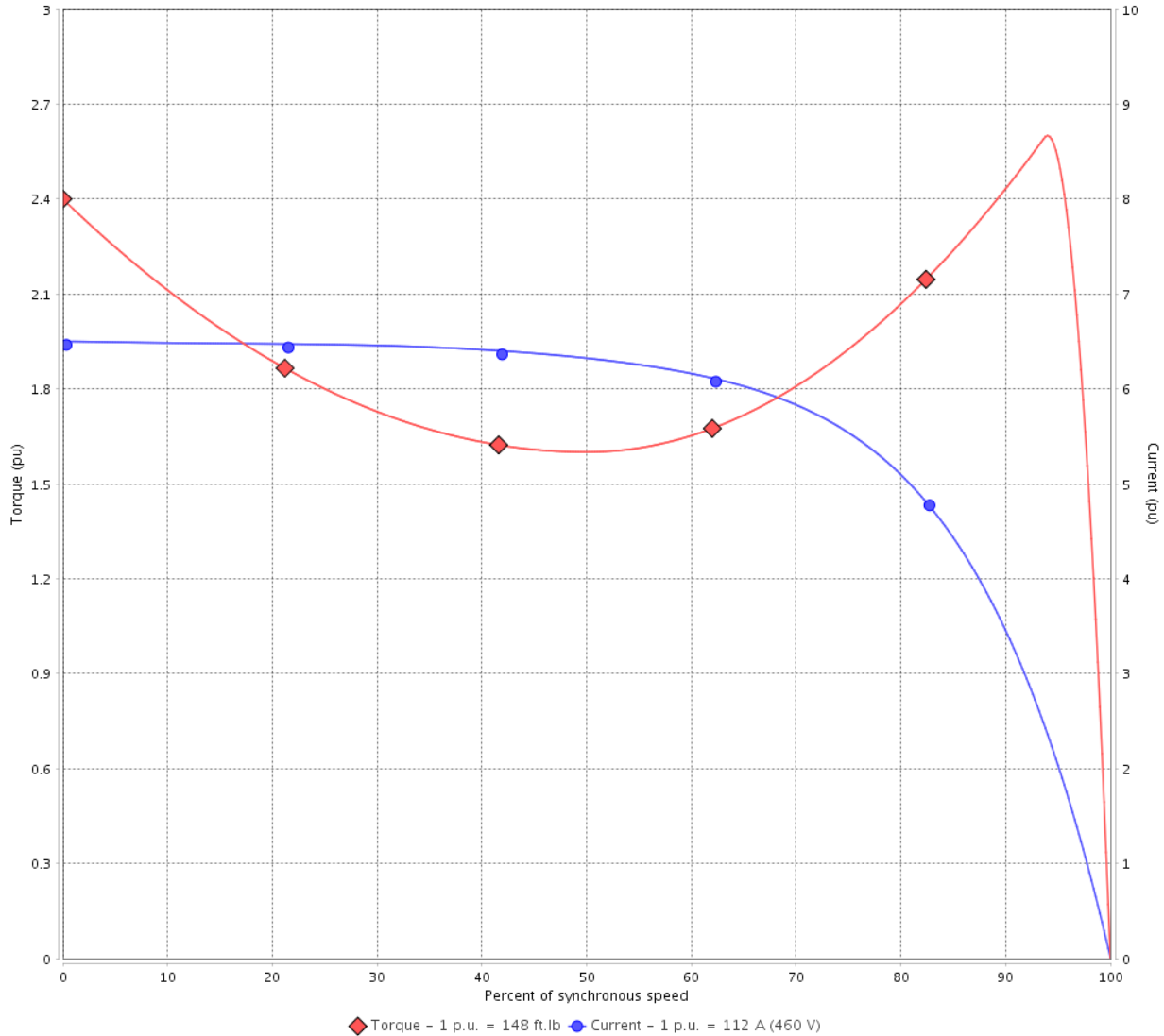

Performance : 460 V 60 Hz 2P

Rated current	: 112 A	Moment of inertia (J)	: 13.2 sq.ft.lb
LRC	: 6.5	Duty cycle	: Cont.(S1)
Rated torque	: 148 ft.lb	Insulation class	: F
Locked rotor torque	: 240 %	Service factor	: 1.25
Breakdown torque	: 260 %	Temperature rise	: 80 K
Rated speed	: 3545 rpm	Design	: B

Locked rotor time : 25s (cold) 14s (hot)

Rev.	Changes Summary	Performed	Checked	Date
Performed by			Page 2 /	Revision
Checked by				
Date	12/04/2022			

TORQUE AND CURRENT VS SPEED CURVE



Three Phase Induction Motor - Squirrel Cage

Customer :

Product line : NEMA Premium Efficiency Three-Phase

Product code : 11904016

Catalog # : 10036ET3G405JP-W22

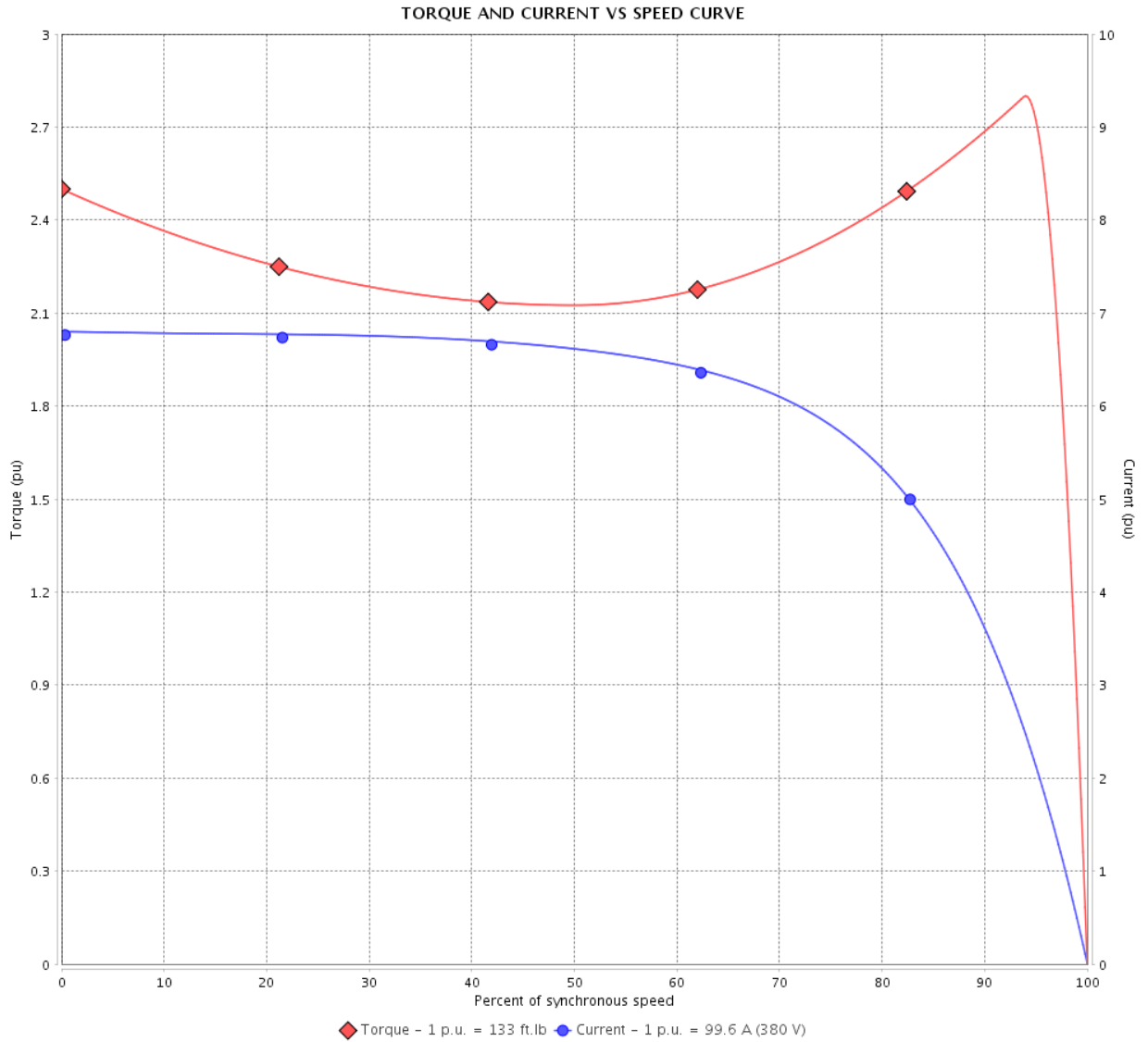

Performance : 380 V 50 Hz 2P IE3

Rated current	: 99.6 A	Moment of inertia (J)	: 13.2 sq.ft.lb
LRC	: 6.8	Duty cycle	: Cont.(S1)
Rated torque	: 133 ft.lb	Insulation class	: F
Locked rotor torque	: 250 %	Service factor	: 1.00
Breakdown torque	: 280 %	Temperature rise	: 80 K
Rated speed	: 2955 rpm	Design	: B

Locked rotor time : 18s (cold) 10s (hot)

Rev.	Changes Summary	Performed	Checked	Date
Performed by			Page 3 /	Revision
Checked by				
Date	12/04/2022			

TORQUE AND CURRENT VS SPEED CURVE

Three Phase Induction Motor - Squirrel Cage



Customer :

Product line : NEMA Premium Efficiency Three-Phase

Product code : 11904016

Catalog # : 10036ET3G405JP-W22

TORQUE AND CURRENT VS SPEED CURVE

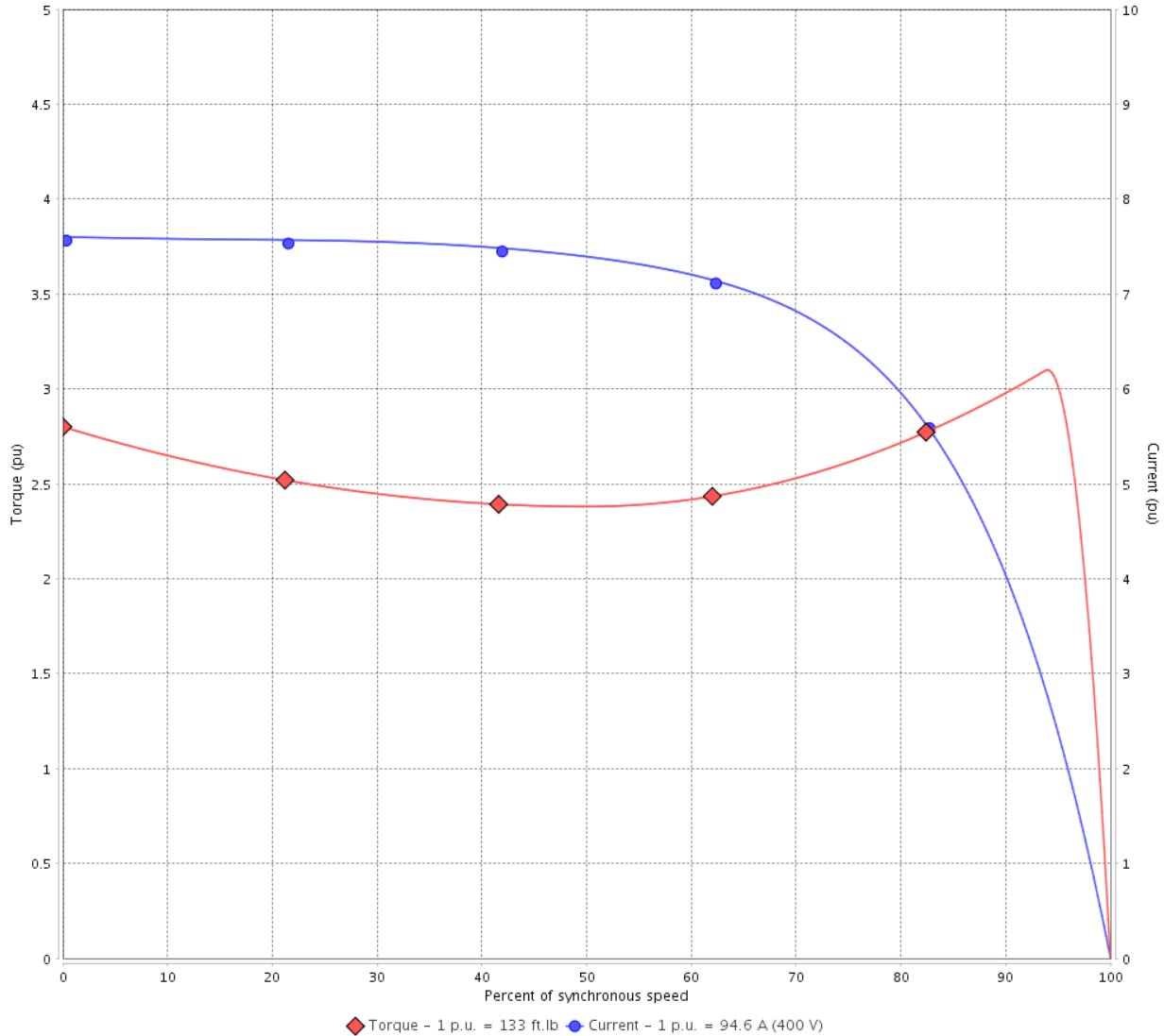

Performance : 400 V 50 Hz 2P IE3

Rated current	: 94.6 A	Moment of inertia (J)	: 13.2 sq.ft.lb
LRC	: 7.6	Duty cycle	: Cont.(S1)
Rated torque	: 133 ft.lb	Insulation class	: F
Locked rotor torque	: 280 %	Service factor	: 1.00
Breakdown torque	: 310 %	Temperature rise	: 80 K
Rated speed	: 2960 rpm	Design	: B

Locked rotor time : 18s (cold) 10s (hot)

Rev.	Changes Summary	Performed	Checked	Date
Performed by			Page 4 /	Revision
Checked by				
Date	12/04/2022			

TORQUE AND CURRENT VS SPEED CURVE



Three Phase Induction Motor - Squirrel Cage

Customer :

Product line : NEMA Premium Efficiency Three-Phase

Product code : 11904016

Catalog # : 10036ET3G405JP-W22

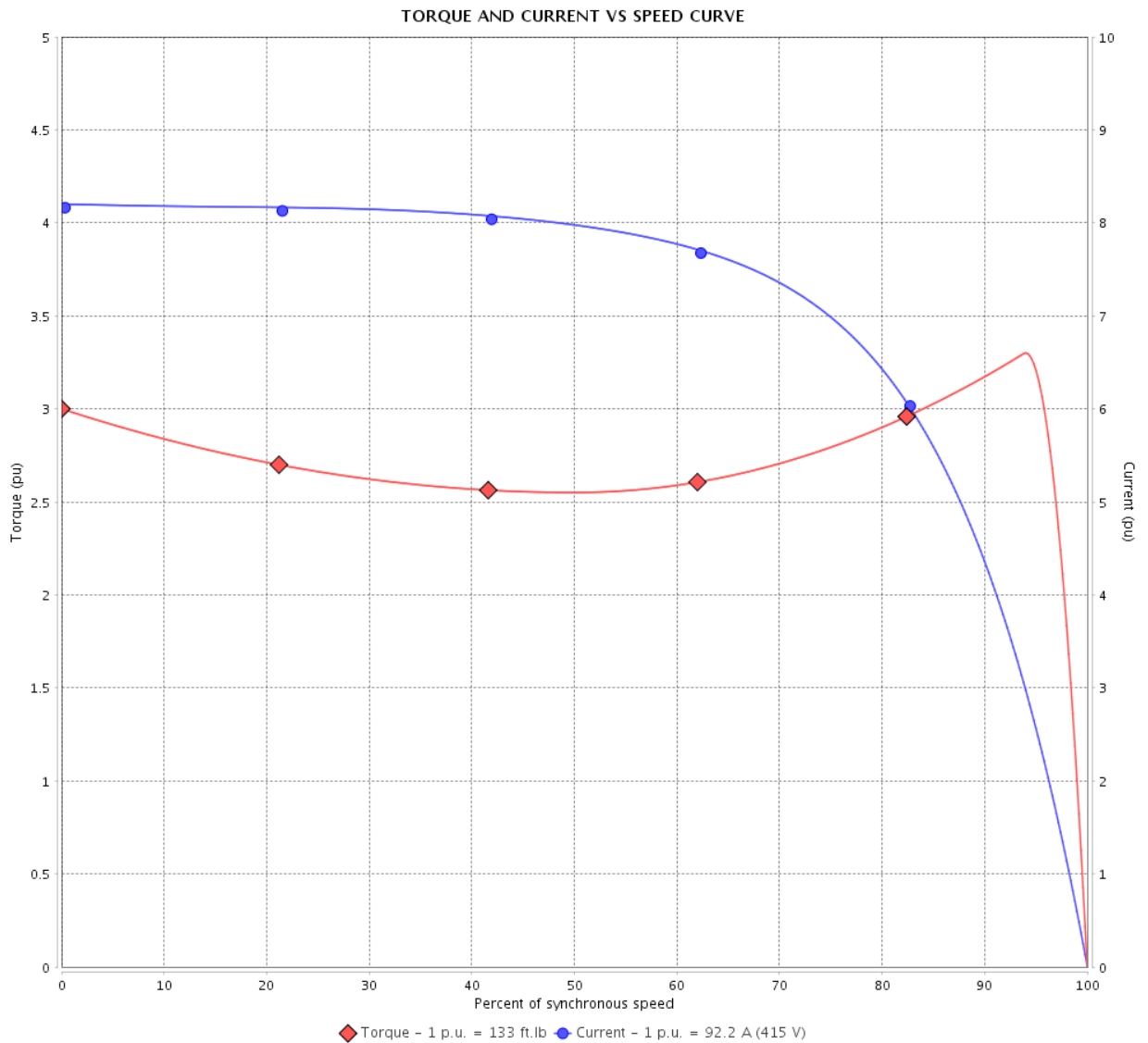

Performance : 415 V 50 Hz 2P IE3

Rated current	: 92.2 A	Moment of inertia (J)	: 13.2 sq.ft.lb
LRC	: 8.2	Duty cycle	: Cont.(S1)
Rated torque	: 133 ft.lb	Insulation class	: F
Locked rotor torque	: 300 %	Service factor	: 1.00
Breakdown torque	: 330 %	Temperature rise	: 80 K
Rated speed	: 2965 rpm	Design	: B

Locked rotor time : 18s (cold) 10s (hot)

Rev.	Changes Summary	Performed	Checked	Date
Performed by			Page 5 /	Revision
Checked by				
Date	12/04/2022			

LOAD PERFORMANCE CURVE

Three Phase Induction Motor - Squirrel Cage



Customer : _____

Product line : NEMA Premium Efficiency Three-Phase

Product code : 11904016

Catalog # : 10036ET3G405JP-W22

LOAD PERFORMANCE CURVE

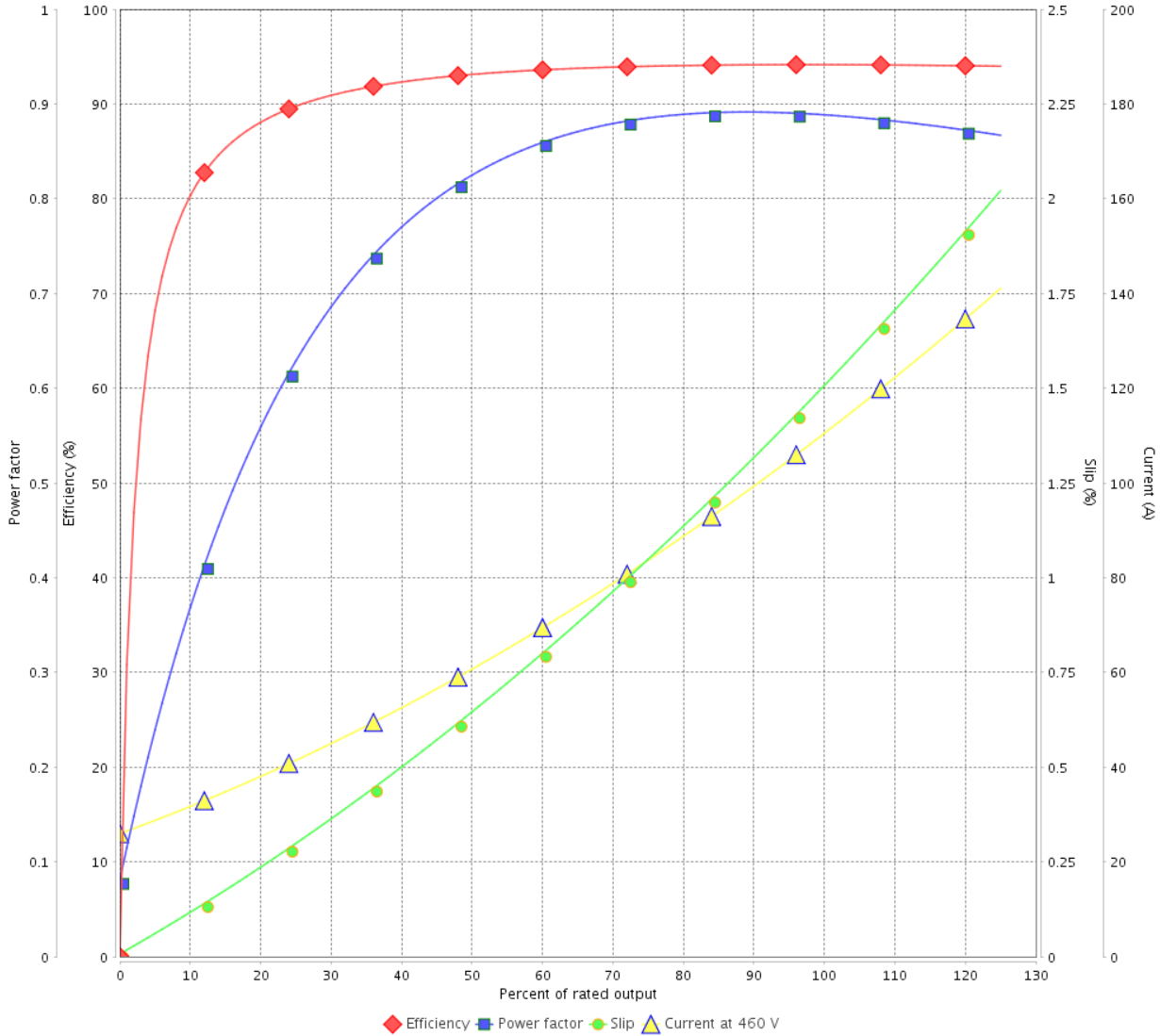

Performance : 460 V 60 Hz 2P

Rated current : 112 A
 LRC : 6.5
 Rated torque : 148 ft.lb
 Locked rotor torque : 240 %
 Breakdown torque : 260 %
 Rated speed : 3545 rpm

Moment of inertia (J) : 13.2 sq.ft.lb
 Duty cycle : Cont.(S1)
 Insulation class : F
 Service factor : 1.25
 Temperature rise : 80 K
 Design : B

Rev.	Changes Summary	Performed	Checked	Date
Performed by			Page 6 /	Revision
Checked by				
Date	12/04/2022			

LOAD PERFORMANCE CURVE

Three Phase Induction Motor - Squirrel Cage



Customer :

Product line : NEMA Premium Efficiency Three-Phase

Product code : 11904016

Catalog # : 10036ET3G405JP-W22

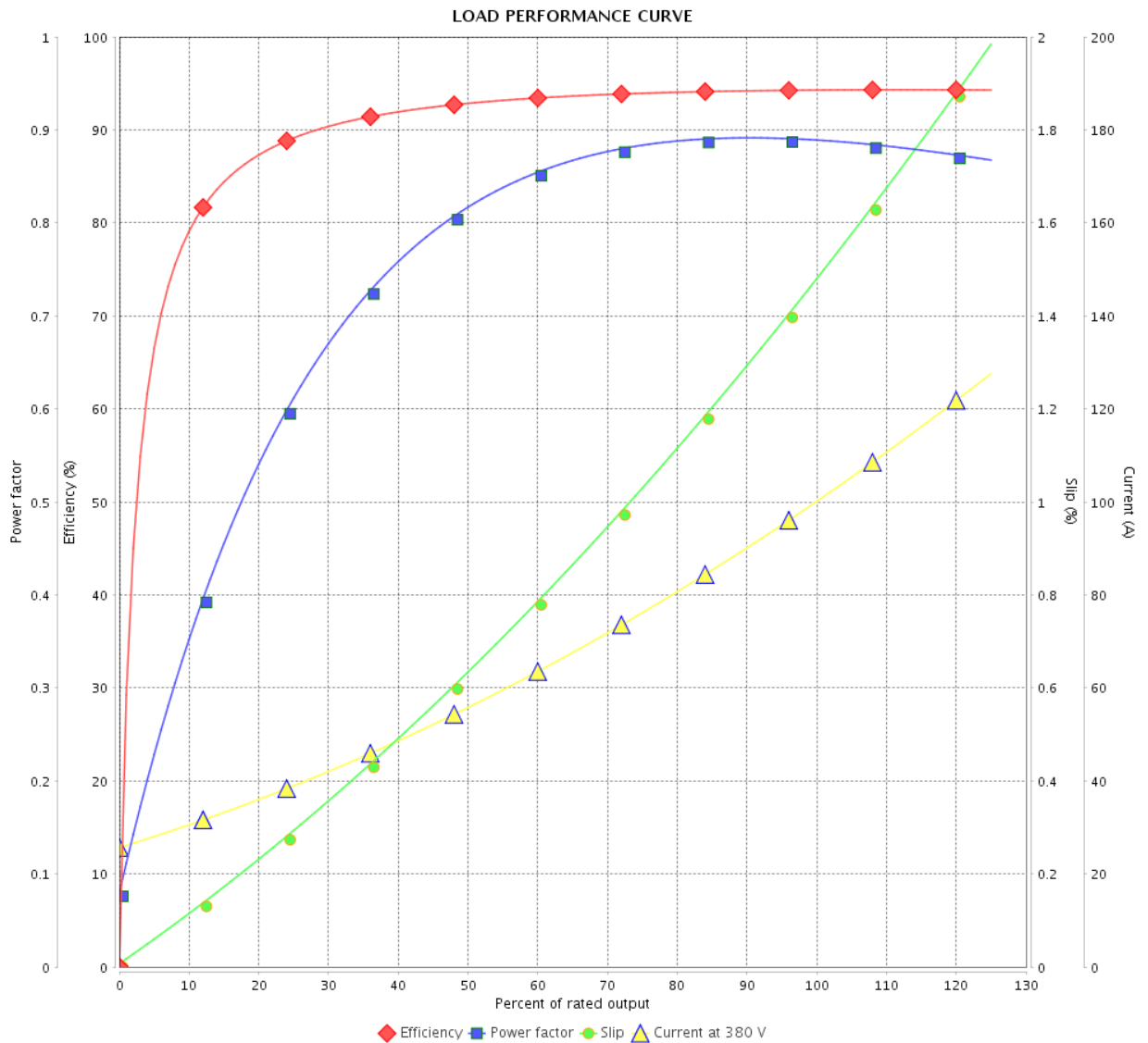

Performance : 380 V 50 Hz 2P IE3

Rated current : 99.6 A
 LRC : 6.8
 Rated torque : 133 ft.lb
 Locked rotor torque : 250 %
 Breakdown torque : 280 %
 Rated speed : 2955 rpm

Moment of inertia (J) : 13.2 sq.ft.lb
 Duty cycle : Cont.(S1)
 Insulation class : F
 Service factor : 1.00
 Temperature rise : 80 K
 Design : B

Rev.	Changes Summary	Performed	Checked	Date
Performed by		Page		Revision
Checked by		7 /		
Date	12/04/2022			

LOAD PERFORMANCE CURVE

Three Phase Induction Motor - Squirrel Cage



Customer : _____

Product line : NEMA Premium Efficiency Three-Phase

Product code : 11904016

Catalog # : 10036ET3G405JP-W22

LOAD PERFORMANCE CURVE

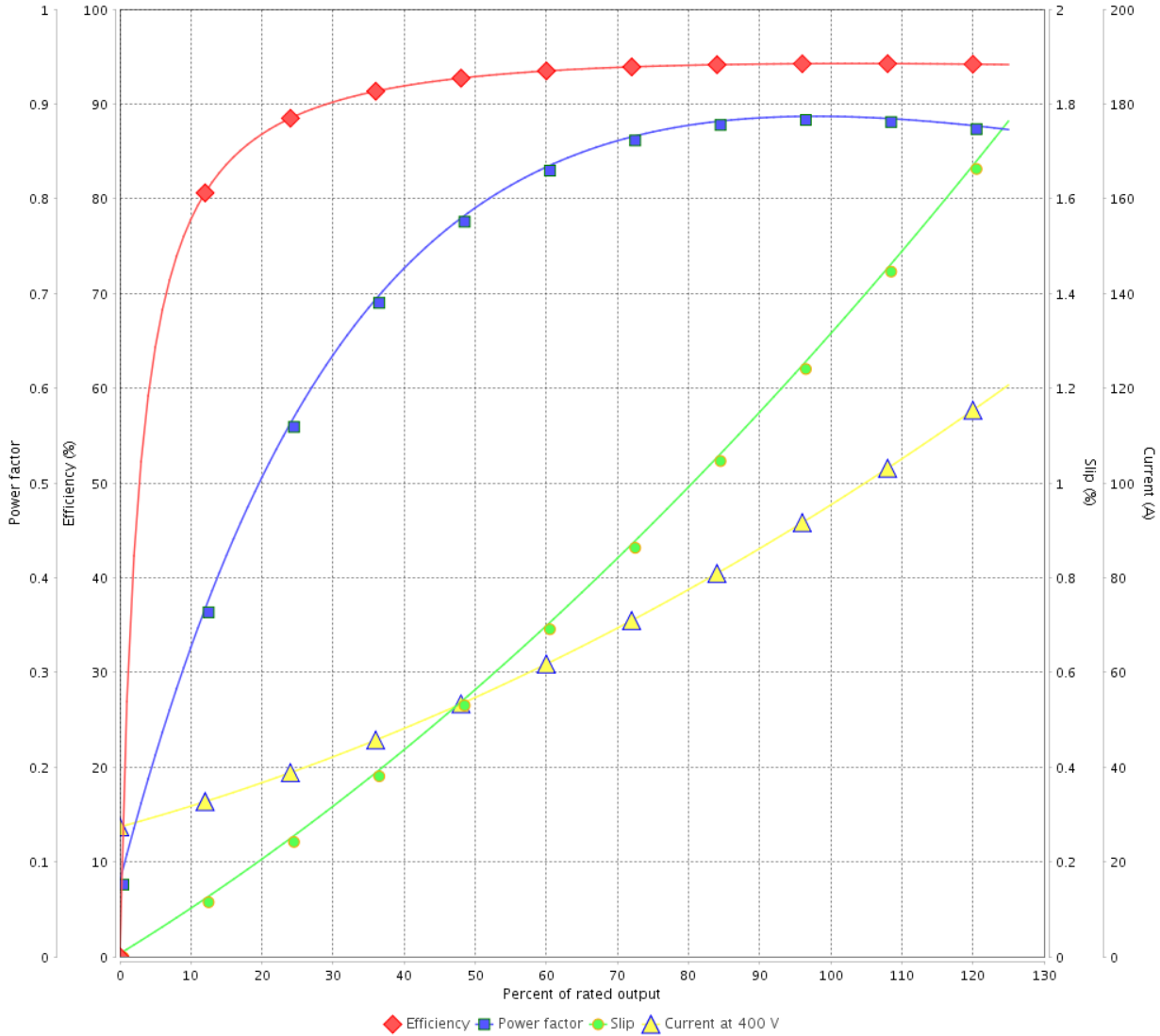

Performance : 400 V 50 Hz 2P IE3

Rated current : 94.6 A
 LRC : 7.6
 Rated torque : 133 ft.lb
 Locked rotor torque : 280 %
 Breakdown torque : 310 %
 Rated speed : 2960 rpm

Moment of inertia (J) : 13.2 sq.ft.lb
 Duty cycle : Cont.(S1)
 Insulation class : F
 Service factor : 1.00
 Temperature rise : 80 K
 Design : B

Rev.	Changes Summary	Performed	Checked	Date
Performed by			Page	Revision
Checked by				
Date	12/04/2022			

LOAD PERFORMANCE CURVE

Three Phase Induction Motor - Squirrel Cage



Customer : _____

Product line : NEMA Premium Efficiency Three-Phase

Product code : 11904016

Catalog # : 10036ET3G405JP-W22

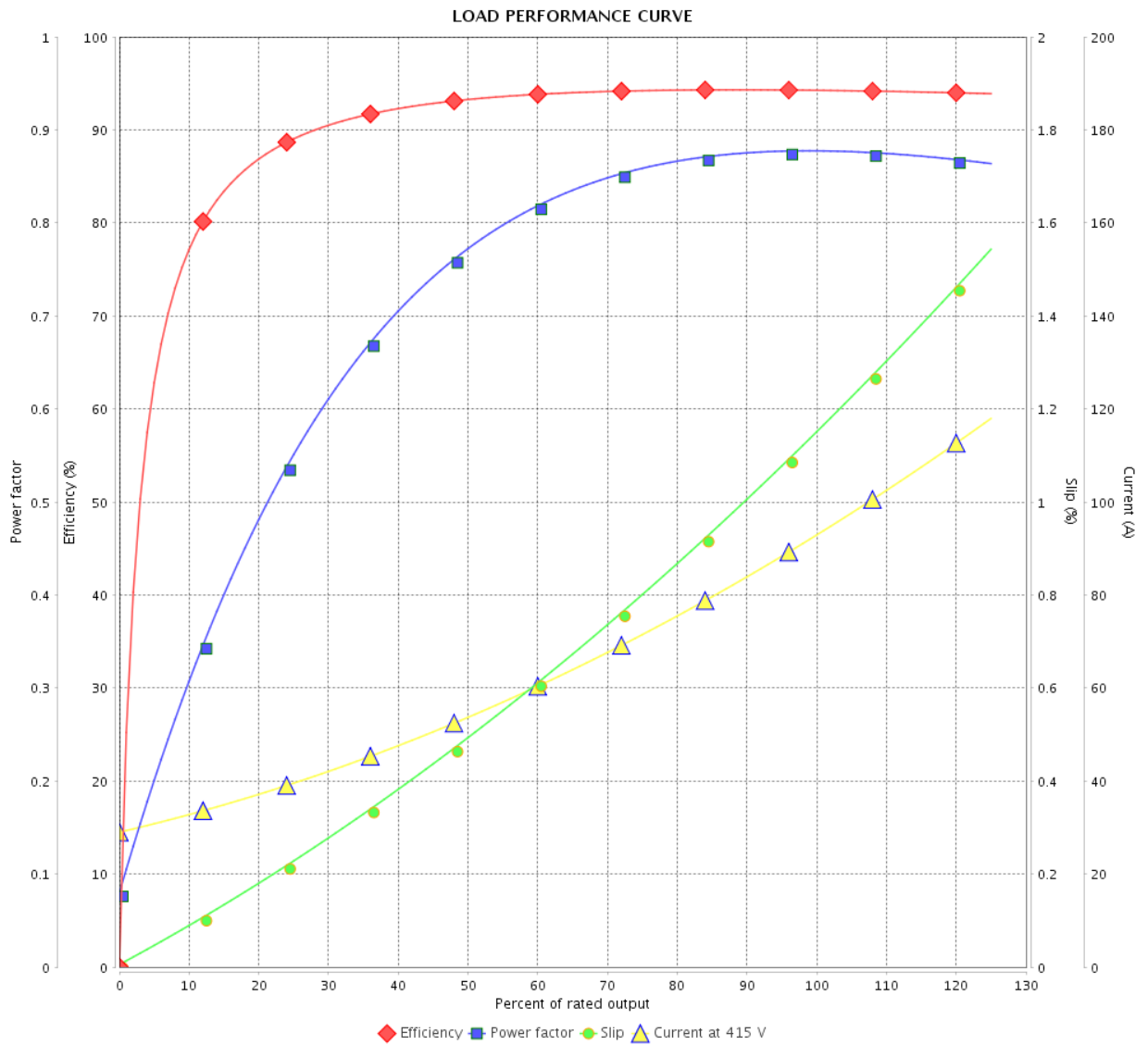

Performance : 415 V 50 Hz 2P IE3

Rated current : 92.2 A
 LRC : 8.2
 Rated torque : 133 ft.lb
 Locked rotor torque : 300 %
 Breakdown torque : 330 %
 Rated speed : 2965 rpm

Moment of inertia (J) : 13.2 sq.ft.lb
 Duty cycle : Cont.(S1)
 Insulation class : F
 Service factor : 1.00
 Temperature rise : 80 K
 Design : B

Rev.	Changes Summary	Performed	Checked	Date
Performed by		Page		Revision
Checked by		9 /		
Date		12/04/2022		

THERMAL LIMIT CURVE



Three Phase Induction Motor - Squirrel Cage

Customer :

Product line : NEMA Premium Efficiency Three-Phase
 Product code : 11904016
 Catalog # : 10036ET3G405JP-W22

Performance : 460 V 60 Hz 2P

Rated current : 112 A	Moment of inertia (J) : 13.2 sq.ft.lb
LRC : 6.5	Duty cycle : Cont.(S1)
Rated torque : 148 ft.lb	Insulation class : F
Locked rotor torque : 240 %	Service factor : 1.25
Breakdown torque : 260 %	Temperature rise : 80 K
Rated speed : 3545 rpm	Design : B

Heating constant

Cooling constant

Rev.	Changes Summary	Performed	Checked	Date
Performed by			Page	Revision
Checked by				
Date	12/04/2022			
			10 /	

THERMAL LIMIT CURVE

Three Phase Induction Motor - Squirrel Cage



Customer : _____

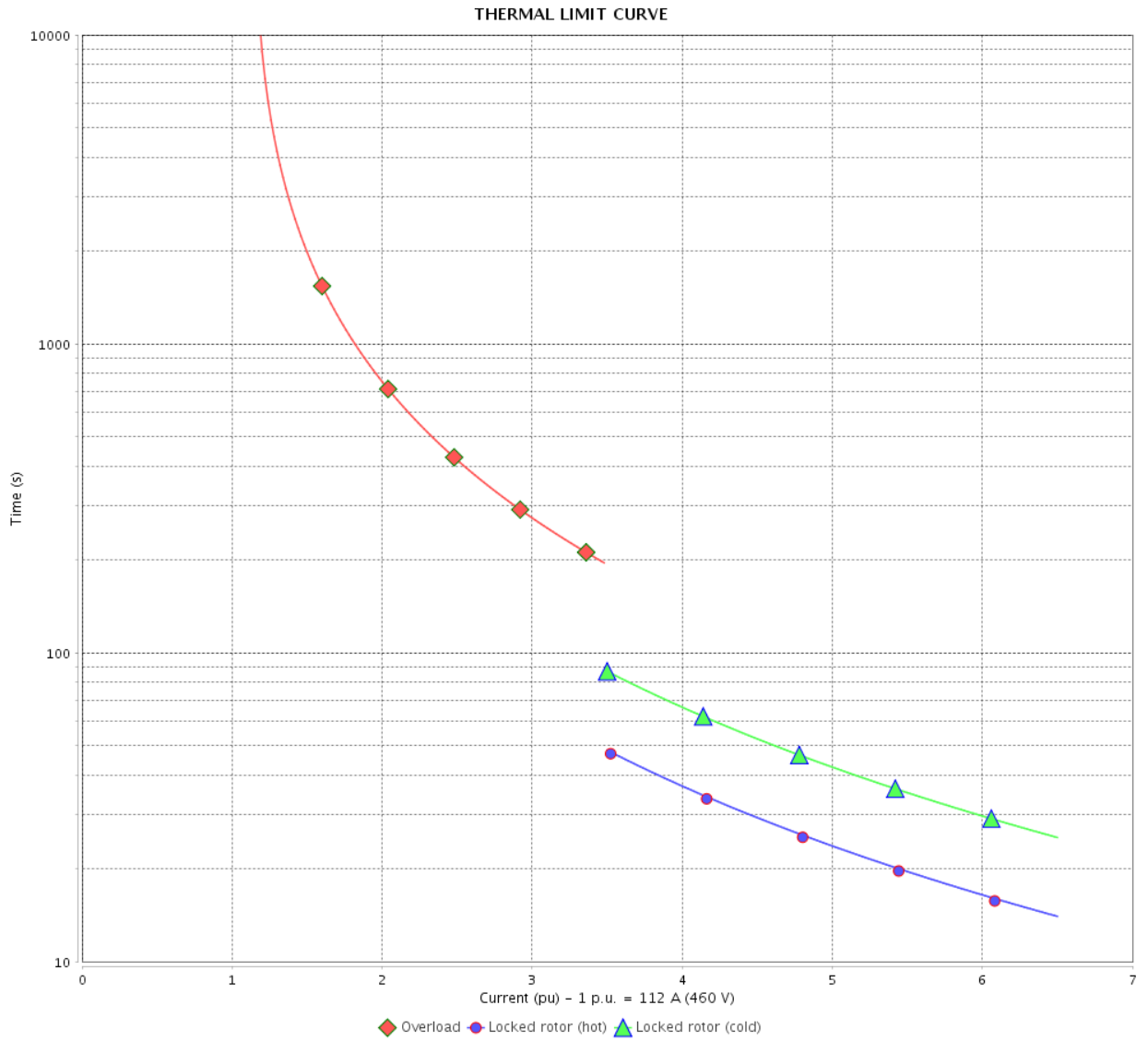

Rev.	Changes Summary	Performed	Checked	Date
Performed by		Page		Revision
Checked by		11 /		
Date		12/04/2022		

THERMAL LIMIT CURVE



Three Phase Induction Motor - Squirrel Cage

Customer :

Product line : NEMA Premium Efficiency Three-Phase
 Product code : 11904016
 Catalog # : 10036ET3G405JP-W22

Performance : 380 V 50 Hz 2P IE3

Rated current : 99.6 A	Moment of inertia (J) : 13.2 sq.ft.lb
LRC : 6.8	Duty cycle : Cont.(S1)
Rated torque : 133 ft.lb	Insulation class : F
Locked rotor torque : 250 %	Service factor : 1.00
Breakdown torque : 280 %	Temperature rise : 80 K
Rated speed : 2955 rpm	Design : B

Heating constant

Cooling constant

Rev.	Changes Summary	Performed	Checked	Date
Performed by			Page	Revision
Checked by				
Date	12/04/2022			
			12 /	

THERMAL LIMIT CURVE

Three Phase Induction Motor - Squirrel Cage



Customer : _____

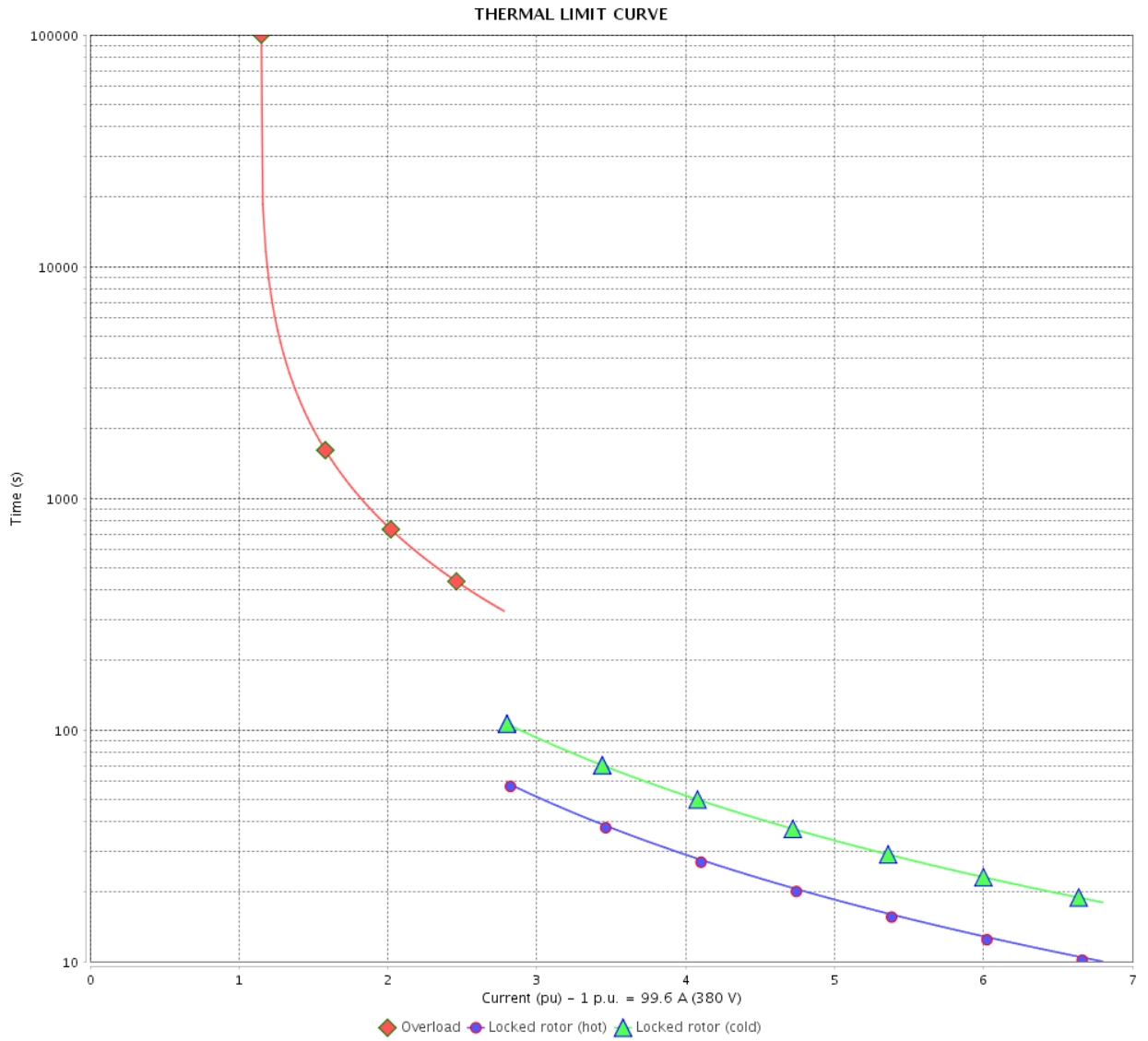

Rev.	Changes Summary	Performed	Checked	Date
Performed by		Page		Revision
Checked by		13 /		
Date		12/04/2022		

THERMAL LIMIT CURVE



Three Phase Induction Motor - Squirrel Cage

Customer :

Product line : NEMA Premium Efficiency Three-Phase
 Product code : 11904016
 Catalog # : 10036ET3G405JP-W22

Performance : 400 V 50 Hz 2P IE3

Rated current : 94.6 A	Moment of inertia (J) : 13.2 sq.ft.lb
LRC : 7.6	Duty cycle : Cont.(S1)
Rated torque : 133 ft.lb	Insulation class : F
Locked rotor torque : 280 %	Service factor : 1.00
Breakdown torque : 310 %	Temperature rise : 80 K
Rated speed : 2960 rpm	Design : B

Heating constant

Cooling constant

Rev.	Changes Summary	Performed	Checked	Date
Performed by			Page 14 /	Revision
Checked by				
Date	12/04/2022			

THERMAL LIMIT CURVE

Three Phase Induction Motor - Squirrel Cage



Customer : _____

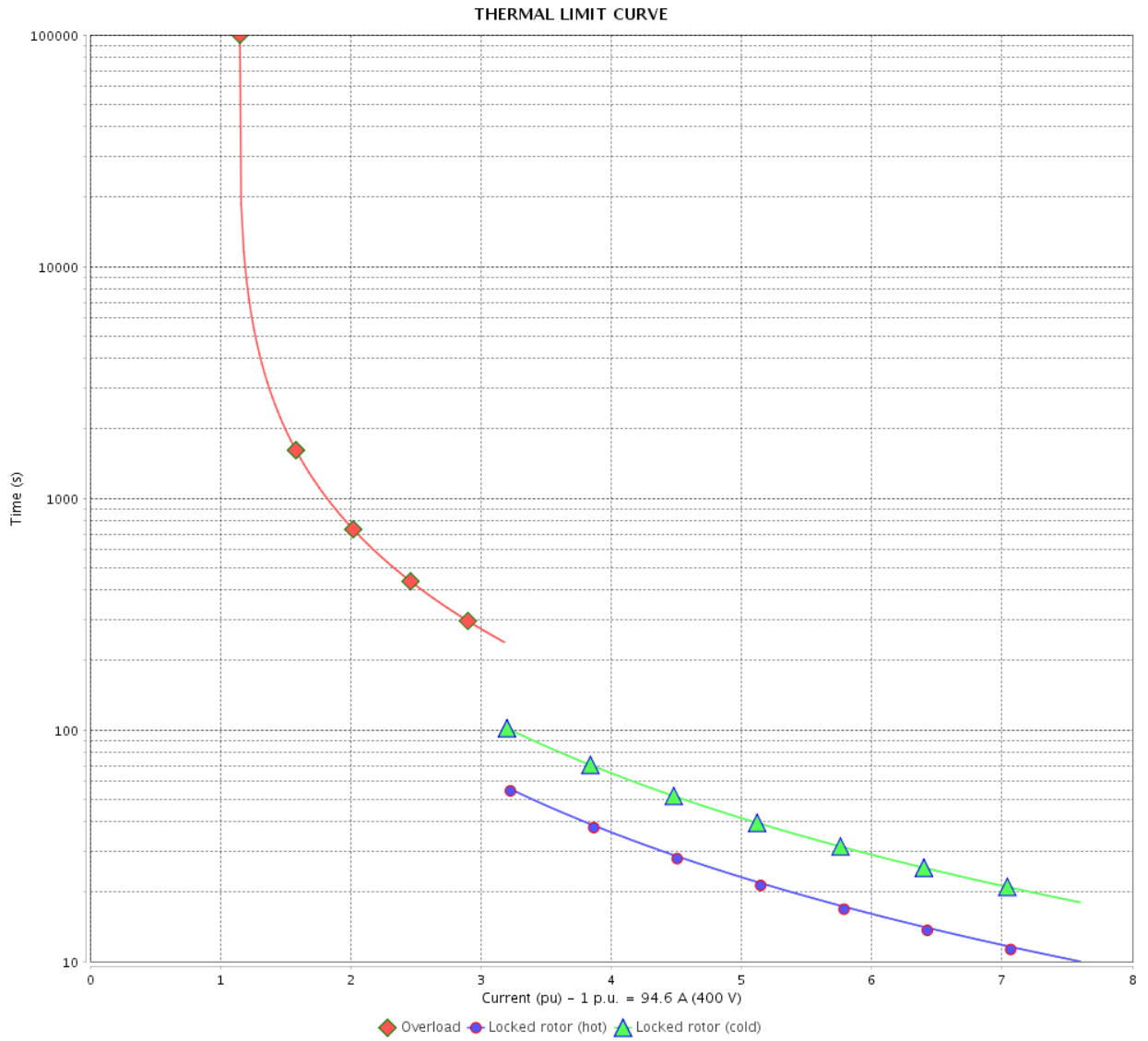

Rev.	Changes Summary	Performed	Checked	Date
Performed by		Page		Revision
Checked by		15 /		
Date		12/04/2022		

THERMAL LIMIT CURVE

Three Phase Induction Motor - Squirrel Cage



Customer :

Product line : NEMA Premium Efficiency Three-Phase
Product code : 11904016
Catalog # : 10036ET3G405JP-W22

Performance : 415 V 50 Hz 2P IE3

Rated current	: 92.2 A	Moment of inertia (J)	: 13.2 sq.ft.lb
LRC	: 8.2	Duty cycle	: Cont.(S1)
Rated torque	: 133 ft.lb	Insulation class	: F
Locked rotor torque	: 300 %	Service factor	: 1.00
Breakdown torque	: 330 %	Temperature rise	: 80 K
Rated speed	: 2965 rpm	Design	: B

Heating constant

Cooling constant

Rev.	Changes Summary	Performed	Checked	Date
Performed by				
Checked by			Page	Revision
Date	12/04/2022		16 /	

THERMAL LIMIT CURVE

Three Phase Induction Motor - Squirrel Cage



Customer : _____

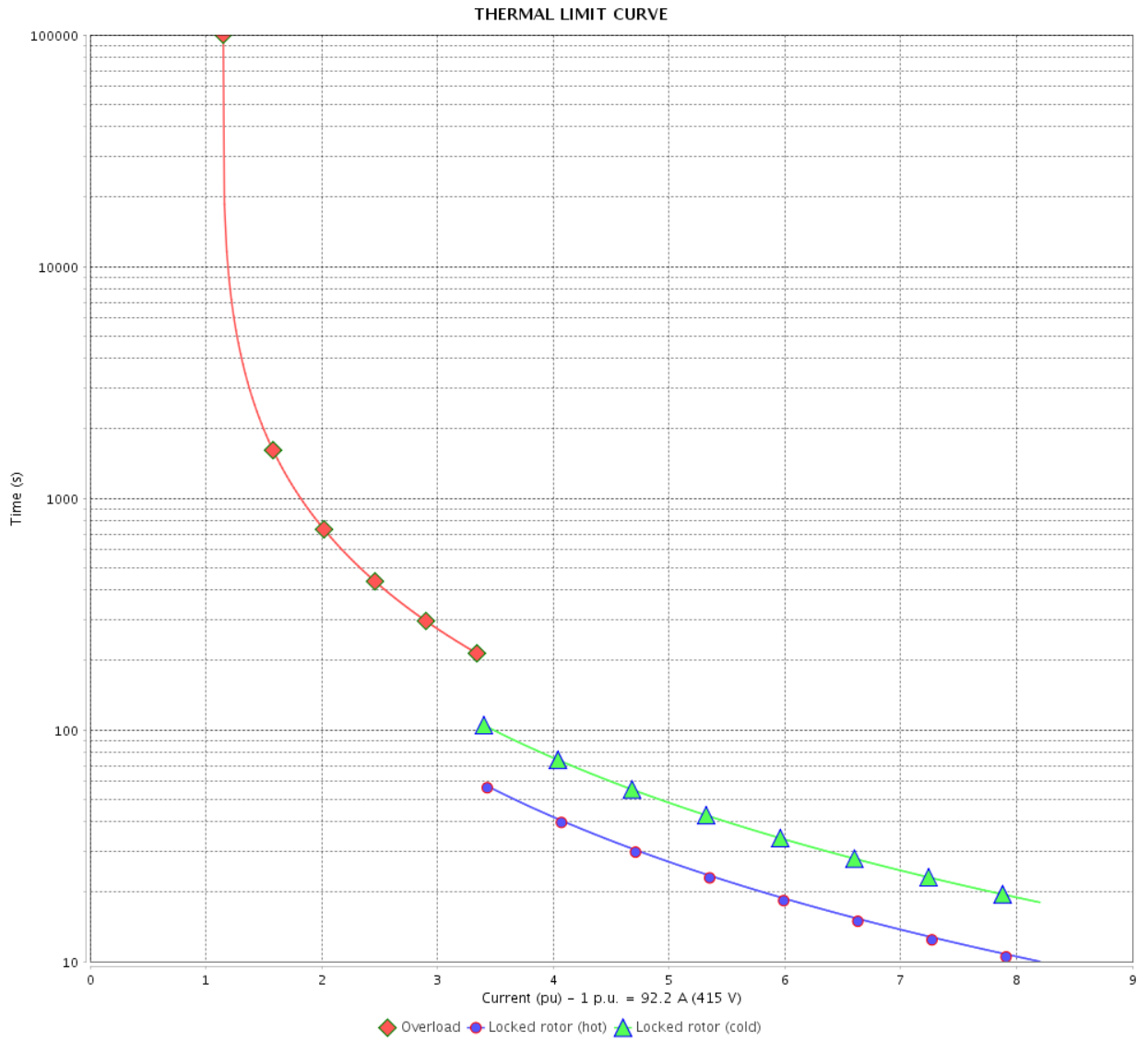

Rev.	Changes Summary	Performed	Checked	Date
Performed by		Page		Revision
Checked by		17 /		
Date		12/04/2022		

VFD OPERATION CURVE

Three Phase Induction Motor - Squirrel Cage



Customer :

Product line : NEMA Premium Efficiency Three-Phase

Product code : 11904016

Catalog # : 10036ET3G405JP-W22

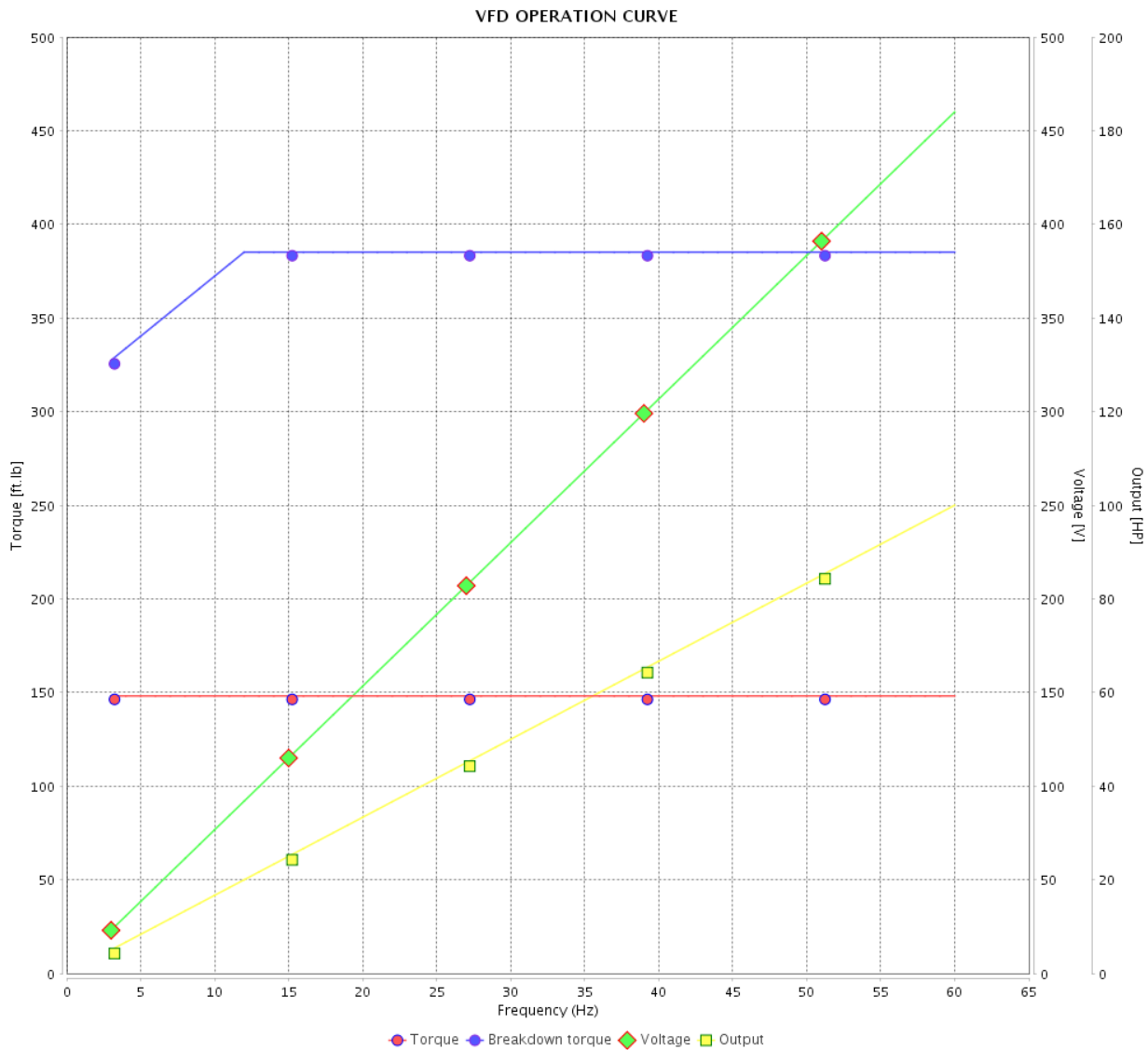

Performance : 460 V 60 Hz 2P

Rated current	: 112 A	Moment of inertia (J)	: 13.2 sq.ft.lb
LRC	: 6.5	Duty cycle	: Cont.(S1)
Rated torque	: 148 ft.lb	Insulation class	: F
Locked rotor torque	: 240 %	Service factor	: 1.25
Breakdown torque	: 260 %	Temperature rise	: 80 K
Rated speed	: 3545 rpm	Design	: B

Rev.	Changes Summary	Performed	Checked	Date
Performed by			Page 18 /	Revision
Checked by				
Date	12/04/2022			

VFD OPERATION CURVE

Three Phase Induction Motor - Squirrel Cage



Customer : _____

Product line : NEMA Premium Efficiency Three-Phase

Product code : 11904016

Catalog # : 10036ET3G405JP-W22

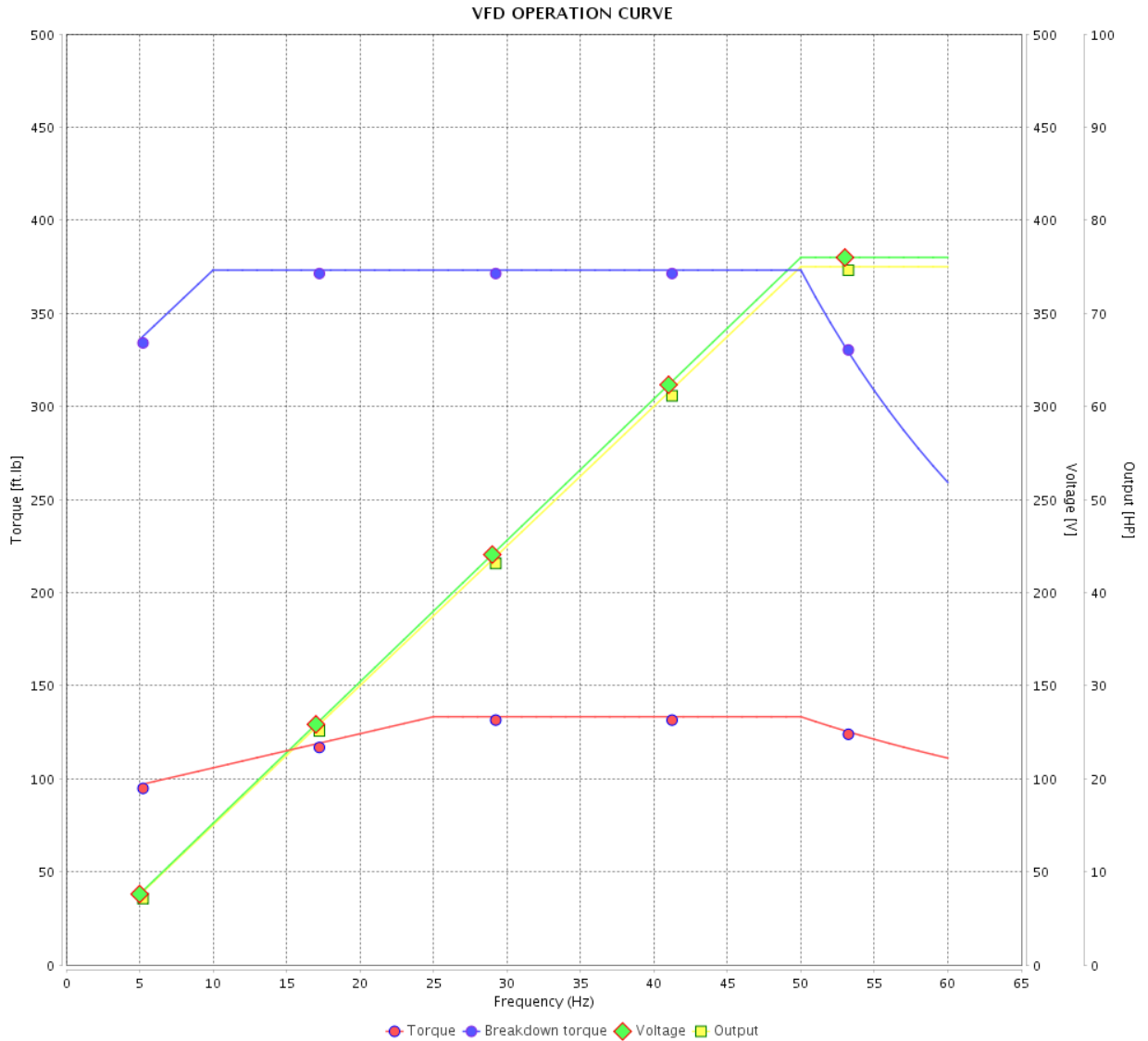

Performance : 380 V 50 Hz 2P IE3

Rated current : 99.6 A
 LRC : 6.8
 Rated torque : 133 ft.lb
 Locked rotor torque : 250 %
 Breakdown torque : 280 %
 Rated speed : 2955 rpm

Moment of inertia (J) : 13.2 sq.ft.lb
 Duty cycle : Cont.(S1)
 Insulation class : F
 Service factor : 1.00
 Temperature rise : 80 K
 Design : B

Rev.	Changes Summary	Performed	Checked	Date
Performed by				Page 19 /
Checked by				
Date	12/04/2022			
				Revision

VFD OPERATION CURVE

Three Phase Induction Motor - Squirrel Cage



Customer :

Product line : NEMA Premium Efficiency Three-Phase

Product code : 11904016

Catalog # : 10036ET3G405JP-W22

VFD OPERATION CURVE

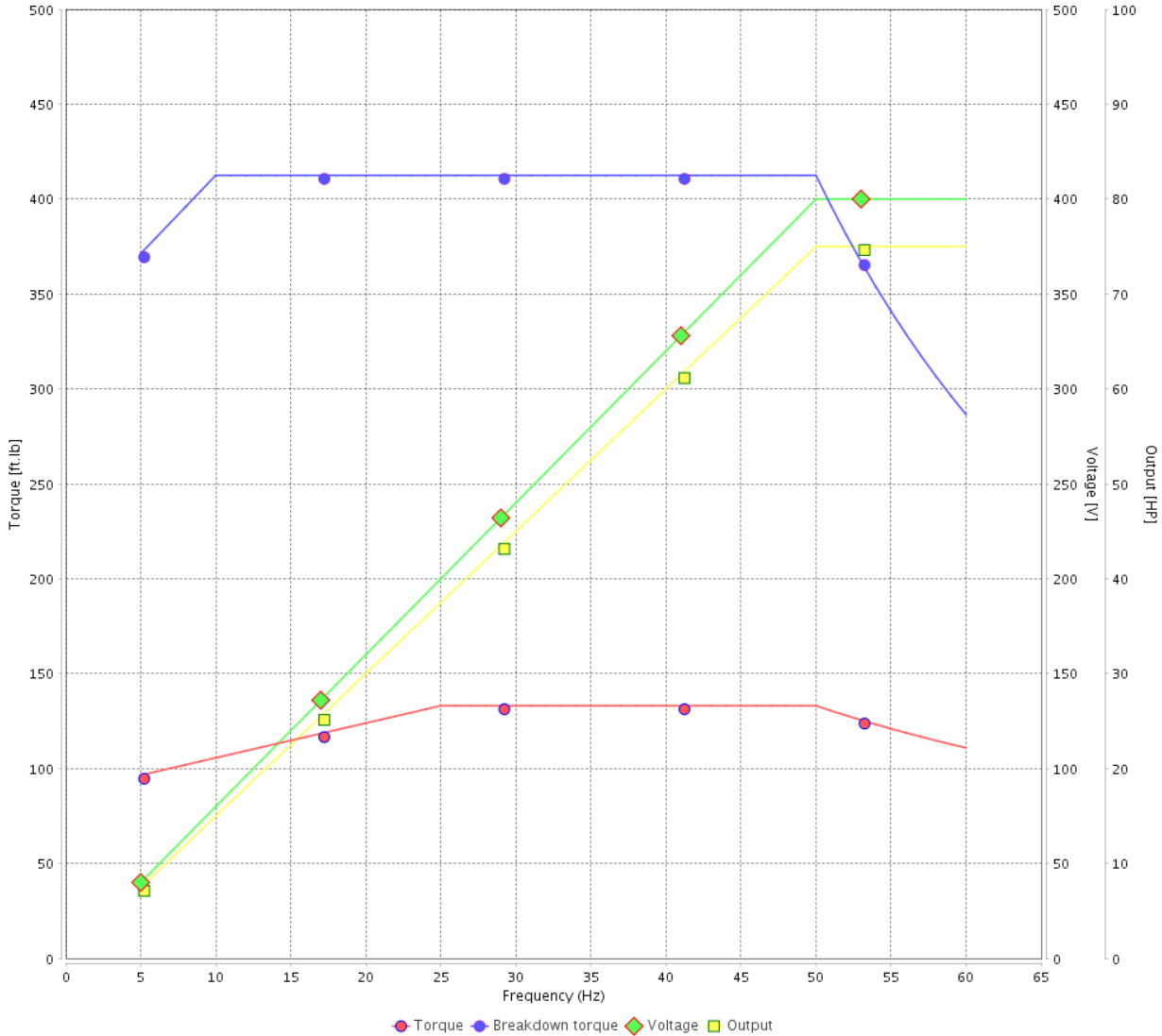

Performance : 400 V 50 Hz 2P IE3

Rated current : 94.6 A
 LRC : 7.6
 Rated torque : 133 ft.lb
 Locked rotor torque : 280 %
 Breakdown torque : 310 %
 Rated speed : 2960 rpm

Moment of inertia (J) : 13.2 sq.ft.lb
 Duty cycle : Cont.(S1)
 Insulation class : F
 Service factor : 1.00
 Temperature rise : 80 K
 Design : B

Rev.	Changes Summary	Performed	Checked	Date
Performed by			Page 20 /	Revision
Checked by				
Date	12/04/2022			

VFD OPERATION CURVE

Three Phase Induction Motor - Squirrel Cage



Customer :

Product line : NEMA Premium Efficiency Three-Phase
 Product code : 11904016
 Catalog # : 10036ET3G405JP-W22

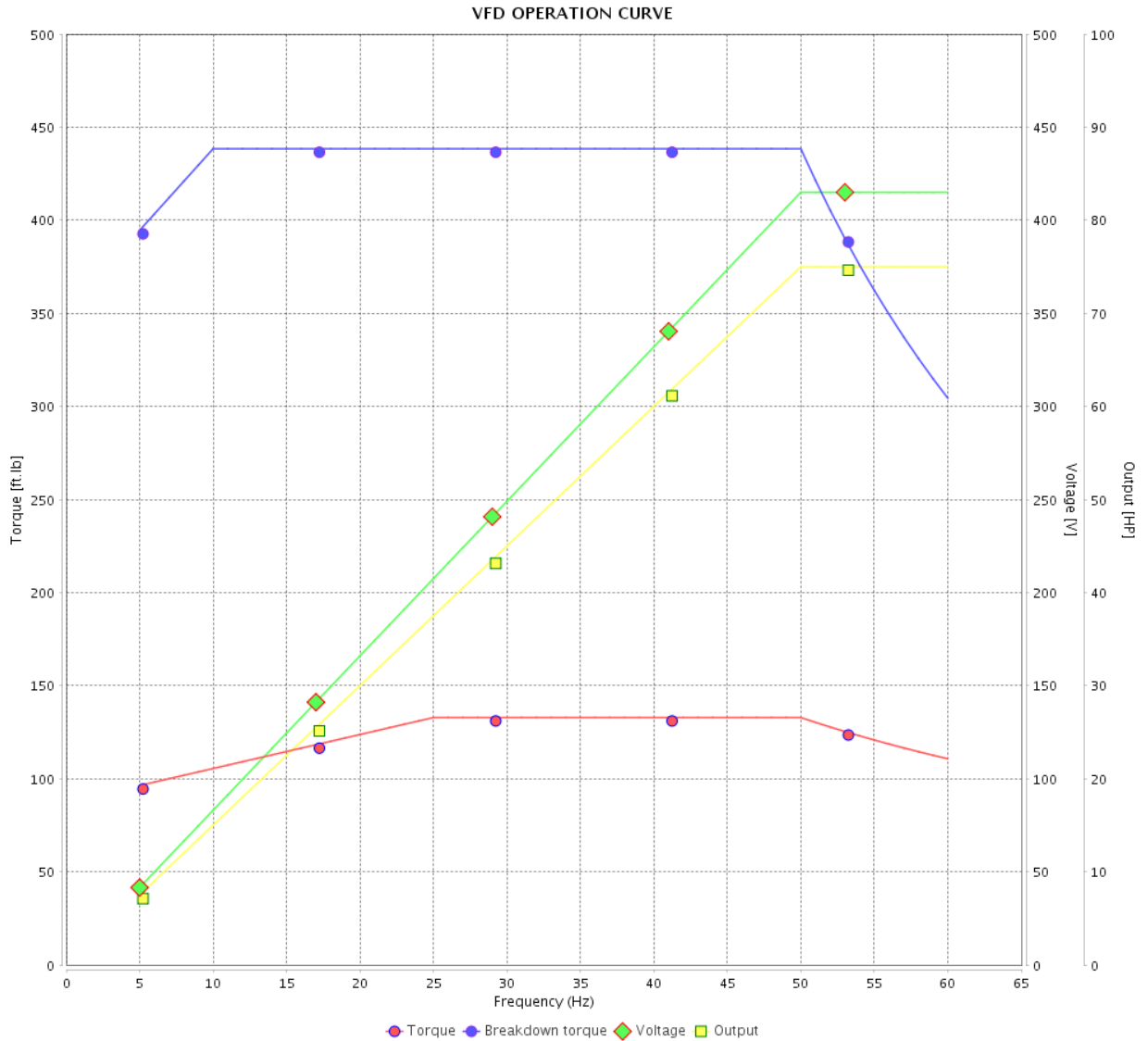

Performance : 415 V 50 Hz 2P IE3

Rated current : 92.2 A	Moment of inertia (J) : 13.2 sq.ft.lb
LRC : 8.2	Duty cycle : Cont.(S1)
Rated torque : 133 ft.lb	Insulation class : F
Locked rotor torque : 300 %	Service factor : 1.00
Breakdown torque : 330 %	Temperature rise : 80 K
Rated speed : 2965 rpm	Design : B

Rev.	Changes Summary	Performed	Checked	Date
Performed by			Page	Revision
Checked by				
Date				

1 2 3 4 5 6

A

B

C

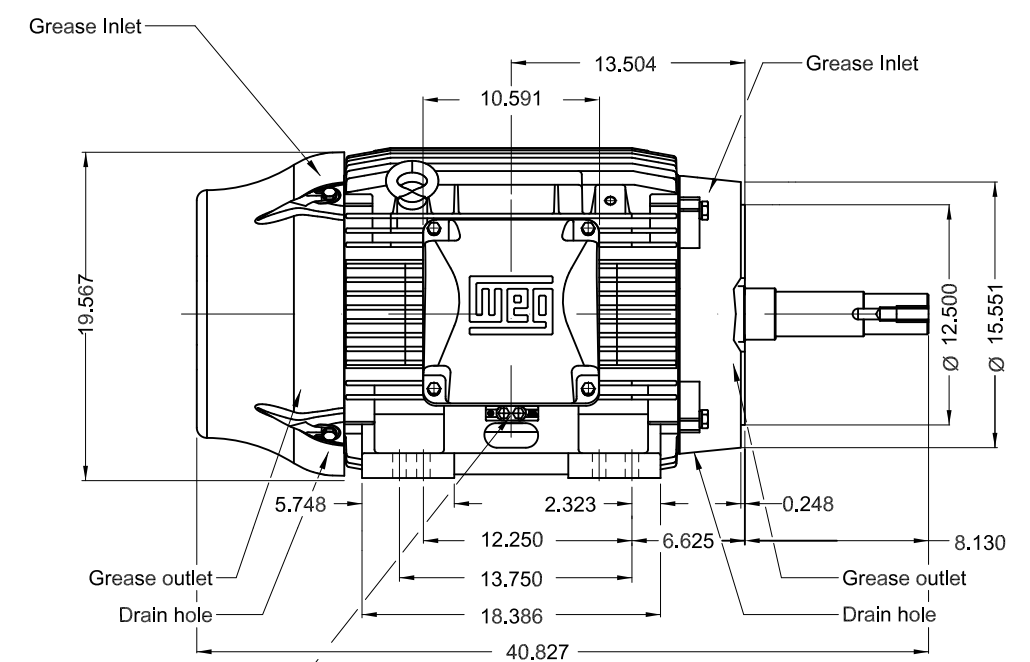
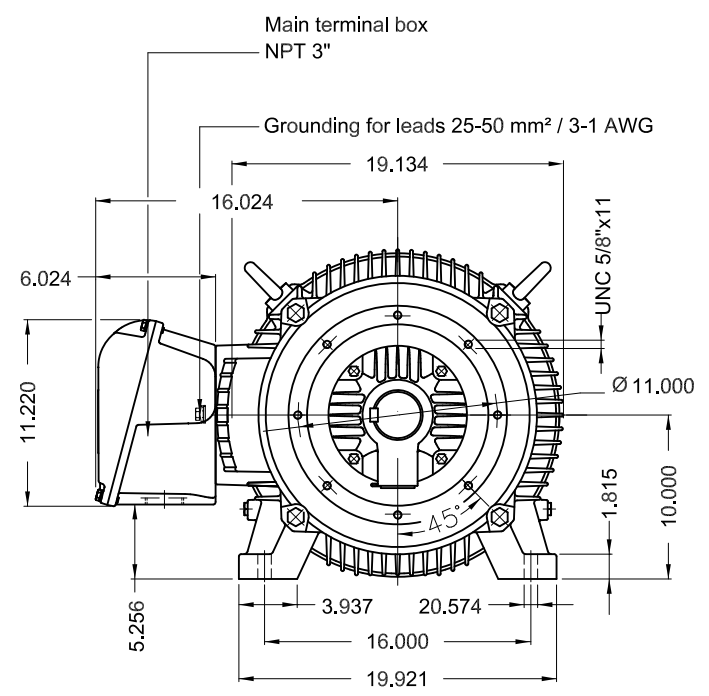

Grounding for leads 25-185 mm² / 3AWG-350MCM

D

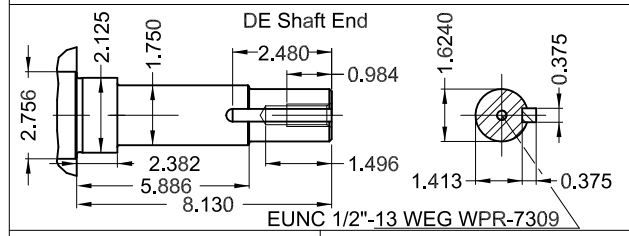

E

Without vertical jackscrews
 Color RAL 5009
 Painting plan 203A
 Mounting B34R(D)

100 HP 02 Poles 60 Hz A

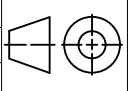
ECM	LOC	SUMMARY OF MODIFICATIONS	EXECUTED	CHECKED	RELEASED	DATE	VER
EXECUTED	PIRWUSER	 THREE PH. MOTOR JM/JP/JET PUMP W22 PREM. EFF. FRAME 404/5JP IP55 TEFC					
CHECKED							
RELEASED							
REL DT.	WMO		Jaragua do Sul	Product Engineering	SHEET	1 / 1	

PREVIEW
 WDD

