

DATA SHEET



Three Phase Induction Motor - Squirrel Cage

| | | | | | | | |
|--|---------------------------------------|-----------------------------|----------------------------|--|-------------------------|-------------------------|-------------------------|
| Customer | | | | | | | |
| Product line | : NEMA Premium Efficiency Three-Phase | Product code | : 12147620 | | | | |
| | | Catalog # | : 12509ST3QIE447T-W22 | | | | |
| Frame | : 445/7T | Cooling method | : IC411 - TEFC | | | | |
| Insulation class | : F | Mounting | : F-1 | | | | |
| Duty cycle | : Cont.(S1) | Rotation ¹ | : Both (CW and CCW) | | | | |
| Ambient temperature | : -20°C to +40°C | Starting method | : Direct On Line | | | | |
| Altitude | : 1000 m.a.s.l. | Approx. weight ² | : 2047 lb | | | | |
| Protection degree | : IP55 | Moment of inertia (J) | : 104 sq.ft.lb | | | | |
| Design | : B | | | | | | |
| Output [HP] | 125 | 100 | 100 | 100 | 125 | 125 | 125 |
| Poles | 8 | 8 | 8 | 8 | 8 | 8 | 8 |
| Frequency [Hz] | 60 | 50 | 50 | 50 | 50 | 50 | 50 |
| Rated voltage [V] | 460 | 380 | 400 | 415 | 380 | 400 | 415 |
| Rated current [A] | 151 | 156 | 152 | 148 | 187 | 179 | 174 |
| L. R. Amperes [A] | 906 | 920 | 988 | 1006 | 879 | 949 | 992 |
| LRC [A] | 6.0x(Code G) | 5.9x(Code G) | 6.5x(Code H) | 6.8x(Code J) | 4.7x(Code E) | 5.3x(Code F) | 5.7x(Code G) |
| No load current [A] | 65.0 | 64.1 | 70.0 | 75.5 | 64.1 | 70.0 | 75.5 |
| Rated speed [RPM] | 889 | 739 | 740 | 741 | 735 | 736 | 738 |
| Slip [%] | 1.22 | 1.47 | 1.33 | 1.20 | 2.00 | 1.87 | 1.60 |
| Rated torque [ft.lb] | 738 | 711 | 710 | 709 | 893 | 892 | 889 |
| Locked rotor torque [%] | 180 | 180 | 200 | 229 | 140 | 160 | 180 |
| Breakdown torque [%] | 210 | 210 | 240 | 260 | 170 | 190 | 210 |
| Service factor | 1.15 | 1.00 | 1.00 | 1.00 | 1.00 | 1.00 | 1.00 |
| Temperature rise | 80 K | 80 K | 80 K | 80 K | 105 K | 105 K | 105 K |
| Locked rotor time | 43s (cold) 24s (hot) | 50s (cold) 28s (hot) | 46s (cold) 26s (hot) | 43s (cold) 24s (hot) | 28s (cold) 16s (hot) | 30s (cold) 17s (hot) | 30s (cold) 17s (hot) |
| Noise level ² | 63.0 dB(A) | | | | | | |
| Efficiency (%) | 25% | | | | | | |
| | 50% | 94.5 | 94.4 | 93.6 | 92.9 | 94.5 | 94.0 |
| | 75% | 94.5 | 94.2 | 93.9 | 93.7 | 93.6 | 93.6 |
| | 100% | 94.5 | 93.4 | 93.6 | 93.7 | 92.4 | 93.0 |
| Power Factor | 25% | | | | | | |
| | 50% | 0.64 | 0.62 | 0.58 | 0.55 | 0.68 | 0.66 |
| | 75% | 0.74 | 0.74 | 0.71 | 0.68 | 0.77 | 0.74 |
| | 100% | 0.79 | 0.78 | 0.76 | 0.75 | 0.79 | 0.78 |
| Bearing type | : Drive end 6319 C3 | Non drive end 6316 C3 | Foundation loads | | | | |
| Sealing | : Inpro/Seal | Inpro/Seal | Max. traction : 3956 lb | | | | |
| Lubrication interval | : 17000 h | 20000 h | Max. compression : 6003 lb | | | | |
| Lubricant amount | : 45 g | 34 g | | | | | |
| Lubricant type | : Mobil Polyrex EM | | | | | | |
| Notes | | | | | | | |
| This revision replaces and cancel the previous one, which must be eliminated. (1) Looking the motor from the shaft end. (2) Measured at 1m and with tolerance of +3dB(A). (3) Approximate weight subject to changes after manufacturing process. (4) At 100% of full load. | | | | These are average values based on tests with sinusoidal power supply, subject to the tolerances stipulated in NEMA MG-1. | | | |
| Rev. | Changes Summary | | | Performed | Checked | Date | |
| Performed by | | | | | | | |
| Checked by | | | | | Page | Revision | |
| Date | 14/04/2022 | | | | 1 / 36 | | |

TORQUE AND CURRENT VS SPEED CURVE

Three Phase Induction Motor - Squirrel Cage



Customer :

Product line : NEMA Premium Efficiency Three-Phase

Product code : 12147620

Catalog # : 12509ST3QIE447T-W22

TORQUE AND CURRENT VS SPEED CURVE

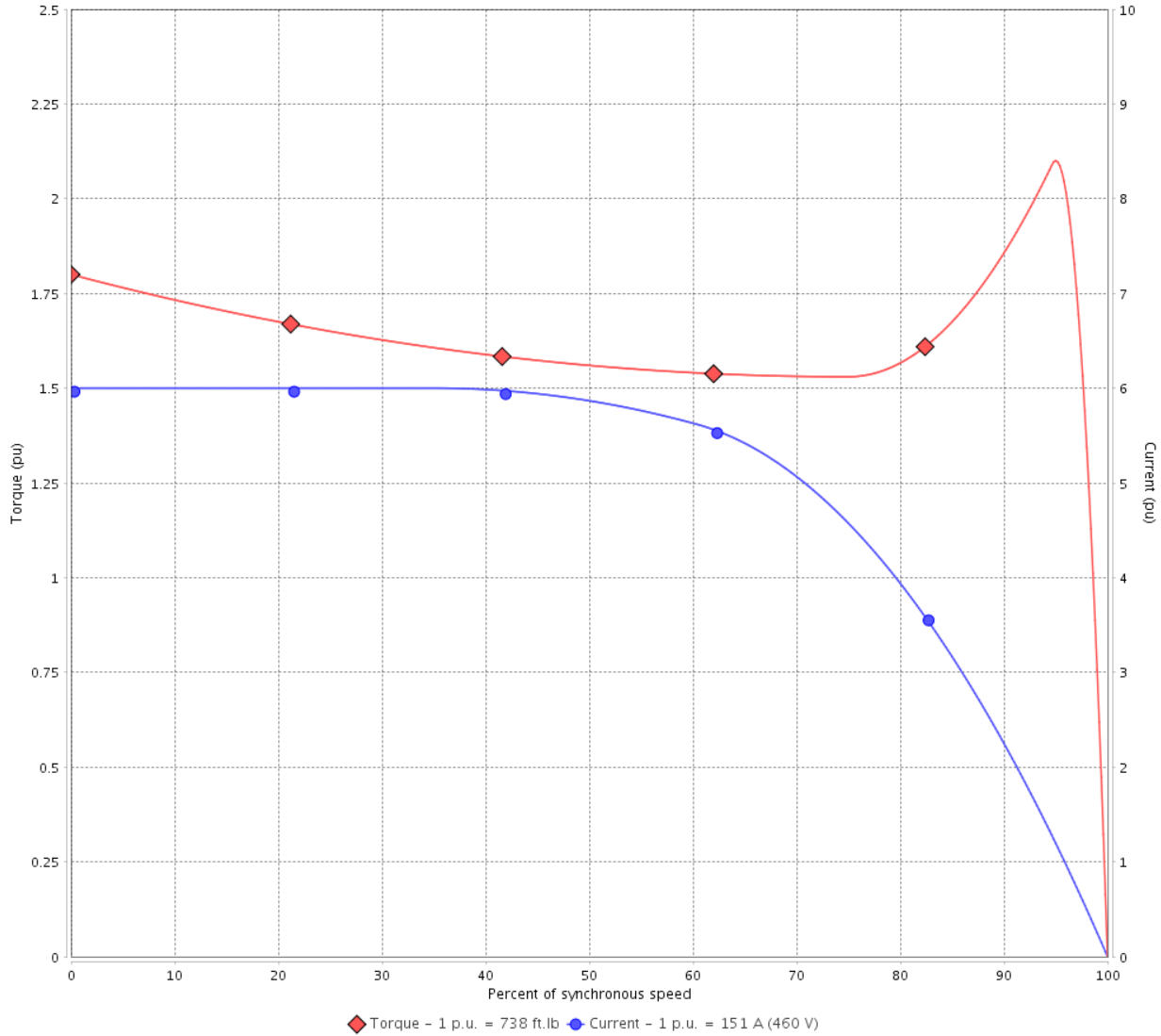

Performance : 460 V 60 Hz 8P

| | | | |
|---------------------|-------------|-----------------------|----------------|
| Rated current | : 151 A | Moment of inertia (J) | : 104 sq.ft.lb |
| LRC | : 6.0 | Duty cycle | : Cont.(S1) |
| Rated torque | : 738 ft.lb | Insulation class | : F |
| Locked rotor torque | : 180 % | Service factor | : 1.15 |
| Breakdown torque | : 210 % | Temperature rise | : 80 K |
| Rated speed | : 889 rpm | Design | : B |

Locked rotor time : 43s (cold) 24s (hot)

| Rev. | Changes Summary | Performed | Checked | Date |
|--------------|-----------------|-----------|----------------|----------|
| | | | | |
| Performed by | | | Page 2 / 36 | Revision |
| Checked by | | | | |
| Date | 14/04/2022 | | | |

TORQUE AND CURRENT VS SPEED CURVE



Three Phase Induction Motor - Squirrel Cage

Customer :

Product line : NEMA Premium Efficiency Three-Phase

Product code : 12147620

Catalog # : 12509ST3QIE447T-W22

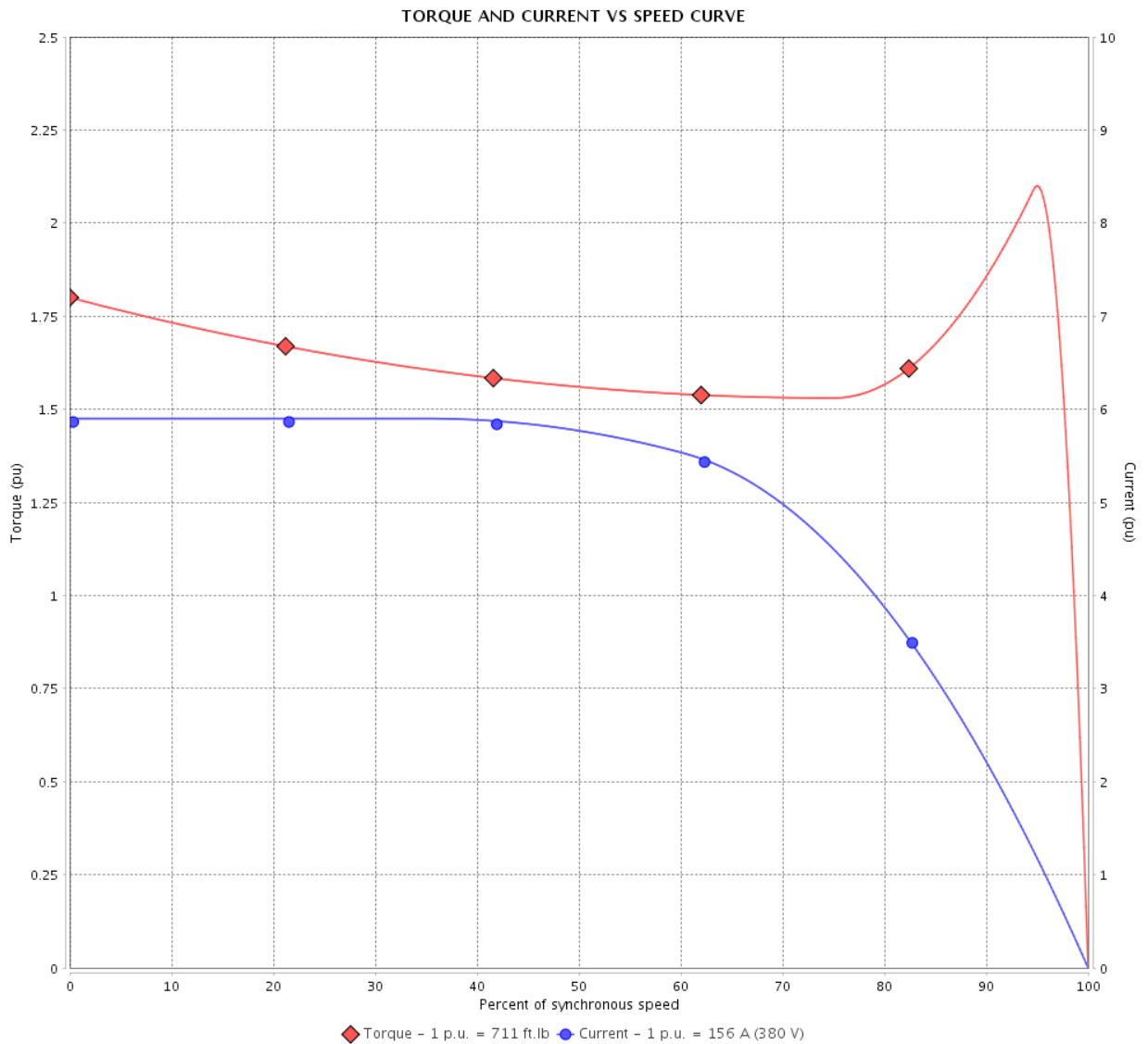

Performance : 380 V 50 Hz 8P IE3

| | | | |
|---------------------|-------------|-----------------------|----------------|
| Rated current | : 156 A | Moment of inertia (J) | : 104 sq.ft.lb |
| LRC | : 5.9 | Duty cycle | : Cont.(S1) |
| Rated torque | : 711 ft.lb | Insulation class | : F |
| Locked rotor torque | : 180 % | Service factor | : 1.00 |
| Breakdown torque | : 210 % | Temperature rise | : 80 K |
| Rated speed | : 739 rpm | Design | : B |

Locked rotor time : 50s (cold) 28s (hot)

| Rev. | Changes Summary | Performed | Checked | Date |
|--------------|-----------------|-----------|----------------|----------|
| | | | | |
| Performed by | | | Page 3 / 36 | Revision |
| Checked by | | | | |
| Date | 14/04/2022 | | | |

TORQUE AND CURRENT VS SPEED CURVE

Three Phase Induction Motor - Squirrel Cage



Customer :

Product line : NEMA Premium Efficiency Three-Phase

Product code : 12147620

Catalog # : 12509ST3QIE447T-W22

TORQUE AND CURRENT VS SPEED CURVE

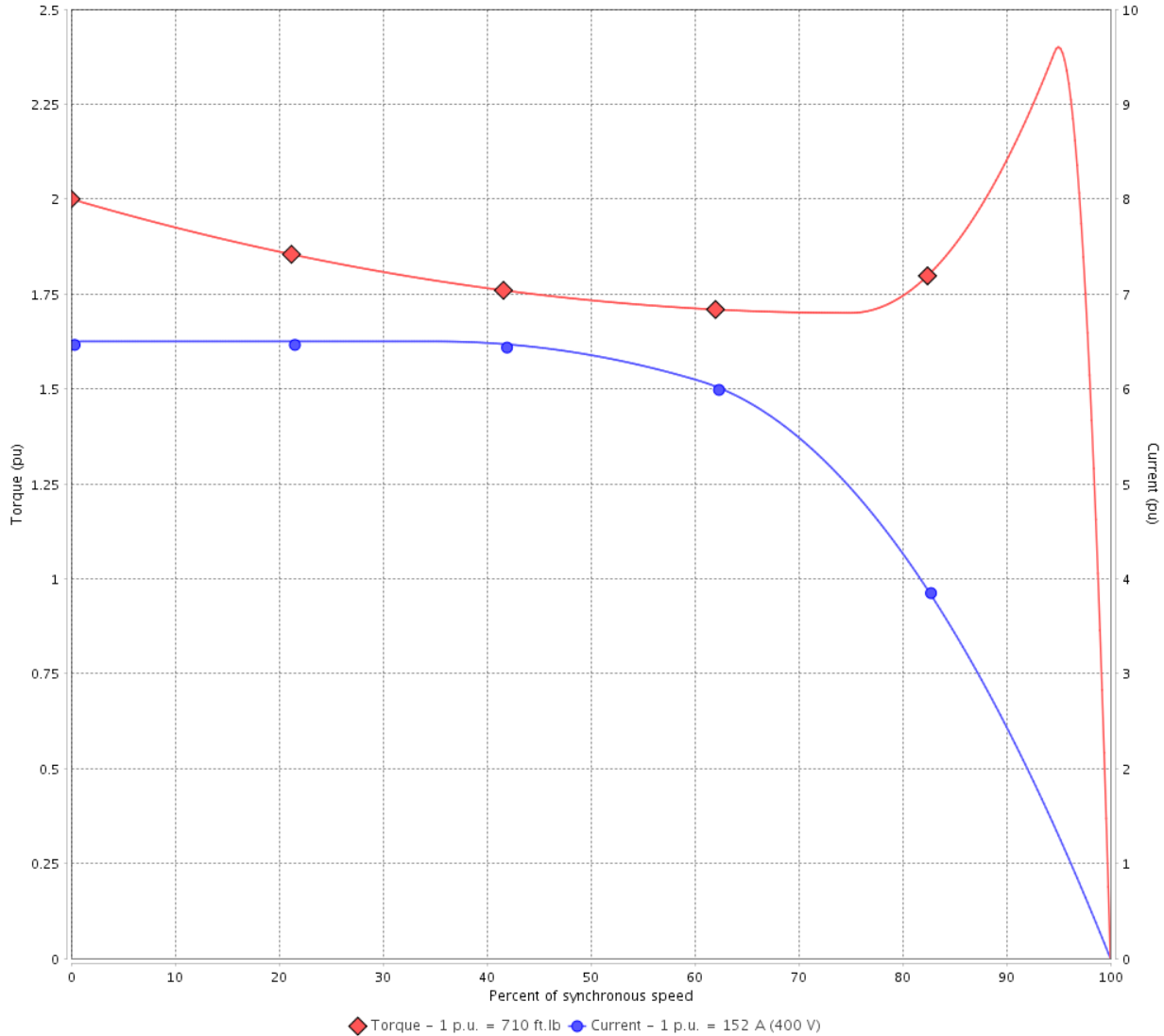

Performance : 400 V 50 Hz 8P IE3

| | | | |
|---------------------|-------------|-----------------------|----------------|
| Rated current | : 152 A | Moment of inertia (J) | : 104 sq.ft.lb |
| LRC | : 6.5 | Duty cycle | : Cont.(S1) |
| Rated torque | : 710 ft.lb | Insulation class | : F |
| Locked rotor torque | : 200 % | Service factor | : 1.00 |
| Breakdown torque | : 240 % | Temperature rise | : 80 K |
| Rated speed | : 740 rpm | Design | : B |

Locked rotor time : 46s (cold) 26s (hot)

| Rev. | Changes Summary | Performed | Checked | Date |
|--------------|-----------------|-----------|----------------|----------|
| | | | | |
| Performed by | | | Page 4 / 36 | Revision |
| Checked by | | | | |
| Date | 14/04/2022 | | | |

TORQUE AND CURRENT VS SPEED CURVE



Three Phase Induction Motor - Squirrel Cage

Customer :

Product line : NEMA Premium Efficiency Three-Phase

Product code : 12147620

Catalog # : 12509ST3QIE447T-W22

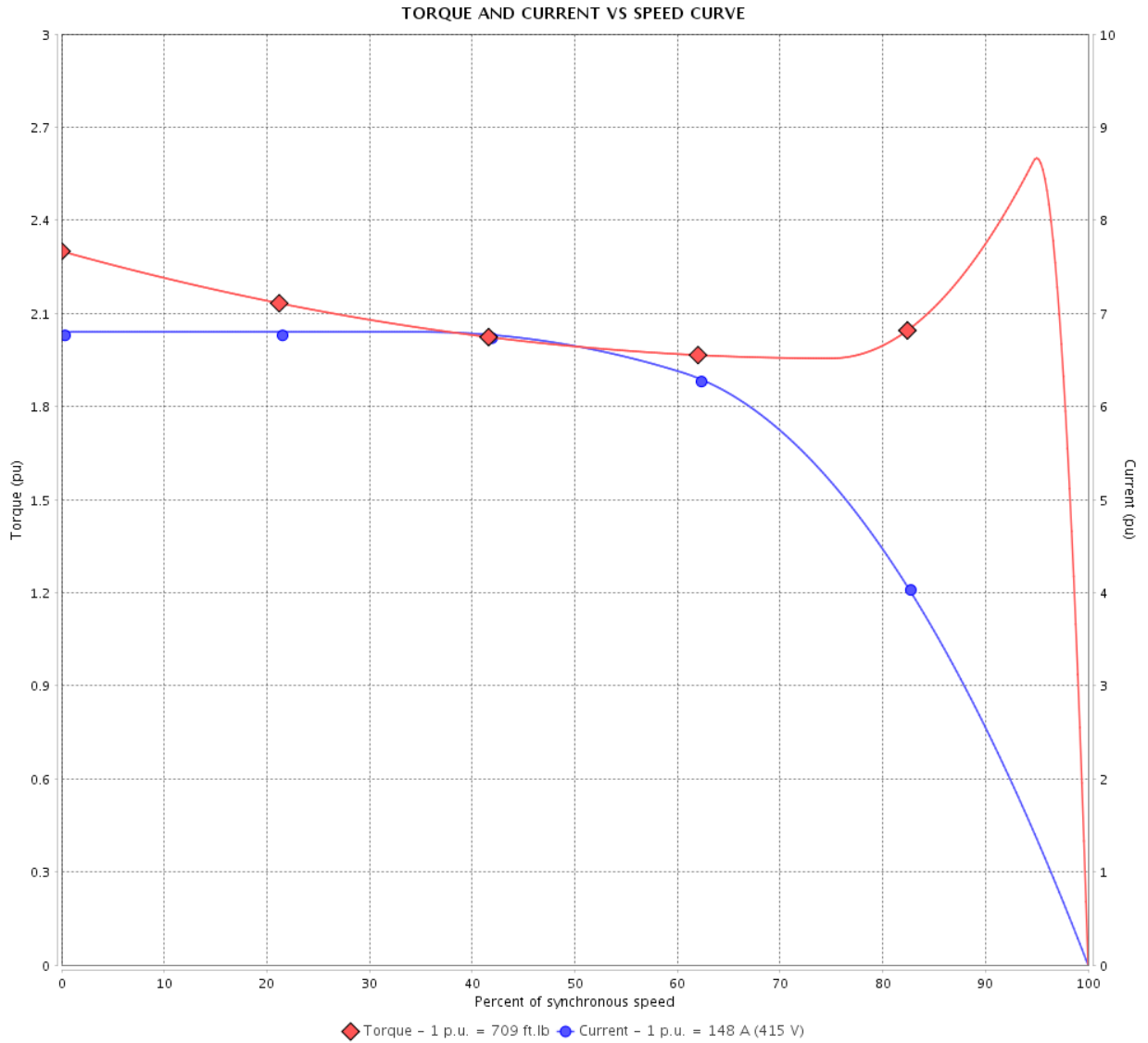

Performance : 415 V 50 Hz 8P IE3

| | | | |
|---------------------|-------------|-----------------------|----------------|
| Rated current | : 148 A | Moment of inertia (J) | : 104 sq.ft.lb |
| LRC | : 6.8 | Duty cycle | : Cont.(S1) |
| Rated torque | : 709 ft.lb | Insulation class | : F |
| Locked rotor torque | : 229 % | Service factor | : 1.00 |
| Breakdown torque | : 260 % | Temperature rise | : 80 K |
| Rated speed | : 741 rpm | Design | : B |

Locked rotor time : 43s (cold) 24s (hot)

| Rev. | Changes Summary | Performed | Checked | Date |
|--------------|-----------------|-----------|----------------|----------|
| | | | | |
| Performed by | | | Page 5 / 36 | Revision |
| Checked by | | | | |
| Date | 14/04/2022 | | | |

TORQUE AND CURRENT VS SPEED CURVE

Three Phase Induction Motor - Squirrel Cage



Customer :

Product line : NEMA Premium Efficiency Three-Phase

Product code : 12147620

Catalog # : 12509ST3QIE447T-W22

TORQUE AND CURRENT VS SPEED CURVE

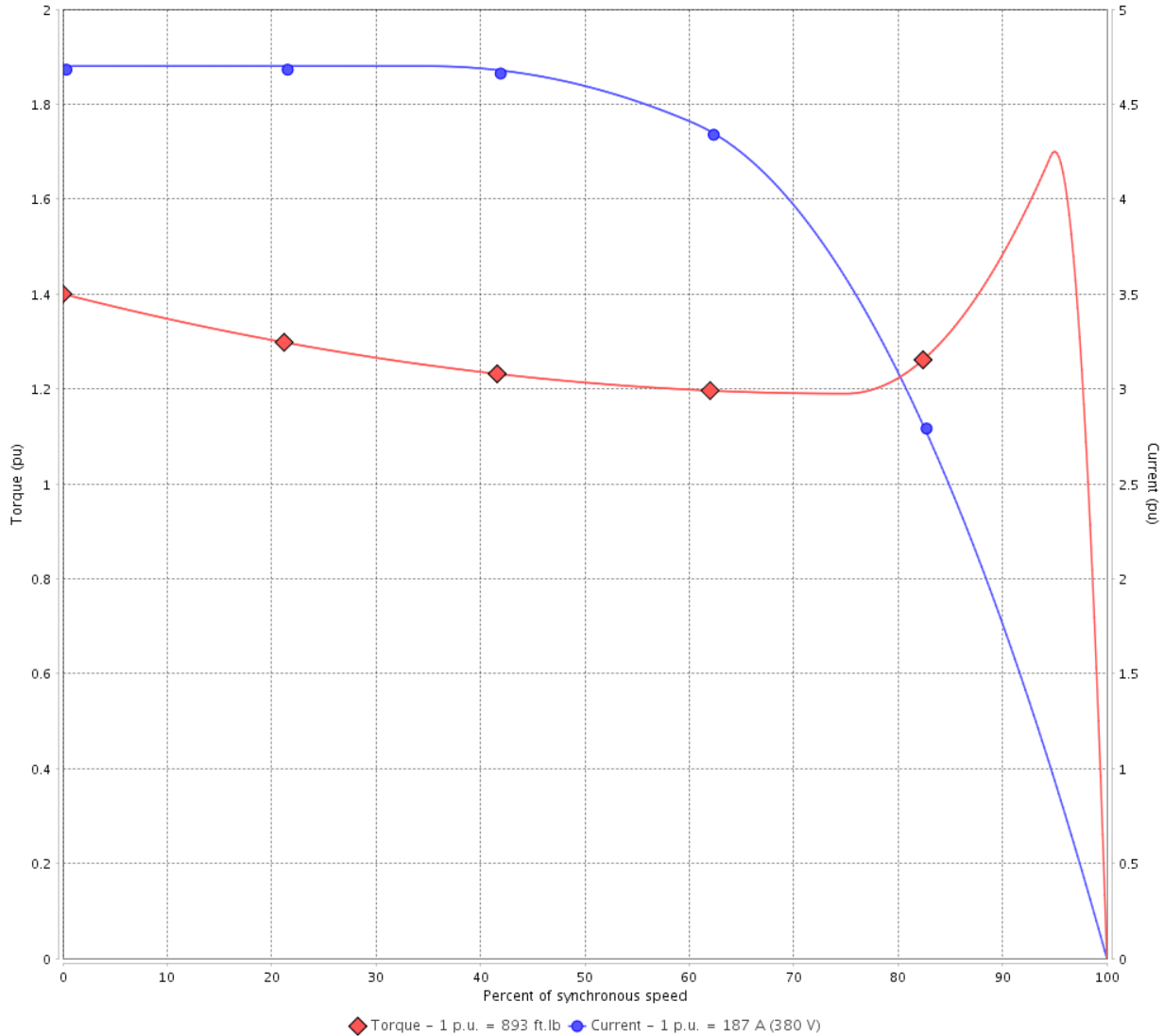

Performance : 380 V 50 Hz 8P IE2

| | | | |
|---------------------|-------------|-----------------------|----------------|
| Rated current | : 187 A | Moment of inertia (J) | : 104 sq.ft.lb |
| LRC | : 4.7 | Duty cycle | : Cont.(S1) |
| Rated torque | : 893 ft.lb | Insulation class | : F |
| Locked rotor torque | : 140 % | Service factor | : 1.00 |
| Breakdown torque | : 170 % | Temperature rise | : 105 K |
| Rated speed | : 735 rpm | Design | : B |

Locked rotor time : 28s (cold) 16s (hot)

| Rev. | Changes Summary | Performed | Checked | Date |
|--------------|-----------------|-----------|----------------|----------|
| | | | | |
| Performed by | | | Page 6 / 36 | Revision |
| Checked by | | | | |
| Date | 14/04/2022 | | | |

TORQUE AND CURRENT VS SPEED CURVE



Three Phase Induction Motor - Squirrel Cage

Customer :

Product line : NEMA Premium Efficiency Three-Phase

Product code : 12147620

Catalog # : 12509ST3QIE447T-W22

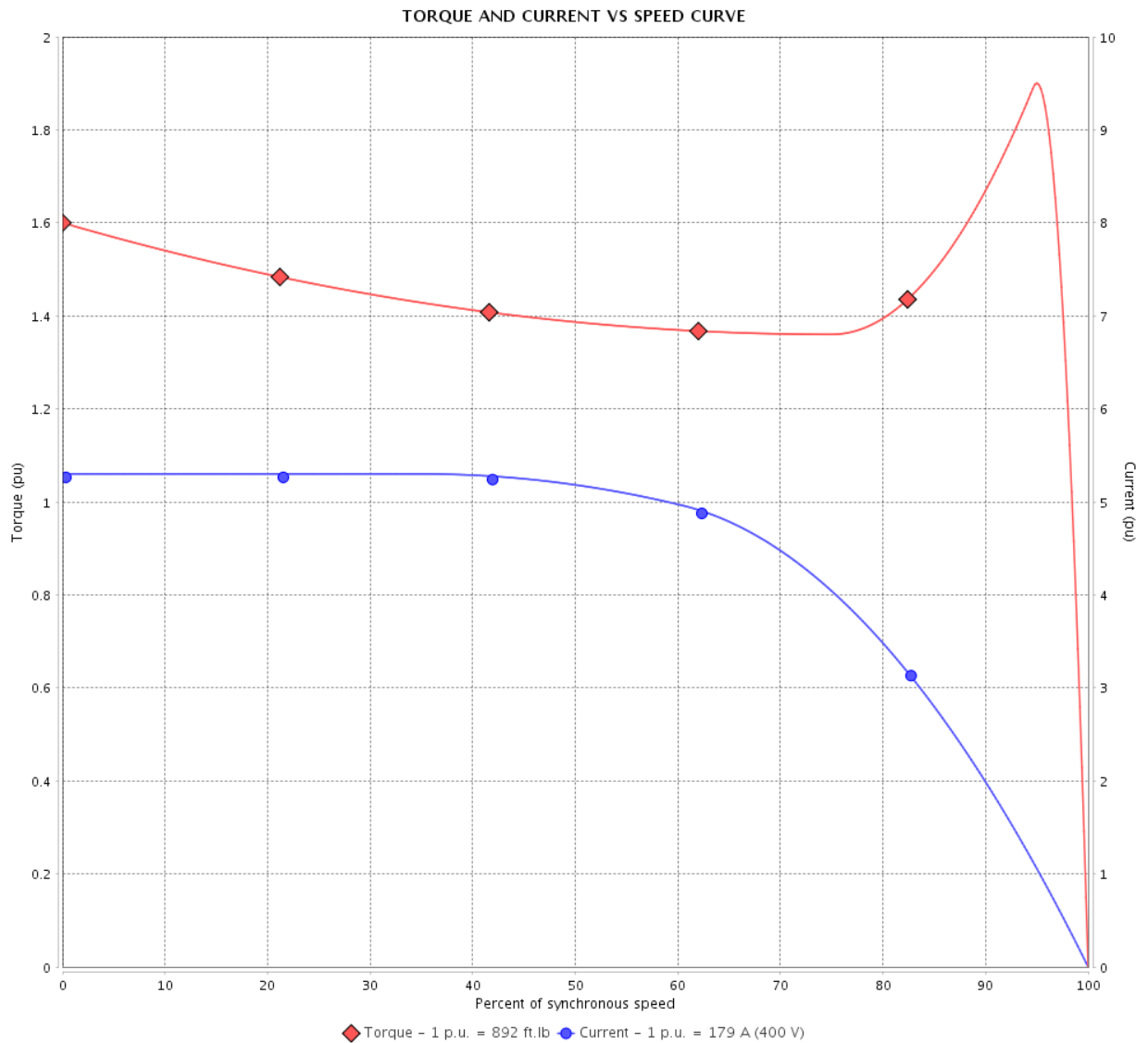

Performance : 400 V 50 Hz 8P IE2

| | | | |
|---------------------|-------------|-----------------------|----------------|
| Rated current | : 179 A | Moment of inertia (J) | : 104 sq.ft.lb |
| LRC | : 5.3 | Duty cycle | : Cont.(S1) |
| Rated torque | : 892 ft.lb | Insulation class | : F |
| Locked rotor torque | : 160 % | Service factor | : 1.00 |
| Breakdown torque | : 190 % | Temperature rise | : 105 K |
| Rated speed | : 736 rpm | Design | : B |

Locked rotor time : 30s (cold) 17s (hot)

| Rev. | Changes Summary | Performed | Checked | Date |
|--------------|-----------------|-----------|----------------|----------|
| | | | | |
| Performed by | | | Page 7 / 36 | Revision |
| Checked by | | | | |
| Date | 14/04/2022 | | | |

TORQUE AND CURRENT VS SPEED CURVE

Three Phase Induction Motor - Squirrel Cage



Customer :

Product line : NEMA Premium Efficiency Three-Phase

Product code : 12147620

Catalog # : 12509ST3QIE447T-W22

TORQUE AND CURRENT VS SPEED CURVE

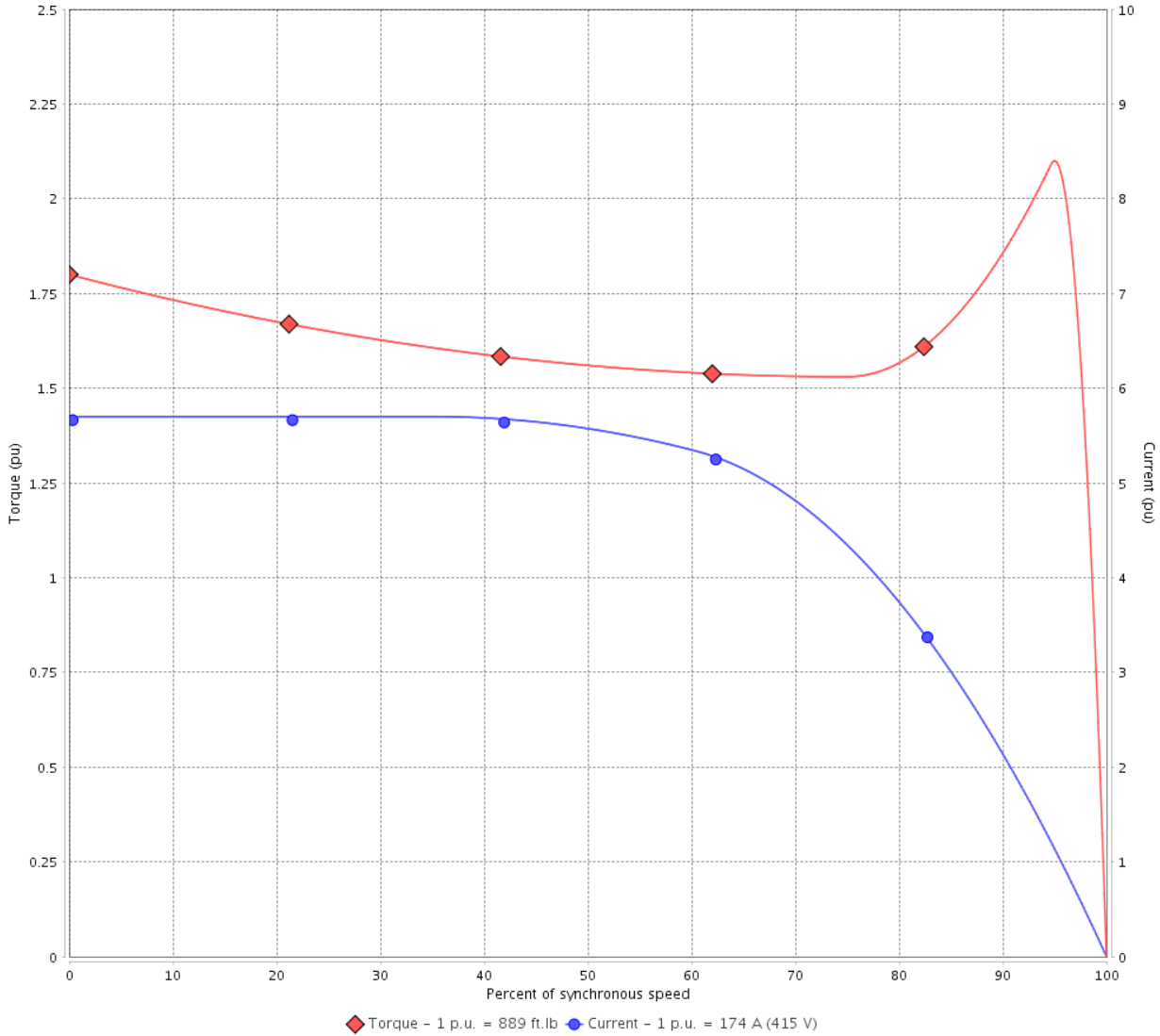

Performance : 415 V 50 Hz 8P IE3

| | | | |
|---------------------|-------------|-----------------------|----------------|
| Rated current | : 174 A | Moment of inertia (J) | : 104 sq.ft.lb |
| LRC | : 5.7 | Duty cycle | : Cont.(S1) |
| Rated torque | : 889 ft.lb | Insulation class | : F |
| Locked rotor torque | : 180 % | Service factor | : 1.00 |
| Breakdown torque | : 210 % | Temperature rise | : 105 K |
| Rated speed | : 738 rpm | Design | : B |

Locked rotor time : 30s (cold) 17s (hot)

| Rev. | Changes Summary | Performed | Checked | Date |
|--------------|-----------------|-----------|----------------|----------|
| | | | | |
| Performed by | | | Page 8 / 36 | Revision |
| Checked by | | | | |
| Date | 14/04/2022 | | | |

LOAD PERFORMANCE CURVE

Three Phase Induction Motor - Squirrel Cage



Customer :

Product line : NEMA Premium Efficiency Three-Phase

Product code : 12147620

Catalog # : 12509ST3QIE447T-W22

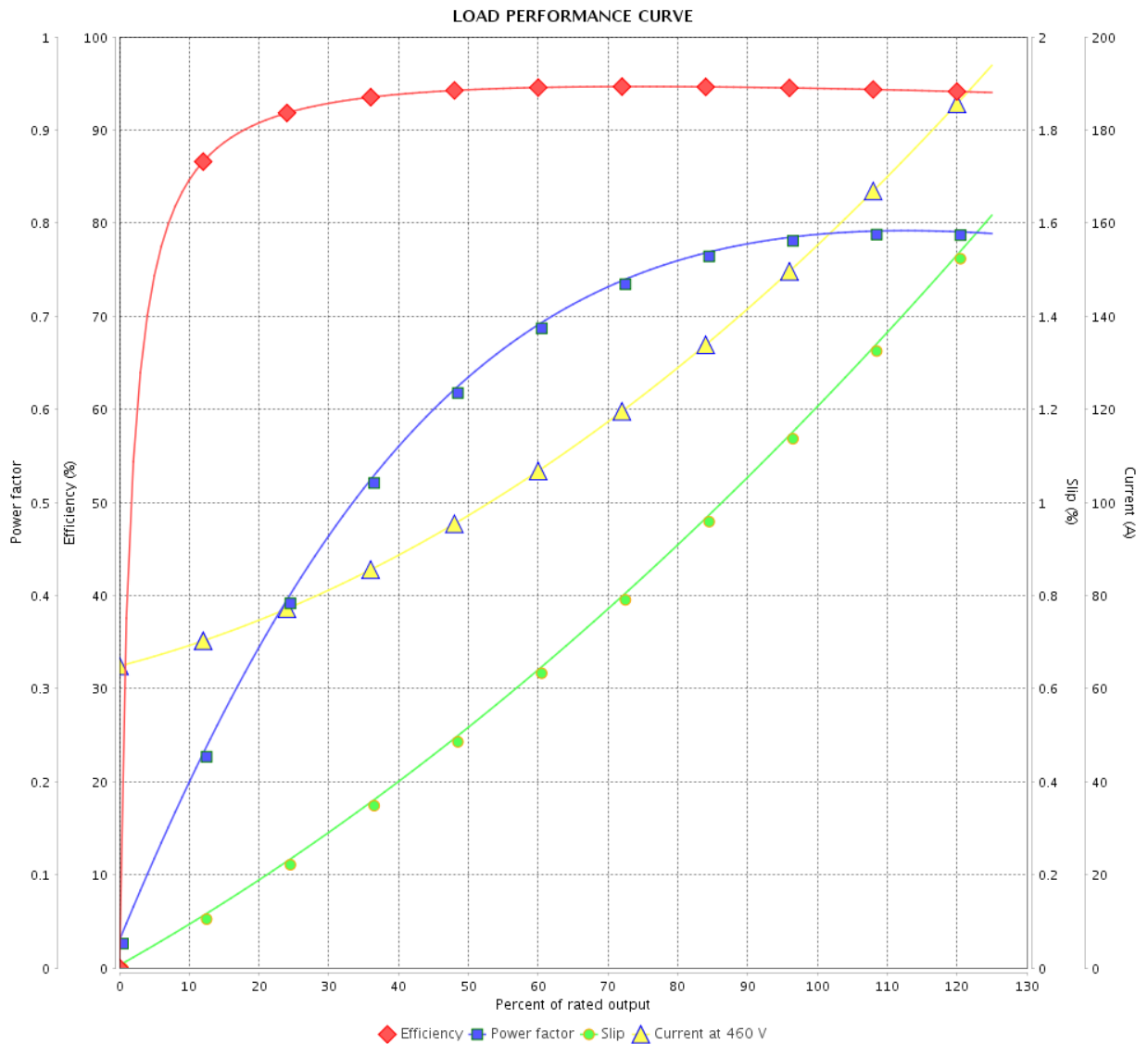

Performance : 460 V 60 Hz 8P

Rated current : 151 A
 LRC : 6.0
 Rated torque : 738 ft.lb
 Locked rotor torque : 180 %
 Breakdown torque : 210 %
 Rated speed : 889 rpm

Moment of inertia (J) : 104 sq.ft.lb
 Duty cycle : Cont.(S1)
 Insulation class : F
 Service factor : 1.15
 Temperature rise : 80 K
 Design : B

| Rev. | Changes Summary | Performed | Checked | Date |
|--------------|-----------------|-----------|---------|----------|
| | | | | |
| Performed by | | | Page | Revision |
| Checked by | | | 9 / 36 | |
| Date | 14/04/2022 | | | |

LOAD PERFORMANCE CURVE

Three Phase Induction Motor - Squirrel Cage



Customer :

Product line : NEMA Premium Efficiency Three-Phase

Product code : 12147620

Catalog # : 12509ST3QIE447T-W22

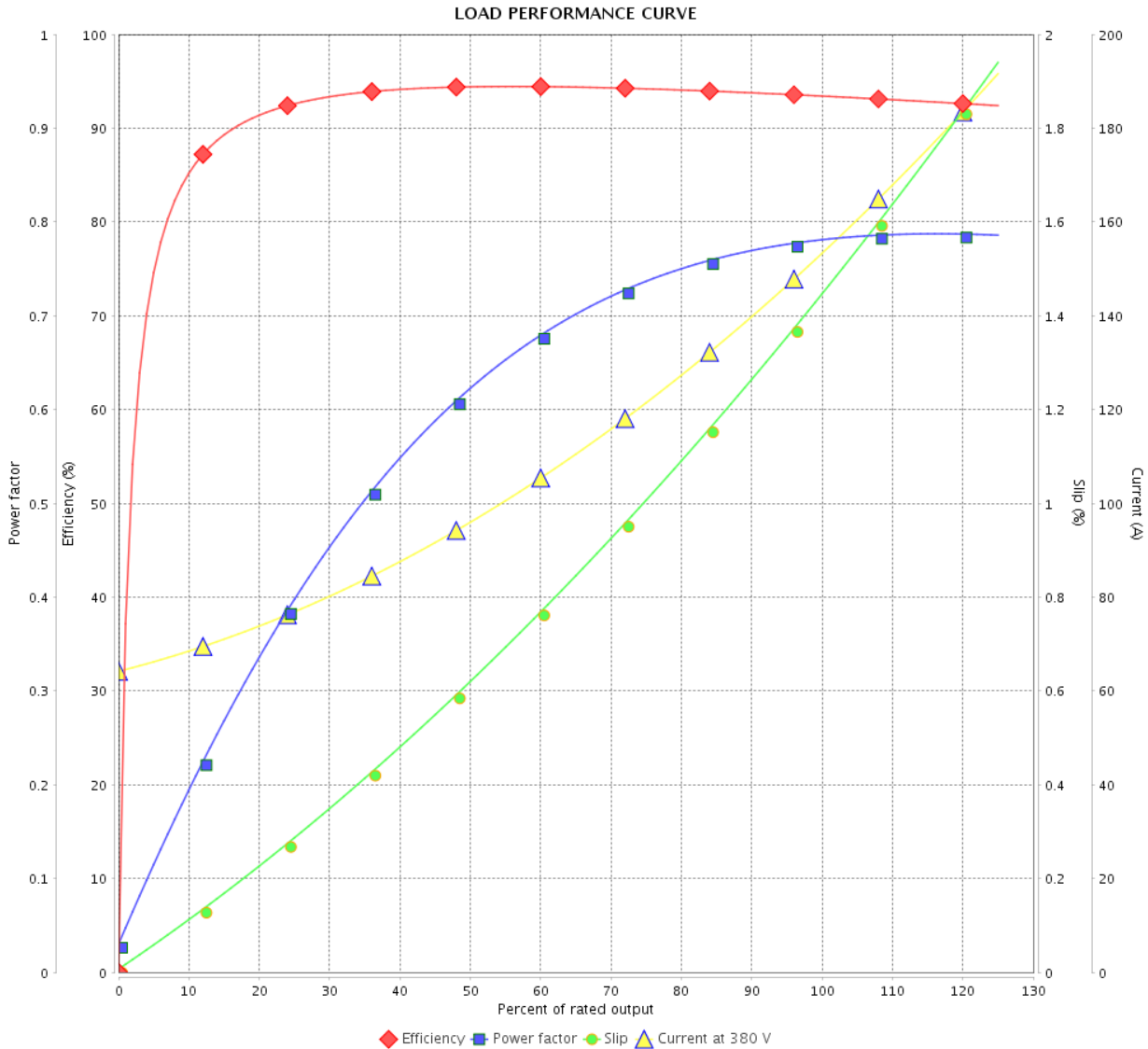

Performance : 380 V 50 Hz 8P IE3

| | | | |
|---------------------|-------------|-----------------------|----------------|
| Rated current | : 156 A | Moment of inertia (J) | : 104 sq.ft.lb |
| LRC | : 5.9 | Duty cycle | : Cont.(S1) |
| Rated torque | : 711 ft.lb | Insulation class | : F |
| Locked rotor torque | : 180 % | Service factor | : 1.00 |
| Breakdown torque | : 210 % | Temperature rise | : 80 K |
| Rated speed | : 739 rpm | Design | : B |

| Rev. | Changes Summary | Performed | Checked | Date |
|--------------|-----------------|-----------|-----------------|----------|
| | | | | |
| Performed by | | | Page 10 / 36 | Revision |
| Checked by | | | | |
| Date | 14/04/2022 | | | |

LOAD PERFORMANCE CURVE

Three Phase Induction Motor - Squirrel Cage



Customer : _____

Product line : NEMA Premium Efficiency Three-Phase

Product code : 12147620

Catalog # : 12509ST3QIE447T-W22

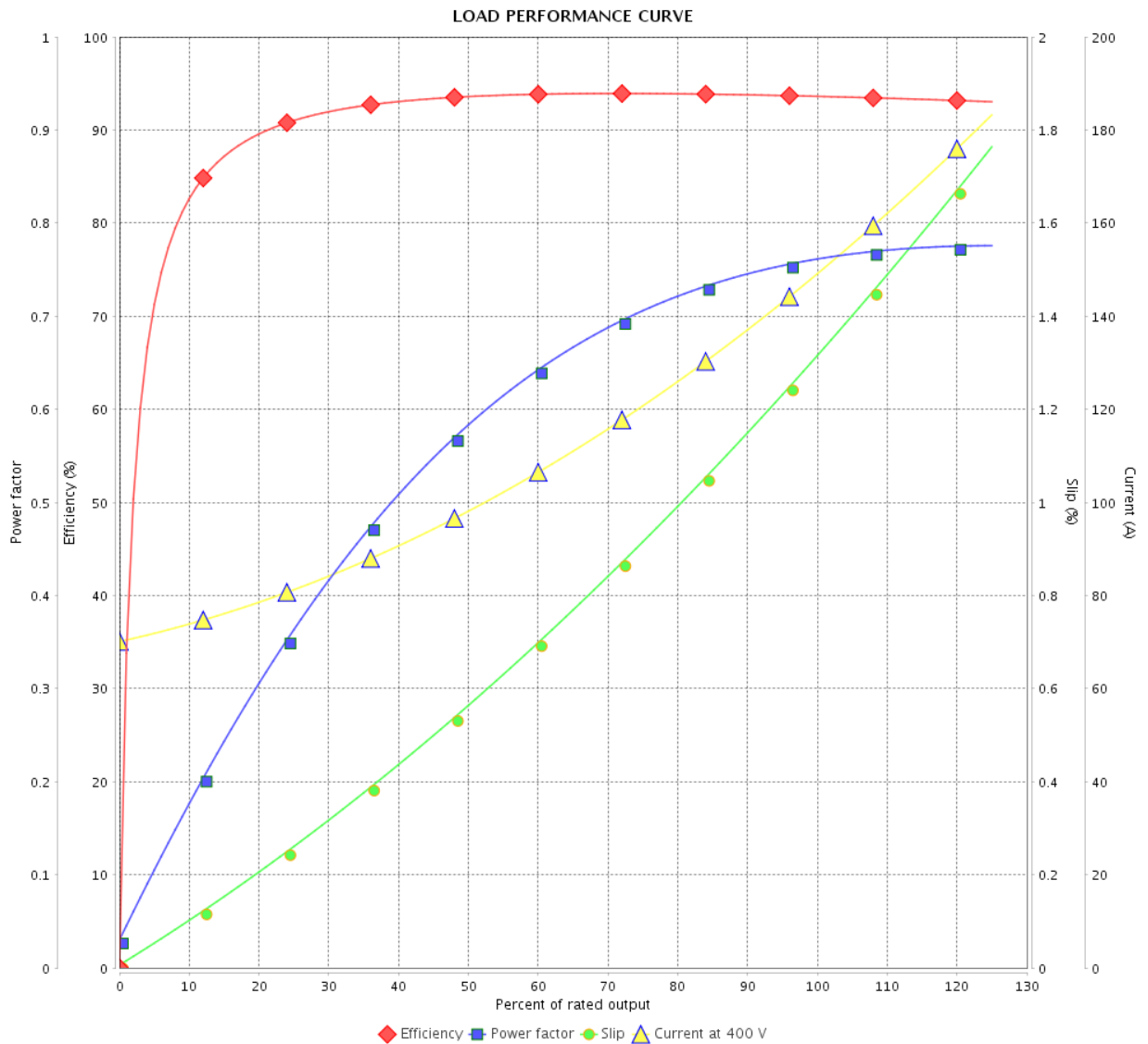

Performance : 400 V 50 Hz 8P IE3

Rated current : 152 A
 LRC : 6.5
 Rated torque : 710 ft.lb
 Locked rotor torque : 200 %
 Breakdown torque : 240 %
 Rated speed : 740 rpm

Moment of inertia (J) : 104 sq.ft.lb
 Duty cycle : Cont.(S1)
 Insulation class : F
 Service factor : 1.00
 Temperature rise : 80 K
 Design : B

| Rev. | Changes Summary | Performed | Checked | Date |
|--------------|-----------------|------------|---------|----------|
| | | | | |
| Performed by | | Page | | Revision |
| Checked by | | 11 / 36 | | |
| Date | | 14/04/2022 | | |

LOAD PERFORMANCE CURVE

Three Phase Induction Motor - Squirrel Cage



Customer : _____

Product line : NEMA Premium Efficiency Three-Phase

Product code : 12147620

Catalog # : 12509ST3QIE447T-W22

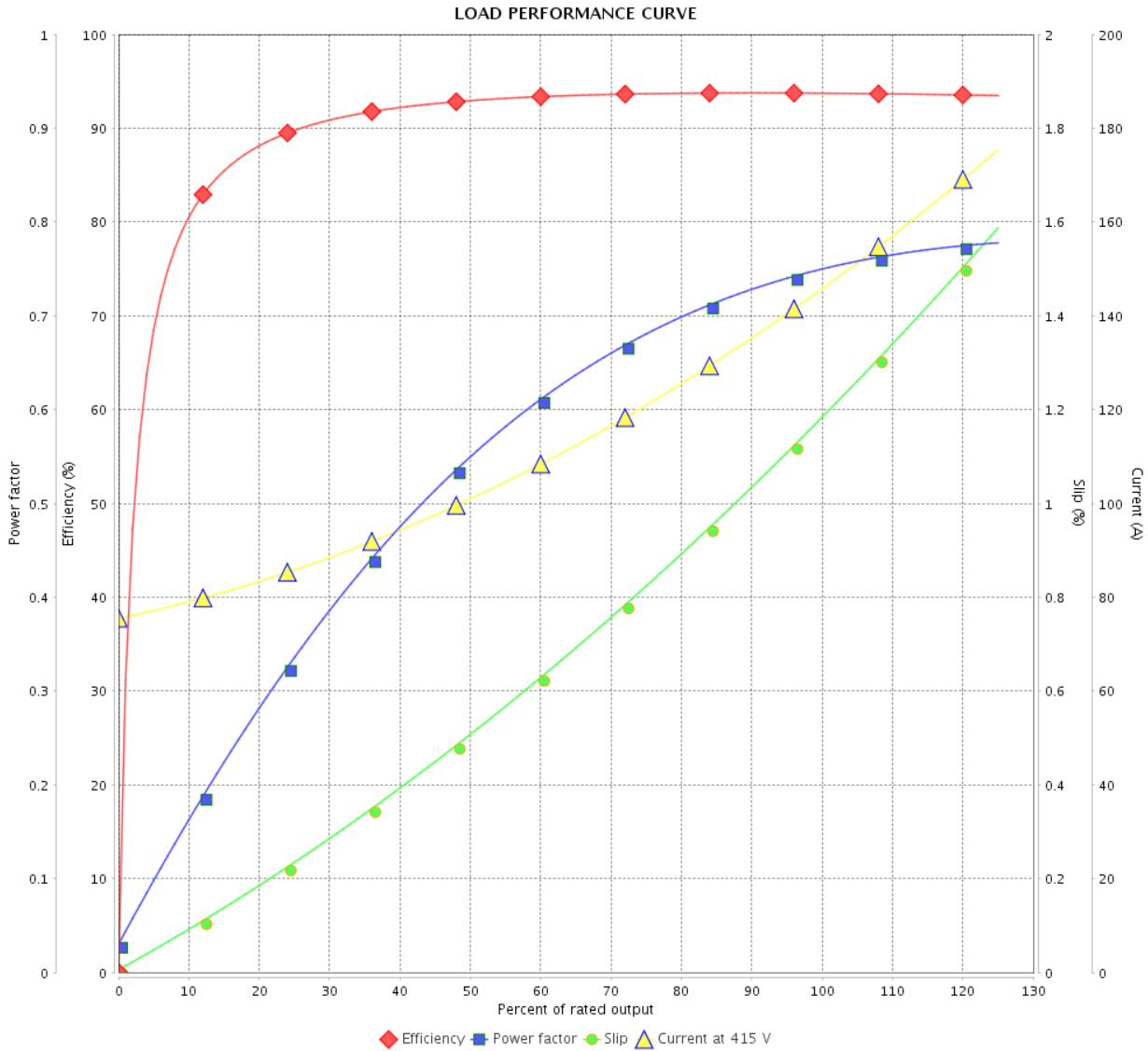

Performance : 415 V 50 Hz 8P IE3

| | |
|-----------------------------|--------------------------------------|
| Rated current : 148 A | Moment of inertia (J) : 104 sq.ft.lb |
| LRC : 6.8 | Duty cycle : Cont.(S1) |
| Rated torque : 709 ft.lb | Insulation class : F |
| Locked rotor torque : 229 % | Service factor : 1.00 |
| Breakdown torque : 260 % | Temperature rise : 80 K |
| Rated speed : 741 rpm | Design : B |

| Rev. | Changes Summary | Performed | Checked | Date |
|--------------|-----------------|-----------|-----------------|----------|
| | | | | |
| Performed by | | | Page 12 / 36 | Revision |
| Checked by | | | | |
| Date | 14/04/2022 | | | |

LOAD PERFORMANCE CURVE

Three Phase Induction Motor - Squirrel Cage



Customer :

Product line : NEMA Premium Efficiency Three-Phase

Product code : 12147620

Catalog # : 12509ST3QIE447T-W22

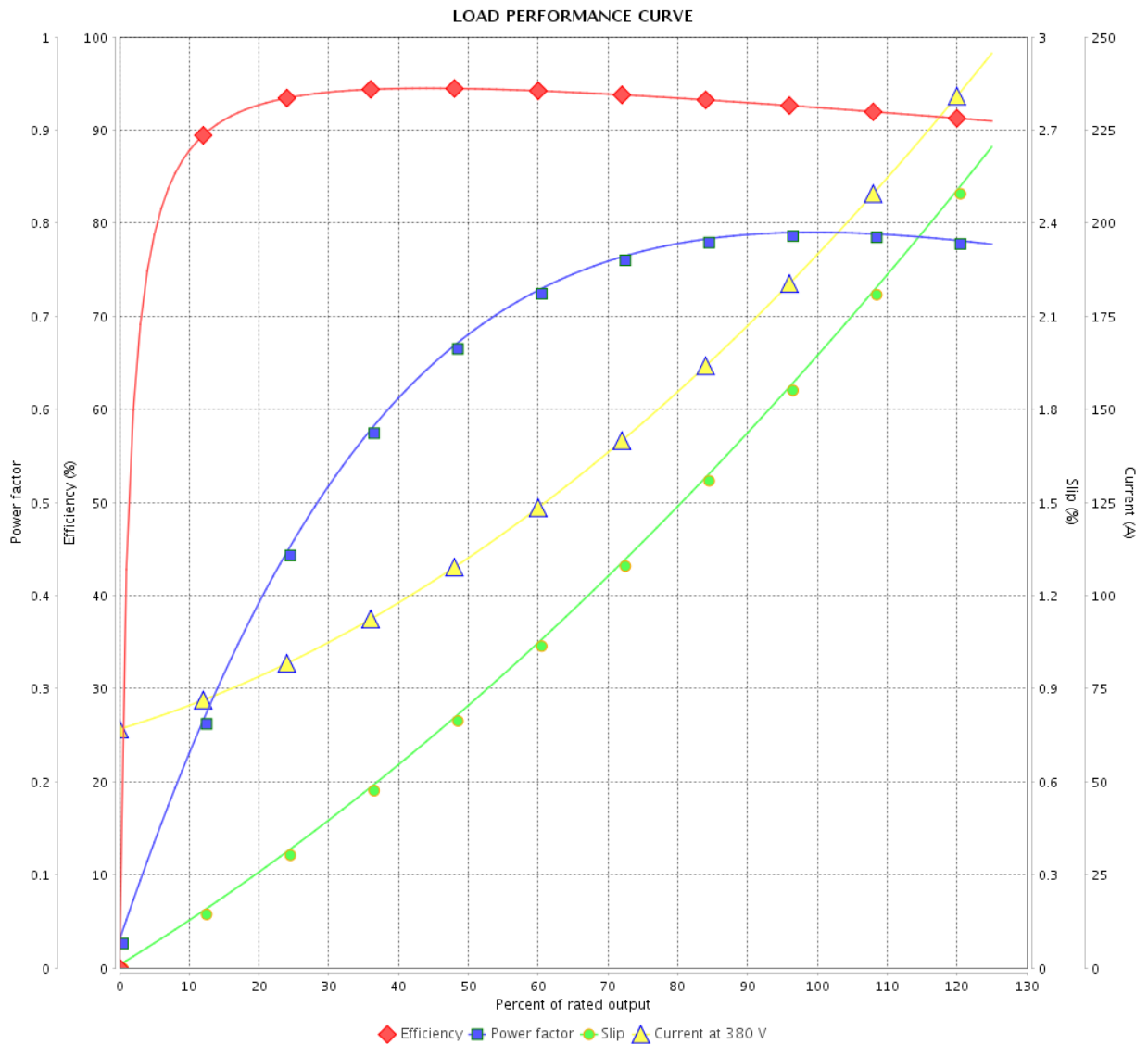

Performance : 380 V 50 Hz 8P IE2

Rated current : 187 A
 LRC : 4.7
 Rated torque : 893 ft.lb
 Locked rotor torque : 140 %
 Breakdown torque : 170 %
 Rated speed : 735 rpm

Moment of inertia (J) : 104 sq.ft.lb
 Duty cycle : Cont.(S1)
 Insulation class : F
 Service factor : 1.00
 Temperature rise : 105 K
 Design : B

| Rev. | Changes Summary | Performed | Checked | Date |
|--------------|-----------------|------------|---------|----------|
| | | | | |
| Performed by | | Page | | Revision |
| Checked by | | 13 / 36 | | |
| Date | | 14/04/2022 | | |

LOAD PERFORMANCE CURVE

Three Phase Induction Motor - Squirrel Cage



Customer :

Product line : NEMA Premium Efficiency Three-Phase

Product code : 12147620

Catalog # : 12509ST3QIE447T-W22

LOAD PERFORMANCE CURVE

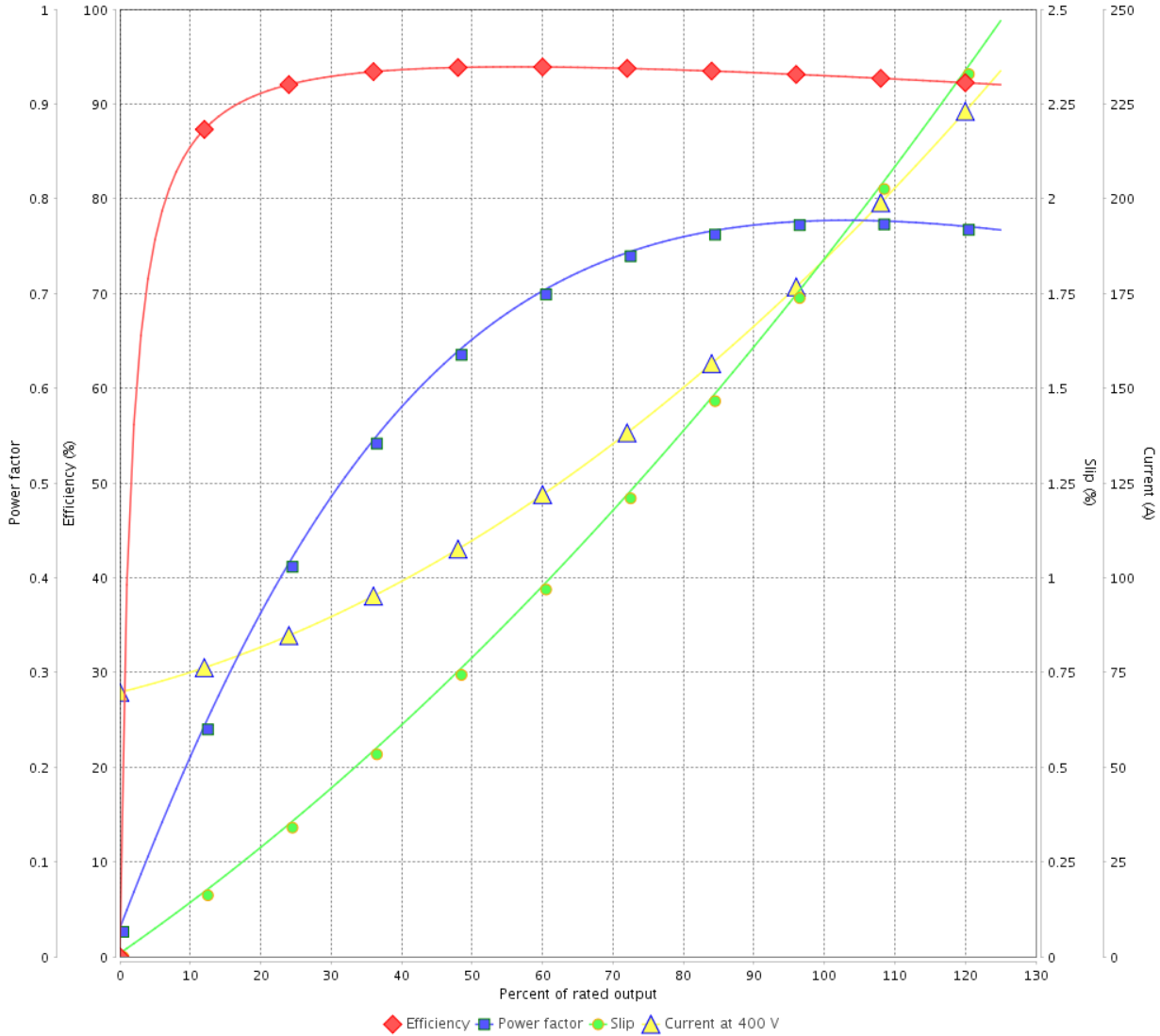

Performance : 400 V 50 Hz 8P IE2

| | | | |
|---------------------|-------------|-----------------------|----------------|
| Rated current | : 179 A | Moment of inertia (J) | : 104 sq.ft.lb |
| LRC | : 5.3 | Duty cycle | : Cont.(S1) |
| Rated torque | : 892 ft.lb | Insulation class | : F |
| Locked rotor torque | : 160 % | Service factor | : 1.00 |
| Breakdown torque | : 190 % | Temperature rise | : 105 K |
| Rated speed | : 736 rpm | Design | : B |

| Rev. | Changes Summary | Performed | Checked | Date |
|--------------|-----------------|-----------|---------|----------|
| | | | | |
| Performed by | | Page | | Revision |
| Checked by | | 14 / 36 | | |
| Date | 14/04/2022 | | | |

LOAD PERFORMANCE CURVE

Three Phase Induction Motor - Squirrel Cage



Customer :

Product line : NEMA Premium Efficiency Three-Phase

Product code : 12147620

Catalog # : 12509ST3QIE447T-W22

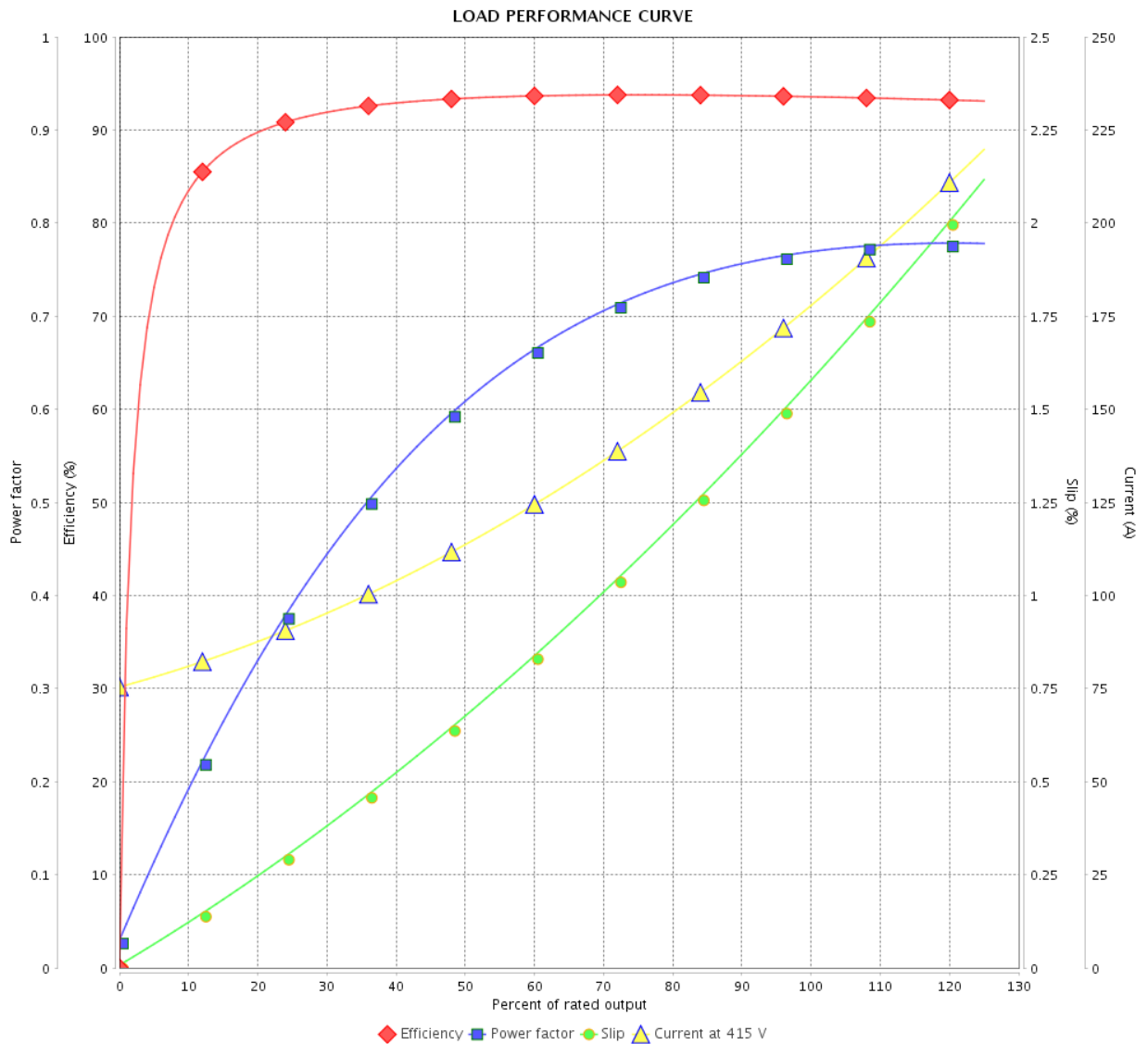

Performance : 415 V 50 Hz 8P IE3

Rated current : 174 A
 LRC : 5.7
 Rated torque : 889 ft.lb
 Locked rotor torque : 180 %
 Breakdown torque : 210 %
 Rated speed : 738 rpm

Moment of inertia (J) : 104 sq.ft.lb
 Duty cycle : Cont.(S1)
 Insulation class : F
 Service factor : 1.00
 Temperature rise : 105 K
 Design : B

| Rev. | Changes Summary | Performed | Checked | Date |
|--------------|-----------------|------------|---------|----------|
| | | | | |
| Performed by | | Page | | Revision |
| Checked by | | 15 / 36 | | |
| Date | | 14/04/2022 | | |

THERMAL LIMIT CURVE

Three Phase Induction Motor - Squirrel Cage



Customer :

Product line : NEMA Premium Efficiency Three-Phase
Product code : 12147620
Catalog # : 12509ST3QIE447T-W22

Performance : 460 V 60 Hz 8P

| | | | |
|---------------------|-------------|-----------------------|----------------|
| Rated current | : 151 A | Moment of inertia (J) | : 104 sq.ft.lb |
| LRC | : 6.0 | Duty cycle | : Cont.(S1) |
| Rated torque | : 738 ft.lb | Insulation class | : F |
| Locked rotor torque | : 180 % | Service factor | : 1.15 |
| Breakdown torque | : 210 % | Temperature rise | : 80 K |
| Rated speed | : 889 rpm | Design | : B |

Heating constant

Cooling constant

| Rev. | Changes Summary | Performed | Checked | Date |
|--------------|-----------------|-----------|---------|----------|
| | | | | |
| Performed by | | | | |
| Checked by | | | Page | Revision |
| Date | 14/04/2022 | | 16 / 36 | |

THERMAL LIMIT CURVE

Three Phase Induction Motor - Squirrel Cage



Customer : _____

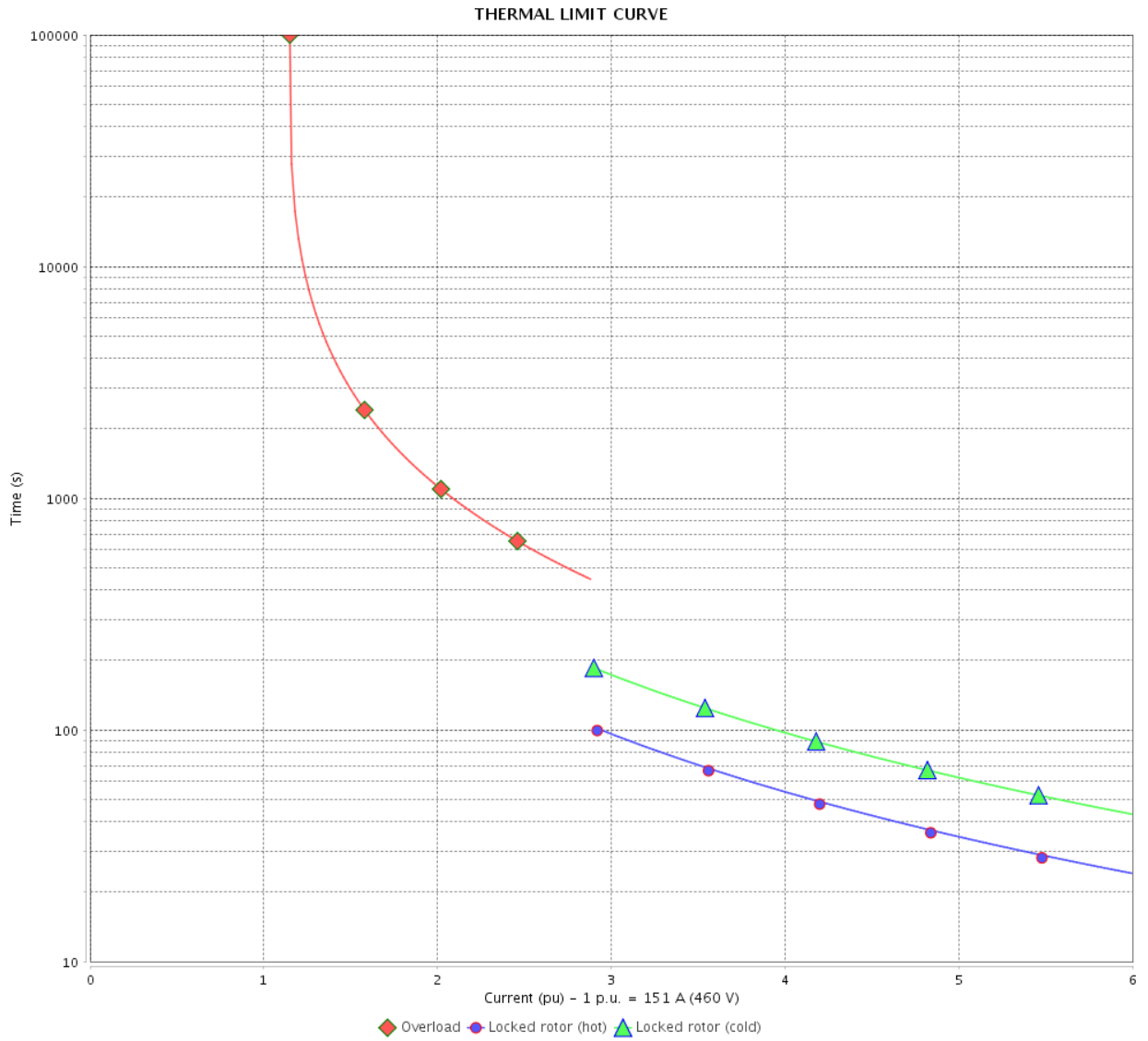

| Rev. | Changes Summary | Performed | Checked | Date |
|--------------|-----------------|-----------------|---------|----------|
| | | | | |
| Performed by | | Page 17 / 36 | | Revision |
| Checked by | | | | |
| Date | | | | |

THERMAL LIMIT CURVE

Three Phase Induction Motor - Squirrel Cage



Customer :

Product line : NEMA Premium Efficiency Three-Phase
Product code : 12147620
Catalog # : 12509ST3QIE447T-W22

Performance : 380 V 50 Hz 8P IE3

| | | | |
|---------------------|-------------|-----------------------|----------------|
| Rated current | : 156 A | Moment of inertia (J) | : 104 sq.ft.lb |
| LRC | : 5.9 | Duty cycle | : Cont.(S1) |
| Rated torque | : 711 ft.lb | Insulation class | : F |
| Locked rotor torque | : 180 % | Service factor | : 1.00 |
| Breakdown torque | : 210 % | Temperature rise | : 80 K |
| Rated speed | : 739 rpm | Design | : B |

Heating constant

Cooling constant

| Rev. | Changes Summary | Performed | Checked | Date |
|--------------|-----------------|-----------|---------|----------|
| | | | | |
| Performed by | | | | |
| Checked by | | | Page | Revision |
| Date | 14/04/2022 | | 18 / 36 | |

THERMAL LIMIT CURVE

Three Phase Induction Motor - Squirrel Cage



Customer : _____

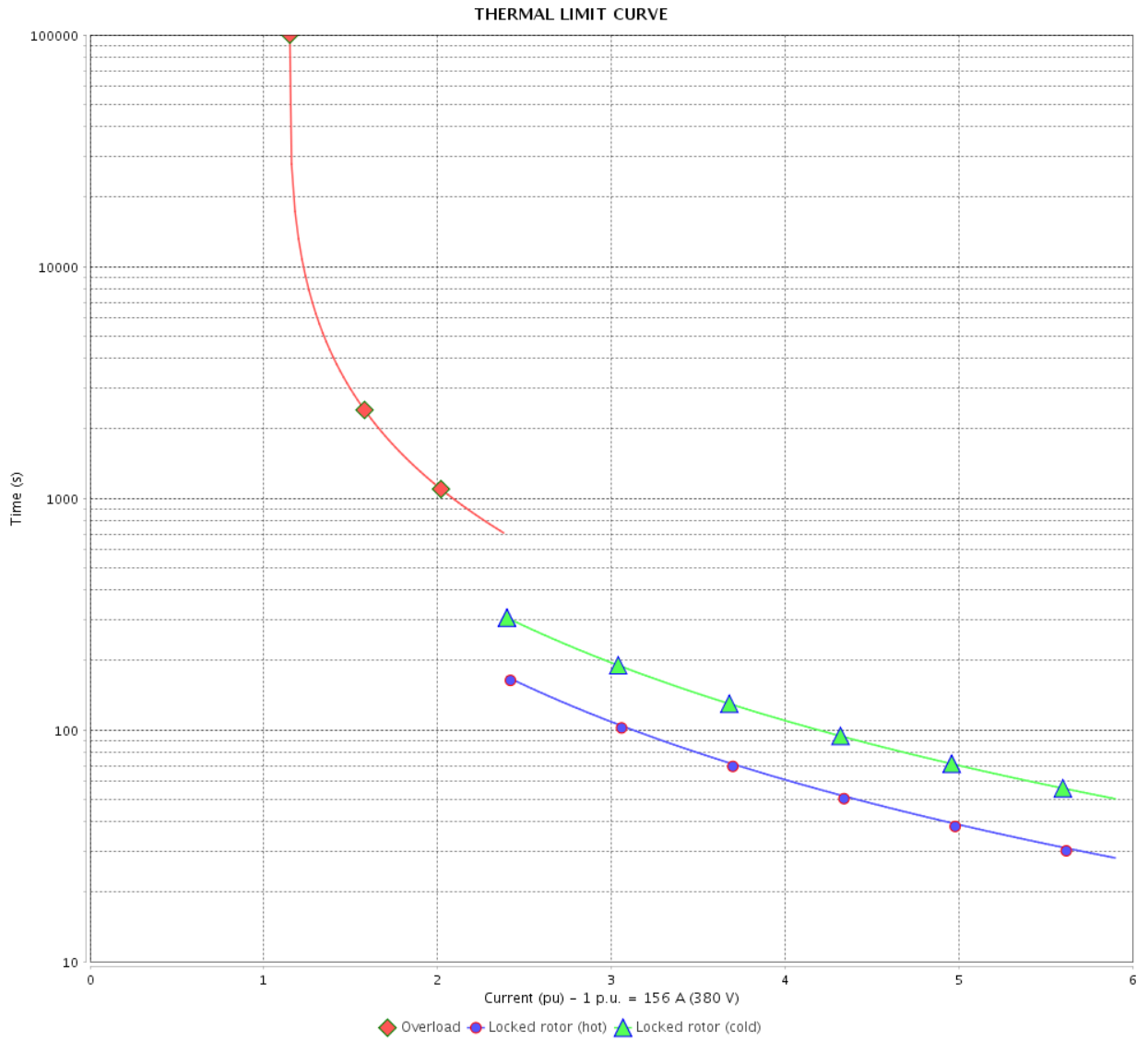

| Rev. | Changes Summary | Performed | Checked | Date |
|--------------|-----------------|-----------------|---------|----------|
| | | | | |
| Performed by | | Page 19 / 36 | | Revision |
| Checked by | | | | |
| Date | | | | |

THERMAL LIMIT CURVE



Three Phase Induction Motor - Squirrel Cage

Customer :

Product line : NEMA Premium Efficiency Three-Phase
Product code : 12147620
Catalog # : 12509ST3QIE447T-W22

Performance : 400 V 50 Hz 8P IE3

| | | | |
|---------------------|-------------|-----------------------|----------------|
| Rated current | : 152 A | Moment of inertia (J) | : 104 sq.ft.lb |
| LRC | : 6.5 | Duty cycle | : Cont.(S1) |
| Rated torque | : 710 ft.lb | Insulation class | : F |
| Locked rotor torque | : 200 % | Service factor | : 1.00 |
| Breakdown torque | : 240 % | Temperature rise | : 80 K |
| Rated speed | : 740 rpm | Design | : B |

Heating constant

Cooling constant

| Rev. | Changes Summary | Performed | Checked | Date |
|--------------|-----------------|-----------|---------|----------|
| | | | | |
| Performed by | | | | |
| Checked by | | | Page | Revision |
| Date | 14/04/2022 | | 20 / 36 | |

THERMAL LIMIT CURVE

Three Phase Induction Motor - Squirrel Cage



Customer : _____

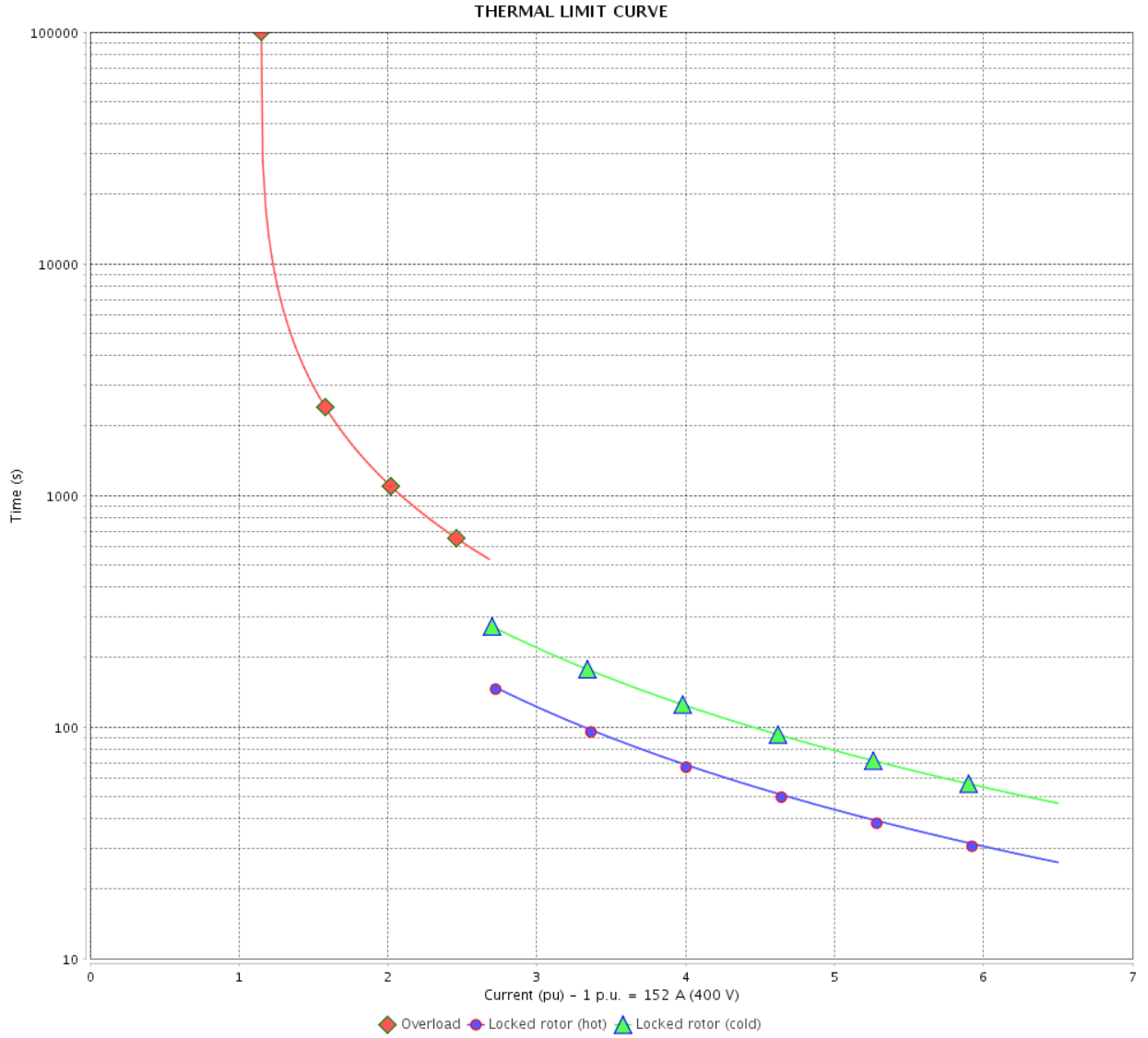

| Rev. | Changes Summary | Performed | Checked | Date |
|--------------|-----------------|------------|---------|----------|
| | | | | |
| Performed by | | Page | | Revision |
| Checked by | | 21 / 36 | | |
| Date | | 14/04/2022 | | |

THERMAL LIMIT CURVE

Three Phase Induction Motor - Squirrel Cage



Customer :

Product line : NEMA Premium Efficiency Three-Phase
Product code : 12147620
Catalog # : 12509ST3QIE447T-W22

Performance : 415 V 50 Hz 8P IE3

| | | | |
|---------------------|-------------|-----------------------|----------------|
| Rated current | : 148 A | Moment of inertia (J) | : 104 sq.ft.lb |
| LRC | : 6.8 | Duty cycle | : Cont.(S1) |
| Rated torque | : 709 ft.lb | Insulation class | : F |
| Locked rotor torque | : 229 % | Service factor | : 1.00 |
| Breakdown torque | : 260 % | Temperature rise | : 80 K |
| Rated speed | : 741 rpm | Design | : B |

Heating constant

Cooling constant

| Rev. | Changes Summary | Performed | Checked | Date |
|--------------|-----------------|-----------|---------|----------|
| | | | | |
| Performed by | | | | |
| Checked by | | | Page | Revision |
| Date | 14/04/2022 | | 22 / 36 | |

THERMAL LIMIT CURVE

Three Phase Induction Motor - Squirrel Cage



Customer : _____

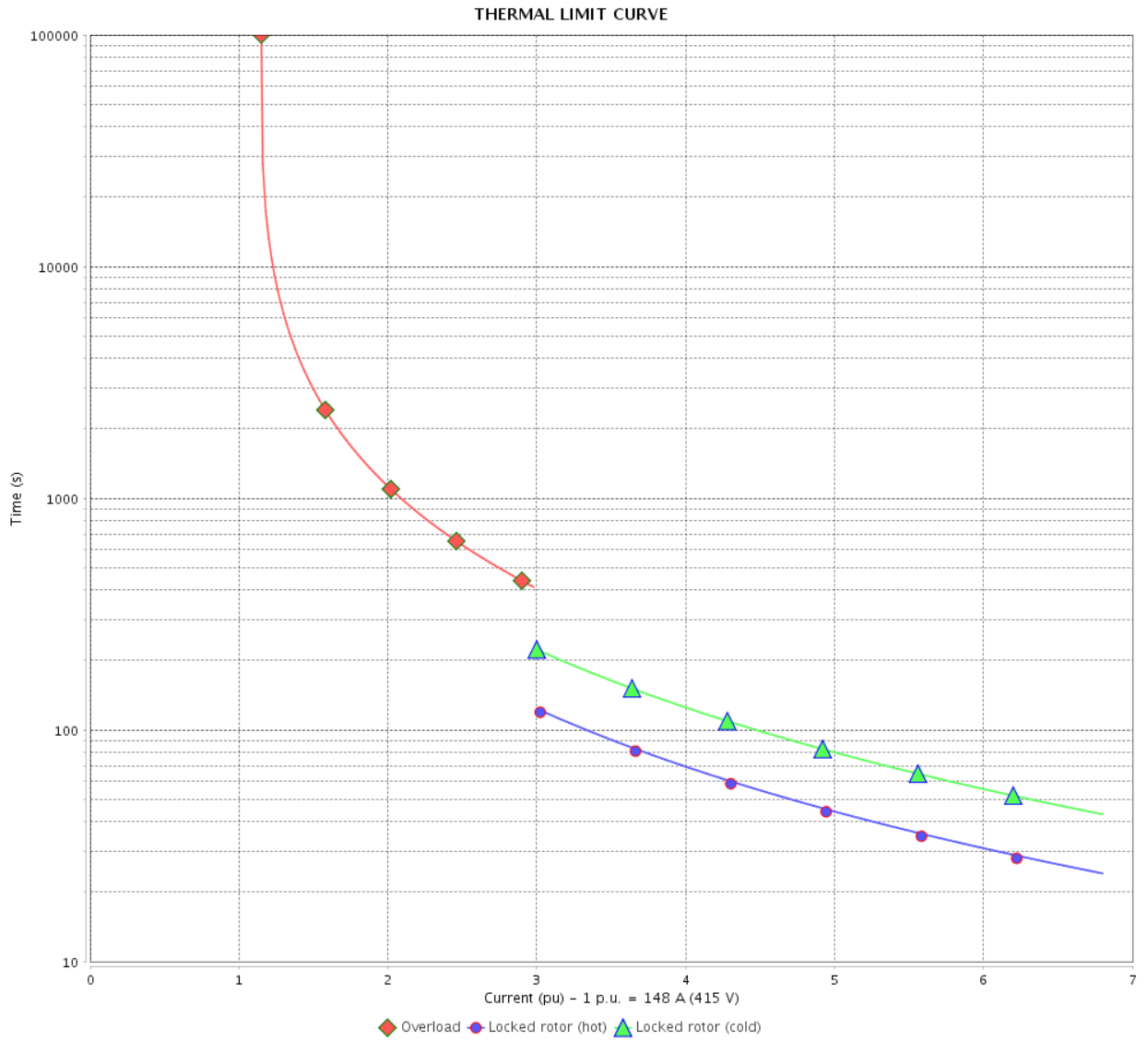

| Rev. | Changes Summary | Performed | Checked | Date |
|--------------|-----------------|-----------------|---------|----------|
| | | | | |
| Performed by | | Page 23 / 36 | | Revision |
| Checked by | | | | |
| Date | | | | |

THERMAL LIMIT CURVE

Three Phase Induction Motor - Squirrel Cage



Customer :

Product line : NEMA Premium Efficiency Three-Phase
Product code : 12147620
Catalog # : 12509ST3QIE447T-W22

Performance : 380 V 50 Hz 8P IE2

| | | | |
|---------------------|-------------|-----------------------|----------------|
| Rated current | : 187 A | Moment of inertia (J) | : 104 sq.ft.lb |
| LRC | : 4.7 | Duty cycle | : Cont.(S1) |
| Rated torque | : 893 ft.lb | Insulation class | : F |
| Locked rotor torque | : 140 % | Service factor | : 1.00 |
| Breakdown torque | : 170 % | Temperature rise | : 105 K |
| Rated speed | : 735 rpm | Design | : B |

Heating constant

Cooling constant

| Rev. | Changes Summary | Performed | Checked | Date |
|--------------|-----------------|-----------|---------|----------|
| | | | | |
| Performed by | | | | |
| Checked by | | | Page | Revision |
| Date | 14/04/2022 | | 24 / 36 | |

THERMAL LIMIT CURVE

Three Phase Induction Motor - Squirrel Cage



Customer : _____

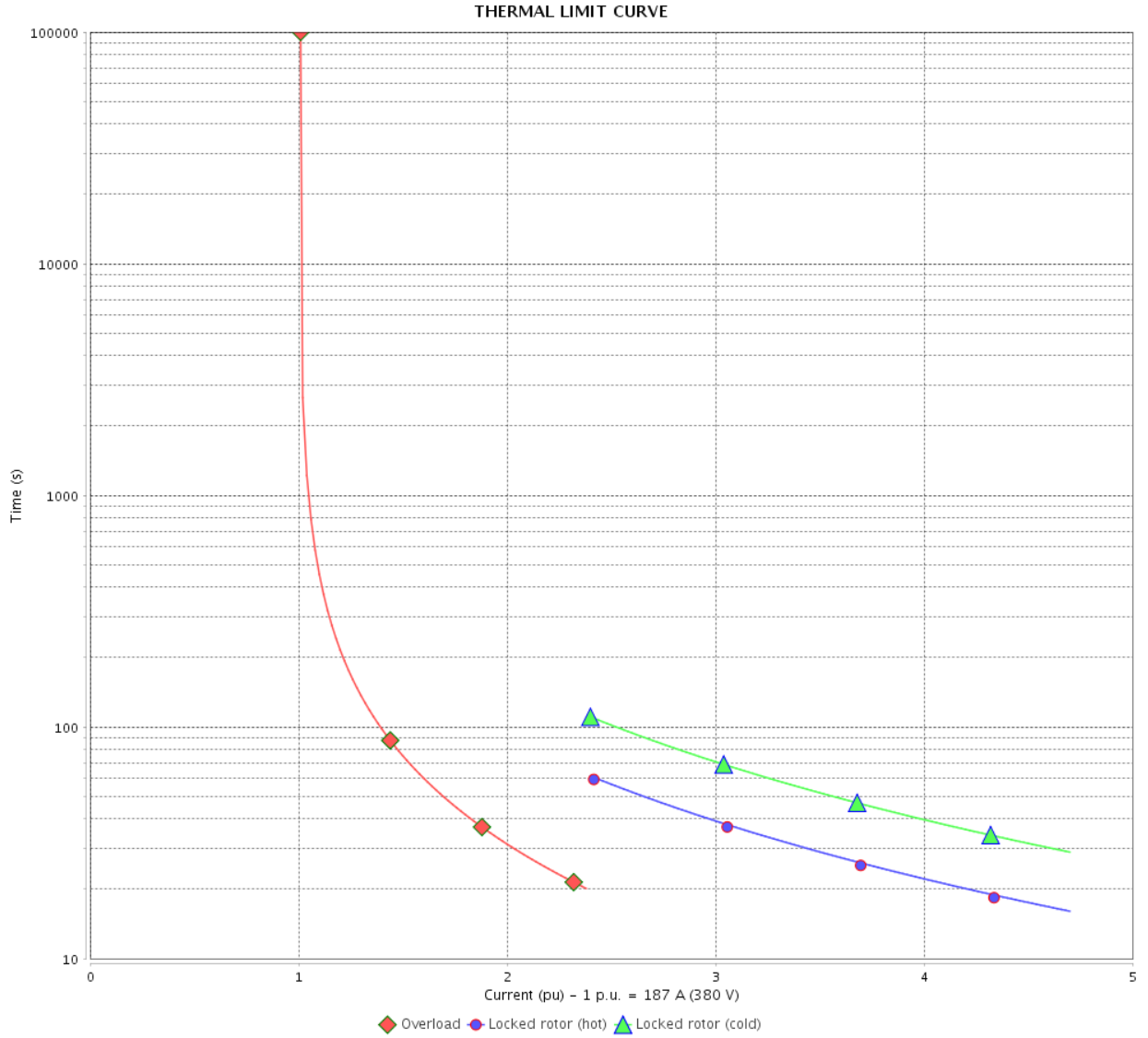

| Rev. | Changes Summary | Performed | Checked | Date |
|--------------|-----------------|-----------|---------|----------|
| | | | | |
| Performed by | | | | |
| Checked by | | | | |
| Date | | | | |
| | | | Page | Revision |
| | | | 25 / 36 | |

THERMAL LIMIT CURVE

Three Phase Induction Motor - Squirrel Cage



Customer :

Product line : NEMA Premium Efficiency Three-Phase
Product code : 12147620
Catalog # : 12509ST3QIE447T-W22

Performance : 400 V 50 Hz 8P IE2

| | | | |
|---------------------|-------------|-----------------------|----------------|
| Rated current | : 179 A | Moment of inertia (J) | : 104 sq.ft.lb |
| LRC | : 5.3 | Duty cycle | : Cont.(S1) |
| Rated torque | : 892 ft.lb | Insulation class | : F |
| Locked rotor torque | : 160 % | Service factor | : 1.00 |
| Breakdown torque | : 190 % | Temperature rise | : 105 K |
| Rated speed | : 736 rpm | Design | : B |

Heating constant

Cooling constant

| Rev. | Changes Summary | Performed | Checked | Date |
|--------------|-----------------|-----------|---------|----------|
| Performed by | | | | |
| Checked by | | | Page | Revision |
| Date | 14/04/2022 | | 26 / 36 | |

THERMAL LIMIT CURVE

Three Phase Induction Motor - Squirrel Cage



Customer : _____

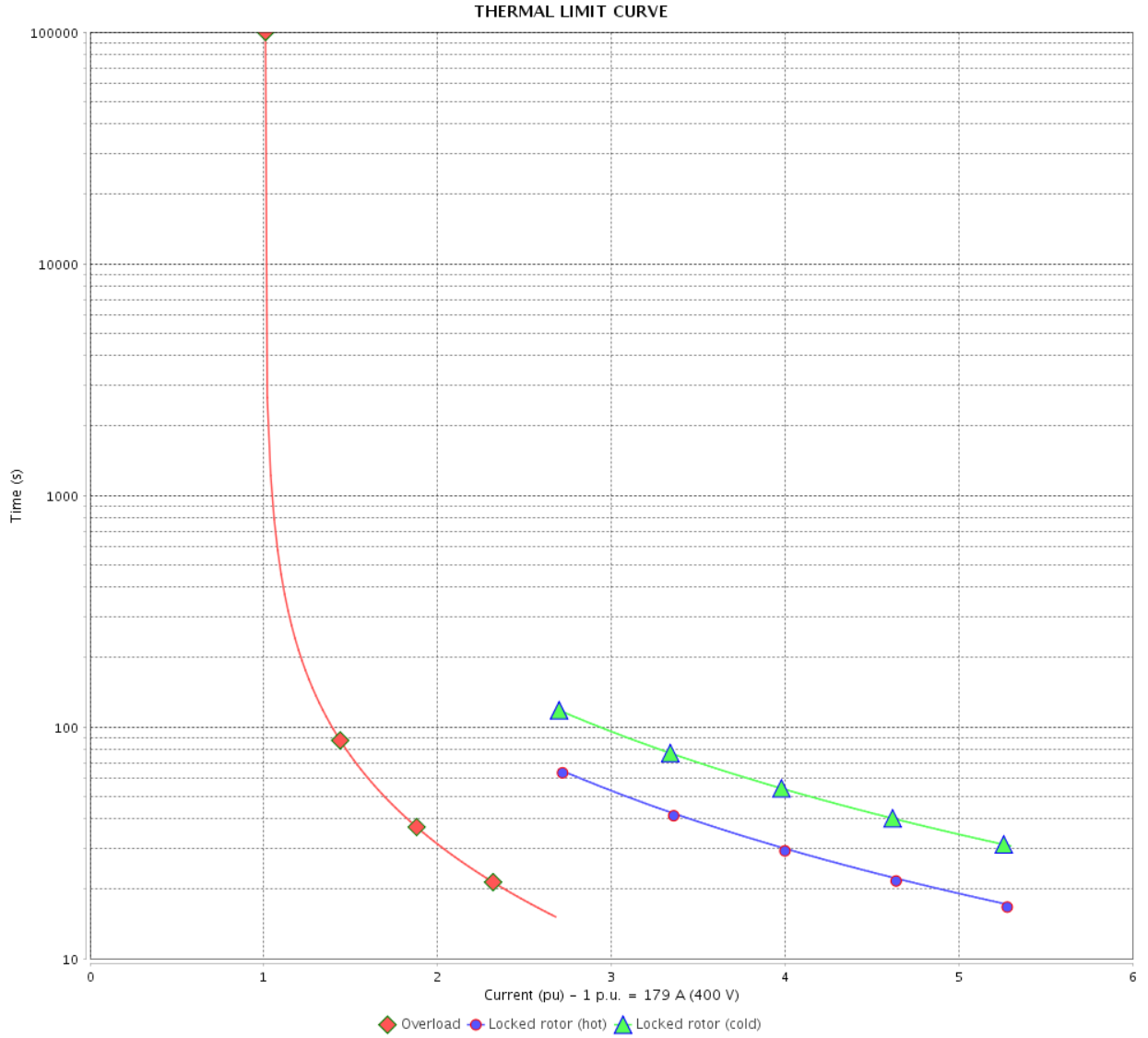

| Rev. | Changes Summary | Performed | Checked | Date |
|--------------|-----------------|-----------------|---------|----------|
| | | | | |
| Performed by | | Page 27 / 36 | | Revision |
| Checked by | | | | |
| Date | | | | |

THERMAL LIMIT CURVE

Three Phase Induction Motor - Squirrel Cage



Customer :

Product line : NEMA Premium Efficiency Three-Phase
Product code : 12147620
Catalog # : 12509ST3QIE447T-W22

Performance : 415 V 50 Hz 8P IE3

| | | | |
|---------------------|-------------|-----------------------|----------------|
| Rated current | : 174 A | Moment of inertia (J) | : 104 sq.ft.lb |
| LRC | : 5.7 | Duty cycle | : Cont.(S1) |
| Rated torque | : 889 ft.lb | Insulation class | : F |
| Locked rotor torque | : 180 % | Service factor | : 1.00 |
| Breakdown torque | : 210 % | Temperature rise | : 105 K |
| Rated speed | : 738 rpm | Design | : B |

Heating constant

Cooling constant

| Rev. | Changes Summary | Performed | Checked | Date |
|--------------|-----------------|-----------|---------|----------|
| | | | | |
| Performed by | | | | |
| Checked by | | | Page | Revision |
| Date | 14/04/2022 | | 28 / 36 | |

THERMAL LIMIT CURVE

Three Phase Induction Motor - Squirrel Cage



Customer : _____

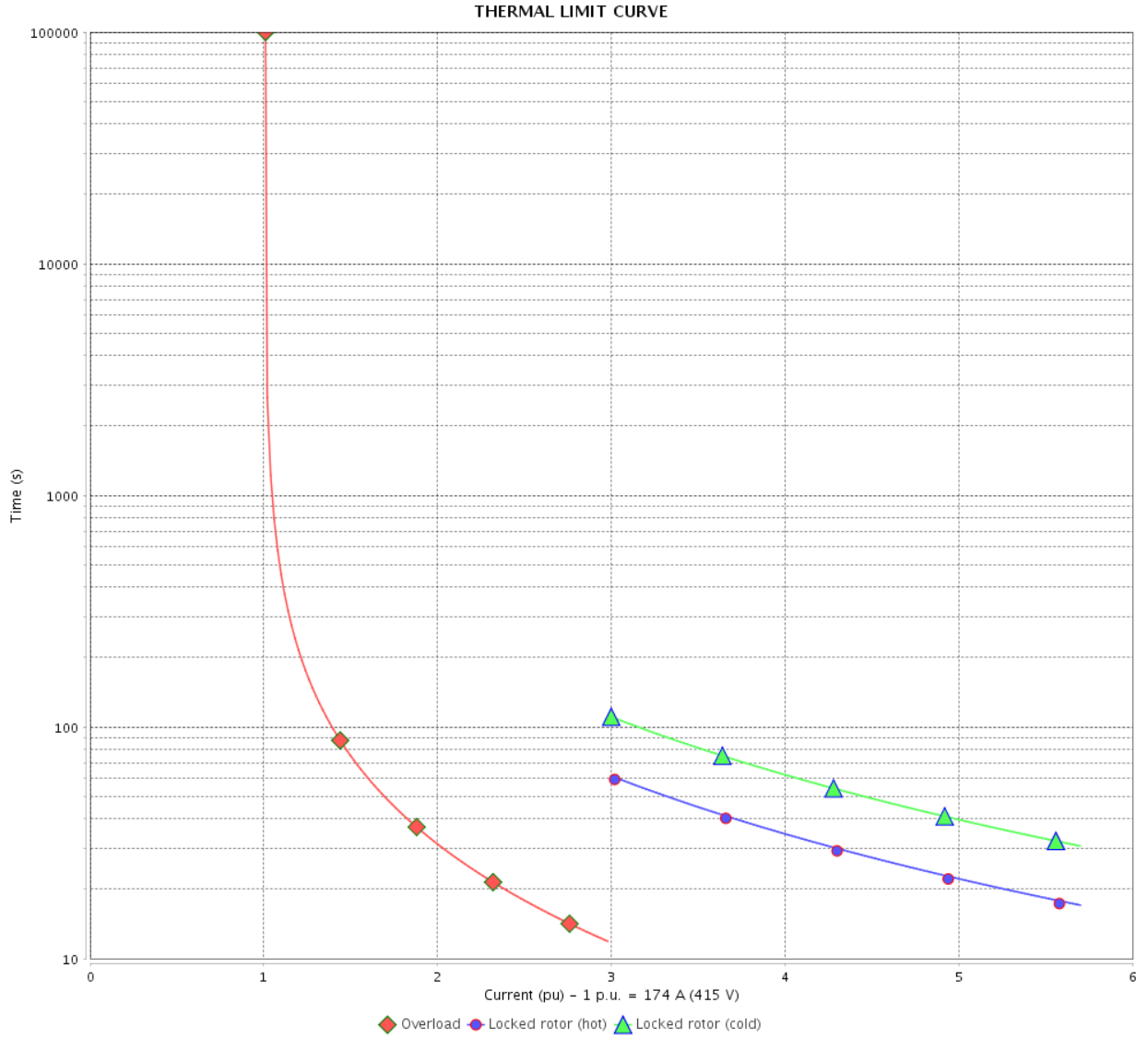

| Rev. | Changes Summary | Performed | Checked | Date |
|--------------|-----------------|-----------------|----------|------|
| | | | | |
| Performed by | | | | |
| Checked by | | | | |
| Date | | | | |
| | | Page 29 / 36 | Revision | |

VFD OPERATION CURVE

Three Phase Induction Motor - Squirrel Cage



Customer :

Product line : NEMA Premium Efficiency Three-Phase

Product code : 12147620

Catalog # : 12509ST3QIE447T-W22

VFD OPERATION CURVE

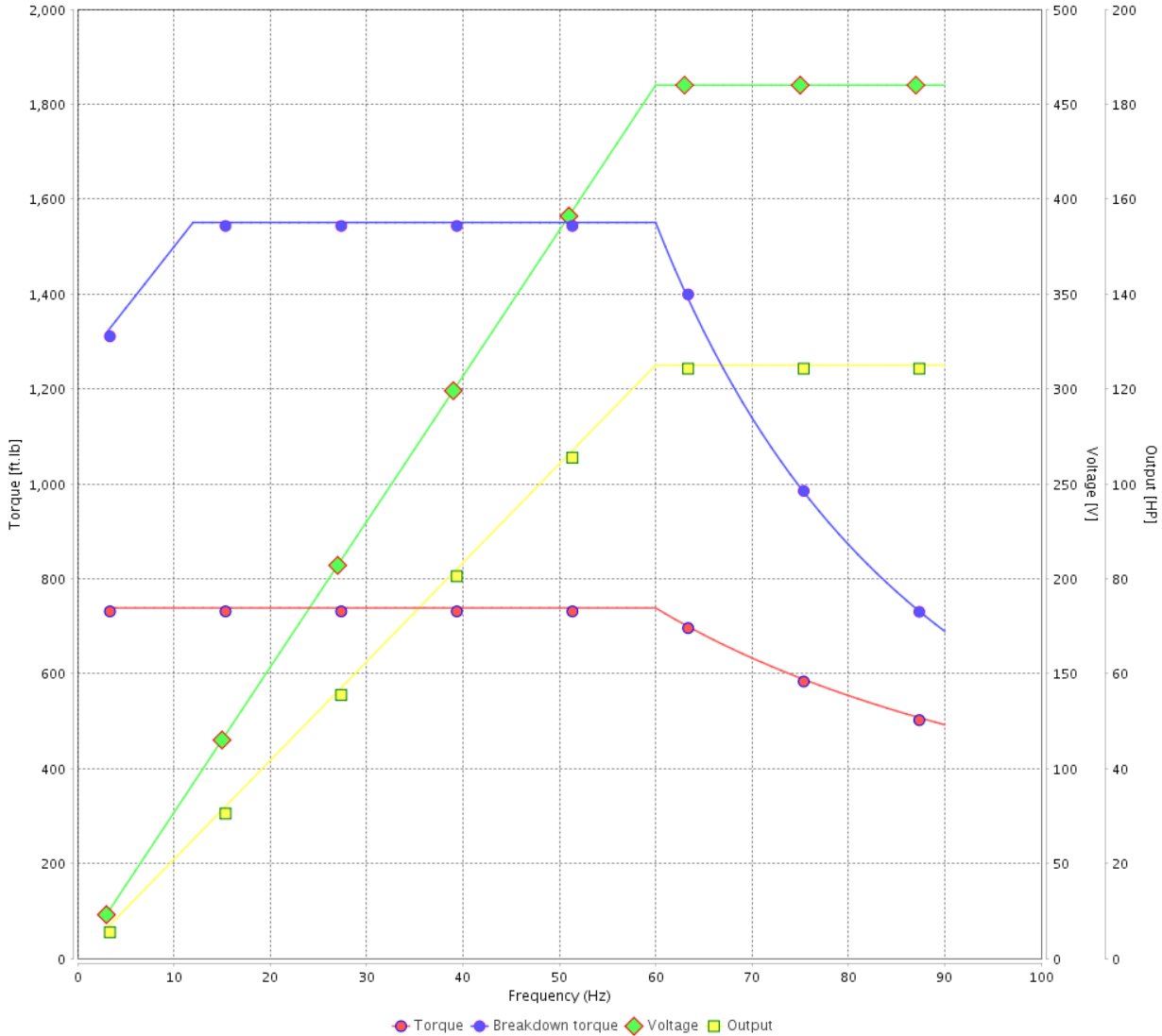

Performance : 460 V 60 Hz 8P

| | | | |
|---------------------|-------------|-----------------------|----------------|
| Rated current | : 151 A | Moment of inertia (J) | : 104 sq.ft.lb |
| LRC | : 6.0 | Duty cycle | : Cont.(S1) |
| Rated torque | : 738 ft.lb | Insulation class | : F |
| Locked rotor torque | : 180 % | Service factor | : 1.15 |
| Breakdown torque | : 210 % | Temperature rise | : 80 K |
| Rated speed | : 889 rpm | Design | : B |

| Rev. | Changes Summary | Performed | Checked | Date |
|--------------|-----------------|-----------|---------|----------|
| | | | | |
| Performed by | | Page | | Revision |
| Checked by | | 30 / 36 | | |
| Date | 14/04/2022 | | | |

VFD OPERATION CURVE

Three Phase Induction Motor - Squirrel Cage



Customer :

Product line : NEMA Premium Efficiency Three-Phase

Product code : 12147620

Catalog # : 12509ST3QIE447T-W22

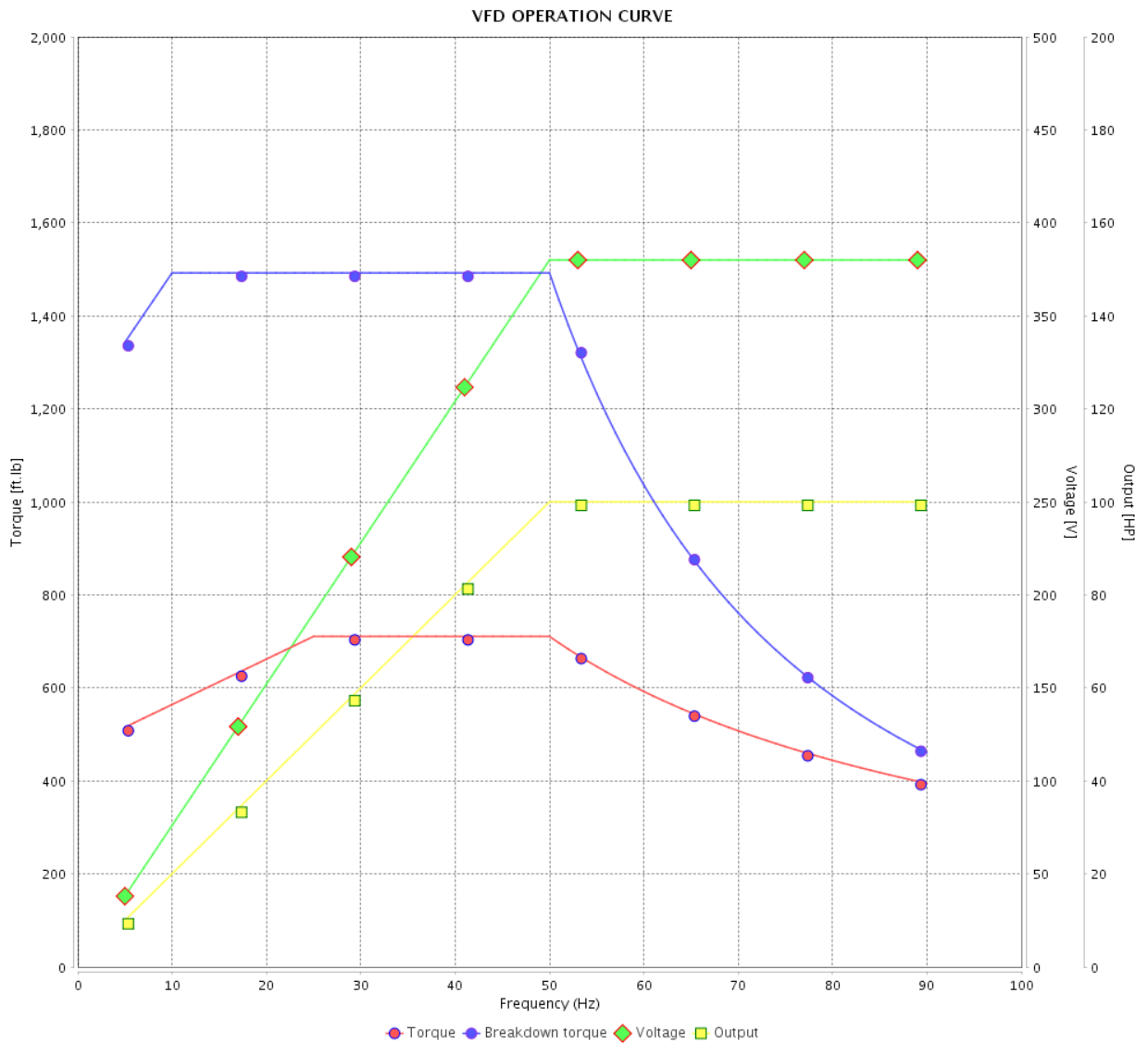

Performance : 380 V 50 Hz 8P IE3

Rated current : 156 A
 LRC : 5.9
 Rated torque : 711 ft.lb
 Locked rotor torque : 180 %
 Breakdown torque : 210 %
 Rated speed : 739 rpm

Moment of inertia (J) : 104 sq.ft.lb
 Duty cycle : Cont.(S1)
 Insulation class : F
 Service factor : 1.00
 Temperature rise : 80 K
 Design : B

| Rev. | Changes Summary | Performed | Checked | Date |
|--------------|-----------------|-----------|---------|----------|
| | | | | |
| Performed by | | Page | | Revision |
| Checked by | | 31 / 36 | | |
| Date | 14/04/2022 | | | |

VFD OPERATION CURVE

Three Phase Induction Motor - Squirrel Cage



Customer : _____

Product line : NEMA Premium Efficiency Three-Phase

Product code : 12147620

Catalog # : 12509ST3QIE447T-W22

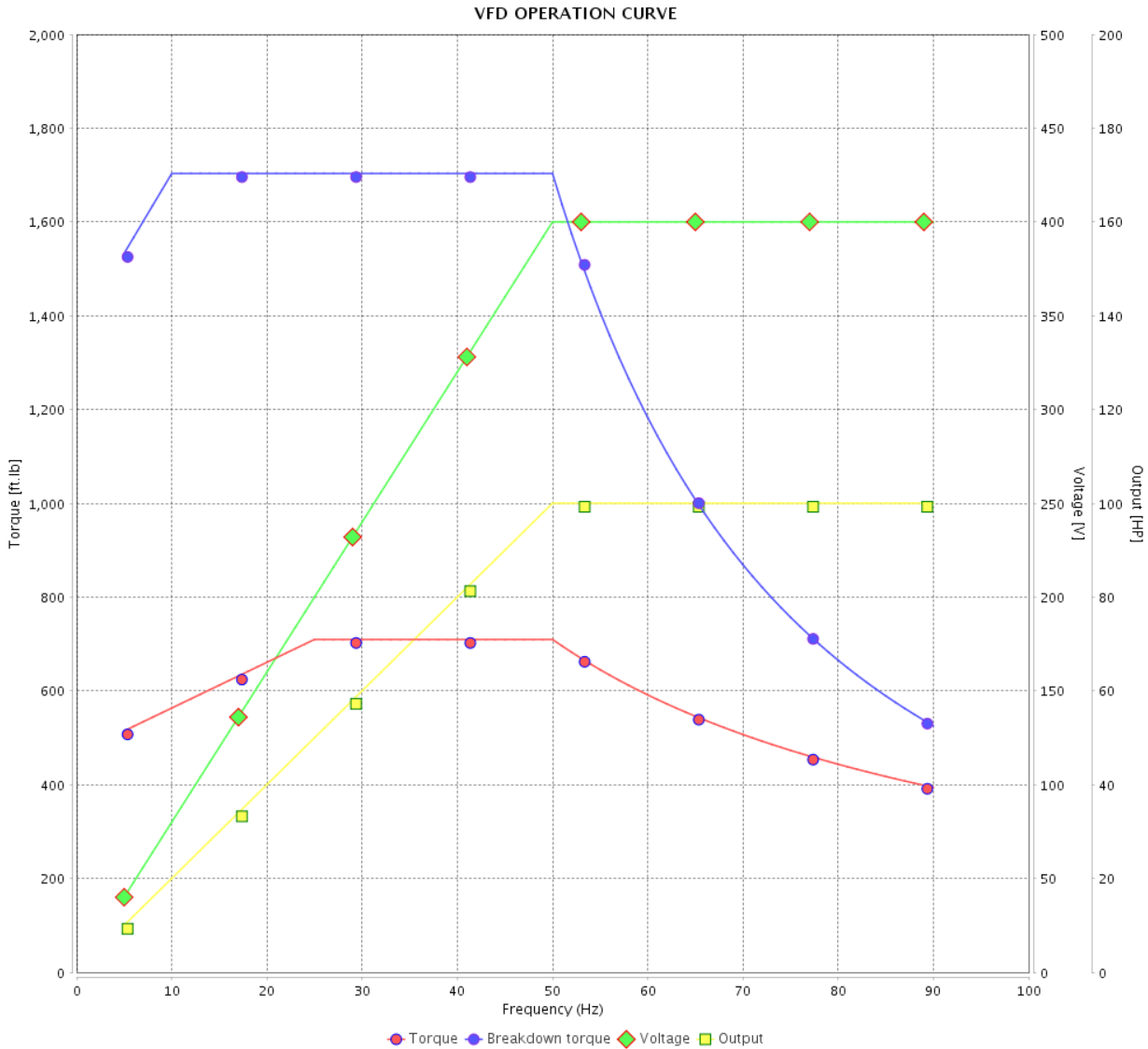

Performance : 400 V 50 Hz 8P IE3

Rated current : 152 A
 LRC : 6.5
 Rated torque : 710 ft.lb
 Locked rotor torque : 200 %
 Breakdown torque : 240 %
 Rated speed : 740 rpm

Moment of inertia (J) : 104 sq.ft.lb
 Duty cycle : Cont.(S1)
 Insulation class : F
 Service factor : 1.00
 Temperature rise : 80 K
 Design : B

| Rev. | Changes Summary | Performed | Checked | Date |
|--------------|-----------------|-----------|-----------------|----------|
| | | | | |
| Performed by | | | Page 32 / 36 | Revision |
| Checked by | | | | |
| Date | 14/04/2022 | | | |

VFD OPERATION CURVE

Three Phase Induction Motor - Squirrel Cage



Customer : _____

Product line : NEMA Premium Efficiency Three-Phase

Product code : 12147620

Catalog # : 12509ST3QIE447T-W22

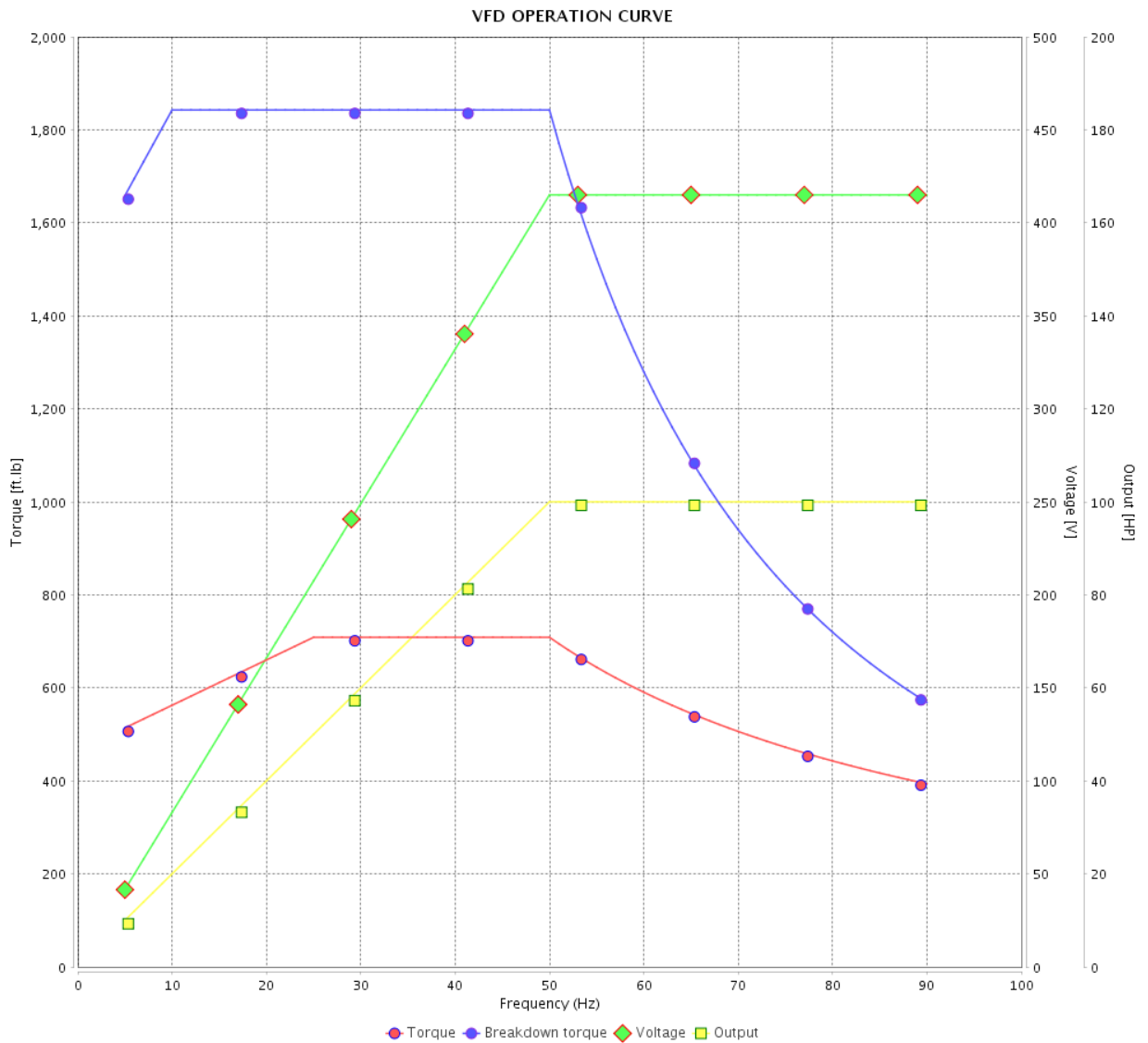

Performance : 415 V 50 Hz 8P IE3

Rated current : 148 A
 LRC : 6.8
 Rated torque : 709 ft.lb
 Locked rotor torque : 229 %
 Breakdown torque : 260 %
 Rated speed : 741 rpm

Moment of inertia (J) : 104 sq.ft.lb
 Duty cycle : Cont.(S1)
 Insulation class : F
 Service factor : 1.00
 Temperature rise : 80 K
 Design : B

| Rev. | Changes Summary | Performed | Checked | Date |
|--------------|-----------------|-----------|---------|----------|
| | | | | |
| Performed by | | Page | | Revision |
| Checked by | | 33 / 36 | | |
| Date | 14/04/2022 | | | |

VFD OPERATION CURVE

Three Phase Induction Motor - Squirrel Cage



Customer :

Product line : NEMA Premium Efficiency Three-Phase

Product code : 12147620

Catalog # : 12509ST3QIE447T-W22

VFD OPERATION CURVE

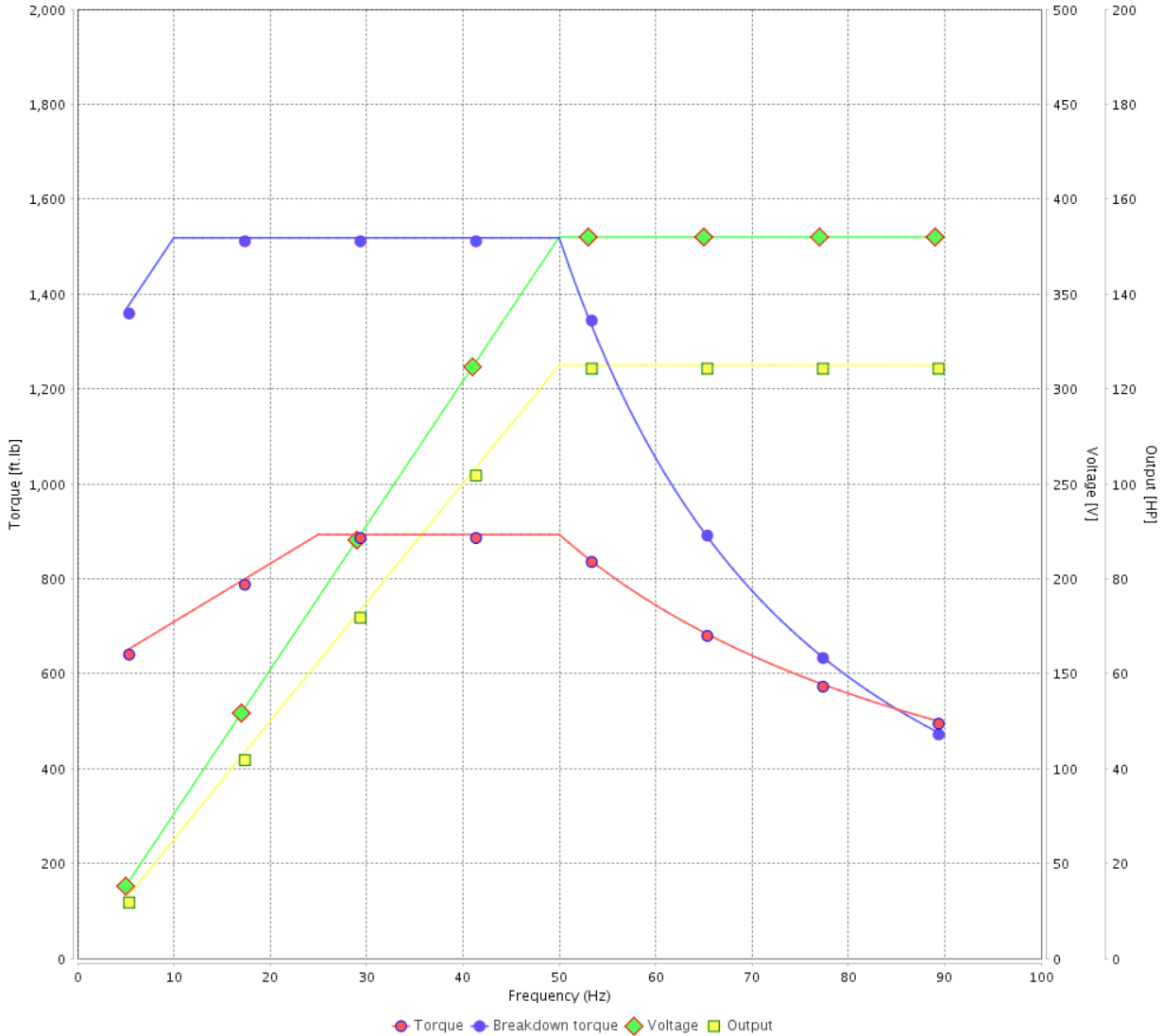

Performance : 380 V 50 Hz 8P IE2

| | | | |
|---------------------|-------------|-----------------------|----------------|
| Rated current | : 187 A | Moment of inertia (J) | : 104 sq.ft.lb |
| LRC | : 4.7 | Duty cycle | : Cont.(S1) |
| Rated torque | : 893 ft.lb | Insulation class | : F |
| Locked rotor torque | : 140 % | Service factor | : 1.00 |
| Breakdown torque | : 170 % | Temperature rise | : 105 K |
| Rated speed | : 735 rpm | Design | : B |

| Rev. | Changes Summary | Performed | Checked | Date |
|--------------|-----------------|-----------|---------|----------|
| | | | | |
| Performed by | | | Page | Revision |
| Checked by | | | 34 / 36 | |
| Date | 14/04/2022 | | | |

VFD OPERATION CURVE

Three Phase Induction Motor - Squirrel Cage



Customer : _____

Product line : NEMA Premium Efficiency Three-Phase

Product code : 12147620

Catalog # : 12509ST3QIE447T-W22

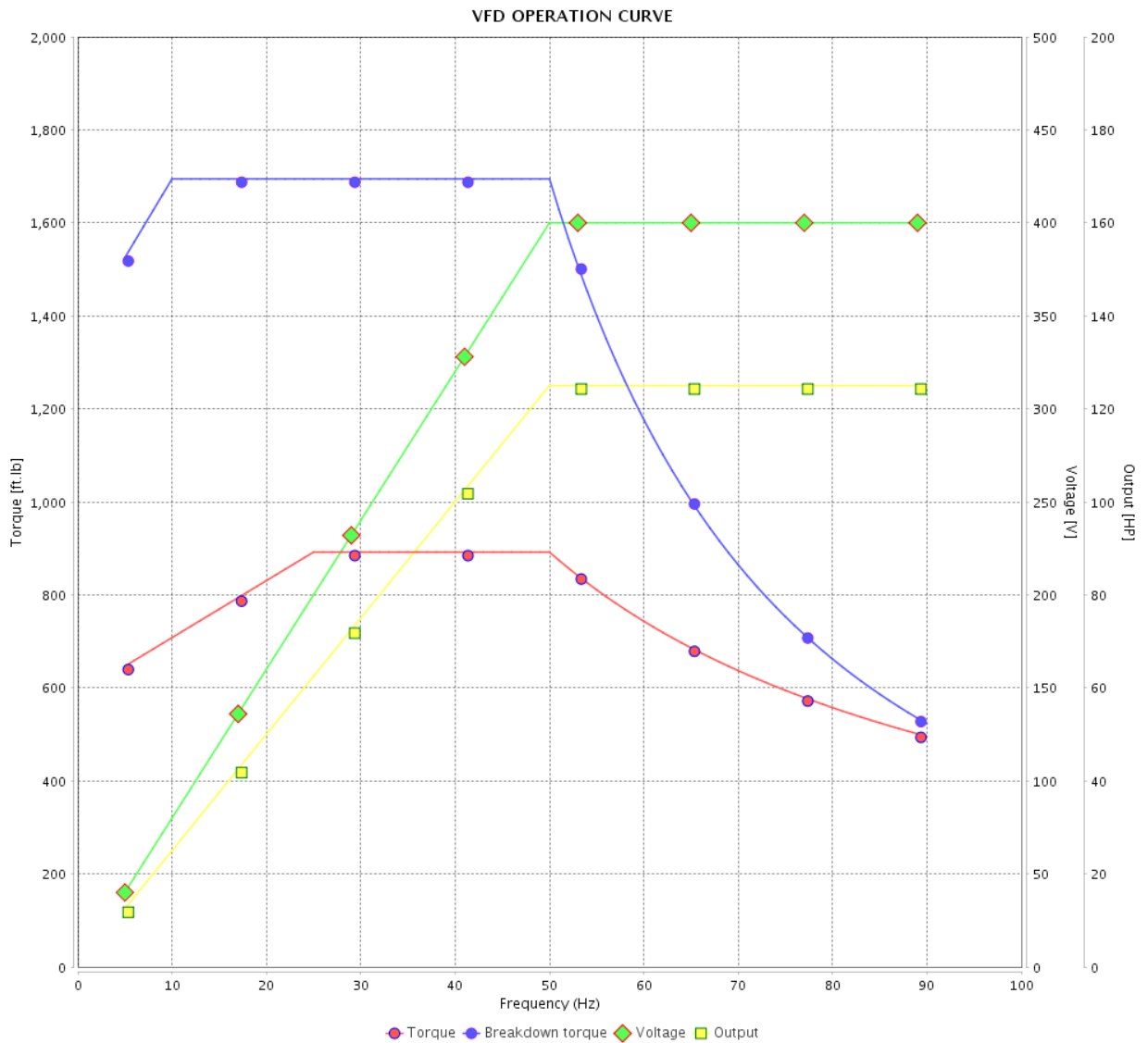

Performance : 400 V 50 Hz 8P IE2

Rated current : 179 A
 LRC : 5.3
 Rated torque : 892 ft.lb
 Locked rotor torque : 160 %
 Breakdown torque : 190 %
 Rated speed : 736 rpm

Moment of inertia (J) : 104 sq.ft.lb
 Duty cycle : Cont.(S1)
 Insulation class : F
 Service factor : 1.00
 Temperature rise : 105 K
 Design : B

| Rev. | Changes Summary | Performed | Checked | Date |
|--------------|-----------------|------------|---------|----------|
| | | | | |
| Performed by | | Page | | Revision |
| Checked by | | 35 / 36 | | |
| Date | | 14/04/2022 | | |

VFD OPERATION CURVE

Three Phase Induction Motor - Squirrel Cage



Customer :

Product line : NEMA Premium Efficiency Three-Phase

Product code : 12147620

Catalog # : 12509ST3QIE447T-W22

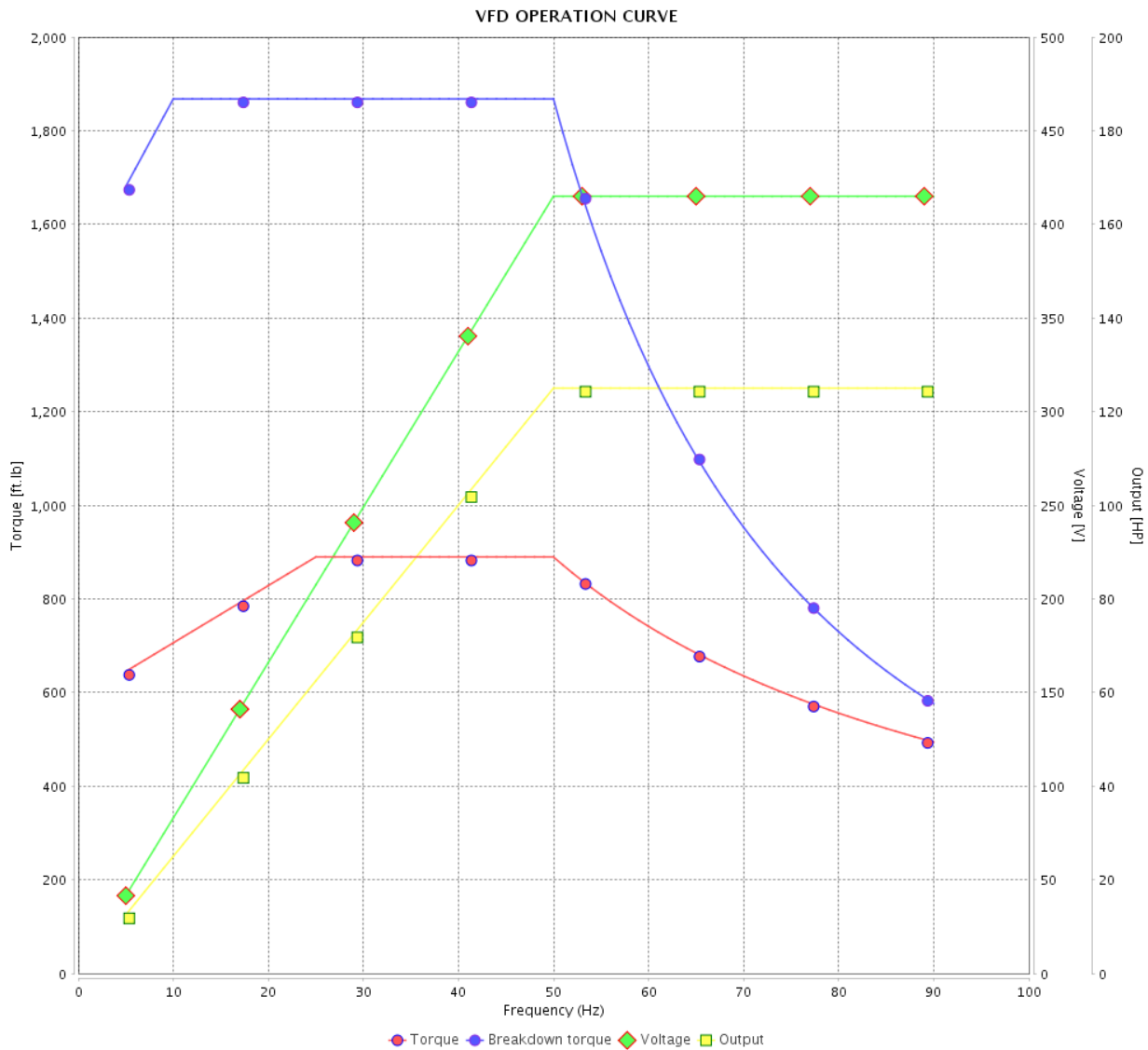

Performance : 415 V 50 Hz 8P IE3

| | | | |
|---------------------|-------------|-----------------------|----------------|
| Rated current | : 174 A | Moment of inertia (J) | : 104 sq.ft.lb |
| LRC | : 5.7 | Duty cycle | : Cont.(S1) |
| Rated torque | : 889 ft.lb | Insulation class | : F |
| Locked rotor torque | : 180 % | Service factor | : 1.00 |
| Breakdown torque | : 210 % | Temperature rise | : 105 K |
| Rated speed | : 738 rpm | Design | : B |

| Rev. | Changes Summary | Performed | Checked | Date |
|--------------|-----------------|-----------|-----------------|----------|
| | | | | |
| Performed by | | | Page 36 / 36 | Revision |
| Checked by | | | | |
| Date | 14/04/2022 | | | |

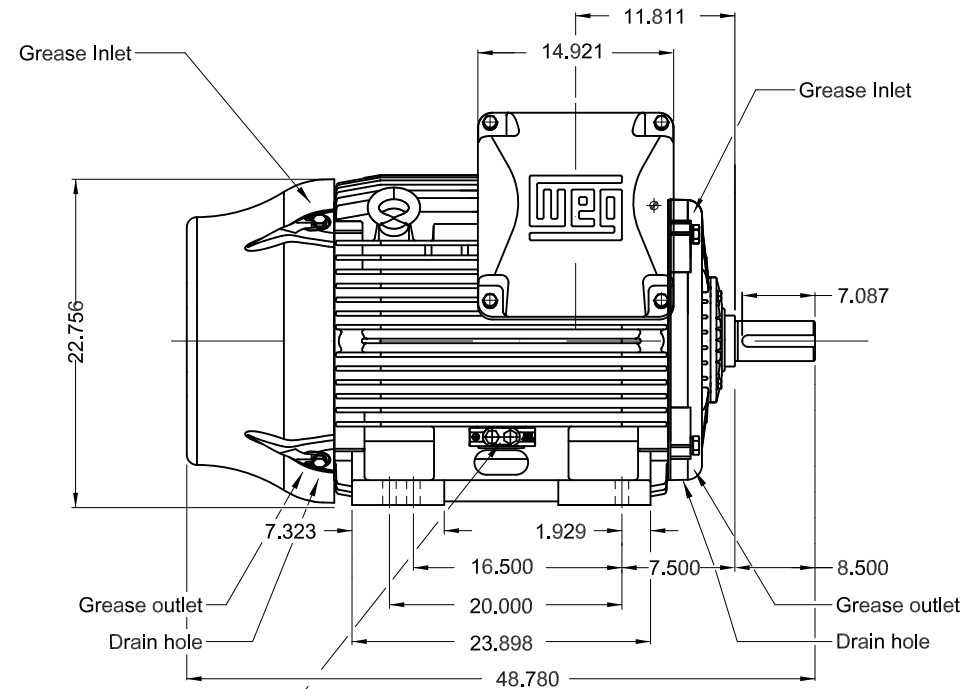
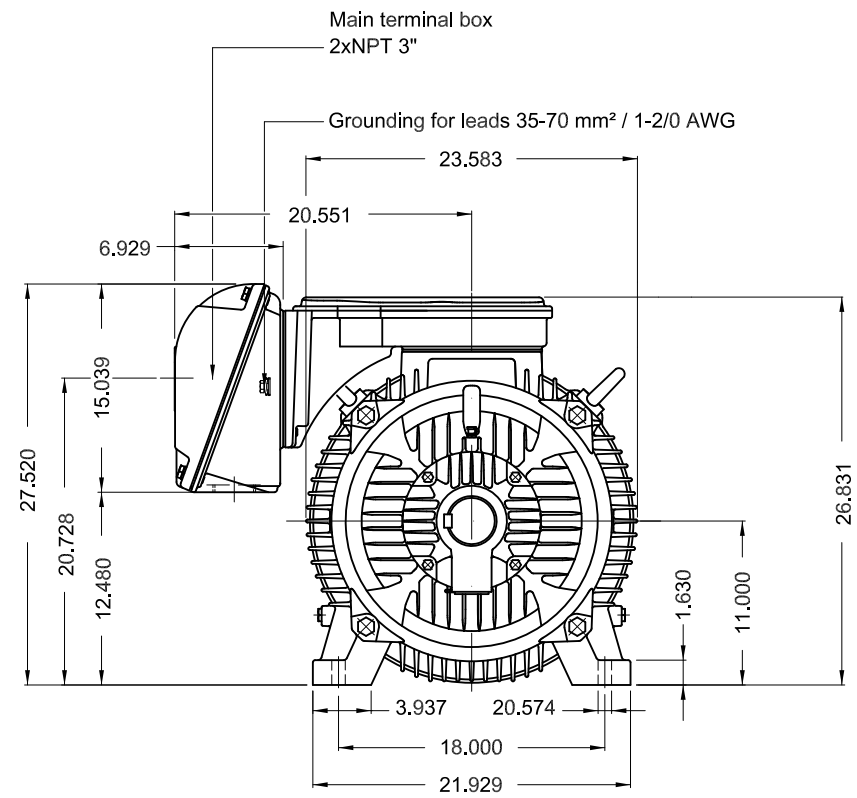

Grounding for leads 25-185 mm² / 3AWG-350MCM

Color RAL 5009
 Painting plan 202E
 Mounting B3R(D)

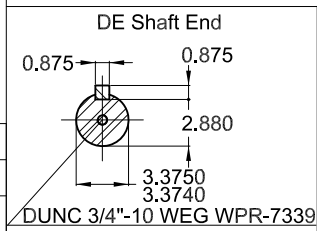

125 HP 08 Poles 60 Hz

A

| ECM | LOC | SUMMARY OF MODIFICATIONS | EXECUTED | CHECKED | RELEASED | DATE | VER |
|----------|----------|---|---------------------|---------|----------|------|-----|
| EXECUTED | PIRWUSER | THREE PH. MOTOR IEEE 841 W22 PREM. EFF. | | | | | |
| CHECKED | | FRAME 445/7T IP55 TEFC | | | | | |
| RELEASED | | | | | | | |
| REL DT. | WMO | Jaragua do Sul | Product Engineering | | | | |

PREVIEW
 WDD



SHEET 1 / 1

Dimensions in inches

XME A3