

DATA SHEET

Three Phase Induction Motor - Squirrel Cage



Customer							
Product line	: NEMA Premium Efficiency Three-Phase	Product code	: 13273169				
		Catalog #	: 12518ET3E444T-W22G				
Frame	: 444/5T	Cooling method	: IC411 - TEFC				
Insulation class	: F	Mounting	: F-1				
Duty cycle	: Cont.(S1)	Rotation ¹	: Both (CW and CCW)				
Ambient temperature	: -20°C to +40°C	Starting method	: Direct On Line				
Altitude	: 1000 m.a.s.l.	Approx. weight ²	: 1648 lb				
Protection degree	: IP55	Moment of inertia (J)	: 57.2 sq.ft.lb				
Design	: B						
Output [HP]	125	100	100	100	125	125	125
Poles	4	4	4	4	4	4	4
Frequency [Hz]	60	50	50	50	50	50	50
Rated voltage [V]	230/460	380	400	415	380	400	415
Rated current [A]	278/139	139	136	132	168	160	155
L. R. Amperes [A]	1807/904	890	952	1003	857	912	961
LRC [A]	6.5x(Code G)	6.4x(Code G)	7.0x(Code H)	7.6x(Code J)	5.1x(Code E)	5.7x(Code F)	6.2x(Code F)
No load current [A]	80.0/40.0	40.0	43.0	45.0	40.0	43.0	45.0
Rated speed [RPM]	1780	1480	1480	1485	1475	1475	1480
Slip [%]	1.11	1.33	1.33	1.00	1.67	1.67	1.33
Rated torque [ft.lb]	368	354	354	353	445	444	443
Locked rotor torque [%]	200	200	229	240	160	180	190
Breakdown torque [%]	229	229	260	280	180	200	220
Service factor	1.15	1.00	1.00	1.00	1.00	1.00	1.00
Temperature rise	80 K	80 K	80 K	80 K	80 K	80 K	80 K
Locked rotor time	48s (cold) 27s (hot)	32s (cold) 18s (hot)	32s (cold) 18s (hot)	32s (cold) 18s (hot)	32s (cold) 18s (hot)	32s (cold) 18s (hot)	32s (cold) 18s (hot)
Noise level ²	73.0 dB(A)	69.0 dB(A)	69.0 dB(A)	69.0 dB(A)	69.0 dB(A)	69.0 dB(A)	69.0 dB(A)
Efficiency (%)	25%	94.9	94.7	94.5	94.1	95.3	94.9
	50%	95.0	94.7	94.6	94.3	95.0	95.0
	75%	95.4	95.1	95.1	95.1	95.0	95.0
	100%	95.4	95.0	95.0	95.2	94.5	95.0
Power Factor	25%	0.52	0.50	0.47	0.44	0.58	0.52
	50%	0.74	0.73	0.69	0.67	0.79	0.74
	75%	0.82	0.82	0.80	0.78	0.85	0.82
	100%	0.85	0.86	0.84	0.83	0.86	0.85
Bearing type	: Drive end 6319 C3	Non drive end 6316 C3	Foundation loads				
Sealing	: WSeal	WSeal	Max. traction : 1777 lb				
Lubrication interval	: 8000 h	10000 h	Max. compression : 3425 lb				
Lubricant amount	: 45 g	34 g					
Lubricant type	: Mobil Polyrex EM						
Notes							
USABLE @208V 307A SF 1.00 SFA 307A							
This revision replaces and cancel the previous one, which must be eliminated. (1) Looking the motor from the shaft end. (2) Measured at 1m and with tolerance of +3dB(A). (3) Approximate weight subject to changes after manufacturing process. (4) At 100% of full load.				These are average values based on tests with sinusoidal power supply, subject to the tolerances stipulated in NEMA MG-1.			
Rev.	Changes Summary			Performed	Checked	Date	
Performed by							
Checked by					Page	Revision	
Date	13/04/2022				1 / 36		

TORQUE AND CURRENT VS SPEED CURVE

Three Phase Induction Motor - Squirrel Cage



Customer :

Product line : NEMA Premium Efficiency Three-Phase

Product code : 13273169

Catalog # : 12518ET3E444T-W22G

TORQUE AND CURRENT VS SPEED CURVE

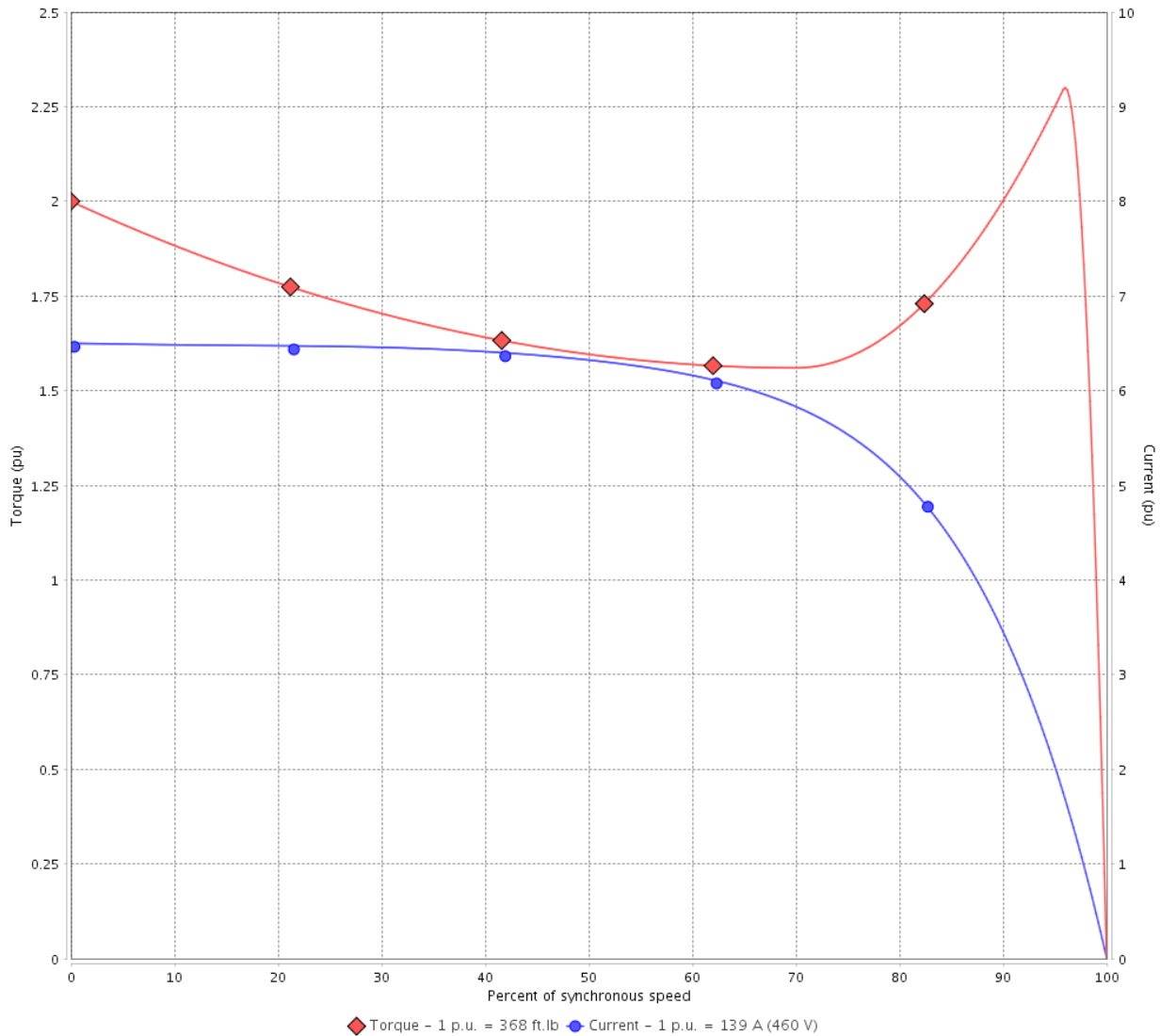

Performance : 230/460 V 60 Hz 4P

Rated current	: 278/139 A	Moment of inertia (J)	: 57.2 sq.ft.lb
LRC	: 6.5	Duty cycle	: Cont.(S1)
Rated torque	: 368 ft.lb	Insulation class	: F
Locked rotor torque	: 200 %	Service factor	: 1.15
Breakdown torque	: 229 %	Temperature rise	: 80 K
Rated speed	: 1780 rpm	Design	: B

Locked rotor time : 48s (cold) 27s (hot)

Rev.	Changes Summary	Performed	Checked	Date
Performed by			Page 2 / 36	Revision
Checked by				
Date	13/04/2022			

TORQUE AND CURRENT VS SPEED CURVE



Three Phase Induction Motor - Squirrel Cage

Customer :

Product line : NEMA Premium Efficiency Three-Phase

Product code : 13273169

Catalog # : 12518ET3E444T-W22G

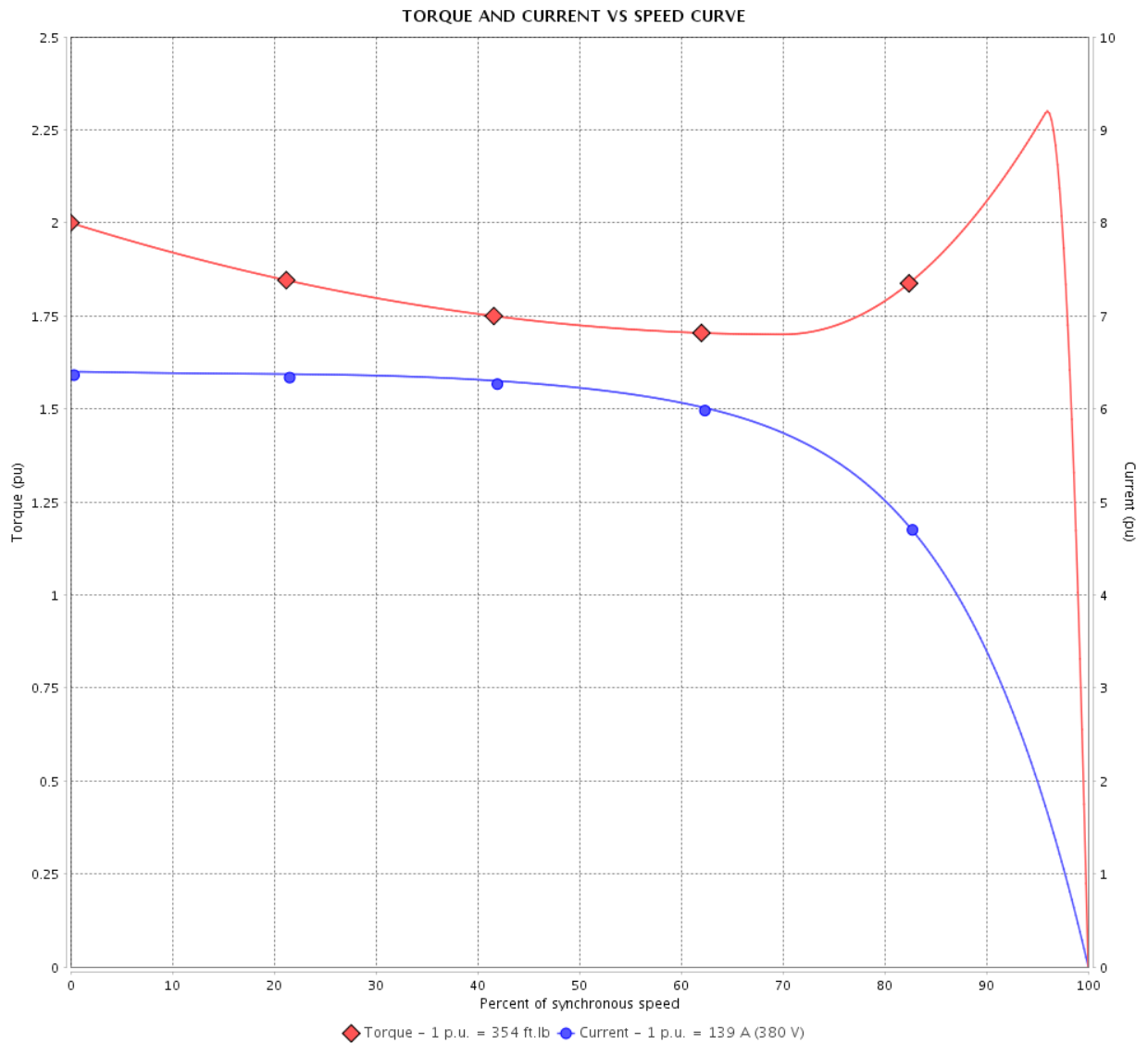

Performance : 380 V 50 Hz 4P IE3

Rated current	: 139 A	Moment of inertia (J)	: 57.2 sq.ft.lb
LRC	: 6.4	Duty cycle	: Cont.(S1)
Rated torque	: 354 ft.lb	Insulation class	: F
Locked rotor torque	: 200 %	Service factor	: 1.00
Breakdown torque	: 229 %	Temperature rise	: 80 K
Rated speed	: 1480 rpm	Design	: B

Locked rotor time : 32s (cold) 18s (hot)

Rev.	Changes Summary	Performed	Checked	Date
Performed by			Page 3 / 36	Revision
Checked by				
Date	13/04/2022			

TORQUE AND CURRENT VS SPEED CURVE

Three Phase Induction Motor - Squirrel Cage



Customer :

Product line : NEMA Premium Efficiency Three-Phase

Product code : 13273169

Catalog # : 12518ET3E444T-W22G

TORQUE AND CURRENT VS SPEED CURVE

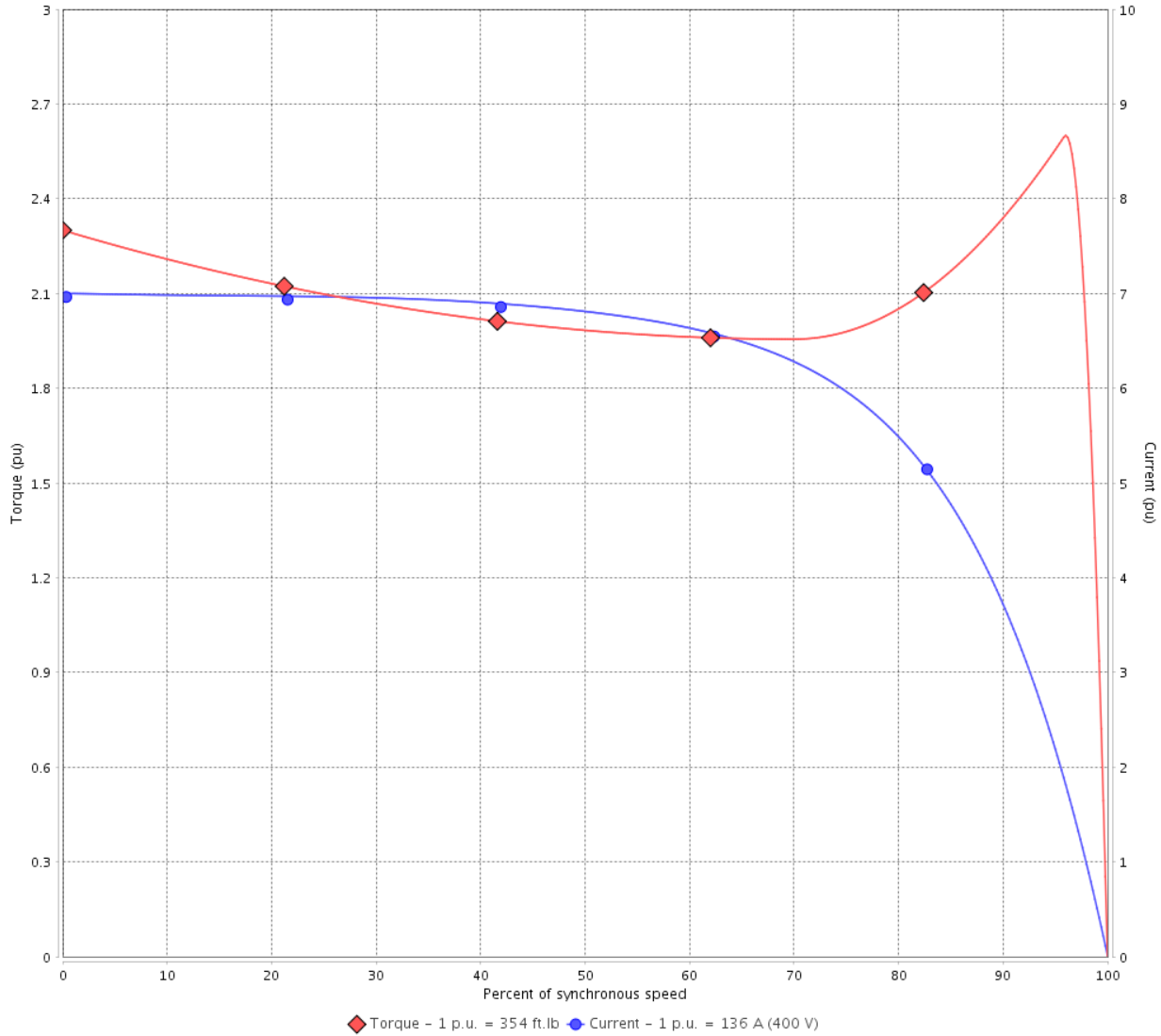

Performance : 400 V 50 Hz 4P IE3

Rated current	: 136 A	Moment of inertia (J)	: 57.2 sq.ft.lb
LRC	: 7.0	Duty cycle	: Cont.(S1)
Rated torque	: 354 ft.lb	Insulation class	: F
Locked rotor torque	: 229 %	Service factor	: 1.00
Breakdown torque	: 260 %	Temperature rise	: 80 K
Rated speed	: 1480 rpm	Design	: B

Locked rotor time : 32s (cold) 18s (hot)

Rev.	Changes Summary	Performed	Checked	Date
Performed by			Page 4 / 36	Revision
Checked by				
Date	13/04/2022			

TORQUE AND CURRENT VS SPEED CURVE



Three Phase Induction Motor - Squirrel Cage

Customer :

Product line : NEMA Premium Efficiency Three-Phase

Product code : 13273169

Catalog # : 12518ET3E444T-W22G

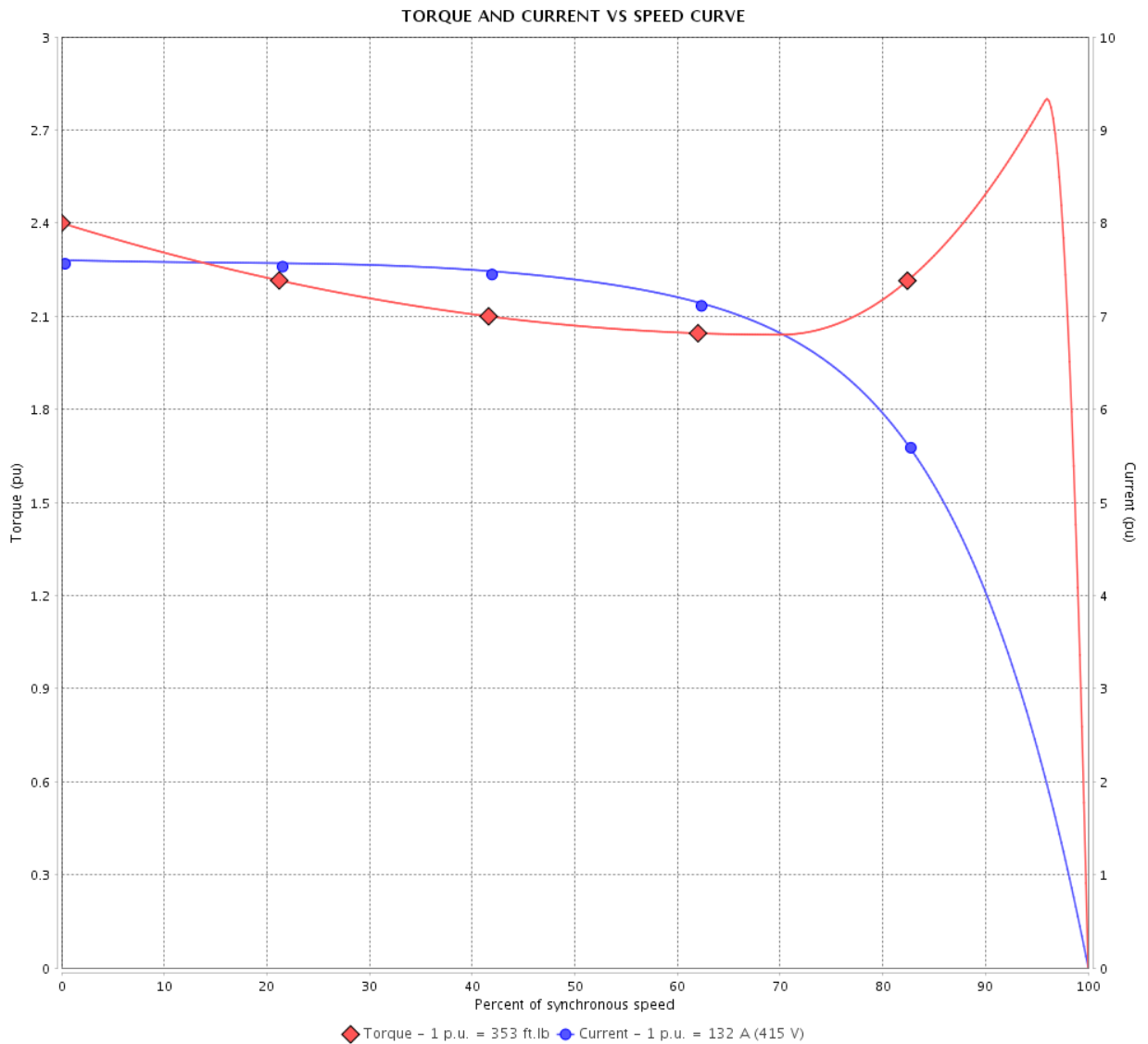

Performance : 415 V 50 Hz 4P IE3

Rated current	: 132 A	Moment of inertia (J)	: 57.2 sq.ft.lb
LRC	: 7.6	Duty cycle	: Cont.(S1)
Rated torque	: 353 ft.lb	Insulation class	: F
Locked rotor torque	: 240 %	Service factor	: 1.00
Breakdown torque	: 280 %	Temperature rise	: 80 K
Rated speed	: 1485 rpm	Design	: B

Locked rotor time : 32s (cold) 18s (hot)

Rev.	Changes Summary	Performed	Checked	Date
Performed by			Page 5 / 36	Revision
Checked by				
Date	13/04/2022			

TORQUE AND CURRENT VS SPEED CURVE

Three Phase Induction Motor - Squirrel Cage



Customer :

Product line : NEMA Premium Efficiency Three-Phase

Product code : 13273169

Catalog # : 12518ET3E444T-W22G

TORQUE AND CURRENT VS SPEED CURVE

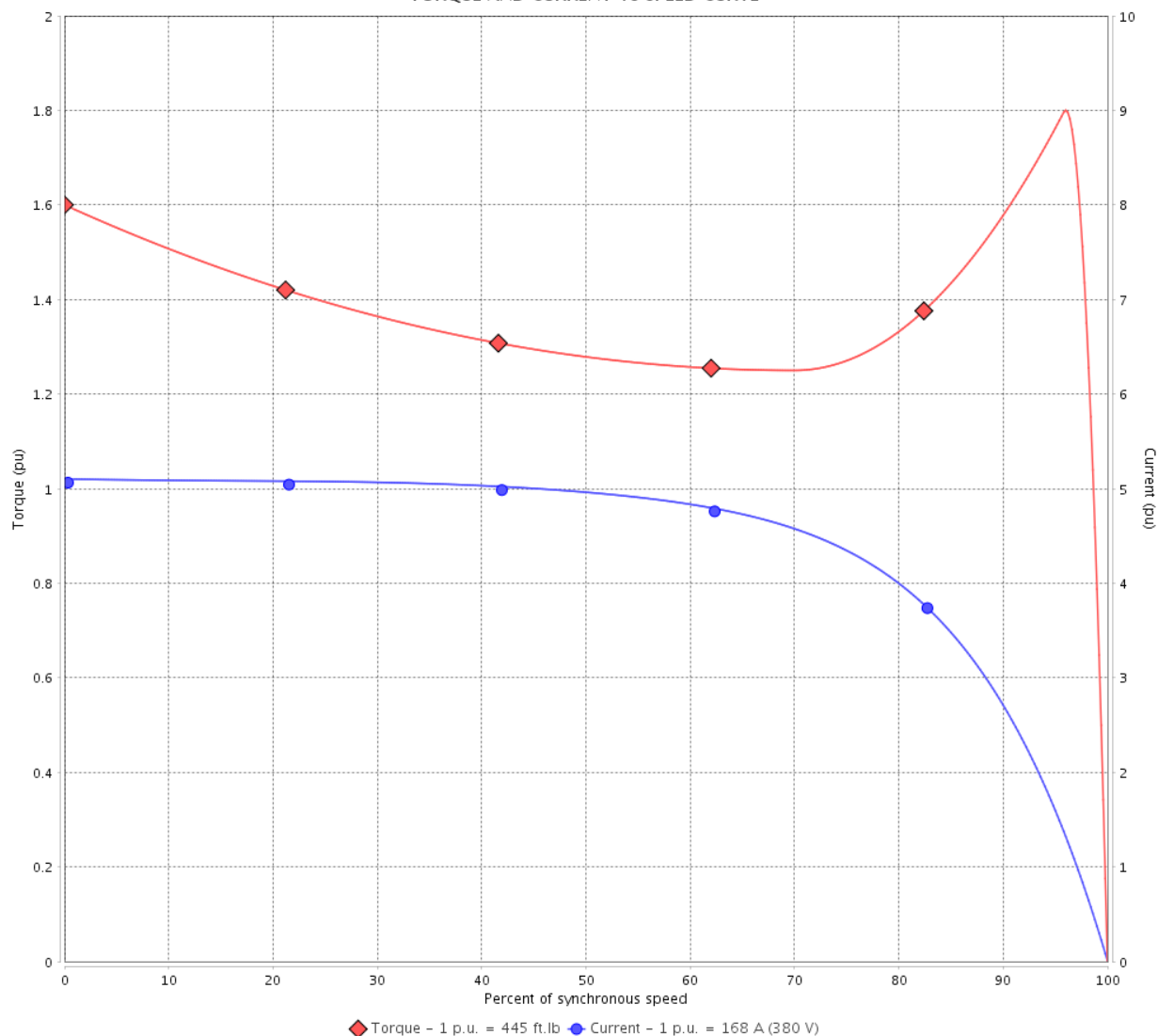

Performance : 380 V 50 Hz 4P IE2

Rated current	: 168 A	Moment of inertia (J)	: 57.2 sq.ft.lb
LRC	: 5.1	Duty cycle	: Cont.(S1)
Rated torque	: 445 ft.lb	Insulation class	: F
Locked rotor torque	: 160 %	Service factor	: 1.00
Breakdown torque	: 180 %	Temperature rise	: 80 K
Rated speed	: 1475 rpm	Design	: B

Locked rotor time : 32s (cold) 18s (hot)

Rev.	Changes Summary	Performed	Checked	Date
Performed by			Page 6 / 36	Revision
Checked by				
Date	13/04/2022			

TORQUE AND CURRENT VS SPEED CURVE



Three Phase Induction Motor - Squirrel Cage

Customer :

Product line : NEMA Premium Efficiency Three-Phase

Product code : 13273169

Catalog # : 12518ET3E444T-W22G

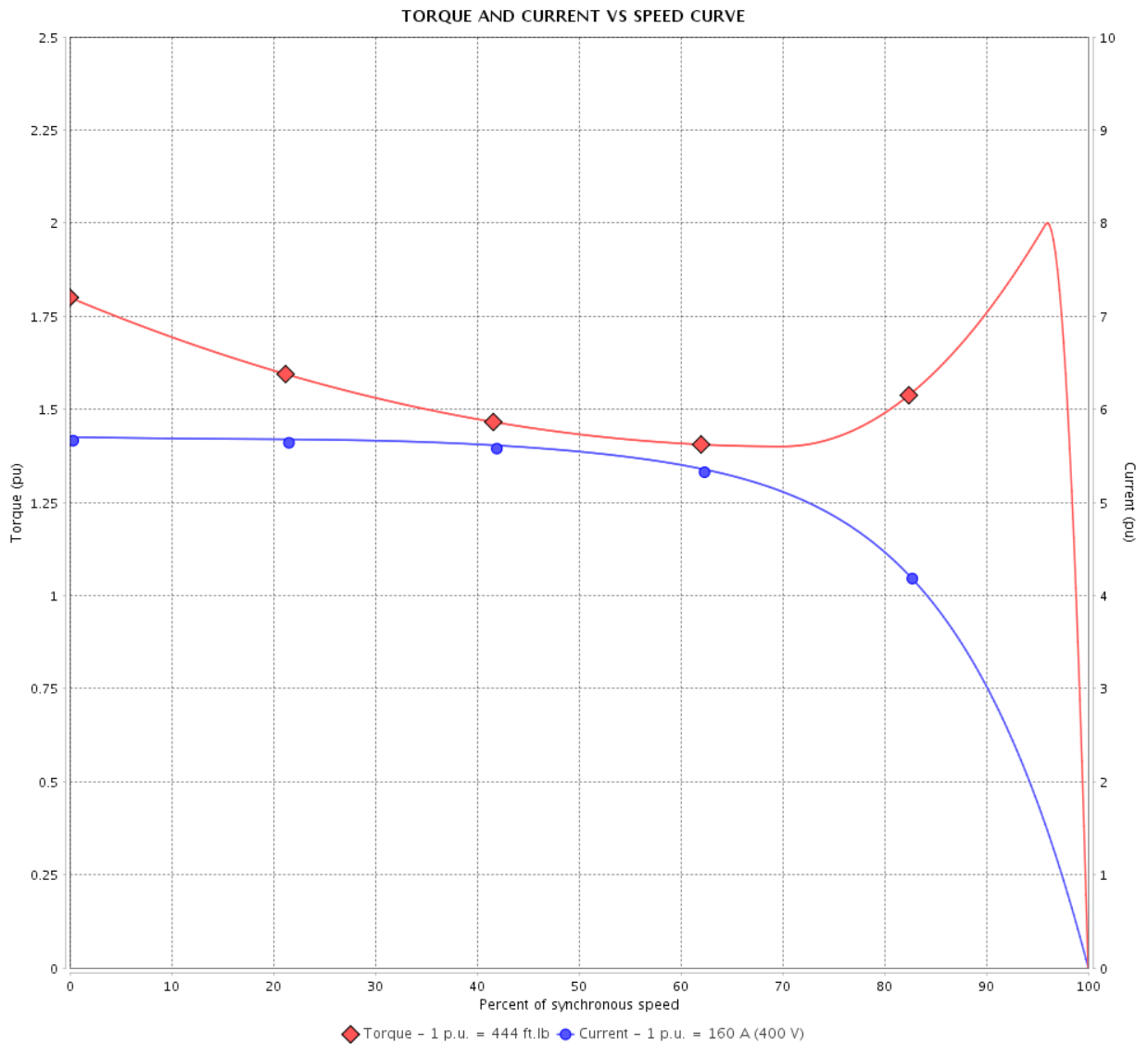

Performance : 400 V 50 Hz 4P IE2

Rated current	: 160 A	Moment of inertia (J)	: 57.2 sq.ft.lb
LRC	: 5.7	Duty cycle	: Cont.(S1)
Rated torque	: 444 ft.lb	Insulation class	: F
Locked rotor torque	: 180 %	Service factor	: 1.00
Breakdown torque	: 200 %	Temperature rise	: 80 K
Rated speed	: 1475 rpm	Design	: B

Locked rotor time : 32s (cold) 18s (hot)

Rev.	Changes Summary	Performed	Checked	Date
Performed by			Page 7 / 36	Revision
Checked by				
Date	13/04/2022			

TORQUE AND CURRENT VS SPEED CURVE

Three Phase Induction Motor - Squirrel Cage



Customer :

Product line : NEMA Premium Efficiency Three-Phase

Product code : 13273169

Catalog # : 12518ET3E444T-W22G

TORQUE AND CURRENT VS SPEED CURVE

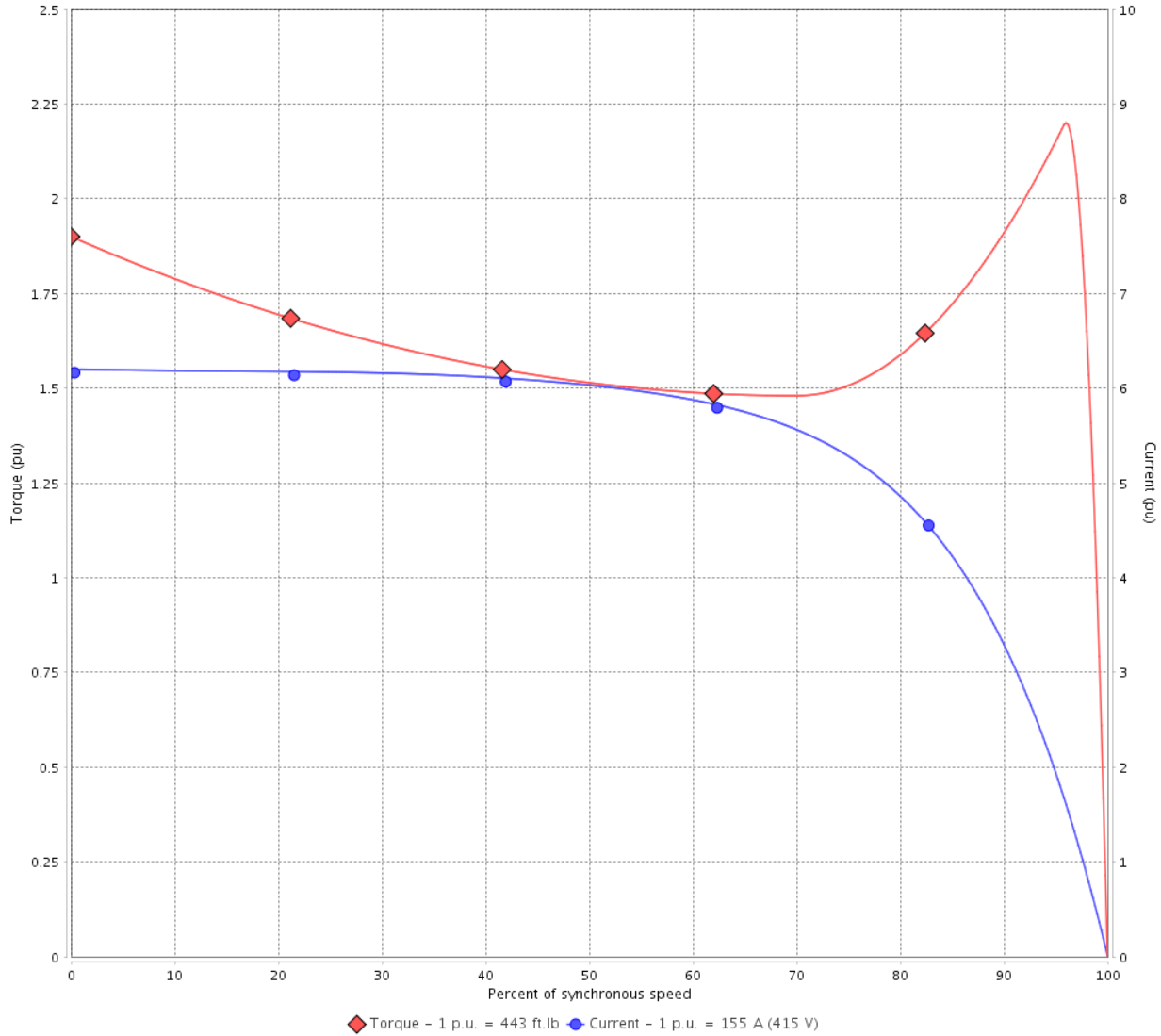

Performance : 415 V 50 Hz 4P IE2

Rated current	: 155 A	Moment of inertia (J)	: 57.2 sq.ft.lb
LRC	: 6.2	Duty cycle	: Cont.(S1)
Rated torque	: 443 ft.lb	Insulation class	: F
Locked rotor torque	: 190 %	Service factor	: 1.00
Breakdown torque	: 220 %	Temperature rise	: 80 K
Rated speed	: 1480 rpm	Design	: B

Locked rotor time : 32s (cold) 18s (hot)

Rev.	Changes Summary	Performed	Checked	Date
Performed by			Page 8 / 36	Revision
Checked by				
Date	13/04/2022			

LOAD PERFORMANCE CURVE

Three Phase Induction Motor - Squirrel Cage



Customer : _____

Product line : NEMA Premium Efficiency Three-Phase

Product code : 13273169

Catalog # : 12518ET3E444T-W22G

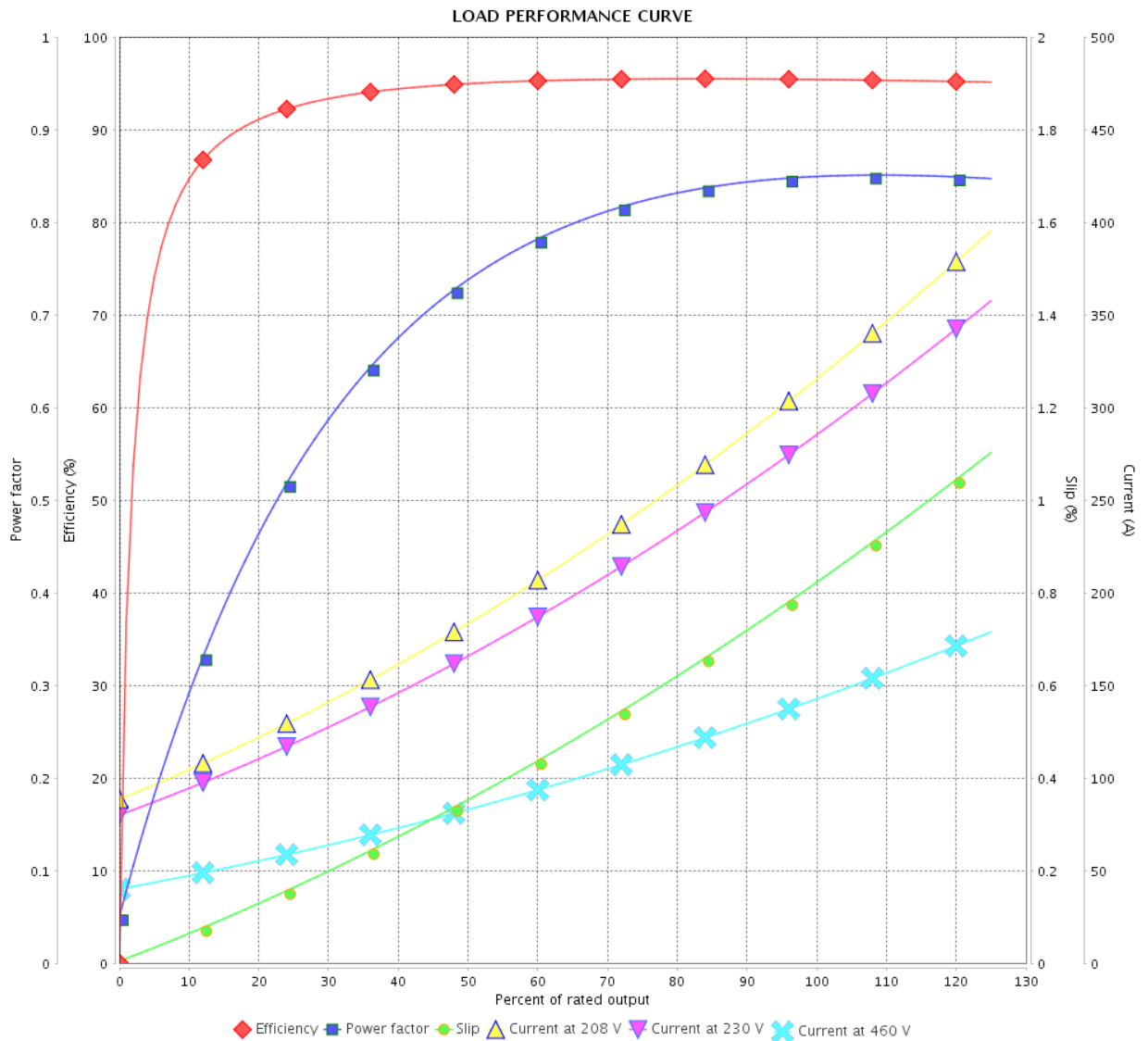

Performance : 230/460 V 60 Hz 4P

Rated current : 278/139 A
 LRC : 6.5
 Rated torque : 368 ft.lb
 Locked rotor torque : 200 %
 Breakdown torque : 229 %
 Rated speed : 1780 rpm

Moment of inertia (J) : 57.2 sq.ft.lb
 Duty cycle : Cont.(S1)
 Insulation class : F
 Service factor : 1.15
 Temperature rise : 80 K
 Design : B

Rev.	Changes Summary	Performed	Checked	Date
Performed by		Page		Revision
Checked by		9 / 36		
Date		13/04/2022		

LOAD PERFORMANCE CURVE

Three Phase Induction Motor - Squirrel Cage



Customer :

Product line : NEMA Premium Efficiency Three-Phase

Product code : 13273169

Catalog # : 12518ET3E444T-W22G

LOAD PERFORMANCE CURVE

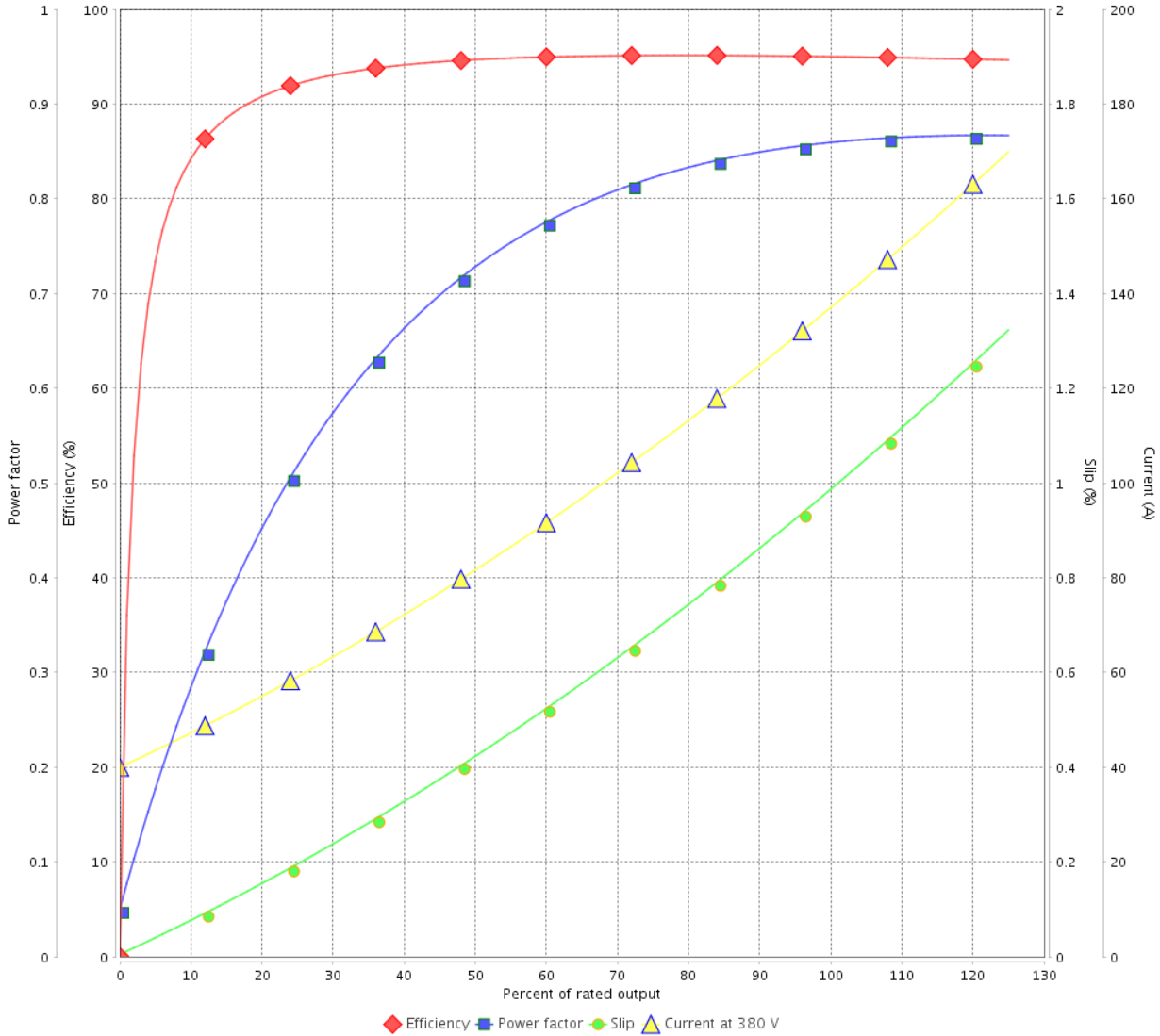

Performance : 380 V 50 Hz 4P IE3

Rated current : 139 A
 LRC : 6.4
 Rated torque : 354 ft.lb
 Locked rotor torque : 200 %
 Breakdown torque : 229 %
 Rated speed : 1480 rpm

Moment of inertia (J) : 57.2 sq.ft.lb
 Duty cycle : Cont.(S1)
 Insulation class : F
 Service factor : 1.00
 Temperature rise : 80 K
 Design : B

Rev.	Changes Summary	Performed	Checked	Date
Performed by			Page 10 / 36	Revision
Checked by				
Date	13/04/2022			

LOAD PERFORMANCE CURVE

Three Phase Induction Motor - Squirrel Cage



Customer :

Product line : NEMA Premium Efficiency Three-Phase

Product code : 13273169

Catalog # : 12518ET3E444T-W22G

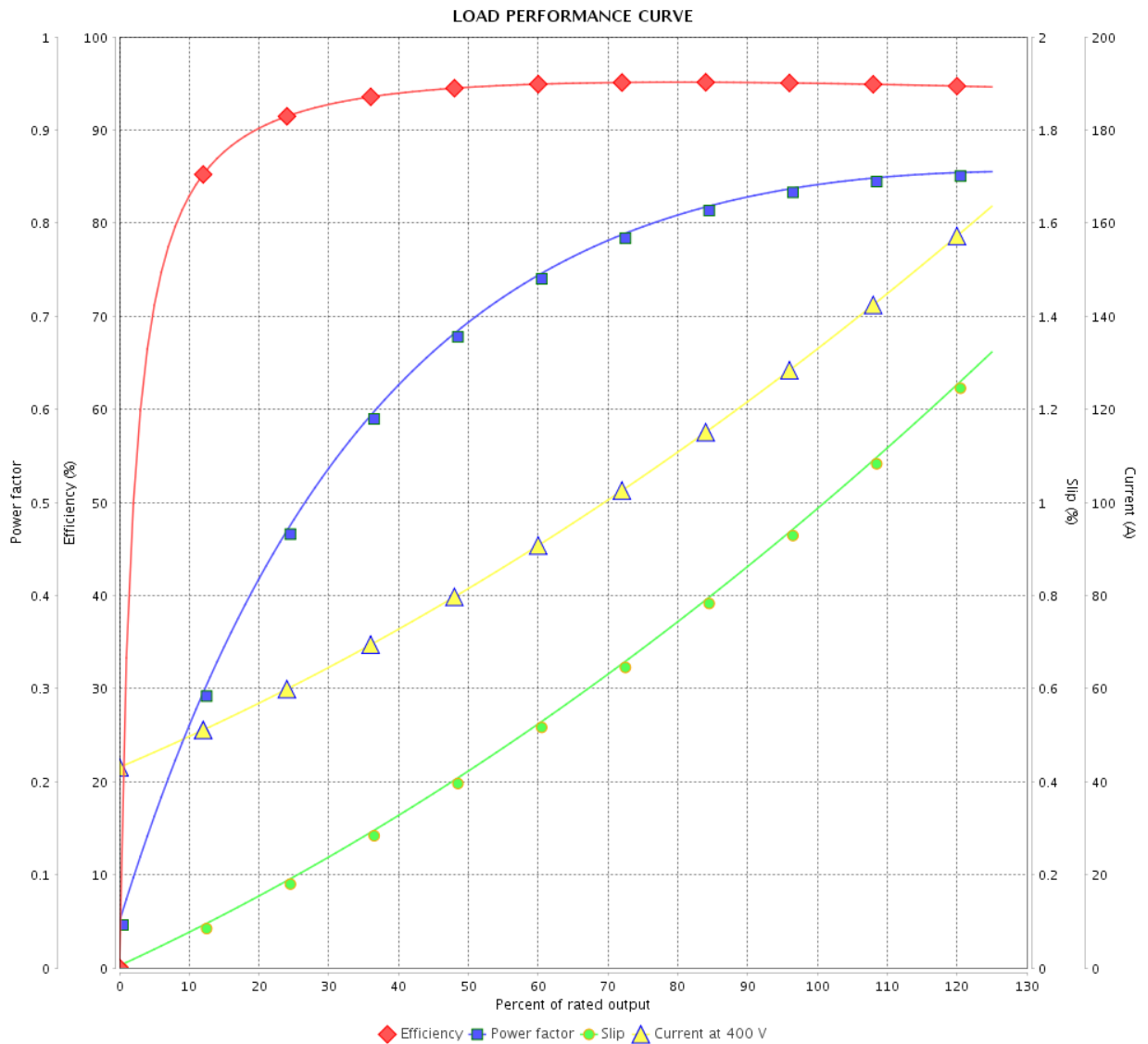

Performance : 400 V 50 Hz 4P IE3

Rated current : 136 A
 LRC : 7.0
 Rated torque : 354 ft.lb
 Locked rotor torque : 229 %
 Breakdown torque : 260 %
 Rated speed : 1480 rpm

Moment of inertia (J) : 57.2 sq.ft.lb
 Duty cycle : Cont.(S1)
 Insulation class : F
 Service factor : 1.00
 Temperature rise : 80 K
 Design : B

Rev.	Changes Summary	Performed	Checked	Date
Performed by			Page	Revision
Checked by			11 / 36	
Date	13/04/2022			

LOAD PERFORMANCE CURVE

Three Phase Induction Motor - Squirrel Cage



Customer :

Product line : NEMA Premium Efficiency Three-Phase

Product code : 13273169

Catalog # : 12518ET3E444T-W22G

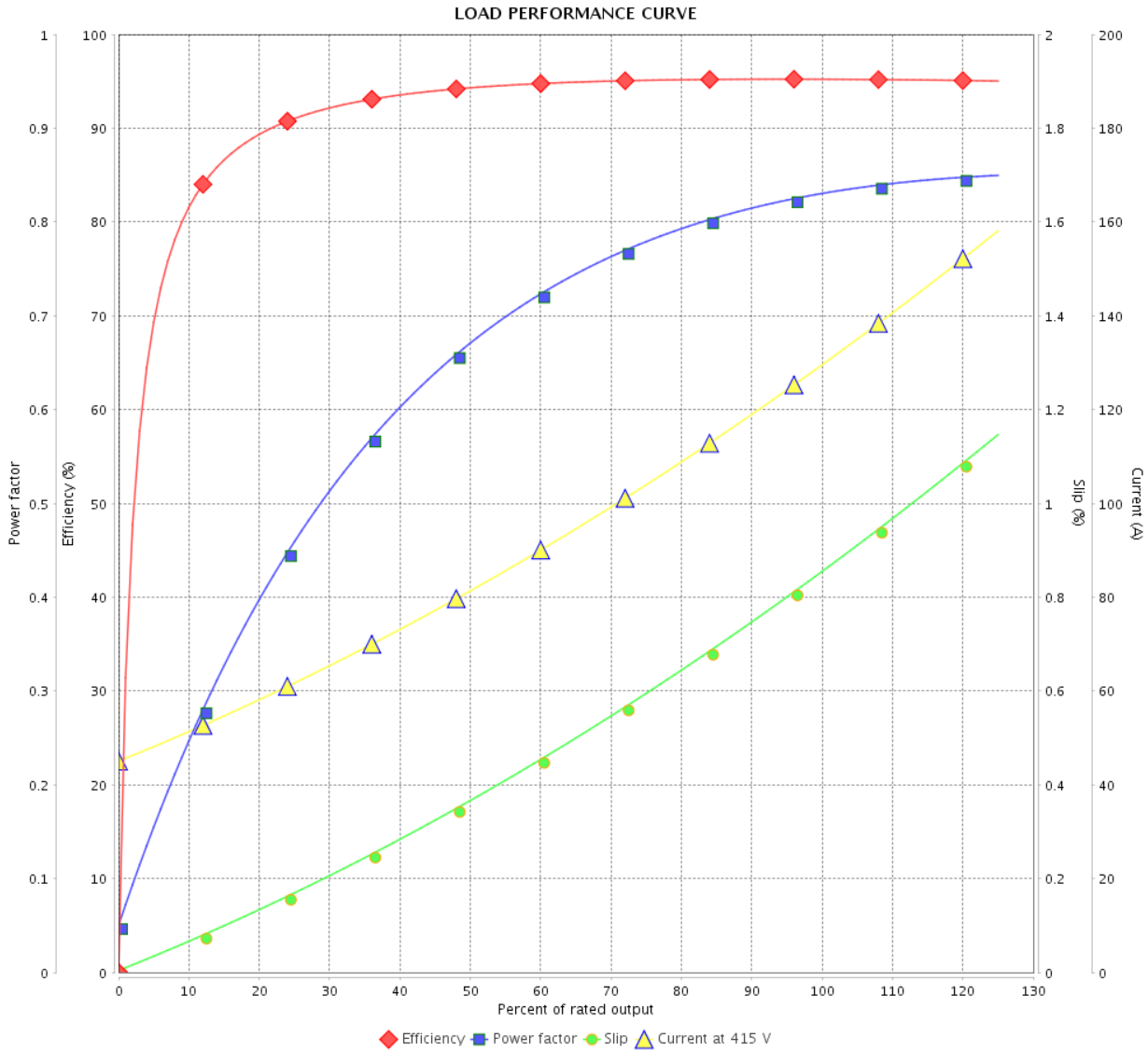

Performance : 415 V 50 Hz 4P IE3

Rated current	: 132 A	Moment of inertia (J)	: 57.2 sq.ft.lb
LRC	: 7.6	Duty cycle	: Cont.(S1)
Rated torque	: 353 ft.lb	Insulation class	: F
Locked rotor torque	: 240 %	Service factor	: 1.00
Breakdown torque	: 280 %	Temperature rise	: 80 K
Rated speed	: 1485 rpm	Design	: B

Rev.	Changes Summary	Performed	Checked	Date
Performed by			Page 12 / 36	Revision
Checked by				
Date	13/04/2022			

LOAD PERFORMANCE CURVE

Three Phase Induction Motor - Squirrel Cage



Customer :

Product line : NEMA Premium Efficiency Three-Phase

Product code : 13273169

Catalog # : 12518ET3E444T-W22G

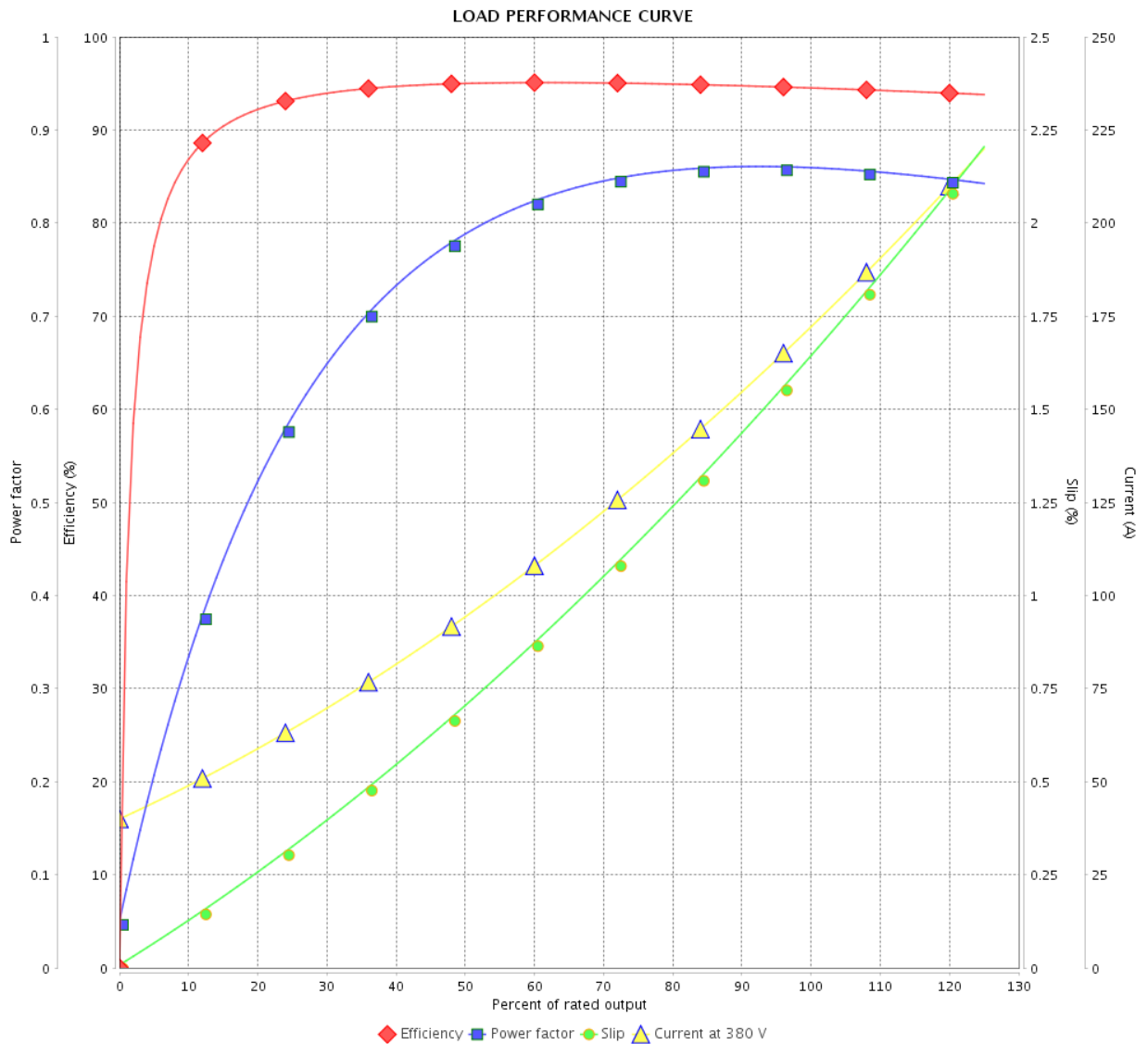

Performance : 380 V 50 Hz 4P IE2

Rated current : 168 A
 LRC : 5.1
 Rated torque : 445 ft.lb
 Locked rotor torque : 160 %
 Breakdown torque : 180 %
 Rated speed : 1475 rpm

Moment of inertia (J) : 57.2 sq.ft.lb
 Duty cycle : Cont.(S1)
 Insulation class : F
 Service factor : 1.00
 Temperature rise : 80 K
 Design : B

Rev.	Changes Summary	Performed	Checked	Date
Performed by			Page	Revision
Checked by				
Date				
			13 / 36	

LOAD PERFORMANCE CURVE

Three Phase Induction Motor - Squirrel Cage



Customer :

Product line : NEMA Premium Efficiency Three-Phase

Product code : 13273169

Catalog # : 12518ET3E444T-W22G

LOAD PERFORMANCE CURVE

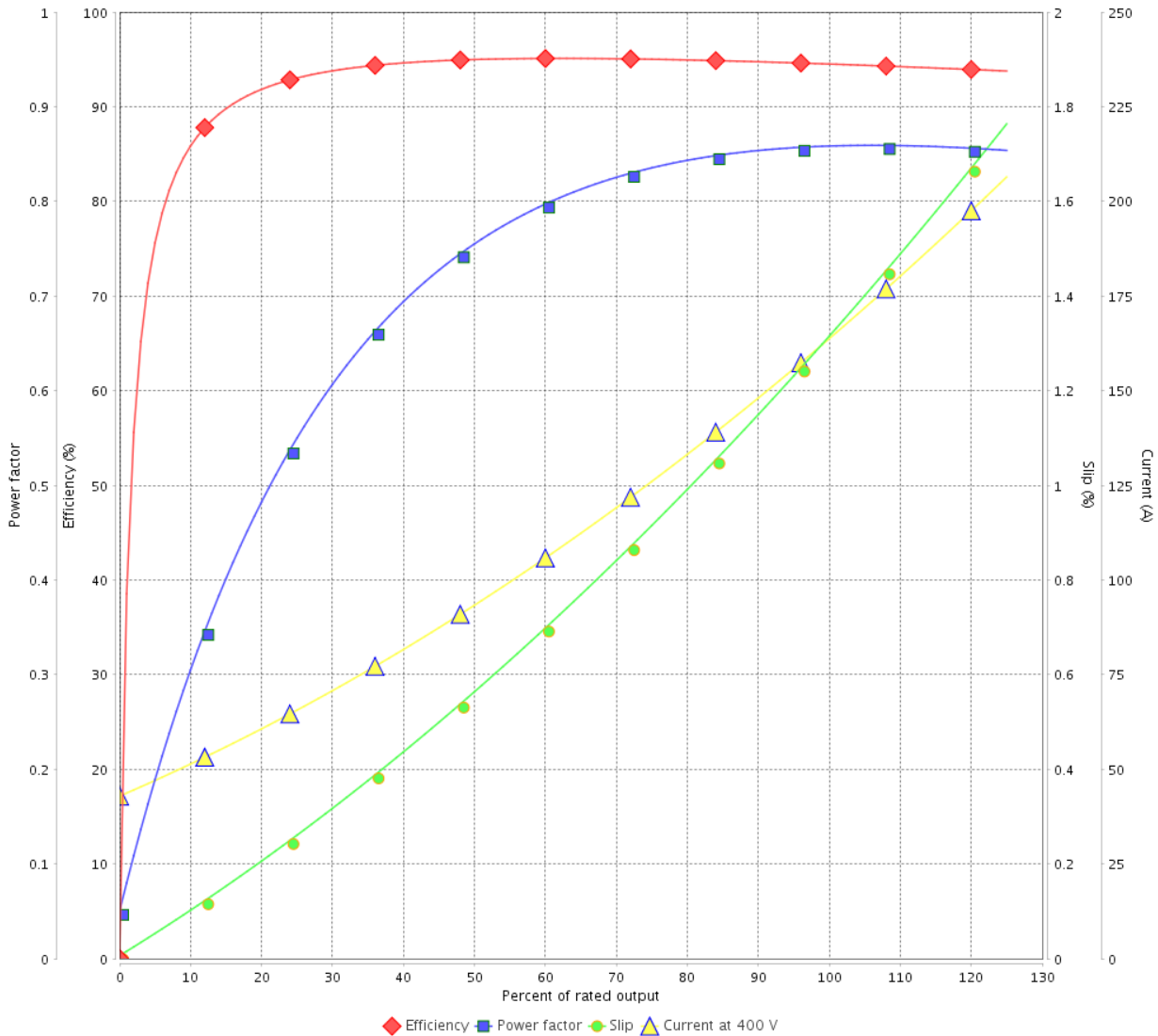

Performance : 400 V 50 Hz 4P IE2

Rated current : 160 A
 LRC : 5.7
 Rated torque : 444 ft.lb
 Locked rotor torque : 180 %
 Breakdown torque : 200 %
 Rated speed : 1475 rpm

Moment of inertia (J) : 57.2 sq.ft.lb
 Duty cycle : Cont.(S1)
 Insulation class : F
 Service factor : 1.00
 Temperature rise : 80 K
 Design : B

Rev.	Changes Summary	Performed	Checked	Date
Performed by			Page	Revision
Checked by			14 / 36	
Date	13/04/2022			

LOAD PERFORMANCE CURVE

Three Phase Induction Motor - Squirrel Cage



Customer : _____

Product line : NEMA Premium Efficiency Three-Phase

Product code : 13273169

Catalog # : 12518ET3E444T-W22G

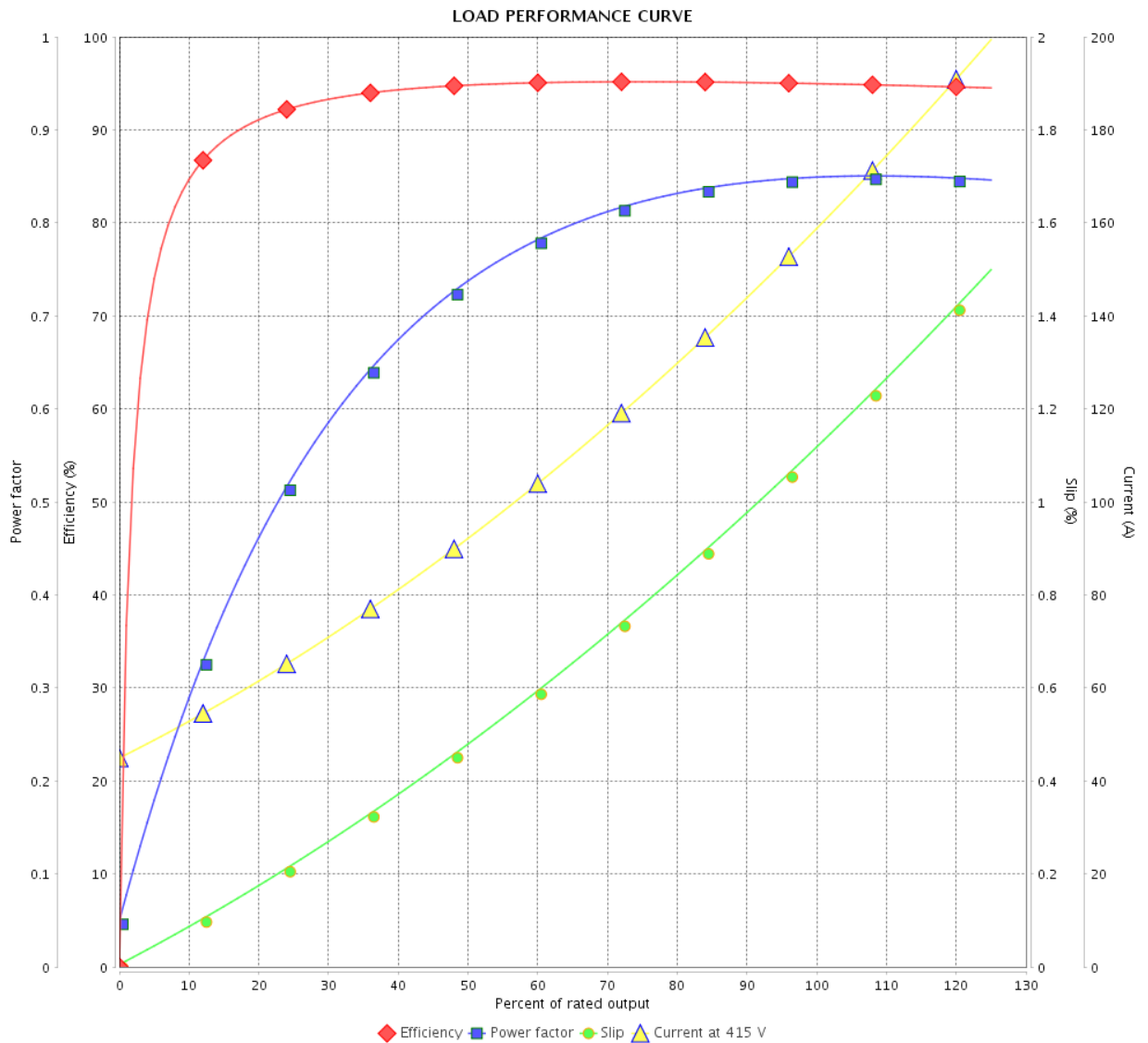

Performance : 415 V 50 Hz 4P IE2

Rated current : 155 A
 LRC : 6.2
 Rated torque : 443 ft.lb
 Locked rotor torque : 190 %
 Breakdown torque : 220 %
 Rated speed : 1480 rpm

Moment of inertia (J) : 57.2 sq.ft.lb
 Duty cycle : Cont.(S1)
 Insulation class : F
 Service factor : 1.00
 Temperature rise : 80 K
 Design : B

Rev.	Changes Summary	Performed	Checked	Date
Performed by		Page		Revision
Checked by		15 / 36		
Date		13/04/2022		

THERMAL LIMIT CURVE

Three Phase Induction Motor - Squirrel Cage



Customer :

Product line : NEMA Premium Efficiency Three-Phase
Product code : 13273169
Catalog # : 12518ET3E444T-W22G

Performance : 230/460 V 60 Hz 4P

Rated current	: 278/139 A	Moment of inertia (J)	: 57.2 sq.ft.lb
LRC	: 6.5	Duty cycle	: Cont.(S1)
Rated torque	: 368 ft.lb	Insulation class	: F
Locked rotor torque	: 200 %	Service factor	: 1.15
Breakdown torque	: 229 %	Temperature rise	: 80 K
Rated speed	: 1780 rpm	Design	: B

Heating constant

Cooling constant

Rev.	Changes Summary	Performed	Checked	Date
Performed by				
Checked by			Page	Revision
Date	13/04/2022		16 / 36	

THERMAL LIMIT CURVE

Three Phase Induction Motor - Squirrel Cage



Customer : _____

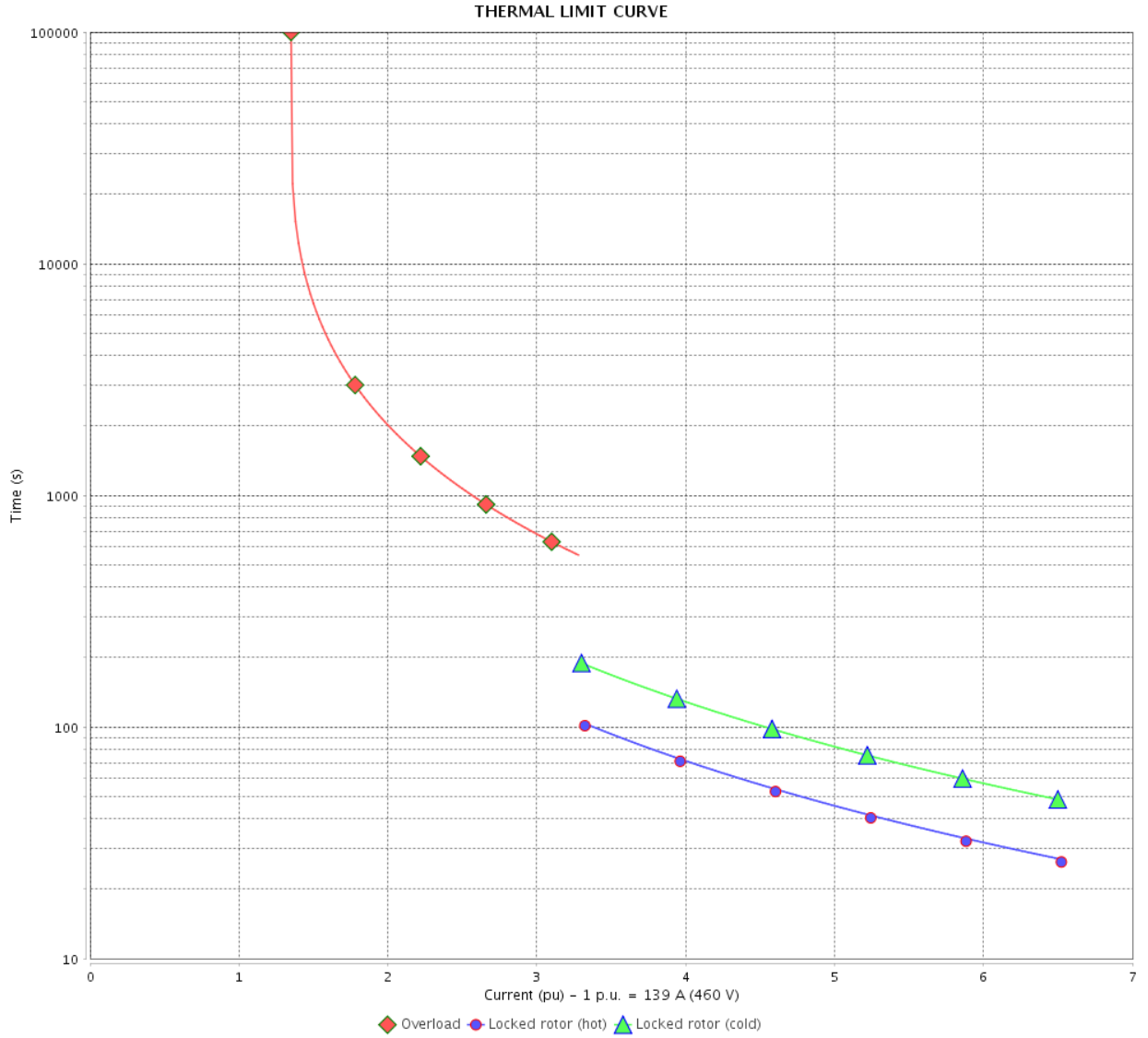

Rev.	Changes Summary	Performed	Checked	Date
Performed by		Page		Revision
Checked by		17 / 36		
Date		13/04/2022		

THERMAL LIMIT CURVE



Three Phase Induction Motor - Squirrel Cage

Customer :

Product line : NEMA Premium Efficiency Three-Phase
Product code : 13273169
Catalog # : 12518ET3E444T-W22G

Performance : 380 V 50 Hz 4P IE3

Rated current	: 139 A	Moment of inertia (J)	: 57.2 sq.ft.lb
LRC	: 6.4	Duty cycle	: Cont.(S1)
Rated torque	: 354 ft.lb	Insulation class	: F
Locked rotor torque	: 200 %	Service factor	: 1.00
Breakdown torque	: 229 %	Temperature rise	: 80 K
Rated speed	: 1480 rpm	Design	: B

Heating constant

Cooling constant

Rev.	Changes Summary	Performed	Checked	Date
Performed by				
Checked by			Page	Revision
Date	13/04/2022		18 / 36	

THERMAL LIMIT CURVE

Three Phase Induction Motor - Squirrel Cage



Customer : _____

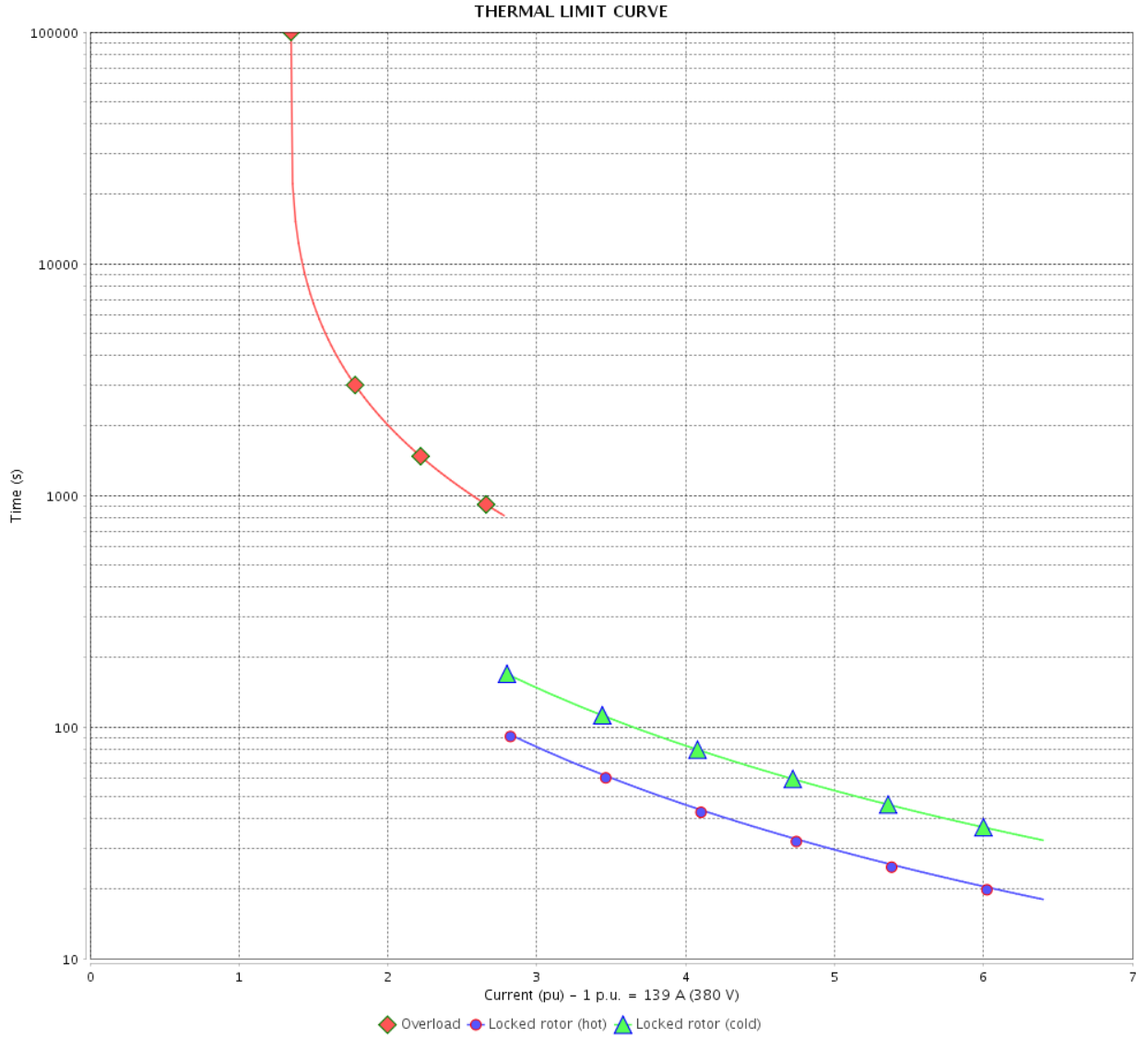

Rev.	Changes Summary	Performed	Checked	Date
Performed by		Page		Revision
Checked by		19 / 36		
Date		13/04/2022		

THERMAL LIMIT CURVE



Three Phase Induction Motor - Squirrel Cage

Customer :

Product line : NEMA Premium Efficiency Three-Phase
Product code : 13273169
Catalog # : 12518ET3E444T-W22G

Performance : 400 V 50 Hz 4P IE3

Rated current	: 136 A	Moment of inertia (J)	: 57.2 sq.ft.lb
LRC	: 7.0	Duty cycle	: Cont.(S1)
Rated torque	: 354 ft.lb	Insulation class	: F
Locked rotor torque	: 229 %	Service factor	: 1.00
Breakdown torque	: 260 %	Temperature rise	: 80 K
Rated speed	: 1480 rpm	Design	: B

Heating constant

Cooling constant

Rev.	Changes Summary	Performed	Checked	Date
Performed by				
Checked by			Page	Revision
Date	13/04/2022		20 / 36	

THERMAL LIMIT CURVE

Three Phase Induction Motor - Squirrel Cage



Customer : _____

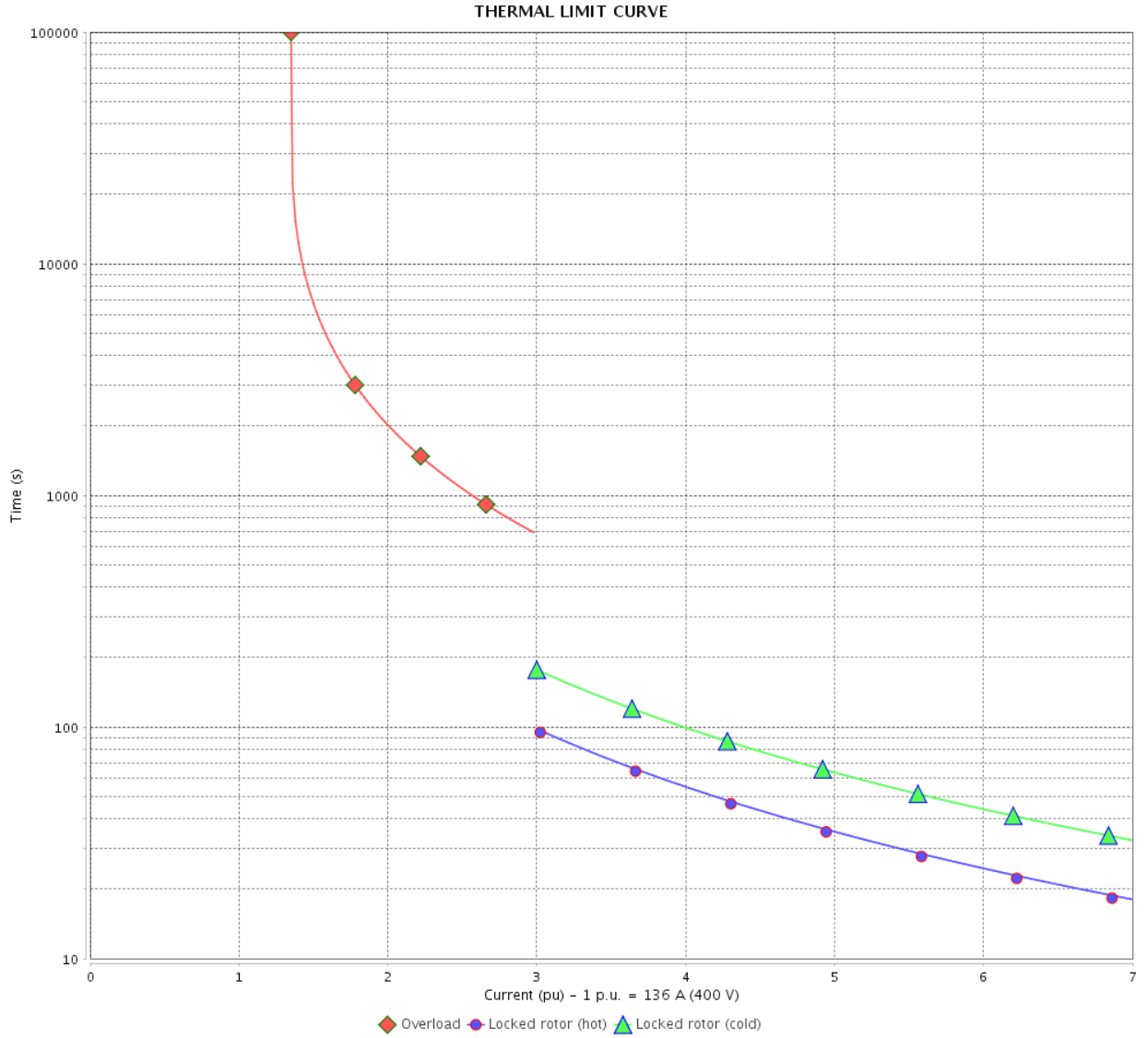

Rev.	Changes Summary	Performed	Checked	Date
Performed by		Page		Revision
Checked by		21 / 36		
Date		13/04/2022		

THERMAL LIMIT CURVE

Three Phase Induction Motor - Squirrel Cage



Customer :

Product line : NEMA Premium Efficiency Three-Phase
Product code : 13273169
Catalog # : 12518ET3E444T-W22G

Performance : 415 V 50 Hz 4P IE3

Rated current	: 132 A	Moment of inertia (J)	: 57.2 sq.ft.lb
LRC	: 7.6	Duty cycle	: Cont.(S1)
Rated torque	: 353 ft.lb	Insulation class	: F
Locked rotor torque	: 240 %	Service factor	: 1.00
Breakdown torque	: 280 %	Temperature rise	: 80 K
Rated speed	: 1485 rpm	Design	: B

Heating constant

Cooling constant

Rev.	Changes Summary	Performed	Checked	Date
Performed by				
Checked by			Page	Revision
Date	13/04/2022		22 / 36	

THERMAL LIMIT CURVE

Three Phase Induction Motor - Squirrel Cage



Customer : _____

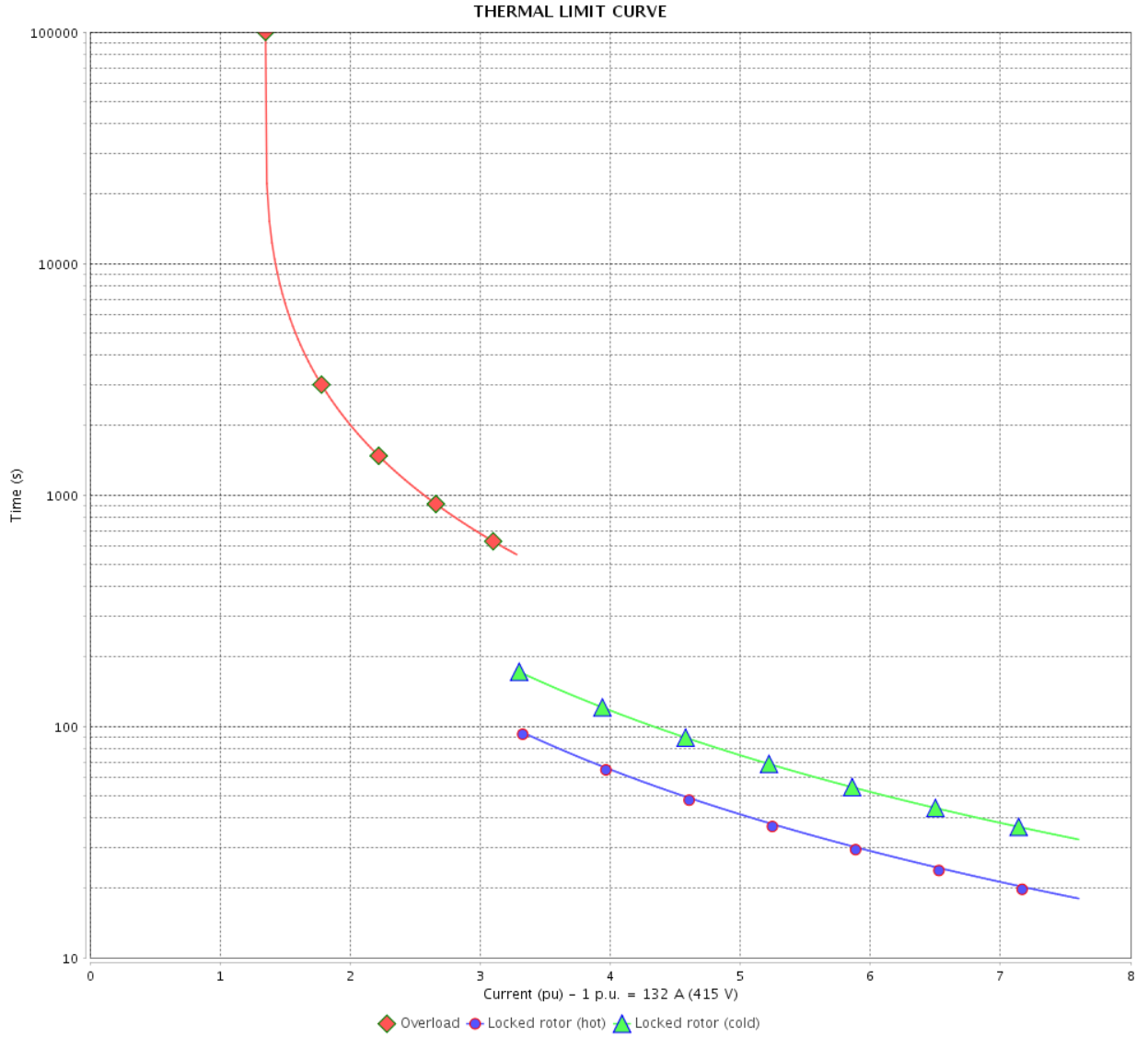

Rev.	Changes Summary	Performed	Checked	Date
Performed by		Page		Revision
Checked by				
Date				

THERMAL LIMIT CURVE

Three Phase Induction Motor - Squirrel Cage



Customer :

Product line : NEMA Premium Efficiency Three-Phase
Product code : 13273169
Catalog # : 12518ET3E444T-W22G

Performance : 380 V 50 Hz 4P IE2

Rated current	: 168 A	Moment of inertia (J)	: 57.2 sq.ft.lb
LRC	: 5.1	Duty cycle	: Cont.(S1)
Rated torque	: 445 ft.lb	Insulation class	: F
Locked rotor torque	: 160 %	Service factor	: 1.00
Breakdown torque	: 180 %	Temperature rise	: 80 K
Rated speed	: 1475 rpm	Design	: B

Heating constant

Cooling constant

Rev.	Changes Summary	Performed	Checked	Date
Performed by				
Checked by			Page	Revision
Date	13/04/2022		24 / 36	

THERMAL LIMIT CURVE

Three Phase Induction Motor - Squirrel Cage



Customer : _____

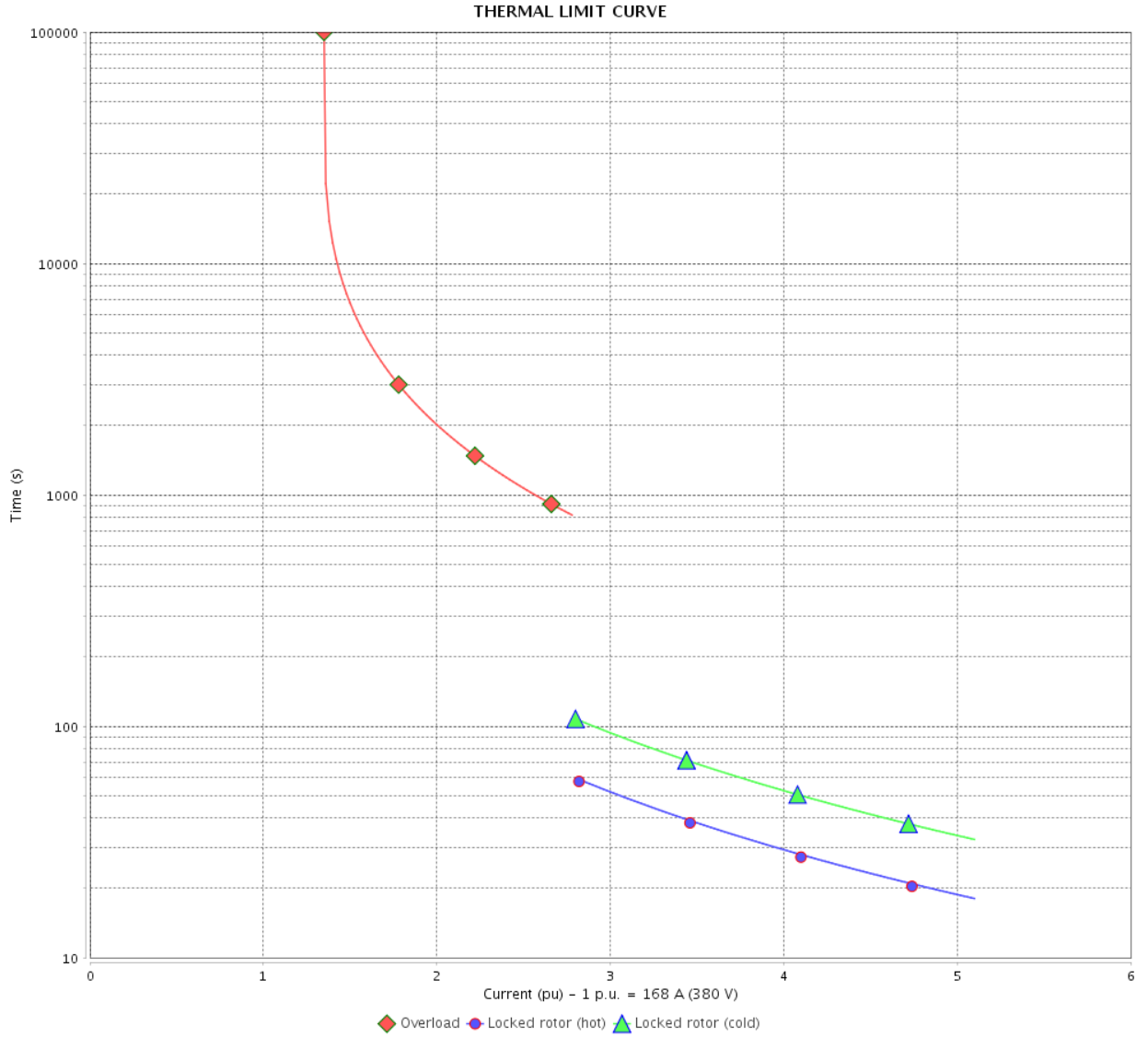

Rev.	Changes Summary	Performed	Checked	Date
Performed by		Page		Revision
Checked by		25 / 36		
Date		13/04/2022		

THERMAL LIMIT CURVE

Three Phase Induction Motor - Squirrel Cage



Customer :

Product line : NEMA Premium Efficiency Three-Phase
Product code : 13273169
Catalog # : 12518ET3E444T-W22G

Performance : 400 V 50 Hz 4P IE2

Rated current	: 160 A	Moment of inertia (J)	: 57.2 sq.ft.lb
LRC	: 5.7	Duty cycle	: Cont.(S1)
Rated torque	: 444 ft.lb	Insulation class	: F
Locked rotor torque	: 180 %	Service factor	: 1.00
Breakdown torque	: 200 %	Temperature rise	: 80 K
Rated speed	: 1475 rpm	Design	: B

Heating constant

Cooling constant

Rev.	Changes Summary	Performed	Checked	Date
Performed by				
Checked by			Page	Revision
Date	13/04/2022		26 / 36	

THERMAL LIMIT CURVE

Three Phase Induction Motor - Squirrel Cage



Customer : _____

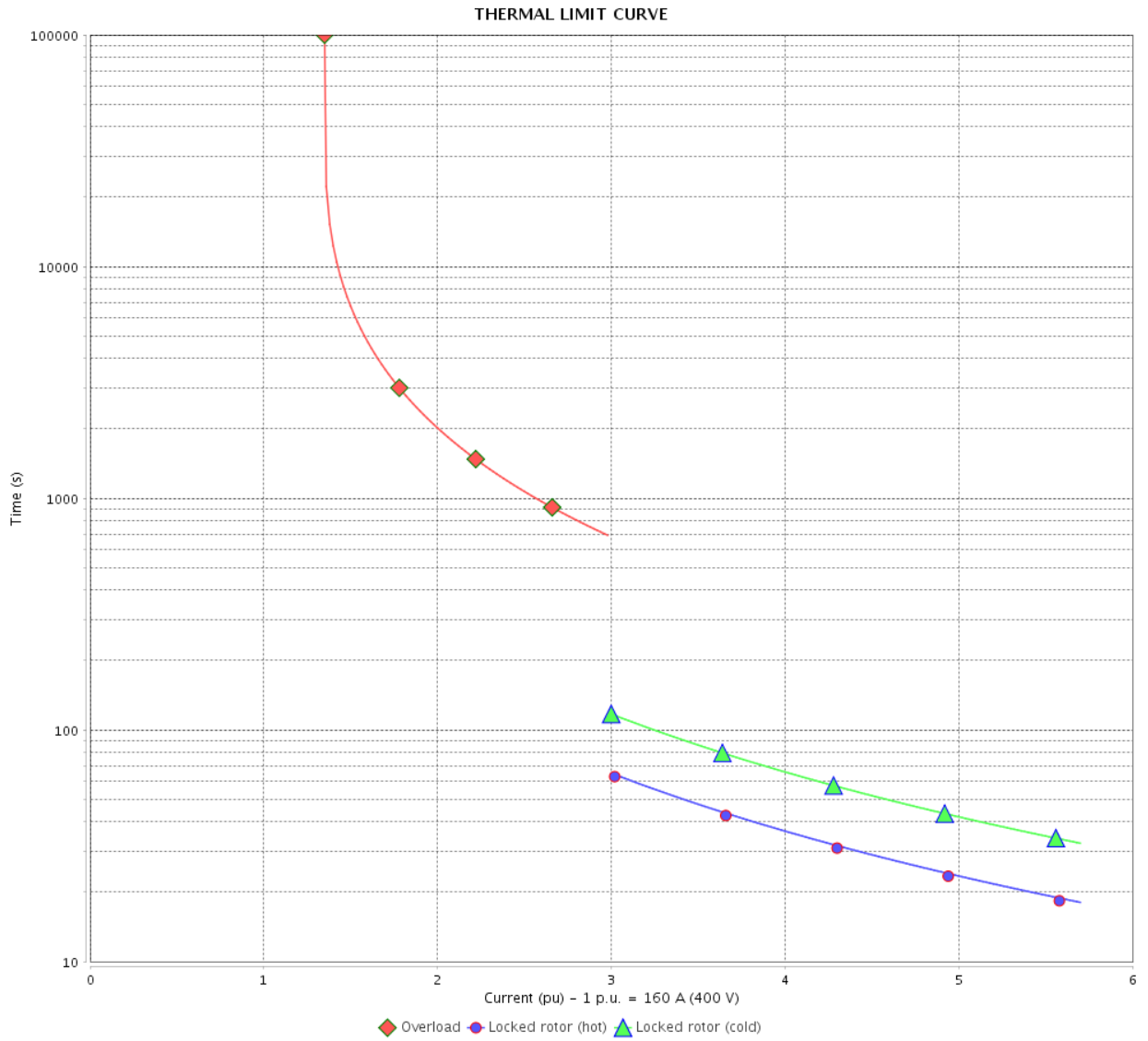

Rev.	Changes Summary	Performed	Checked	Date
Performed by		Page		Revision
Checked by		27 / 36		
Date		13/04/2022		

THERMAL LIMIT CURVE

Three Phase Induction Motor - Squirrel Cage



Customer :

Product line : NEMA Premium Efficiency Three-Phase
Product code : 13273169
Catalog # : 12518ET3E444T-W22G

Performance : 415 V 50 Hz 4P IE2

Rated current	: 155 A	Moment of inertia (J)	: 57.2 sq.ft.lb
LRC	: 6.2	Duty cycle	: Cont.(S1)
Rated torque	: 443 ft.lb	Insulation class	: F
Locked rotor torque	: 190 %	Service factor	: 1.00
Breakdown torque	: 220 %	Temperature rise	: 80 K
Rated speed	: 1480 rpm	Design	: B

Heating constant

Cooling constant

Rev.	Changes Summary	Performed	Checked	Date
Performed by				
Checked by			Page	Revision
Date	13/04/2022		28 / 36	

THERMAL LIMIT CURVE

Three Phase Induction Motor - Squirrel Cage



Customer : _____

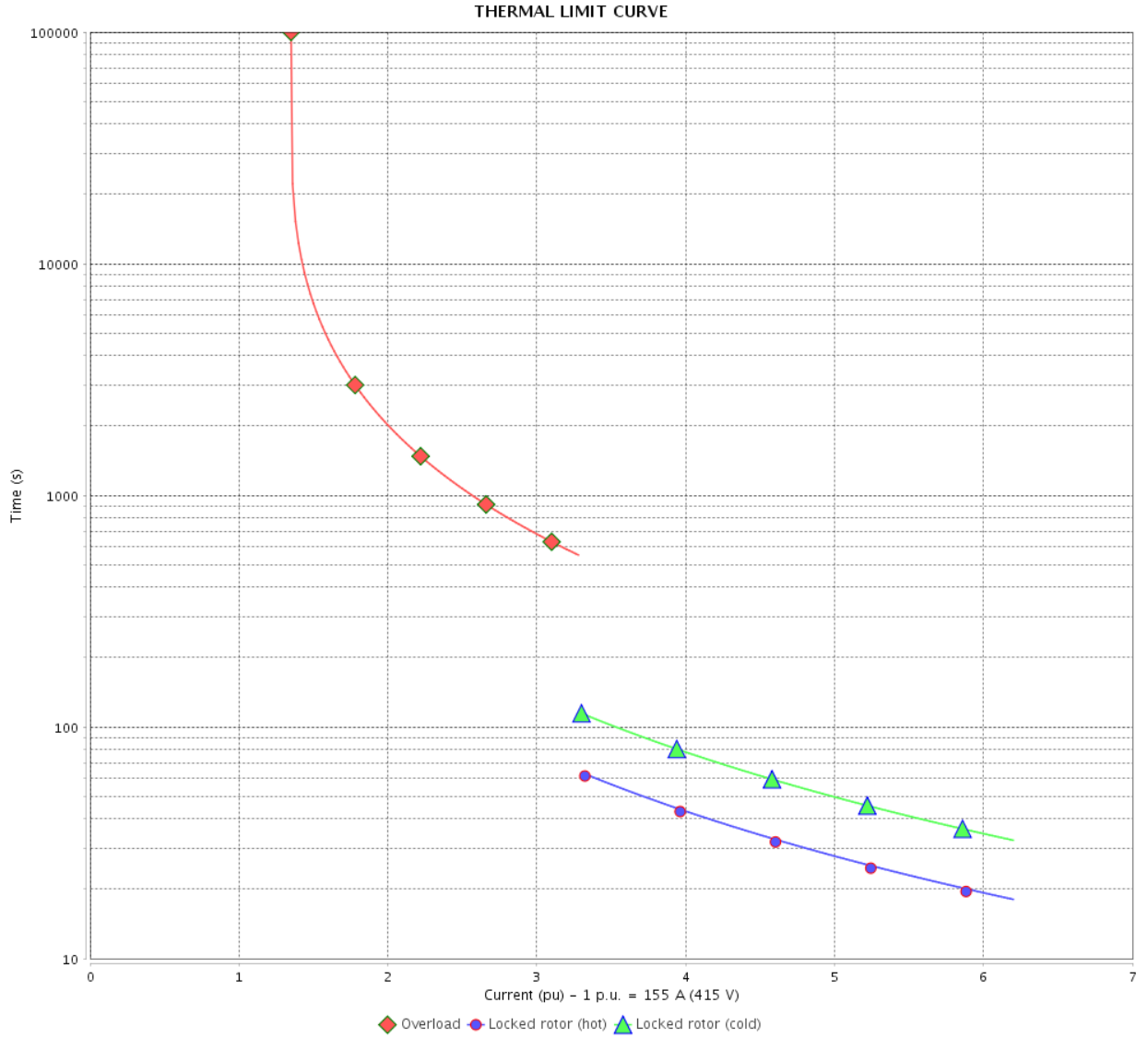

Rev.	Changes Summary	Performed	Checked	Date
Performed by		Page 29 / 36		Revision
Checked by				
Date				

VFD OPERATION CURVE

Three Phase Induction Motor - Squirrel Cage



Customer :

Product line : NEMA Premium Efficiency Three-Phase

Product code : 13273169

Catalog # : 12518ET3E444T-W22G

VFD OPERATION CURVE

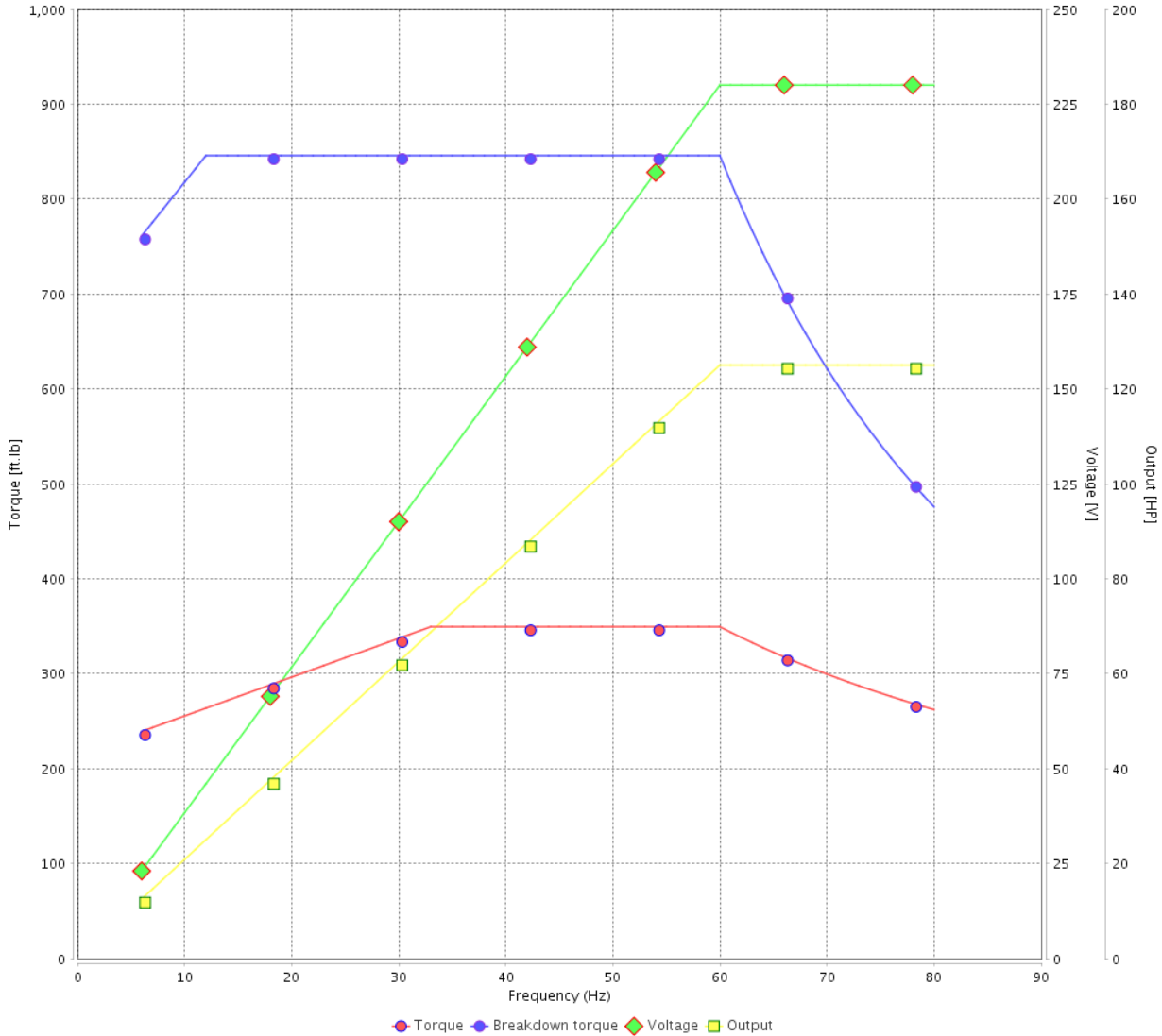

Performance : 230/460 V 60 Hz 4P

Rated current : 278/139 A
 LRC : 6.5
 Rated torque : 368 ft.lb
 Locked rotor torque : 200 %
 Breakdown torque : 229 %
 Rated speed : 1780 rpm

Moment of inertia (J) : 57.2 sq.ft.lb
 Duty cycle : Cont.(S1)
 Insulation class : F
 Service factor : 1.15
 Temperature rise : 80 K
 Design : B

Rev.	Changes Summary	Performed	Checked	Date
Performed by			Page 30 / 36	Revision
Checked by				
Date	13/04/2022			

VFD OPERATION CURVE

Three Phase Induction Motor - Squirrel Cage



Customer : _____

Product line : NEMA Premium Efficiency Three-Phase

Product code : 13273169

Catalog # : 12518ET3E444T-W22G

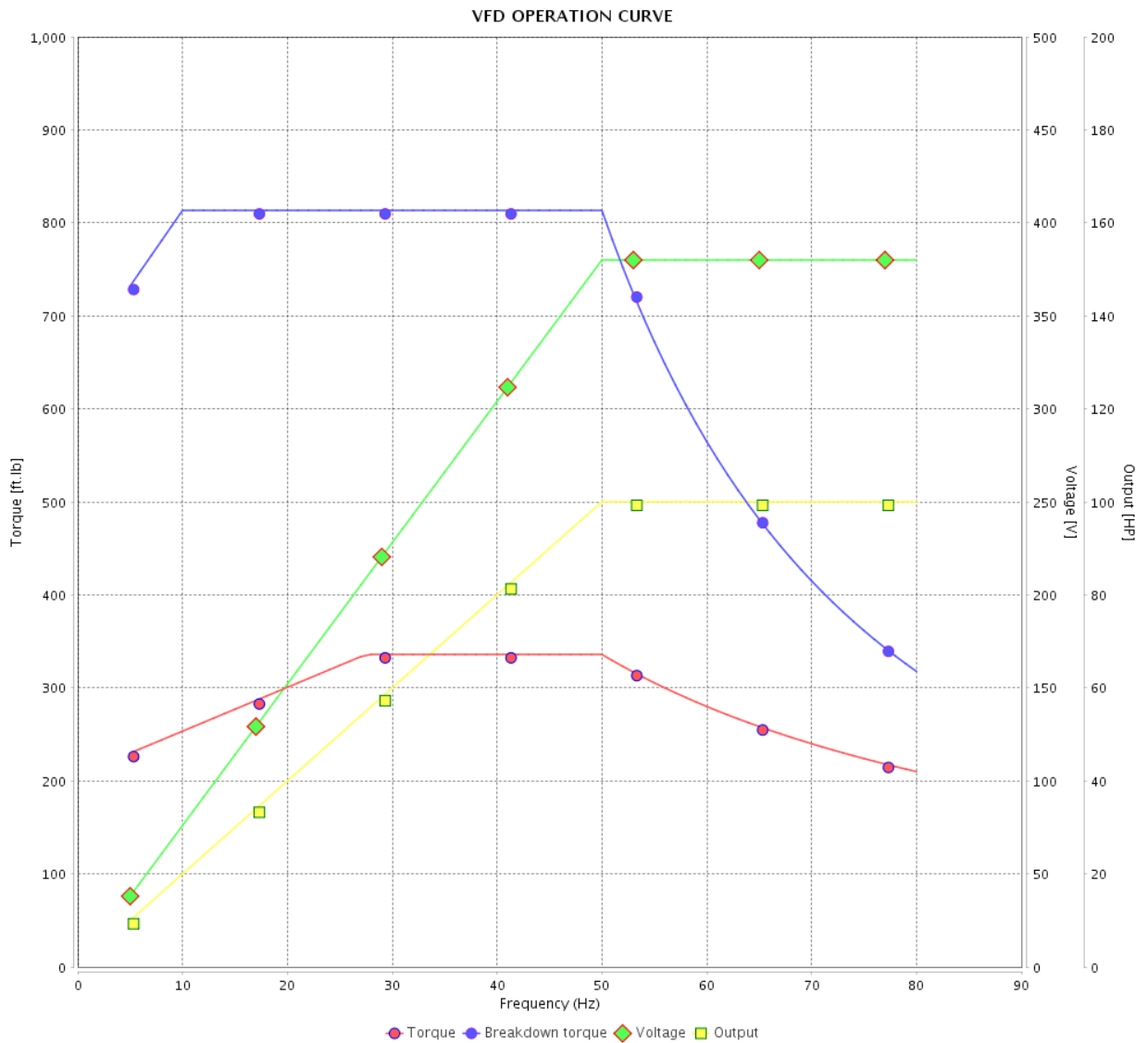

Performance : 380 V 50 Hz 4P IE3

Rated current : 139 A
 LRC : 6.4
 Rated torque : 354 ft.lb
 Locked rotor torque : 200 %
 Breakdown torque : 229 %
 Rated speed : 1480 rpm

Moment of inertia (J) : 57.2 sq.ft.lb
 Duty cycle : Cont.(S1)
 Insulation class : F
 Service factor : 1.00
 Temperature rise : 80 K
 Design : B

Rev.	Changes Summary	Performed	Checked	Date
Performed by			Page 31 / 36	Revision
Checked by				
Date	13/04/2022			

VFD OPERATION CURVE

Three Phase Induction Motor - Squirrel Cage



Customer : _____

Product line : NEMA Premium Efficiency Three-Phase

Product code : 13273169

Catalog # : 12518ET3E444T-W22G

VFD OPERATION CURVE

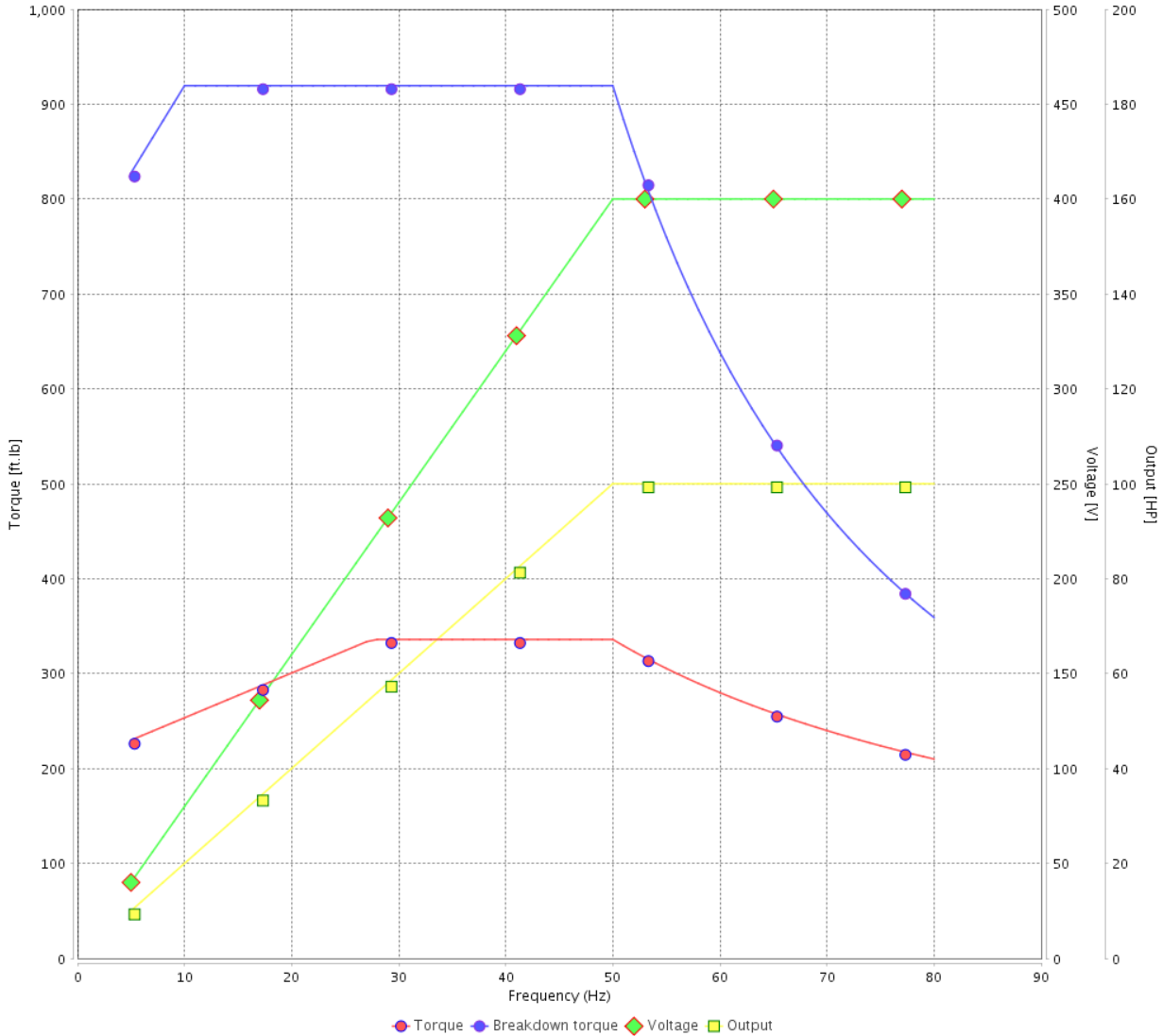

Performance : 400 V 50 Hz 4P IE3

Rated current : 136 A
 LRC : 7.0
 Rated torque : 354 ft.lb
 Locked rotor torque : 229 %
 Breakdown torque : 260 %
 Rated speed : 1480 rpm

Moment of inertia (J) : 57.2 sq.ft.lb
 Duty cycle : Cont.(S1)
 Insulation class : F
 Service factor : 1.00
 Temperature rise : 80 K
 Design : B

Rev.	Changes Summary	Performed	Checked	Date
Performed by			Page 32 / 36	Revision
Checked by				
Date	13/04/2022			

VFD OPERATION CURVE

Three Phase Induction Motor - Squirrel Cage



Customer :

Product line : NEMA Premium Efficiency Three-Phase

Product code : 13273169

Catalog # : 12518ET3E444T-W22G

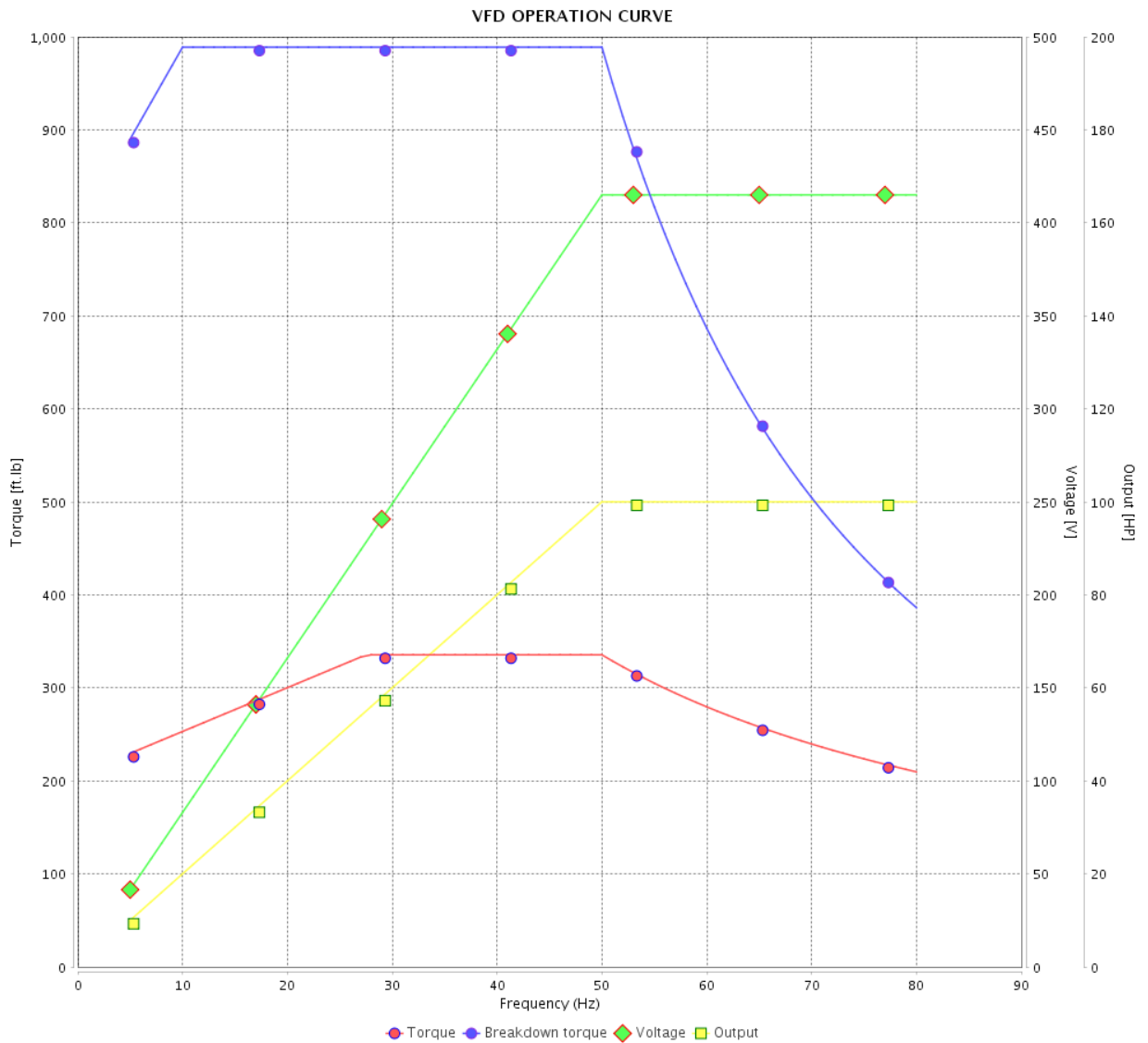

Performance : 415 V 50 Hz 4P IE3

Rated current : 132 A
 LRC : 7.6
 Rated torque : 353 ft.lb
 Locked rotor torque : 240 %
 Breakdown torque : 280 %
 Rated speed : 1485 rpm

Moment of inertia (J) : 57.2 sq.ft.lb
 Duty cycle : Cont.(S1)
 Insulation class : F
 Service factor : 1.00
 Temperature rise : 80 K
 Design : B

Rev.	Changes Summary	Performed	Checked	Date
Performed by		Page		Revision
Checked by		33 / 36		
Date	13/04/2022			

VFD OPERATION CURVE

Three Phase Induction Motor - Squirrel Cage



Customer :

Product line : NEMA Premium Efficiency Three-Phase

Product code : 13273169

Catalog # : 12518ET3E444T-W22G

VFD OPERATION CURVE

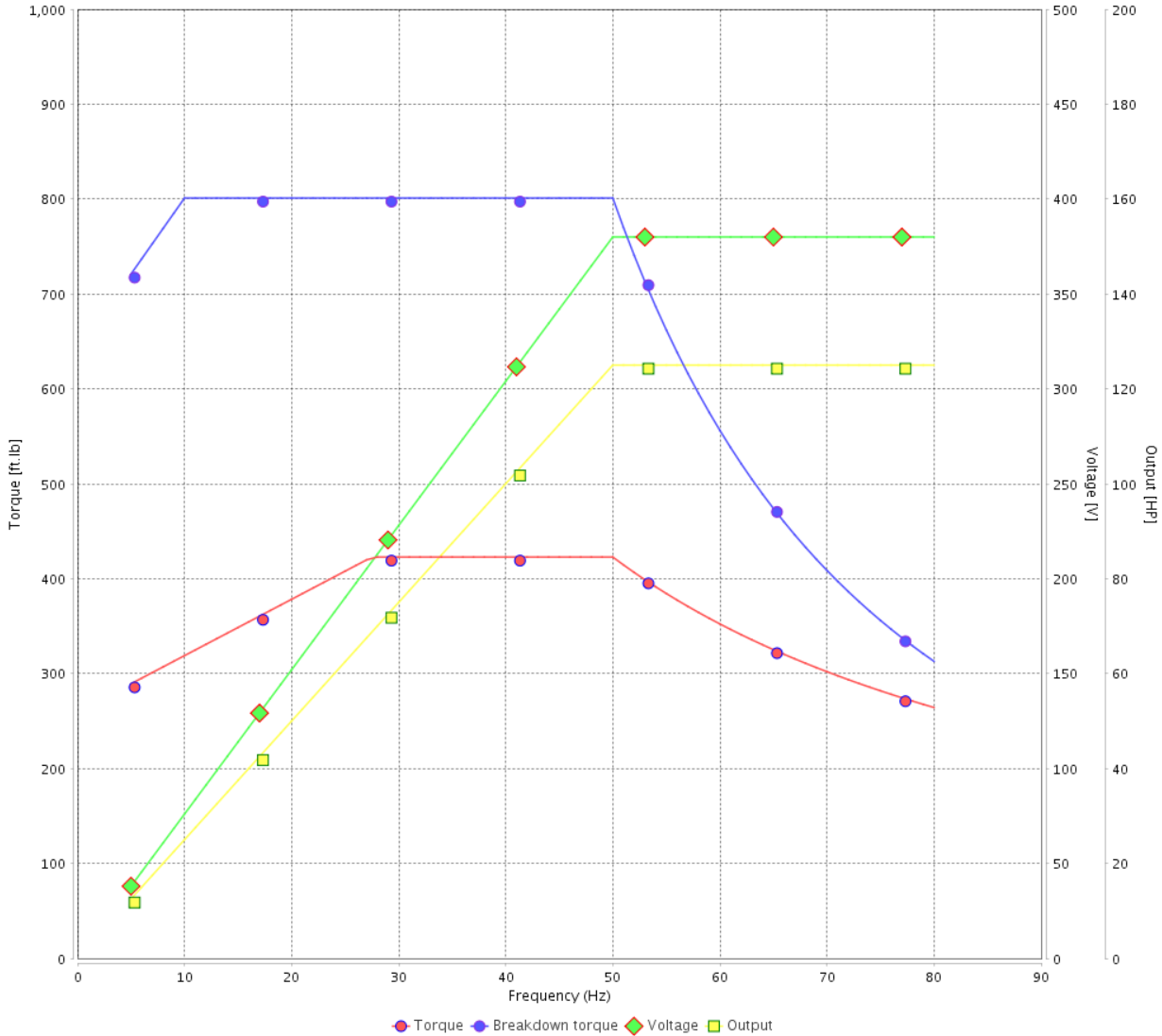

Performance : 380 V 50 Hz 4P IE2

Rated current	: 168 A	Moment of inertia (J)	: 57.2 sq.ft.lb
LRC	: 5.1	Duty cycle	: Cont.(S1)
Rated torque	: 445 ft.lb	Insulation class	: F
Locked rotor torque	: 160 %	Service factor	: 1.00
Breakdown torque	: 180 %	Temperature rise	: 80 K
Rated speed	: 1475 rpm	Design	: B

Rev.	Changes Summary	Performed	Checked	Date
Performed by			Page 34 / 36	Revision
Checked by				
Date	13/04/2022			

VFD OPERATION CURVE

Three Phase Induction Motor - Squirrel Cage



Customer : _____

Product line : NEMA Premium Efficiency Three-Phase

Product code : 13273169

Catalog # : 12518ET3E444T-W22G

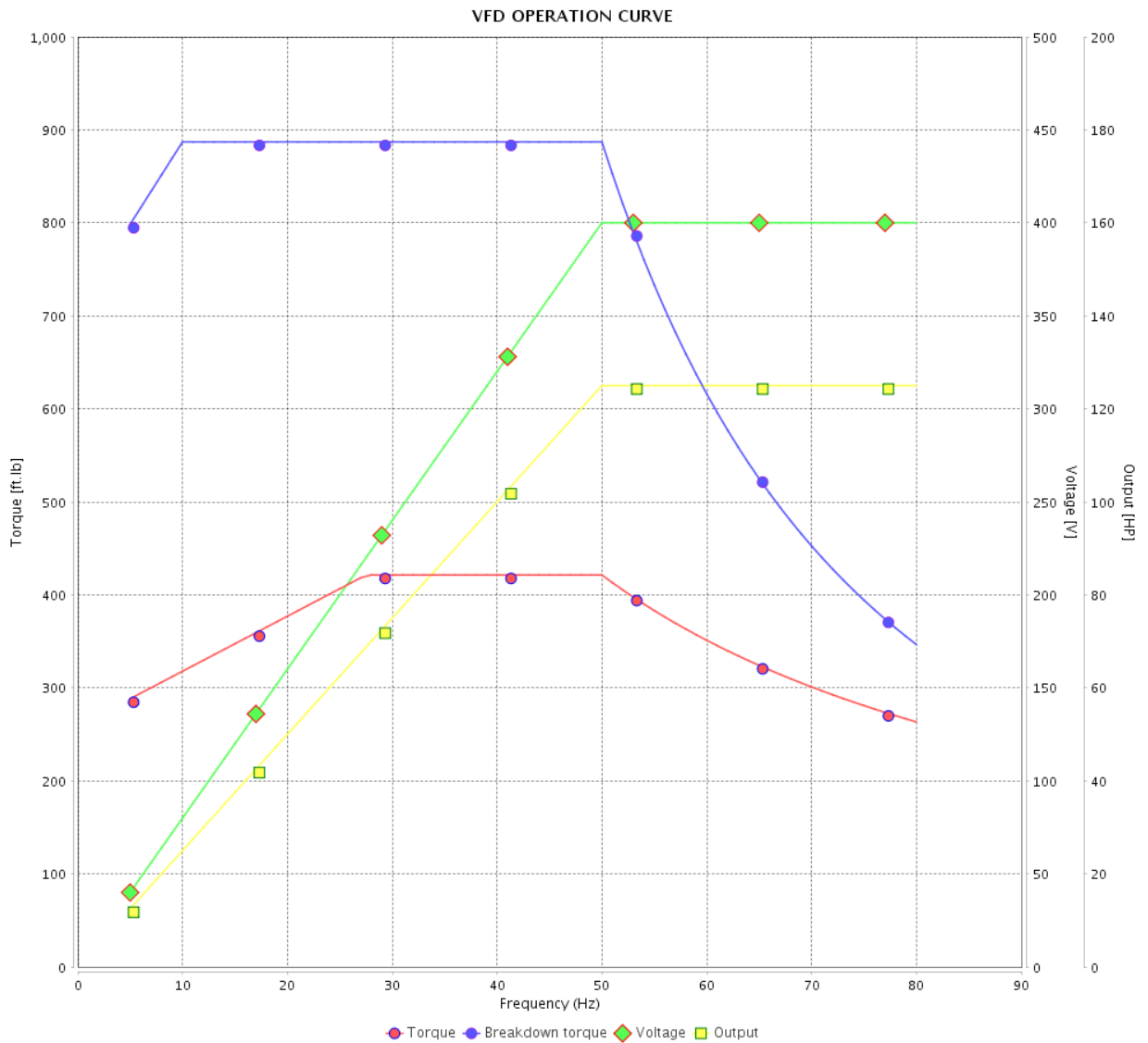

Performance : 400 V 50 Hz 4P IE2

Rated current : 160 A
 LRC : 5.7
 Rated torque : 444 ft.lb
 Locked rotor torque : 180 %
 Breakdown torque : 200 %
 Rated speed : 1475 rpm

Moment of inertia (J) : 57.2 sq.ft.lb
 Duty cycle : Cont.(S1)
 Insulation class : F
 Service factor : 1.00
 Temperature rise : 80 K
 Design : B

Rev.	Changes Summary	Performed	Checked	Date
Performed by			Page 35 / 36	Revision
Checked by				
Date	13/04/2022			

VFD OPERATION CURVE

Three Phase Induction Motor - Squirrel Cage



Customer :

Product line : NEMA Premium Efficiency Three-Phase

Product code : 13273169

Catalog # : 12518ET3E444T-W22G

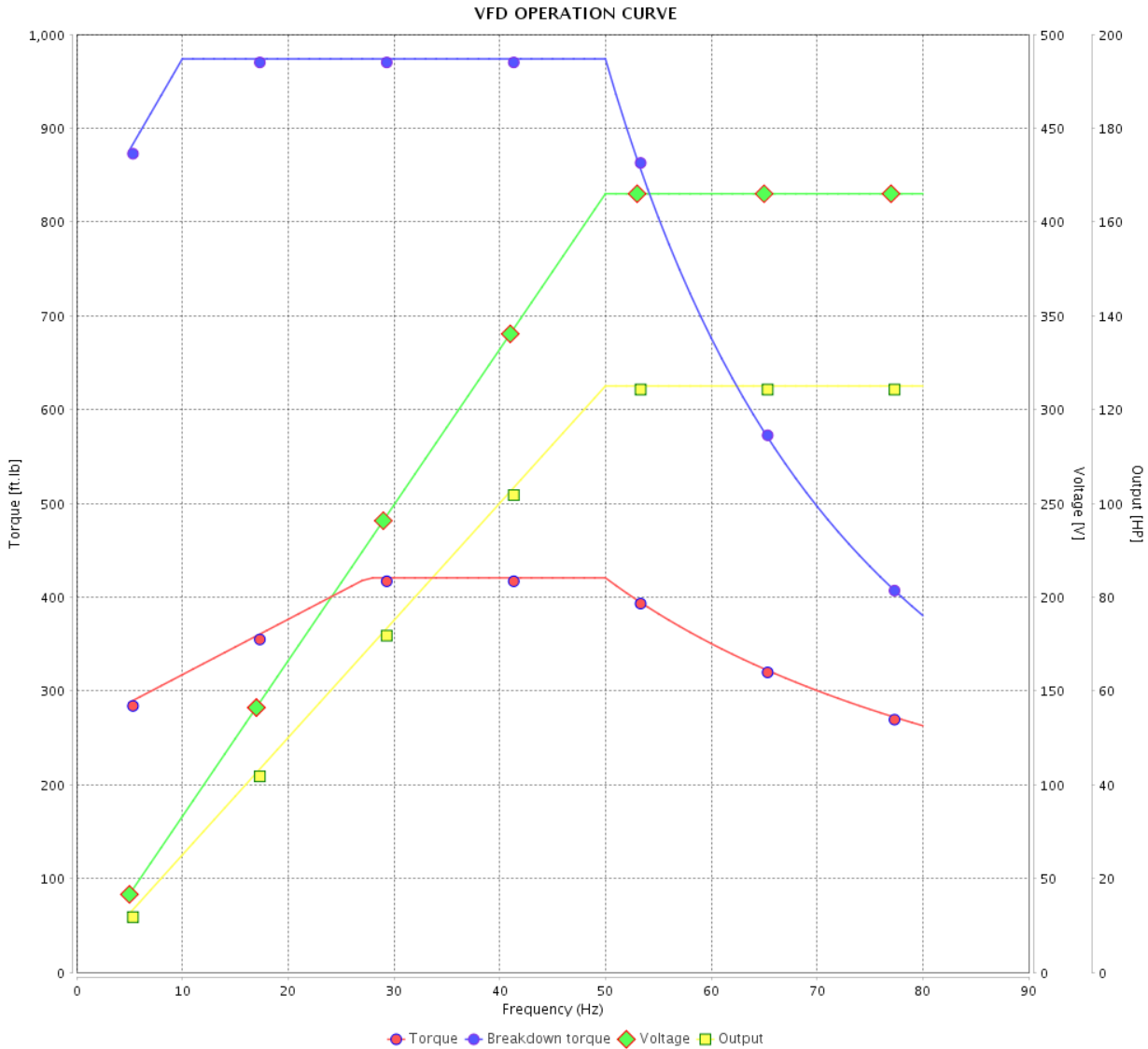

Performance : 415 V 50 Hz 4P IE2

Rated current : 155 A
 LRC : 6.2
 Rated torque : 443 ft.lb
 Locked rotor torque : 190 %
 Breakdown torque : 220 %
 Rated speed : 1480 rpm

Moment of inertia (J) : 57.2 sq.ft.lb
 Duty cycle : Cont.(S1)
 Insulation class : F
 Service factor : 1.00
 Temperature rise : 80 K
 Design : B

Rev.	Changes Summary	Performed	Checked	Date
Performed by			Page 36 / 36	Revision
Checked by				
Date	13/04/2022			

1 2 3 4 5 6

A

B

C

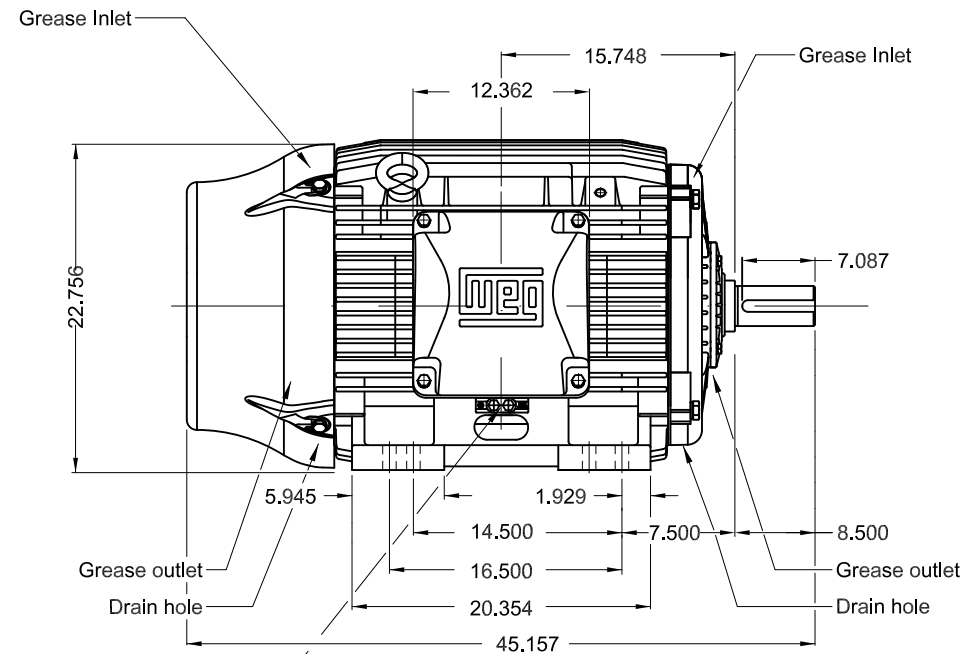
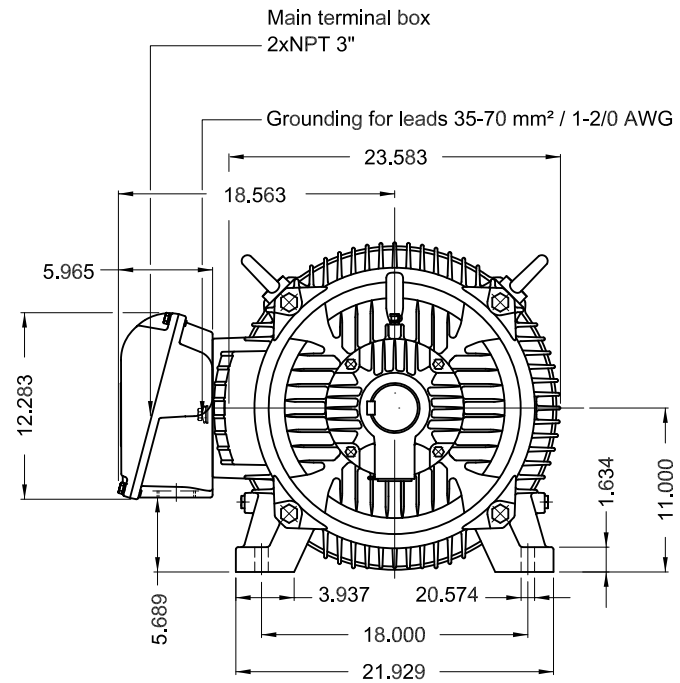

Grounding for leads 25-185 mm² / 3AWG-350MCM

D

E

- Internal AEGIS ground ring on the DE
- Color RAL 5009
- Painting plan 203A
- Mounting NEMA F-1
- Mounting B3R(D)

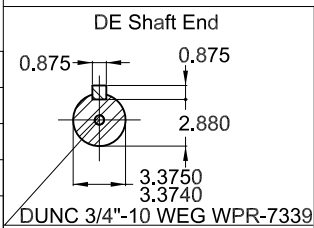

125 HP 04 Poles 60 Hz A

ECM	LOC	SUMMARY OF MODIFICATIONS	EXECUTED	CHECKED	RELEASED	DATE	VER
EXECUTED	PIRWBUSER	THREE PH. MOTOR W22 PREM. EFF.					
CHECKED		FRAME 444/5T IP55 TEFC					
RELEASED							
REL DT.	WMO	Jaragua do Sul	Product Engineering	SHEET	1 / 1		

PREVIEW
WDD





MODEL 12518ET3E444T-W22G

Inverter Duty Motor
Severe Duty



Mod.TE1BFOXON
CC029A

60Hz: For use on PWM: VT 1000:1,
CT 20:1, 1.00SF

MADE IN BRAZIL
13273169

PH3	60Hz	Fr. 444/5T	1000m.a.s.l.	IP55	TEFC	1548lb
V	230/460			A	278/139	
HP	125			kW	90	
SF	1.15			SFA	320/160	
RPM	1785			PF	0.85	
AMB	40°C			INS cl.	F DT80K	NEMA NOM EFF 95.4%
DUTY CONT.				DES B	Code G	
USABLE @208V	307A	SF 1.00				
125HP	90kW	50Hz	380V	168A	1475RPM	SF 1.00 EFF 94.5% (IE2)

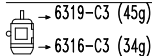
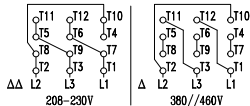

MOBIL POLYREX EM (8000h)

