

DATA SHEET



Three Phase Induction Motor - Squirrel Cage

Customer							
Product line		: NEMA Premium Efficiency Three-Phase		Product code :		12274312	
				Catalog # :		12518ET3G444TC-W22	
Frame		: 444/5TC		Cooling method		: IC411 - TEFC	
Insulation class		: F		Mounting		: F-1	
Duty cycle		: Cont.(S1)		Rotation ¹		: Both (CW and CCW)	
Ambient temperature		: -20°C to +40°C		Starting method		: Direct On Line	
Altitude		: 1000 m.a.s.l.		Approx. weight ²		: 1684 lb	
Protection degree		: IP55		Moment of inertia (J)		: 57.2 sq.ft.lb	
Design		: B					
Output [HP]	125	100	100	100	125	125	125
Poles	4	4	4	4	4	4	4
Frequency [Hz]	60	50	50	50	50	50	50
Rated voltage [V]	460	380	400	415	380	400	415
Rated current [A]	139	139	136	132	168	160	155
L. R. Amperes [A]	904	890	952	1003	857	912	961
LRC [A]	6.5x(Code G)	6.4x(Code G)	7.0x(Code H)	7.6x(Code J)	5.1x(Code E)	5.7x(Code F)	6.2x(Code F)
No load current [A]	40.0	40.0	43.0	45.0	40.0	43.0	45.0
Rated speed [RPM]	1780	1480	1480	1485	1475	1475	1480
Slip [%]	1.11	1.33	1.33	1.00	1.67	1.67	1.33
Rated torque [ft.lb]	368	354	354	353	445	444	443
Locked rotor torque [%]	200	200	229	240	160	180	190
Breakdown torque [%]	229	229	260	280	180	200	220
Service factor	1.15	1.00	1.00	1.00	1.00	1.00	1.00
Temperature rise	80 K	80 K	80 K	80 K	80 K	80 K	80 K
Locked rotor time	48s (cold)	32s (cold)	32s (cold)	32s (cold)	32s (cold)	32s (cold)	32s (cold)
	27s (hot)	18s (hot)	18s (hot)	18s (hot)	18s (hot)	18s (hot)	18s (hot)
Noise level ²	73.0 dB(A)	69.0 dB(A)	69.0 dB(A)	69.0 dB(A)	69.0 dB(A)	69.0 dB(A)	69.0 dB(A)
Efficiency (%)	25%	94.9	94.7	94.5	94.1	95.3	94.9
	50%	95.0	94.7	94.6	94.3	95.0	95.0
	75%	95.4	95.1	95.1	95.1	95.0	95.0
	100%	95.4	95.0	95.0	95.2	94.5	95.0
Power Factor	25%	0.52	0.50	0.47	0.44	0.58	0.52
	50%	0.74	0.73	0.69	0.67	0.79	0.74
	75%	0.82	0.82	0.80	0.78	0.85	0.82
	100%	0.85	0.86	0.84	0.83	0.86	0.85
Bearing type	: Drive end		: Non drive end		Foundation loads		
	: 6319 C3		: 6316 C3		Max. traction : 1759 lb		
	: WSeal		: WSeal		Max. compression : 3443 lb		
	: 8000 h		: 10000 h				
	: 45 g		: 34 g				
Lubricant type		: Mobil Polyrex EM					
Notes							
This revision replaces and cancel the previous one, which must be eliminated. (1) Looking the motor from the shaft end. (2) Measured at 1m and with tolerance of +3dB(A). (3) Approximate weight subject to changes after manufacturing process. (4) At 100% of full load.				These are average values based on tests with sinusoidal power supply, subject to the tolerances stipulated in NEMA MG-1.			
Rev.	Changes Summary			Performed	Checked	Date	
Performed by							
Checked by					Page	Revision	
Date	13/04/2022				1 / 36		

TORQUE AND CURRENT VS SPEED CURVE

Three Phase Induction Motor - Squirrel Cage



Customer :

Product line : NEMA Premium Efficiency Three-Phase

Product code : 12274312

Catalog # : 12518ET3G444TC-W22

TORQUE AND CURRENT VS SPEED CURVE

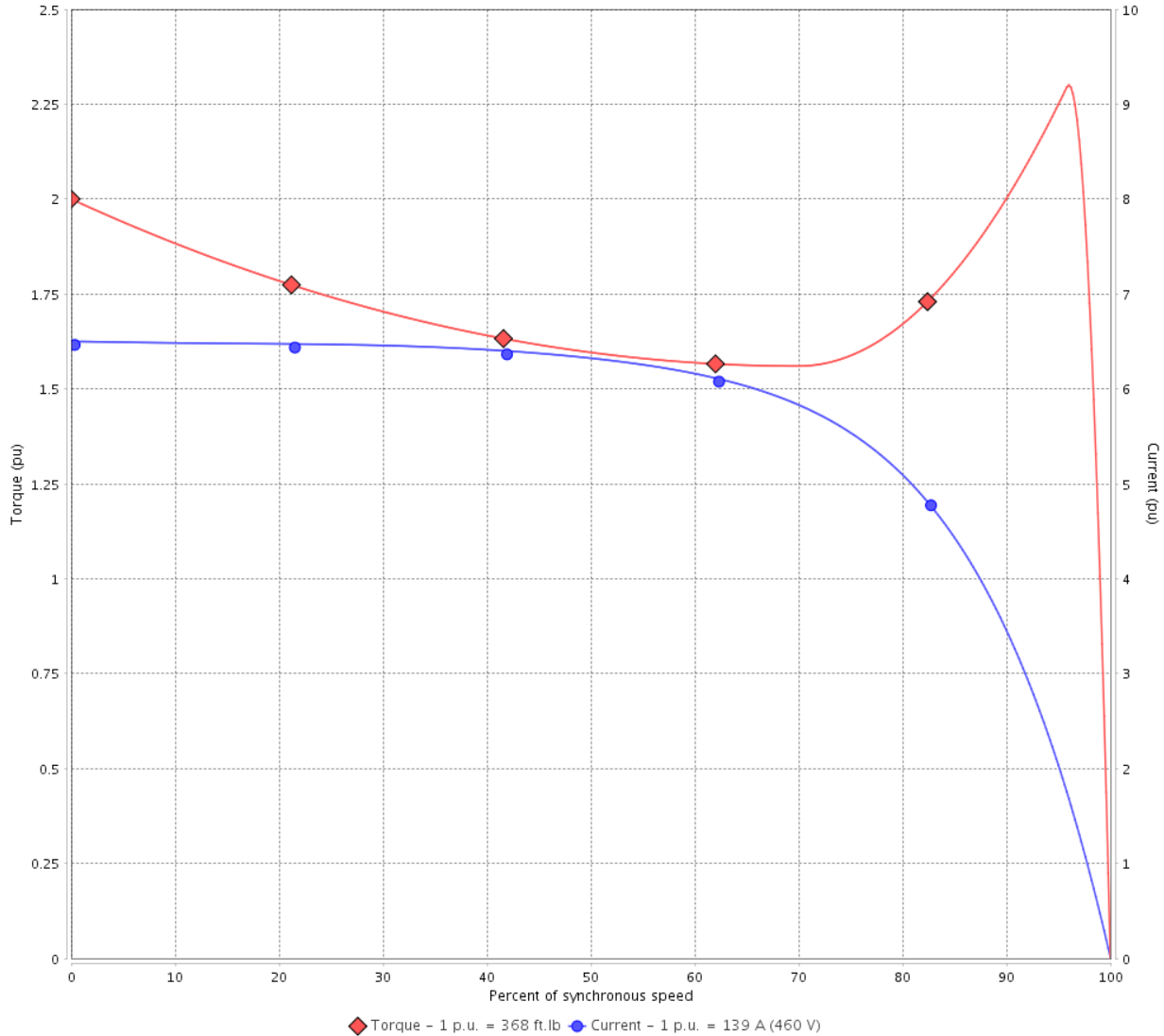

Performance : 460 V 60 Hz 4P

Rated current	: 139 A	Moment of inertia (J)	: 57.2 sq.ft.lb
LRC	: 6.5	Duty cycle	: Cont.(S1)
Rated torque	: 368 ft.lb	Insulation class	: F
Locked rotor torque	: 200 %	Service factor	: 1.15
Breakdown torque	: 229 %	Temperature rise	: 80 K
Rated speed	: 1780 rpm	Design	: B

Locked rotor time : 48s (cold) 27s (hot)

Rev.	Changes Summary	Performed	Checked	Date
Performed by			Page 2 / 36	Revision
Checked by				
Date	13/04/2022			

TORQUE AND CURRENT VS SPEED CURVE



Three Phase Induction Motor - Squirrel Cage

Customer :

Product line : NEMA Premium Efficiency Three-Phase

Product code : 12274312

Catalog # : 12518ET3G444TC-W22

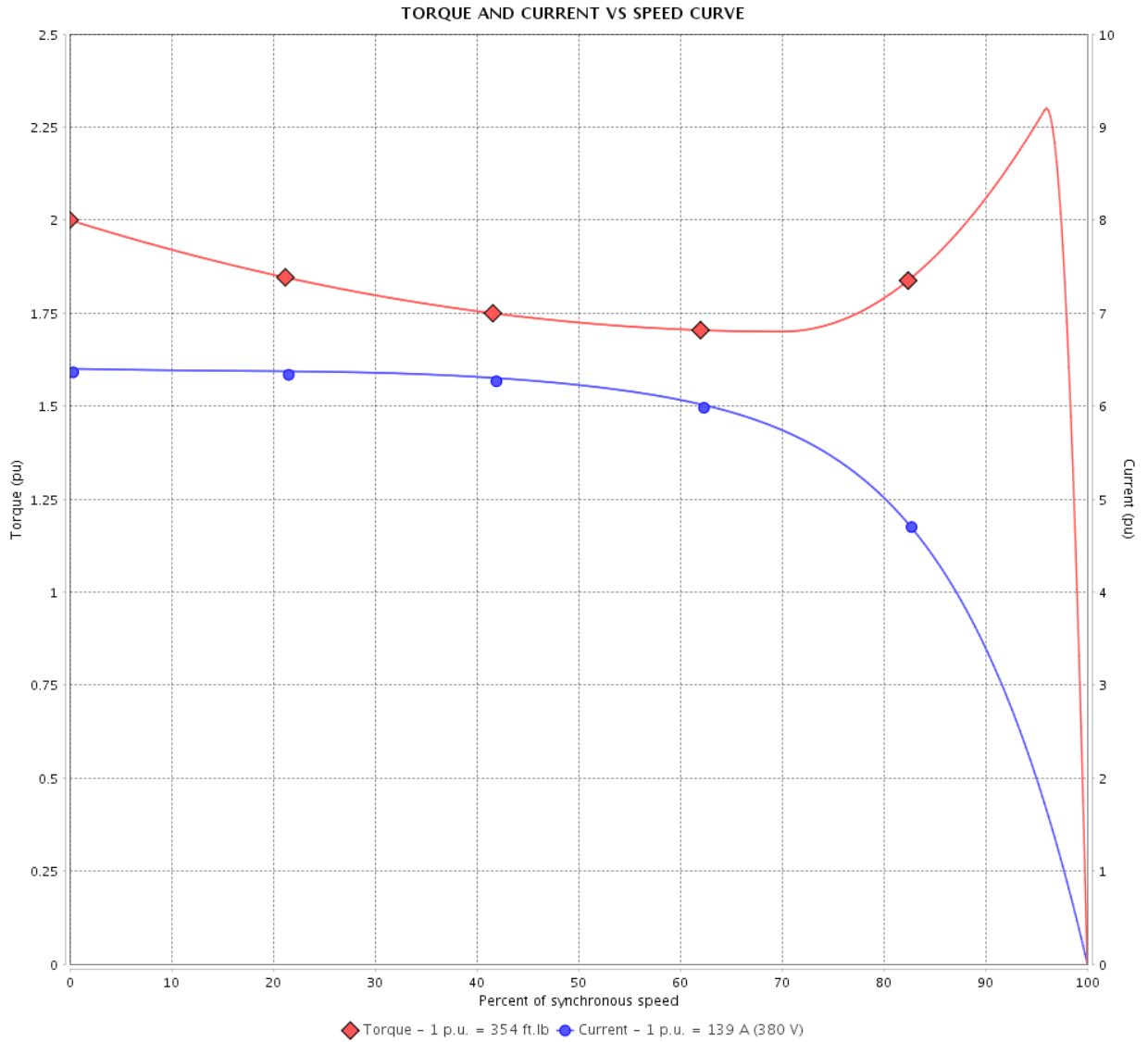

Performance : 380 V 50 Hz 4P IE3

Rated current	: 139 A	Moment of inertia (J)	: 57.2 sq.ft.lb
LRC	: 6.4	Duty cycle	: Cont.(S1)
Rated torque	: 354 ft.lb	Insulation class	: F
Locked rotor torque	: 200 %	Service factor	: 1.00
Breakdown torque	: 229 %	Temperature rise	: 80 K
Rated speed	: 1480 rpm	Design	: B

Locked rotor time : 32s (cold) 18s (hot)

Rev.	Changes Summary	Performed	Checked	Date
Performed by			Page 3 / 36	Revision
Checked by				
Date	13/04/2022			

TORQUE AND CURRENT VS SPEED CURVE

Three Phase Induction Motor - Squirrel Cage



Customer :

Product line : NEMA Premium Efficiency Three-Phase

Product code : 12274312

Catalog # : 12518ET3G444TC-W22

TORQUE AND CURRENT VS SPEED CURVE

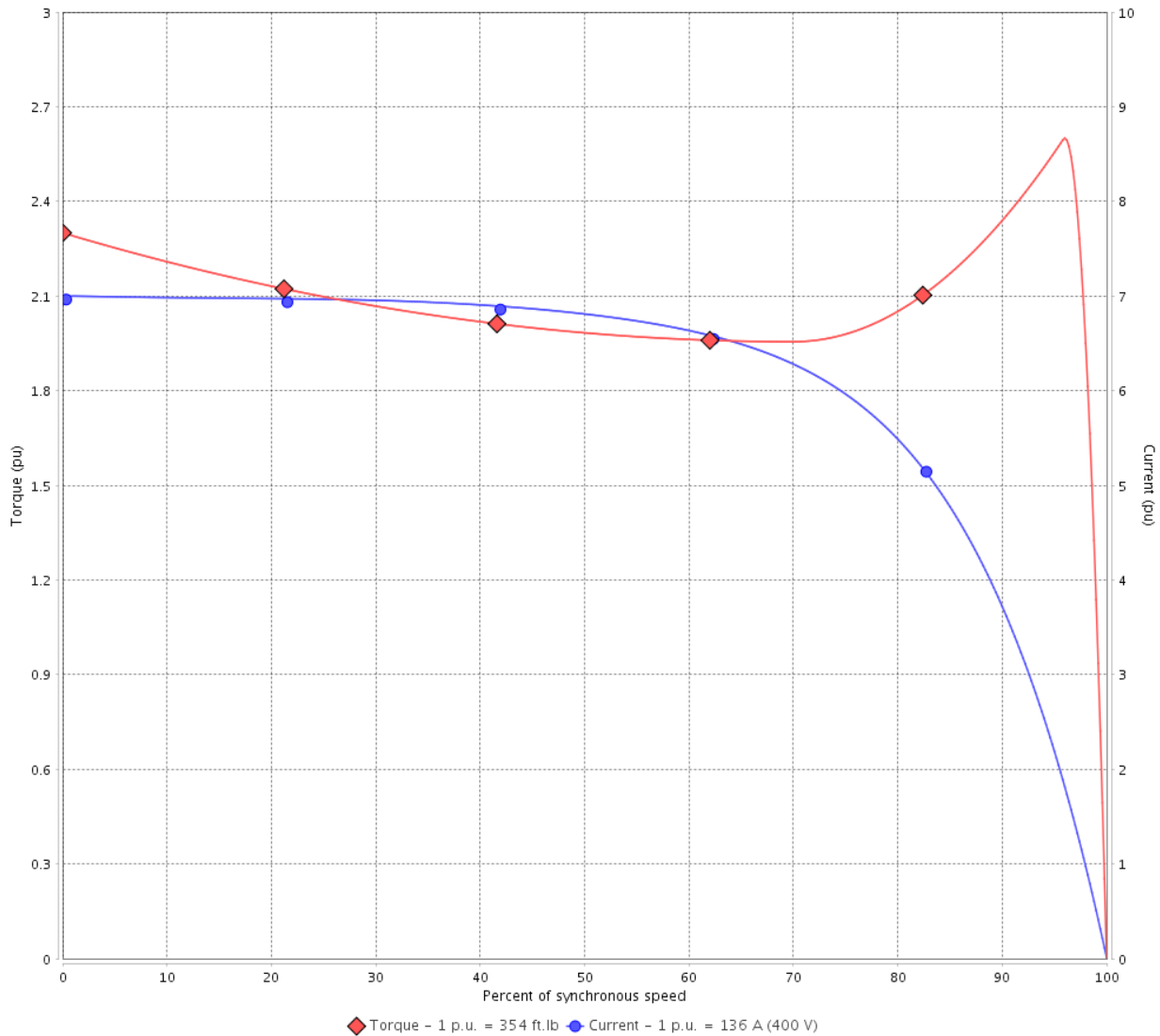

Performance : 400 V 50 Hz 4P IE3

Rated current	: 136 A	Moment of inertia (J)	: 57.2 sq.ft.lb
LRC	: 7.0	Duty cycle	: Cont.(S1)
Rated torque	: 354 ft.lb	Insulation class	: F
Locked rotor torque	: 229 %	Service factor	: 1.00
Breakdown torque	: 260 %	Temperature rise	: 80 K
Rated speed	: 1480 rpm	Design	: B

Locked rotor time : 32s (cold) 18s (hot)

Rev.	Changes Summary	Performed	Checked	Date
Performed by			Page 4 / 36	Revision
Checked by				
Date	13/04/2022			

TORQUE AND CURRENT VS SPEED CURVE



Three Phase Induction Motor - Squirrel Cage

Customer :

Product line : NEMA Premium Efficiency Three-Phase

Product code : 12274312

Catalog # : 12518ET3G444TC-W22

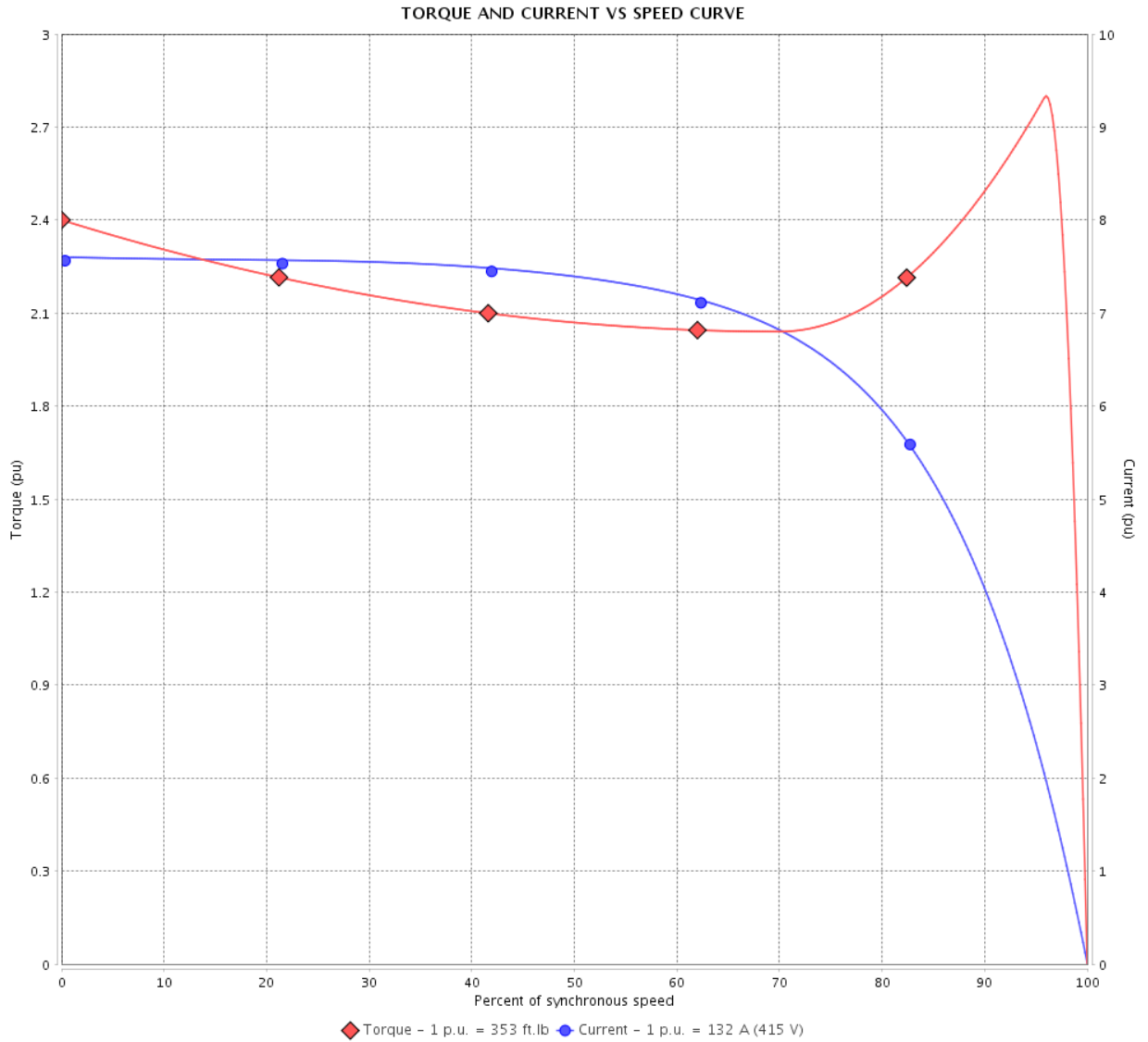

Performance : 415 V 50 Hz 4P IE3

Rated current	: 132 A	Moment of inertia (J)	: 57.2 sq.ft.lb
LRC	: 7.6	Duty cycle	: Cont.(S1)
Rated torque	: 353 ft.lb	Insulation class	: F
Locked rotor torque	: 240 %	Service factor	: 1.00
Breakdown torque	: 280 %	Temperature rise	: 80 K
Rated speed	: 1485 rpm	Design	: B

Locked rotor time : 32s (cold) 18s (hot)

Rev.	Changes Summary	Performed	Checked	Date
Performed by			Page 5 / 36	Revision
Checked by				
Date	13/04/2022			

TORQUE AND CURRENT VS SPEED CURVE

Three Phase Induction Motor - Squirrel Cage



Customer :

Product line : NEMA Premium Efficiency Three-Phase

Product code : 12274312

Catalog # : 12518ET3G444TC-W22

TORQUE AND CURRENT VS SPEED CURVE

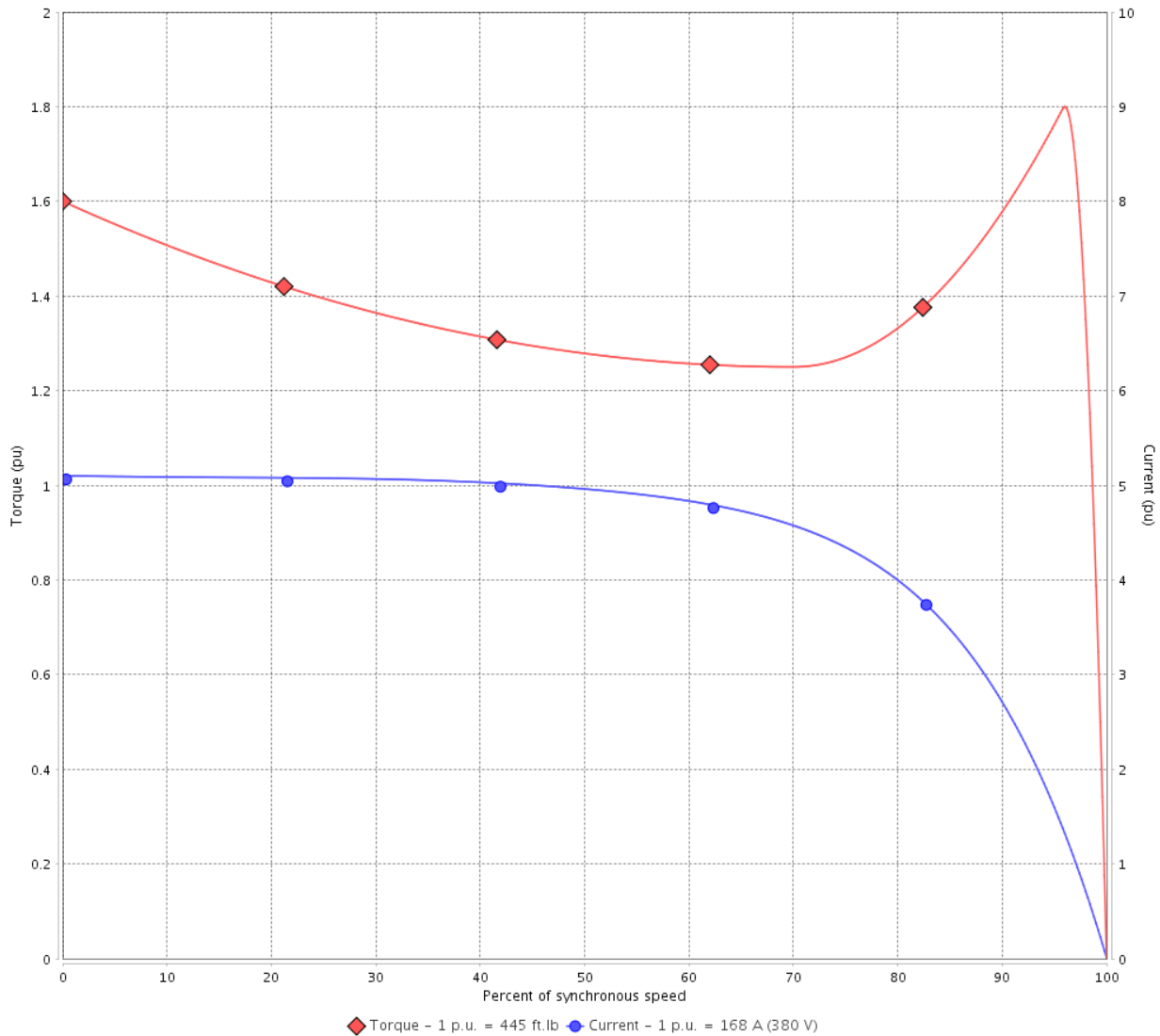

Performance : 380 V 50 Hz 4P IE2

Rated current	: 168 A	Moment of inertia (J)	: 57.2 sq.ft.lb
LRC	: 5.1	Duty cycle	: Cont.(S1)
Rated torque	: 445 ft.lb	Insulation class	: F
Locked rotor torque	: 160 %	Service factor	: 1.00
Breakdown torque	: 180 %	Temperature rise	: 80 K
Rated speed	: 1475 rpm	Design	: B

Locked rotor time : 32s (cold) 18s (hot)

Rev.	Changes Summary	Performed	Checked	Date
Performed by			Page 6 / 36	Revision
Checked by				
Date	13/04/2022			

TORQUE AND CURRENT VS SPEED CURVE



Three Phase Induction Motor - Squirrel Cage

Customer :

Product line : NEMA Premium Efficiency Three-Phase

Product code : 12274312

Catalog # : 12518ET3G444TC-W22

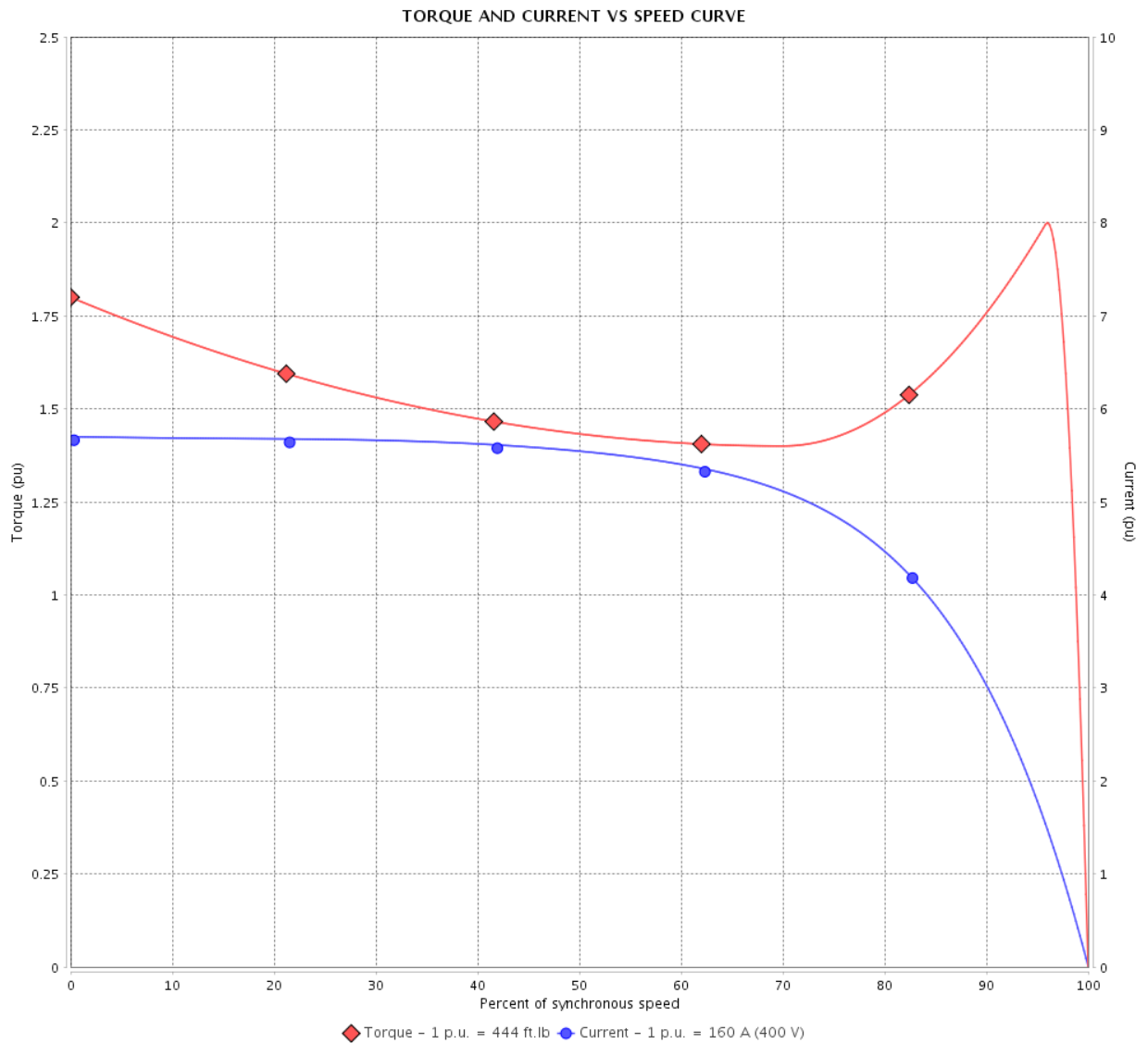

Performance : 400 V 50 Hz 4P IE2

Rated current	: 160 A	Moment of inertia (J)	: 57.2 sq.ft.lb
LRC	: 5.7	Duty cycle	: Cont.(S1)
Rated torque	: 444 ft.lb	Insulation class	: F
Locked rotor torque	: 180 %	Service factor	: 1.00
Breakdown torque	: 200 %	Temperature rise	: 80 K
Rated speed	: 1475 rpm	Design	: B

Locked rotor time : 32s (cold) 18s (hot)

Rev.	Changes Summary	Performed	Checked	Date
Performed by			Page 7 / 36	Revision
Checked by				
Date	13/04/2022			

TORQUE AND CURRENT VS SPEED CURVE

Three Phase Induction Motor - Squirrel Cage



Customer :

Product line : NEMA Premium Efficiency Three-Phase

Product code : 12274312

Catalog # : 12518ET3G444TC-W22

TORQUE AND CURRENT VS SPEED CURVE

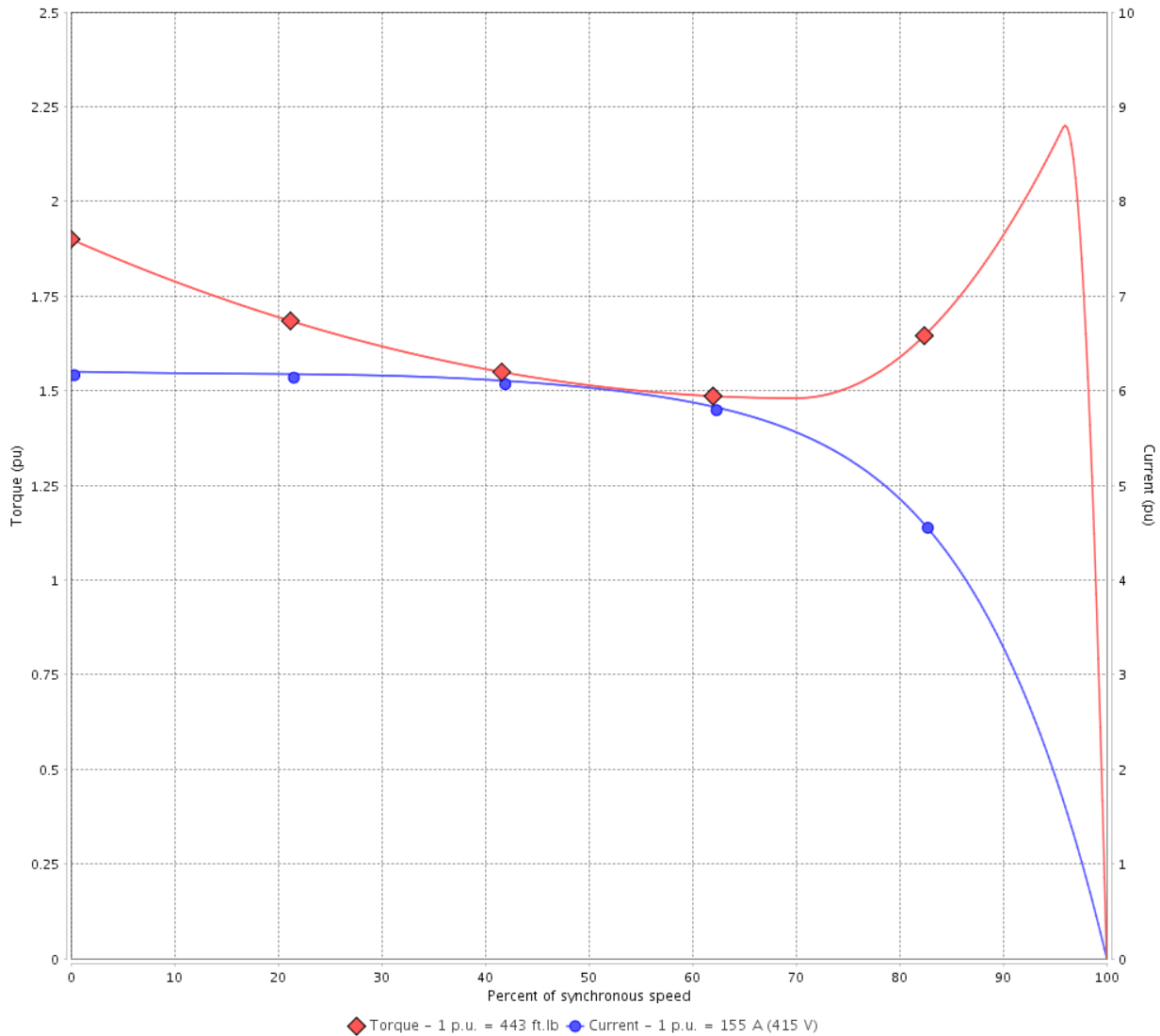

Performance : 415 V 50 Hz 4P IE2

Rated current	: 155 A	Moment of inertia (J)	: 57.2 sq.ft.lb
LRC	: 6.2	Duty cycle	: Cont.(S1)
Rated torque	: 443 ft.lb	Insulation class	: F
Locked rotor torque	: 190 %	Service factor	: 1.00
Breakdown torque	: 220 %	Temperature rise	: 80 K
Rated speed	: 1480 rpm	Design	: B

Locked rotor time : 32s (cold) 18s (hot)

Rev.	Changes Summary	Performed	Checked	Date
Performed by			Page 8 / 36	Revision
Checked by				
Date	13/04/2022			

LOAD PERFORMANCE CURVE

Three Phase Induction Motor - Squirrel Cage



Customer :

Product line : NEMA Premium Efficiency Three-Phase

Product code : 12274312

Catalog # : 12518ET3G444TC-W22

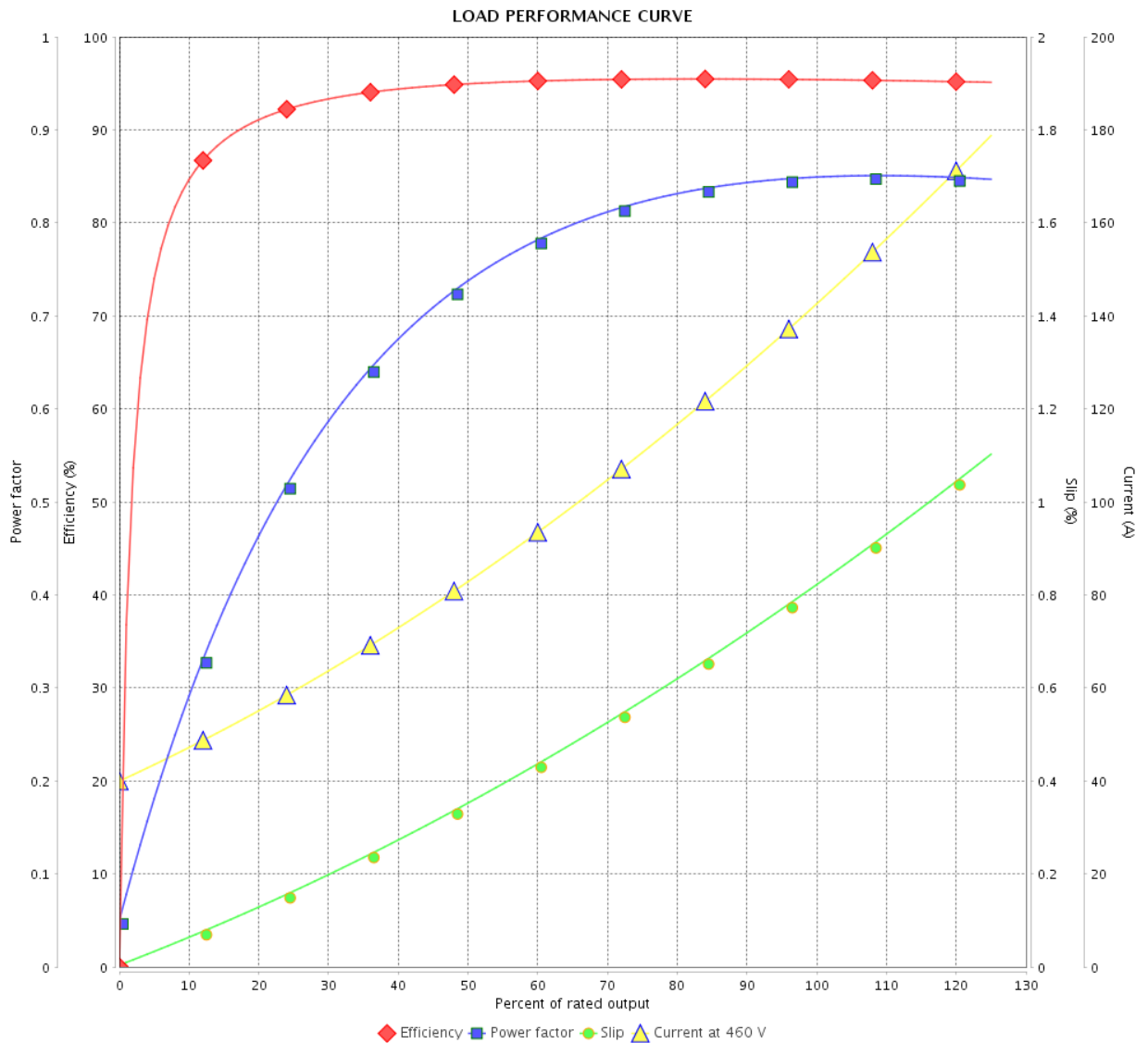

Performance : 460 V 60 Hz 4P

Rated current : 139 A
 LRC : 6.5
 Rated torque : 368 ft.lb
 Locked rotor torque : 200 %
 Breakdown torque : 229 %
 Rated speed : 1780 rpm

Moment of inertia (J) : 57.2 sq.ft.lb
 Duty cycle : Cont.(S1)
 Insulation class : F
 Service factor : 1.15
 Temperature rise : 80 K
 Design : B

Rev.	Changes Summary	Performed	Checked	Date
Performed by			Page	Revision
Checked by			9 / 36	
Date	13/04/2022			

LOAD PERFORMANCE CURVE

Three Phase Induction Motor - Squirrel Cage



Customer :

Product line : NEMA Premium Efficiency Three-Phase

Product code : 12274312

Catalog # : 12518ET3G444TC-W22

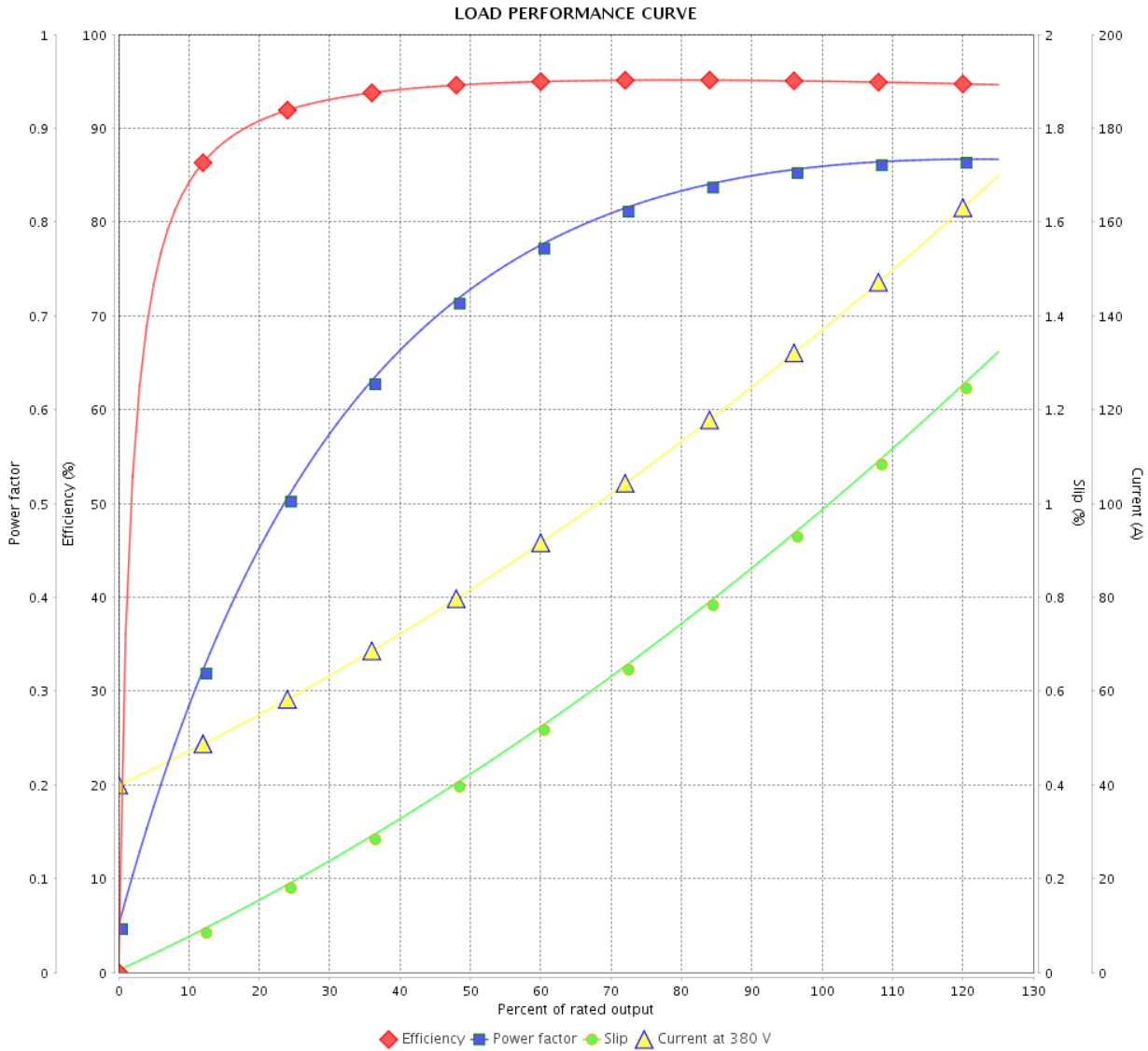

Performance : 380 V 50 Hz 4P IE3

Rated current	: 139 A	Moment of inertia (J)	: 57.2 sq.ft.lb
LRC	: 6.4	Duty cycle	: Cont.(S1)
Rated torque	: 354 ft.lb	Insulation class	: F
Locked rotor torque	: 200 %	Service factor	: 1.00
Breakdown torque	: 229 %	Temperature rise	: 80 K
Rated speed	: 1480 rpm	Design	: B

Rev.	Changes Summary	Performed	Checked	Date
Performed by			Page 10 / 36	Revision
Checked by				
Date	13/04/2022			

LOAD PERFORMANCE CURVE

Three Phase Induction Motor - Squirrel Cage



Customer :

Product line : NEMA Premium Efficiency Three-Phase

Product code : 12274312

Catalog # : 12518ET3G444TC-W22

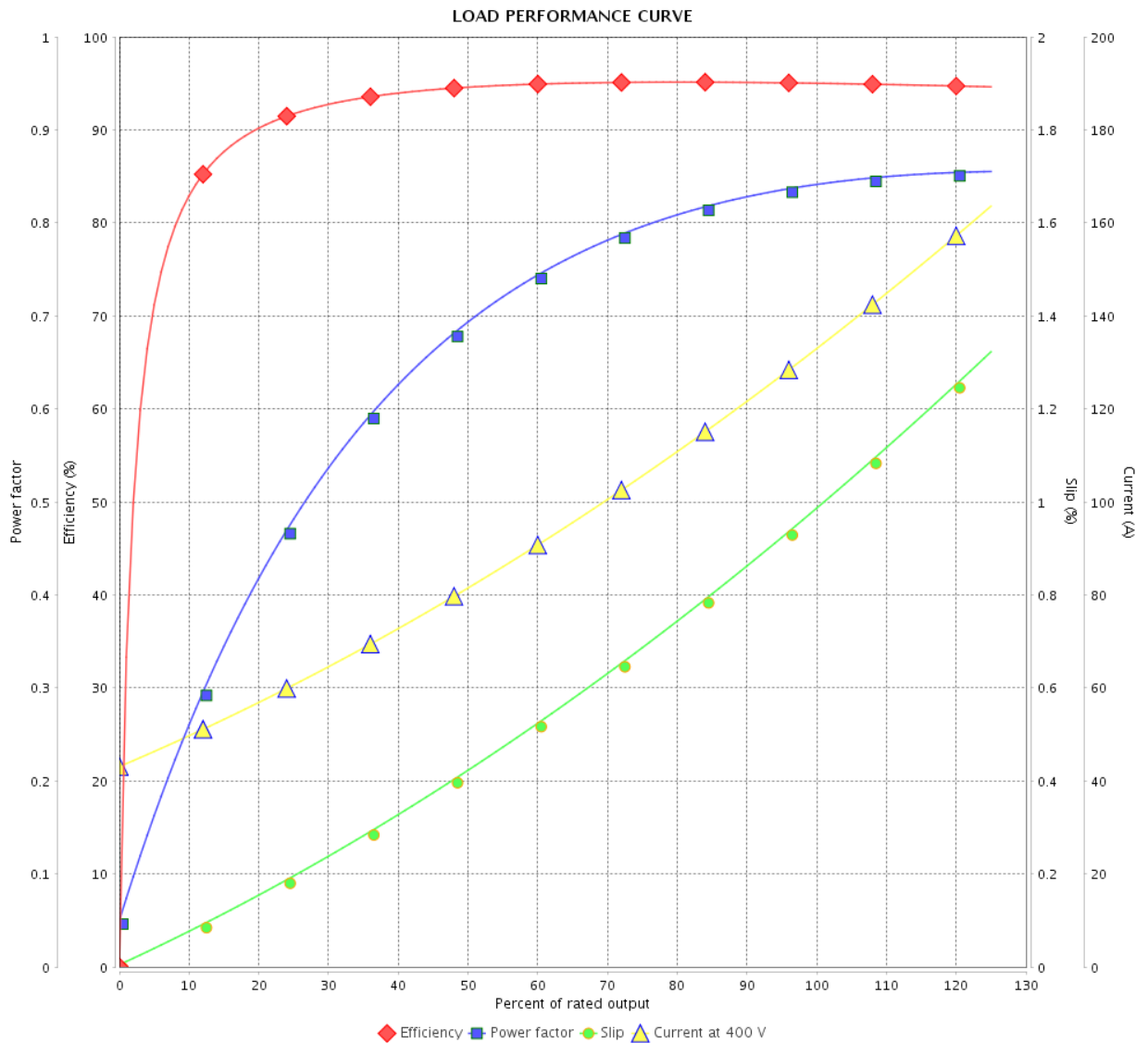

Performance : 400 V 50 Hz 4P IE3

Rated current : 136 A
 LRC : 7.0
 Rated torque : 354 ft.lb
 Locked rotor torque : 229 %
 Breakdown torque : 260 %
 Rated speed : 1480 rpm

Moment of inertia (J) : 57.2 sq.ft.lb
 Duty cycle : Cont.(S1)
 Insulation class : F
 Service factor : 1.00
 Temperature rise : 80 K
 Design : B

Rev.	Changes Summary	Performed	Checked	Date
Performed by		Page		Revision
Checked by		11 / 36		
Date		13/04/2022		

LOAD PERFORMANCE CURVE

Three Phase Induction Motor - Squirrel Cage



Customer :

Product line : NEMA Premium Efficiency Three-Phase

Product code : 12274312

Catalog # : 12518ET3G444TC-W22

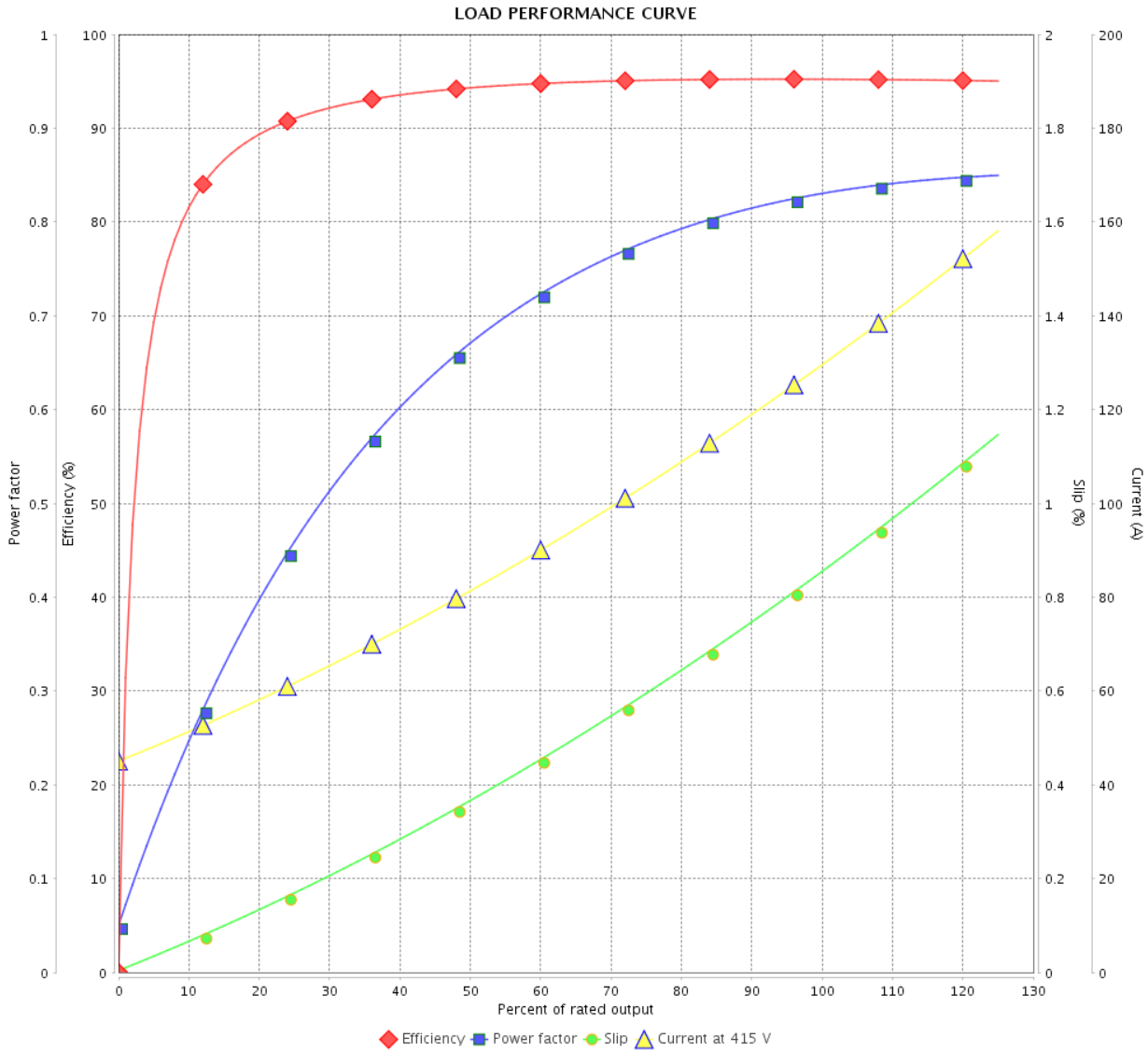

Performance : 415 V 50 Hz 4P IE3

Rated current	: 132 A	Moment of inertia (J)	: 57.2 sq.ft.lb
LRC	: 7.6	Duty cycle	: Cont.(S1)
Rated torque	: 353 ft.lb	Insulation class	: F
Locked rotor torque	: 240 %	Service factor	: 1.00
Breakdown torque	: 280 %	Temperature rise	: 80 K
Rated speed	: 1485 rpm	Design	: B

Rev.	Changes Summary	Performed	Checked	Date
Performed by			Page	Revision
Checked by			12 / 36	
Date	13/04/2022			

LOAD PERFORMANCE CURVE

Three Phase Induction Motor - Squirrel Cage



Customer : _____

Product line : NEMA Premium Efficiency Three-Phase

Product code : 12274312

Catalog # : 12518ET3G444TC-W22

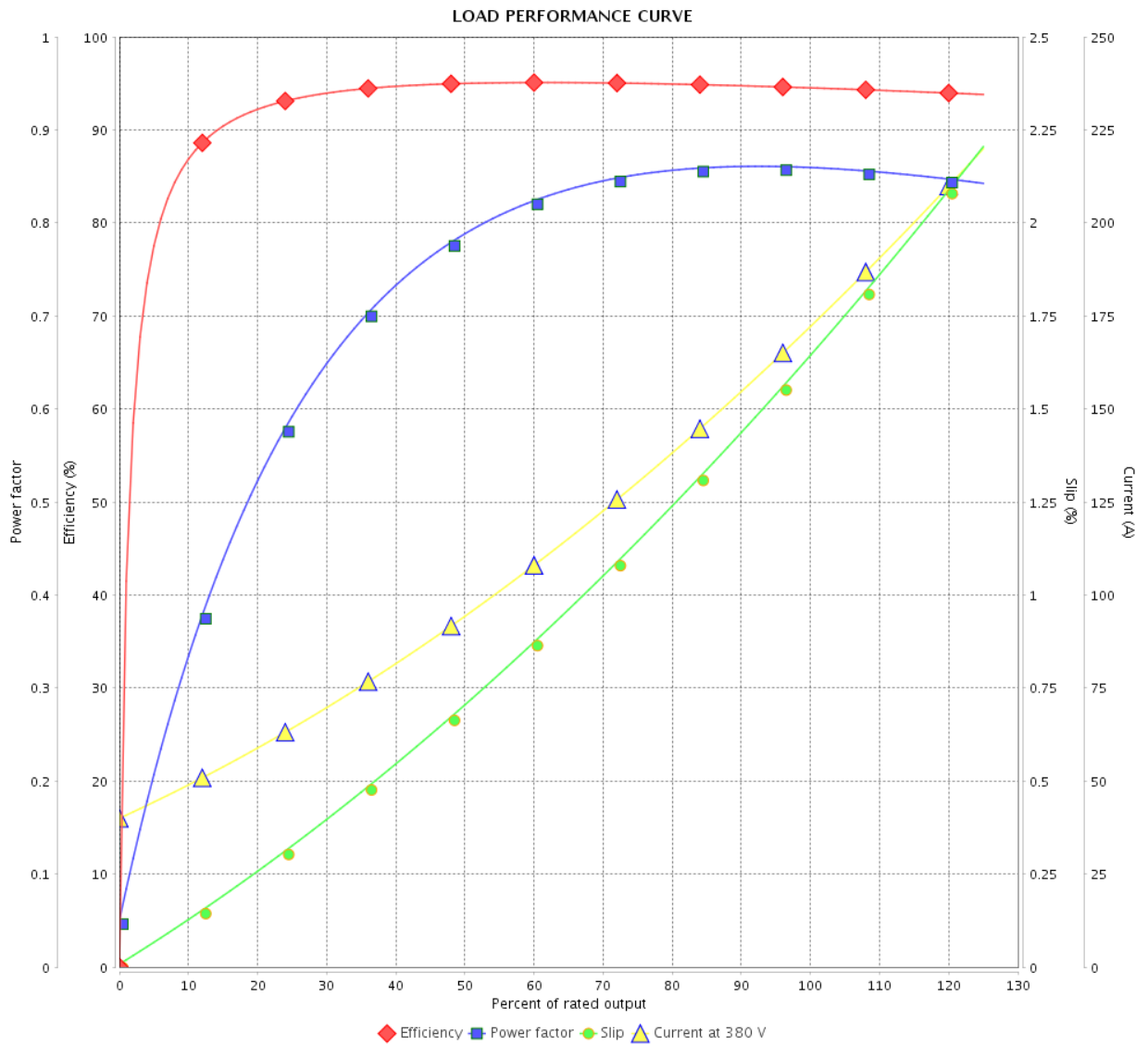

Performance : 380 V 50 Hz 4P IE2

Rated current : 168 A
 LRC : 5.1
 Rated torque : 445 ft.lb
 Locked rotor torque : 160 %
 Breakdown torque : 180 %
 Rated speed : 1475 rpm

Moment of inertia (J) : 57.2 sq.ft.lb
 Duty cycle : Cont.(S1)
 Insulation class : F
 Service factor : 1.00
 Temperature rise : 80 K
 Design : B

Rev.	Changes Summary	Performed	Checked	Date
Performed by		Page		Revision
Checked by		13 / 36		
Date		13 / 04 / 2022		

LOAD PERFORMANCE CURVE

Three Phase Induction Motor - Squirrel Cage



Customer : _____

Product line : NEMA Premium Efficiency Three-Phase

Product code : 12274312

Catalog # : 12518ET3G444TC-W22

LOAD PERFORMANCE CURVE

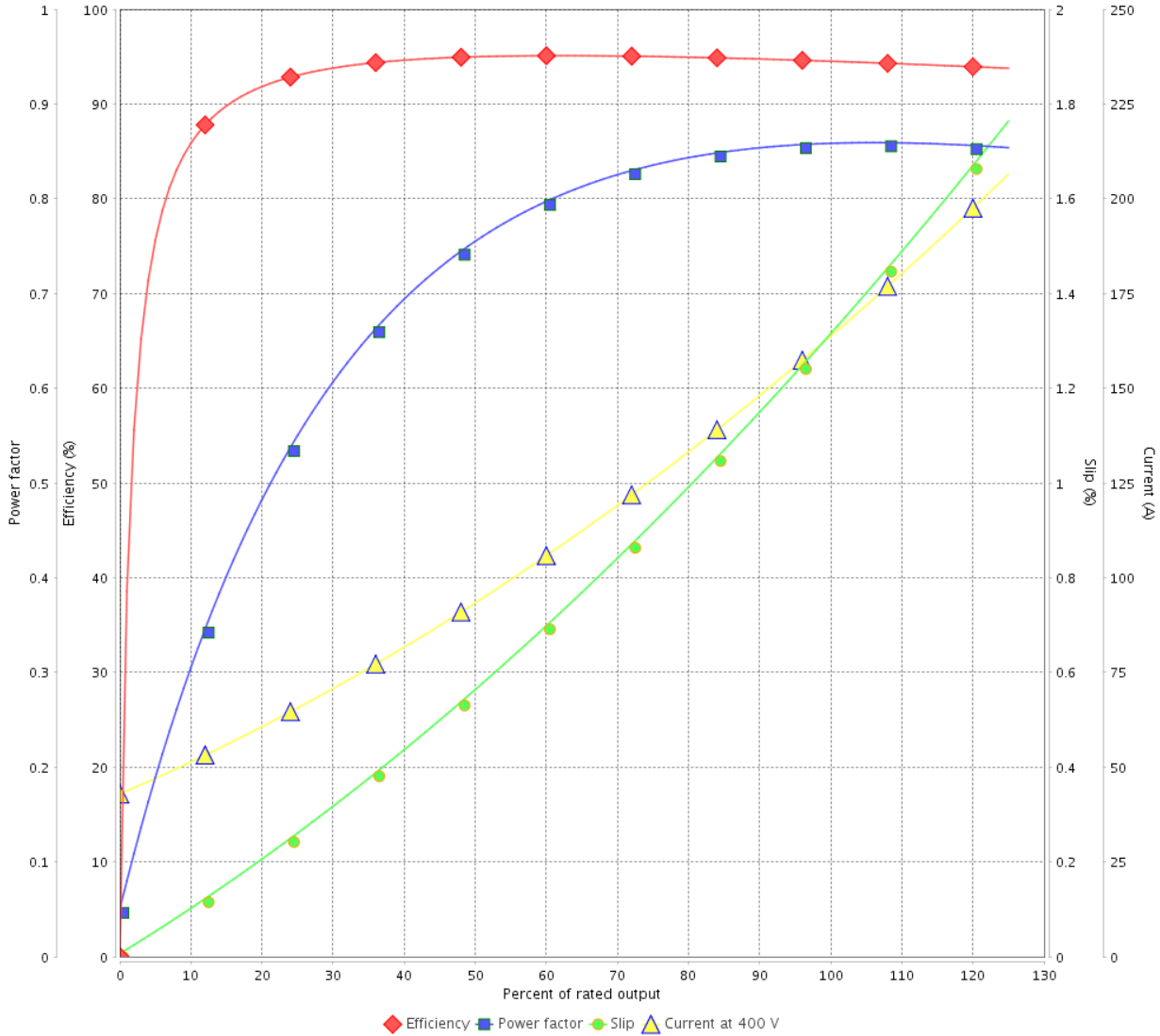

Performance : 400 V 50 Hz 4P IE2

Rated current	: 160 A	Moment of inertia (J)	: 57.2 sq.ft.lb
LRC	: 5.7	Duty cycle	: Cont.(S1)
Rated torque	: 444 ft.lb	Insulation class	: F
Locked rotor torque	: 180 %	Service factor	: 1.00
Breakdown torque	: 200 %	Temperature rise	: 80 K
Rated speed	: 1475 rpm	Design	: B

Rev.	Changes Summary	Performed	Checked	Date
Performed by		Page		Revision
Checked by		14 / 36		
Date	13/04/2022			

LOAD PERFORMANCE CURVE

Three Phase Induction Motor - Squirrel Cage



Customer : _____

Product line : NEMA Premium Efficiency Three-Phase

Product code : 12274312

Catalog # : 12518ET3G444TC-W22

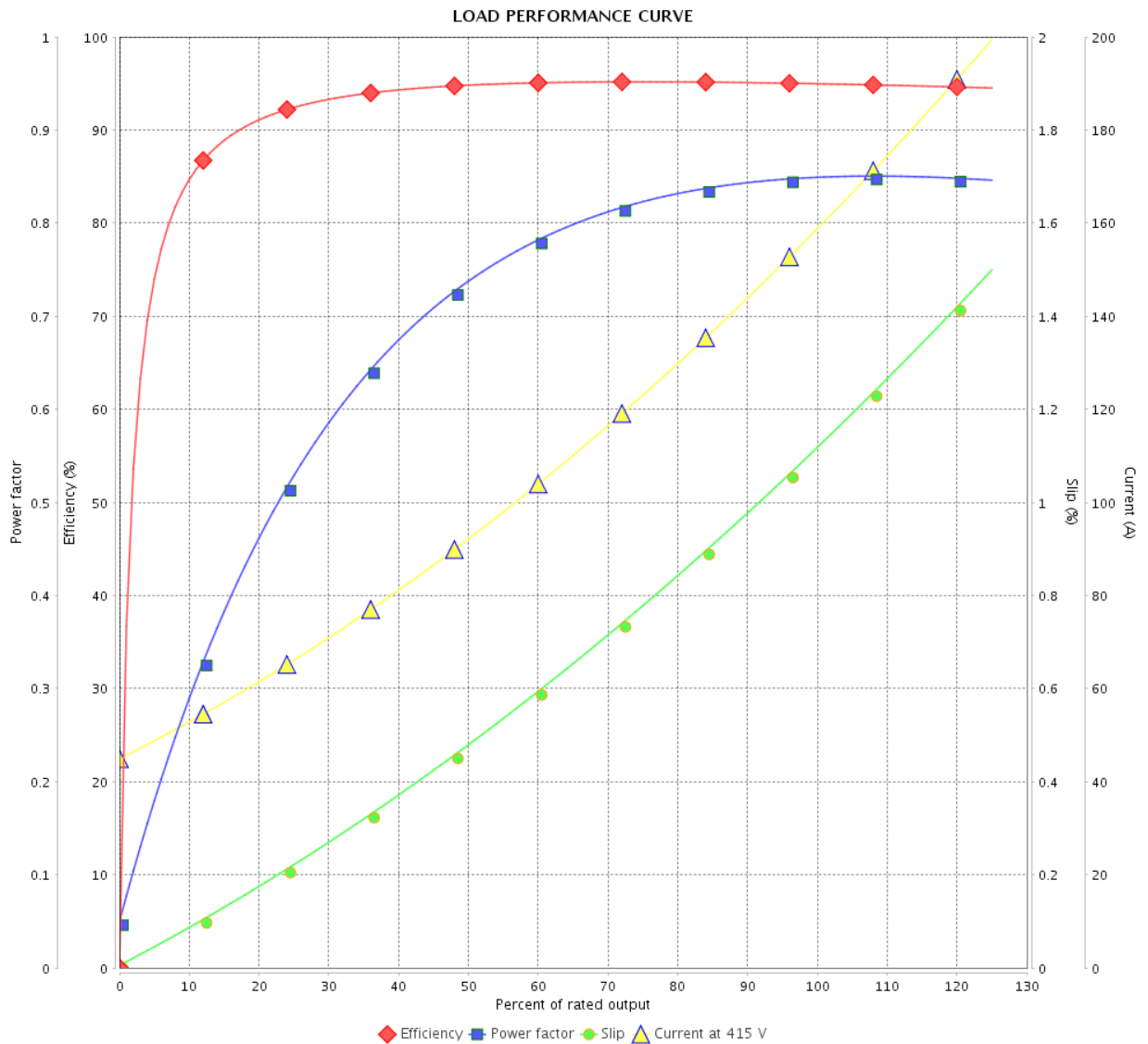

Performance : 415 V 50 Hz 4P IE2

Rated current : 155 A
 LRC : 6.2
 Rated torque : 443 ft.lb
 Locked rotor torque : 190 %
 Breakdown torque : 220 %
 Rated speed : 1480 rpm

Moment of inertia (J) : 57.2 sq.ft.lb
 Duty cycle : Cont.(S1)
 Insulation class : F
 Service factor : 1.00
 Temperature rise : 80 K
 Design : B

Rev.	Changes Summary	Performed	Checked	Date
Performed by		Page		Revision
Checked by		15 / 36		
Date	13/04/2022			

THERMAL LIMIT CURVE



Three Phase Induction Motor - Squirrel Cage

Customer :

Product line : NEMA Premium Efficiency Three-Phase
Product code : 12274312
Catalog # : 12518ET3G444TC-W22

Performance : 460 V 60 Hz 4P

Rated current	: 139 A	Moment of inertia (J)	: 57.2 sq.ft.lb
LRC	: 6.5	Duty cycle	: Cont.(S1)
Rated torque	: 368 ft.lb	Insulation class	: F
Locked rotor torque	: 200 %	Service factor	: 1.15
Breakdown torque	: 229 %	Temperature rise	: 80 K
Rated speed	: 1780 rpm	Design	: B

Heating constant

Cooling constant

Rev.	Changes Summary	Performed	Checked	Date
Performed by				
Checked by			Page	Revision
Date	13/04/2022		16 / 36	

THERMAL LIMIT CURVE

Three Phase Induction Motor - Squirrel Cage



Customer : _____

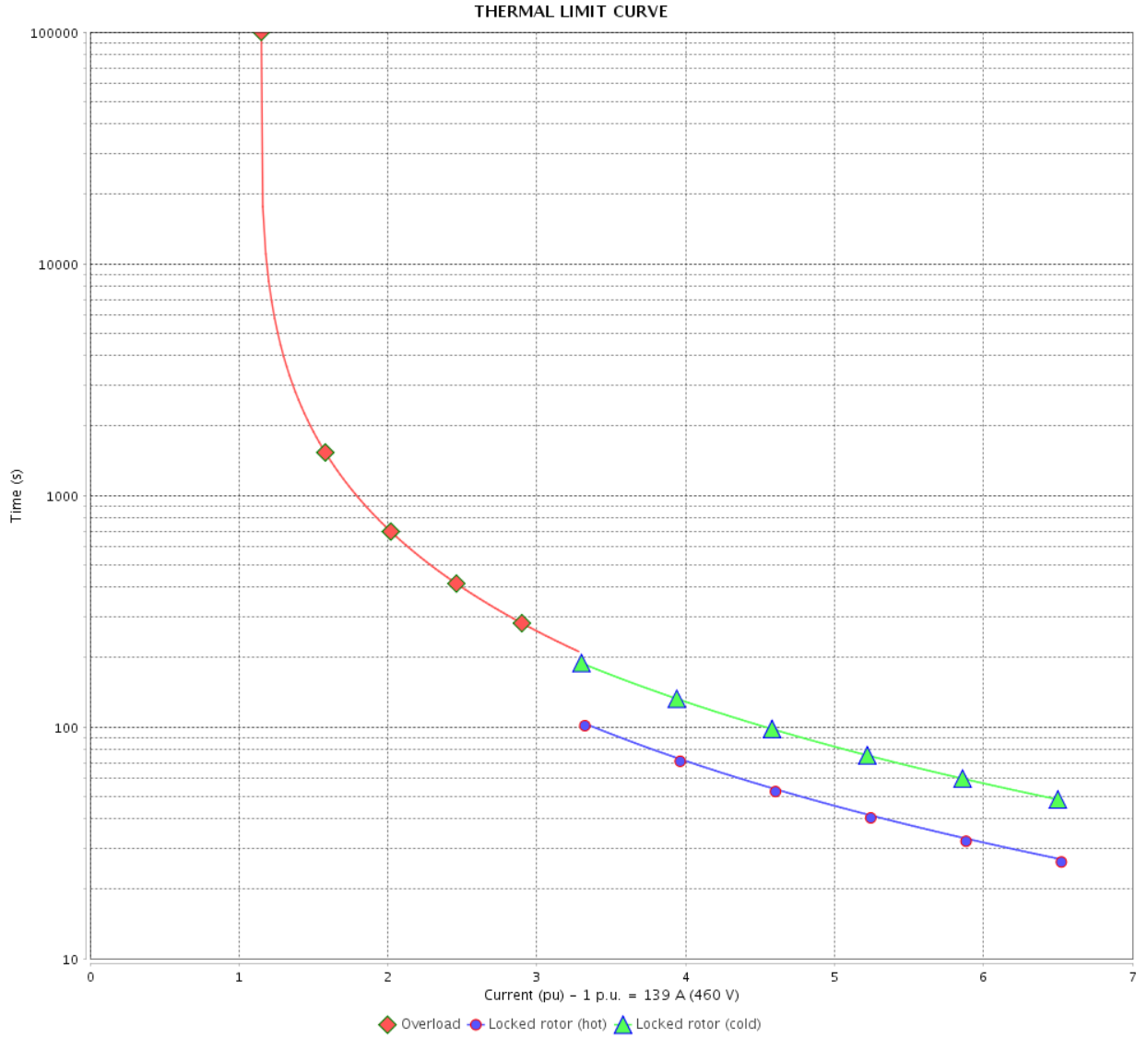

Rev.	Changes Summary	Performed	Checked	Date
Performed by		Page 17 / 36		Revision
Checked by				
Date				

THERMAL LIMIT CURVE



Three Phase Induction Motor - Squirrel Cage

Customer :

Product line : NEMA Premium Efficiency Three-Phase
Product code : 12274312
Catalog # : 12518ET3G444TC-W22

Performance : 380 V 50 Hz 4P IE3

Rated current	: 139 A	Moment of inertia (J)	: 57.2 sq.ft.lb
LRC	: 6.4	Duty cycle	: Cont.(S1)
Rated torque	: 354 ft.lb	Insulation class	: F
Locked rotor torque	: 200 %	Service factor	: 1.00
Breakdown torque	: 229 %	Temperature rise	: 80 K
Rated speed	: 1480 rpm	Design	: B

Heating constant

Cooling constant

Rev.	Changes Summary	Performed	Checked	Date
Performed by				
Checked by			Page	Revision
Date	13/04/2022		18 / 36	

THERMAL LIMIT CURVE

Three Phase Induction Motor - Squirrel Cage



Customer : _____

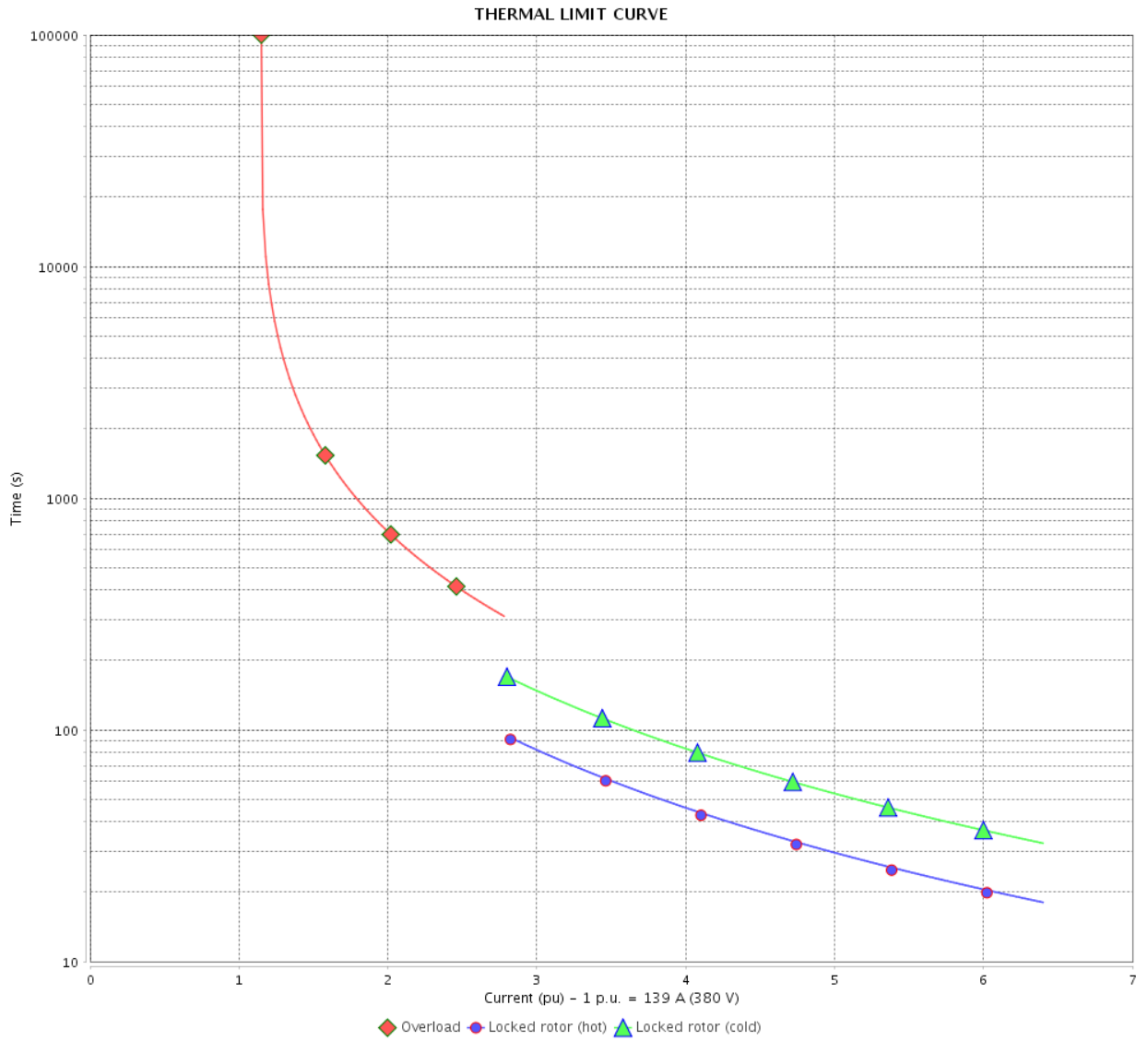

Rev.	Changes Summary	Performed	Checked	Date
Performed by		Page 19 / 36		Revision
Checked by				
Date				

THERMAL LIMIT CURVE

Three Phase Induction Motor - Squirrel Cage



Customer :

Product line : NEMA Premium Efficiency Three-Phase
Product code : 12274312
Catalog # : 12518ET3G444TC-W22

Performance : 400 V 50 Hz 4P IE3

Rated current	: 136 A	Moment of inertia (J)	: 57.2 sq.ft.lb
LRC	: 7.0	Duty cycle	: Cont.(S1)
Rated torque	: 354 ft.lb	Insulation class	: F
Locked rotor torque	: 229 %	Service factor	: 1.00
Breakdown torque	: 260 %	Temperature rise	: 80 K
Rated speed	: 1480 rpm	Design	: B

Heating constant

Cooling constant

Rev.	Changes Summary	Performed	Checked	Date
Performed by				
Checked by			Page	Revision
Date	13/04/2022		20 / 36	

THERMAL LIMIT CURVE

Three Phase Induction Motor - Squirrel Cage



Customer : _____

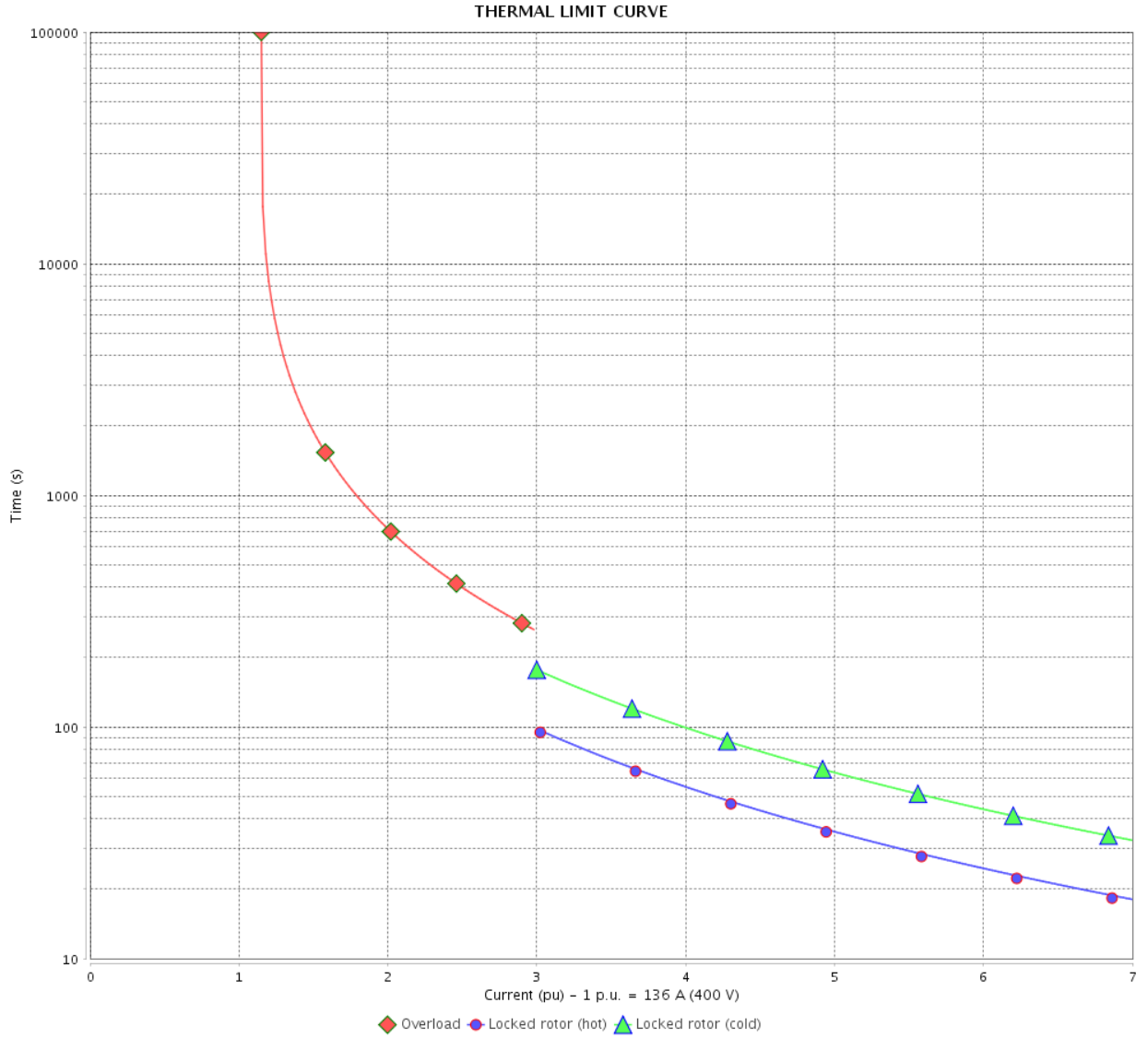

Rev.	Changes Summary	Performed	Checked	Date
Performed by		Page 21 / 36		Revision
Checked by				
Date				

THERMAL LIMIT CURVE



Three Phase Induction Motor - Squirrel Cage

Customer :

Product line : NEMA Premium Efficiency Three-Phase
Product code : 12274312
Catalog # : 12518ET3G444TC-W22

Performance : 415 V 50 Hz 4P IE3

Rated current	: 132 A	Moment of inertia (J)	: 57.2 sq.ft.lb
LRC	: 7.6	Duty cycle	: Cont.(S1)
Rated torque	: 353 ft.lb	Insulation class	: F
Locked rotor torque	: 240 %	Service factor	: 1.00
Breakdown torque	: 280 %	Temperature rise	: 80 K
Rated speed	: 1485 rpm	Design	: B

Heating constant

Cooling constant

Rev.	Changes Summary	Performed	Checked	Date
Performed by				
Checked by			Page	Revision
Date	13/04/2022		22 / 36	

THERMAL LIMIT CURVE

Three Phase Induction Motor - Squirrel Cage



Customer : _____

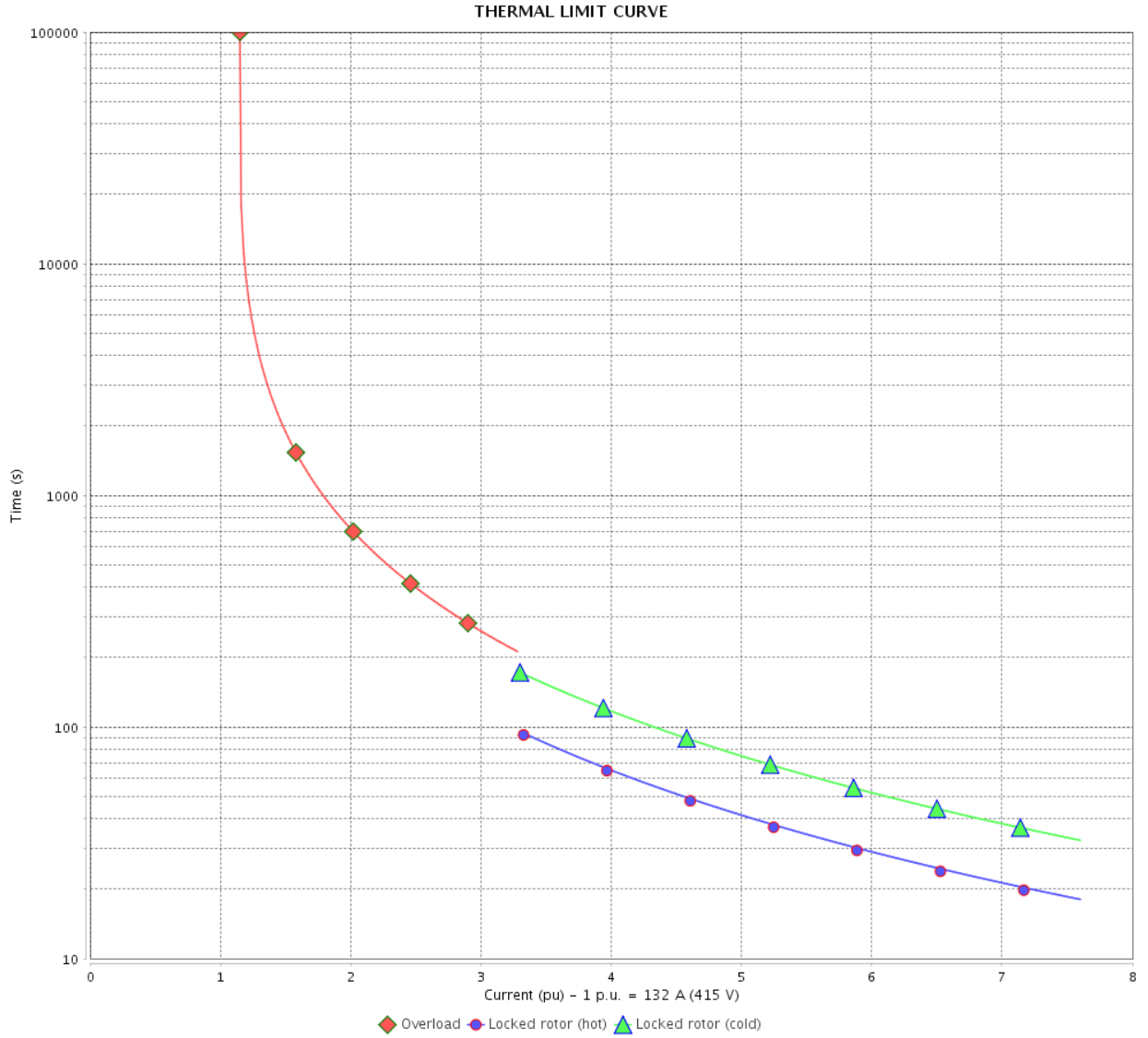

Rev.	Changes Summary	Performed	Checked	Date
Performed by		Page 23 / 36		Revision
Checked by				
Date				

THERMAL LIMIT CURVE



Three Phase Induction Motor - Squirrel Cage

Customer :

Product line : NEMA Premium Efficiency Three-Phase
Product code : 12274312
Catalog # : 12518ET3G444TC-W22

Performance : 380 V 50 Hz 4P IE2

Rated current	: 168 A	Moment of inertia (J)	: 57.2 sq.ft.lb
LRC	: 5.1	Duty cycle	: Cont.(S1)
Rated torque	: 445 ft.lb	Insulation class	: F
Locked rotor torque	: 160 %	Service factor	: 1.00
Breakdown torque	: 180 %	Temperature rise	: 80 K
Rated speed	: 1475 rpm	Design	: B

Heating constant

Cooling constant

Rev.	Changes Summary	Performed	Checked	Date
Performed by				
Checked by			Page	Revision
Date	13/04/2022		24 / 36	

THERMAL LIMIT CURVE

Three Phase Induction Motor - Squirrel Cage



Customer : _____

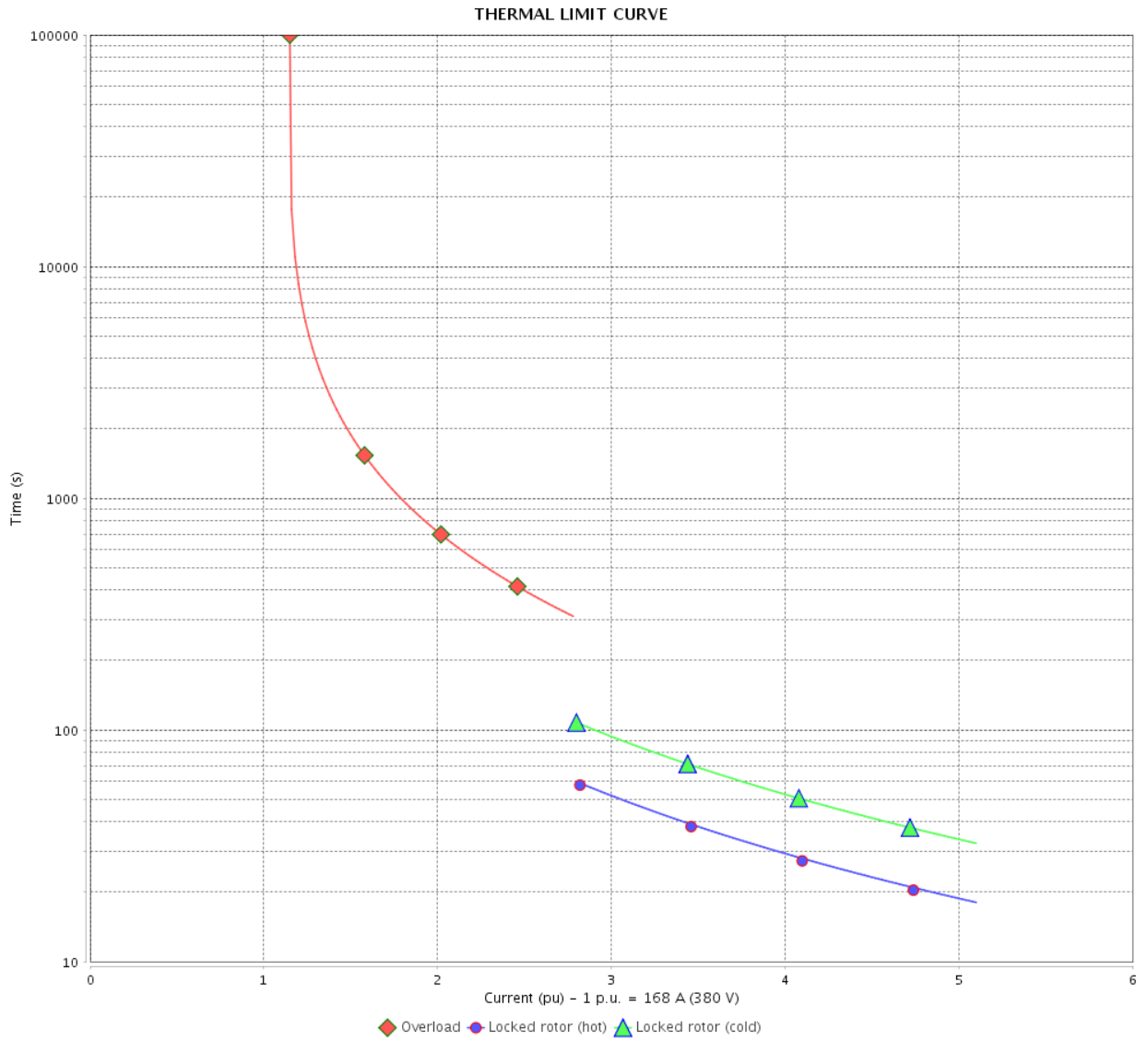

Rev.	Changes Summary	Performed	Checked	Date
Performed by		Page		Revision
Checked by		25 / 36		
Date		13/04/2022		

THERMAL LIMIT CURVE

Three Phase Induction Motor - Squirrel Cage



Customer :

Product line : NEMA Premium Efficiency Three-Phase
Product code : 12274312
Catalog # : 12518ET3G444TC-W22

Performance : 400 V 50 Hz 4P IE2

Rated current	: 160 A	Moment of inertia (J)	: 57.2 sq.ft.lb
LRC	: 5.7	Duty cycle	: Cont.(S1)
Rated torque	: 444 ft.lb	Insulation class	: F
Locked rotor torque	: 180 %	Service factor	: 1.00
Breakdown torque	: 200 %	Temperature rise	: 80 K
Rated speed	: 1475 rpm	Design	: B

Heating constant

Cooling constant

Rev.	Changes Summary	Performed	Checked	Date
Performed by				
Checked by			Page	Revision
Date	13/04/2022		26 / 36	

THERMAL LIMIT CURVE

Three Phase Induction Motor - Squirrel Cage



Customer : _____

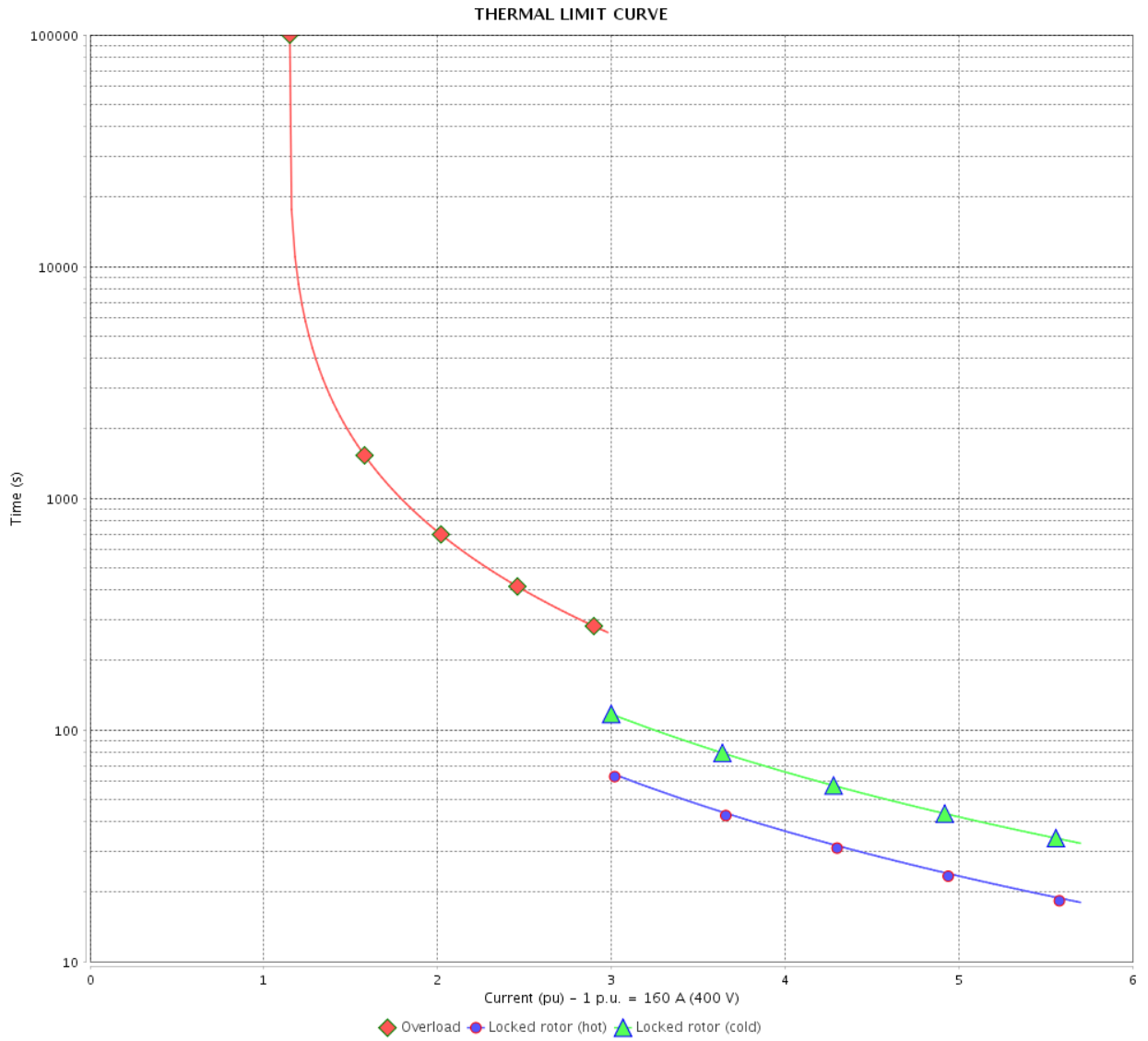

Rev.	Changes Summary	Performed	Checked	Date
Performed by		Page 27 / 36		Revision
Checked by				
Date				

THERMAL LIMIT CURVE

Three Phase Induction Motor - Squirrel Cage



Customer :

Product line : NEMA Premium Efficiency Three-Phase
Product code : 12274312
Catalog # : 12518ET3G444TC-W22

Performance : 415 V 50 Hz 4P IE2

Rated current	: 155 A	Moment of inertia (J)	: 57.2 sq.ft.lb
LRC	: 6.2	Duty cycle	: Cont.(S1)
Rated torque	: 443 ft.lb	Insulation class	: F
Locked rotor torque	: 190 %	Service factor	: 1.00
Breakdown torque	: 220 %	Temperature rise	: 80 K
Rated speed	: 1480 rpm	Design	: B

Heating constant

Cooling constant

Rev.	Changes Summary	Performed	Checked	Date
Performed by				
Checked by			Page	Revision
Date	13/04/2022		28 / 36	

THERMAL LIMIT CURVE

Three Phase Induction Motor - Squirrel Cage



Customer : _____

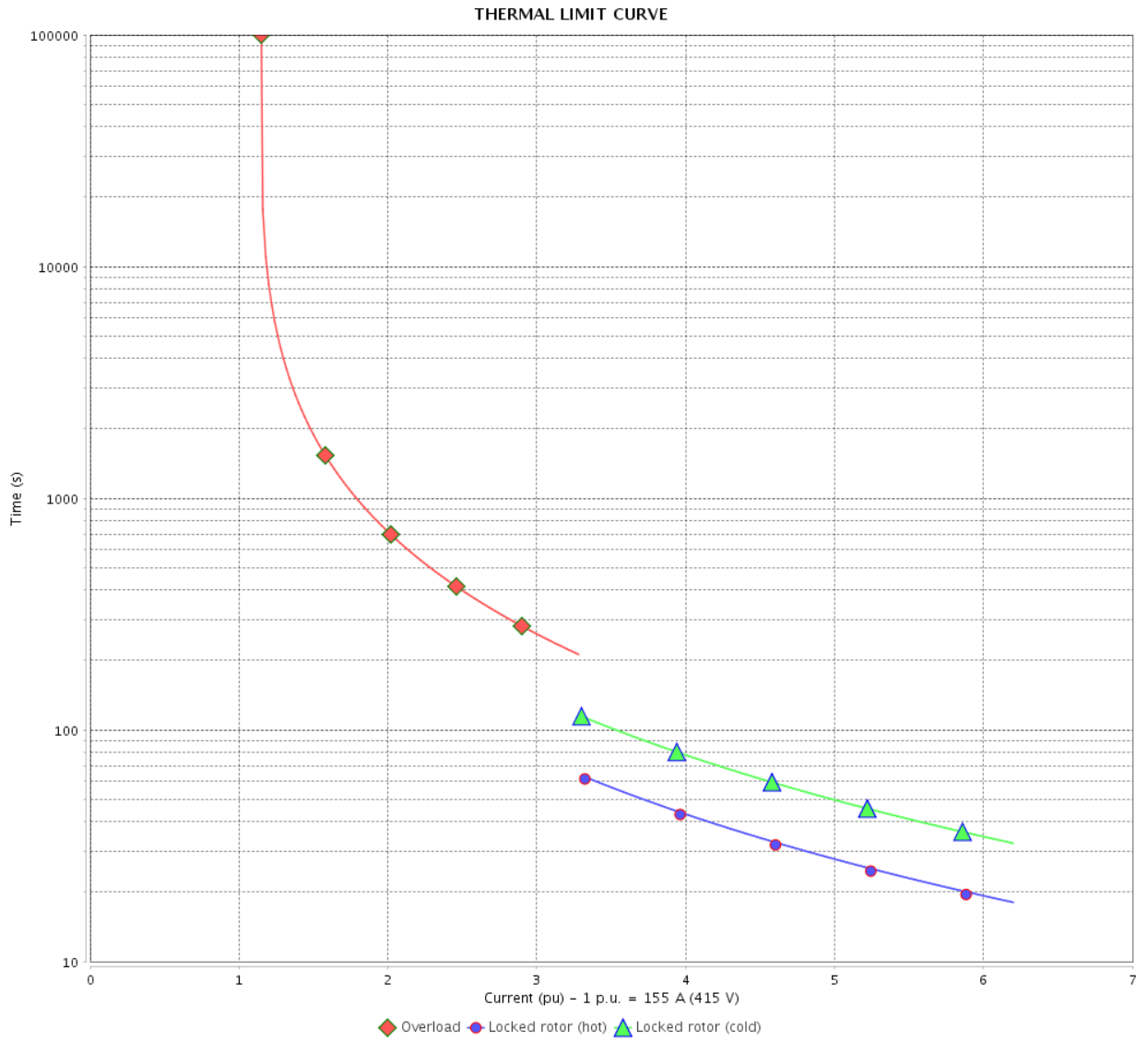

Rev.	Changes Summary	Performed	Checked	Date
Performed by		Page		Revision
Checked by		29 / 36		
Date		13/04/2022		

VFD OPERATION CURVE

Three Phase Induction Motor - Squirrel Cage



Customer :

Product line : NEMA Premium Efficiency Three-Phase

Product code : 12274312

Catalog # : 12518ET3G444TC-W22

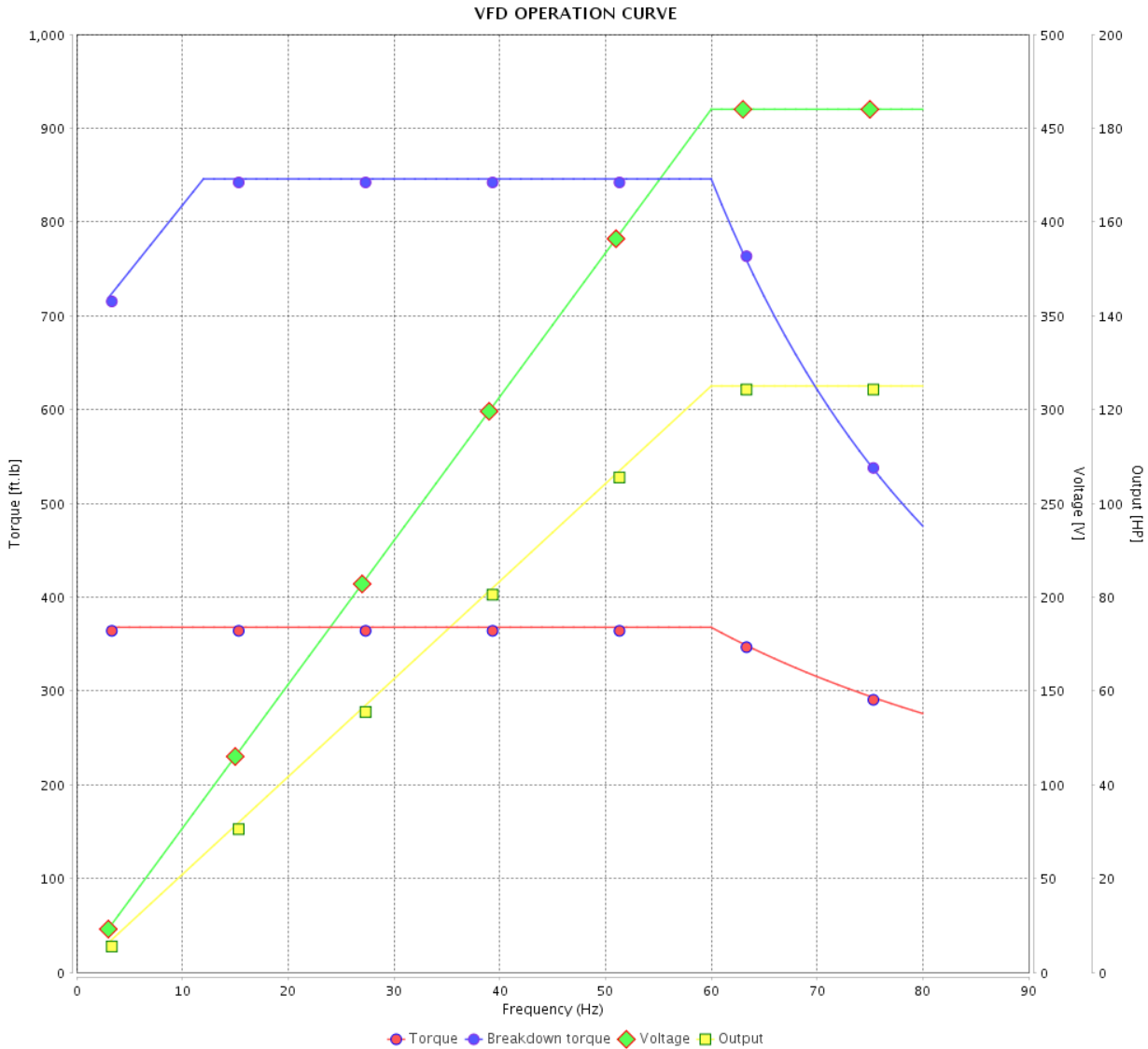

Performance : 460 V 60 Hz 4P

Rated current	: 139 A	Moment of inertia (J)	: 57.2 sq.ft.lb
LRC	: 6.5	Duty cycle	: Cont.(S1)
Rated torque	: 368 ft.lb	Insulation class	: F
Locked rotor torque	: 200 %	Service factor	: 1.15
Breakdown torque	: 229 %	Temperature rise	: 80 K
Rated speed	: 1780 rpm	Design	: B

Rev.	Changes Summary	Performed	Checked	Date
Performed by			Page 30 / 36	Revision
Checked by				
Date	13/04/2022			

VFD OPERATION CURVE

Three Phase Induction Motor - Squirrel Cage



Customer : _____

Product line : NEMA Premium Efficiency Three-Phase

Product code : 12274312

Catalog # : 12518ET3G444TC-W22

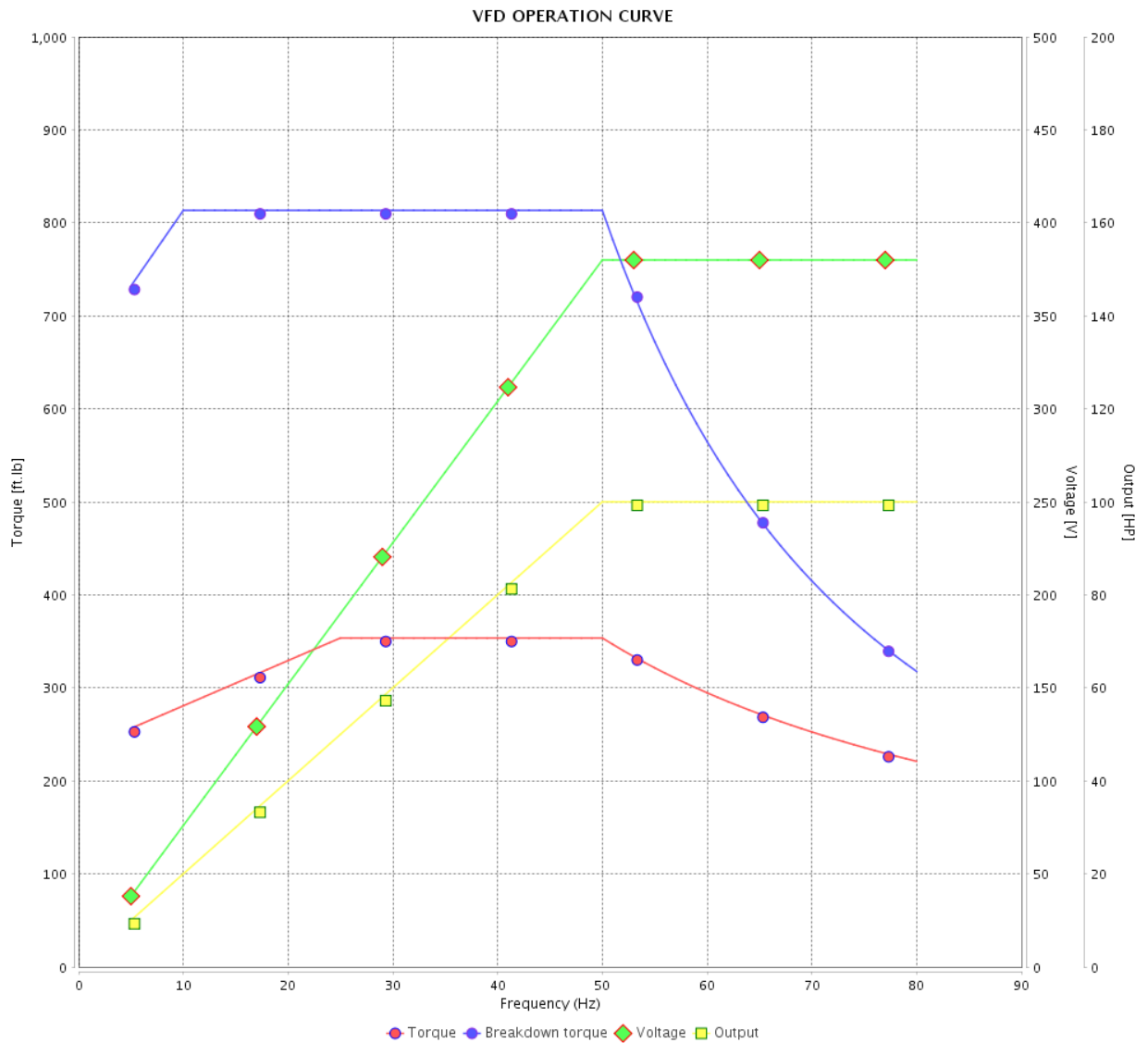

Performance : 380 V 50 Hz 4P IE3

Rated current : 139 A
 LRC : 6.4
 Rated torque : 354 ft.lb
 Locked rotor torque : 200 %
 Breakdown torque : 229 %
 Rated speed : 1480 rpm

Moment of inertia (J) : 57.2 sq.ft.lb
 Duty cycle : Cont.(S1)
 Insulation class : F
 Service factor : 1.00
 Temperature rise : 80 K
 Design : B

Rev.	Changes Summary	Performed	Checked	Date
Performed by		Page		Revision
Checked by		31 / 36		
Date	13/04/2022			

VFD OPERATION CURVE

Three Phase Induction Motor - Squirrel Cage



Customer :

Product line : NEMA Premium Efficiency Three-Phase

Product code : 12274312

Catalog # : 12518ET3G444TC-W22

VFD OPERATION CURVE

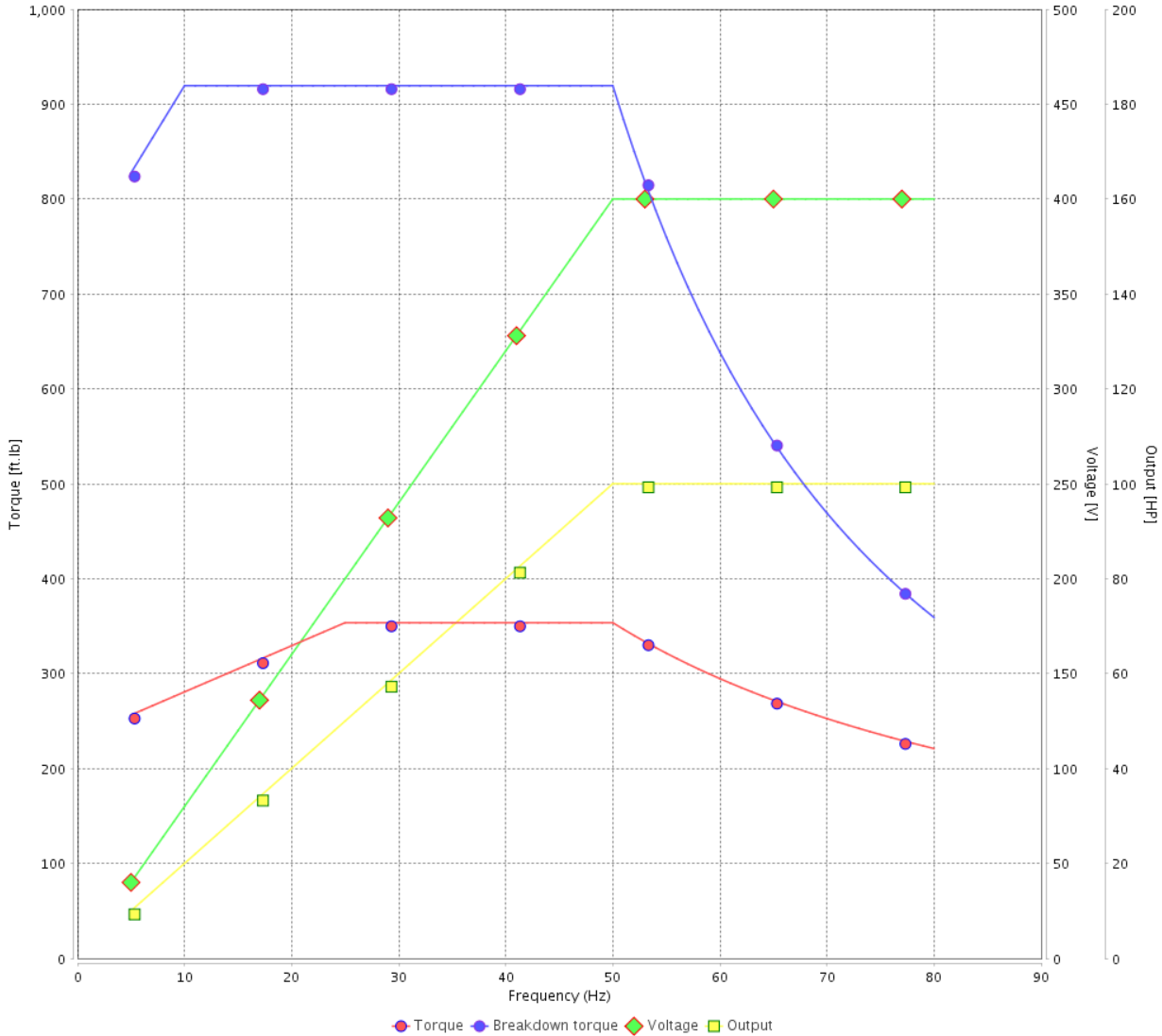

Performance : 400 V 50 Hz 4P IE3

Rated current : 136 A
 LRC : 7.0
 Rated torque : 354 ft.lb
 Locked rotor torque : 229 %
 Breakdown torque : 260 %
 Rated speed : 1480 rpm

Moment of inertia (J) : 57.2 sq.ft.lb
 Duty cycle : Cont.(S1)
 Insulation class : F
 Service factor : 1.00
 Temperature rise : 80 K
 Design : B

Rev.	Changes Summary	Performed	Checked	Date
Performed by			Page 32 / 36	Revision
Checked by				
Date	13/04/2022			

VFD OPERATION CURVE

Three Phase Induction Motor - Squirrel Cage



Customer : _____

Product line : NEMA Premium Efficiency Three-Phase

Product code : 12274312

Catalog # : 12518ET3G444TC-W22

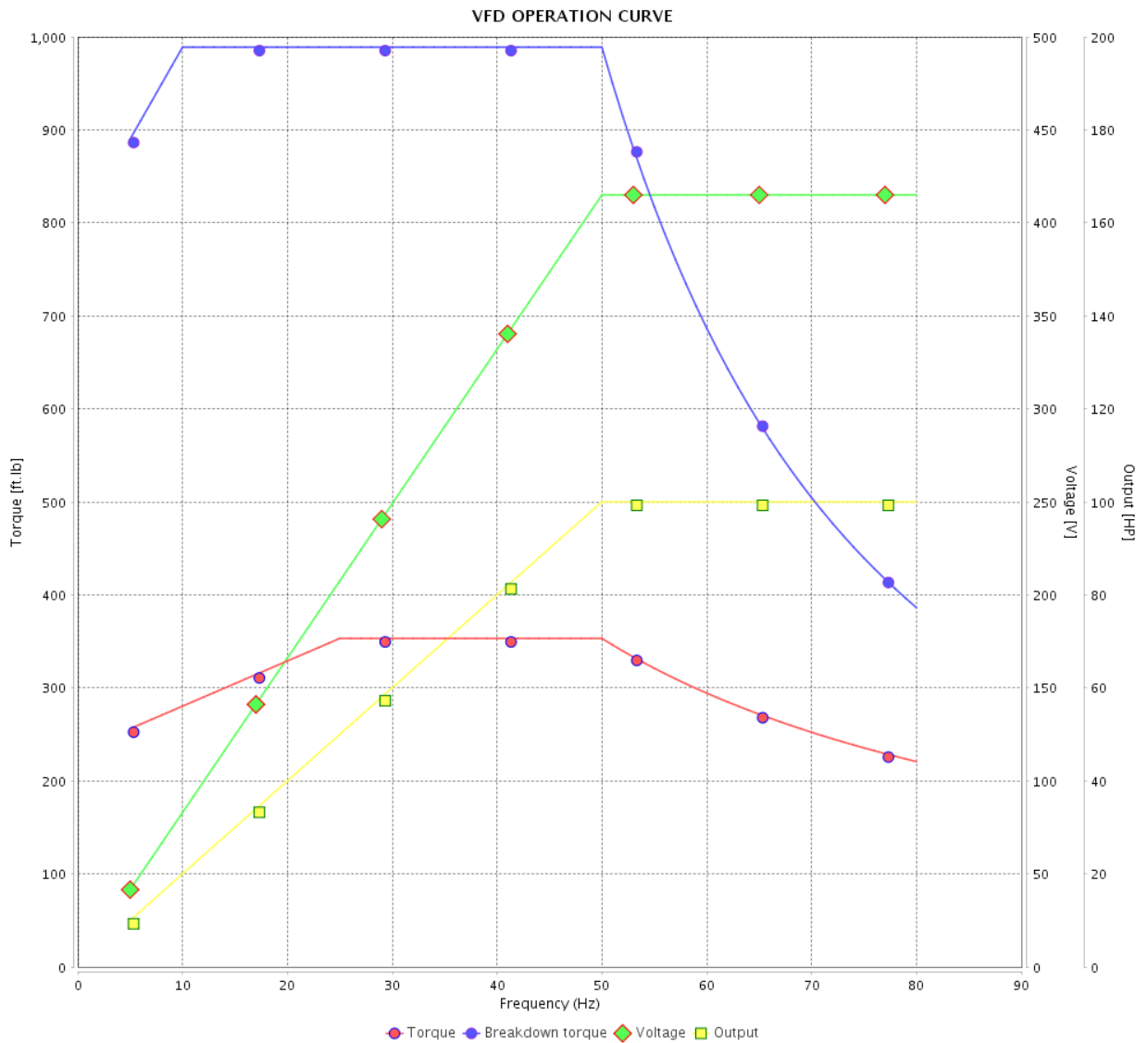

Performance : 415 V 50 Hz 4P IE3

Rated current : 132 A
 LRC : 7.6
 Rated torque : 353 ft.lb
 Locked rotor torque : 240 %
 Breakdown torque : 280 %
 Rated speed : 1485 rpm

Moment of inertia (J) : 57.2 sq.ft.lb
 Duty cycle : Cont.(S1)
 Insulation class : F
 Service factor : 1.00
 Temperature rise : 80 K
 Design : B

Rev.	Changes Summary	Performed	Checked	Date
Performed by			Page 33 / 36	Revision
Checked by				
Date	13/04/2022			

VFD OPERATION CURVE

Three Phase Induction Motor - Squirrel Cage



Customer :

Product line : NEMA Premium Efficiency Three-Phase

Product code : 12274312

Catalog # : 12518ET3G444TC-W22

VFD OPERATION CURVE

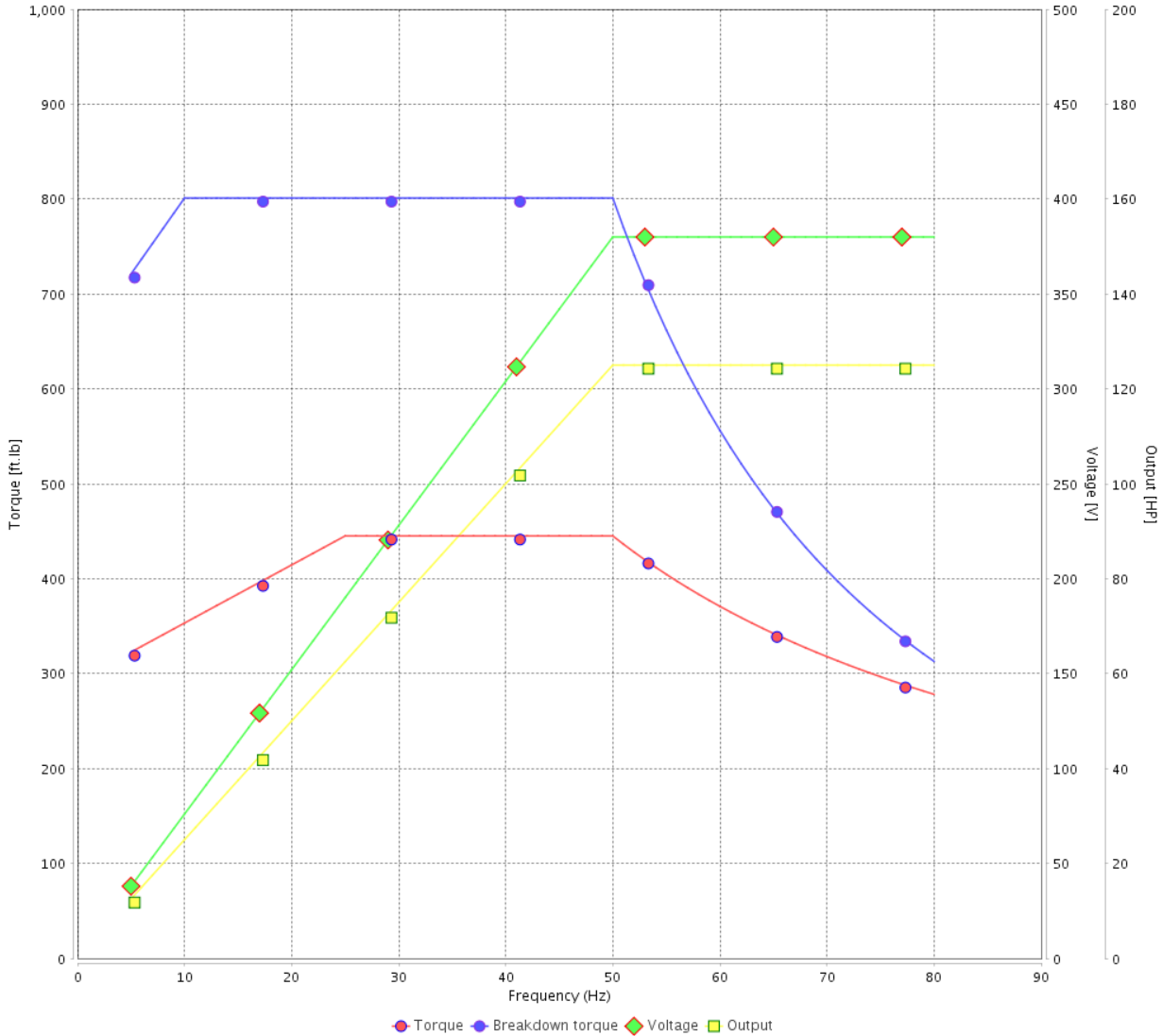

Performance : 380 V 50 Hz 4P IE2

Rated current	: 168 A	Moment of inertia (J)	: 57.2 sq.ft.lb
LRC	: 5.1	Duty cycle	: Cont.(S1)
Rated torque	: 445 ft.lb	Insulation class	: F
Locked rotor torque	: 160 %	Service factor	: 1.00
Breakdown torque	: 180 %	Temperature rise	: 80 K
Rated speed	: 1475 rpm	Design	: B

Rev.	Changes Summary	Performed	Checked	Date
Performed by			Page	Revision
Checked by			34 / 36	
Date	13/04/2022			

VFD OPERATION CURVE

Three Phase Induction Motor - Squirrel Cage



Customer :

Product line : NEMA Premium Efficiency Three-Phase

Product code : 12274312

Catalog # : 12518ET3G444TC-W22

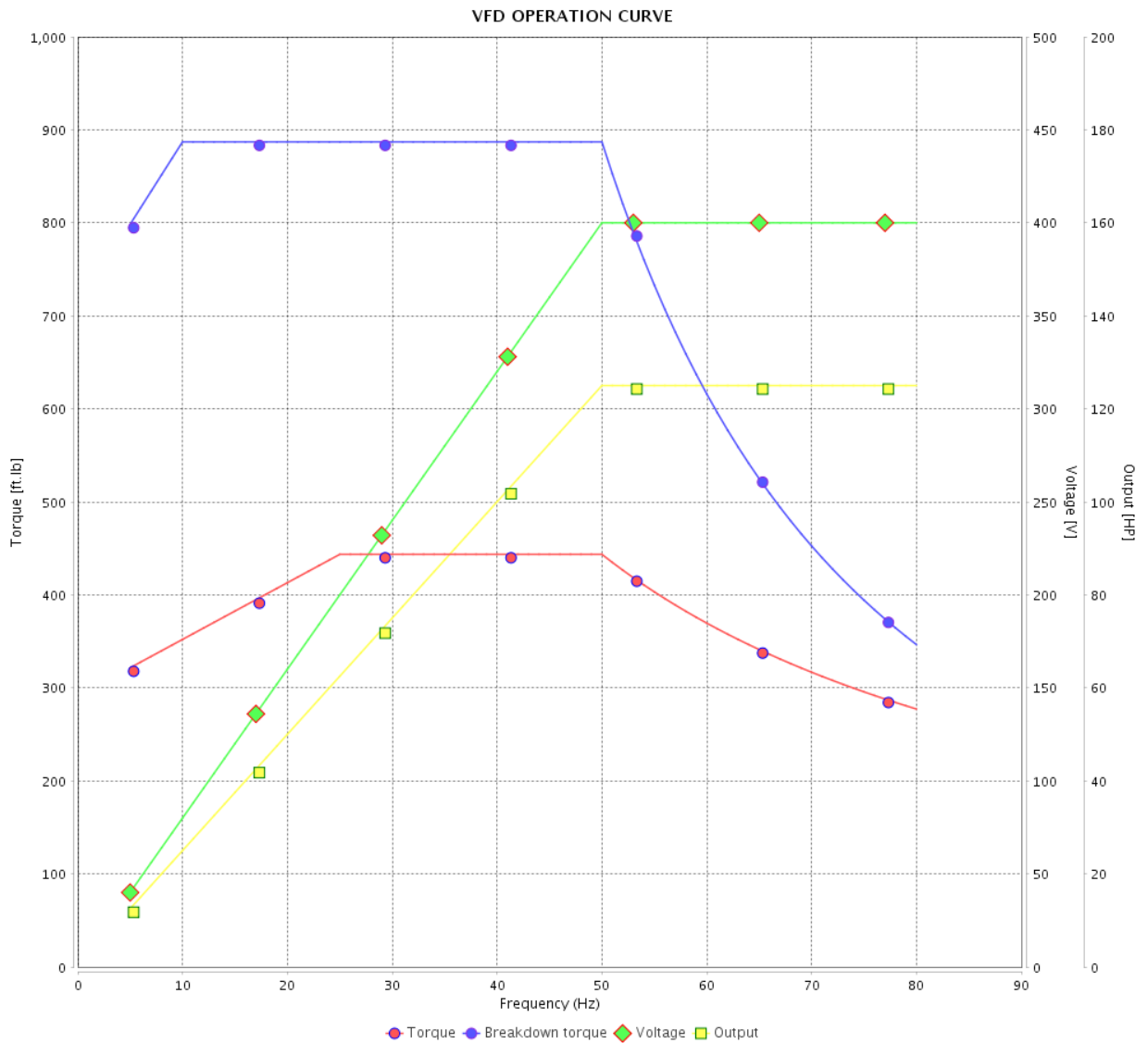

Performance : 400 V 50 Hz 4P IE2

Rated current : 160 A
 LRC : 5.7
 Rated torque : 444 ft.lb
 Locked rotor torque : 180 %
 Breakdown torque : 200 %
 Rated speed : 1475 rpm

Moment of inertia (J) : 57.2 sq.ft.lb
 Duty cycle : Cont.(S1)
 Insulation class : F
 Service factor : 1.00
 Temperature rise : 80 K
 Design : B

Rev.	Changes Summary	Performed	Checked	Date
Performed by		Page		Revision
Checked by		35 / 36		
Date	13/04/2022			

VFD OPERATION CURVE

Three Phase Induction Motor - Squirrel Cage



Customer :

Product line : NEMA Premium Efficiency Three-Phase

Product code : 12274312

Catalog # : 12518ET3G444TC-W22

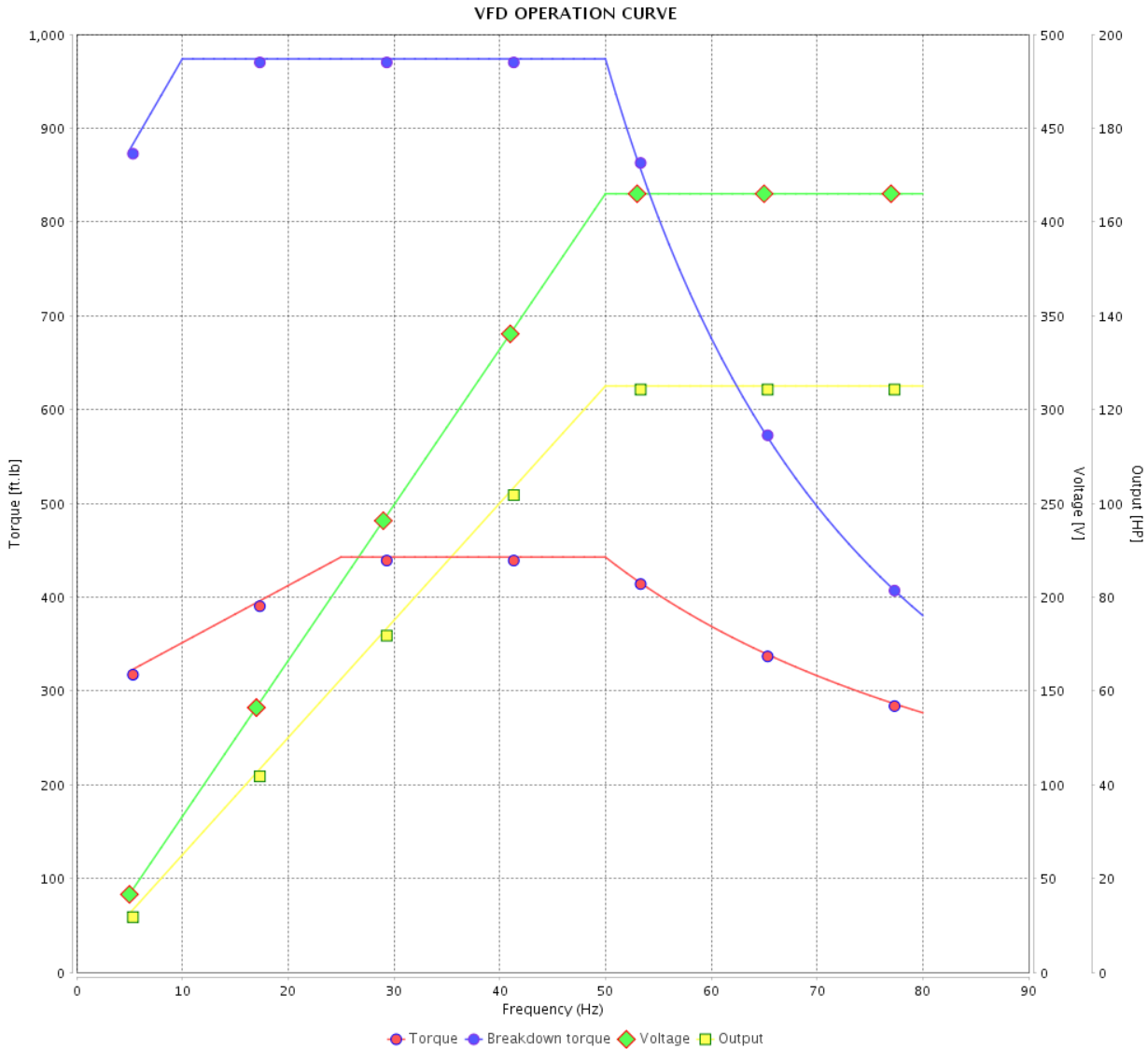

Performance : 415 V 50 Hz 4P IE2

Rated current : 155 A
 LRC : 6.2
 Rated torque : 443 ft.lb
 Locked rotor torque : 190 %
 Breakdown torque : 220 %
 Rated speed : 1480 rpm

Moment of inertia (J) : 57.2 sq.ft.lb
 Duty cycle : Cont.(S1)
 Insulation class : F
 Service factor : 1.00
 Temperature rise : 80 K
 Design : B

Rev.	Changes Summary	Performed	Checked	Date
Performed by			Page 36 / 36	Revision
Checked by				
Date	13/04/2022			

1 2 3 4 5 6

A

B

C

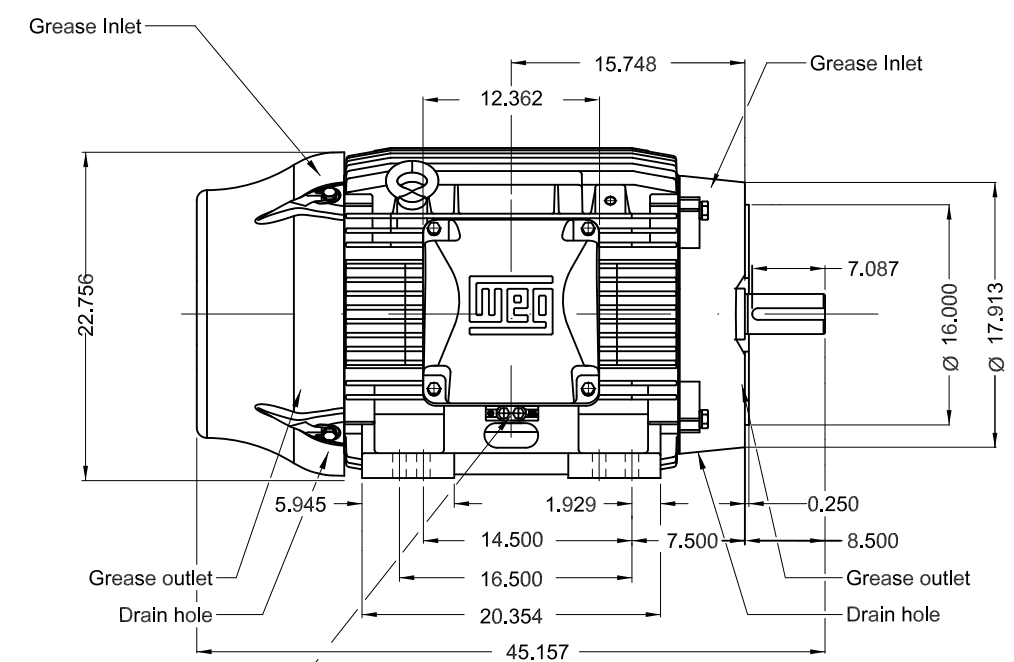
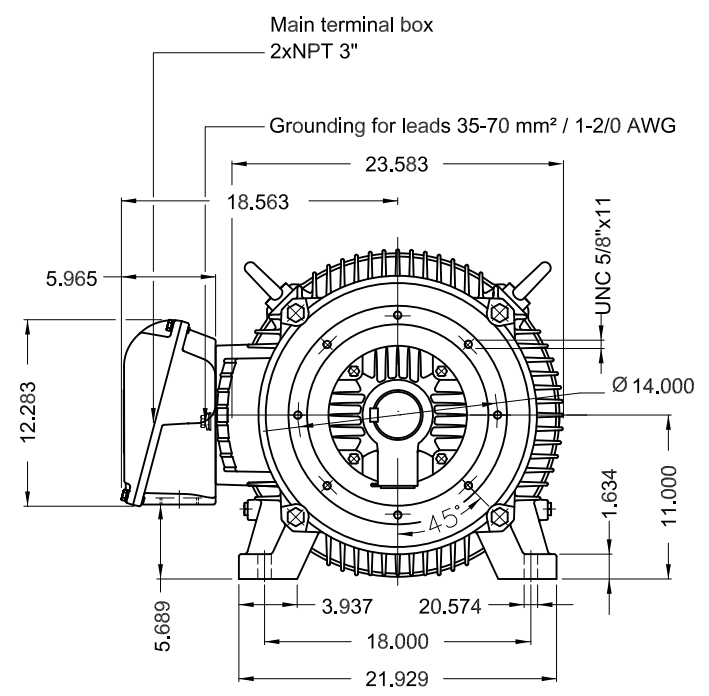

Grounding for leads 25-185 mm² / 3AWG-350MCM

D

E

125 HP 04 Poles 60 Hz A

Color RAL 5009
 Painting plan 203A
 Mounting B34R(D)

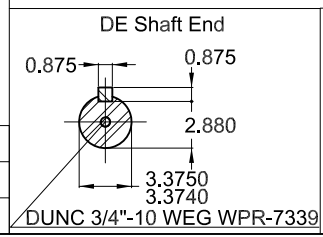

ECM	LOC	SUMMARY OF MODIFICATIONS	EXECUTED	CHECKED	RELEASED	DATE	VER
EXECUTED	PIRWUSER	THREE PH. MOTOR W22 PREM. EFF.					
CHECKED		FRAME 444/5TC IP55 TEFC					
RELEASED							
REL DT.	WMO	Jaragua do Sul	Product Engineering	SHEET	1 / 1		

PREVIEW
 WDD



MADE IN MEXICO
12274312



FOR SAFE AREA
Mod.TE1BFOXON
CC029A



Class I, Div 2, Gr A, B, C and D - T3
Class I, Zone 2, IIC - T3
Class II, Div 2, Gr F and G - T3C
For use on PWM: Gr. A, B, C, D and F,
VT 1000:1, CT 20:1, 1.00SF - T3A

MODEL 12518ET3G444TC-W22

Inverter Duty Motor
Severe Duty

PH3	60Hz	Fr. 444/5TC	1000m.a.s.l.	IP55	TEFC	1685lb
V 460				A 139		
HP 125				kW 90		
SF 1.15				SFA 160		
RPM 1780				PF 0.85		
AMB 40°C				INS cl. F DT80K	NEMA NOM EFF 95.4%	
DUTY CONT.				DES B Code G		

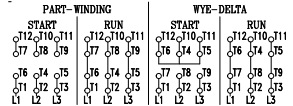

→ 6319-C3 (45g)
 → 6316-C3 (34g)

MOBIL POLYREX EM (8000h)