

DATA SHEET

Three Phase Induction Motor - Squirrel Cage



Customer :							
Product line	: NEMA Premium Efficiency Three-Phase	Product code :	13273171				
		Catalog # :	12536ET3E444TS-W22G				
Frame	: 444/5TS	Cooling method	: IC411 - TEFC				
Insulation class	: F	Mounting	: F-1				
Duty cycle	: Cont.(S1)	Rotation ¹	: Both (CW and CCW)				
Ambient temperature	: -20°C to +40°C	Starting method	: Direct On Line				
Altitude	: 1000 m.a.s.l.	Approx. weight ²	: 1599 lb				
Protection degree	: IP55	Moment of inertia (J)	: 33.5 sq.ft.lb				
Design	: B						
Output [HP]	125	100	100	100	125	125	125
Poles	2	2	2	2	2	2	2
Frequency [Hz]	60	50	50	50	50	50	50
Rated voltage [V]	230/460	380	400	415	380	400	415
Rated current [A]	268/134	135	128	124	163	154	148
L. R. Amperes [A]	1769/884	878	909	955	848	878	918
LRC [A]	6.6x(Code G)	6.5x(Code G)	7.1x(Code G)	7.7x(Code H)	5.2x(Code D)	5.7x(Code E)	6.2x(Code F)
No load current [A]	68.0/34.0	33.6	36.0	37.9	33.6	36.0	37.9
Rated speed [RPM]	3570	2970	2970	2975	2960	2965	2970
Slip [%]	0.83	1.00	1.00	0.83	1.33	1.17	1.00
Rated torque [ft.lb]	184	177	177	177	222	221	221
Locked rotor torque [%]	200	200	210	240	160	170	190
Breakdown torque [%]	250	250	280	300	200	220	240
Service factor	1.15	1.00	1.00	1.00	1.00	1.00	1.00
Temperature rise	80 K	80 K	80 K	80 K	80 K	80 K	80 K
Locked rotor time	52s (cold) 29s (hot)	36s (cold) 20s (hot)	36s (cold) 20s (hot)	36s (cold) 20s (hot)	36s (cold) 20s (hot)	36s (cold) 20s (hot)	36s (cold) 20s (hot)
Noise level ²	81.0 dB(A)	77.0 dB(A)	77.0 dB(A)	77.0 dB(A)	77.0 dB(A)	77.0 dB(A)	77.0 dB(A)
Efficiency (%)	25%	93.0	92.7	92.7	92.2	93.9	93.4
	50%	93.6	93.2	93.2	92.8	94.0	94.0
	75%	94.5	94.3	94.3	94.3	94.5	94.5
	100%	95.0	94.7	94.7	94.8	94.5	95.0
Power Factor	25%	0.59	0.57	0.54	0.51	0.64	0.59
	50%	0.82	0.79	0.77	0.75	0.85	0.82
	75%	0.87	0.87	0.87	0.85	0.88	0.87
	100%	0.89	0.89	0.89	0.89	0.89	0.89
Bearing type	: Drive end : 6314 C3	Non drive end : 6314 C3	Foundation loads				
Sealing	: WSeal	WSeal	Max. traction	: 614 lb			
Lubrication interval	: 4000 h	4000 h	Max. compression	: 2213 lb			
Lubricant amount	: 27 g	27 g					
Lubricant type	: Mobil Polyrex EM						
Notes USABLE @208V 296A SF 1.00 SFA 296A							
This revision replaces and cancel the previous one, which must be eliminated. (1) Looking the motor from the shaft end. (2) Measured at 1m and with tolerance of +3dB(A). (3) Approximate weight subject to changes after manufacturing process. (4) At 100% of full load.				These are average values based on tests with sinusoidal power supply, subject to the tolerances stipulated in NEMA MG-1.			
Rev.	Changes Summary			Performed	Checked	Date	
Performed by							
Checked by					Page	Revision	
Date	13/04/2022				1 / 36		

TORQUE AND CURRENT VS SPEED CURVE

Three Phase Induction Motor - Squirrel Cage



Customer :

Product line : NEMA Premium Efficiency Three-Phase

Product code : 13273171

Catalog # : 12536ET3E444TS-W22G

TORQUE AND CURRENT VS SPEED CURVE

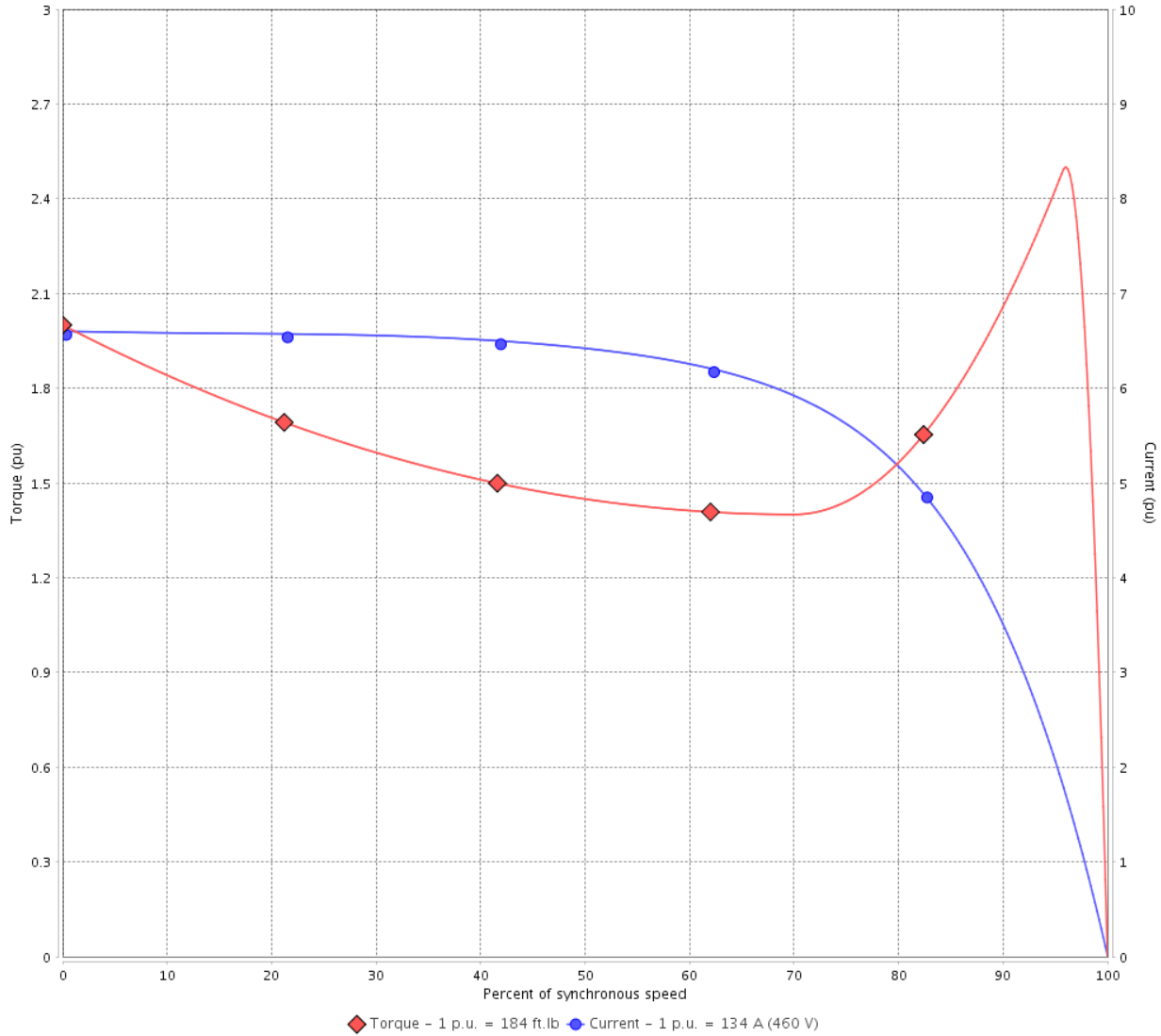

Performance : 230/460 V 60 Hz 2P

Rated current : 268/134 A
 LRC : 6.6
 Rated torque : 184 ft.lb
 Locked rotor torque : 200 %
 Breakdown torque : 250 %
 Rated speed : 3570 rpm

Moment of inertia (J) : 33.5 sq.ft.lb
 Duty cycle : Cont.(S1)
 Insulation class : F
 Service factor : 1.15
 Temperature rise : 80 K
 Design : B

Locked rotor time : 52s (cold) 29s (hot)

Rev.	Changes Summary	Performed	Checked	Date
Performed by			Page 2 / 36	Revision
Checked by				
Date	13/04/2022			

TORQUE AND CURRENT VS SPEED CURVE



Three Phase Induction Motor - Squirrel Cage

Customer :

Product line : NEMA Premium Efficiency Three-Phase

Product code : 13273171

Catalog # : 12536ET3E444TS-W22G

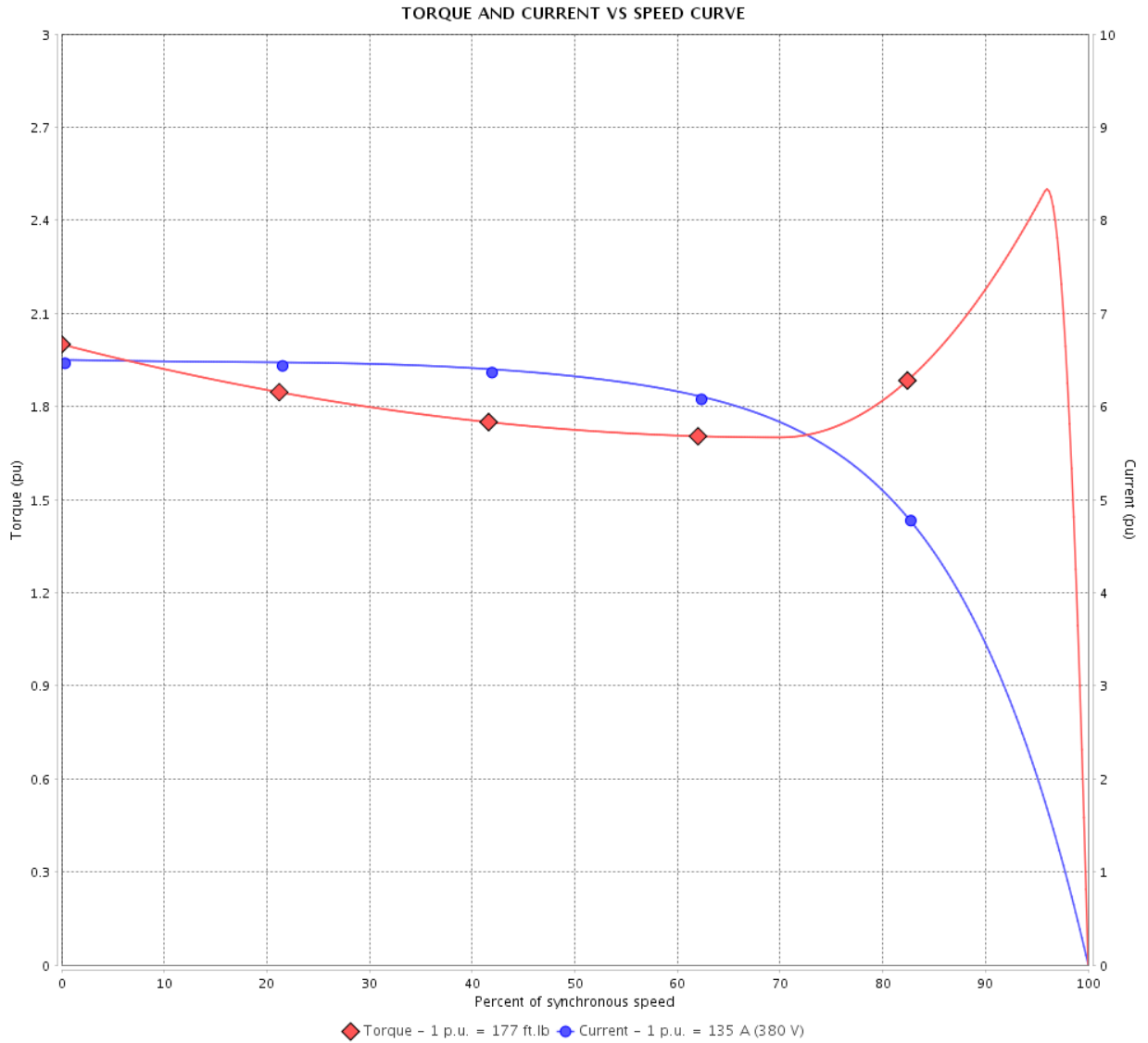

Performance : 380 V 50 Hz 2P IE3

Rated current	: 135 A	Moment of inertia (J)	: 33.5 sq.ft.lb
LRC	: 6.5	Duty cycle	: Cont.(S1)
Rated torque	: 177 ft.lb	Insulation class	: F
Locked rotor torque	: 200 %	Service factor	: 1.00
Breakdown torque	: 250 %	Temperature rise	: 80 K
Rated speed	: 2970 rpm	Design	: B

Locked rotor time : 36s (cold) 20s (hot)

Rev.	Changes Summary	Performed	Checked	Date
Performed by			Page 3 / 36	Revision
Checked by				
Date	13/04/2022			

TORQUE AND CURRENT VS SPEED CURVE

Three Phase Induction Motor - Squirrel Cage



Customer :

Product line : NEMA Premium Efficiency Three-Phase

Product code : 13273171

Catalog # : 12536ET3E444TS-W22G

TORQUE AND CURRENT VS SPEED CURVE

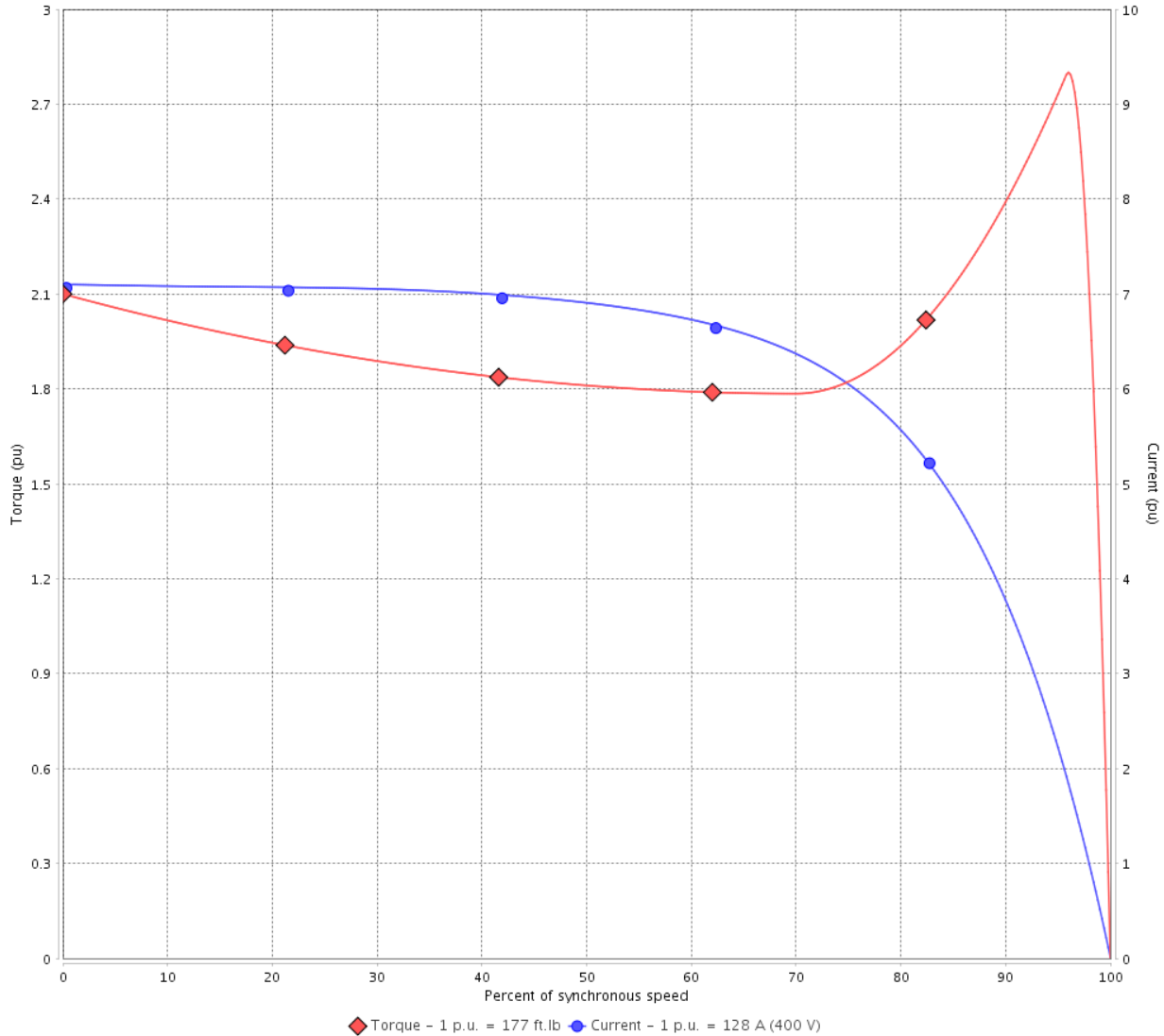

Performance : 400 V 50 Hz 2P IE3

Rated current	: 128 A	Moment of inertia (J)	: 33.5 sq.ft.lb
LRC	: 7.1	Duty cycle	: Cont.(S1)
Rated torque	: 177 ft.lb	Insulation class	: F
Locked rotor torque	: 210 %	Service factor	: 1.00
Breakdown torque	: 280 %	Temperature rise	: 80 K
Rated speed	: 2970 rpm	Design	: B

Locked rotor time : 36s (cold) 20s (hot)

Rev.	Changes Summary	Performed	Checked	Date
Performed by			Page 4 / 36	Revision
Checked by				
Date	13/04/2022			

TORQUE AND CURRENT VS SPEED CURVE



Three Phase Induction Motor - Squirrel Cage

Customer :

Product line : NEMA Premium Efficiency Three-Phase

Product code : 13273171

Catalog # : 12536ET3E444TS-W22G

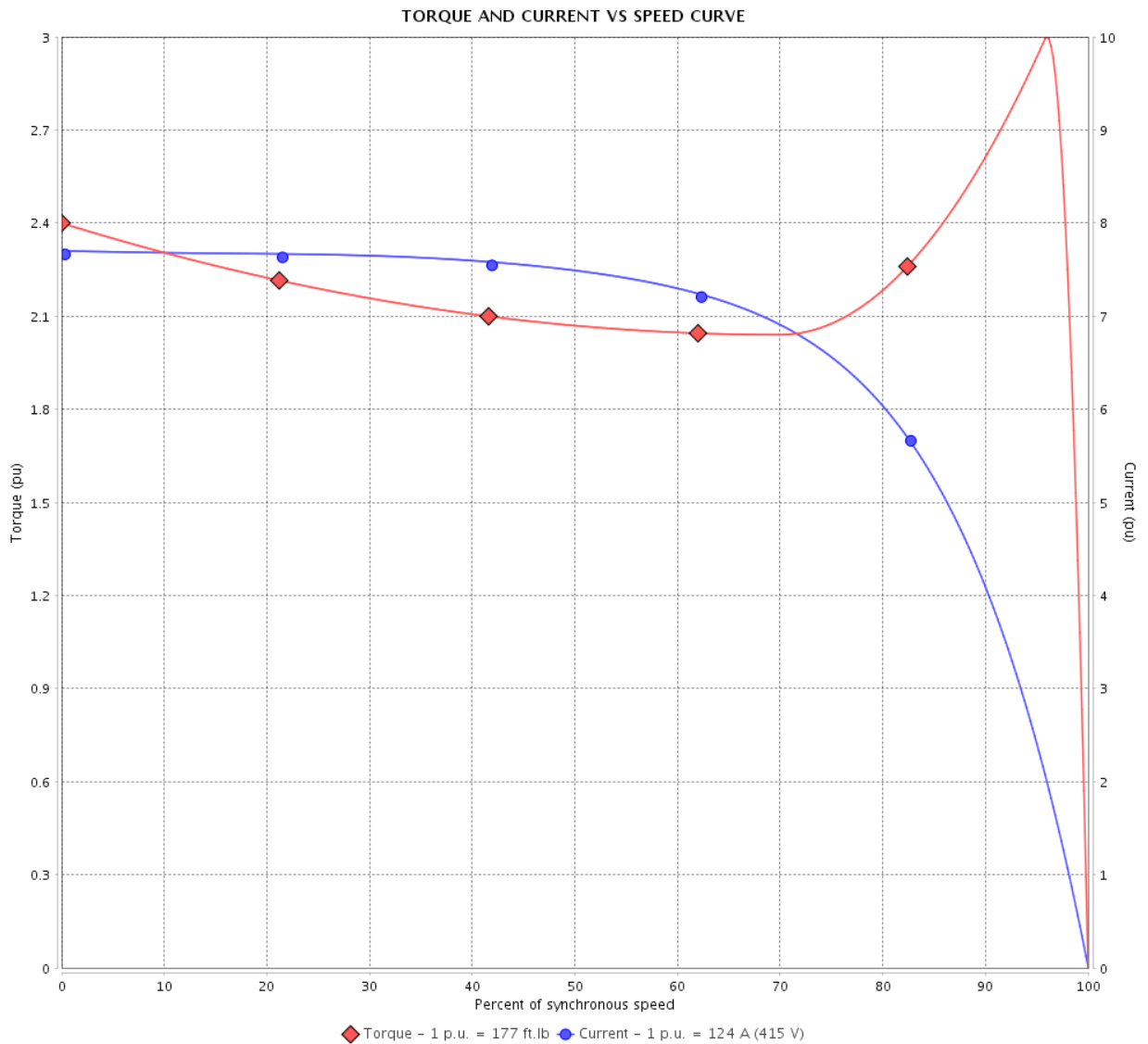

Performance : 415 V 50 Hz 2P IE3

Rated current	: 124 A	Moment of inertia (J)	: 33.5 sq.ft.lb
LRC	: 7.7	Duty cycle	: Cont.(S1)
Rated torque	: 177 ft.lb	Insulation class	: F
Locked rotor torque	: 240 %	Service factor	: 1.00
Breakdown torque	: 300 %	Temperature rise	: 80 K
Rated speed	: 2975 rpm	Design	: B

Locked rotor time : 36s (cold) 20s (hot)

Rev.	Changes Summary	Performed	Checked	Date
Performed by			Page 5 / 36	Revision
Checked by				
Date	13/04/2022			

TORQUE AND CURRENT VS SPEED CURVE

Three Phase Induction Motor - Squirrel Cage



Customer :

Product line : NEMA Premium Efficiency Three-Phase

Product code : 13273171

Catalog # : 12536ET3E444TS-W22G

TORQUE AND CURRENT VS SPEED CURVE

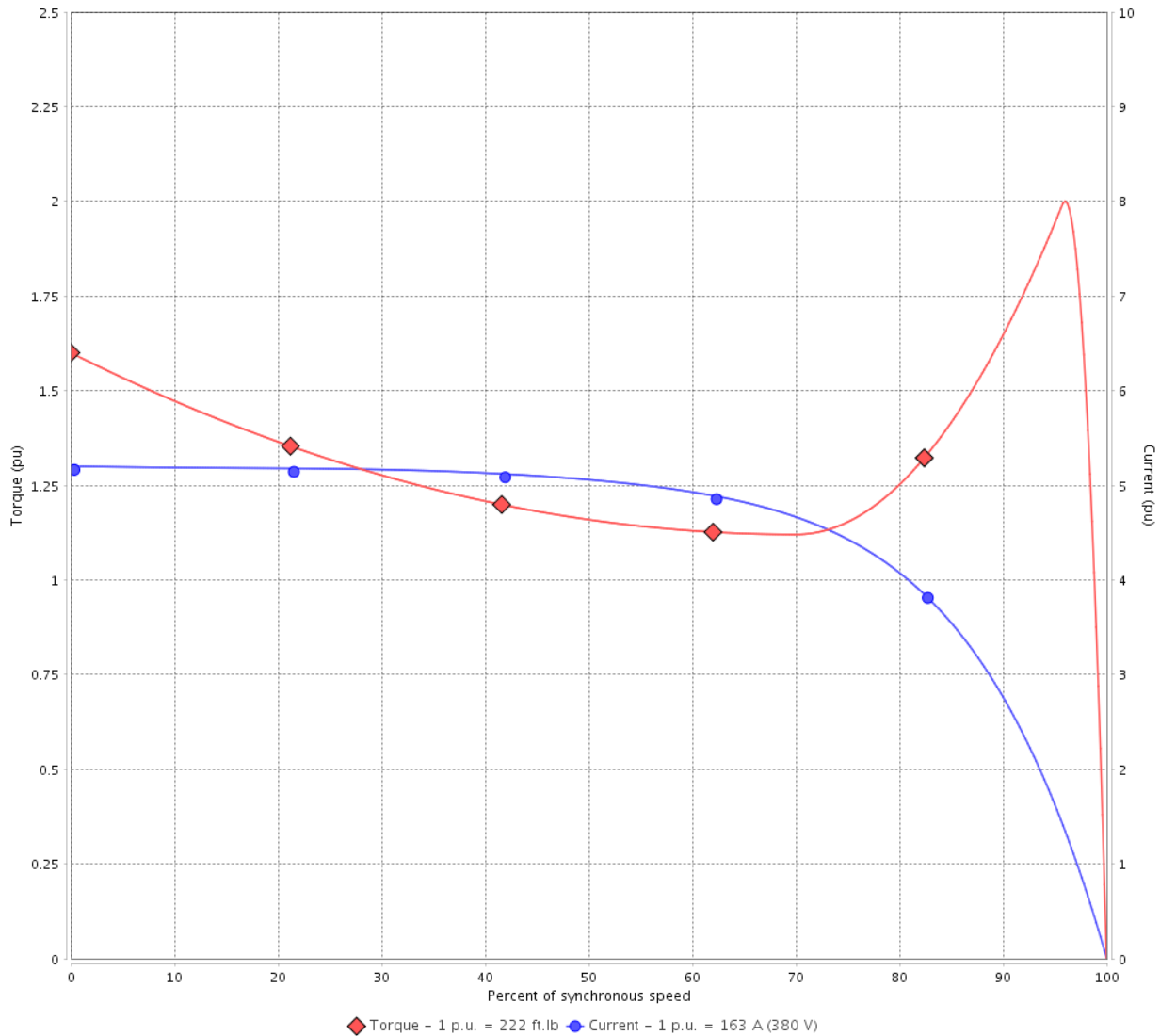

Performance : 380 V 50 Hz 2P IE2

Rated current	: 163 A	Moment of inertia (J)	: 33.5 sq.ft.lb
LRC	: 5.2	Duty cycle	: Cont.(S1)
Rated torque	: 222 ft.lb	Insulation class	: F
Locked rotor torque	: 160 %	Service factor	: 1.00
Breakdown torque	: 200 %	Temperature rise	: 80 K
Rated speed	: 2960 rpm	Design	: B

Locked rotor time : 36s (cold) 20s (hot)

Rev.	Changes Summary	Performed	Checked	Date
Performed by			Page 6 / 36	Revision
Checked by				
Date	13/04/2022			

TORQUE AND CURRENT VS SPEED CURVE



Three Phase Induction Motor - Squirrel Cage

Customer :

Product line : NEMA Premium Efficiency Three-Phase

Product code : 13273171

Catalog # : 12536ET3E444TS-W22G

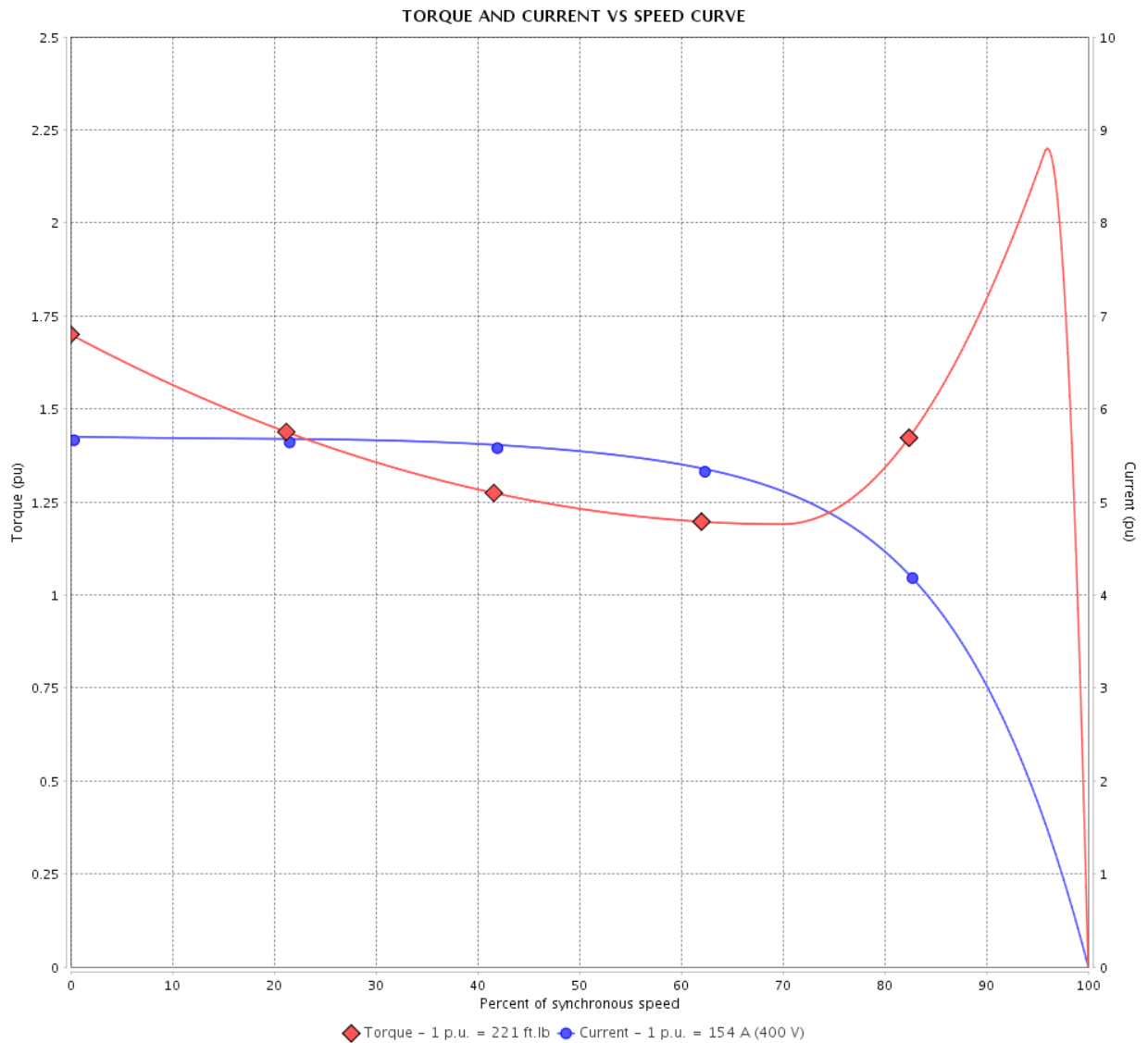

Performance : 400 V 50 Hz 2P IE2

Rated current	: 154 A	Moment of inertia (J)	: 33.5 sq.ft.lb
LRC	: 5.7	Duty cycle	: Cont.(S1)
Rated torque	: 221 ft.lb	Insulation class	: F
Locked rotor torque	: 170 %	Service factor	: 1.00
Breakdown torque	: 220 %	Temperature rise	: 80 K
Rated speed	: 2965 rpm	Design	: B

Locked rotor time : 36s (cold) 20s (hot)

Rev.	Changes Summary	Performed	Checked	Date
Performed by			Page 7 / 36	Revision
Checked by				
Date	13/04/2022			

TORQUE AND CURRENT VS SPEED CURVE

Three Phase Induction Motor - Squirrel Cage



Customer :

Product line : NEMA Premium Efficiency Three-Phase

Product code : 13273171

Catalog # : 12536ET3E444TS-W22G

TORQUE AND CURRENT VS SPEED CURVE

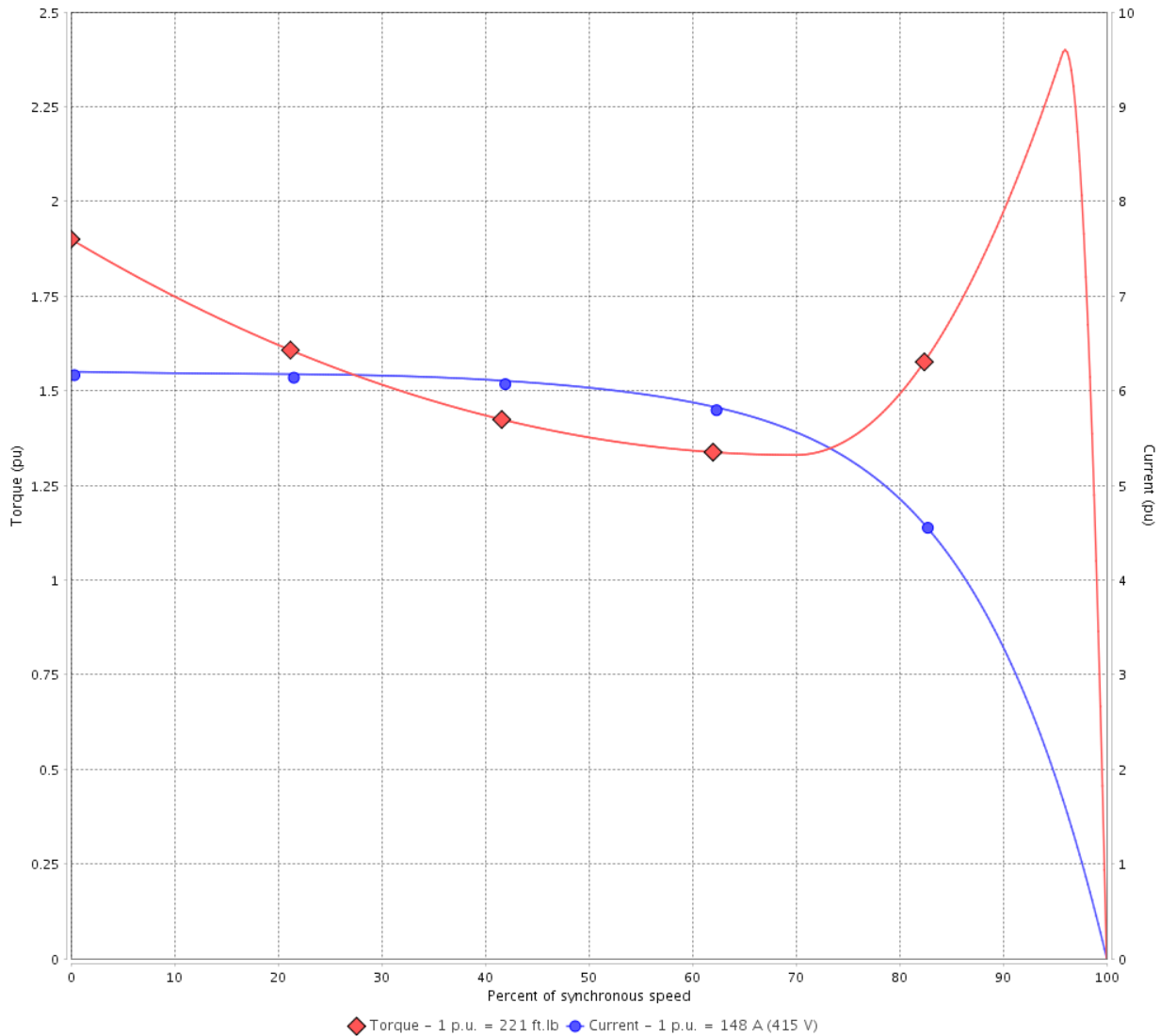

Performance : 415 V 50 Hz 2P IE3

Rated current	: 148 A	Moment of inertia (J)	: 33.5 sq.ft.lb
LRC	: 6.2	Duty cycle	: Cont.(S1)
Rated torque	: 221 ft.lb	Insulation class	: F
Locked rotor torque	: 190 %	Service factor	: 1.00
Breakdown torque	: 240 %	Temperature rise	: 80 K
Rated speed	: 2970 rpm	Design	: B

Locked rotor time : 36s (cold) 20s (hot)

Rev.	Changes Summary	Performed	Checked	Date
Performed by			Page 8 / 36	Revision
Checked by				
Date	13/04/2022			

LOAD PERFORMANCE CURVE

Three Phase Induction Motor - Squirrel Cage



Customer : _____

Product line : NEMA Premium Efficiency Three-Phase

Product code : 13273171

Catalog # : 12536ET3E444TS-W22G

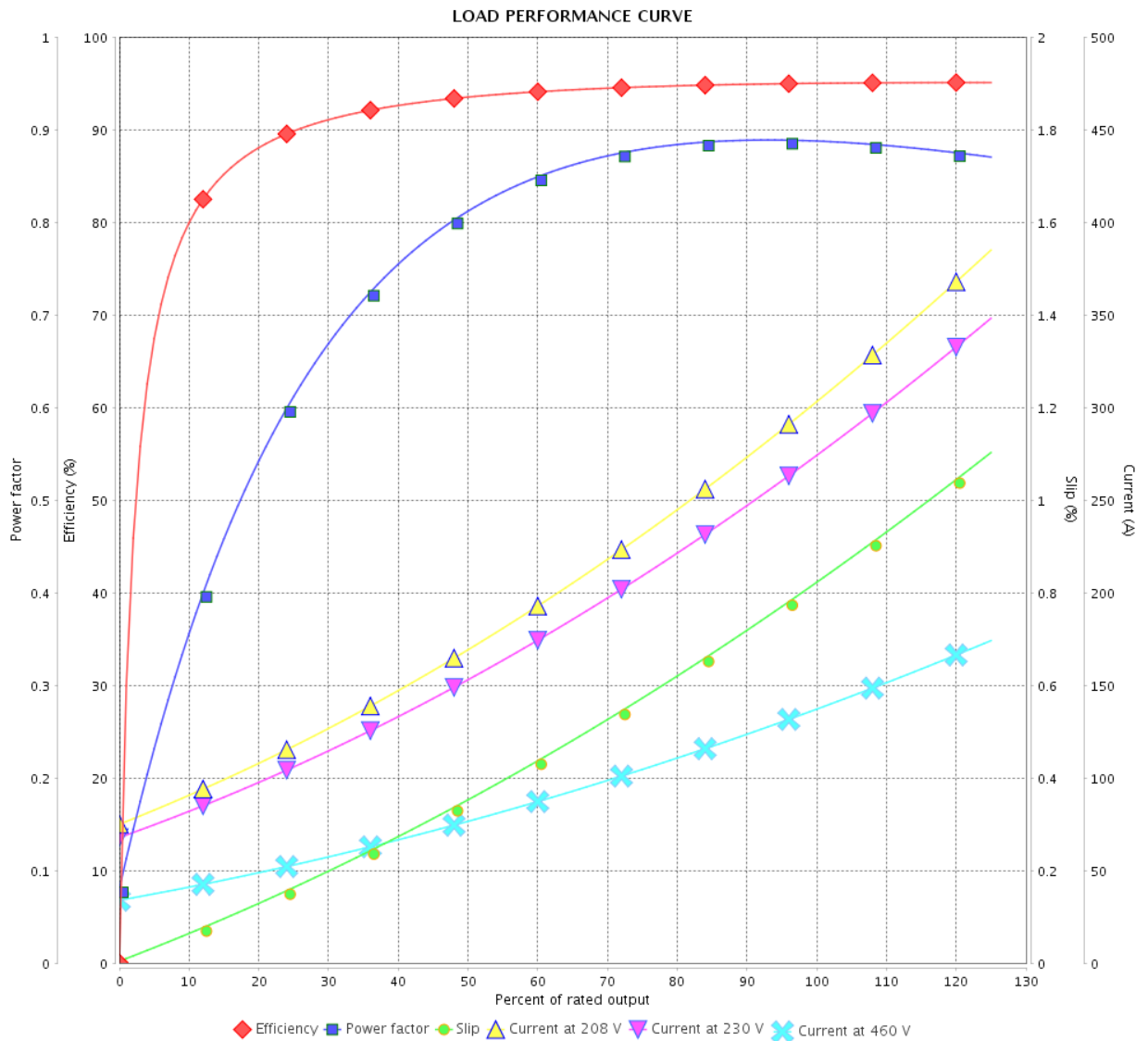

Performance : 230/460 V 60 Hz 2P

Rated current : 268/134 A
 LRC : 6.6
 Rated torque : 184 ft.lb
 Locked rotor torque : 200 %
 Breakdown torque : 250 %
 Rated speed : 3570 rpm

Moment of inertia (J) : 33.5 sq.ft.lb
 Duty cycle : Cont.(S1)
 Insulation class : F
 Service factor : 1.15
 Temperature rise : 80 K
 Design : B

Rev.	Changes Summary	Performed	Checked	Date
Performed by		Page		Revision
Checked by		9 / 36		
Date		13/04/2022		

LOAD PERFORMANCE CURVE

Three Phase Induction Motor - Squirrel Cage



Customer :

Product line : NEMA Premium Efficiency Three-Phase

Product code : 13273171

Catalog # : 12536ET3E444TS-W22G

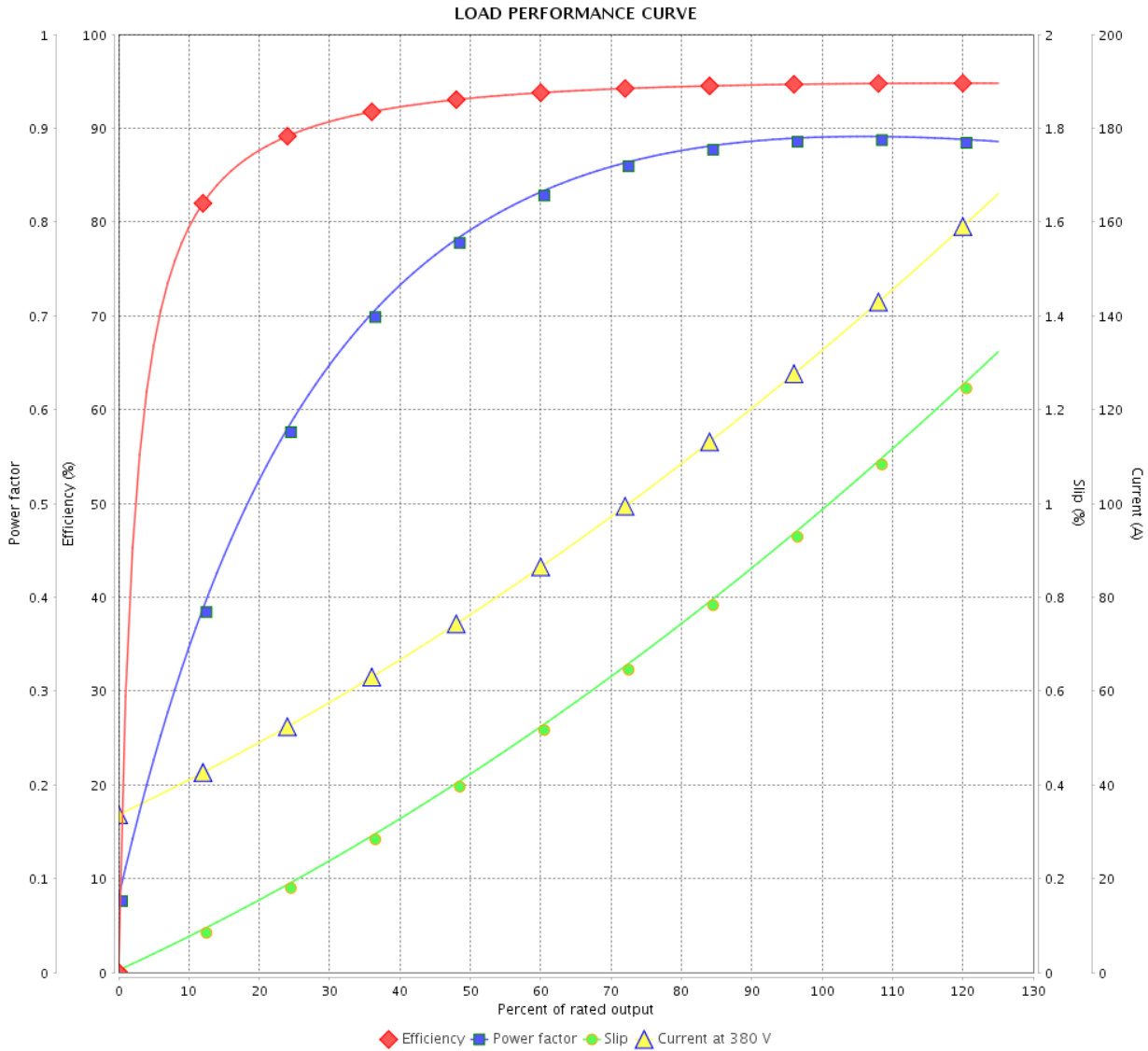

Performance : 380 V 50 Hz 2P IE3

Rated current : 135 A
 LRC : 6.5
 Rated torque : 177 ft.lb
 Locked rotor torque : 200 %
 Breakdown torque : 250 %
 Rated speed : 2970 rpm

Moment of inertia (J) : 33.5 sq.ft.lb
 Duty cycle : Cont.(S1)
 Insulation class : F
 Service factor : 1.00
 Temperature rise : 80 K
 Design : B

Rev.	Changes Summary	Performed	Checked	Date
Performed by			Page 10 / 36	Revision
Checked by				
Date	13/04/2022			

LOAD PERFORMANCE CURVE

Three Phase Induction Motor - Squirrel Cage



Customer : _____

Product line : NEMA Premium Efficiency Three-Phase

Product code : 13273171

Catalog # : 12536ET3E444TS-W22G

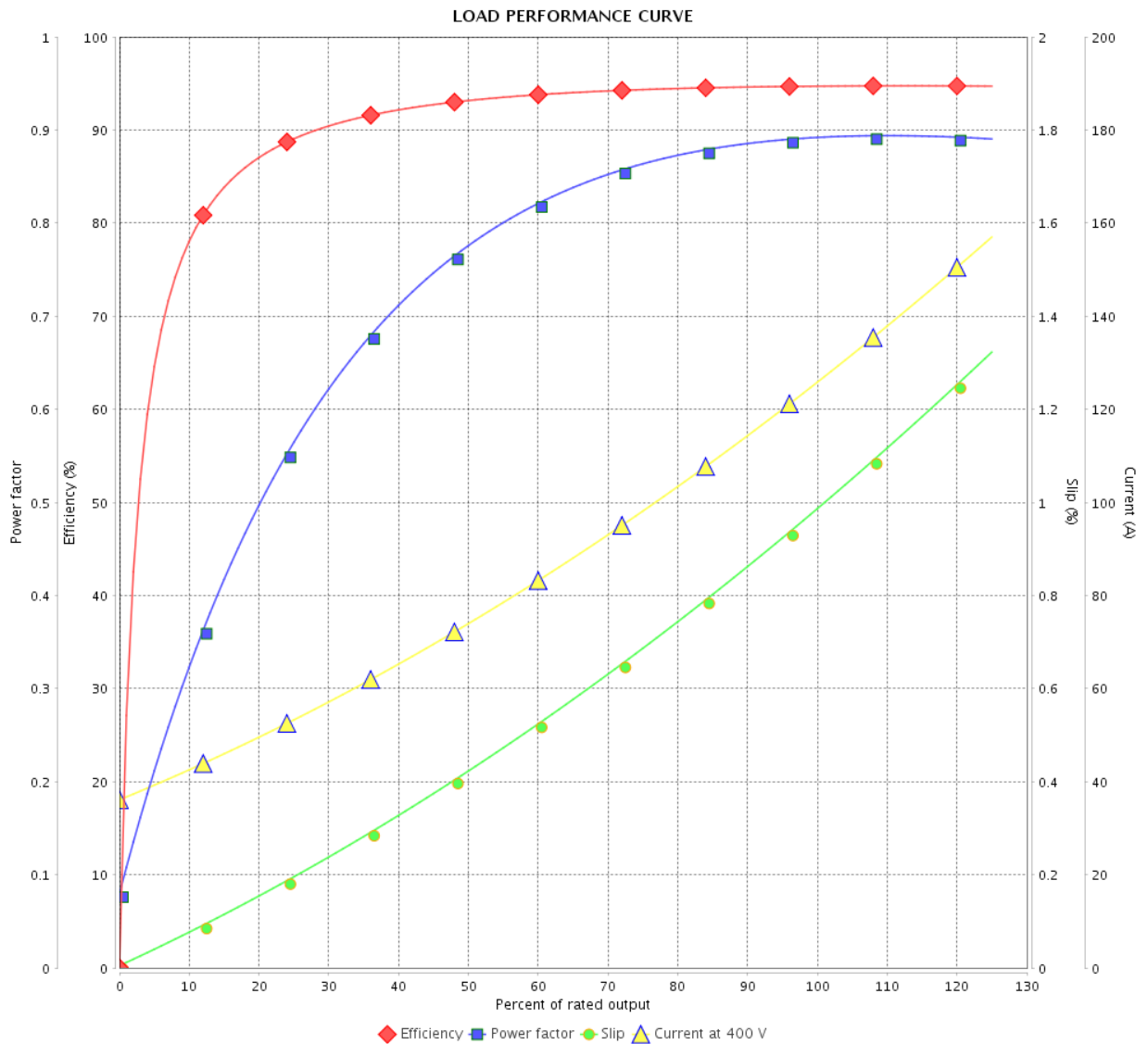

Performance : 400 V 50 Hz 2P IE3

Rated current : 128 A
 LRC : 7.1
 Rated torque : 177 ft.lb
 Locked rotor torque : 210 %
 Breakdown torque : 280 %
 Rated speed : 2970 rpm

Moment of inertia (J) : 33.5 sq.ft.lb
 Duty cycle : Cont.(S1)
 Insulation class : F
 Service factor : 1.00
 Temperature rise : 80 K
 Design : B

Rev.	Changes Summary	Performed	Checked	Date
Performed by		Page		Revision
Checked by		11 / 36		
Date		13/04/2022		

LOAD PERFORMANCE CURVE

Three Phase Induction Motor - Squirrel Cage



Customer :

Product line : NEMA Premium Efficiency Three-Phase

Product code : 13273171

Catalog # : 12536ET3E444TS-W22G

LOAD PERFORMANCE CURVE

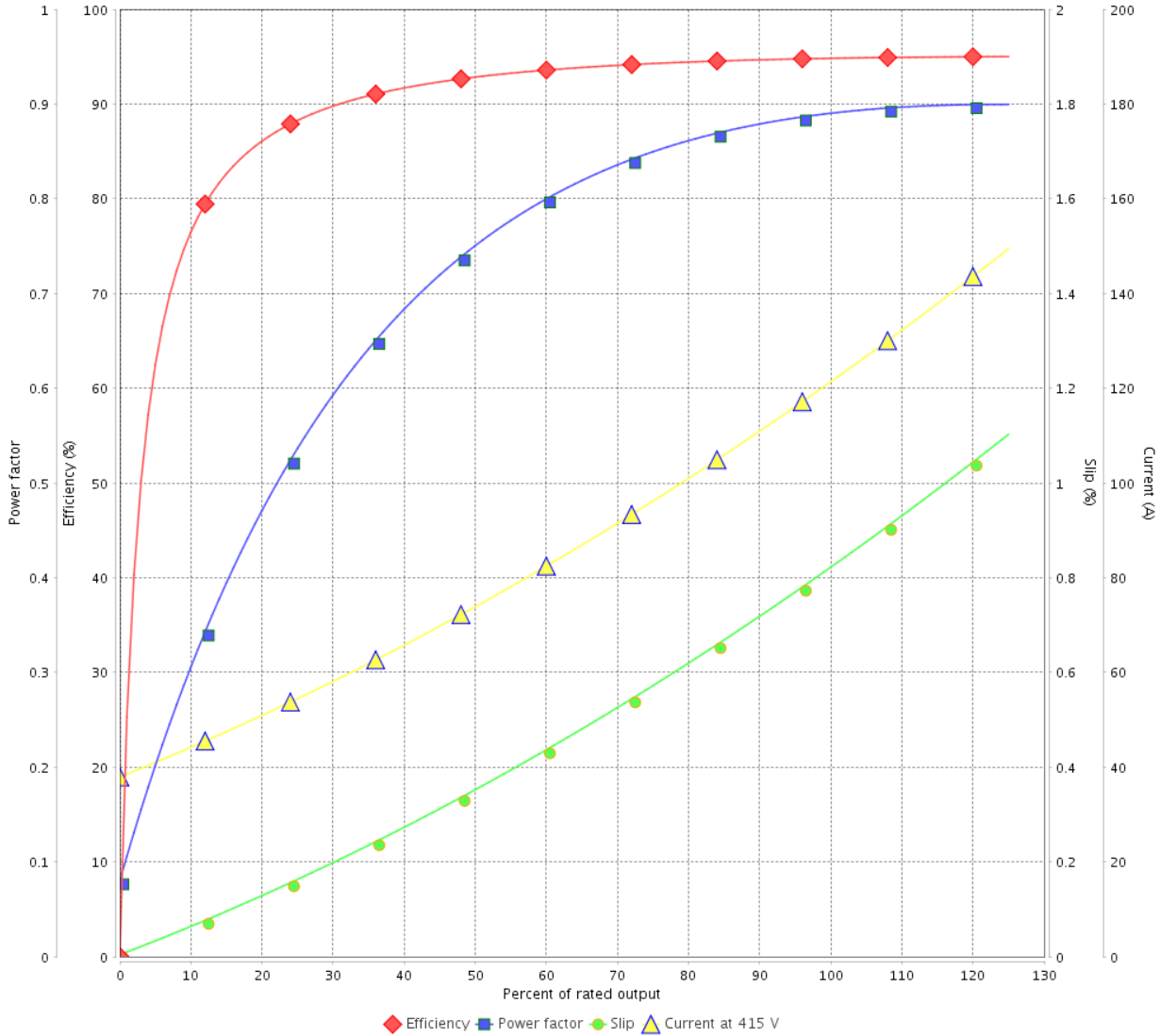

Performance : 415 V 50 Hz 2P IE3

Rated current : 124 A
 LRC : 7.7
 Rated torque : 177 ft.lb
 Locked rotor torque : 240 %
 Breakdown torque : 300 %
 Rated speed : 2975 rpm

Moment of inertia (J) : 33.5 sq.ft.lb
 Duty cycle : Cont.(S1)
 Insulation class : F
 Service factor : 1.00
 Temperature rise : 80 K
 Design : B

Rev.	Changes Summary	Performed	Checked	Date
Performed by		Page		Revision
Checked by		12 / 36		
Date	13/04/2022			

LOAD PERFORMANCE CURVE

Three Phase Induction Motor - Squirrel Cage



Customer : _____

Product line : NEMA Premium Efficiency Three-Phase

Product code : 13273171

Catalog # : 12536ET3E444TS-W22G

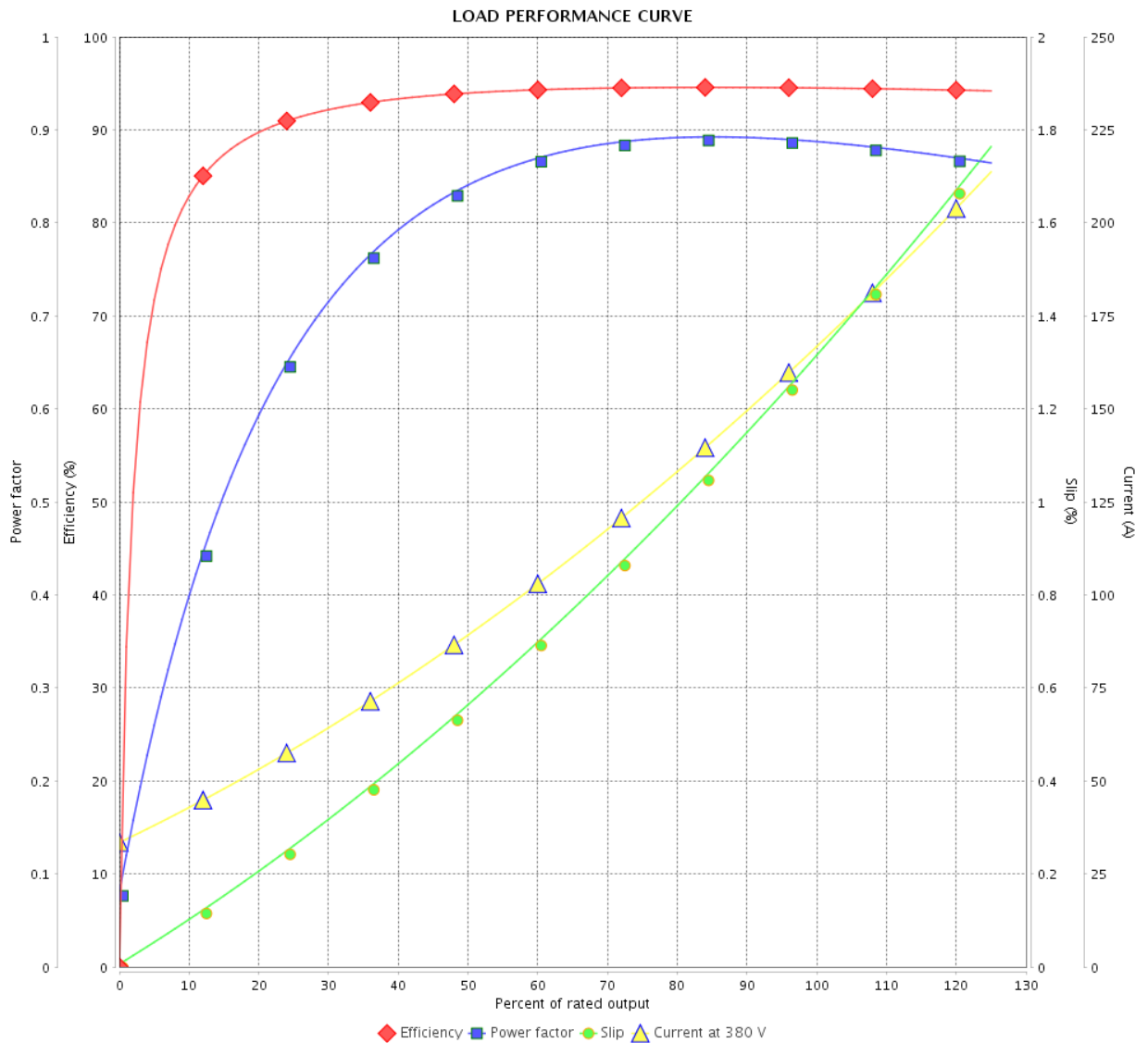

Performance : 380 V 50 Hz 2P IE2

Rated current : 163 A
 LRC : 5.2
 Rated torque : 222 ft.lb
 Locked rotor torque : 160 %
 Breakdown torque : 200 %
 Rated speed : 2960 rpm

Moment of inertia (J) : 33.5 sq.ft.lb
 Duty cycle : Cont.(S1)
 Insulation class : F
 Service factor : 1.00
 Temperature rise : 80 K
 Design : B

Rev.	Changes Summary	Performed	Checked	Date
Performed by				
Checked by				
Date				
		Page	Revision	
		13 / 36		

LOAD PERFORMANCE CURVE

Three Phase Induction Motor - Squirrel Cage



Customer : _____

Product line : NEMA Premium Efficiency Three-Phase

Product code : 13273171

Catalog # : 12536ET3E444TS-W22G

LOAD PERFORMANCE CURVE

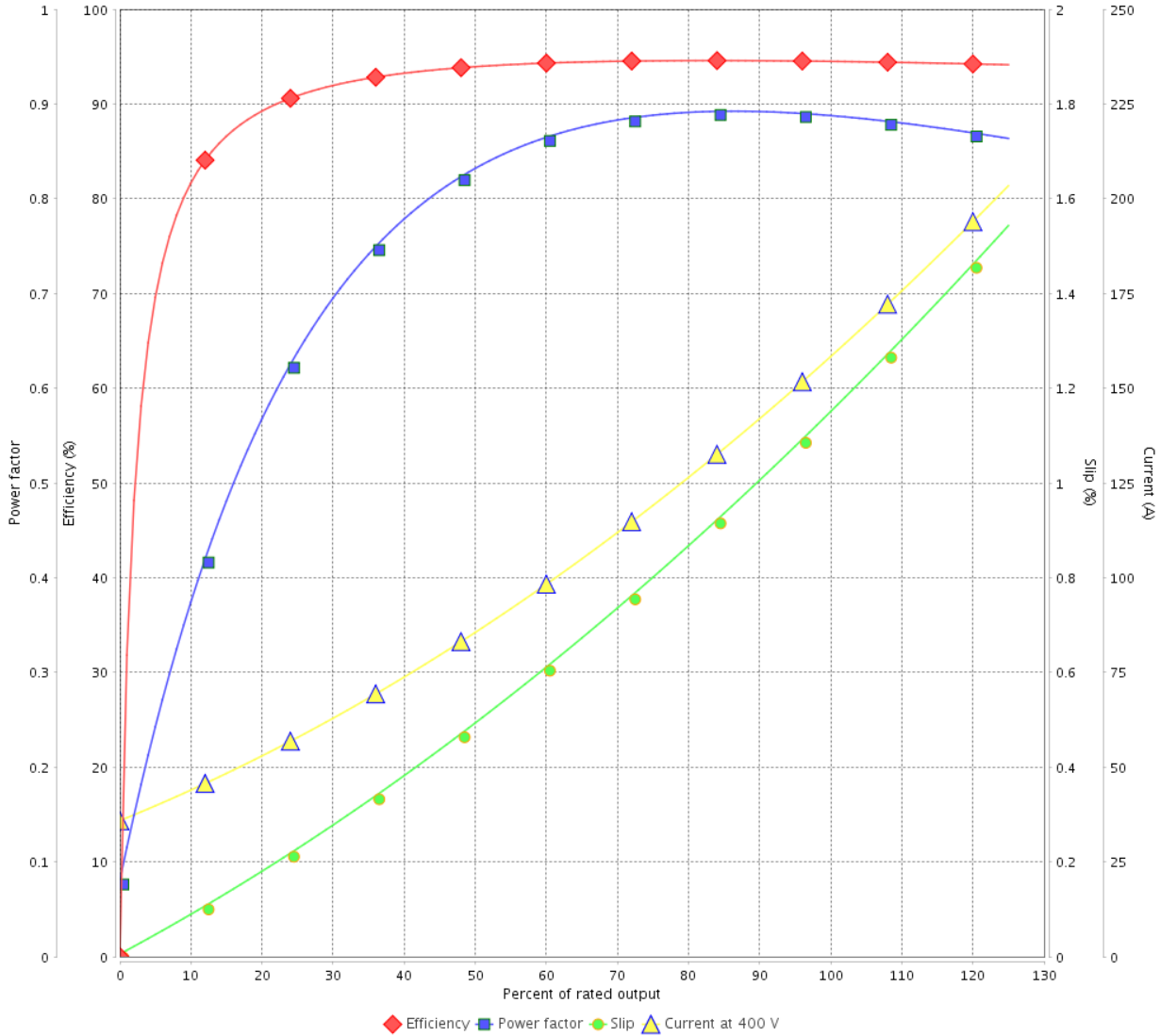

Performance : 400 V 50 Hz 2P IE2

Rated current : 154 A
 LRC : 5.7
 Rated torque : 221 ft.lb
 Locked rotor torque : 170 %
 Breakdown torque : 220 %
 Rated speed : 2965 rpm

Moment of inertia (J) : 33.5 sq.ft.lb
 Duty cycle : Cont.(S1)
 Insulation class : F
 Service factor : 1.00
 Temperature rise : 80 K
 Design : B

Rev.	Changes Summary	Performed	Checked	Date
Performed by		Page		Revision
Checked by		14 / 36		
Date	13/04/2022			

LOAD PERFORMANCE CURVE

Three Phase Induction Motor - Squirrel Cage



Customer :

Product line : NEMA Premium Efficiency Three-Phase

Product code : 13273171

Catalog # : 12536ET3E444TS-W22G

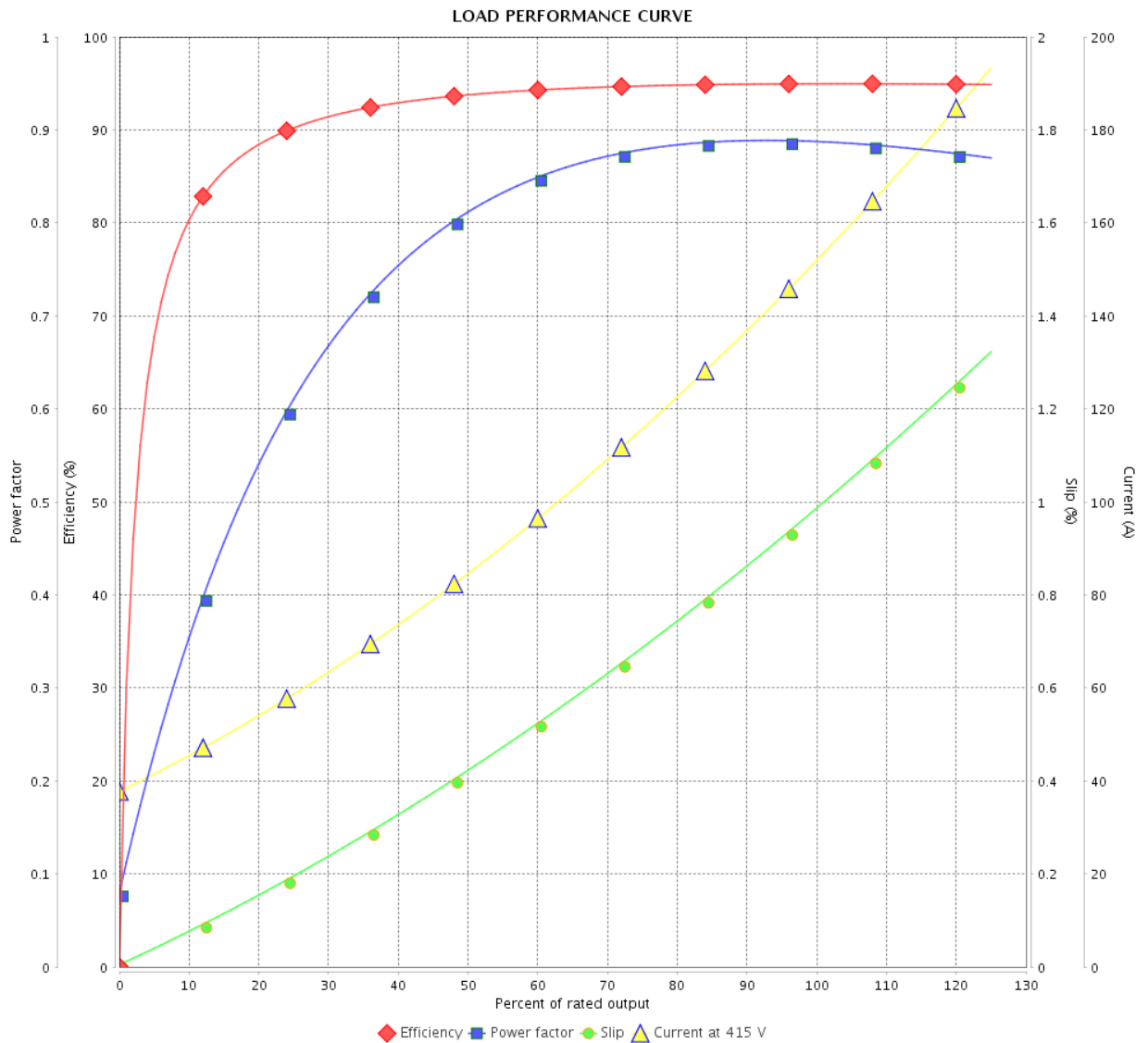

Performance : 415 V 50 Hz 2P IE3

Rated current : 148 A
 LRC : 6.2
 Rated torque : 221 ft.lb
 Locked rotor torque : 190 %
 Breakdown torque : 240 %
 Rated speed : 2970 rpm

Moment of inertia (J) : 33.5 sq.ft.lb
 Duty cycle : Cont.(S1)
 Insulation class : F
 Service factor : 1.00
 Temperature rise : 80 K
 Design : B

Rev.	Changes Summary	Performed	Checked	Date
Performed by		Page		Revision
Checked by		15 / 36		
Date		13/04/2022		

THERMAL LIMIT CURVE

Three Phase Induction Motor - Squirrel Cage



Customer :

Product line : NEMA Premium Efficiency Three-Phase
Product code : 13273171
Catalog # : 12536ET3E444TS-W22G

Performance : 230/460 V 60 Hz 2P

Rated current : 268/134 A	Moment of inertia (J) : 33.5 sq.ft.lb
LRC : 6.6	Duty cycle : Cont.(S1)
Rated torque : 184 ft.lb	Insulation class : F
Locked rotor torque : 200 %	Service factor : 1.15
Breakdown torque : 250 %	Temperature rise : 80 K
Rated speed : 3570 rpm	Design : B

Heating constant

Cooling constant

Rev.	Changes Summary	Performed	Checked	Date
Performed by		Page		Revision
Checked by		16 / 36		
Date	13/04/2022			

THERMAL LIMIT CURVE

Three Phase Induction Motor - Squirrel Cage



Customer : _____

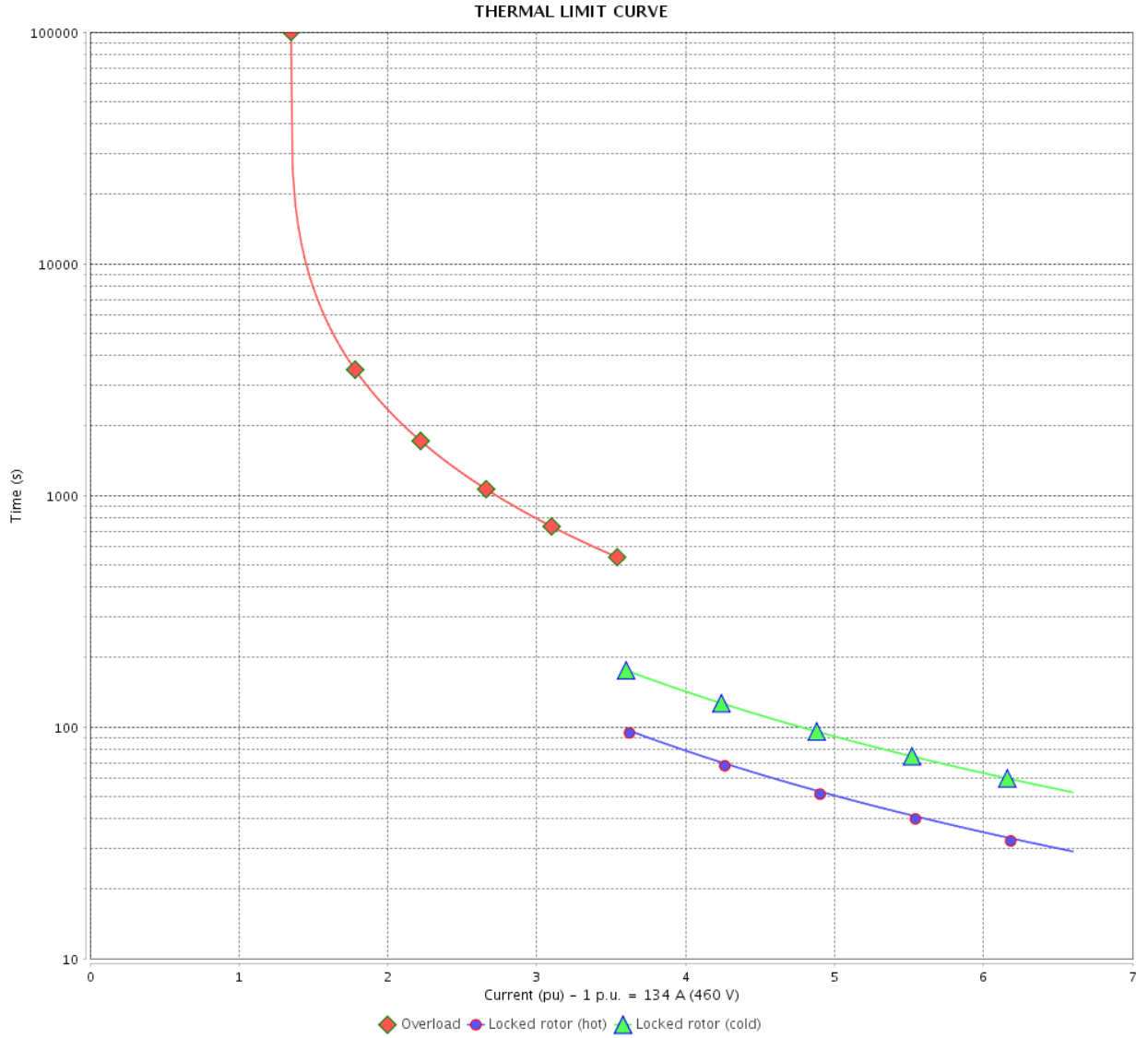

Rev.	Changes Summary	Performed	Checked	Date
Performed by		Page 17 / 36		Revision
Checked by				
Date				

THERMAL LIMIT CURVE



Three Phase Induction Motor - Squirrel Cage

Customer :

Product line : NEMA Premium Efficiency Three-Phase
Product code : 13273171
Catalog # : 12536ET3E444TS-W22G

Performance : 380 V 50 Hz 2P IE3

Rated current	: 135 A	Moment of inertia (J)	: 33.5 sq.ft.lb
LRC	: 6.5	Duty cycle	: Cont.(S1)
Rated torque	: 177 ft.lb	Insulation class	: F
Locked rotor torque	: 200 %	Service factor	: 1.00
Breakdown torque	: 250 %	Temperature rise	: 80 K
Rated speed	: 2970 rpm	Design	: B

Heating constant

Cooling constant

Rev.	Changes Summary	Performed	Checked	Date
Performed by				
Checked by			Page	Revision
Date	13/04/2022		18 / 36	

THERMAL LIMIT CURVE

Three Phase Induction Motor - Squirrel Cage



Customer : _____

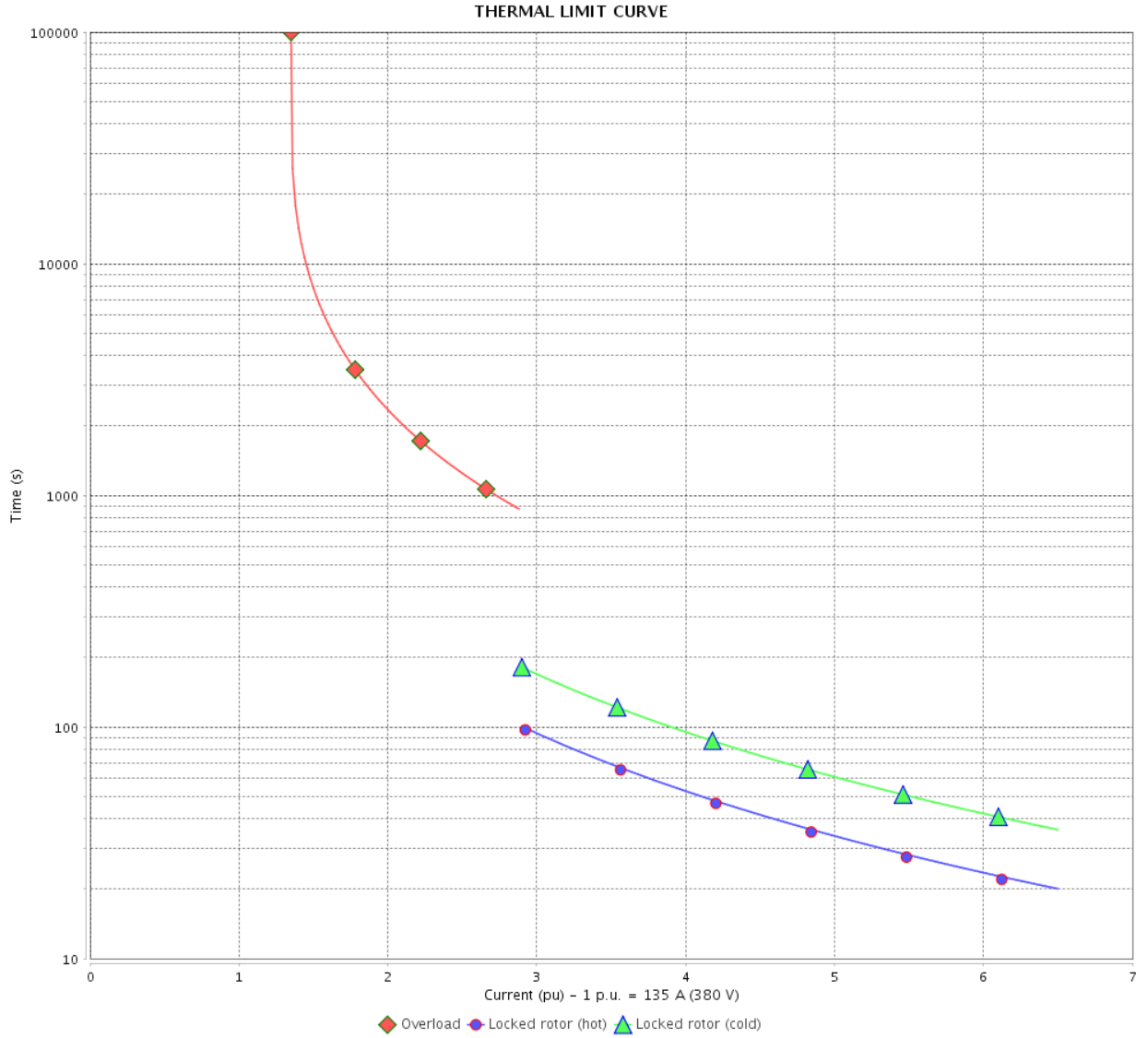

Rev.	Changes Summary	Performed	Checked	Date
Performed by		Page 19 / 36		Revision
Checked by				
Date				

THERMAL LIMIT CURVE



Three Phase Induction Motor - Squirrel Cage

Customer :

Product line : NEMA Premium Efficiency Three-Phase
Product code : 13273171
Catalog # : 12536ET3E444TS-W22G

Performance : 400 V 50 Hz 2P IE3

Rated current	: 128 A	Moment of inertia (J)	: 33.5 sq.ft.lb
LRC	: 7.1	Duty cycle	: Cont.(S1)
Rated torque	: 177 ft.lb	Insulation class	: F
Locked rotor torque	: 210 %	Service factor	: 1.00
Breakdown torque	: 280 %	Temperature rise	: 80 K
Rated speed	: 2970 rpm	Design	: B

Heating constant

Cooling constant

Rev.	Changes Summary	Performed	Checked	Date
Performed by				
Checked by			Page	Revision
Date	13/04/2022		20 / 36	

THERMAL LIMIT CURVE

Three Phase Induction Motor - Squirrel Cage



Customer : _____

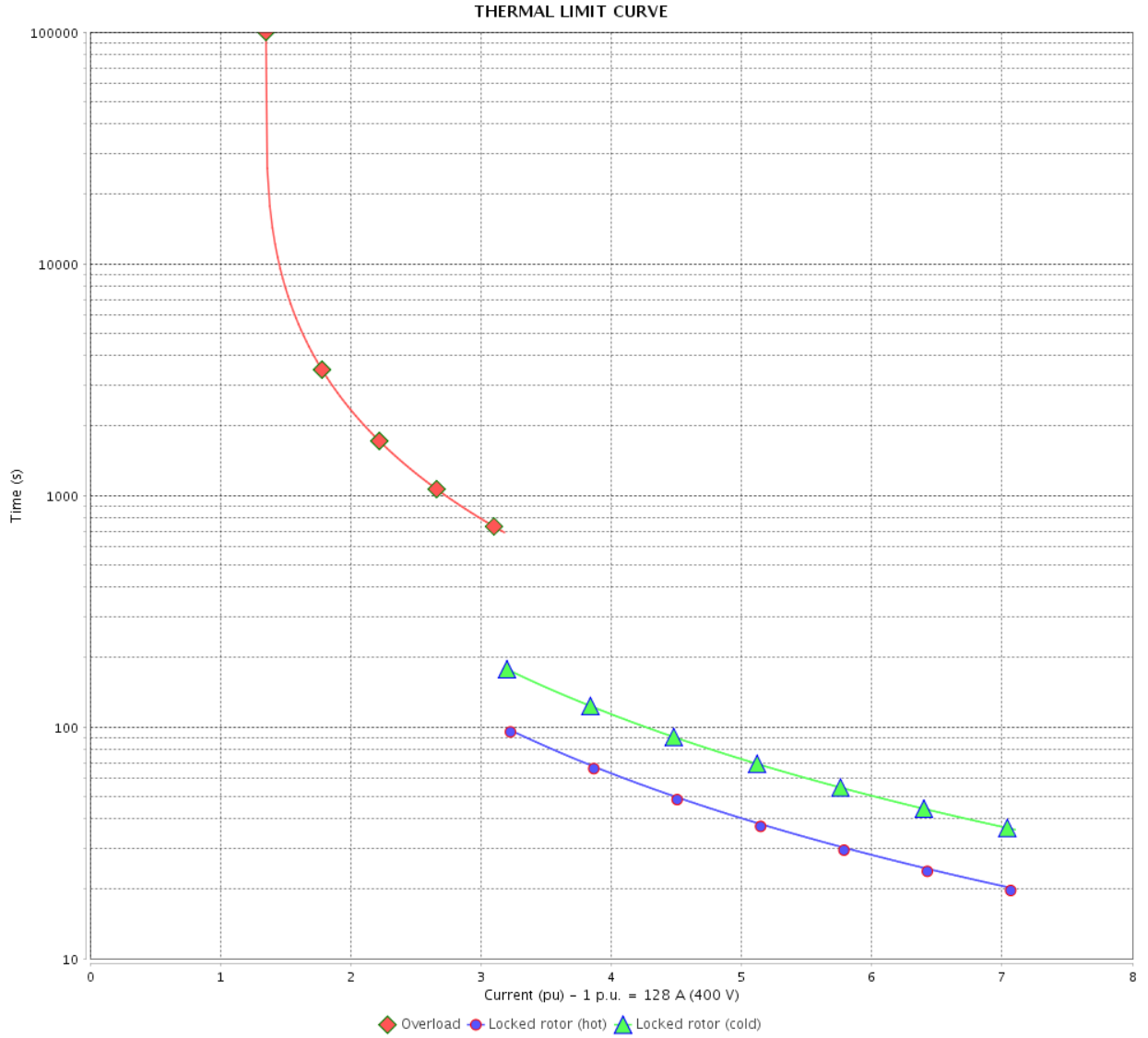

Rev.	Changes Summary	Performed	Checked	Date
Performed by		Page 21 / 36		Revision
Checked by				
Date				

THERMAL LIMIT CURVE



Three Phase Induction Motor - Squirrel Cage

Customer :

Product line : NEMA Premium Efficiency Three-Phase
Product code : 13273171
Catalog # : 12536ET3E444TS-W22G

Performance : 415 V 50 Hz 2P IE3

Rated current	: 124 A	Moment of inertia (J)	: 33.5 sq.ft.lb
LRC	: 7.7	Duty cycle	: Cont.(S1)
Rated torque	: 177 ft.lb	Insulation class	: F
Locked rotor torque	: 240 %	Service factor	: 1.00
Breakdown torque	: 300 %	Temperature rise	: 80 K
Rated speed	: 2975 rpm	Design	: B

Heating constant

Cooling constant

Rev.	Changes Summary	Performed	Checked	Date
Performed by				
Checked by			Page	Revision
Date	13/04/2022		22 / 36	

THERMAL LIMIT CURVE

Three Phase Induction Motor - Squirrel Cage



Customer : _____

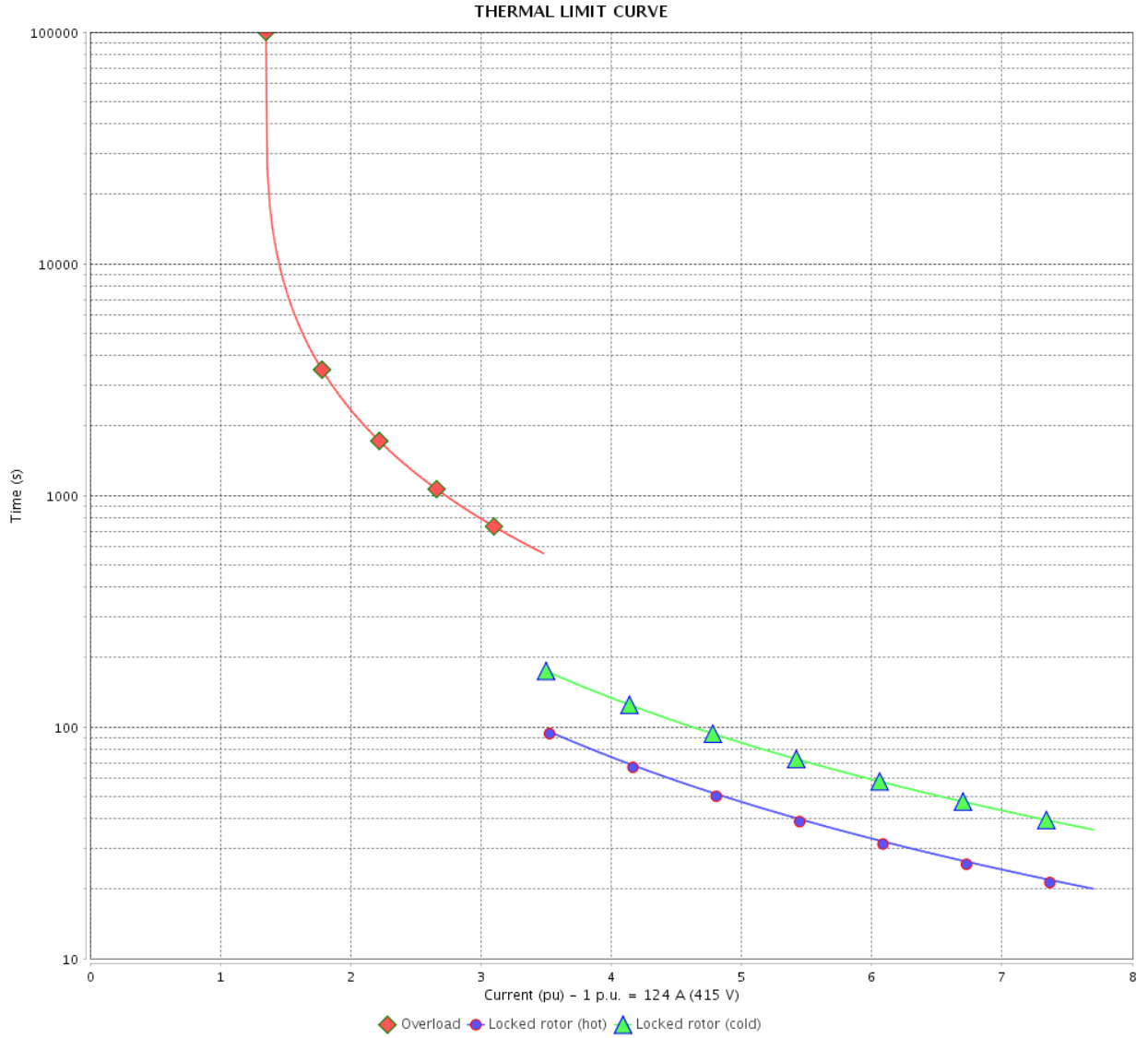

Rev.	Changes Summary	Performed	Checked	Date
Performed by		Page 23 / 36		Revision
Checked by				
Date				

THERMAL LIMIT CURVE

Three Phase Induction Motor - Squirrel Cage



Customer :

Product line : NEMA Premium Efficiency Three-Phase
Product code : 13273171
Catalog # : 12536ET3E444TS-W22G

Performance : 380 V 50 Hz 2P IE2

Rated current	: 163 A	Moment of inertia (J)	: 33.5 sq.ft.lb
LRC	: 5.2	Duty cycle	: Cont.(S1)
Rated torque	: 222 ft.lb	Insulation class	: F
Locked rotor torque	: 160 %	Service factor	: 1.00
Breakdown torque	: 200 %	Temperature rise	: 80 K
Rated speed	: 2960 rpm	Design	: B

Heating constant

Cooling constant

Rev.	Changes Summary	Performed	Checked	Date
Performed by				
Checked by			Page	Revision
Date	13/04/2022		24 / 36	

THERMAL LIMIT CURVE

Three Phase Induction Motor - Squirrel Cage



Customer : _____

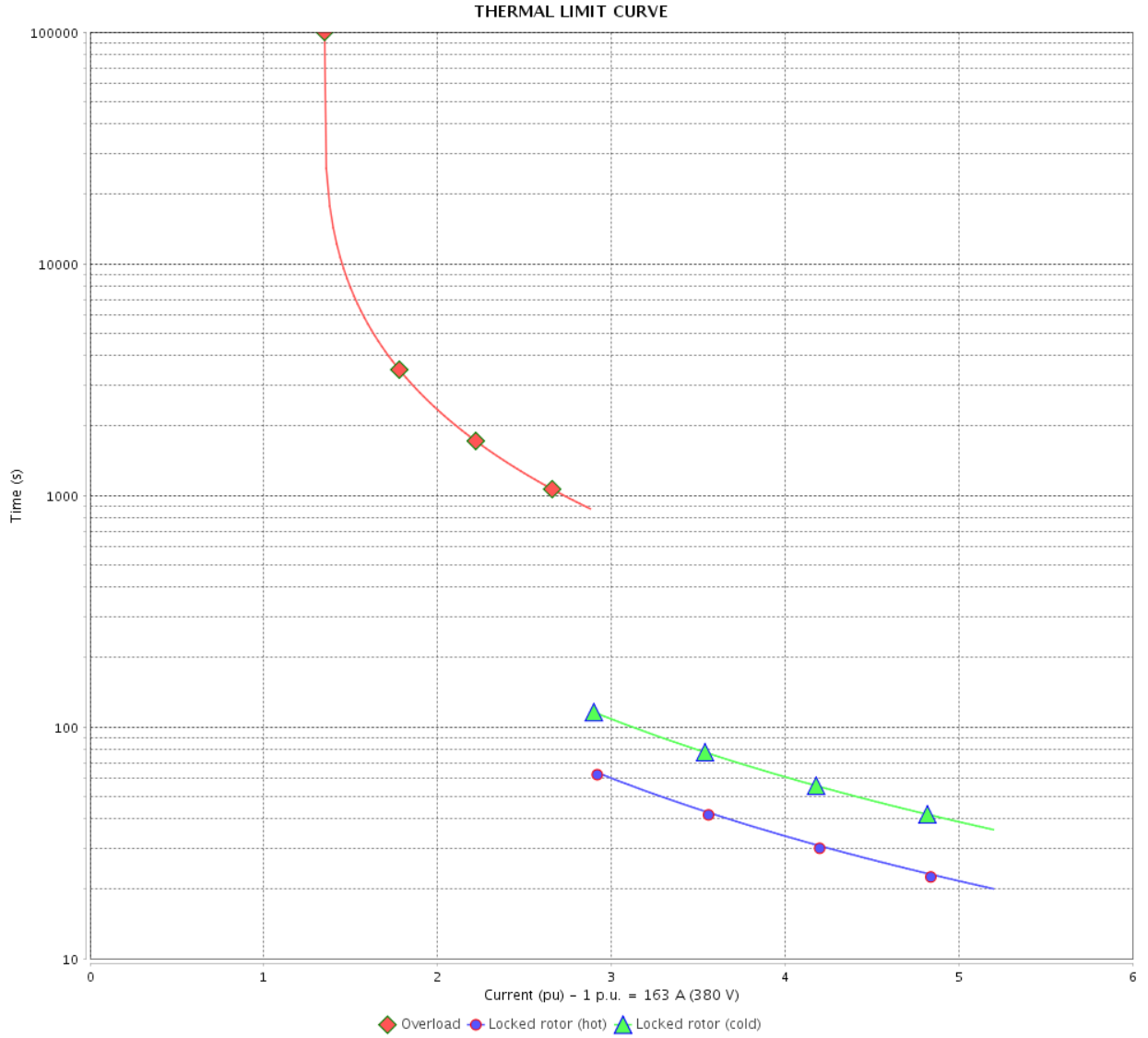

Rev.	Changes Summary	Performed	Checked	Date
Performed by		Page		Revision
Checked by		25 / 36		
Date		13/04/2022		

THERMAL LIMIT CURVE



Three Phase Induction Motor - Squirrel Cage

Customer :

Product line : NEMA Premium Efficiency Three-Phase
Product code : 13273171
Catalog # : 12536ET3E444TS-W22G

Performance : 400 V 50 Hz 2P IE2

Rated current	: 154 A	Moment of inertia (J)	: 33.5 sq.ft.lb
LRC	: 5.7	Duty cycle	: Cont.(S1)
Rated torque	: 221 ft.lb	Insulation class	: F
Locked rotor torque	: 170 %	Service factor	: 1.00
Breakdown torque	: 220 %	Temperature rise	: 80 K
Rated speed	: 2965 rpm	Design	: B

Heating constant

Cooling constant

Rev.	Changes Summary	Performed	Checked	Date
Performed by				
Checked by			Page	Revision
Date	13/04/2022		26 / 36	

THERMAL LIMIT CURVE

Three Phase Induction Motor - Squirrel Cage



Customer : _____

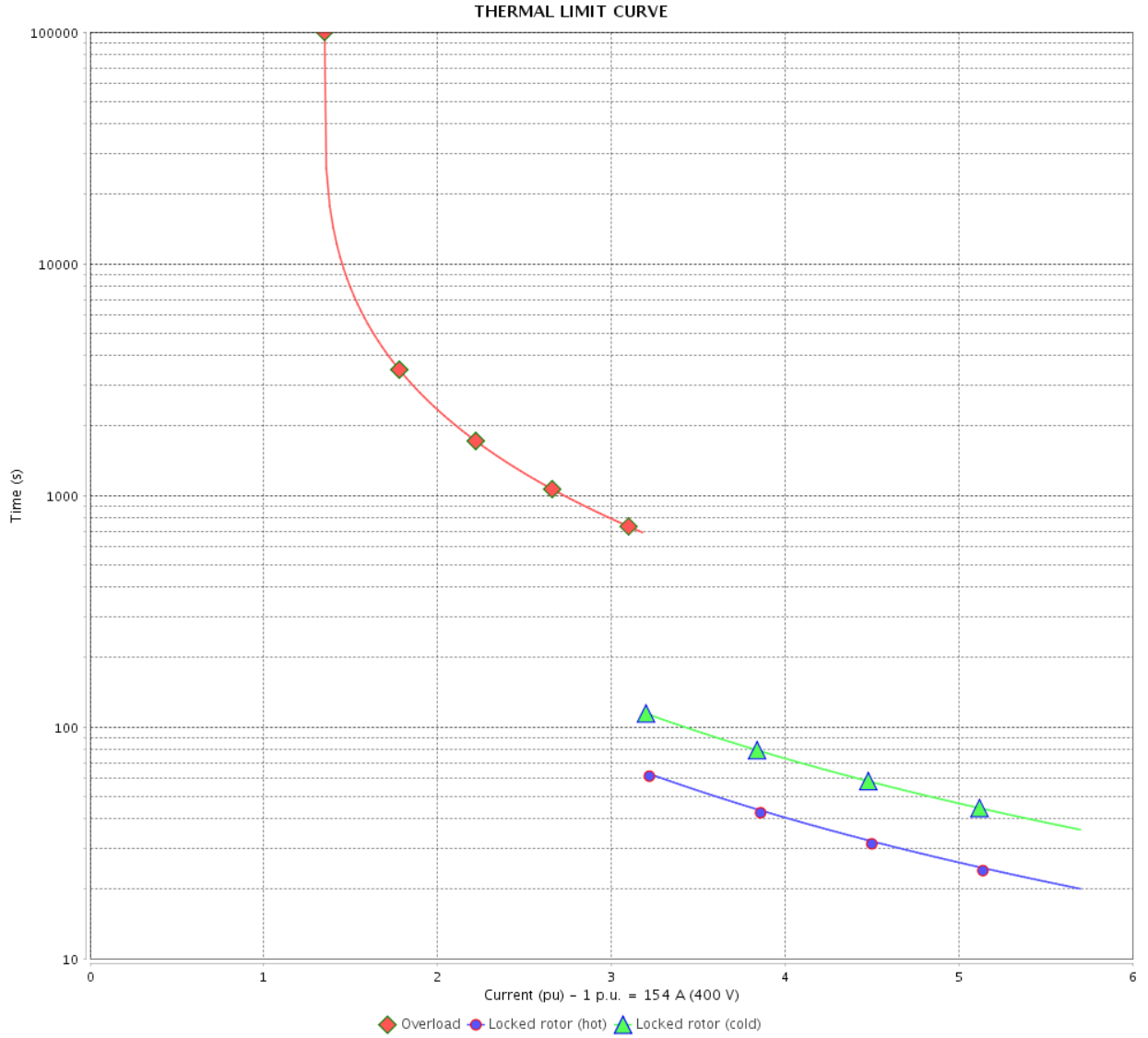

Rev.	Changes Summary	Performed	Checked	Date
Performed by		Page		Revision
Checked by		27 / 36		
Date		13/04/2022		

THERMAL LIMIT CURVE



Three Phase Induction Motor - Squirrel Cage

Customer :

Product line : NEMA Premium Efficiency Three-Phase
 Product code : 13273171
 Catalog # : 12536ET3E444TS-W22G

Performance : 415 V 50 Hz 2P IE3

Rated current : 148 A	Moment of inertia (J) : 33.5 sq.ft.lb
LRC : 6.2	Duty cycle : Cont.(S1)
Rated torque : 221 ft.lb	Insulation class : F
Locked rotor torque : 190 %	Service factor : 1.00
Breakdown torque : 240 %	Temperature rise : 80 K
Rated speed : 2970 rpm	Design : B

Heating constant

Cooling constant

Rev.	Changes Summary	Performed	Checked	Date
Performed by			Page 28 / 36	Revision
Checked by				
Date	13/04/2022			

THERMAL LIMIT CURVE

Three Phase Induction Motor - Squirrel Cage



Customer : _____

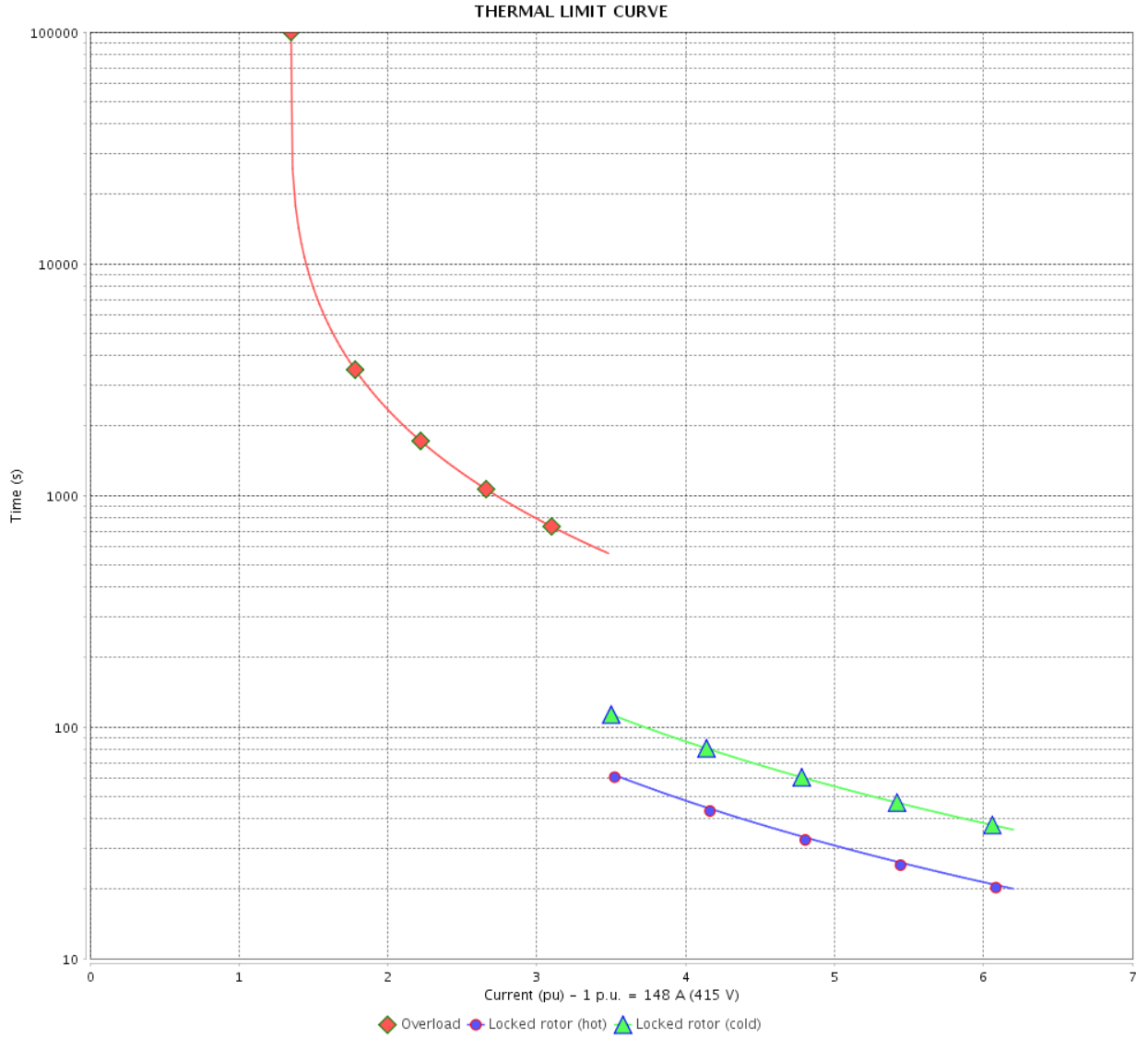

Rev.	Changes Summary	Performed	Checked	Date
Performed by		Page 29 / 36 Revision		
Checked by				
Date				

VFD OPERATION CURVE

Three Phase Induction Motor - Squirrel Cage



Customer : _____

Product line : NEMA Premium Efficiency Three-Phase

Product code : 13273171

Catalog # : 12536ET3E444TS-W22G

VFD OPERATION CURVE

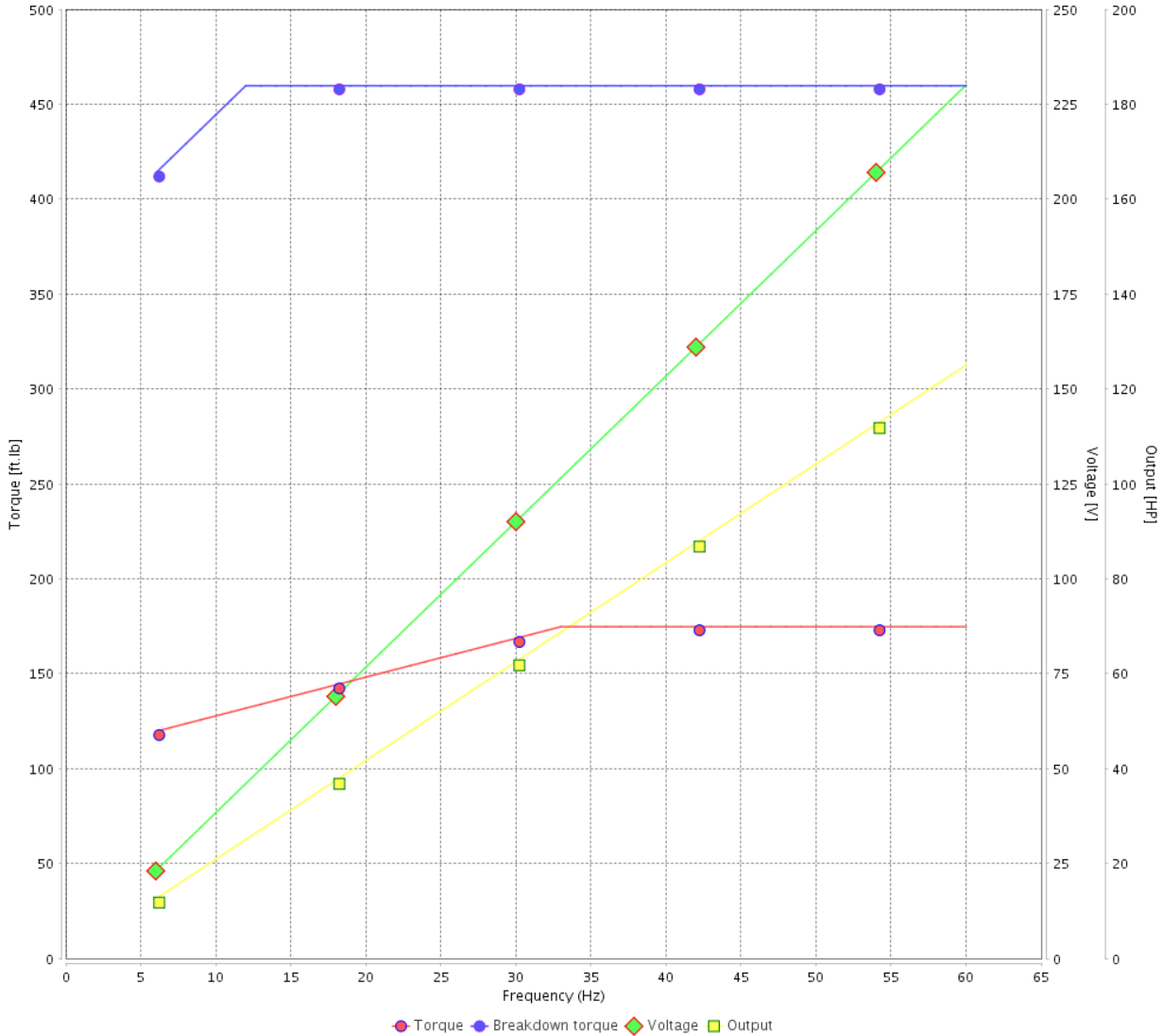

Performance : 230/460 V 60 Hz 2P

Rated current : 268/134 A
 LRC : 6.6
 Rated torque : 184 ft.lb
 Locked rotor torque : 200 %
 Breakdown torque : 250 %
 Rated speed : 3570 rpm

Moment of inertia (J) : 33.5 sq.ft.lb
 Duty cycle : Cont.(S1)
 Insulation class : F
 Service factor : 1.15
 Temperature rise : 80 K
 Design : B

Rev.	Changes Summary	Performed	Checked	Date
Performed by			Page 30 / 36	Revision
Checked by				
Date	13/04/2022			

VFD OPERATION CURVE

Three Phase Induction Motor - Squirrel Cage



Customer :

Product line : NEMA Premium Efficiency Three-Phase
 Product code : 13273171
 Catalog # : 12536ET3E444TS-W22G

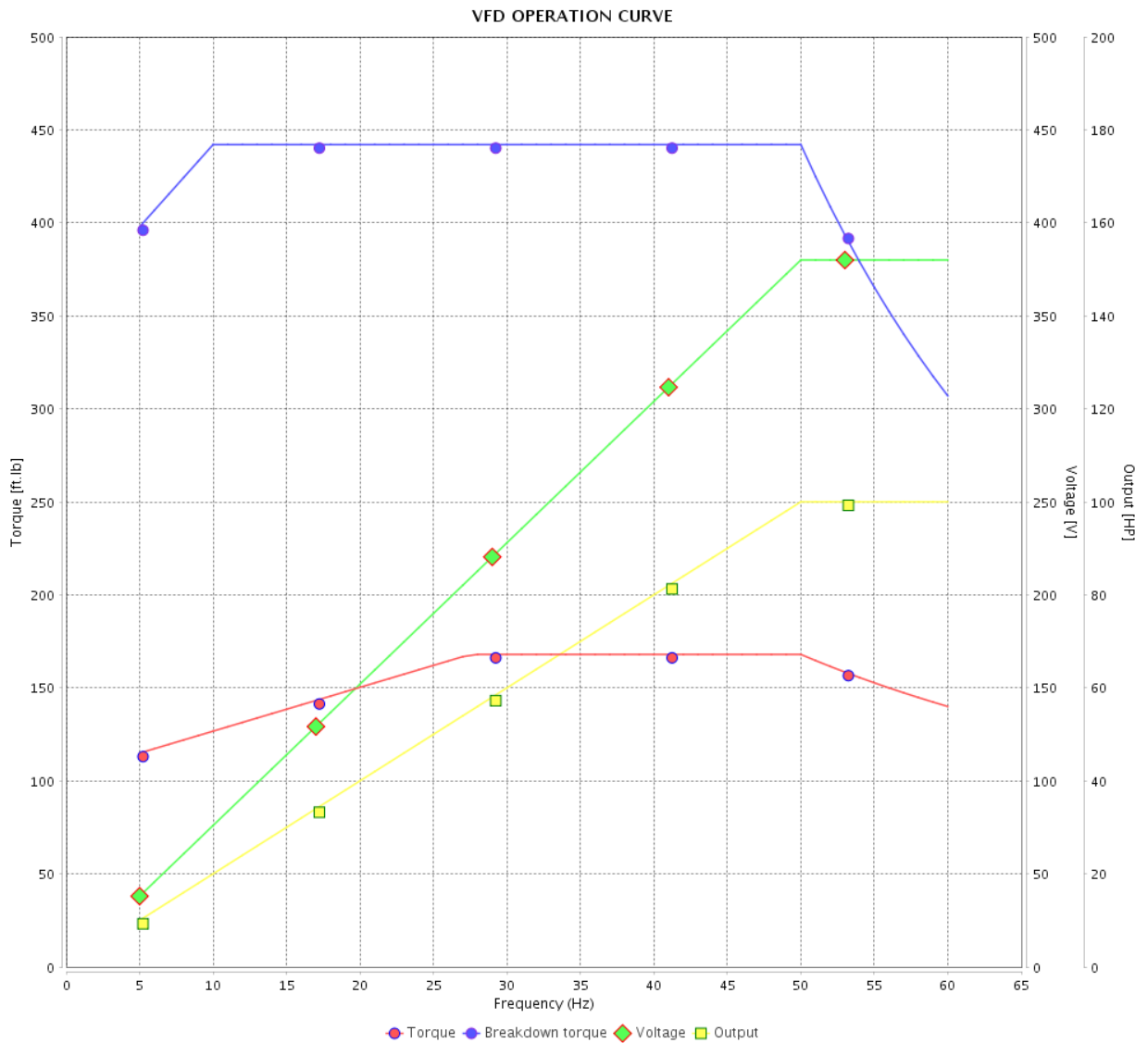

Performance : 380 V 50 Hz 2P IE3

Rated current : 135 A	Moment of inertia (J) : 33.5 sq.ft.lb
LRC : 6.5	Duty cycle : Cont.(S1)
Rated torque : 177 ft.lb	Insulation class : F
Locked rotor torque : 200 %	Service factor : 1.00
Breakdown torque : 250 %	Temperature rise : 80 K
Rated speed : 2970 rpm	Design : B

Rev.	Changes Summary	Performed	Checked	Date
Performed by			Page 31 / 36	Revision
Checked by				
Date	13/04/2022			

VFD OPERATION CURVE

Three Phase Induction Motor - Squirrel Cage



Customer :

Product line : NEMA Premium Efficiency Three-Phase

Product code : 13273171

Catalog # : 12536ET3E444TS-W22G

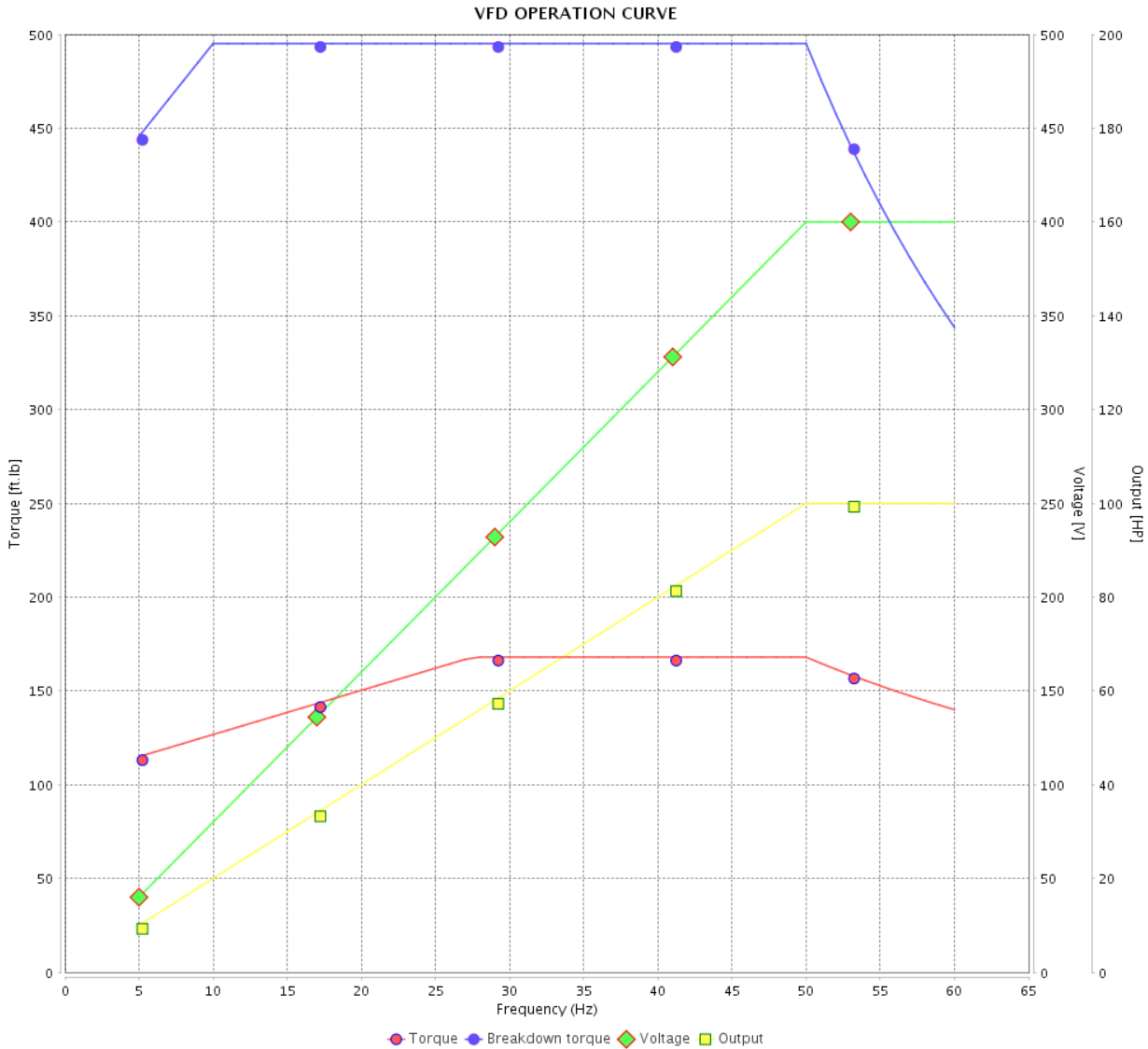

Performance : 400 V 50 Hz 2P IE3

Rated current	: 128 A	Moment of inertia (J)	: 33.5 sq.ft.lb
LRC	: 7.1	Duty cycle	: Cont.(S1)
Rated torque	: 177 ft.lb	Insulation class	: F
Locked rotor torque	: 210 %	Service factor	: 1.00
Breakdown torque	: 280 %	Temperature rise	: 80 K
Rated speed	: 2970 rpm	Design	: B

Rev.	Changes Summary	Performed	Checked	Date
Performed by			Page 32 / 36	Revision
Checked by				
Date	13/04/2022			

VFD OPERATION CURVE

Three Phase Induction Motor - Squirrel Cage



Customer :

Product line : NEMA Premium Efficiency Three-Phase
 Product code : 13273171
 Catalog # : 12536ET3E444TS-W22G

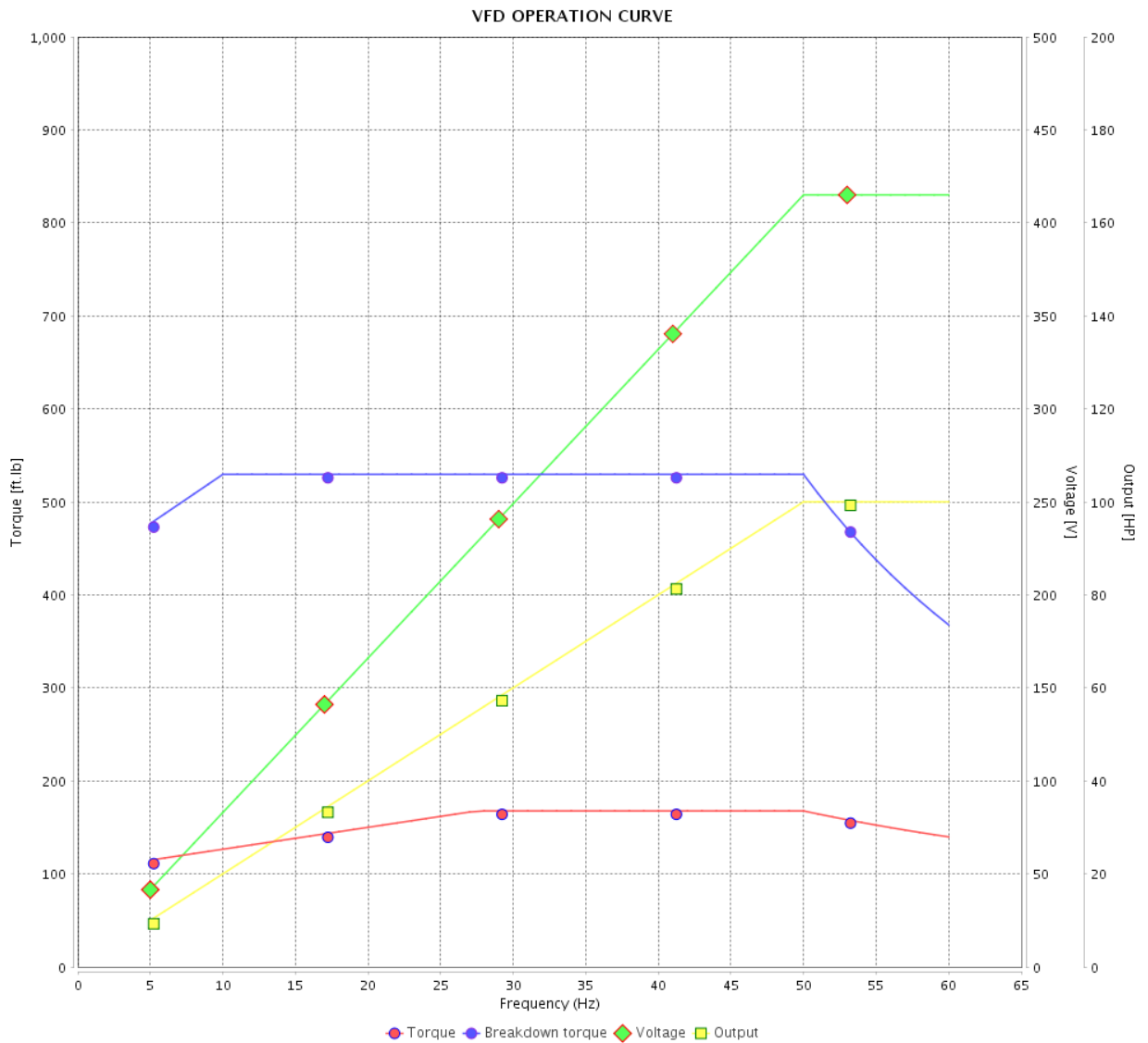

Performance : 415 V 50 Hz 2P IE3

Rated current : 124 A	Moment of inertia (J) : 33.5 sq.ft.lb
LRC : 7.7	Duty cycle : Cont.(S1)
Rated torque : 177 ft.lb	Insulation class : F
Locked rotor torque : 240 %	Service factor : 1.00
Breakdown torque : 300 %	Temperature rise : 80 K
Rated speed : 2975 rpm	Design : B

Rev.	Changes Summary	Performed	Checked	Date
Performed by			Page 33 / 36	Revision
Checked by				
Date	13/04/2022			

VFD OPERATION CURVE

Three Phase Induction Motor - Squirrel Cage



Customer :

Product line : NEMA Premium Efficiency Three-Phase

Product code : 13273171

Catalog # : 12536ET3E444TS-W22G

VFD OPERATION CURVE

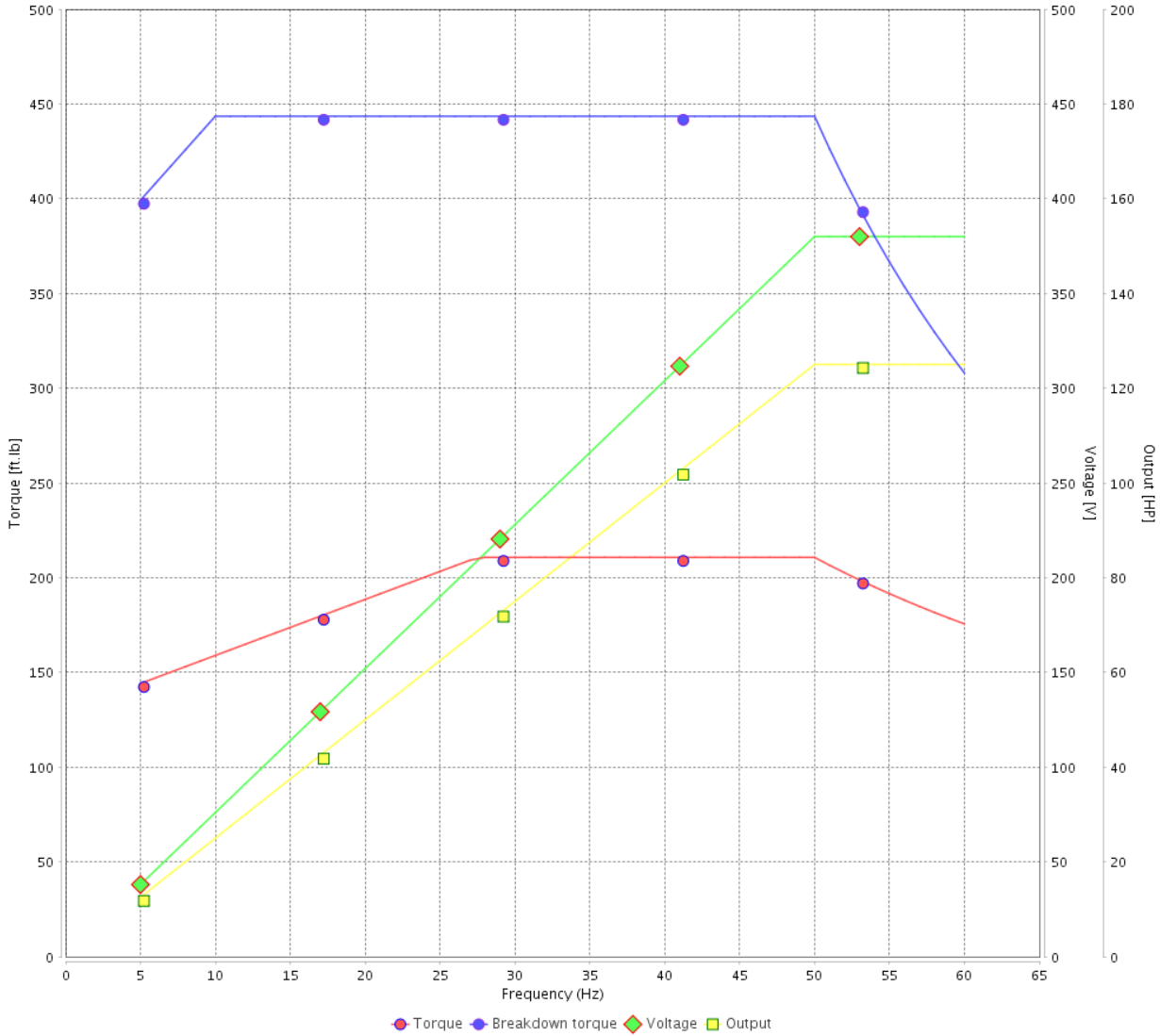

Performance : 380 V 50 Hz 2P IE2

Rated current	: 163 A	Moment of inertia (J)	: 33.5 sq.ft.lb
LRC	: 5.2	Duty cycle	: Cont.(S1)
Rated torque	: 222 ft.lb	Insulation class	: F
Locked rotor torque	: 160 %	Service factor	: 1.00
Breakdown torque	: 200 %	Temperature rise	: 80 K
Rated speed	: 2960 rpm	Design	: B

Rev.	Changes Summary	Performed	Checked	Date
Performed by			Page 34 / 36	Revision
Checked by				
Date	13/04/2022			

VFD OPERATION CURVE

Three Phase Induction Motor - Squirrel Cage



Customer : _____

Product line : NEMA Premium Efficiency Three-Phase

Product code : 13273171

Catalog # : 12536ET3E444TS-W22G

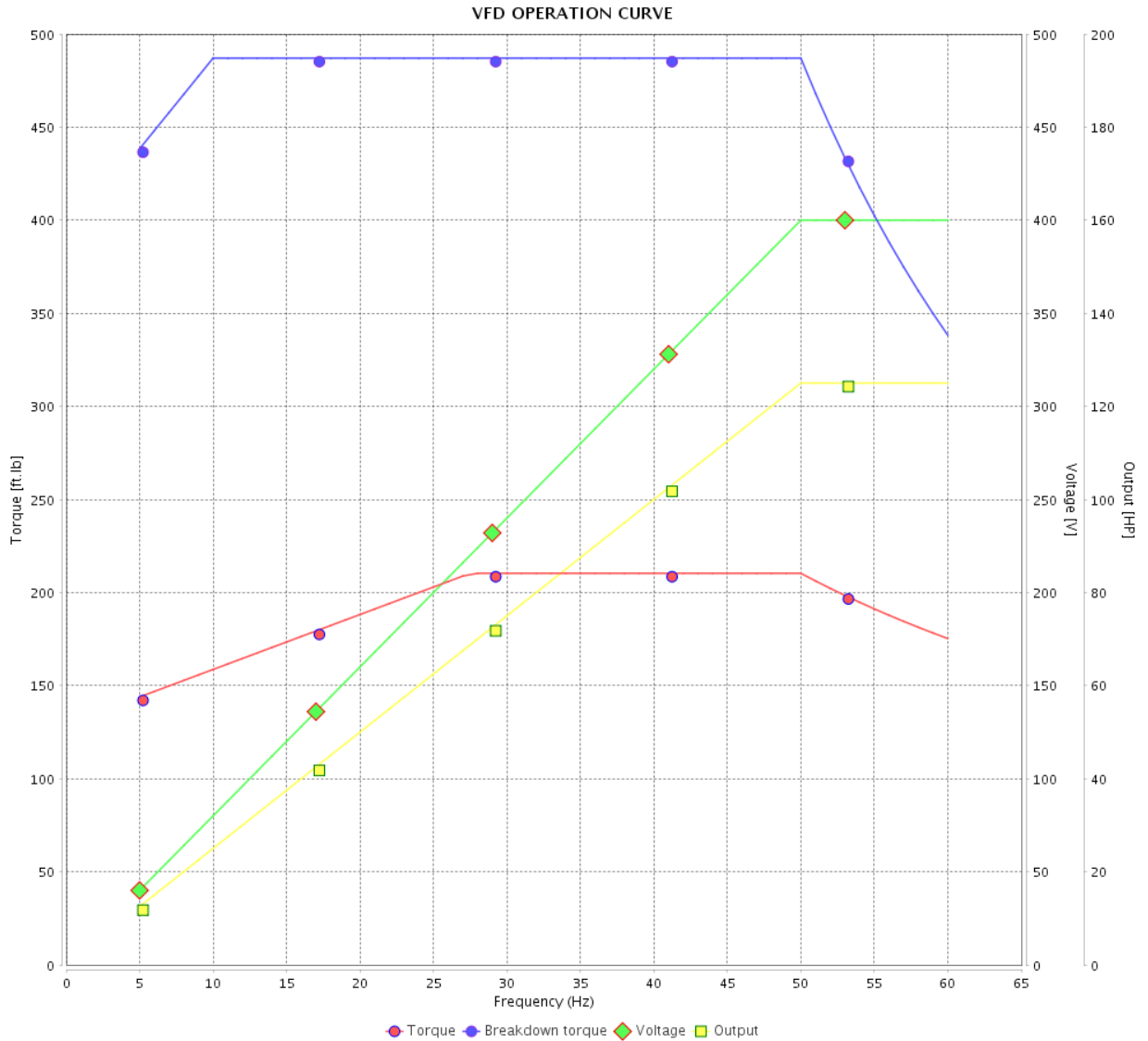

Performance : 400 V 50 Hz 2P IE2

Rated current : 154 A
 LRC : 5.7
 Rated torque : 221 ft.lb
 Locked rotor torque : 170 %
 Breakdown torque : 220 %
 Rated speed : 2965 rpm

Moment of inertia (J) : 33.5 sq.ft.lb
 Duty cycle : Cont.(S1)
 Insulation class : F
 Service factor : 1.00
 Temperature rise : 80 K
 Design : B

Rev.	Changes Summary	Performed	Checked	Date
Performed by			Page	Revision
Checked by				
Date				

VFD OPERATION CURVE

Three Phase Induction Motor - Squirrel Cage

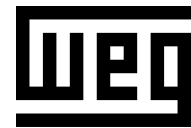

Customer :

Product line : NEMA Premium Efficiency Three-Phase

Product code : 13273171

Catalog # : 12536ET3E444TS-W22G

VFD OPERATION CURVE

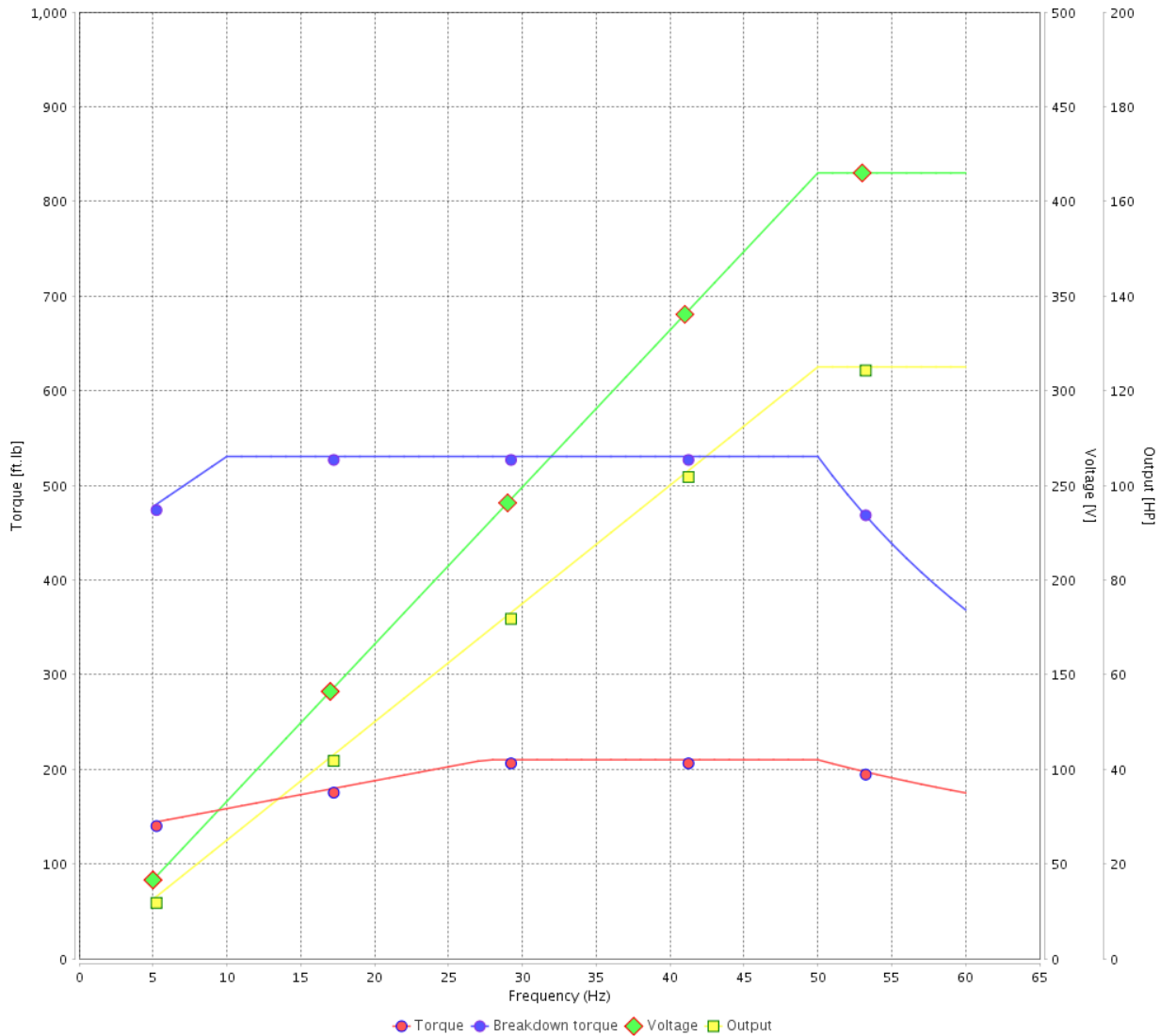

Performance : 415 V 50 Hz 2P IE3

Rated current : 148 A
 LRC : 6.2
 Rated torque : 221 ft.lb
 Locked rotor torque : 190 %
 Breakdown torque : 240 %
 Rated speed : 2970 rpm

Moment of inertia (J) : 33.5 sq.ft.lb
 Duty cycle : Cont.(S1)
 Insulation class : F
 Service factor : 1.00
 Temperature rise : 80 K
 Design : B

Rev.	Changes Summary	Performed	Checked	Date
Performed by			Page	Revision
Checked by				
Date				

1 2 3 4 5 6

A

B

C

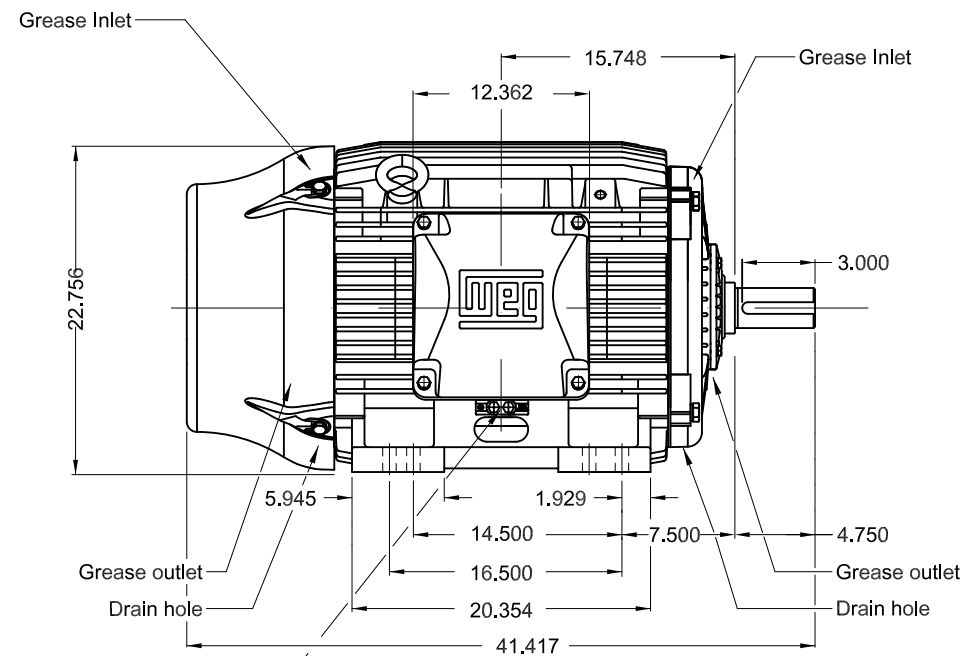
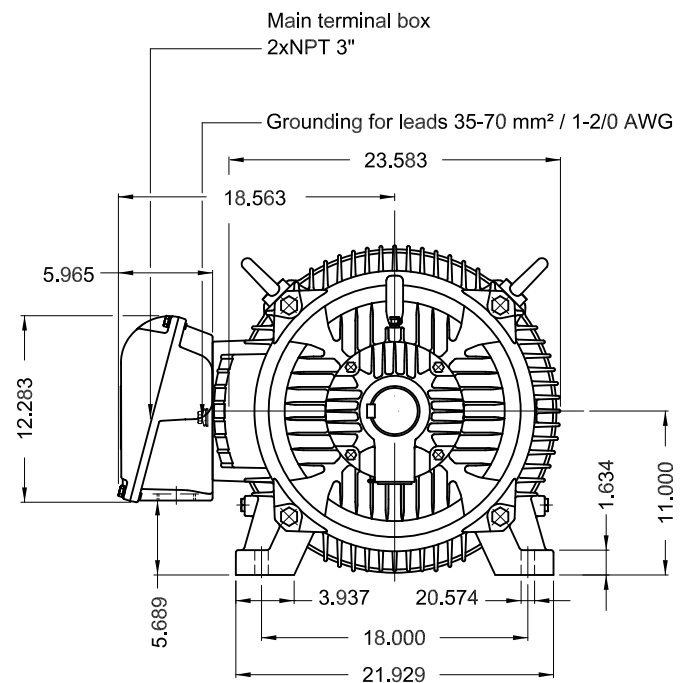

Grounding for leads 25-185 mm² / 3AWG-350MCM

D

E

- Internal AEGIS ground ring on the DE
- Color RAL 5009
- Painting plan 203A
- Mounting NEMA F-1
- Mounting B3R(D)

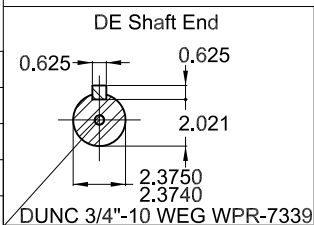

125 HP 02 Poles 60 Hz

A

ECM	LOC	SUMMARY OF MODIFICATIONS	EXECUTED	CHECKED	RELEASED	DATE	VER
EXECUTED	PIRWUSER	THREE PH. MOTOR W22 PREM. EFF.					
CHECKED		FRAME 444/5TS IP55 TEFC					
RELEASED							
REL DT.	WMO	Jaragua do Sul	Product Engineering	SHEET	1 / 1		

PREVIEW
WDD



Dimensions in inches

XME A3