

DATA SHEET

Three Phase Induction Motor - Squirrel Cage



Customer :					
Product line	: W40 NEMA Premium Efficiency Three-Phase	Product code :	14272435		
		Catalog # :	12536OT3G404TS-W40		
Frame	: 404/5TS	Cooling method	: IC01 - ODP		
Insulation class	: F	Mounting	: F-1		
Duty cycle	: Cont.(S1)	Rotation ¹	: Both (CW and CCW)		
Ambient temperature	: -20°C to +40°C	Starting method	: Direct On Line		
Altitude	: 1000 m.a.s.l.	Approx. weight ²	: 1837 lb		
Protection degree	: IP23	Moment of inertia (J)	: 8.23 sq.ft.lb		
Design	: B				
Output [HP]	125	100	100	100	
Poles	2	2	2	2	
Frequency [Hz]	60	50	50	50	
Rated voltage [V]	460	380	400	415	
Rated current [A]	136	137	133	131	
L. R. Amperes [A]	925	986	931	1022	
LRC [A]	6.8x(Code G)	7.2x(Code H)	7.0x(Code H)	7.8x(Code J)	
No load current [A]	36.0	33.0	36.5	40.0	
Rated speed [RPM]	3557	2955	2960	2965	
Slip [%]	1.19	1.50	1.33	1.17	
Rated torque [ft.lb]	185	178	177	177	
Locked rotor torque [%]	170	170	190	200	
Breakdown torque [%]	260	250	280	290	
Service factor	1.25	1.00	1.00	1.00	
Temperature rise	80 K	80 K	80 K	80 K	
Locked rotor time	21s (cold) 12s (hot)	16s (cold) 9s (hot)	19s (cold) 11s (hot)	16s (cold) 9s (hot)	
Noise level ²	84.0 dB(A)				
Efficiency (%)	25%	92.8	90.2	90.3	90.3
	50%	93.0	91.9	92.0	92.0
	75%	94.1	92.9	92.9	92.9
	100%	94.1	94.7	94.7	94.7
Power Factor	25%	0.57	0.59	0.55	0.48
	50%	0.79	0.80	0.77	0.70
	75%	0.86	0.86	0.84	0.80
	100%	0.88	0.88	0.86	0.84
Bearing type	: <u>Drive end</u> 6314 C3 <u>Non drive end</u> 6212 Z C3	Foundation loads			
Sealing	: Without Without	Max. traction	: 622 lb		
	: Bearing Seal Bearing Seal	Max. compression	: 2458 lb		
Lubrication interval	: 14418 h 20000 h				
Lubricant amount	: 27 g 13 g				
Lubricant type	: Mobil Polyrex EM				
Notes					
This revision replaces and cancel the previous one, which must be eliminated. (1) Looking the motor from the shaft end. (2) Measured at 1m and with tolerance of +3dB(A). (3) Approximate weight subject to changes after manufacturing process. (4) At 100% of full load.			These are average values based on tests with sinusoidal power supply, subject to the tolerances stipulated in NEMA MG-1.		
Rev.	Changes Summary		Performed	Checked	Date
Performed by					
Checked by				Page	Revision
Date	13/04/2022			1 / 21	

TORQUE AND CURRENT VS SPEED CURVE

Three Phase Induction Motor - Squirrel Cage



Customer :

Product line : W40 NEMA Premium Efficiency
Three-Phase

Product code : 14272435

Catalog # : 12536OT3G404TS-W40

TORQUE AND CURRENT VS SPEED CURVE

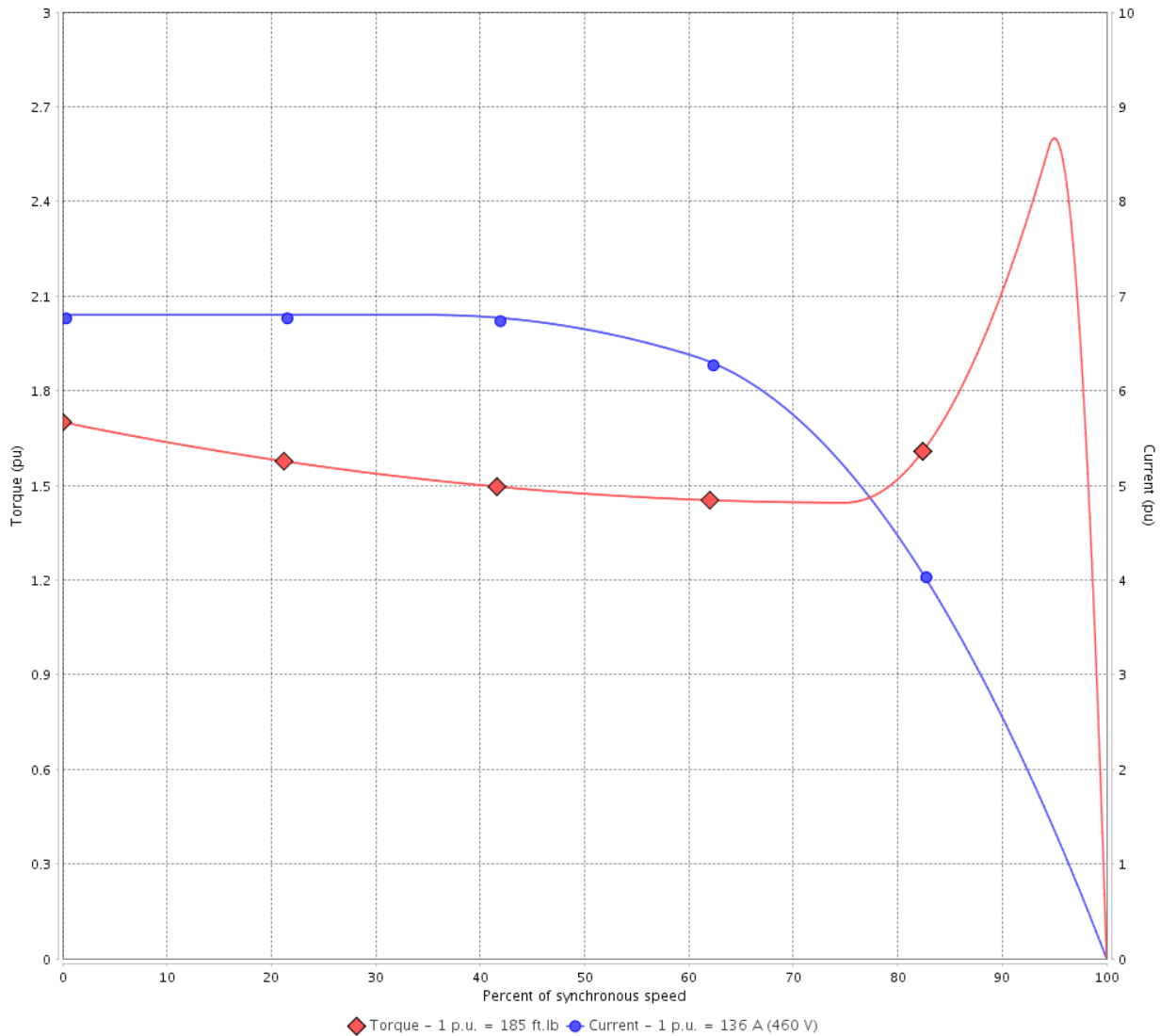

Performance : 460 V 60 Hz 2P

Rated current	: 136 A	Moment of inertia (J)	: 8.23 sq.ft.lb
LRC	: 6.8	Duty cycle	: Cont.(S1)
Rated torque	: 185 ft.lb	Insulation class	: F
Locked rotor torque	: 170 %	Service factor	: 1.25
Breakdown torque	: 260 %	Temperature rise	: 80 K
Rated speed	: 3557 rpm	Design	: B

Locked rotor time : 21s (cold) 12s (hot)

Rev.	Changes Summary	Performed	Checked	Date
Performed by			Page 2 / 21	Revision
Checked by				
Date	13/04/2022			

TORQUE AND CURRENT VS SPEED CURVE



Three Phase Induction Motor - Squirrel Cage

Customer :

Product line : W40 NEMA Premium Efficiency
Three-Phase

Product code : 14272435

Catalog # : 12536OT3G404TS-W40

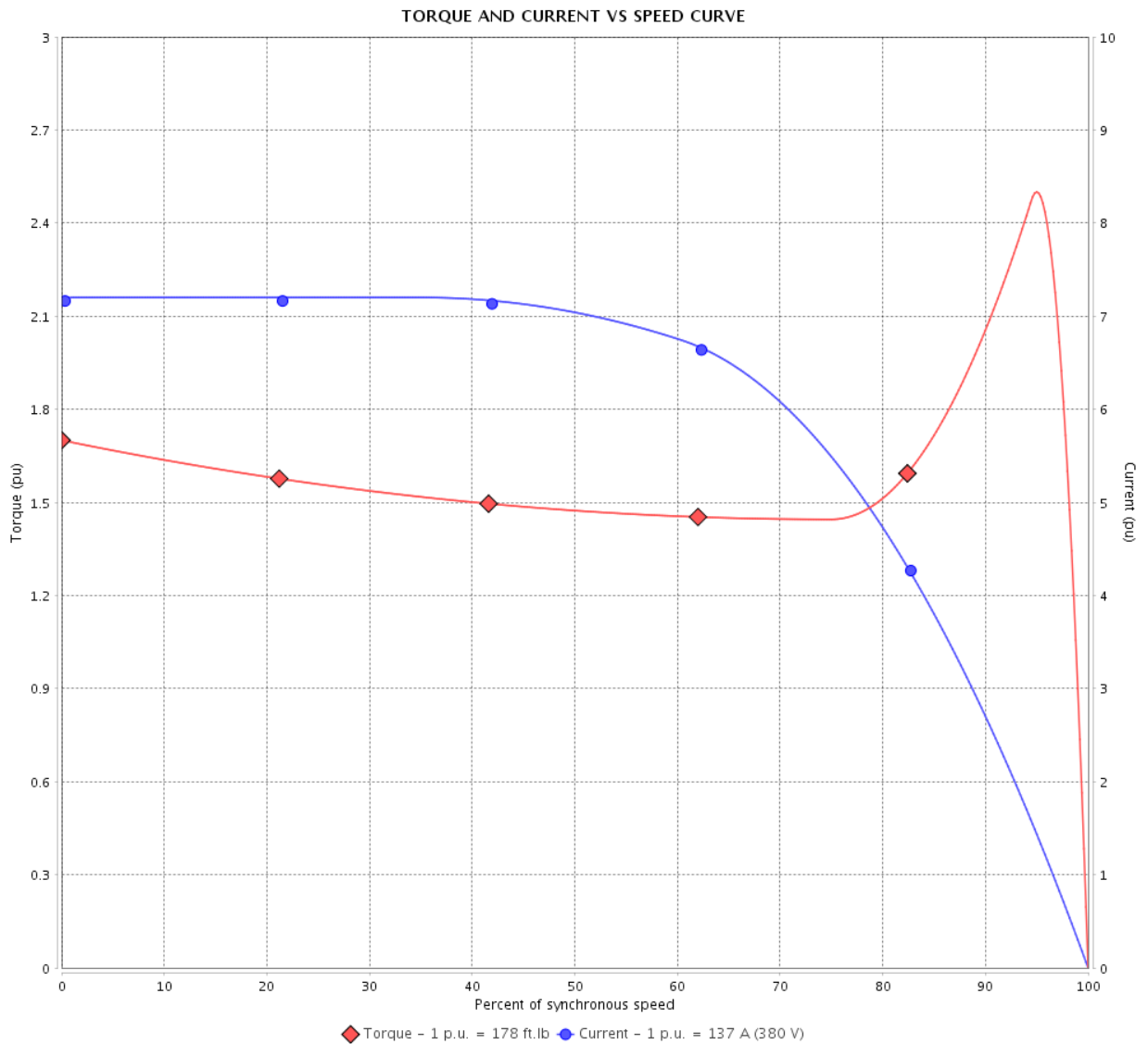

Performance : 380 V 50 Hz 2P IE3

Rated current	: 137 A	Moment of inertia (J)	: 8.23 sq.ft.lb
LRC	: 7.2	Duty cycle	: Cont.(S1)
Rated torque	: 178 ft.lb	Insulation class	: F
Locked rotor torque	: 170 %	Service factor	: 1.00
Breakdown torque	: 250 %	Temperature rise	: 80 K
Rated speed	: 2955 rpm	Design	: B

Locked rotor time : 16s (cold) 9s (hot)

Rev.	Changes Summary	Performed	Checked	Date
Performed by			Page	Revision
Checked by				
Date	13/04/2022			
			3 / 21	

TORQUE AND CURRENT VS SPEED CURVE

Three Phase Induction Motor - Squirrel Cage



Customer :

Product line : W40 NEMA Premium Efficiency
Three-Phase

Product code : 14272435

Catalog # : 12536OT3G404TS-W40

TORQUE AND CURRENT VS SPEED CURVE

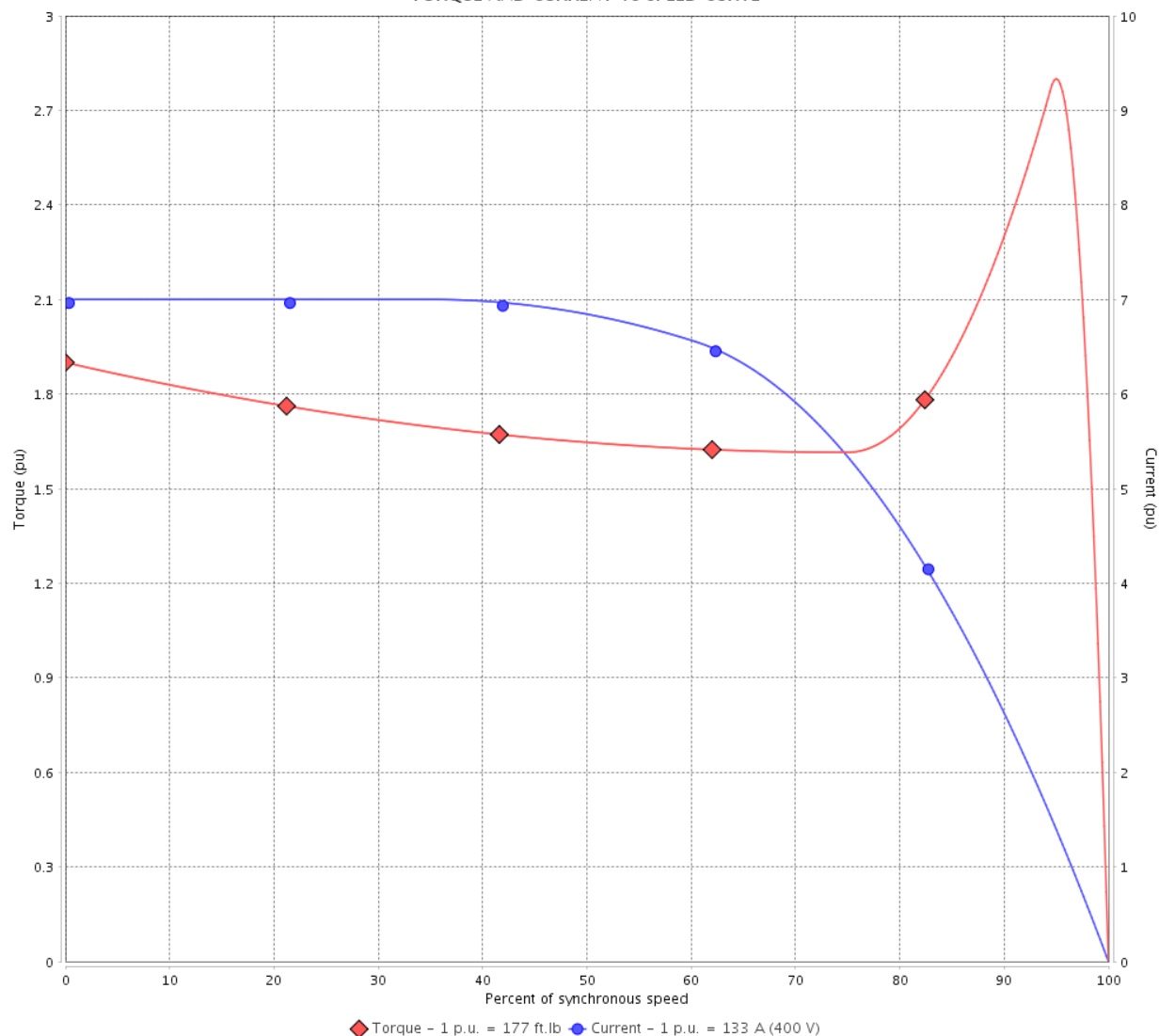

Performance : 400 V 50 Hz 2P IE3

Rated current	: 133 A	Moment of inertia (J)	: 8.23 sq.ft.lb
LRC	: 7.0	Duty cycle	: Cont.(S1)
Rated torque	: 177 ft.lb	Insulation class	: F
Locked rotor torque	: 190 %	Service factor	: 1.00
Breakdown torque	: 280 %	Temperature rise	: 80 K
Rated speed	: 2960 rpm	Design	: B

Locked rotor time : 19s (cold) 11s (hot)

Rev.	Changes Summary	Performed	Checked	Date
Performed by			Page 4 / 21	Revision
Checked by				
Date	13/04/2022			

TORQUE AND CURRENT VS SPEED CURVE



Three Phase Induction Motor - Squirrel Cage

Customer :

Product line : W40 NEMA Premium Efficiency
Three-Phase

Product code : 14272435

Catalog # : 12536OT3G404TS-W40

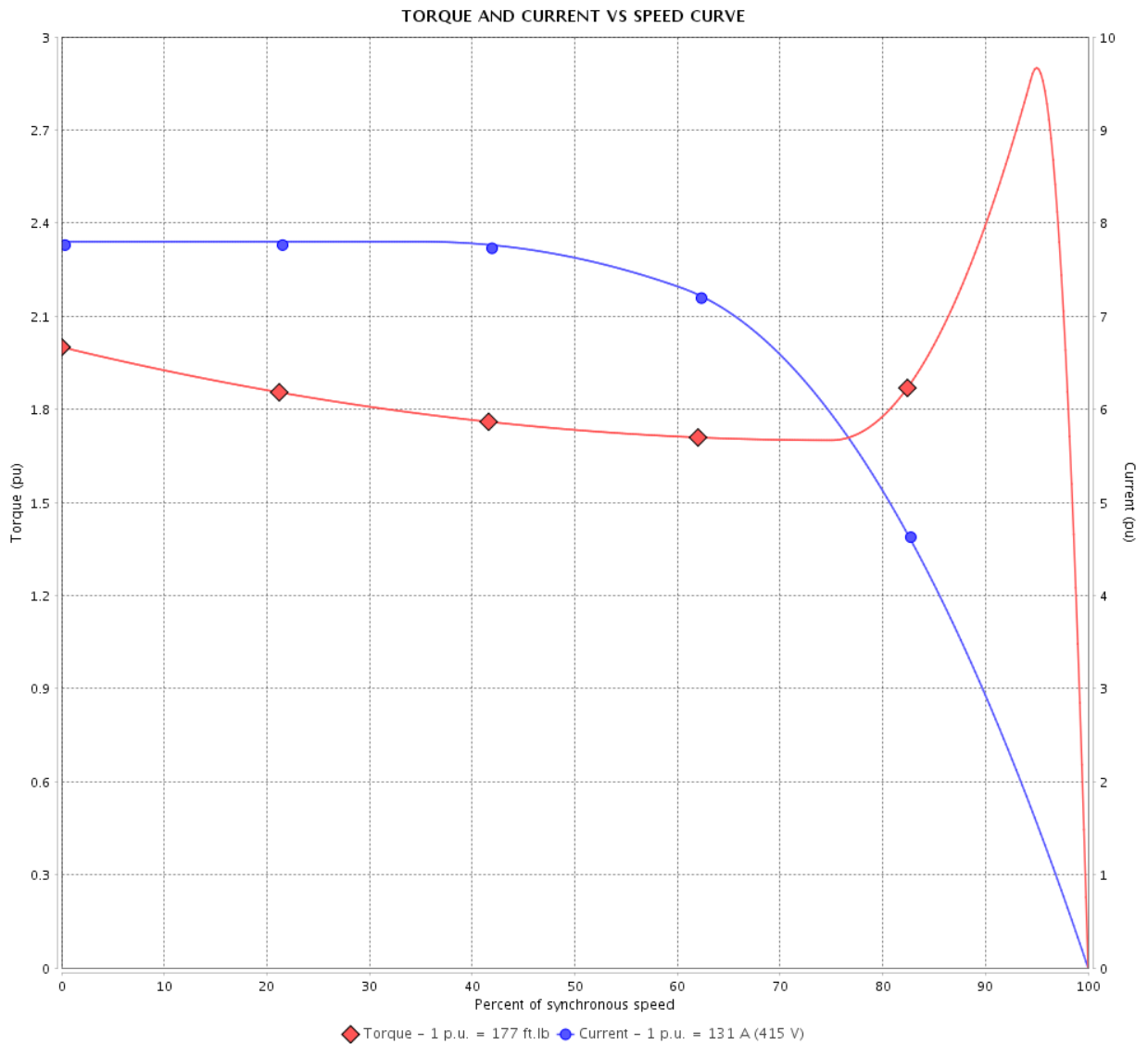

Performance : 415 V 50 Hz 2P IE3

Rated current	: 131 A	Moment of inertia (J)	: 8.23 sq.ft.lb
LRC	: 7.8	Duty cycle	: Cont.(S1)
Rated torque	: 177 ft.lb	Insulation class	: F
Locked rotor torque	: 200 %	Service factor	: 1.00
Breakdown torque	: 290 %	Temperature rise	: 80 K
Rated speed	: 2965 rpm	Design	: B

Locked rotor time : 16s (cold) 9s (hot)

Rev.	Changes Summary	Performed	Checked	Date
Performed by			Page 5 / 21	Revision
Checked by				
Date	13/04/2022			

LOAD PERFORMANCE CURVE

Three Phase Induction Motor - Squirrel Cage



Customer : _____

Product line : W40 NEMA Premium Efficiency
Three-Phase

Product code : 14272435

Catalog # : 12536OT3G404TS-W40

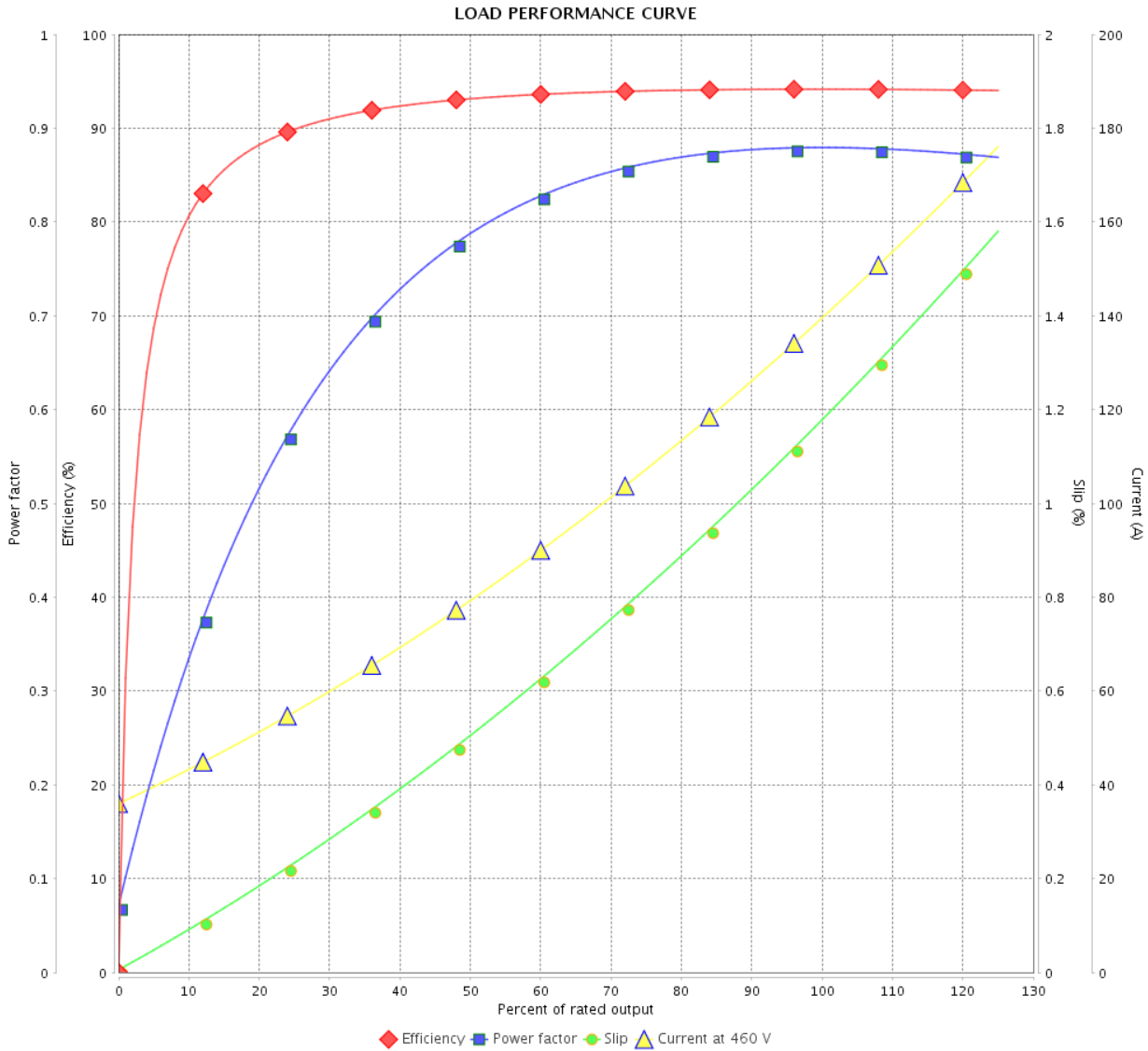

Performance : 460 V 60 Hz 2P

Rated current : 136 A
 LRC : 6.8
 Rated torque : 185 ft.lb
 Locked rotor torque : 170 %
 Breakdown torque : 260 %
 Rated speed : 3557 rpm

Moment of inertia (J) : 8.23 sq.ft.lb
 Duty cycle : Cont.(S1)
 Insulation class : F
 Service factor : 1.25
 Temperature rise : 80 K
 Design : B

Rev.	Changes Summary	Performed	Checked	Date
Performed by		Page		Revision
Checked by		6 / 21		
Date		13/04/2022		

LOAD PERFORMANCE CURVE

Three Phase Induction Motor - Squirrel Cage



Customer :

Product line : W40 NEMA Premium Efficiency Three-Phase

Product code : 14272435

Catalog # : 12536OT3G404TS-W40

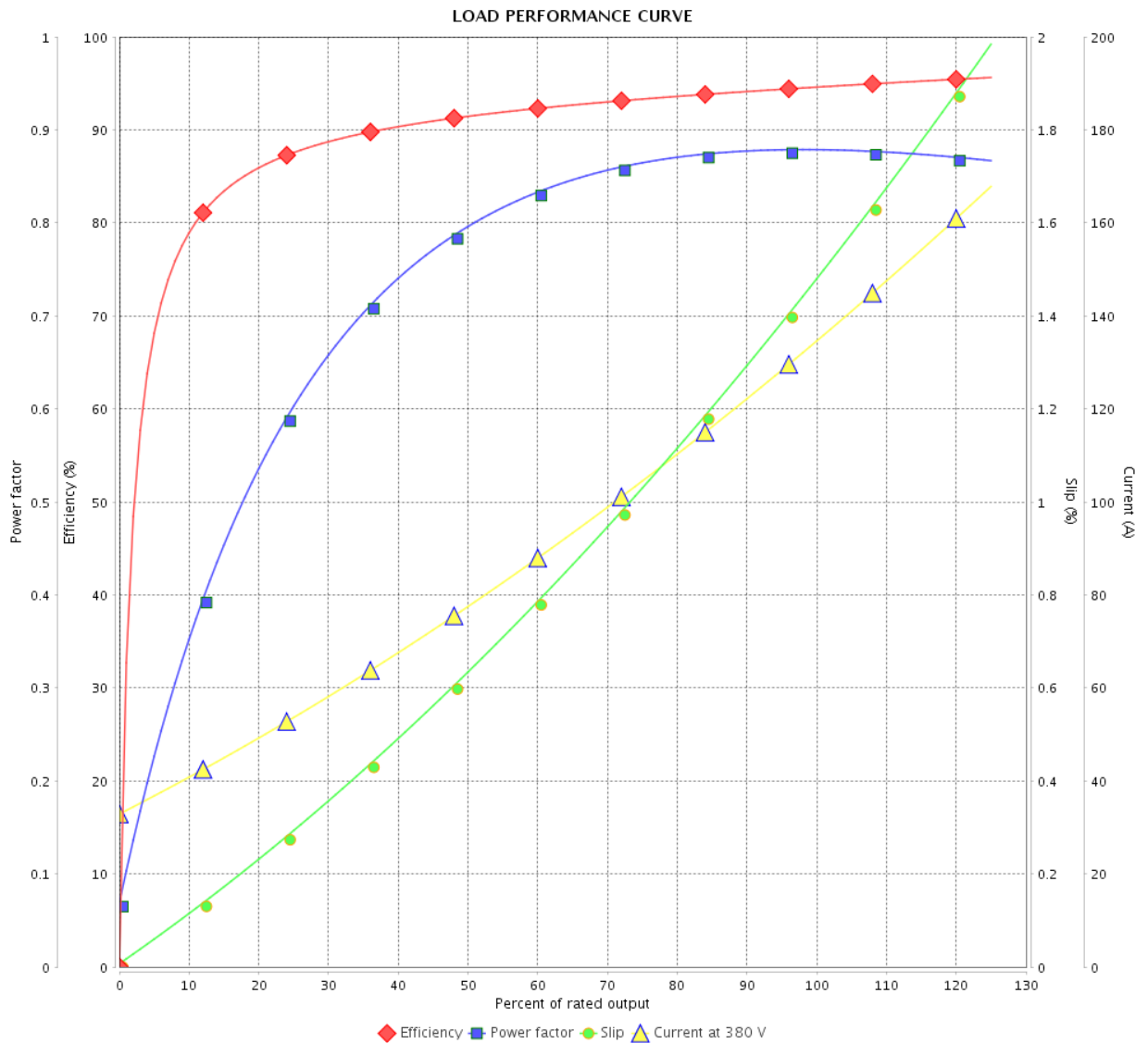

Performance : 380 V 50 Hz 2P IE3

Rated current : 137 A
 LRC : 7.2
 Rated torque : 178 ft.lb
 Locked rotor torque : 170 %
 Breakdown torque : 250 %
 Rated speed : 2955 rpm

Moment of inertia (J) : 8.23 sq.ft.lb
 Duty cycle : Cont.(S1)
 Insulation class : F
 Service factor : 1.00
 Temperature rise : 80 K
 Design : B

Rev.	Changes Summary	Performed	Checked	Date
Performed by			Page	Revision
Checked by			7 / 21	
Date	13/04/2022			

LOAD PERFORMANCE CURVE

Three Phase Induction Motor - Squirrel Cage



Customer :

Product line : W40 NEMA Premium Efficiency
Three-Phase

Product code : 14272435

Catalog # : 12536OT3G404TS-W40

LOAD PERFORMANCE CURVE

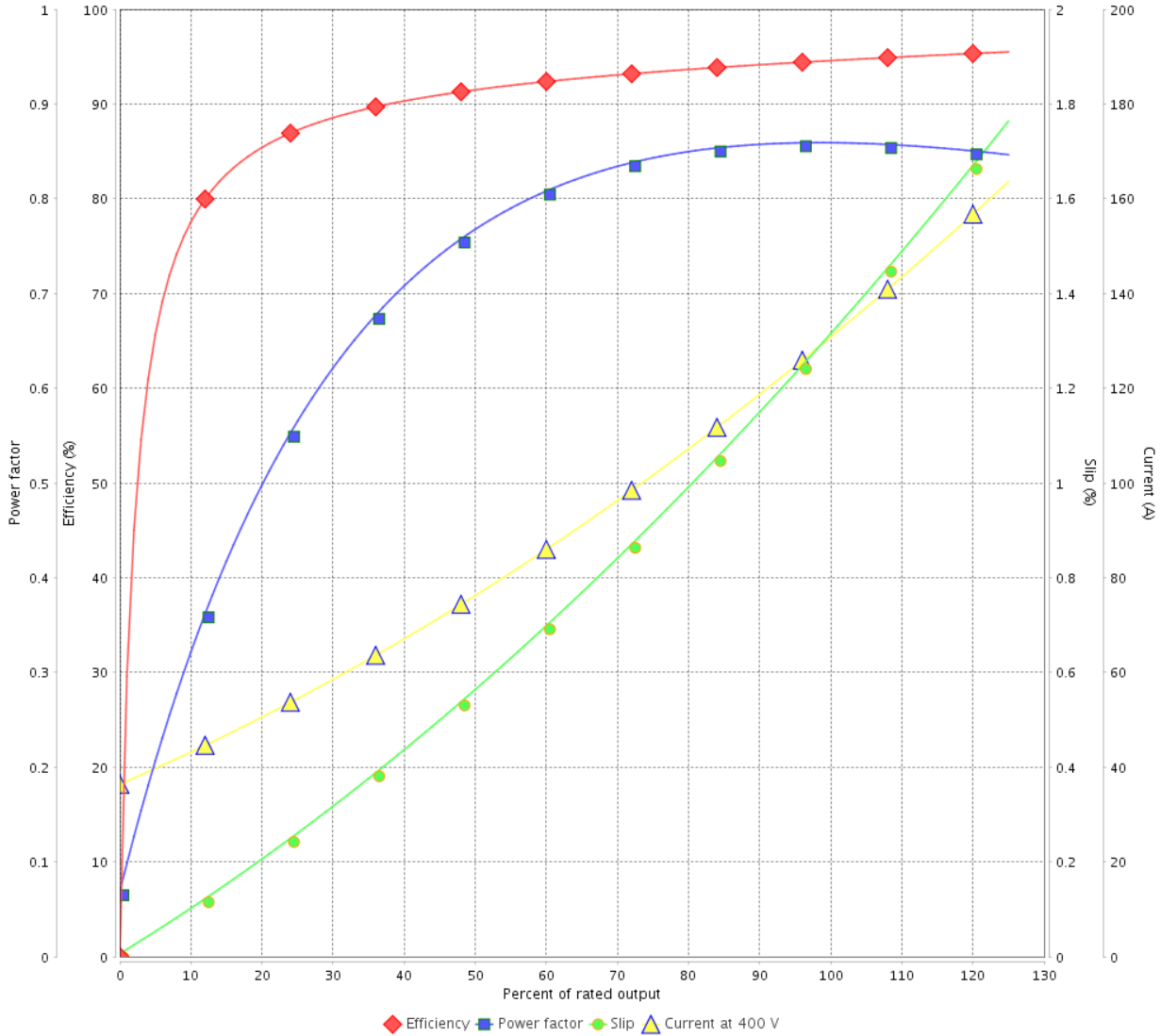

Performance : 400 V 50 Hz 2P IE3

Rated current : 133 A
LRC : 7.0
Rated torque : 177 ft.lb
Locked rotor torque : 190 %
Breakdown torque : 280 %
Rated speed : 2960 rpm

Moment of inertia (J) : 8.23 sq.ft.lb
Duty cycle : Cont.(S1)
Insulation class : F
Service factor : 1.00
Temperature rise : 80 K
Design : B

Rev.	Changes Summary	Performed	Checked	Date
Performed by		Page		Revision
Checked by		8 / 21		
Date	13/04/2022			

LOAD PERFORMANCE CURVE

Three Phase Induction Motor - Squirrel Cage



Customer :

Product line : W40 NEMA Premium Efficiency
Three-Phase

Product code : 14272435

Catalog # : 12536OT3G404TS-W40

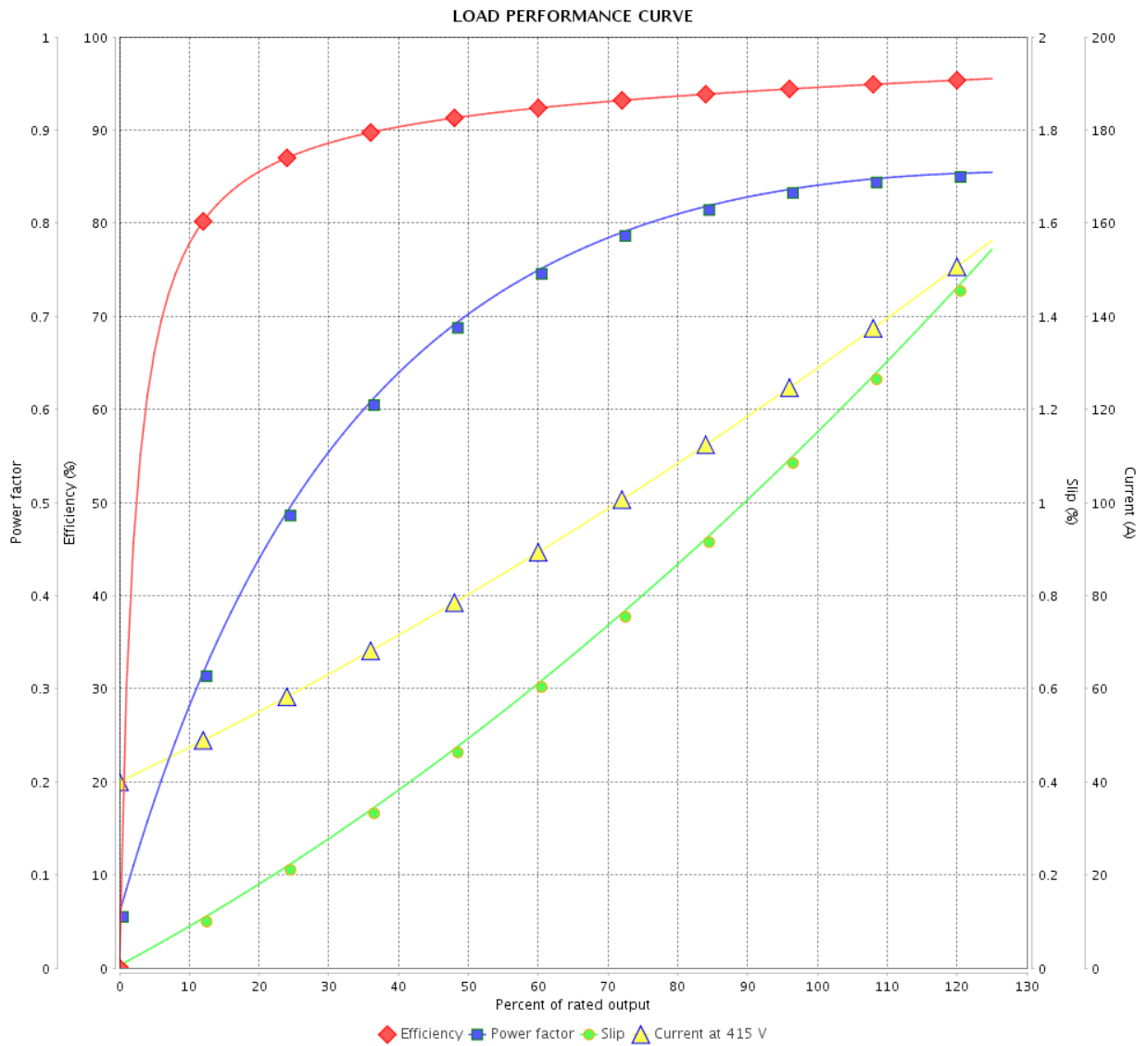

Performance : 415 V 50 Hz 2P IE3

Rated current : 131 A
 LRC : 7.8
 Rated torque : 177 ft.lb
 Locked rotor torque : 200 %
 Breakdown torque : 290 %
 Rated speed : 2965 rpm

Moment of inertia (J) : 8.23 sq.ft.lb
 Duty cycle : Cont.(S1)
 Insulation class : F
 Service factor : 1.00
 Temperature rise : 80 K
 Design : B

Rev.	Changes Summary	Performed	Checked	Date
Performed by		Page		Revision
Checked by		9 / 21		
Date		13/04/2022		

THERMAL LIMIT CURVE

Three Phase Induction Motor - Squirrel Cage



Customer :

Product line : W40 NEMA Premium Efficiency
Three-Phase

Product code : 14272435

Catalog # : 12536OT3G404TS-W40

Performance : 460 V 60 Hz 2P

Rated current	: 136 A	Moment of inertia (J)	: 8.23 sq.ft.lb
LRC	: 6.8	Duty cycle	: Cont.(S1)
Rated torque	: 185 ft.lb	Insulation class	: F
Locked rotor torque	: 170 %	Service factor	: 1.25
Breakdown torque	: 260 %	Temperature rise	: 80 K
Rated speed	: 3557 rpm	Design	: B

Heating constant

Cooling constant

Rev.	Changes Summary	Performed	Checked	Date
Performed by				
Checked by			Page	Revision
Date	13/04/2022		10 / 21	

THERMAL LIMIT CURVE

Three Phase Induction Motor - Squirrel Cage



Customer : _____

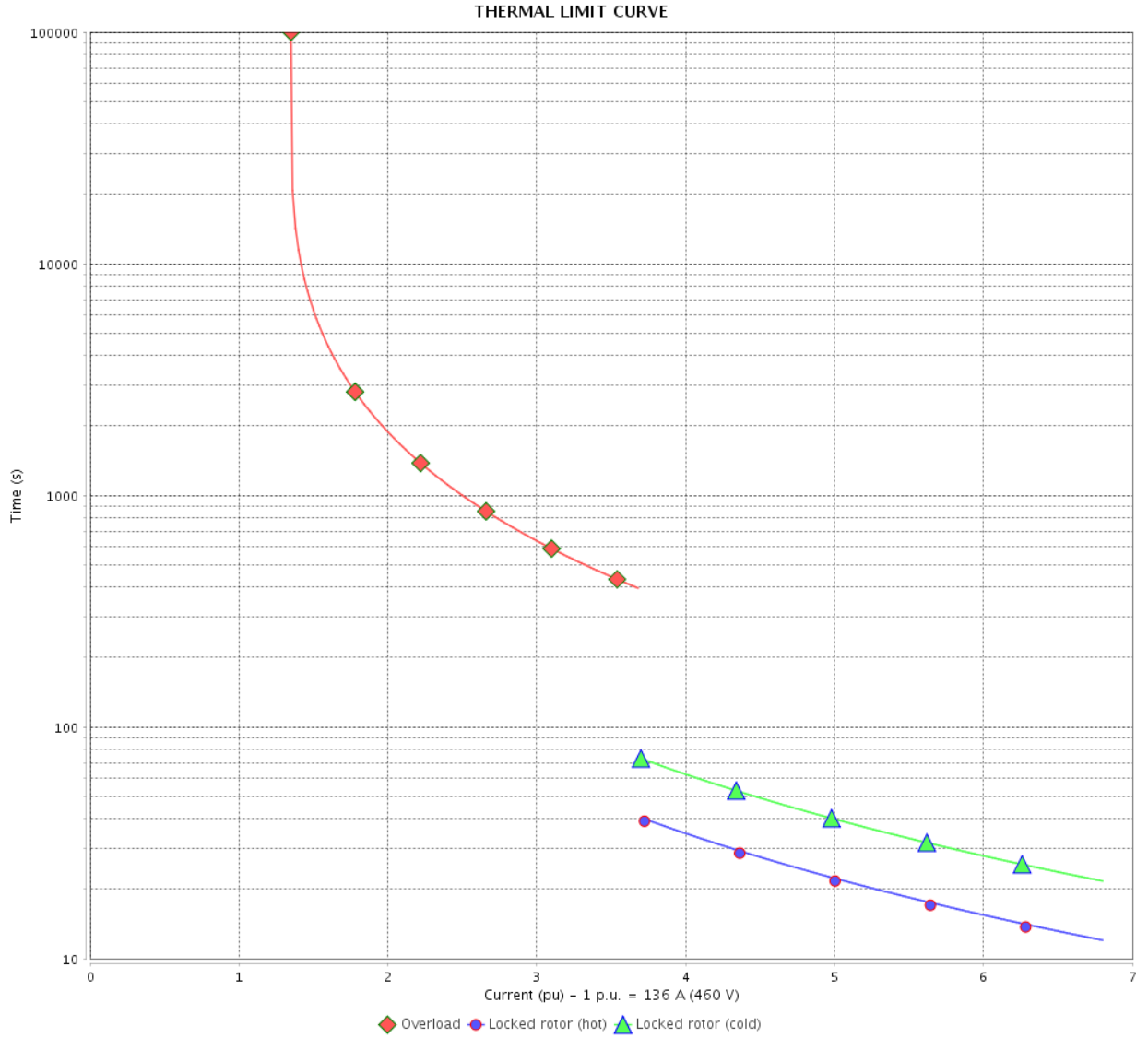

Rev.	Changes Summary	Performed	Checked	Date
Performed by		Page		Revision
Checked by		11 / 21		
Date		13/04/2022		

THERMAL LIMIT CURVE



Three Phase Induction Motor - Squirrel Cage

Customer :

Product line : W40 NEMA Premium Efficiency
Three-Phase

Product code : 14272435

Catalog # : 12536OT3G404TS-W40

Performance : 380 V 50 Hz 2P IE3

Rated current	: 137 A	Moment of inertia (J)	: 8.23 sq.ft.lb
LRC	: 7.2	Duty cycle	: Cont.(S1)
Rated torque	: 178 ft.lb	Insulation class	: F
Locked rotor torque	: 170 %	Service factor	: 1.00
Breakdown torque	: 250 %	Temperature rise	: 80 K
Rated speed	: 2955 rpm	Design	: B

Heating constant

Cooling constant

Rev.	Changes Summary	Performed	Checked	Date
Performed by		Page		Revision
Checked by		12 / 21		
Date	13/04/2022			

THERMAL LIMIT CURVE

Three Phase Induction Motor - Squirrel Cage



Customer : _____

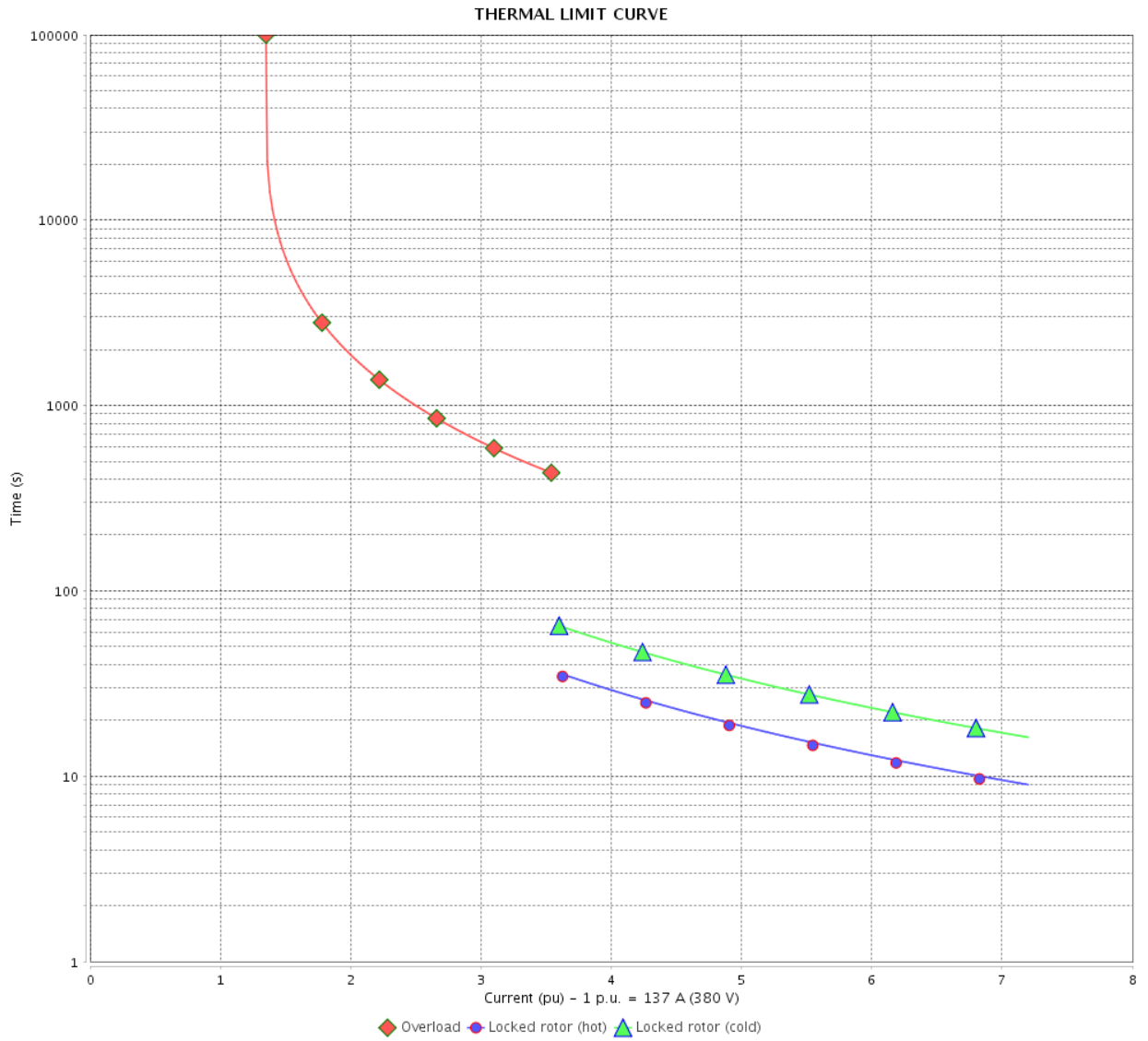

Rev.	Changes Summary	Performed	Checked	Date
Performed by		Page 13 / 21		Revision
Checked by				
Date				

THERMAL LIMIT CURVE

Three Phase Induction Motor - Squirrel Cage



Customer :

Product line : W40 NEMA Premium Efficiency
Three-Phase

Product code : 14272435

Catalog # : 12536OT3G404TS-W40

Performance : 400 V 50 Hz 2P IE3

Rated current	: 133 A	Moment of inertia (J)	: 8.23 sq.ft.lb
LRC	: 7.0	Duty cycle	: Cont.(S1)
Rated torque	: 177 ft.lb	Insulation class	: F
Locked rotor torque	: 190 %	Service factor	: 1.00
Breakdown torque	: 280 %	Temperature rise	: 80 K
Rated speed	: 2960 rpm	Design	: B

Heating constant

Cooling constant

Rev.	Changes Summary	Performed	Checked	Date
Performed by				
Checked by			Page	Revision
Date	13/04/2022		14 / 21	

THERMAL LIMIT CURVE

Three Phase Induction Motor - Squirrel Cage



Customer : _____

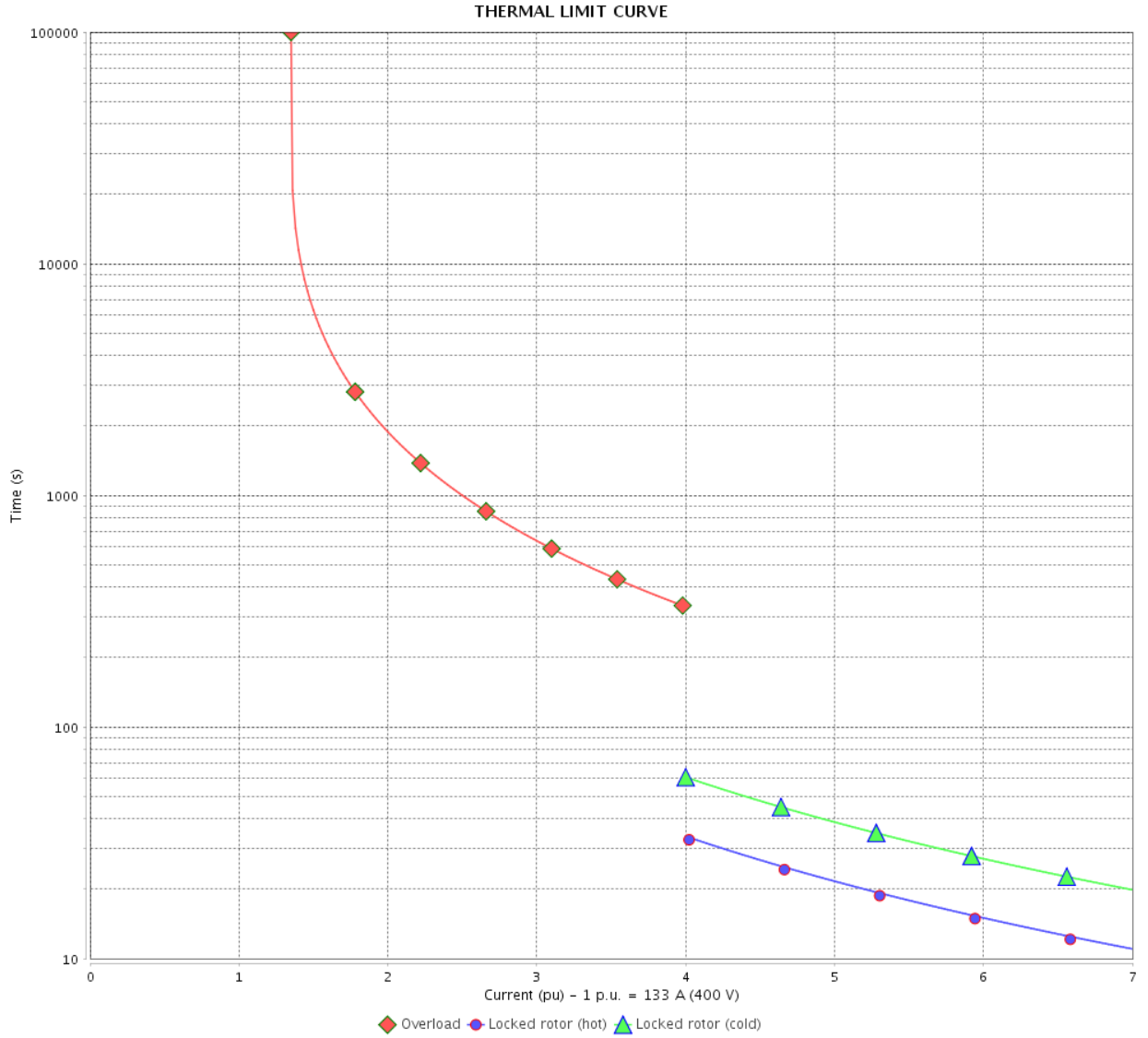

Rev.	Changes Summary	Performed	Checked	Date
Performed by		Page		Revision
Checked by		15 / 21		
Date		13/04/2022		

THERMAL LIMIT CURVE



Three Phase Induction Motor - Squirrel Cage

Customer :

Product line : W40 NEMA Premium Efficiency
Three-Phase

Product code : 14272435

Catalog # : 12536OT3G404TS-W40

Performance : 415 V 50 Hz 2P IE3

Rated current	: 131 A	Moment of inertia (J)	: 8.23 sq.ft.lb
LRC	: 7.8	Duty cycle	: Cont.(S1)
Rated torque	: 177 ft.lb	Insulation class	: F
Locked rotor torque	: 200 %	Service factor	: 1.00
Breakdown torque	: 290 %	Temperature rise	: 80 K
Rated speed	: 2965 rpm	Design	: B

Heating constant

Cooling constant

Rev.	Changes Summary	Performed	Checked	Date
Performed by				
Checked by			Page	Revision
Date	13/04/2022		16 / 21	

THERMAL LIMIT CURVE

Three Phase Induction Motor - Squirrel Cage



Customer : _____

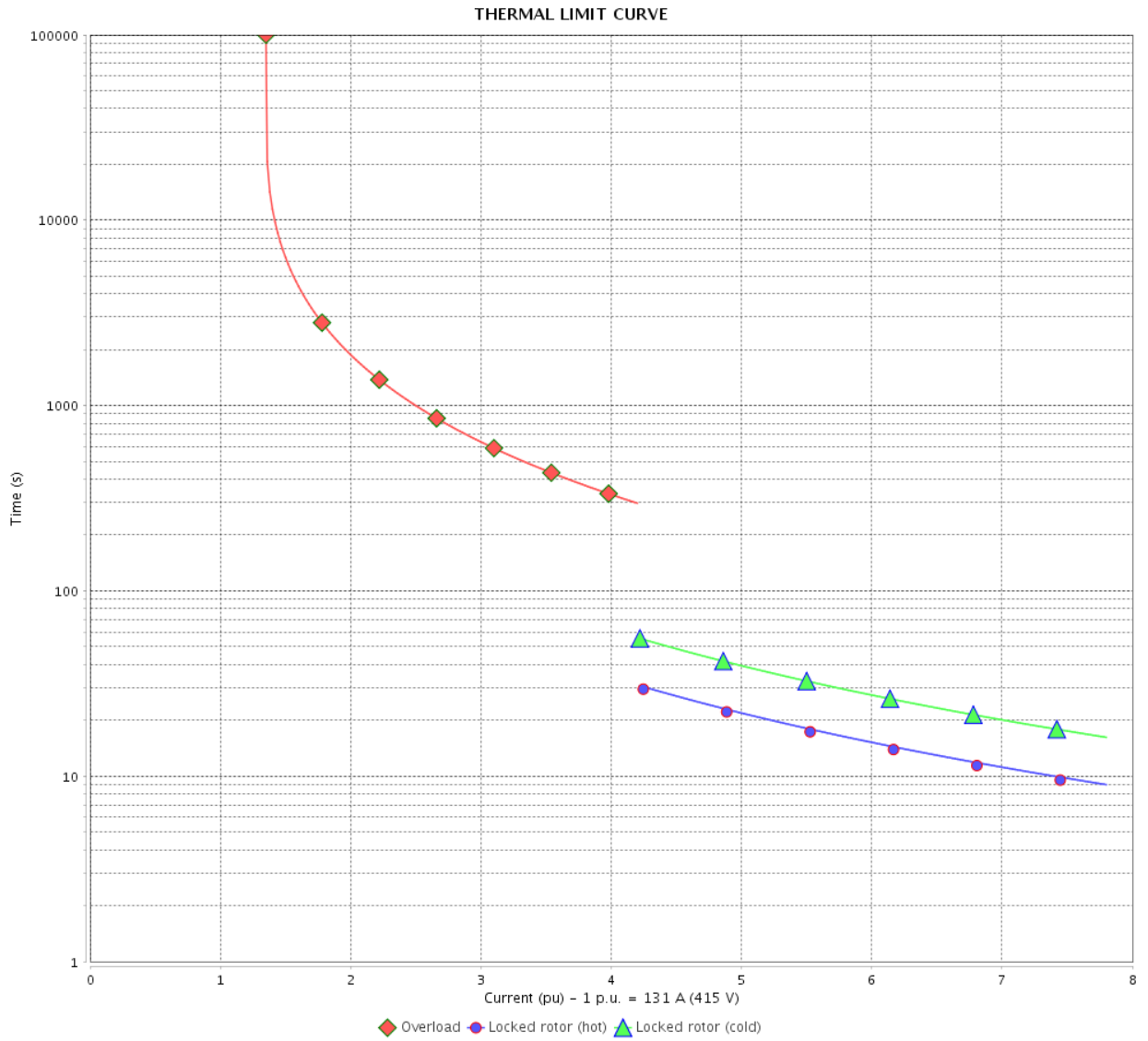

Rev.	Changes Summary	Performed	Checked	Date
Performed by		Page		Revision
Checked by				
Date				

VFD OPERATION CURVE

Three Phase Induction Motor - Squirrel Cage



Customer :

Product line : W40 NEMA Premium Efficiency
Three-Phase

Product code : 14272435

Catalog # : 12536OT3G404TS-W40

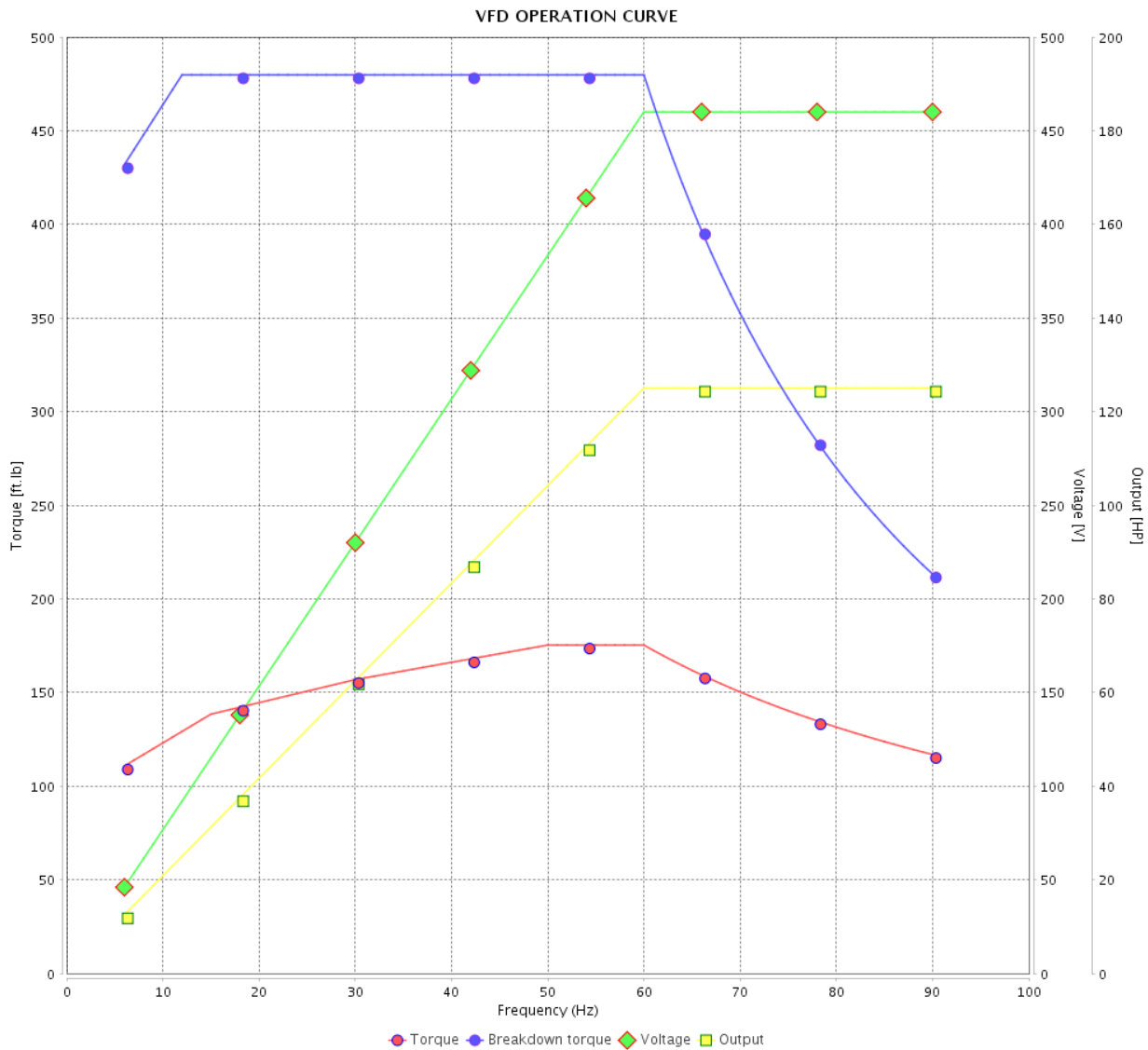

Performance : 460 V 60 Hz 2P

Rated current : 136 A
LRC : 6.8
Rated torque : 185 ft.lb
Locked rotor torque : 170 %
Breakdown torque : 260 %
Rated speed : 3557 rpm

Moment of inertia (J) : 8.23 sq.ft.lb
Duty cycle : Cont.(S1)
Insulation class : F
Service factor : 1.25
Temperature rise : 80 K
Design : B

Rev.	Changes Summary	Performed	Checked	Date
Performed by			Page 18 / 21	Revision
Checked by				
Date	13/04/2022			

VFD OPERATION CURVE

Three Phase Induction Motor - Squirrel Cage



Customer :

Product line : W40 NEMA Premium Efficiency
Three-Phase

Product code : 14272435

Catalog # : 12536OT3G404TS-W40

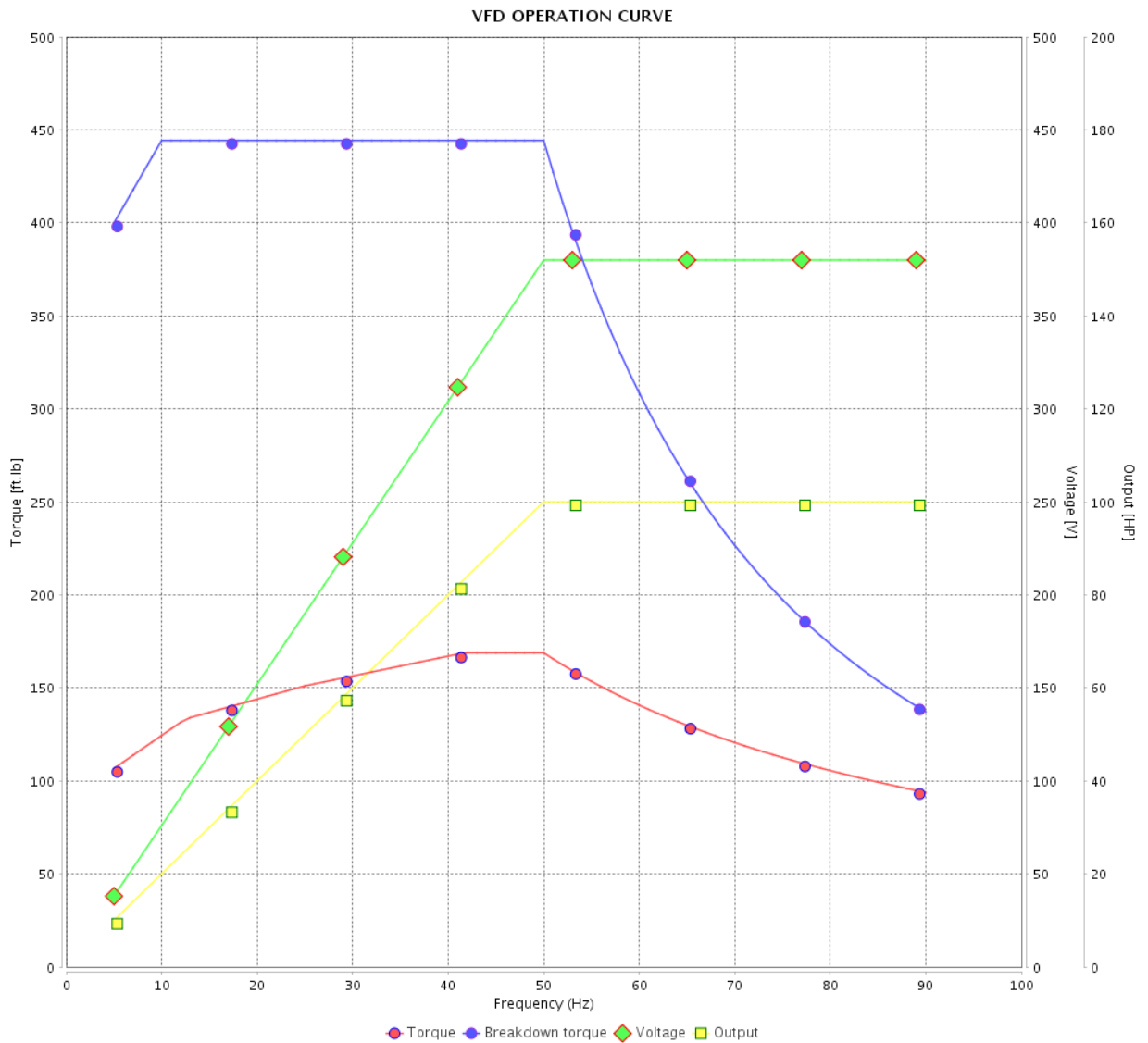

Performance : 380 V 50 Hz 2P IE3

Rated current : 137 A
LRC : 7.2
Rated torque : 178 ft.lb
Locked rotor torque : 170 %
Breakdown torque : 250 %
Rated speed : 2955 rpm

Moment of inertia (J) : 8.23 sq.ft.lb
Duty cycle : Cont.(S1)
Insulation class : F
Service factor : 1.00
Temperature rise : 80 K
Design : B

Rev.	Changes Summary	Performed	Checked	Date
Performed by				Page 19 / 21
Checked by				
Date	13/04/2022			

VFD OPERATION CURVE

Three Phase Induction Motor - Squirrel Cage



Customer :

Product line : W40 NEMA Premium Efficiency Three-Phase

Product code : 14272435

Catalog # : 12536OT3G404TS-W40

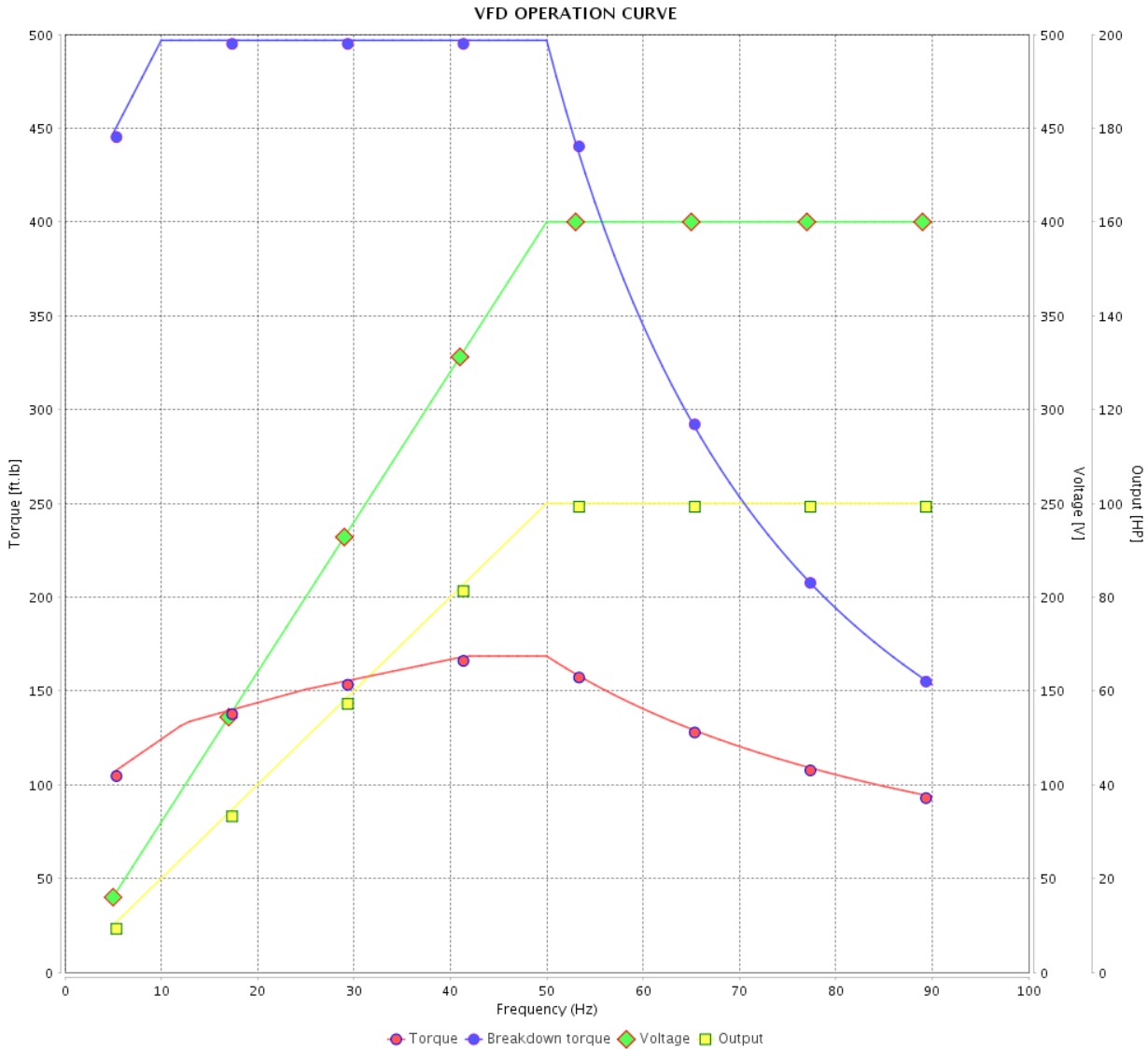

Performance : 400 V 50 Hz 2P IE3

Rated current : 133 A
 LRC : 7.0
 Rated torque : 177 ft.lb
 Locked rotor torque : 190 %
 Breakdown torque : 280 %
 Rated speed : 2960 rpm

Moment of inertia (J) : 8.23 sq.ft.lb
 Duty cycle : Cont.(S1)
 Insulation class : F
 Service factor : 1.00
 Temperature rise : 80 K
 Design : B

Rev.	Changes Summary	Performed	Checked	Date
Performed by			Page 20 / 21	Revision
Checked by				
Date	13/04/2022			

VFD OPERATION CURVE

Three Phase Induction Motor - Squirrel Cage



Customer :

Product line : W40 NEMA Premium Efficiency
Three-Phase

Product code : 14272435

Catalog # : 12536OT3G404TS-W40

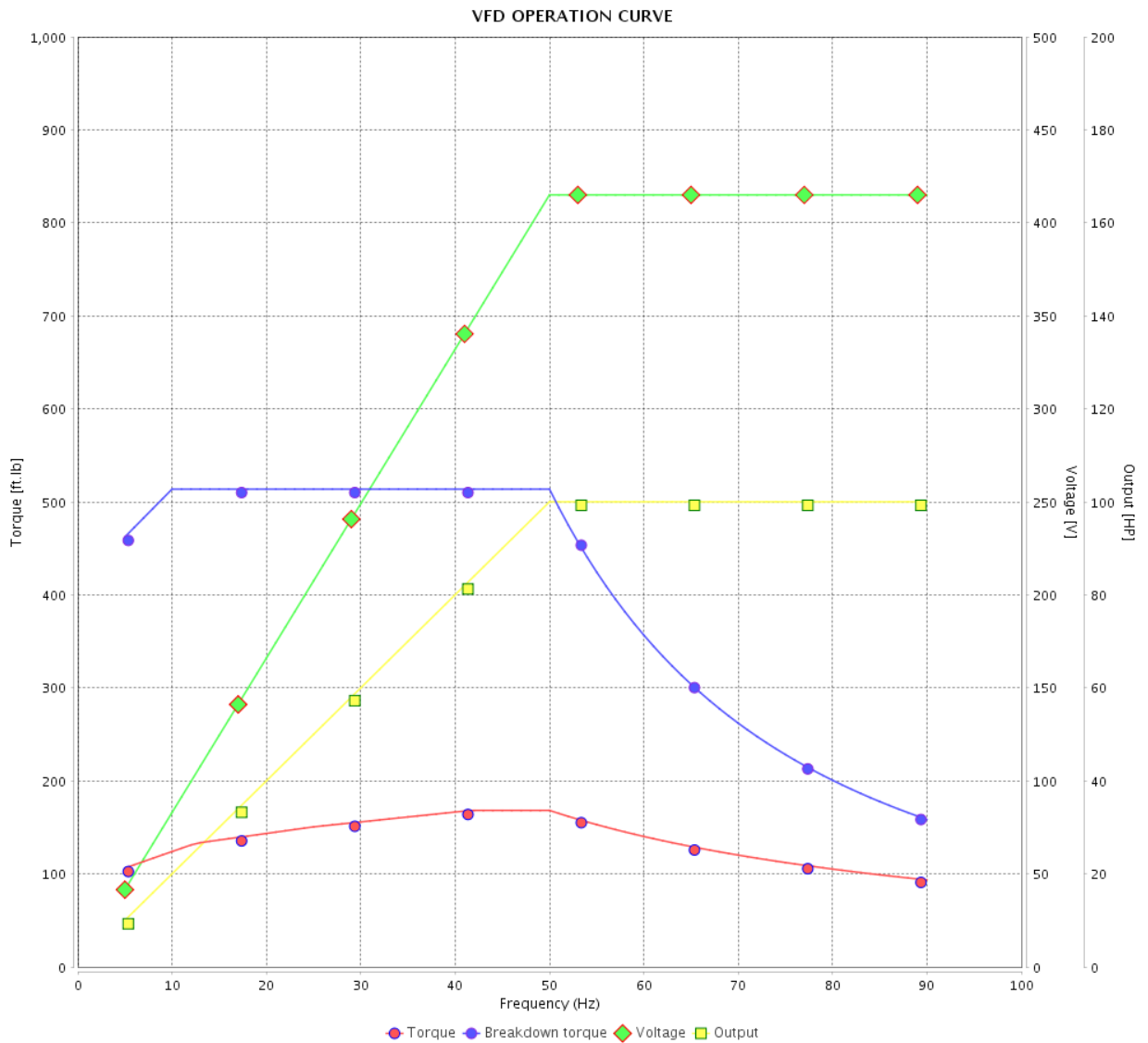

Performance : 415 V 50 Hz 2P IE3

Rated current : 131 A
 LRC : 7.8
 Rated torque : 177 ft.lb
 Locked rotor torque : 200 %
 Breakdown torque : 290 %
 Rated speed : 2965 rpm

Moment of inertia (J) : 8.23 sq.ft.lb
 Duty cycle : Cont.(S1)
 Insulation class : F
 Service factor : 1.00
 Temperature rise : 80 K
 Design : B

Rev.	Changes Summary	Performed	Checked	Date
Performed by			Page 21 / 21	Revision
Checked by				
Date	13/04/2022			

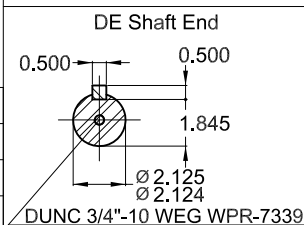
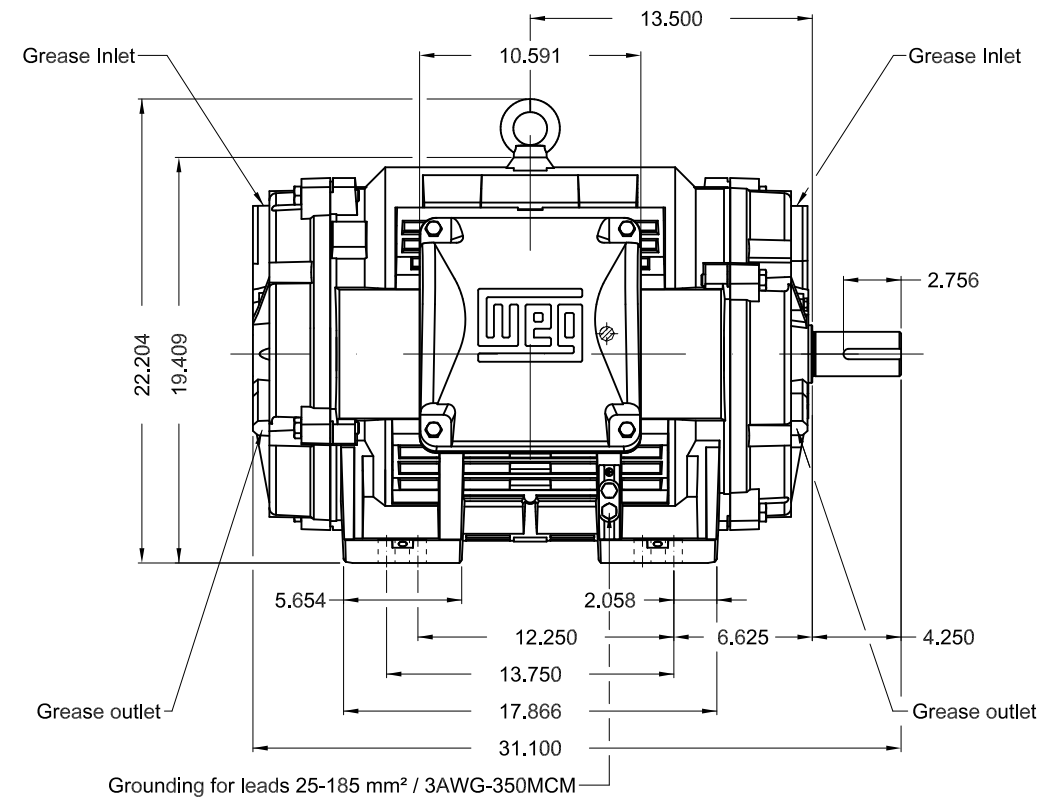
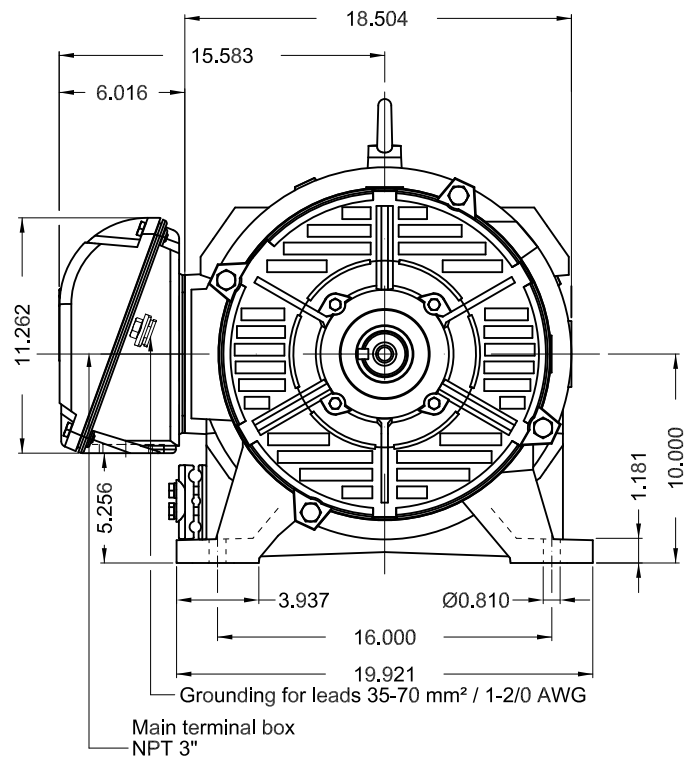

Color RAL 5009
Painting plan 203A
Mounting NEMA F-1
Mounting B3R(D)

125 HP 02 Poles 60 Hz

A

1:9

ECM	LOC	SUMMARY OF MODIFICATIONS	EXECUTED	CHECKED	RELEASED	DATE	VER
EXECUTED	PIRWBUSER	THREE PH. MOTOR W40 PREM. EFF.					
CHECKED		FRAME 404/5TS IP23 ODP					
RELEASED							
REL DT.	WMO	Jaragua do Sul	Product Engineering	SHEET	1 / 1		

PREVIEW
WDD

