

DATA SHEET

Three Phase Induction Motor - Squirrel Cage



Customer :					
Product line		: NEMA Premium Efficiency Three-Phase	Product code :	12176656	
			Catalog # :	15009ST3QIE447T-W22	
Frame		: 445/7T	Cooling method : IC411 - TEFC		
Insulation class		: F	Mounting : F-1		
Duty cycle		: Cont.(S1)	Rotation ¹ : Both (CW and CCW)		
Ambient temperature		: -20°C to +40°C	Starting method : Direct On Line		
Altitude		: 1000 m.a.s.l.	Approx. weight ² : 2214 lb		
Protection degree		: IP55	Moment of inertia (J) : 125 sq.ft.lb		
Design		: B			
Output [HP]	150	125	125	125	
Poles	8	8	8	8	
Frequency [Hz]	60	50	50	50	
Rated voltage [V]	460	380	400	415	
Rated current [A]	185	183	177	175	
L. R. Amperes [A]	1110	1025	1097	1138	
LRC [A]	6.0x(Code G)	5.6x(Code F)	6.2x(Code G)	6.5x(Code H)	
No load current [A]	75.0	78.9	83.3	86.8	
Rated speed [RPM]	890	740	740	740	
Slip [%]	1.11	1.33	1.33	1.33	
Rated torque [ft.lb]	885	887	887	887	
Locked rotor torque [%]	190	170	200	220	
Breakdown torque [%]	210	200	229	250	
Service factor	1.15	1.15	1.15	1.15	
Temperature rise	80 K	105 K	80 K	80 K	
Locked rotor time	27s (cold) 15s (hot)	27s (cold) 15s (hot)	27s (cold) 15s (hot)	27s (cold) 15s (hot)	
Noise level ²	63.0 dB(A)				
Efficiency (%)	25%				
	50%	94.5	94.5	94.1	
	75%	94.5	94.1	94.1	
	100%	94.5	93.6	94.1	
Power Factor	25%				
	50%	0.64	0.65	0.61	
	75%	0.74	0.75	0.72	
	100%	0.79	0.80	0.78	
Bearing type		Drive end : 6319 C3	Non drive end : 6316 C3	Foundation loads	
Sealing		: Inpro/Seal	: Inpro/Seal	Max. traction : 4805 lb	
Lubrication interval		: 17000 h	: 20000 h	Max. compression : 7019 lb	
Lubricant amount		: 45 g	: 34 g		
Lubricant type		: Mobil Polyrex EM			
Notes					
This revision replaces and cancel the previous one, which must be eliminated. (1) Looking the motor from the shaft end. (2) Measured at 1m and with tolerance of +3dB(A). (3) Approximate weight subject to changes after manufacturing process. (4) At 100% of full load.			These are average values based on tests with sinusoidal power supply, subject to the tolerances stipulated in NEMA MG-1.		
Rev.	Changes Summary		Performed	Checked	Date
Performed by					
Checked by				Page	Revision
Date	13/04/2022			1 / 21	

TORQUE AND CURRENT VS SPEED CURVE

Three Phase Induction Motor - Squirrel Cage



Customer :

Product line : NEMA Premium Efficiency Three-Phase

Product code : 12176656

Catalog # : 15009ST3QIE447T-W22

TORQUE AND CURRENT VS SPEED CURVE

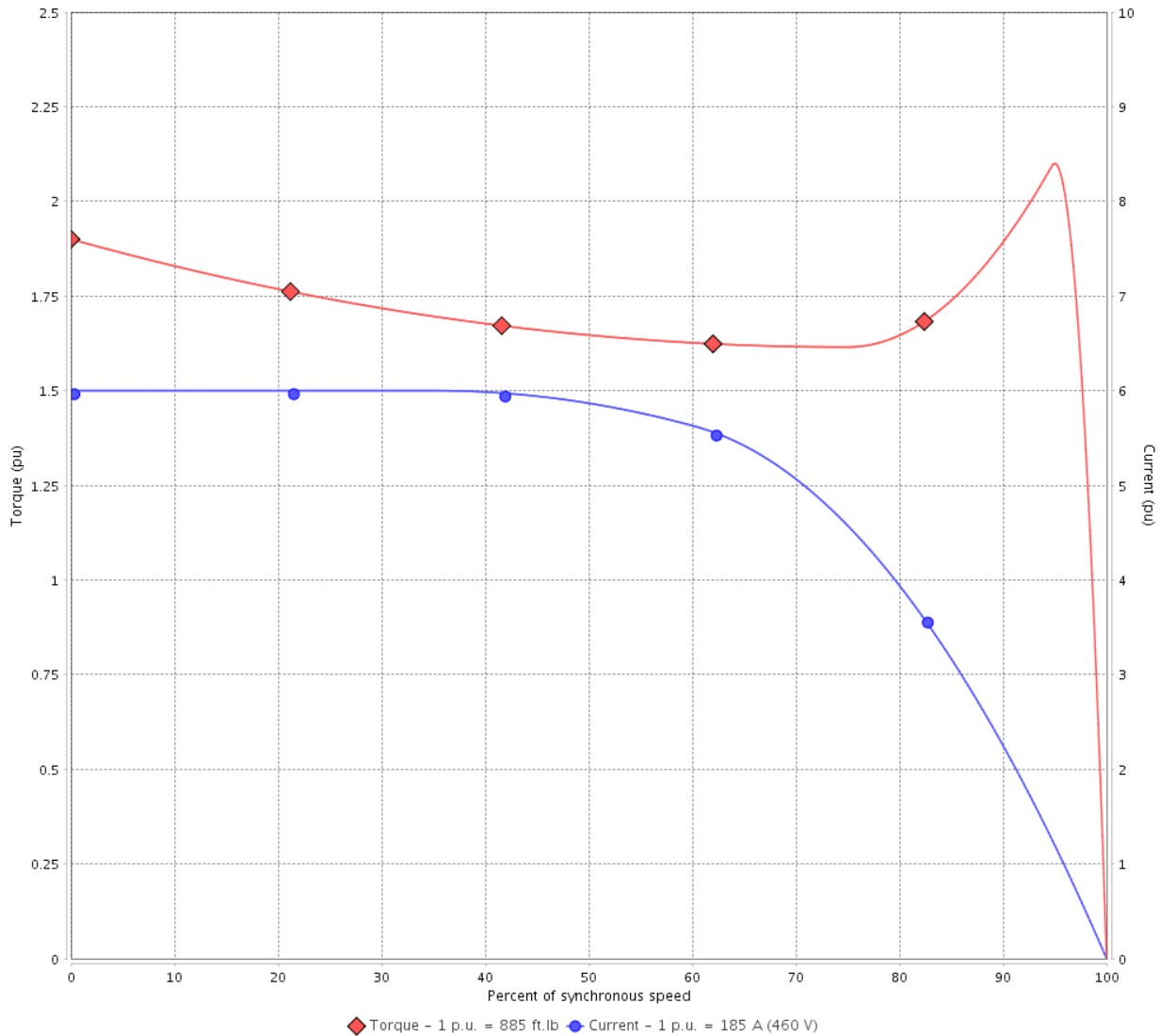

Performance : 460 V 60 Hz 8P

Rated current	: 185 A	Moment of inertia (J)	: 125 sq.ft.lb
LRC	: 6.0	Duty cycle	: Cont.(S1)
Rated torque	: 885 ft.lb	Insulation class	: F
Locked rotor torque	: 190 %	Service factor	: 1.15
Breakdown torque	: 210 %	Temperature rise	: 80 K
Rated speed	: 890 rpm	Design	: B

Locked rotor time : 27s (cold) 15s (hot)

Rev.	Changes Summary	Performed	Checked	Date
Performed by			Page 2 / 21	Revision
Checked by				
Date	13/04/2022			

TORQUE AND CURRENT VS SPEED CURVE



Three Phase Induction Motor - Squirrel Cage

Customer :

Product line : NEMA Premium Efficiency Three-Phase

Product code : 12176656

Catalog # : 15009ST3QIE447T-W22

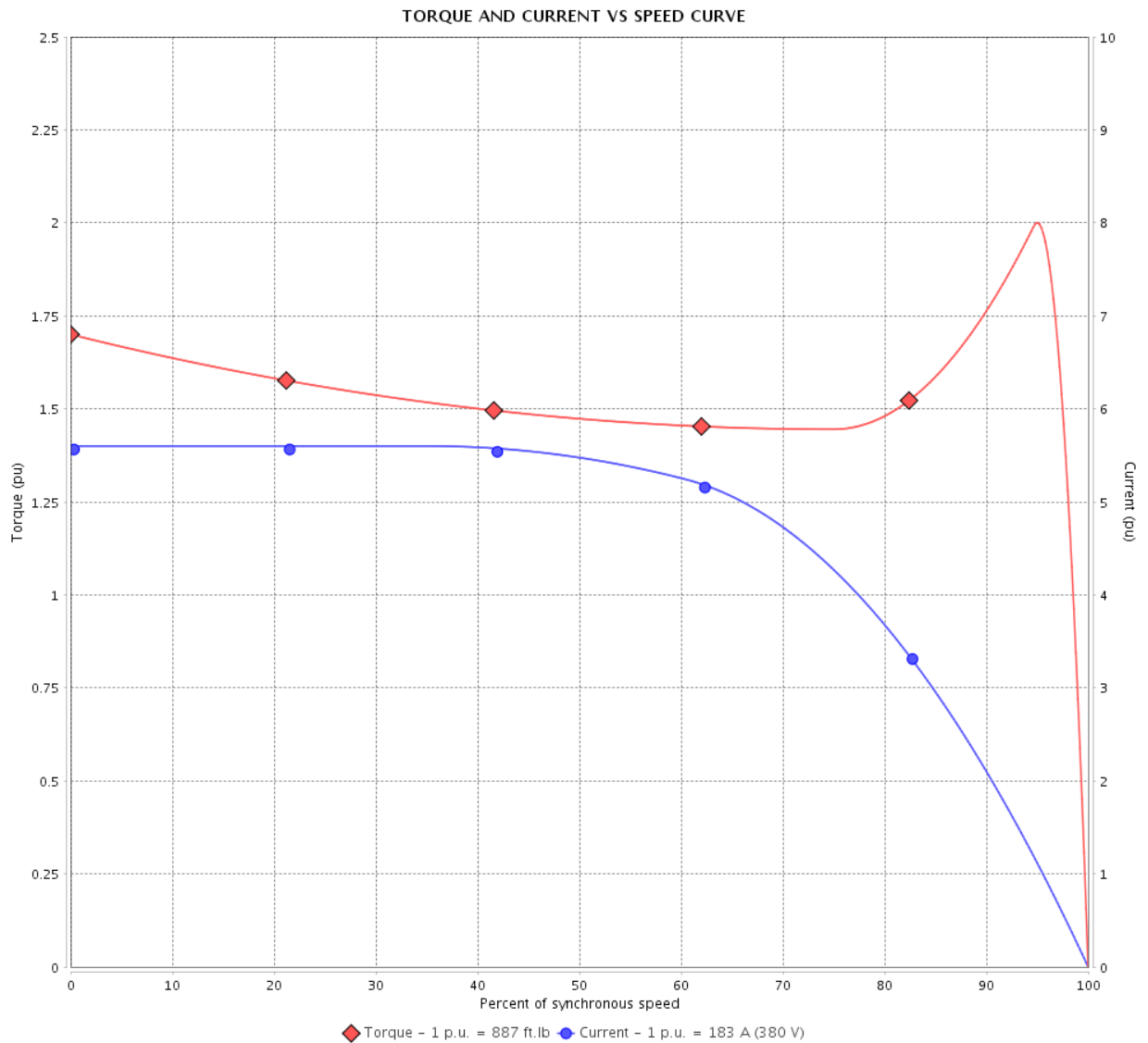

Performance : 380 V 50 Hz 8P IE3

Rated current	: 183 A	Moment of inertia (J)	: 125 sq.ft.lb
LRC	: 5.6	Duty cycle	: Cont.(S1)
Rated torque	: 887 ft.lb	Insulation class	: F
Locked rotor torque	: 170 %	Service factor	: 1.15
Breakdown torque	: 200 %	Temperature rise	: 105 K
Rated speed	: 740 rpm	Design	: B

Locked rotor time : 27s (cold) 15s (hot)

Rev.	Changes Summary	Performed	Checked	Date
Performed by			Page 3 / 21	Revision
Checked by				
Date	13/04/2022			

TORQUE AND CURRENT VS SPEED CURVE

Three Phase Induction Motor - Squirrel Cage



Customer :

Product line : NEMA Premium Efficiency Three-Phase

Product code : 12176656

Catalog # : 15009ST3QIE447T-W22

TORQUE AND CURRENT VS SPEED CURVE

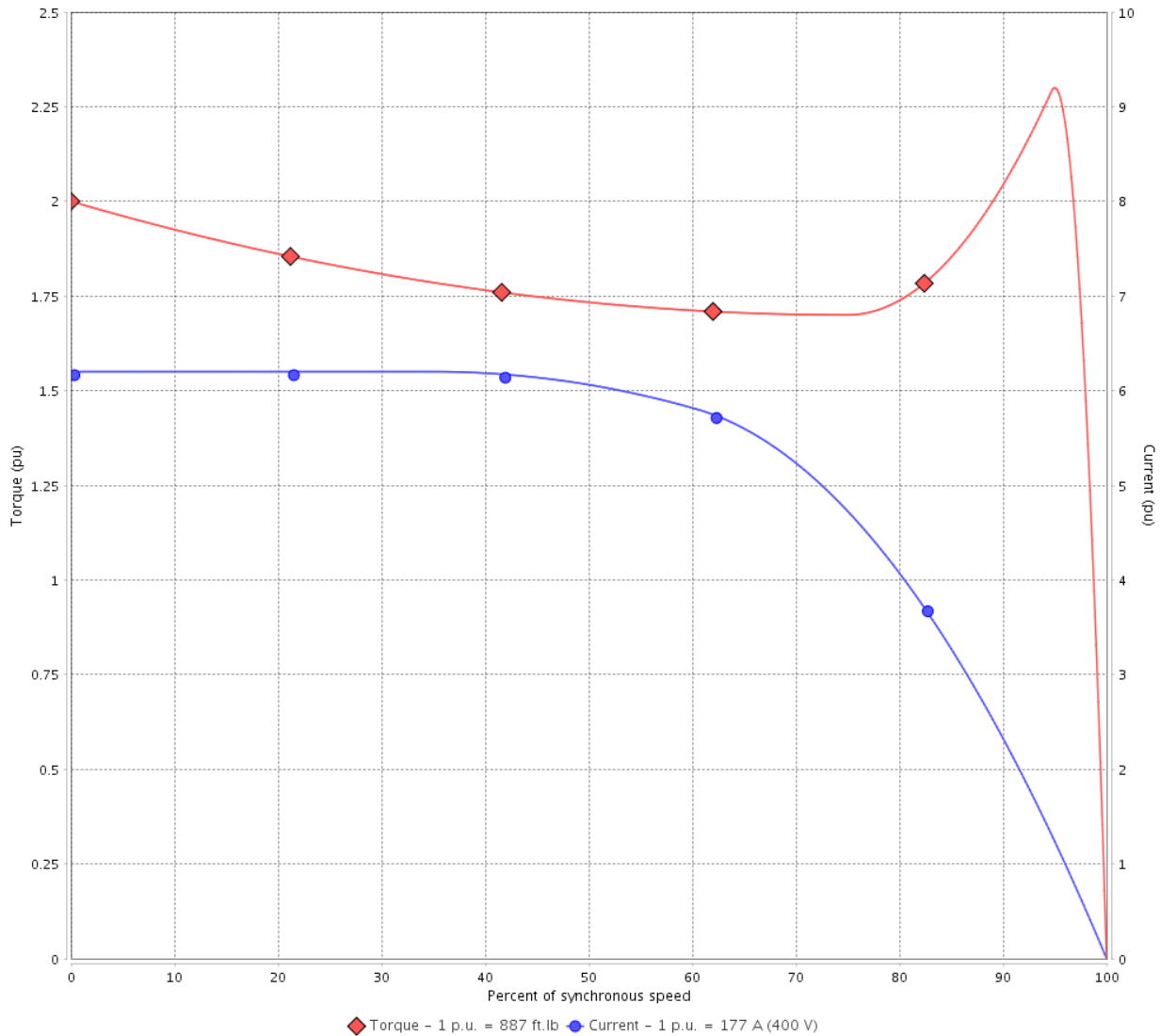

Performance : 400 V 50 Hz 8P IE3

Rated current	: 177 A	Moment of inertia (J)	: 125 sq.ft.lb
LRC	: 6.2	Duty cycle	: Cont.(S1)
Rated torque	: 887 ft.lb	Insulation class	: F
Locked rotor torque	: 200 %	Service factor	: 1.15
Breakdown torque	: 229 %	Temperature rise	: 80 K
Rated speed	: 740 rpm	Design	: B

Locked rotor time : 27s (cold) 15s (hot)

Rev.	Changes Summary	Performed	Checked	Date
Performed by			Page 4 / 21	Revision
Checked by				
Date	13/04/2022			

TORQUE AND CURRENT VS SPEED CURVE

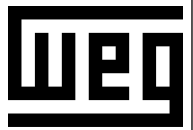

Three Phase Induction Motor - Squirrel Cage

Customer :

Product line : NEMA Premium Efficiency Three-Phase

Product code : 12176656

Catalog # : 15009ST3QIE447T-W22

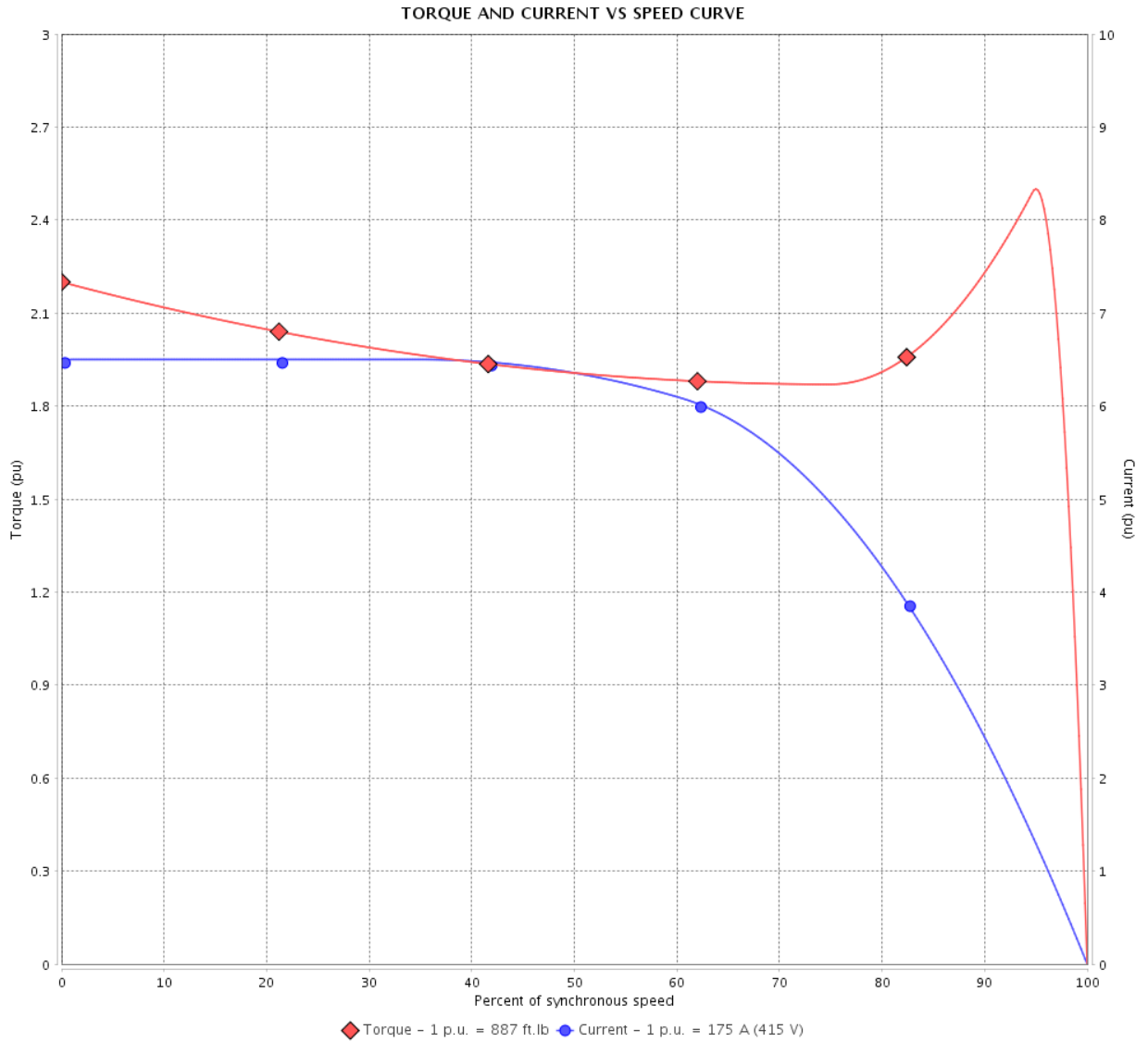

Performance : 415 V 50 Hz 8P IE3

Rated current	: 175 A	Moment of inertia (J)	: 125 sq.ft.lb
LRC	: 6.5	Duty cycle	: Cont.(S1)
Rated torque	: 887 ft.lb	Insulation class	: F
Locked rotor torque	: 220 %	Service factor	: 1.15
Breakdown torque	: 250 %	Temperature rise	: 80 K
Rated speed	: 740 rpm	Design	: B

Locked rotor time : 27s (cold) 15s (hot)

Rev.	Changes Summary	Performed	Checked	Date
Performed by			Page 5 / 21	Revision
Checked by				
Date	13/04/2022			

LOAD PERFORMANCE CURVE

Three Phase Induction Motor - Squirrel Cage



Customer :

Product line : NEMA Premium Efficiency Three-Phase

Product code : 12176656

Catalog # : 15009ST3QIE447T-W22

LOAD PERFORMANCE CURVE

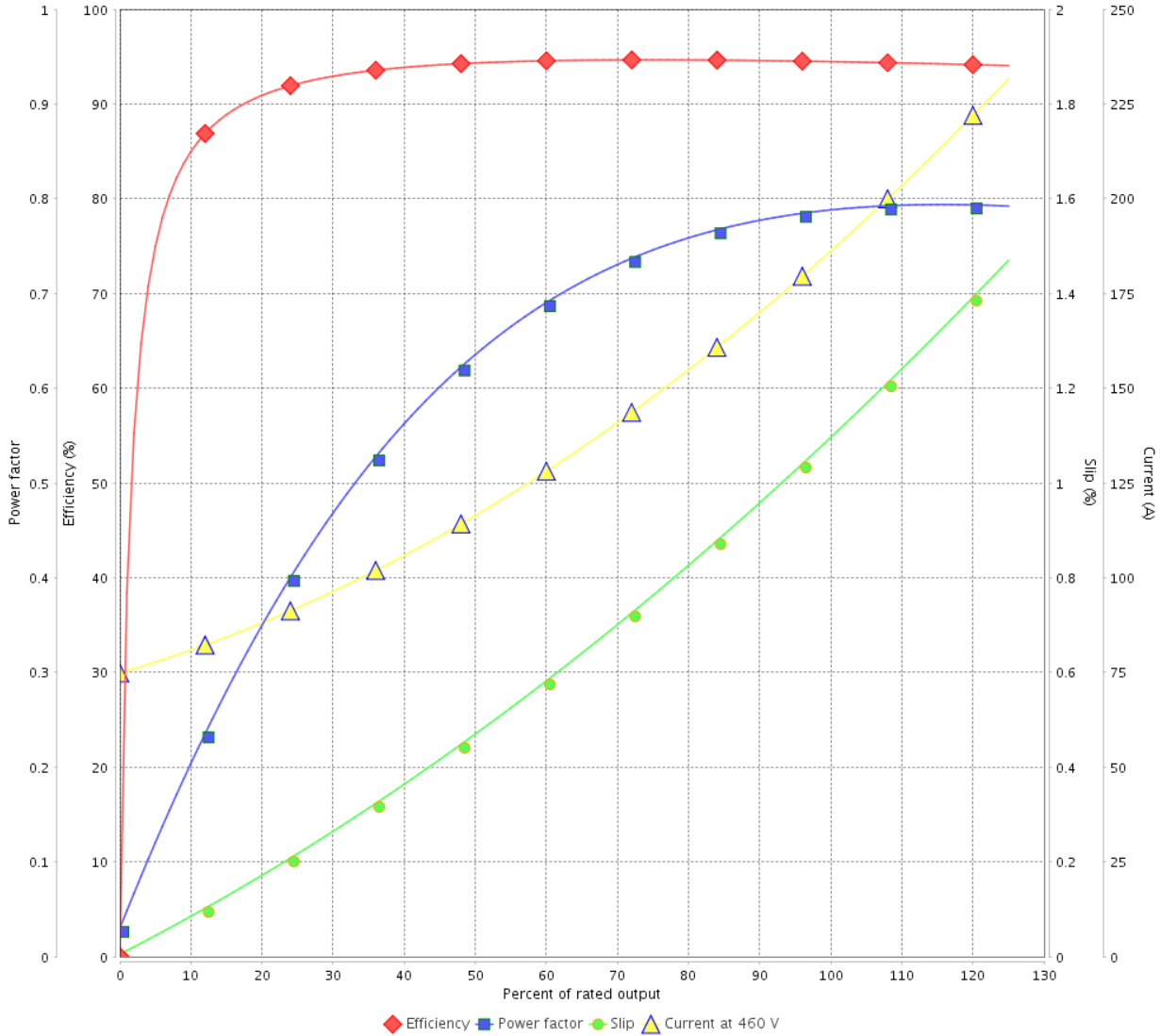

Performance : 460 V 60 Hz 8P

Rated current	: 185 A	Moment of inertia (J)	: 125 sq.ft.lb
LRC	: 6.0	Duty cycle	: Cont.(S1)
Rated torque	: 885 ft.lb	Insulation class	: F
Locked rotor torque	: 190 %	Service factor	: 1.15
Breakdown torque	: 210 %	Temperature rise	: 80 K
Rated speed	: 890 rpm	Design	: B

Rev.	Changes Summary	Performed	Checked	Date
Performed by			Page 6 / 21	Revision
Checked by				
Date	13/04/2022			

LOAD PERFORMANCE CURVE

Three Phase Induction Motor - Squirrel Cage



Customer : _____

Product line : NEMA Premium Efficiency Three-Phase

Product code : 12176656

Catalog # : 15009ST3QIE447T-W22

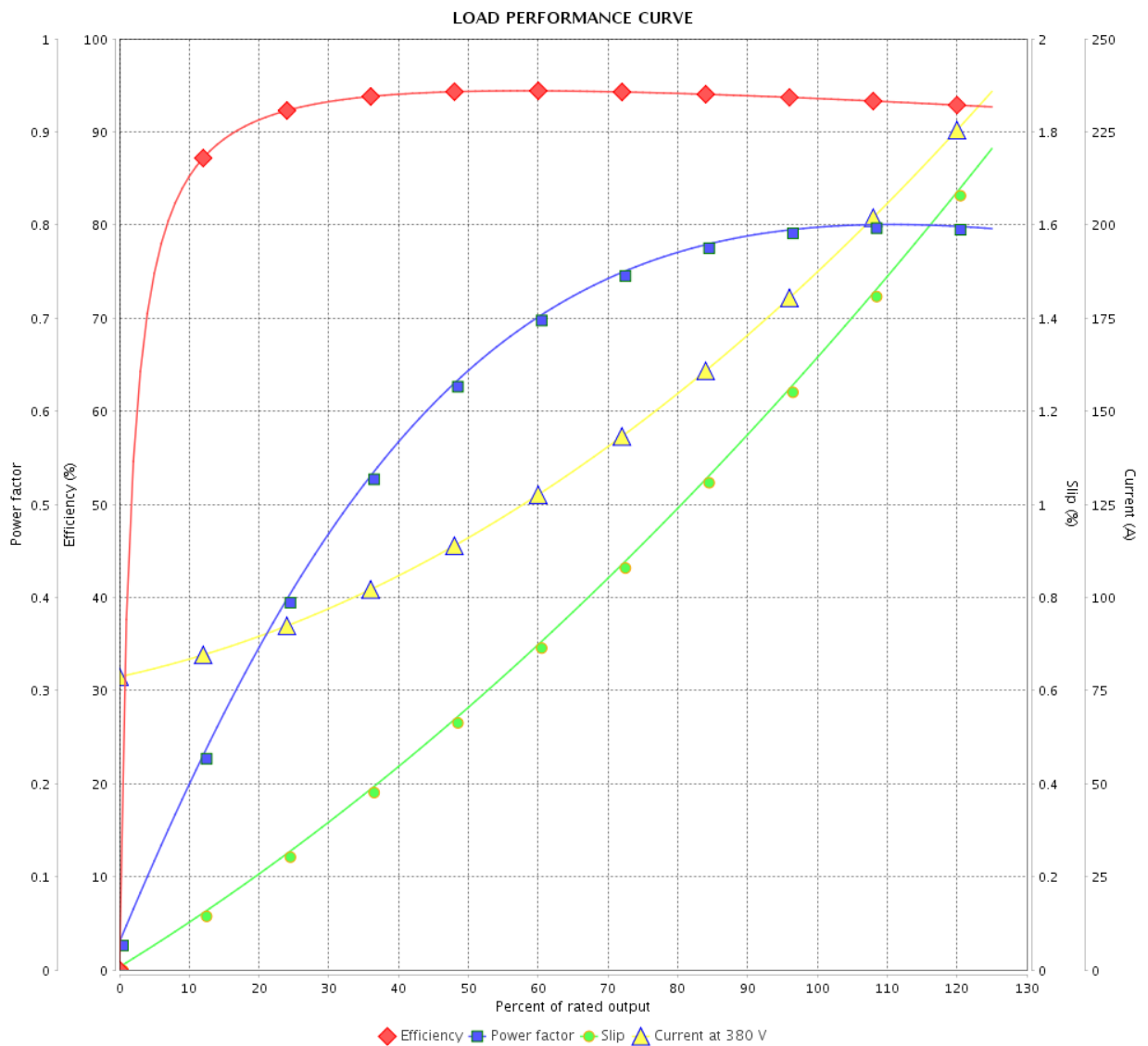

Performance : 380 V 50 Hz 8P IE3

Rated current : 183 A
 LRC : 5.6
 Rated torque : 887 ft.lb
 Locked rotor torque : 170 %
 Breakdown torque : 200 %
 Rated speed : 740 rpm

Moment of inertia (J) : 125 sq.ft.lb
 Duty cycle : Cont.(S1)
 Insulation class : F
 Service factor : 1.15
 Temperature rise : 105 K
 Design : B

Rev.	Changes Summary	Performed	Checked	Date
Performed by				
Checked by				
Date				
		Page	Revision	
		7 / 21		

LOAD PERFORMANCE CURVE

Three Phase Induction Motor - Squirrel Cage



Customer :

Product line : NEMA Premium Efficiency Three-Phase

Product code : 12176656

Catalog # : 15009ST3QIE447T-W22

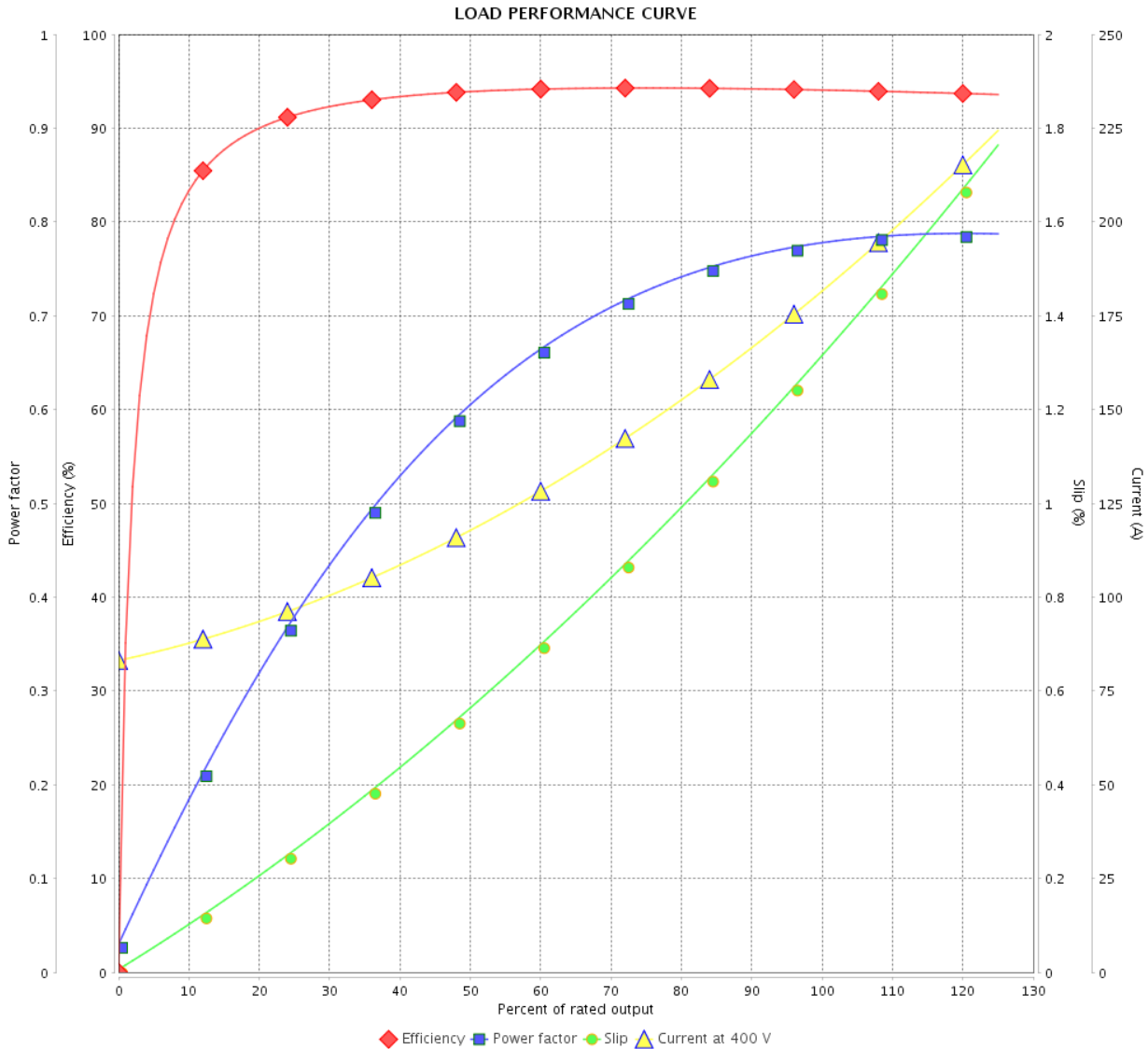

Performance : 400 V 50 Hz 8P IE3

Rated current : 177 A	Moment of inertia (J) : 125 sq.ft.lb
LRC : 6.2	Duty cycle : Cont.(S1)
Rated torque : 887 ft.lb	Insulation class : F
Locked rotor torque : 200 %	Service factor : 1.15
Breakdown torque : 229 %	Temperature rise : 80 K
Rated speed : 740 rpm	Design : B

Rev.	Changes Summary	Performed	Checked	Date
Performed by			Page	Revision
Checked by				
Date	13/04/2022			

LOAD PERFORMANCE CURVE

Three Phase Induction Motor - Squirrel Cage



Customer : _____

Product line : NEMA Premium Efficiency Three-Phase

Product code : 12176656

Catalog # : 15009ST3QIE447T-W22

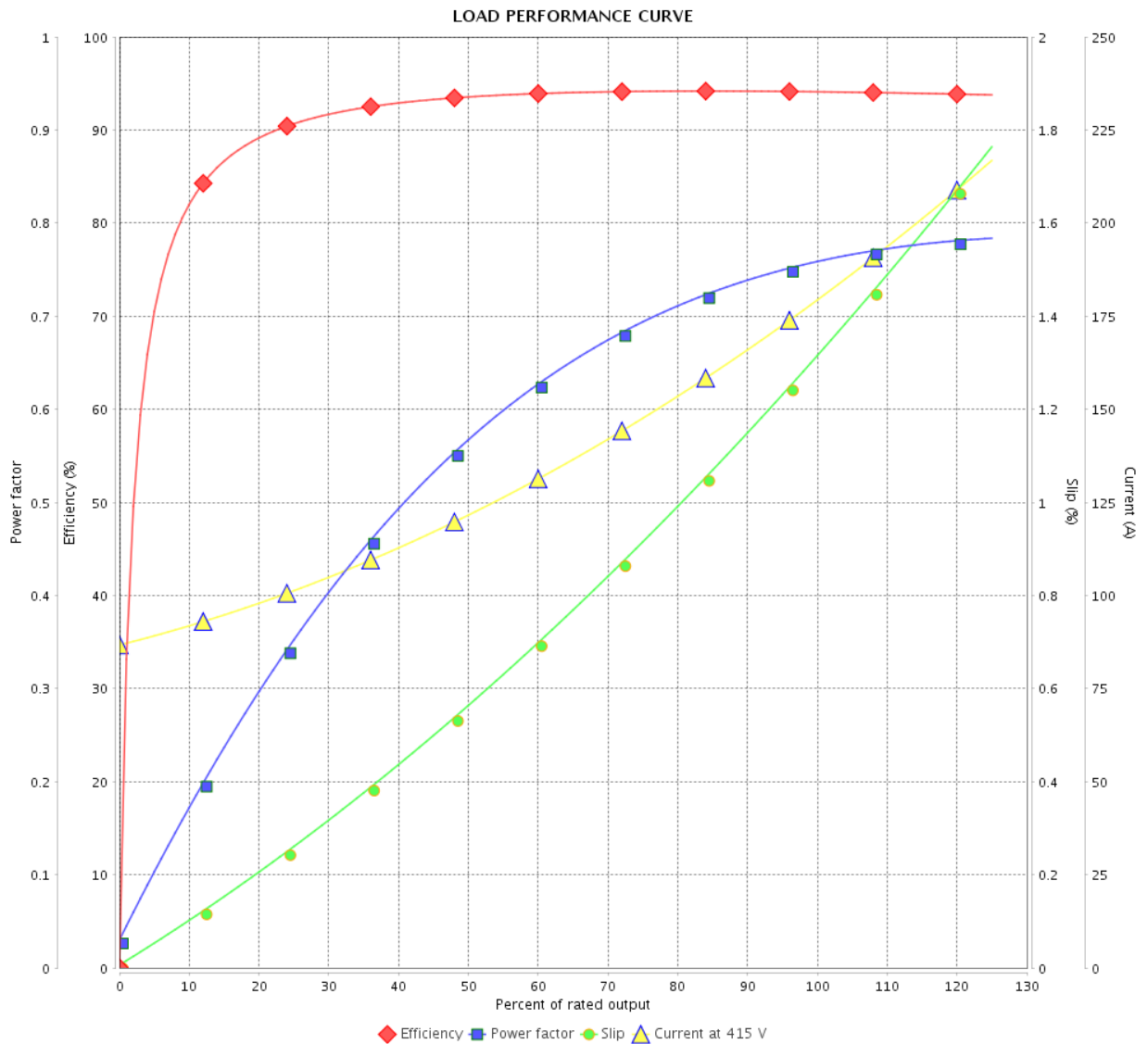

Performance : 415 V 50 Hz 8P IE3

Rated current : 175 A
 LRC : 6.5
 Rated torque : 887 ft.lb
 Locked rotor torque : 220 %
 Breakdown torque : 250 %
 Rated speed : 740 rpm

Moment of inertia (J) : 125 sq.ft.lb
 Duty cycle : Cont.(S1)
 Insulation class : F
 Service factor : 1.15
 Temperature rise : 80 K
 Design : B

Rev.	Changes Summary	Performed	Checked	Date
Performed by		Page		Revision
Checked by		9 / 21		
Date		13/04/2022		

THERMAL LIMIT CURVE

Three Phase Induction Motor - Squirrel Cage



Customer :

Product line : NEMA Premium Efficiency Three-Phase
Product code : 12176656
Catalog # : 15009ST3QIE447T-W22

Performance : 460 V 60 Hz 8P

Rated current	: 185 A	Moment of inertia (J)	: 125 sq.ft.lb
LRC	: 6.0	Duty cycle	: Cont.(S1)
Rated torque	: 885 ft.lb	Insulation class	: F
Locked rotor torque	: 190 %	Service factor	: 1.15
Breakdown torque	: 210 %	Temperature rise	: 80 K
Rated speed	: 890 rpm	Design	: B

Heating constant

Cooling constant

Rev.	Changes Summary	Performed	Checked	Date
Performed by				
Checked by			Page	Revision
Date	13/04/2022		10 / 21	

THERMAL LIMIT CURVE

Three Phase Induction Motor - Squirrel Cage



Customer : _____

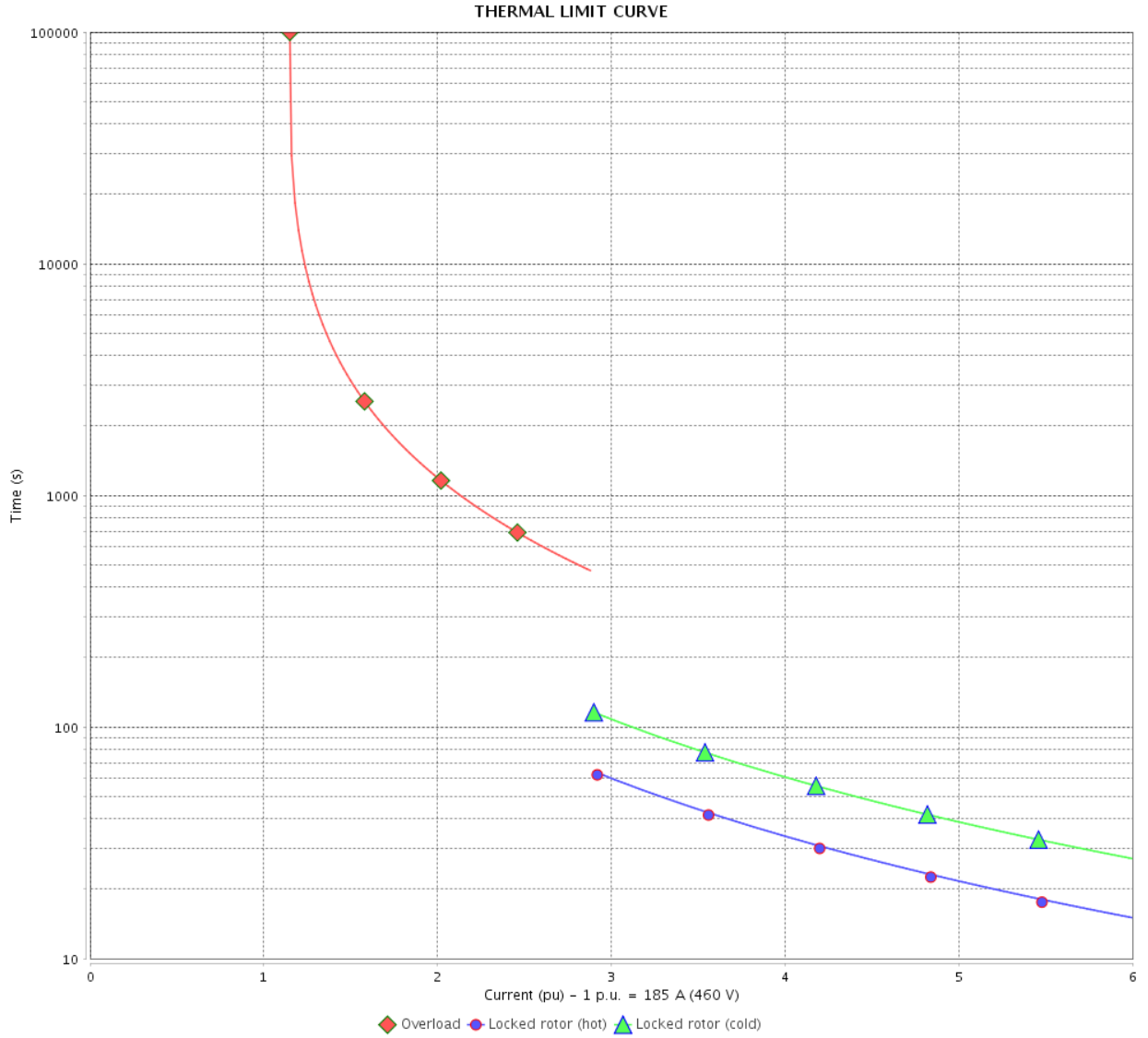

Rev.	Changes Summary	Performed	Checked	Date
Performed by				
Checked by				
Date				
			Page	Revision
			11 / 21	

THERMAL LIMIT CURVE

Three Phase Induction Motor - Squirrel Cage



Customer :

Product line : NEMA Premium Efficiency Three-Phase
Product code : 12176656
Catalog # : 15009ST3QIE447T-W22

Performance : 380 V 50 Hz 8P IE3

Rated current	: 183 A	Moment of inertia (J)	: 125 sq.ft.lb
LRC	: 5.6	Duty cycle	: Cont.(S1)
Rated torque	: 887 ft.lb	Insulation class	: F
Locked rotor torque	: 170 %	Service factor	: 1.15
Breakdown torque	: 200 %	Temperature rise	: 105 K
Rated speed	: 740 rpm	Design	: B

Heating constant

Cooling constant

Rev.	Changes Summary	Performed	Checked	Date
Performed by				
Checked by			Page	Revision
Date	13/04/2022		12 / 21	

THERMAL LIMIT CURVE

Three Phase Induction Motor - Squirrel Cage



Customer : _____

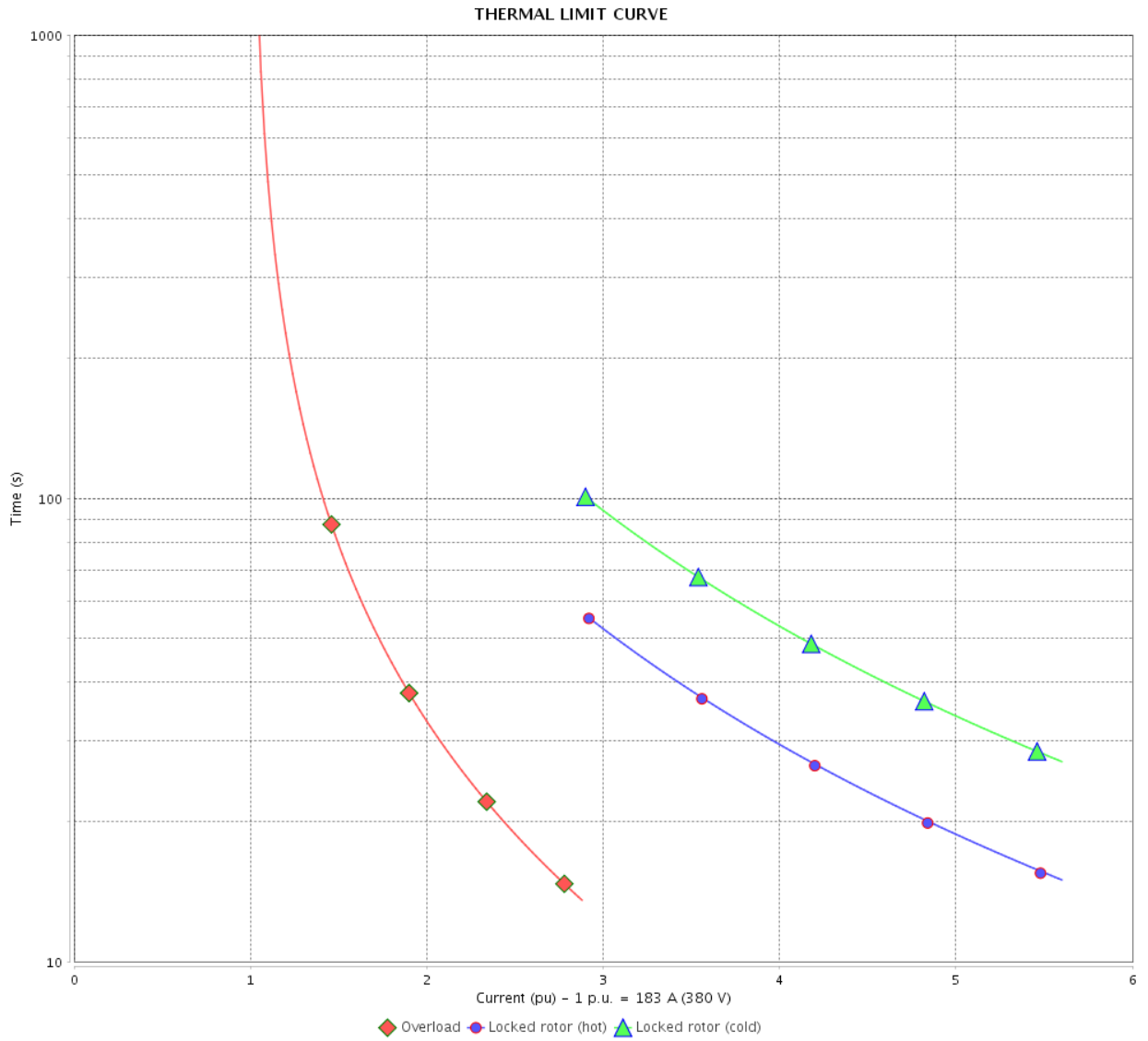

Rev.	Changes Summary	Performed	Checked	Date
Performed by				
Checked by				
Date				
			Page	Revision
			13 / 21	

THERMAL LIMIT CURVE



Three Phase Induction Motor - Squirrel Cage

Customer :

Product line : NEMA Premium Efficiency Three-Phase
Product code : 12176656
Catalog # : 15009ST3QIE447T-W22

Performance : 400 V 50 Hz 8P IE3

Rated current	: 177 A	Moment of inertia (J)	: 125 sq.ft.lb
LRC	: 6.2	Duty cycle	: Cont.(S1)
Rated torque	: 887 ft.lb	Insulation class	: F
Locked rotor torque	: 200 %	Service factor	: 1.15
Breakdown torque	: 229 %	Temperature rise	: 80 K
Rated speed	: 740 rpm	Design	: B

Heating constant

Cooling constant

Rev.	Changes Summary	Performed	Checked	Date
Performed by				
Checked by			Page	Revision
Date	13/04/2022		14 / 21	

THERMAL LIMIT CURVE

Three Phase Induction Motor - Squirrel Cage



Customer : _____

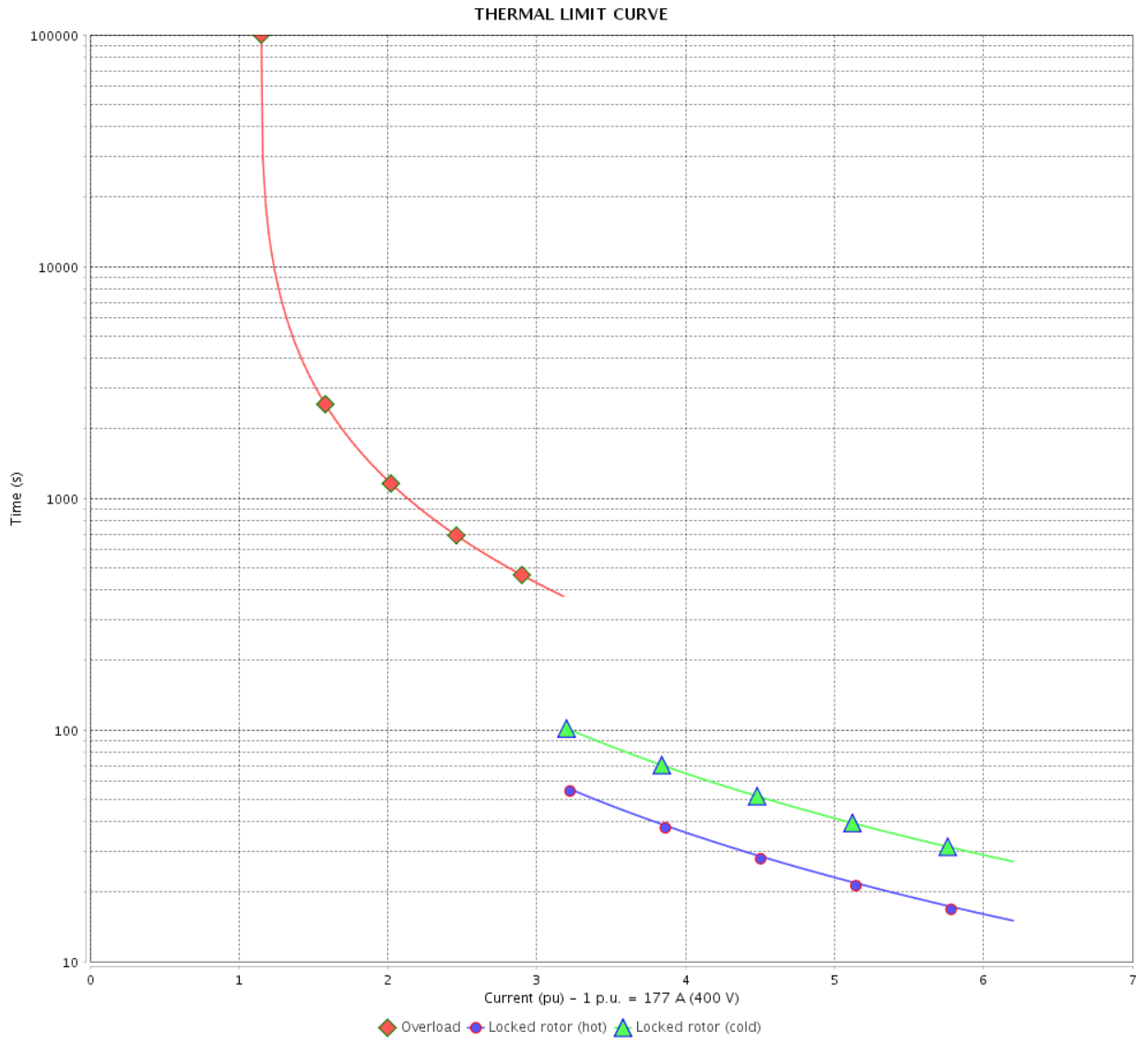

Rev.	Changes Summary	Performed	Checked	Date
Performed by		Page		Revision
Checked by		15 / 21		
Date		13/04/2022		

THERMAL LIMIT CURVE

Three Phase Induction Motor - Squirrel Cage



Customer :

Product line : NEMA Premium Efficiency Three-Phase
Product code : 12176656
Catalog # : 15009ST3QIE447T-W22

Performance : 415 V 50 Hz 8P IE3

Rated current	: 175 A	Moment of inertia (J)	: 125 sq.ft.lb
LRC	: 6.5	Duty cycle	: Cont.(S1)
Rated torque	: 887 ft.lb	Insulation class	: F
Locked rotor torque	: 220 %	Service factor	: 1.15
Breakdown torque	: 250 %	Temperature rise	: 80 K
Rated speed	: 740 rpm	Design	: B

Heating constant

Cooling constant

Rev.	Changes Summary	Performed	Checked	Date
Performed by				
Checked by			Page	Revision
Date	13/04/2022		16 / 21	

THERMAL LIMIT CURVE

Three Phase Induction Motor - Squirrel Cage



Customer : _____

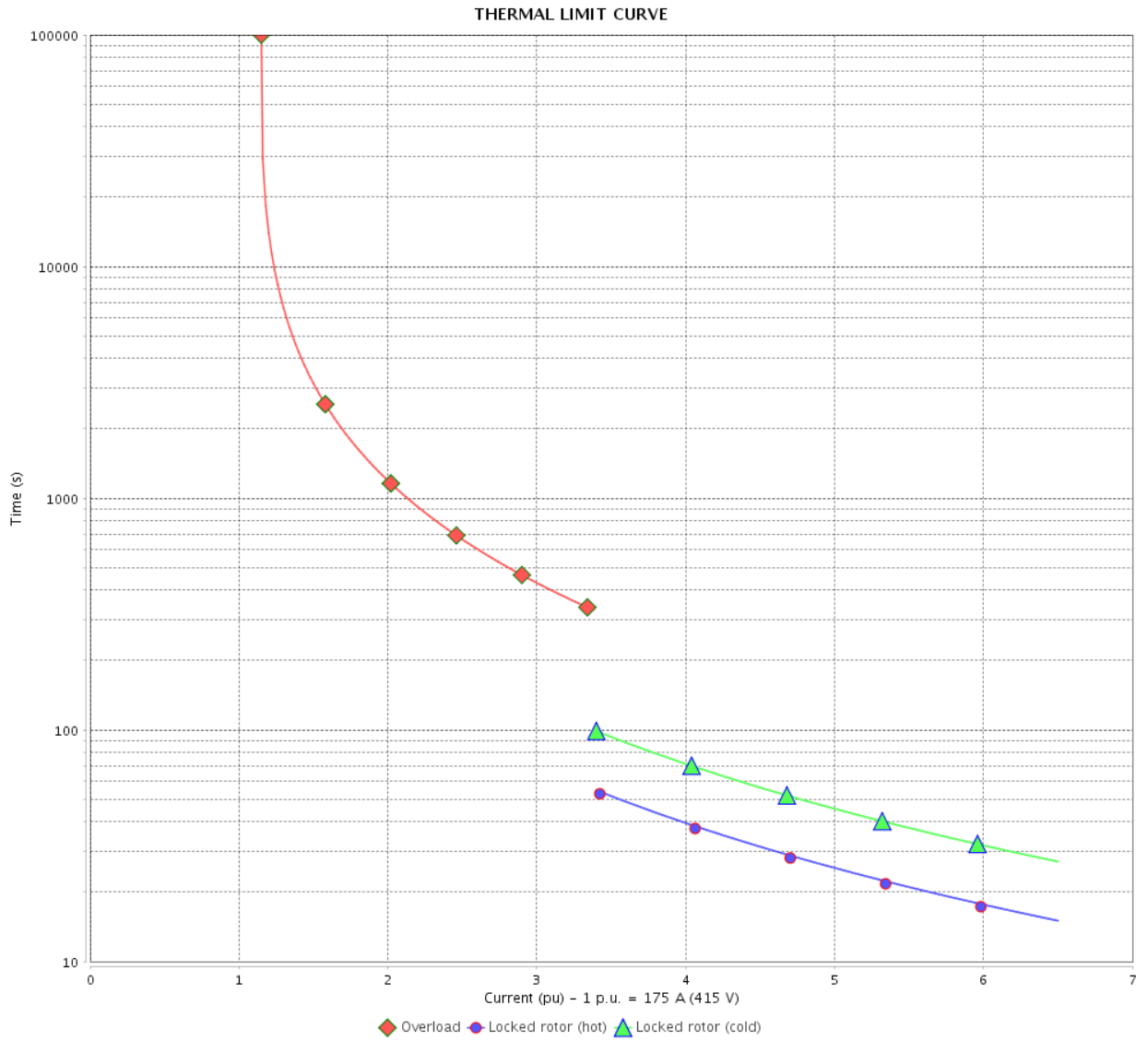

Rev.	Changes Summary	Performed	Checked	Date
Performed by		Page 17 / 21		Revision
Checked by				
Date				

VFD OPERATION CURVE

Three Phase Induction Motor - Squirrel Cage



Customer :

Product line : NEMA Premium Efficiency Three-Phase

Product code : 12176656

Catalog # : 15009ST3QIE447T-W22

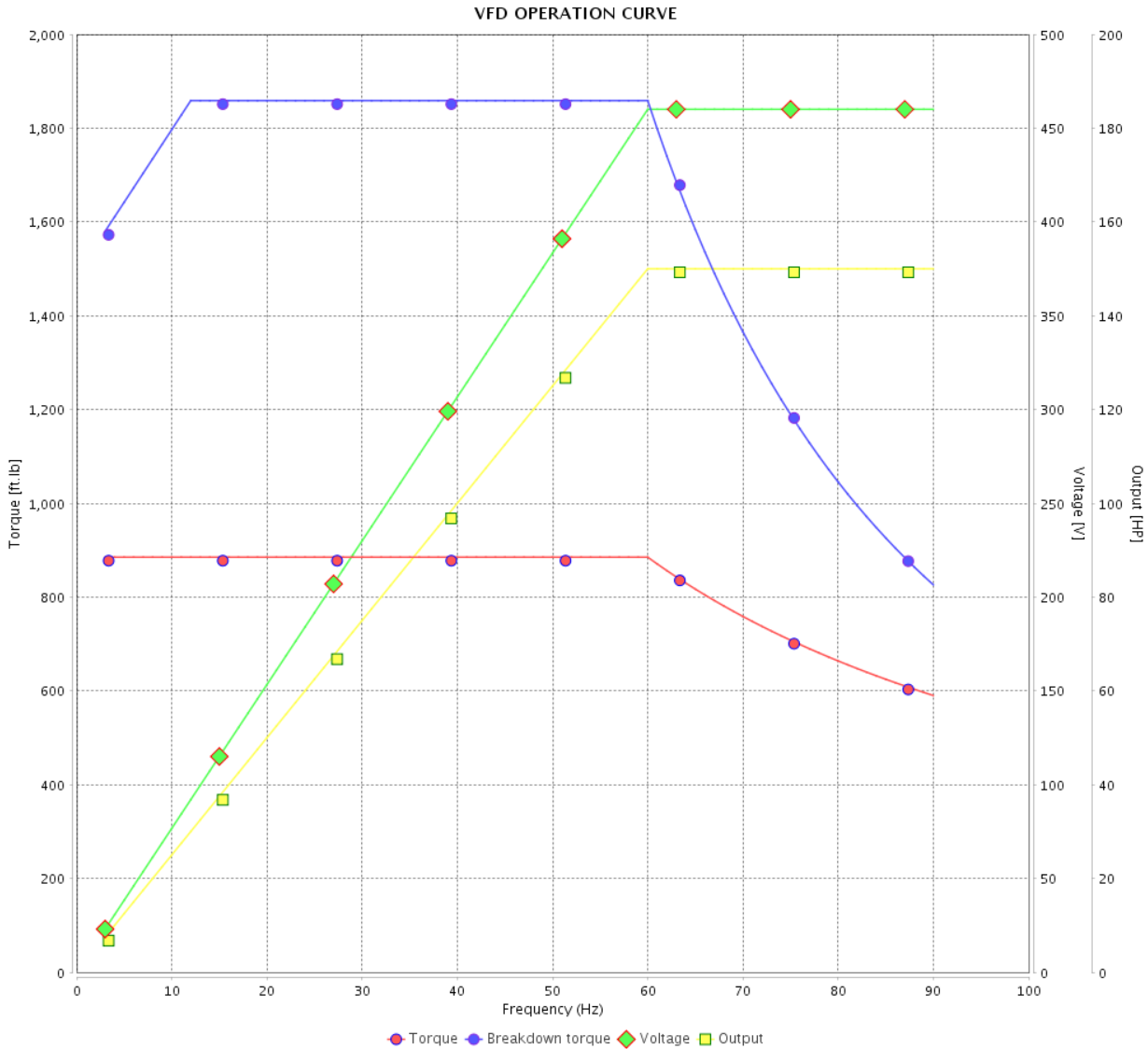

Performance : 460 V 60 Hz 8P

Rated current	: 185 A	Moment of inertia (J)	: 125 sq.ft.lb
LRC	: 6.0	Duty cycle	: Cont.(S1)
Rated torque	: 885 ft.lb	Insulation class	: F
Locked rotor torque	: 190 %	Service factor	: 1.15
Breakdown torque	: 210 %	Temperature rise	: 80 K
Rated speed	: 890 rpm	Design	: B

Rev.	Changes Summary	Performed	Checked	Date
Performed by			Page 18 / 21	Revision
Checked by				
Date	13/04/2022			

VFD OPERATION CURVE

Three Phase Induction Motor - Squirrel Cage



Customer :

Product line : NEMA Premium Efficiency Three-Phase

Product code : 12176656

Catalog # : 15009ST3QIE447T-W22

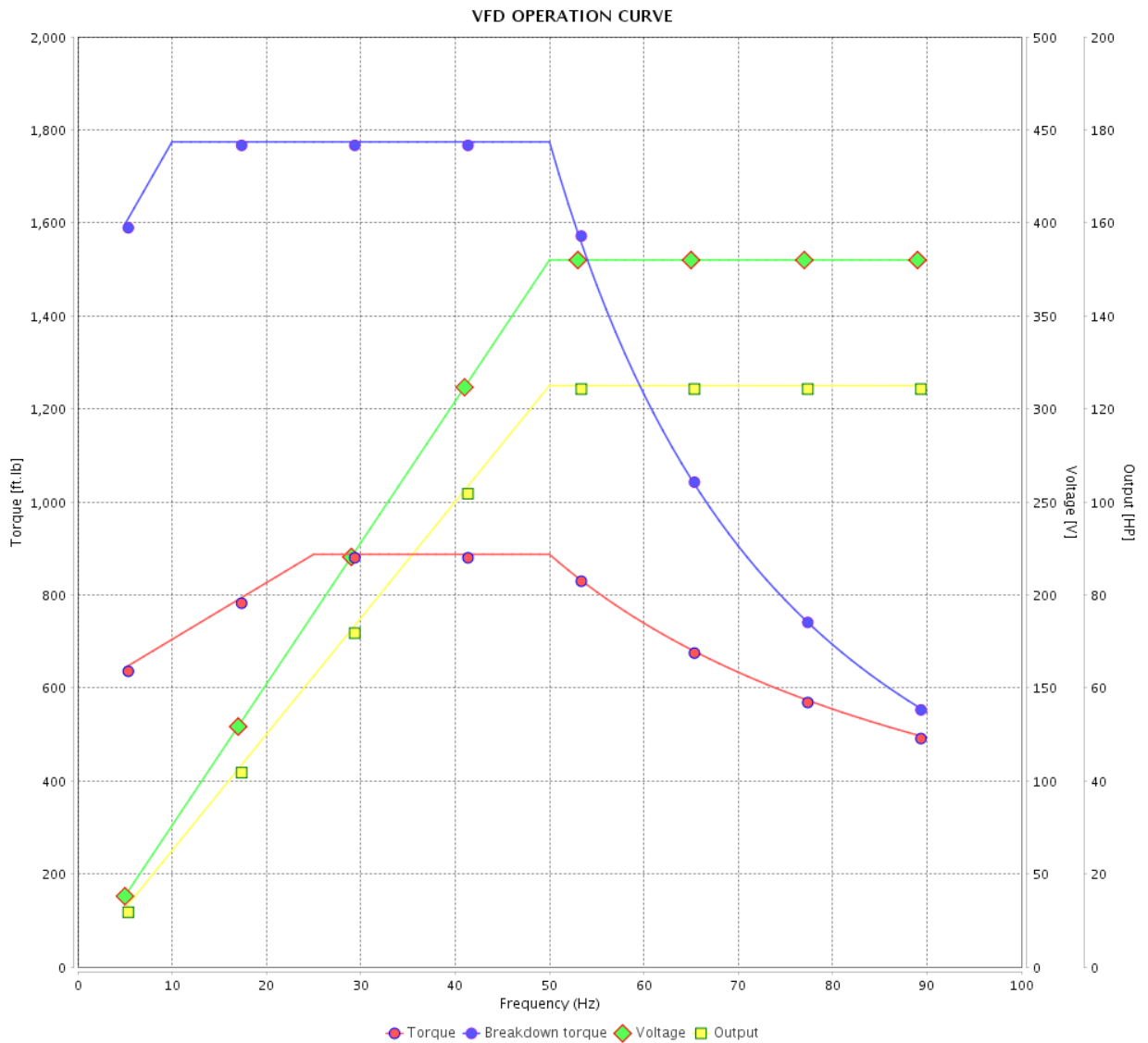

Performance : 380 V 50 Hz 8P IE3

Rated current : 183 A
 LRC : 5.6
 Rated torque : 887 ft.lb
 Locked rotor torque : 170 %
 Breakdown torque : 200 %
 Rated speed : 740 rpm

Moment of inertia (J) : 125 sq.ft.lb
 Duty cycle : Cont.(S1)
 Insulation class : F
 Service factor : 1.15
 Temperature rise : 105 K
 Design : B

Rev.	Changes Summary	Performed	Checked	Date
Performed by			Page 19 / 21	Revision
Checked by				
Date	13/04/2022			

VFD OPERATION CURVE

Three Phase Induction Motor - Squirrel Cage



Customer :

Product line : NEMA Premium Efficiency Three-Phase

Product code : 12176656

Catalog # : 15009ST3QIE447T-W22

VFD OPERATION CURVE

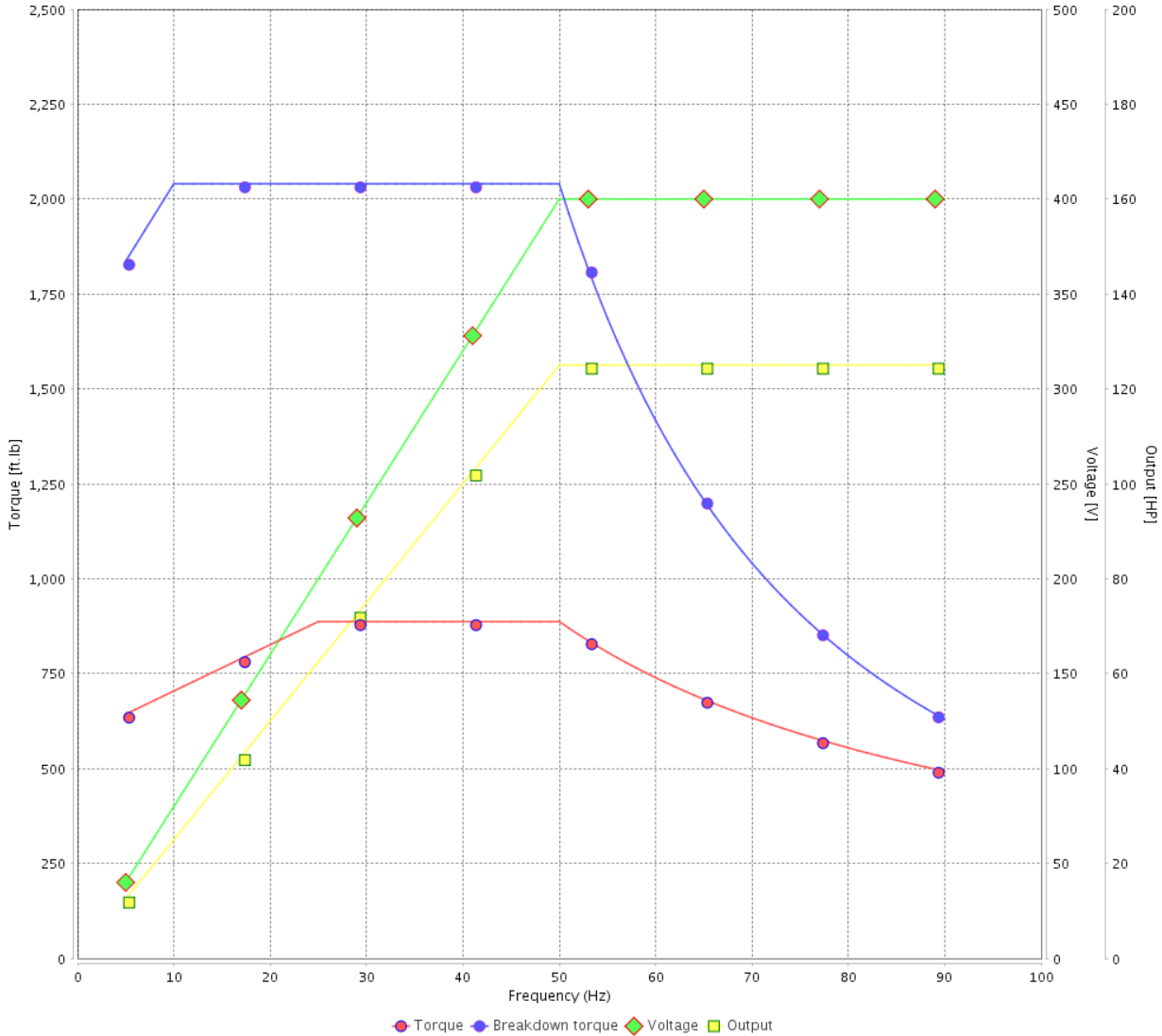

Performance : 400 V 50 Hz 8P IE3

Rated current	: 177 A	Moment of inertia (J)	: 125 sq.ft.lb
LRC	: 6.2	Duty cycle	: Cont.(S1)
Rated torque	: 887 ft.lb	Insulation class	: F
Locked rotor torque	: 200 %	Service factor	: 1.15
Breakdown torque	: 229 %	Temperature rise	: 80 K
Rated speed	: 740 rpm	Design	: B

Rev.	Changes Summary	Performed	Checked	Date
Performed by			Page 20 / 21	Revision
Checked by				
Date	13/04/2022			

VFD OPERATION CURVE

Three Phase Induction Motor - Squirrel Cage



Customer : _____

Product line : NEMA Premium Efficiency Three-Phase

Product code : 12176656

Catalog # : 15009ST3QIE447T-W22

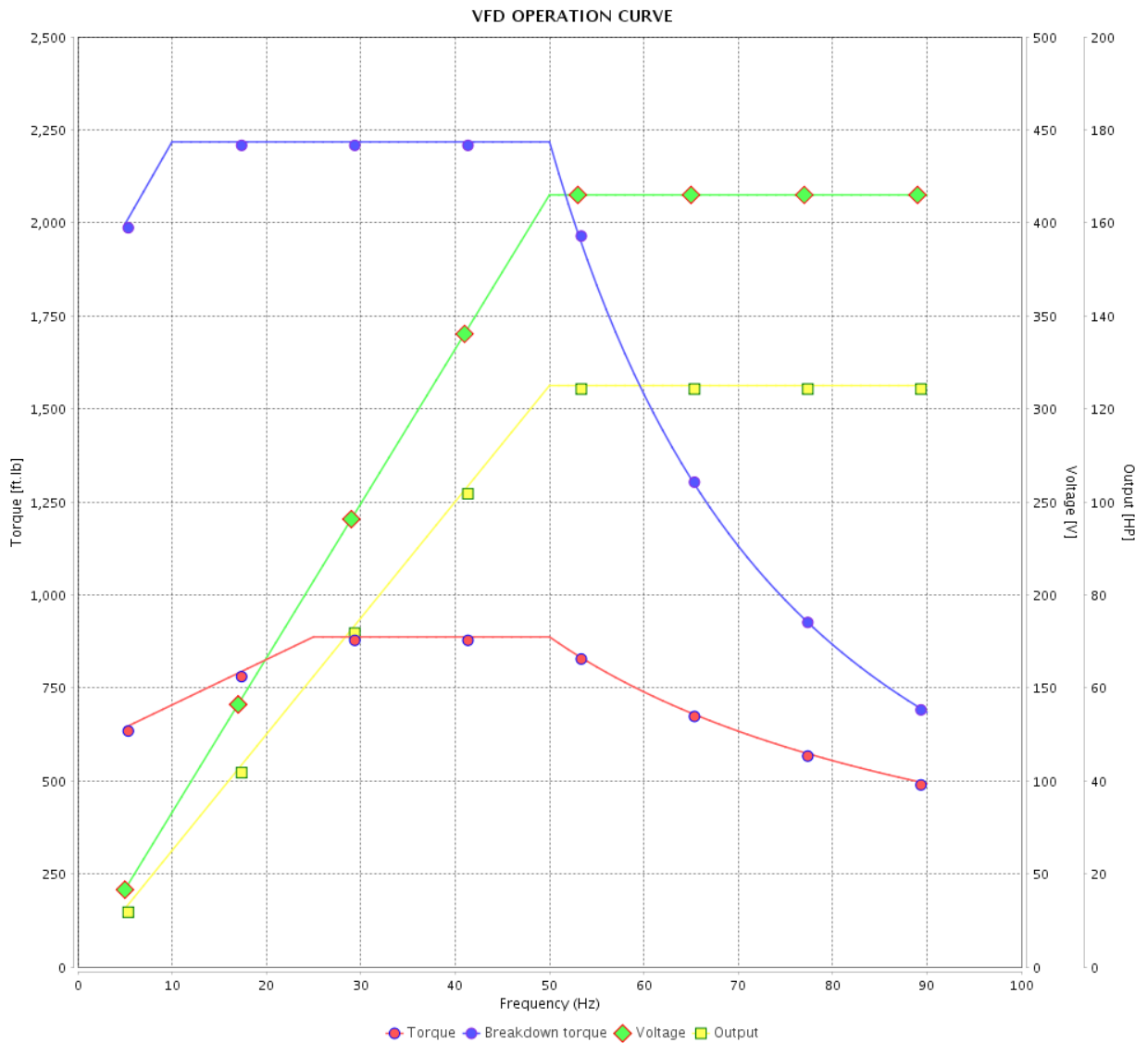

Performance : 415 V 50 Hz 8P IE3

Rated current : 175 A
 LRC : 6.5
 Rated torque : 887 ft.lb
 Locked rotor torque : 220 %
 Breakdown torque : 250 %
 Rated speed : 740 rpm

Moment of inertia (J) : 125 sq.ft.lb
 Duty cycle : Cont.(S1)
 Insulation class : F
 Service factor : 1.15
 Temperature rise : 80 K
 Design : B

Rev.	Changes Summary	Performed	Checked	Date
Performed by		Page		Revision
Checked by		21 / 21		
Date		13/04/2022		

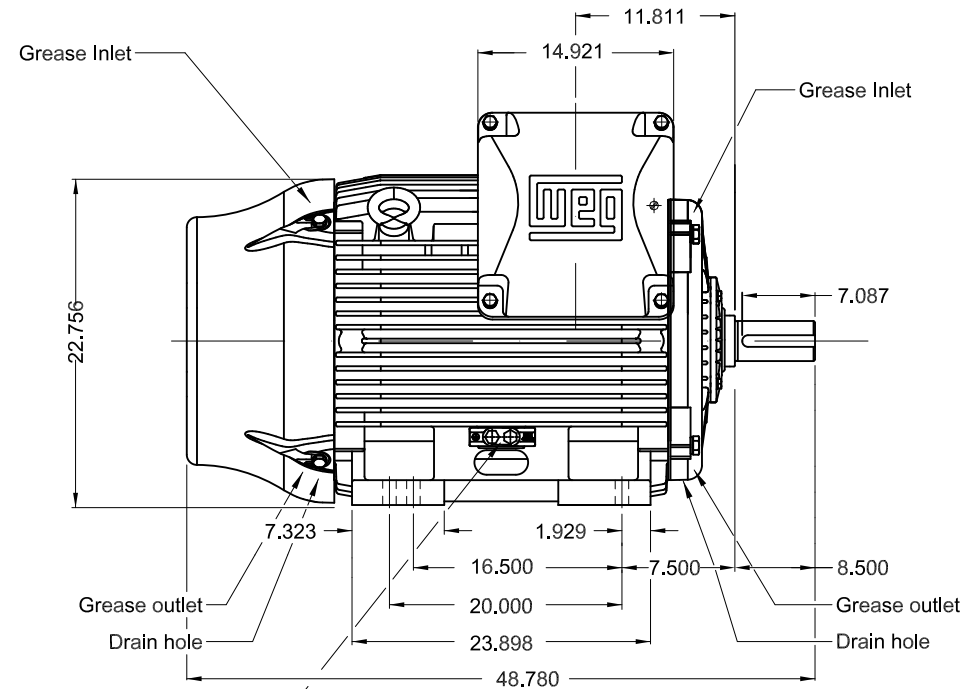
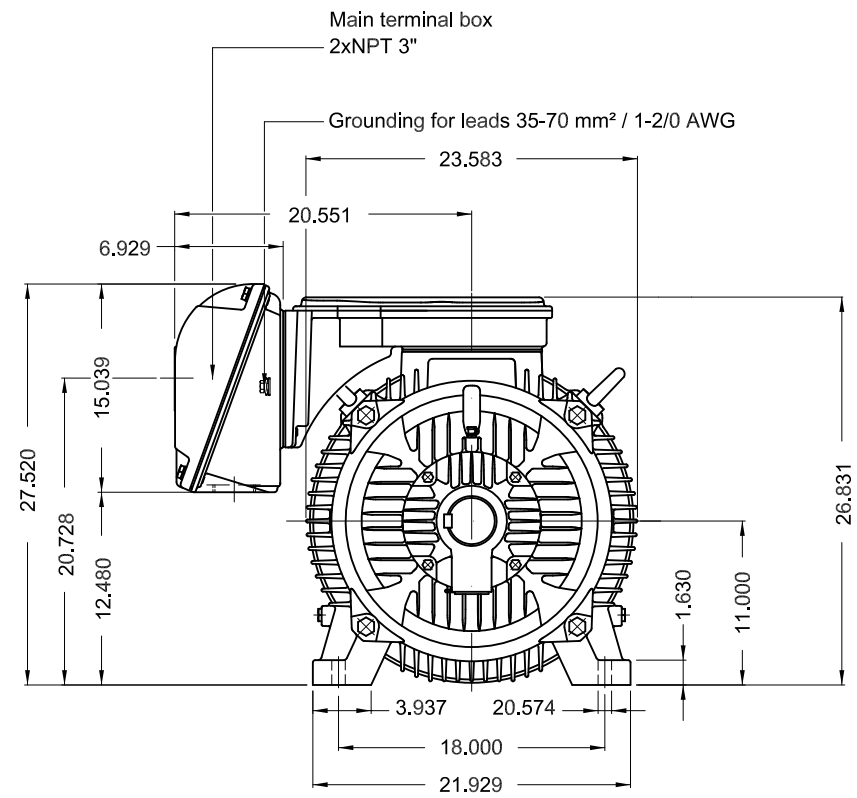

Grounding for leads 25-185 mm² / 3AWG-350MCM

Color RAL 5009
 Painting plan 202E
 Mounting B3R(D)

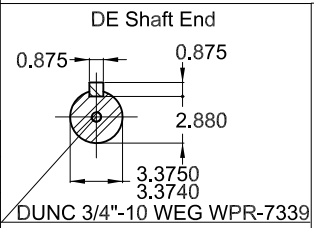

150 HP 08 Poles 60 Hz

A

ECM	LOC	SUMMARY OF MODIFICATIONS	EXECUTED	CHECKED	RELEASED	DATE	VER
EXECUTED	PIRWUSER	THREE PH. MOTOR IEEE 841 W22 PREM. EFF.					
CHECKED		FRAME 445/7T IP55 TEFC					
RELEASED							
REL DT.	WMO	Jaragua do Sul	Product Engineering				

PREVIEW
 WDD



SHEET 1 / 1

Dimensions in inches XME A3



NEMA
Premium
W22



FOR SAFE AREA
Mod.TE1BFOXON
CC029A



Class I, Div 2, Gr A, B, C and D - T3
Class I, Zone 2, IIC - T3
Class II, Div 2, Gr F and G - T3C
For use on PWM: Gr. A, B, C, D and F,
VT 1000:1, CT 20:1, 1.00SF - T3

MODEL 15009ST3QIE447T-W22



Inverter Duty Motor
Severe Duty

MADE IN BRAZIL
12176656

PH3 60Hz Fr. 445/7T 1000m.a.s.l. IP55 TEFC 2214lb

V 460

A 185

HP 150

kW 110

SF 1.15

SFA 213

RPM 890

PF 0.79

AMB 40°C

INS cl. F DT80K

NEMA NOM EFF 94.5%

DUTY CONT.

DES B Code G

GUARANT. EFF 93.6%

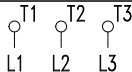

460V



→ 6319-C3 (45g) 95BC03X30

→ 6316-C3 (34g) 80BC03X30



MOBIL POLYREX EM (17000h)

