

# DATA SHEET

## Three Phase Induction Motor - Squirrel Cage



Customer								
Product line	: NEMA Premium Efficiency Three-Phase	Product code	: 11457762					
		Catalog #	: 15012ET3GRB447T-W22					
Frame	: 445/7T	Cooling method	: IC411 - TEFC					
Insulation class	: F	Mounting	: F-1					
Duty cycle	: Cont.(S1)	Rotation <sup>1</sup>	: Both (CW and CCW)					
Ambient temperature	: -20°C to +40°C	Starting method	: Direct On Line					
Altitude	: 1000 m.a.s.l.	Approx. weight <sup>2</sup>	: 2285 lb					
Protection degree	: IP55	Moment of inertia (J)	: 134 sq.ft.lb					
Design	: B							
Output [HP]	150	125	125	125	150	150	150	
Poles	6	6	6	6	6	6	6	
Frequency [Hz]	60	50	50	50	50	50	50	
Rated voltage [V]	460	380	400	415	380	400	415	
Rated current [A]	176	174	167	165	211	201	196	
L. R. Amperes [A]	1091	1044	1086	1155	1055	1106	1176	
LRC [A]	6.2x(Code G)	6.0x(Code F)	6.5x(Code G)	7.0x(Code H)	5.0x(Code E)	5.5x(Code F)	6.0x(Code G)	
No load current [A]	70.0	70.0	74.0	78.0	70.0	74.0	78.0	
Rated speed [RPM]	1187	987	989	990	982	985	986	
Slip [%]	1.08	1.30	1.10	1.00	1.80	1.50	1.40	
Rated torque [ft.lb]	664	665	664	663	802	800	799	
Locked rotor torque [%]	240	240	270	290	190	220	240	
Breakdown torque [%]	250	240	270	290	200	229	250	
Service factor	1.15	1.00	1.00	1.00	1.00	1.00	1.00	
Temperature rise	80 K	80 K	80 K	80 K	105 K	105 K	105 K	
Locked rotor time	36s (cold) 20s (hot)	27s (cold) 15s (hot)	27s (cold) 15s (hot)	27s (cold) 15s (hot)	27s (cold) 15s (hot)	27s (cold) 15s (hot)	27s (cold) 15s (hot)	
Noise level <sup>2</sup>	69.0 dB(A)							
Efficiency (%)	25%	94.5	94.9	94.4	94.4	95.3	94.9	94.9
	50%	95.0	94.8	94.5	94.5	95.0	95.0	95.0
	75%	95.4	95.1	95.1	95.1	95.0	95.0	95.0
	100%	95.8	94.9	95.1	95.1	94.5	95.0	95.0
Power Factor	25%	0.43	0.43	0.40	0.37	0.49	0.46	0.43
	50%	0.67	0.67	0.64	0.60	0.73	0.70	0.67
	75%	0.78	0.79	0.76	0.74	0.82	0.80	0.78
	100%	0.82	0.83	0.82	0.80	0.84	0.83	0.82
Bearing type	: NU-319 C3	Drive end	Non drive end	Foundation loads				
Sealing	: WSeal	WSeal	WSeal	Max. traction	: 4182 lb			
Lubrication interval	: 9000 h	16000 h	16000 h	Max. compression	: 6467 lb			
Lubricant amount	: 45 g	34 g	34 g					
Lubricant type	: Mobil Polyrex EM							
Notes								
This revision replaces and cancel the previous one, which must be eliminated. (1) Looking the motor from the shaft end. (2) Measured at 1m and with tolerance of +3dB(A). (3) Approximate weight subject to changes after manufacturing process. (4) At 100% of full load.				These are average values based on tests with sinusoidal power supply, subject to the tolerances stipulated in NEMA MG-1.				
Rev.	Changes Summary			Performed	Checked	Date		
Performed by								
Checked by						Page	Revision	
Date	13/04/2022					1 / 36		

# TORQUE AND CURRENT VS SPEED CURVE

Three Phase Induction Motor - Squirrel Cage



Customer :

Product line : NEMA Premium Efficiency Three-Phase

Product code : 11457762

Catalog # : 15012ET3GRB447T-W22

TORQUE AND CURRENT VS SPEED CURVE

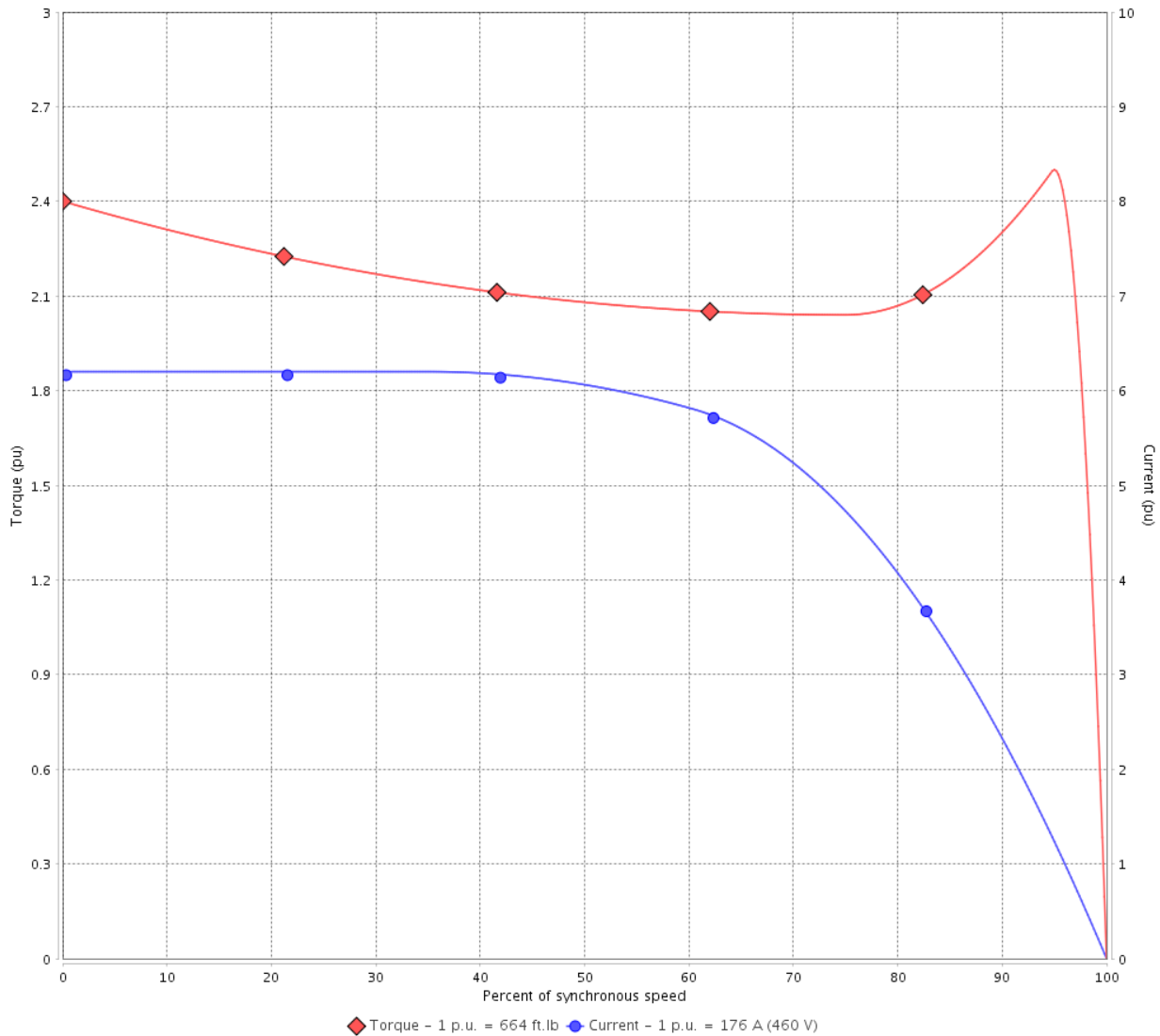

Performance : 460 V 60 Hz 6P

Rated current	: 176 A	Moment of inertia (J)	: 134 sq.ft.lb
LRC	: 6.2	Duty cycle	: Cont.(S1)
Rated torque	: 664 ft.lb	Insulation class	: F
Locked rotor torque	: 240 %	Service factor	: 1.15
Breakdown torque	: 250 %	Temperature rise	: 80 K
Rated speed	: 1187 rpm	Design	: B

Locked rotor time : 36s (cold) 20s (hot)

Rev.	Changes Summary	Performed	Checked	Date
Performed by			Page 2 / 36	Revision
Checked by				
Date	13/04/2022			

# TORQUE AND CURRENT VS SPEED CURVE



## Three Phase Induction Motor - Squirrel Cage

Customer :

Product line : NEMA Premium Efficiency Three-Phase      Product code : 11457762  
 Catalog # : 15012ET3GRB447T-W22

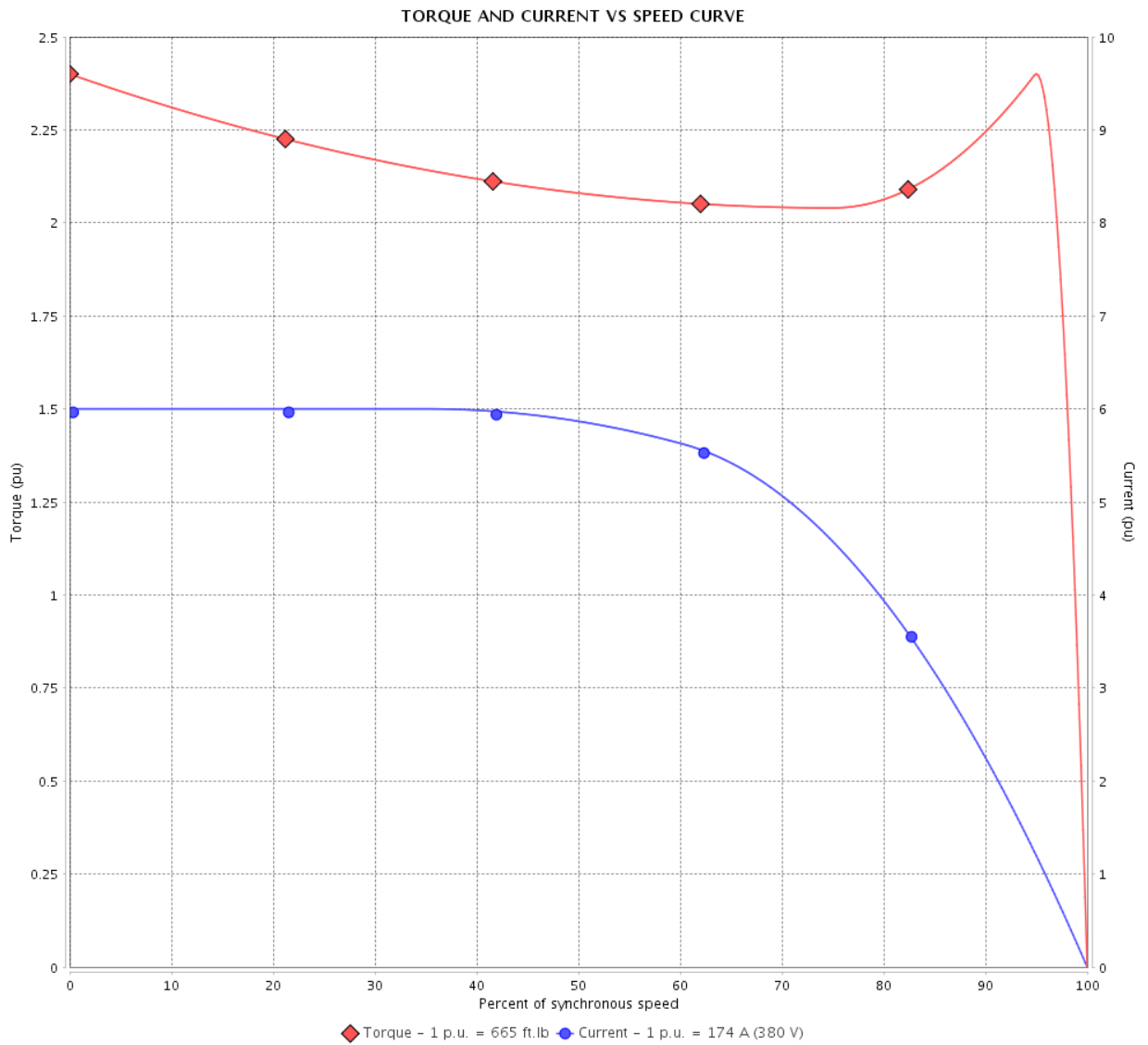

Performance : 380 V 50 Hz 6P IE3

Rated current	: 174 A	Moment of inertia (J)	: 134 sq.ft.lb
LRC	: 6.0	Duty cycle	: Cont.(S1)
Rated torque	: 665 ft.lb	Insulation class	: F
Locked rotor torque	: 240 %	Service factor	: 1.00
Breakdown torque	: 240 %	Temperature rise	: 80 K
Rated speed	: 987 rpm	Design	: B

Locked rotor time : 27s (cold) 15s (hot)

Rev.	Changes Summary	Performed	Checked	Date
Performed by		Page		Revision
Checked by		3 / 36		
Date	13/04/2022			

# TORQUE AND CURRENT VS SPEED CURVE

Three Phase Induction Motor - Squirrel Cage



Customer :

Product line : NEMA Premium Efficiency Three-Phase

Product code : 11457762

Catalog # : 15012ET3GRB447T-W22

TORQUE AND CURRENT VS SPEED CURVE

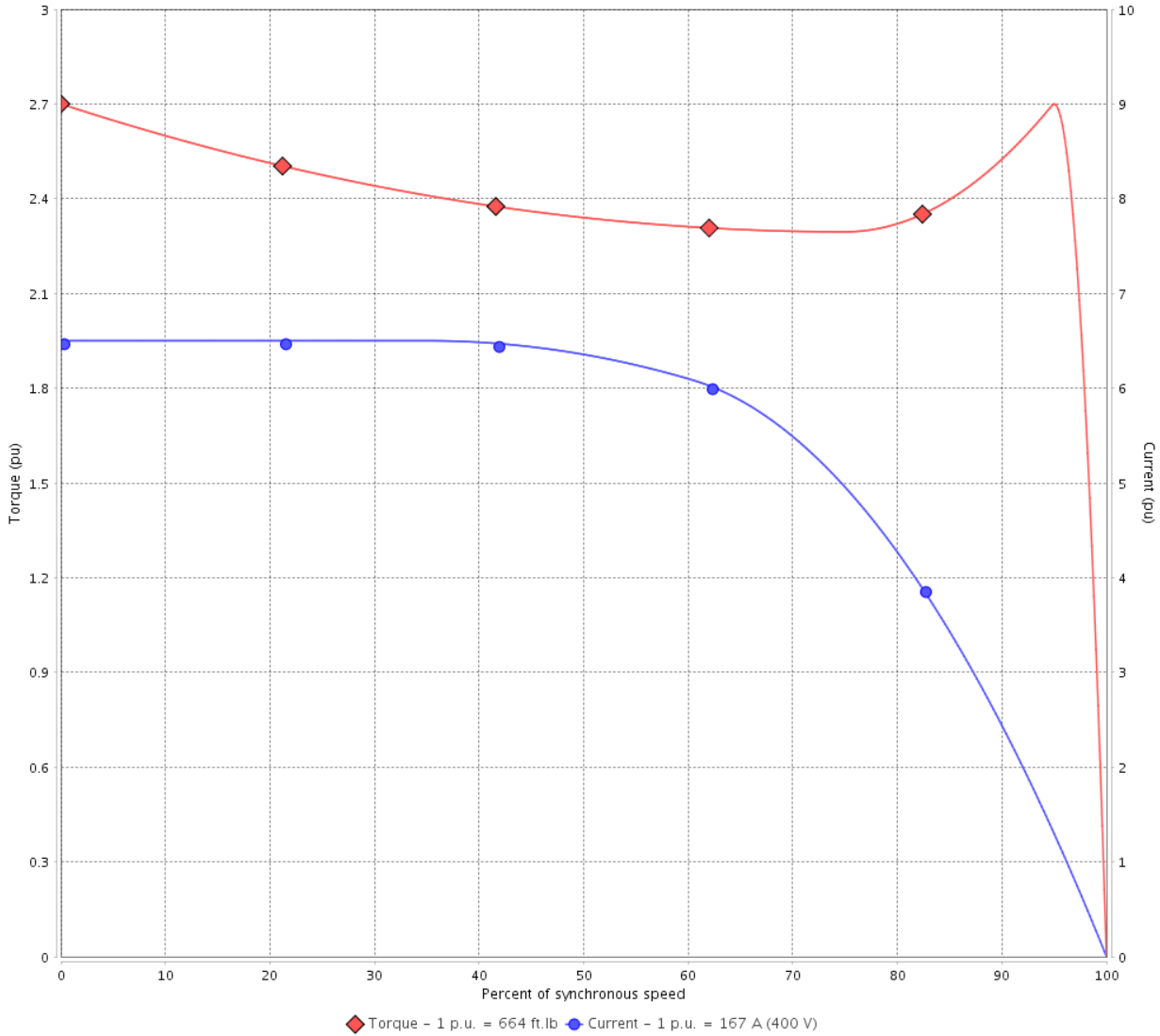

Performance : 400 V 50 Hz 6P IE3

Rated current	: 167 A	Moment of inertia (J)	: 134 sq.ft.lb
LRC	: 6.5	Duty cycle	: Cont.(S1)
Rated torque	: 664 ft.lb	Insulation class	: F
Locked rotor torque	: 270 %	Service factor	: 1.00
Breakdown torque	: 270 %	Temperature rise	: 80 K
Rated speed	: 989 rpm	Design	: B

Locked rotor time : 27s (cold) 15s (hot)

Rev.	Changes Summary	Performed	Checked	Date
Performed by			Page 4 / 36	Revision
Checked by				
Date	13/04/2022			

# TORQUE AND CURRENT VS SPEED CURVE



## Three Phase Induction Motor - Squirrel Cage

Customer :

Product line : NEMA Premium Efficiency Three-Phase

Product code : 11457762

Catalog # : 15012ET3GRB447T-W22

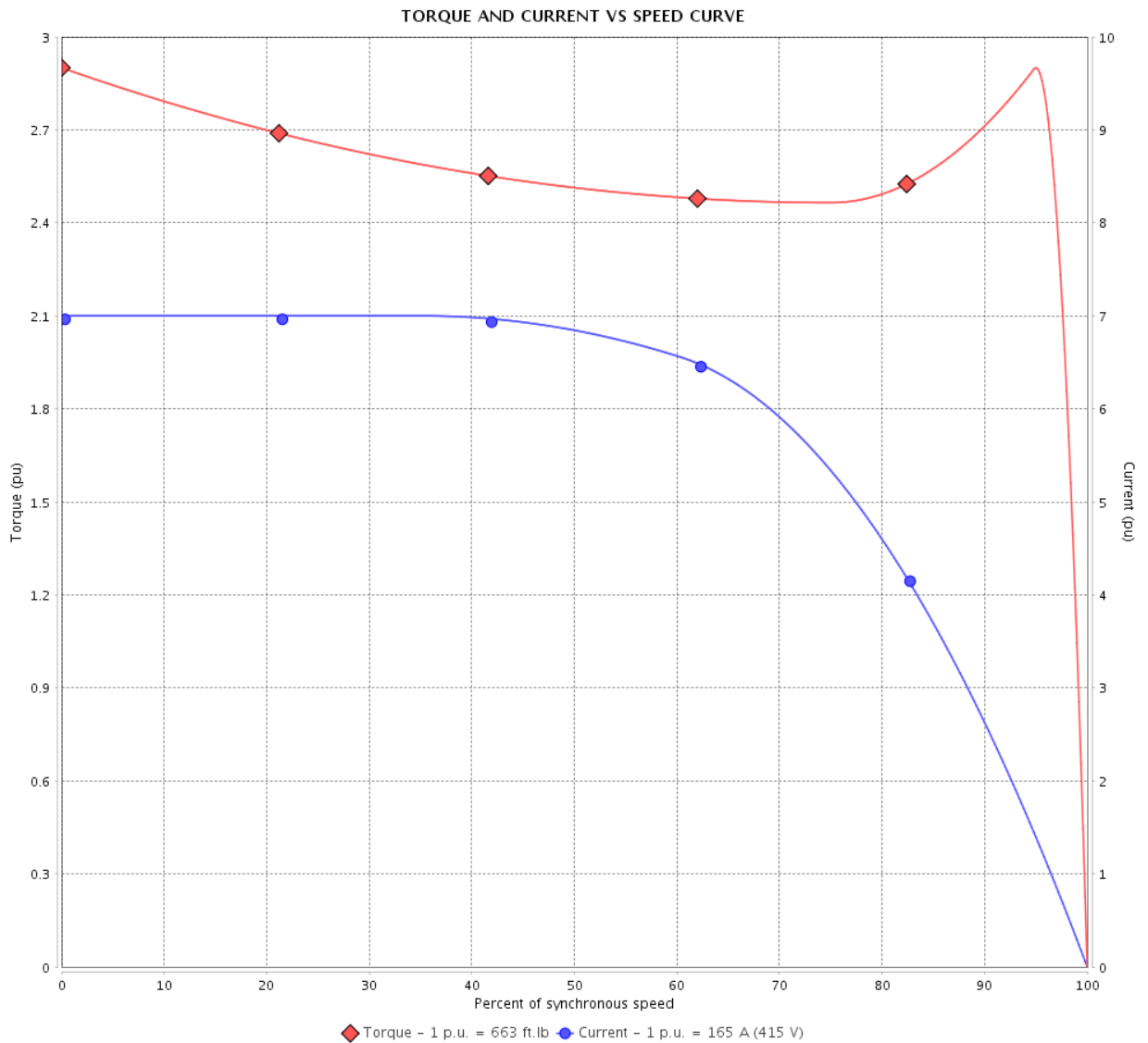

Performance : 415 V 50 Hz 6P IE3

Rated current	: 165 A	Moment of inertia (J)	: 134 sq.ft.lb
LRC	: 7.0	Duty cycle	: Cont.(S1)
Rated torque	: 663 ft.lb	Insulation class	: F
Locked rotor torque	: 290 %	Service factor	: 1.00
Breakdown torque	: 290 %	Temperature rise	: 80 K
Rated speed	: 990 rpm	Design	: B

Locked rotor time : 27s (cold) 15s (hot)

Rev.	Changes Summary	Performed	Checked	Date
Performed by			Page 5 / 36	Revision
Checked by				
Date	13/04/2022			

# TORQUE AND CURRENT VS SPEED CURVE

Three Phase Induction Motor - Squirrel Cage



Customer :

Product line : NEMA Premium Efficiency Three-Phase

Product code : 11457762

Catalog # : 15012ET3GRB447T-W22

TORQUE AND CURRENT VS SPEED CURVE

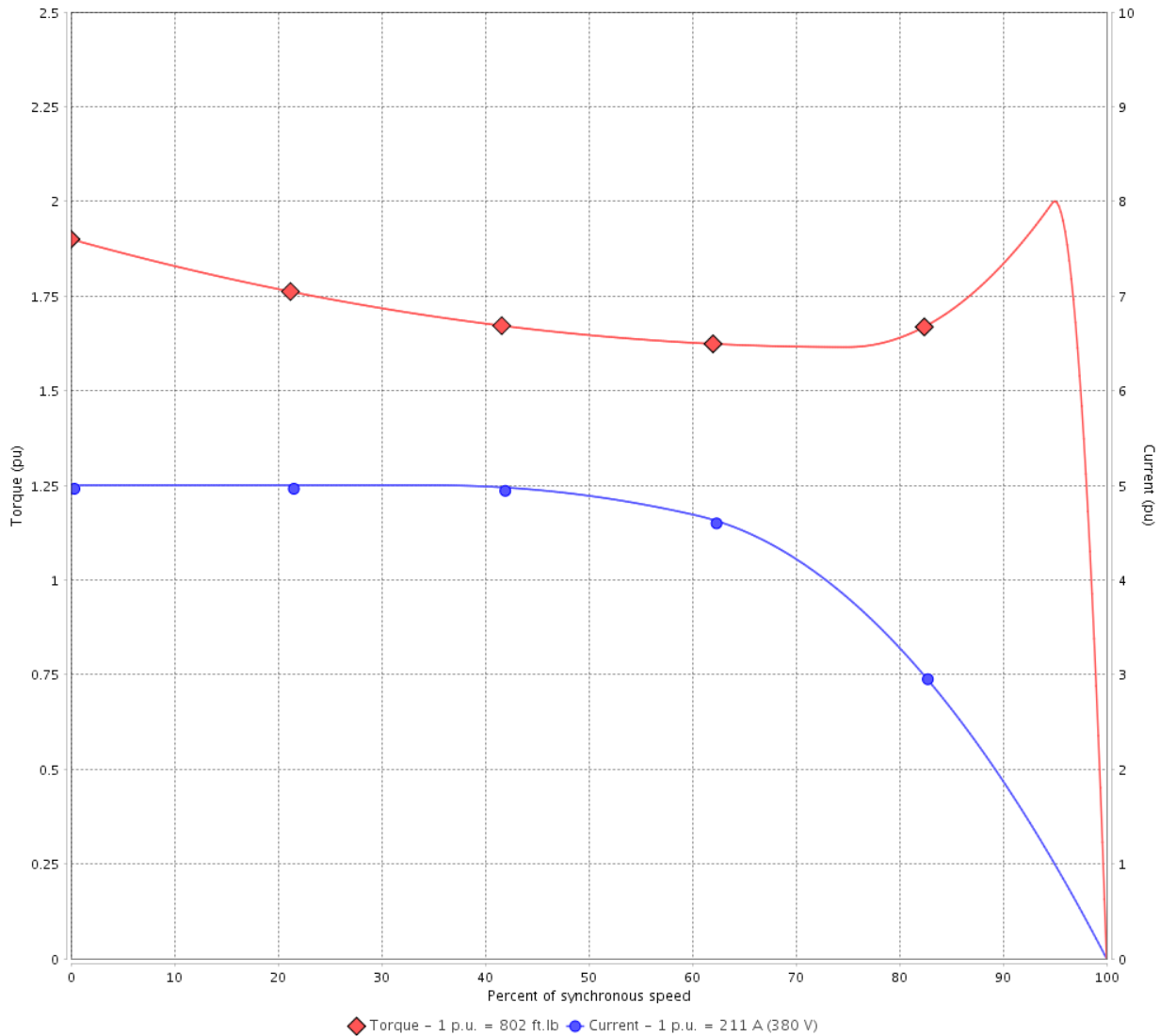

Performance : 380 V 50 Hz 6P IE2

Rated current	: 211 A	Moment of inertia (J)	: 134 sq.ft.lb
LRC	: 5.0	Duty cycle	: Cont.(S1)
Rated torque	: 802 ft.lb	Insulation class	: F
Locked rotor torque	: 190 %	Service factor	: 1.00
Breakdown torque	: 200 %	Temperature rise	: 105 K
Rated speed	: 982 rpm	Design	: B

Locked rotor time : 27s (cold) 15s (hot)

Rev.	Changes Summary	Performed	Checked	Date
Performed by			Page 6 / 36	Revision
Checked by				
Date	13/04/2022			

# TORQUE AND CURRENT VS SPEED CURVE



## Three Phase Induction Motor - Squirrel Cage

Customer :

Product line : NEMA Premium Efficiency Three-Phase

Product code : 11457762

Catalog # : 15012ET3GRB447T-W22

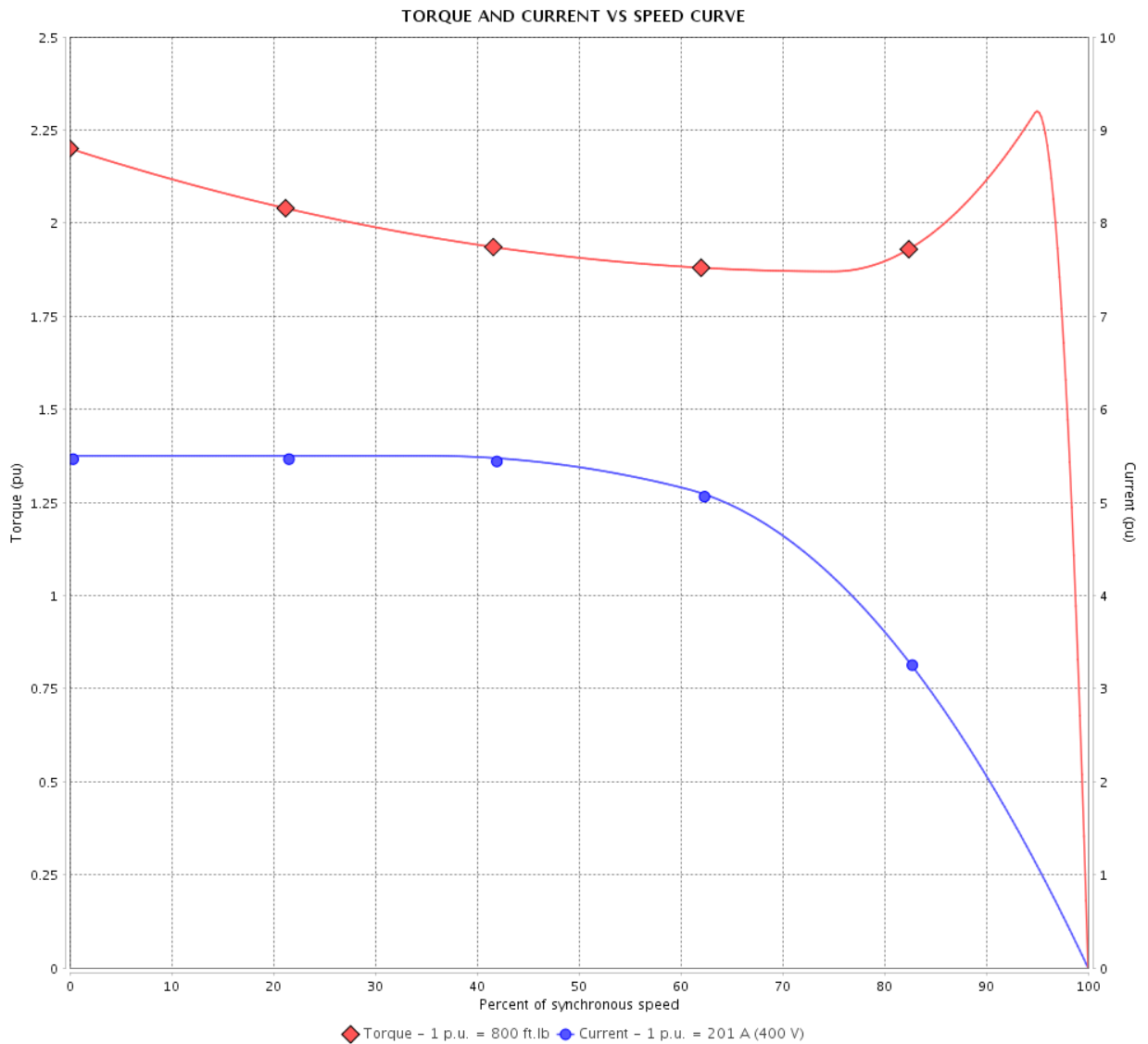

Performance : 400 V 50 Hz 6P IE2

Rated current	: 201 A	Moment of inertia (J)	: 134 sq.ft.lb
LRC	: 5.5	Duty cycle	: Cont.(S1)
Rated torque	: 800 ft.lb	Insulation class	: F
Locked rotor torque	: 220 %	Service factor	: 1.00
Breakdown torque	: 229 %	Temperature rise	: 105 K
Rated speed	: 985 rpm	Design	: B

Locked rotor time : 27s (cold) 15s (hot)

Rev.	Changes Summary	Performed	Checked	Date
Performed by			Page 7 / 36	Revision
Checked by				
Date	13/04/2022			

# TORQUE AND CURRENT VS SPEED CURVE

## Three Phase Induction Motor - Squirrel Cage



Customer :

Product line : NEMA Premium Efficiency Three-Phase

Product code : 11457762

Catalog # : 15012ET3GRB447T-W22

TORQUE AND CURRENT VS SPEED CURVE

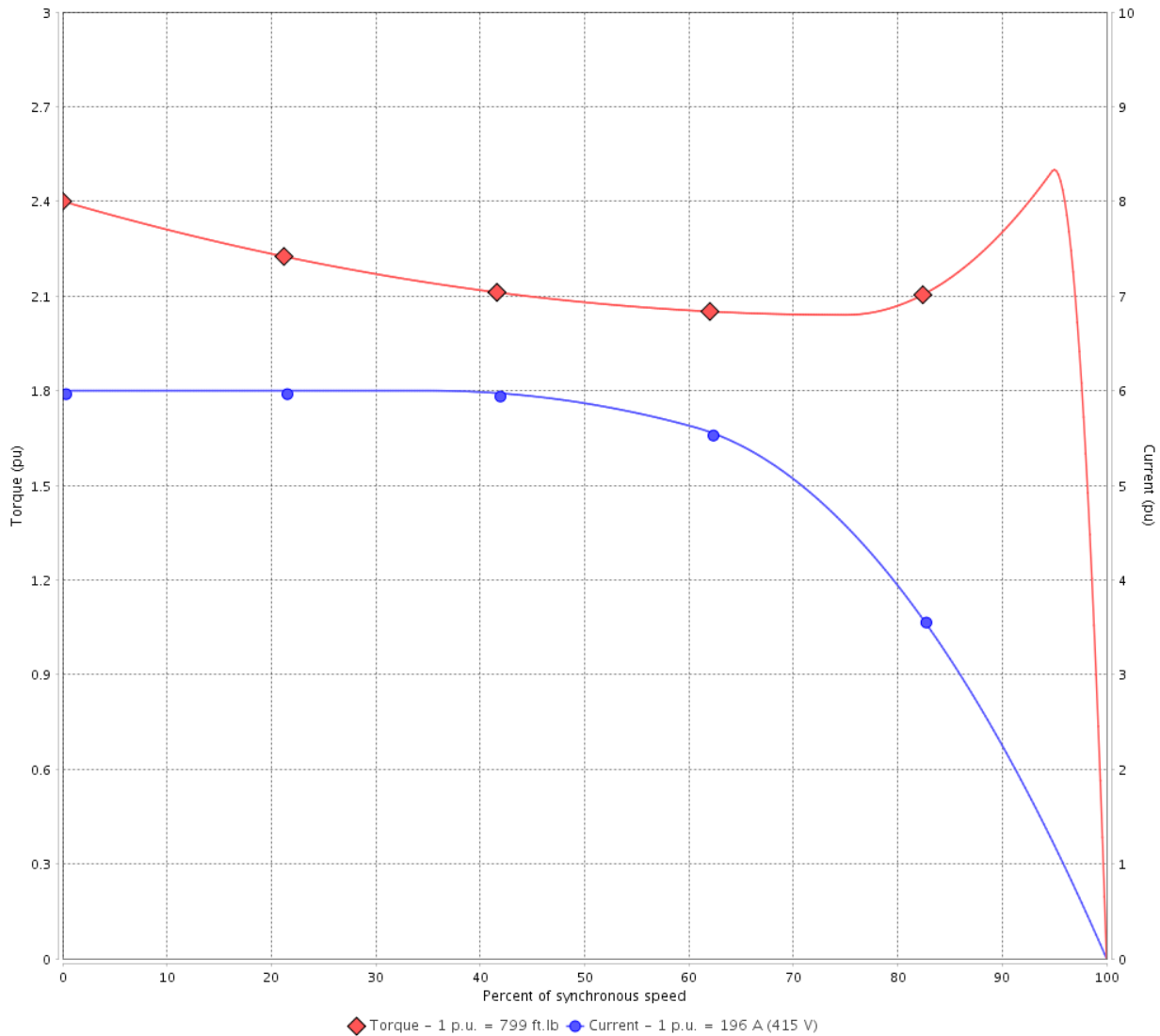

Performance : 415 V 50 Hz 6P IE2

Rated current	: 196 A	Moment of inertia (J)	: 134 sq.ft.lb
LRC	: 6.0	Duty cycle	: Cont.(S1)
Rated torque	: 799 ft.lb	Insulation class	: F
Locked rotor torque	: 240 %	Service factor	: 1.00
Breakdown torque	: 250 %	Temperature rise	: 105 K
Rated speed	: 986 rpm	Design	: B

Locked rotor time : 27s (cold) 15s (hot)

Rev.	Changes Summary	Performed	Checked	Date
Performed by			Page 8 / 36	Revision
Checked by				
Date	13/04/2022			



# LOAD PERFORMANCE CURVE

## Three Phase Induction Motor - Squirrel Cage



Customer :

Product line : NEMA Premium Efficiency Three-Phase

Product code : 11457762

Catalog # : 15012ET3GRB447T-W22

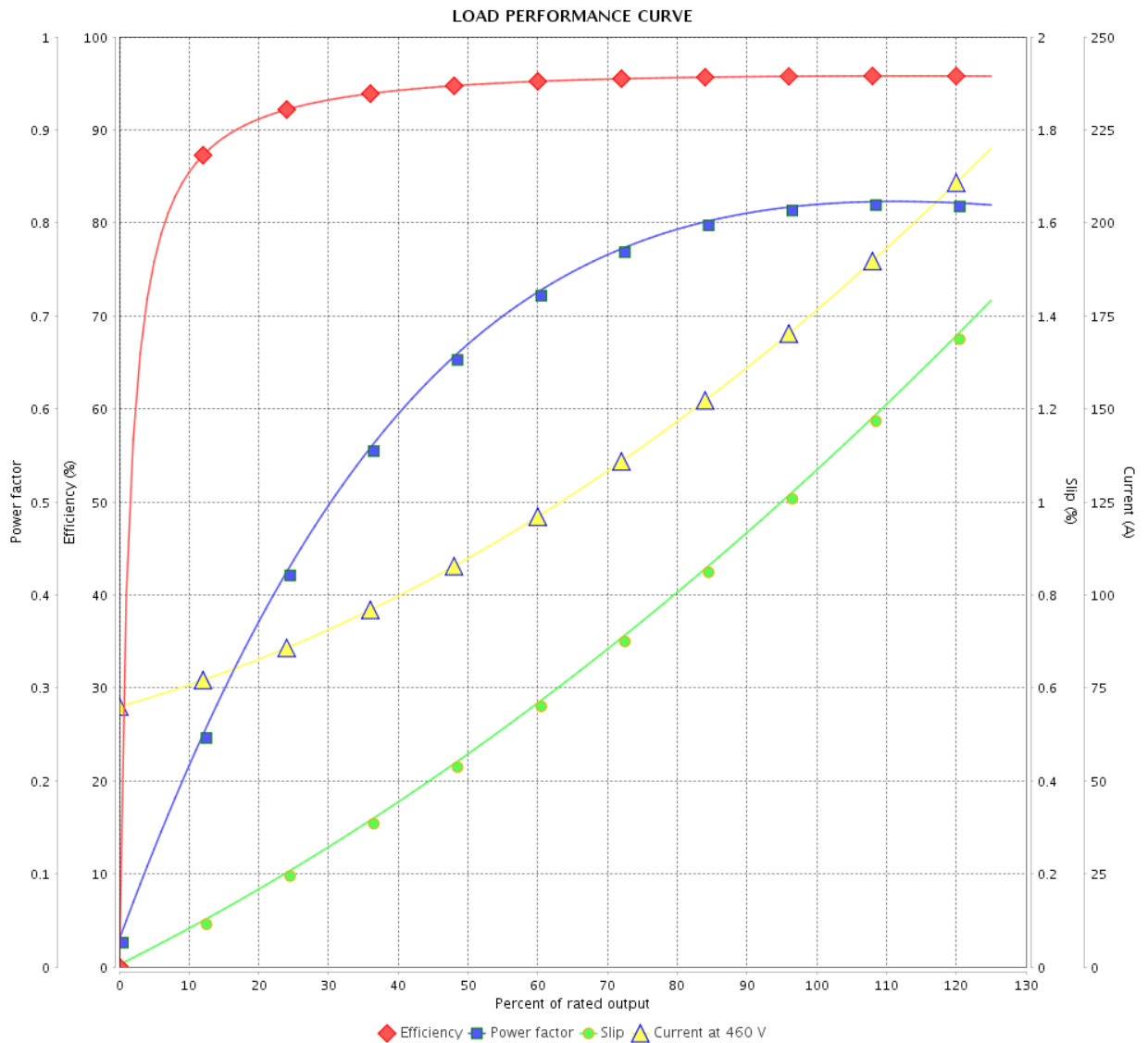

Performance : 460 V 60 Hz 6P

Rated current : 176 A  
 LRC : 6.2  
 Rated torque : 664 ft.lb  
 Locked rotor torque : 240 %  
 Breakdown torque : 250 %  
 Rated speed : 1187 rpm

Moment of inertia (J) : 134 sq.ft.lb  
 Duty cycle : Cont.(S1)  
 Insulation class : F  
 Service factor : 1.15  
 Temperature rise : 80 K  
 Design : B

Rev.	Changes Summary	Performed	Checked	Date
Performed by			Page	Revision
Checked by			9 / 36	
Date	13/04/2022			

# LOAD PERFORMANCE CURVE

Three Phase Induction Motor - Squirrel Cage



Customer :

Product line : NEMA Premium Efficiency Three-Phase

Product code : 11457762

Catalog # : 15012ET3GRB447T-W22

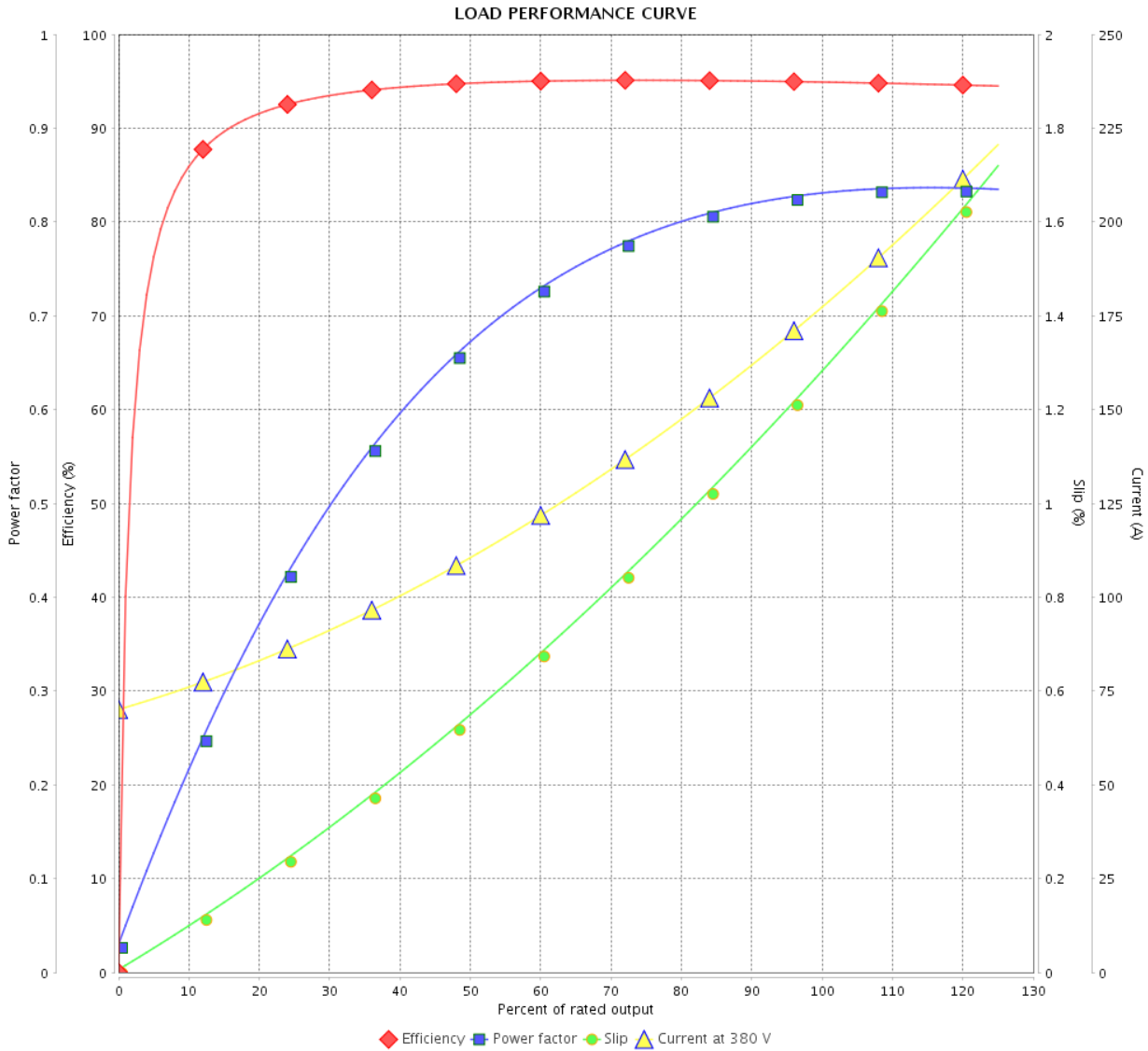

Performance : 380 V 50 Hz 6P IE3

Rated current	: 174 A	Moment of inertia (J)	: 134 sq.ft.lb
LRC	: 6.0	Duty cycle	: Cont.(S1)
Rated torque	: 665 ft.lb	Insulation class	: F
Locked rotor torque	: 240 %	Service factor	: 1.00
Breakdown torque	: 240 %	Temperature rise	: 80 K
Rated speed	: 987 rpm	Design	: B

Rev.	Changes Summary	Performed	Checked	Date
Performed by			Page	Revision
Checked by			10 / 36	
Date	13/04/2022			

# LOAD PERFORMANCE CURVE

## Three Phase Induction Motor - Squirrel Cage



Customer : \_\_\_\_\_

Product line : NEMA Premium Efficiency Three-Phase

Product code : 11457762

Catalog # : 15012ET3GRB447T-W22

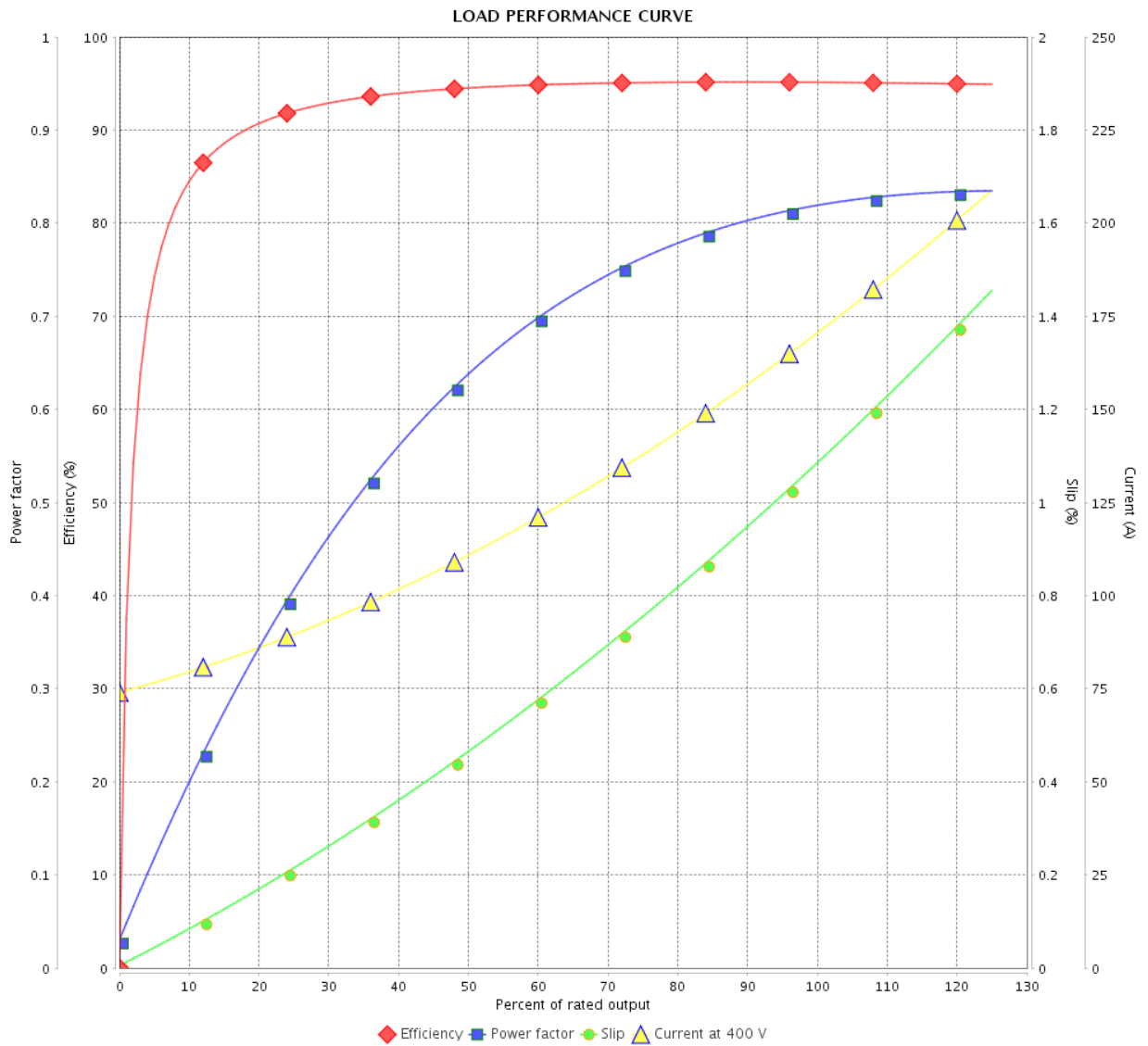

Performance : 400 V 50 Hz 6P IE3

Rated current : 167 A  
 LRC : 6.5  
 Rated torque : 664 ft.lb  
 Locked rotor torque : 270 %  
 Breakdown torque : 270 %  
 Rated speed : 989 rpm

Moment of inertia (J) : 134 sq.ft.lb  
 Duty cycle : Cont.(S1)  
 Insulation class : F  
 Service factor : 1.00  
 Temperature rise : 80 K  
 Design : B

Rev.	Changes Summary	Performed	Checked	Date
Performed by		Page		Revision
Checked by		11 / 36		
Date		13/04/2022		

# LOAD PERFORMANCE CURVE

Three Phase Induction Motor - Squirrel Cage



Customer :

Product line : NEMA Premium Efficiency Three-Phase

Product code : 11457762

Catalog # : 15012ET3GRB447T-W22

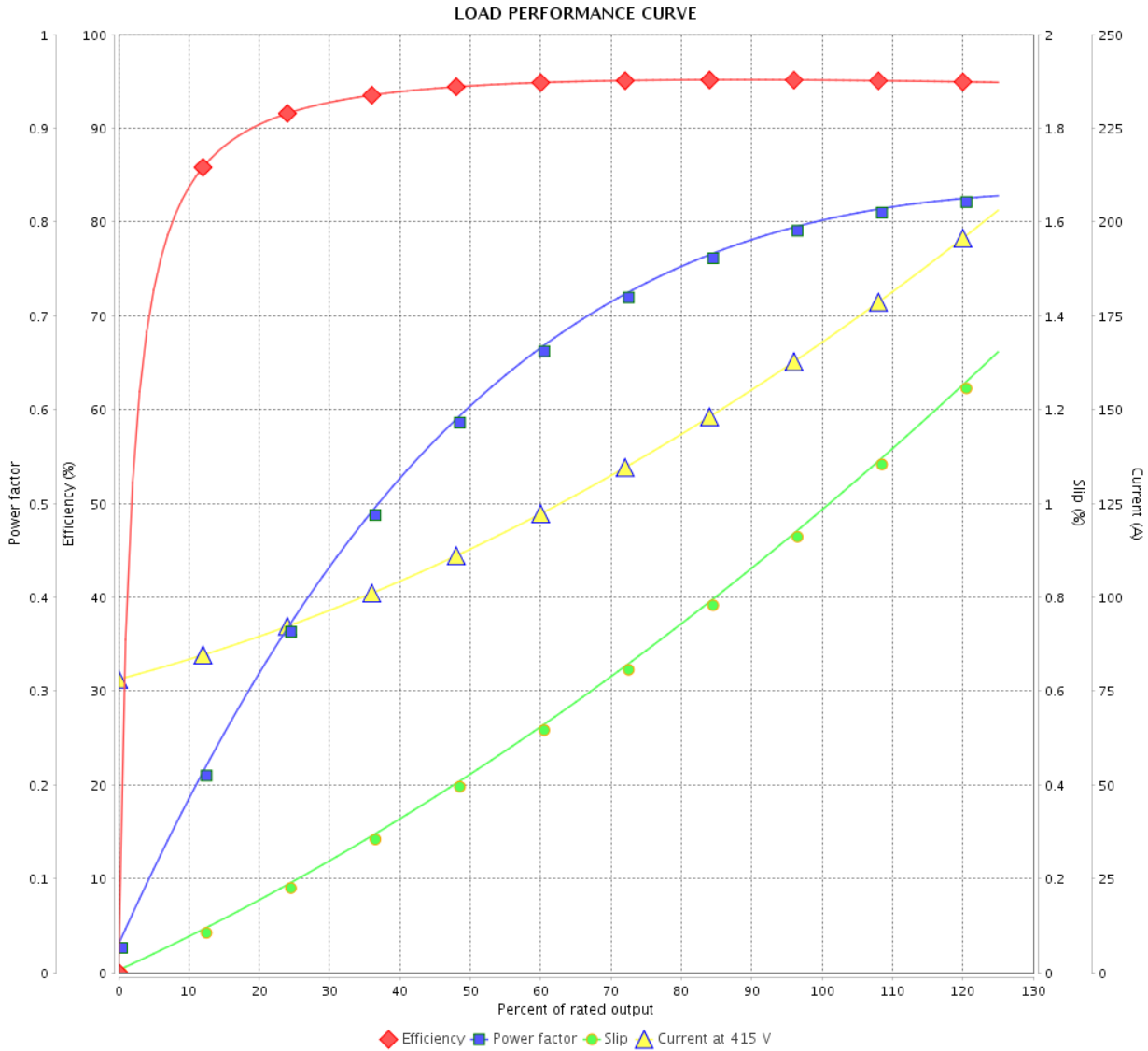

Performance : 415 V 50 Hz 6P IE3

Rated current	: 165 A	Moment of inertia (J)	: 134 sq.ft.lb
LRC	: 7.0	Duty cycle	: Cont.(S1)
Rated torque	: 663 ft.lb	Insulation class	: F
Locked rotor torque	: 290 %	Service factor	: 1.00
Breakdown torque	: 290 %	Temperature rise	: 80 K
Rated speed	: 990 rpm	Design	: B

Rev.	Changes Summary	Performed	Checked	Date
Performed by			Page 12 / 36	Revision
Checked by				
Date	13/04/2022			

# LOAD PERFORMANCE CURVE

## Three Phase Induction Motor - Squirrel Cage



Customer : \_\_\_\_\_

Product line : NEMA Premium Efficiency Three-Phase

Product code : 11457762

Catalog # : 15012ET3GRB447T-W22

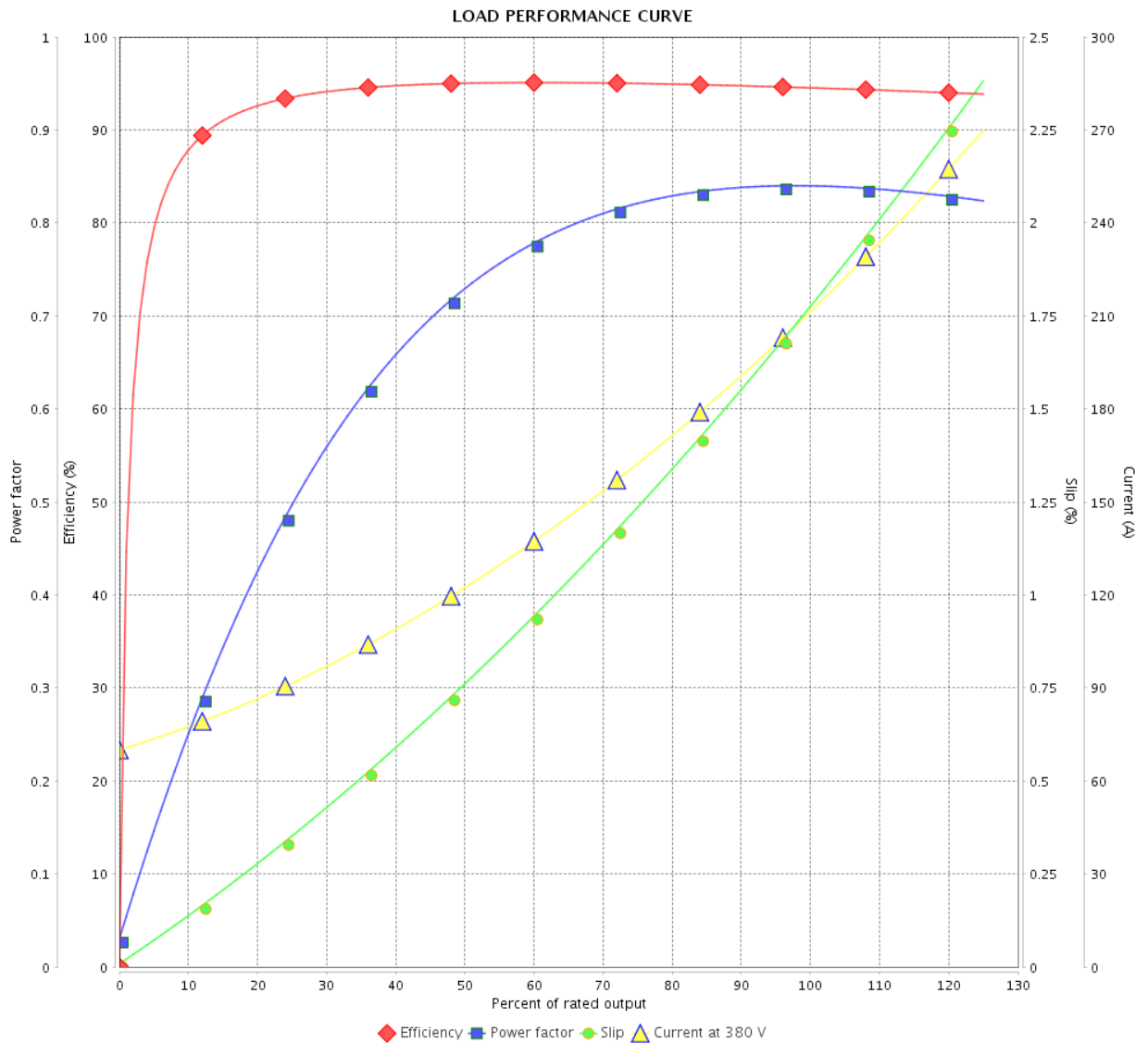

Performance : 380 V 50 Hz 6P IE2

Rated current : 211 A  
 LRC : 5.0  
 Rated torque : 802 ft.lb  
 Locked rotor torque : 190 %  
 Breakdown torque : 200 %  
 Rated speed : 982 rpm

Moment of inertia (J) : 134 sq.ft.lb  
 Duty cycle : Cont.(S1)  
 Insulation class : F  
 Service factor : 1.00  
 Temperature rise : 105 K  
 Design : B

Rev.	Changes Summary	Performed	Checked	Date
Performed by			Page	Revision
Checked by			13 / 36	
Date	13/04/2022			

# LOAD PERFORMANCE CURVE

Three Phase Induction Motor - Squirrel Cage



Customer : \_\_\_\_\_

Product line : NEMA Premium Efficiency Three-Phase

Product code : 11457762

Catalog # : 15012ET3GRB447T-W22

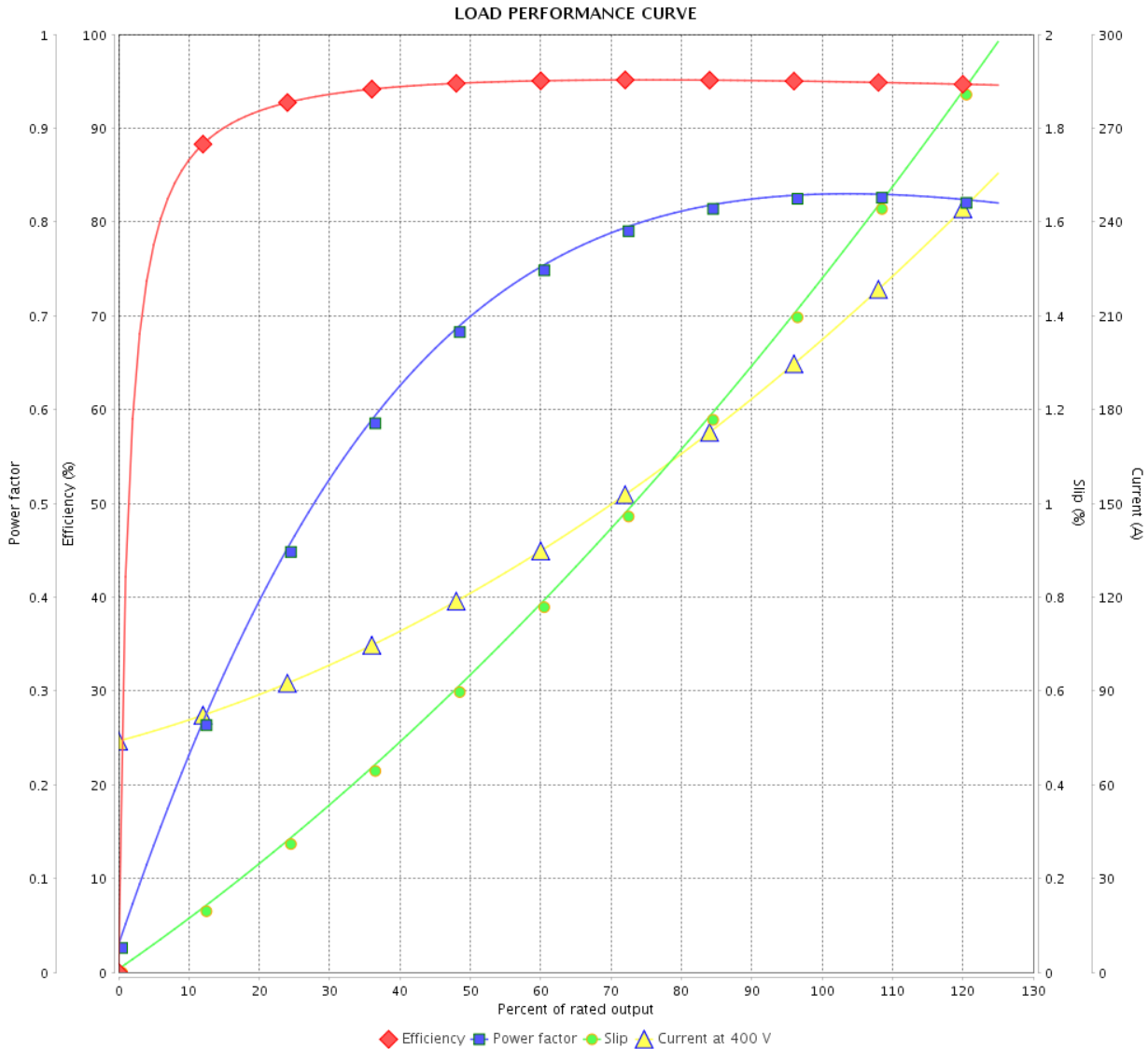

Performance : 400 V 50 Hz 6P IE2

Rated current : 201 A	Moment of inertia (J) : 134 sq.ft.lb
LRC : 5.5	Duty cycle : Cont.(S1)
Rated torque : 800 ft.lb	Insulation class : F
Locked rotor torque : 220 %	Service factor : 1.00
Breakdown torque : 229 %	Temperature rise : 105 K
Rated speed : 985 rpm	Design : B

Rev.	Changes Summary	Performed	Checked	Date
Performed by			Page 14 / 36	Revision
Checked by				
Date	13/04/2022			

# LOAD PERFORMANCE CURVE

## Three Phase Induction Motor - Squirrel Cage



Customer :

Product line : NEMA Premium Efficiency Three-Phase

Product code : 11457762

Catalog # : 15012ET3GRB447T-W22

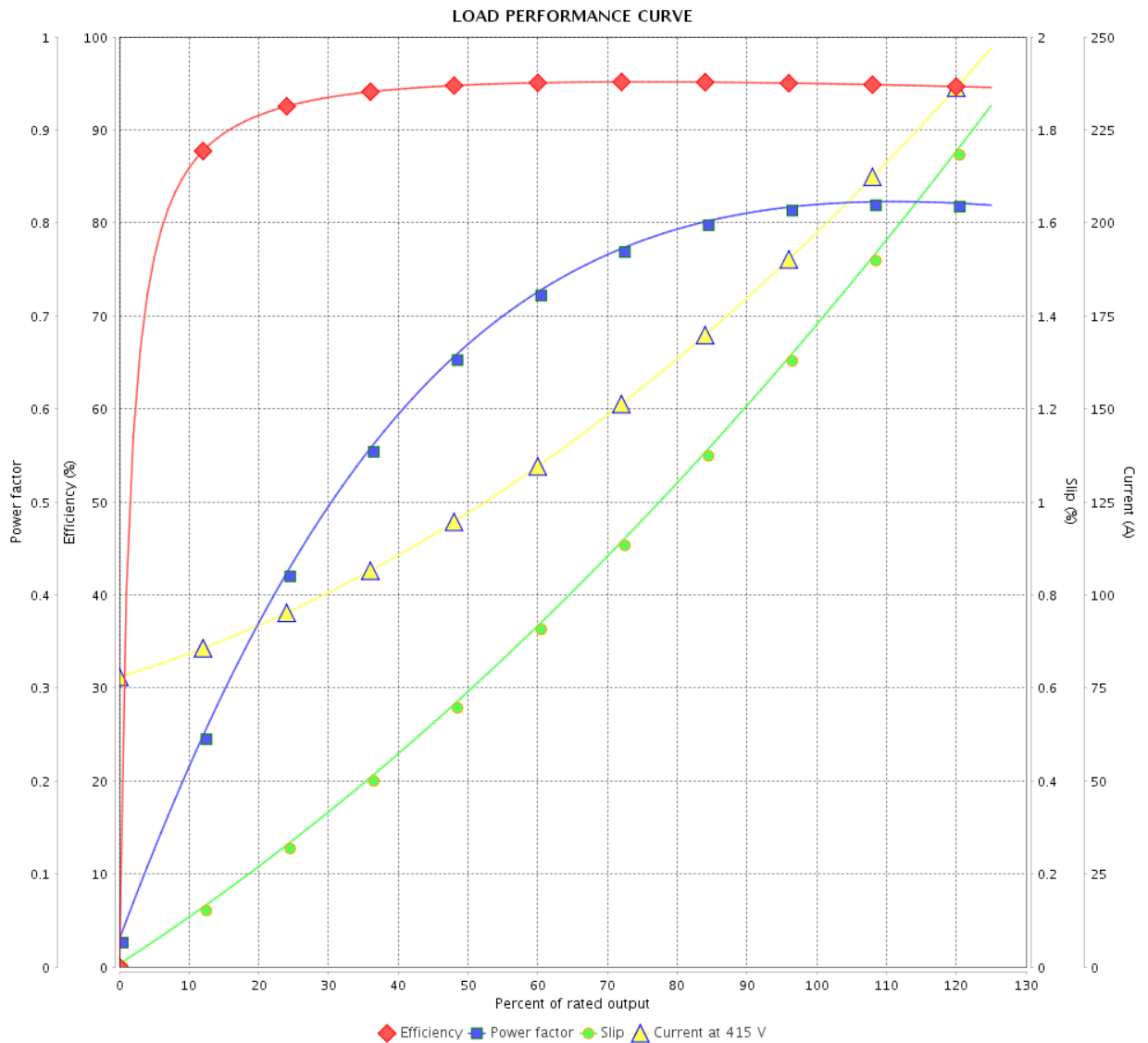

Performance : 415 V 50 Hz 6P IE2

Rated current : 196 A  
 LRC : 6.0  
 Rated torque : 799 ft.lb  
 Locked rotor torque : 240 %  
 Breakdown torque : 250 %  
 Rated speed : 986 rpm

Moment of inertia (J) : 134 sq.ft.lb  
 Duty cycle : Cont.(S1)  
 Insulation class : F  
 Service factor : 1.00  
 Temperature rise : 105 K  
 Design : B

Rev.	Changes Summary	Performed	Checked	Date
Performed by		Page		Revision
Checked by		15 / 36		
Date		13/04/2022		

# THERMAL LIMIT CURVE

## Three Phase Induction Motor - Squirrel Cage



Customer :

Product line : NEMA Premium Efficiency Three-Phase  
Product code : 11457762  
Catalog # : 15012ET3GRB447T-W22

Performance : 460 V 60 Hz 6P

Rated current	: 176 A	Moment of inertia (J)	: 134 sq.ft.lb
LRC	: 6.2	Duty cycle	: Cont.(S1)
Rated torque	: 664 ft.lb	Insulation class	: F
Locked rotor torque	: 240 %	Service factor	: 1.15
Breakdown torque	: 250 %	Temperature rise	: 80 K
Rated speed	: 1187 rpm	Design	: B

Heating constant

Cooling constant

Rev.	Changes Summary	Performed	Checked	Date
Performed by				
Checked by			Page	Revision
Date	13/04/2022		16 / 36	



# THERMAL LIMIT CURVE

Three Phase Induction Motor - Squirrel Cage



Customer : \_\_\_\_\_

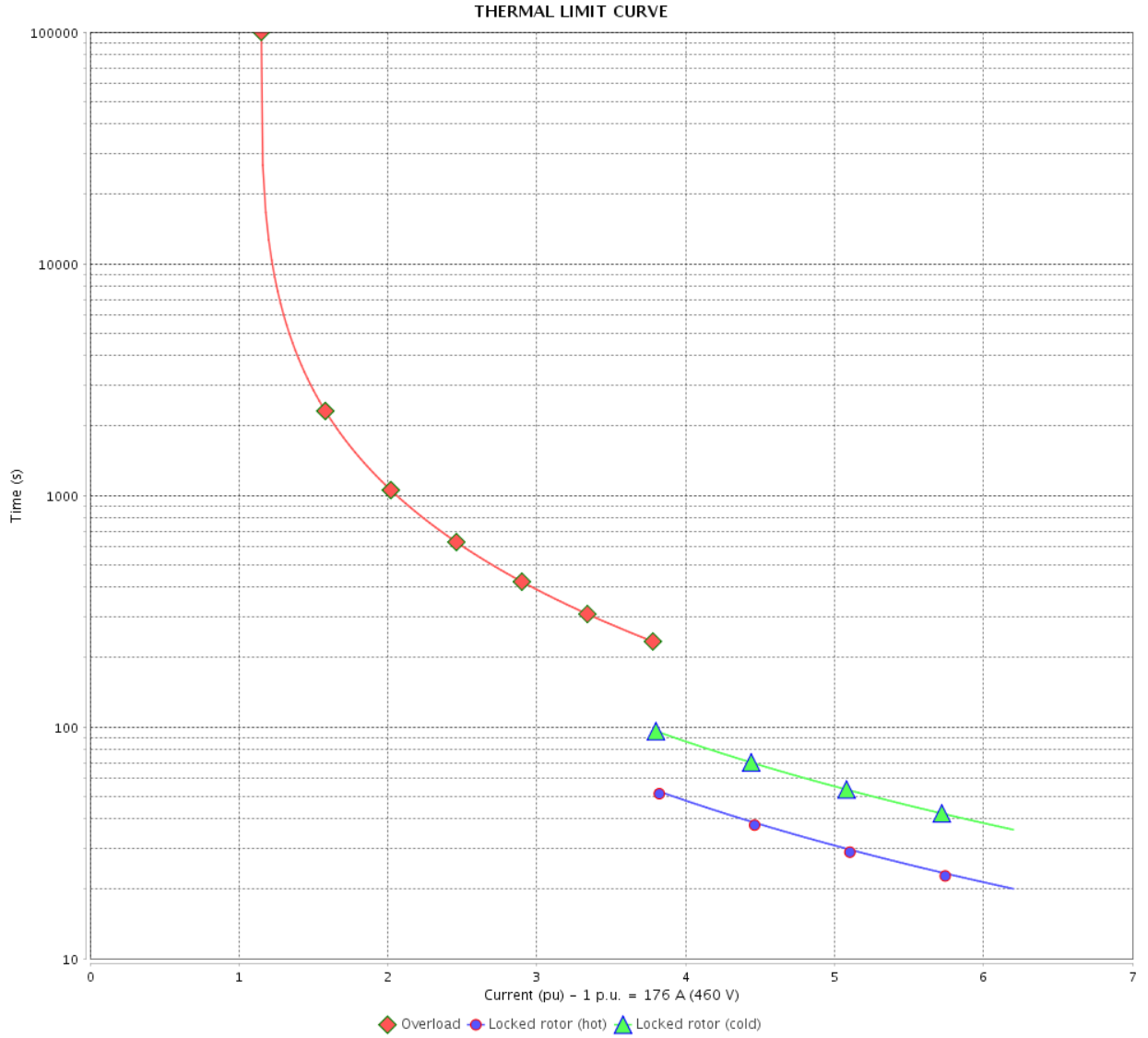

Rev.	Changes Summary	Performed	Checked	Date
Performed by		Page 17 / 36		Revision
Checked by				
Date				

# THERMAL LIMIT CURVE



## Three Phase Induction Motor - Squirrel Cage

Customer :

Product line : NEMA Premium Efficiency Three-Phase  
Product code : 11457762  
Catalog # : 15012ET3GRB447T-W22

Performance : 380 V 50 Hz 6P IE3

Rated current	: 174 A	Moment of inertia (J)	: 134 sq.ft.lb
LRC	: 6.0	Duty cycle	: Cont.(S1)
Rated torque	: 665 ft.lb	Insulation class	: F
Locked rotor torque	: 240 %	Service factor	: 1.00
Breakdown torque	: 240 %	Temperature rise	: 80 K
Rated speed	: 987 rpm	Design	: B

Heating constant

Cooling constant

Rev.	Changes Summary	Performed	Checked	Date
Performed by				
Checked by			Page	Revision
Date	13/04/2022		18 / 36	

# THERMAL LIMIT CURVE

Three Phase Induction Motor - Squirrel Cage



Customer : \_\_\_\_\_

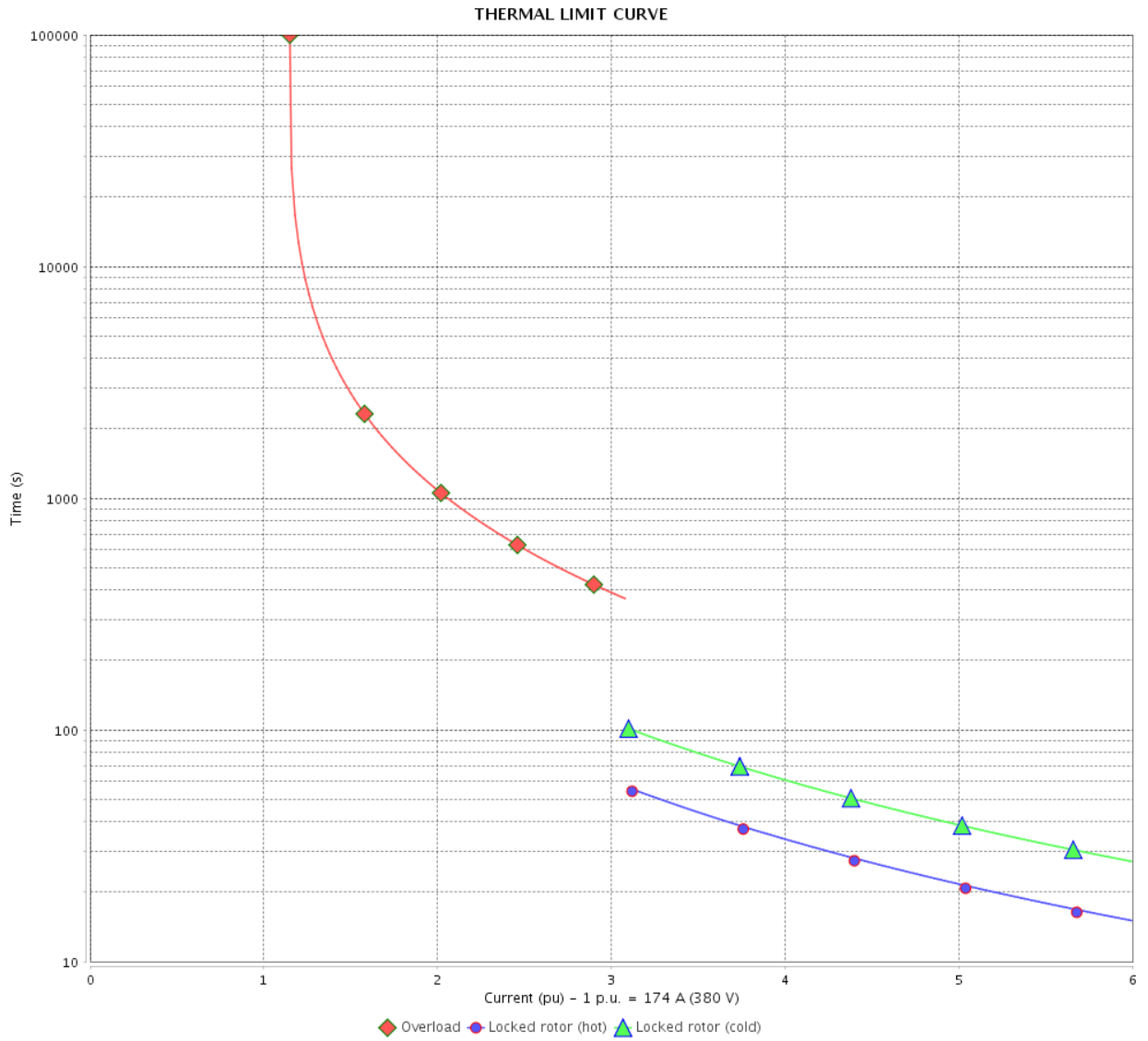

Rev.	Changes Summary	Performed	Checked	Date
Performed by				
Checked by				
Date				
			Page	Revision
			19 / 36	

# THERMAL LIMIT CURVE

## Three Phase Induction Motor - Squirrel Cage



Customer :

Product line : NEMA Premium Efficiency Three-Phase  
Product code : 11457762  
Catalog # : 15012ET3GRB447T-W22

Performance : 400 V 50 Hz 6P IE3

Rated current	: 167 A	Moment of inertia (J)	: 134 sq.ft.lb
LRC	: 6.5	Duty cycle	: Cont.(S1)
Rated torque	: 664 ft.lb	Insulation class	: F
Locked rotor torque	: 270 %	Service factor	: 1.00
Breakdown torque	: 270 %	Temperature rise	: 80 K
Rated speed	: 989 rpm	Design	: B

Heating constant

Cooling constant

Rev.	Changes Summary	Performed	Checked	Date
Performed by				
Checked by			Page	Revision
Date	13/04/2022		20 / 36	

# THERMAL LIMIT CURVE

Three Phase Induction Motor - Squirrel Cage



Customer : \_\_\_\_\_

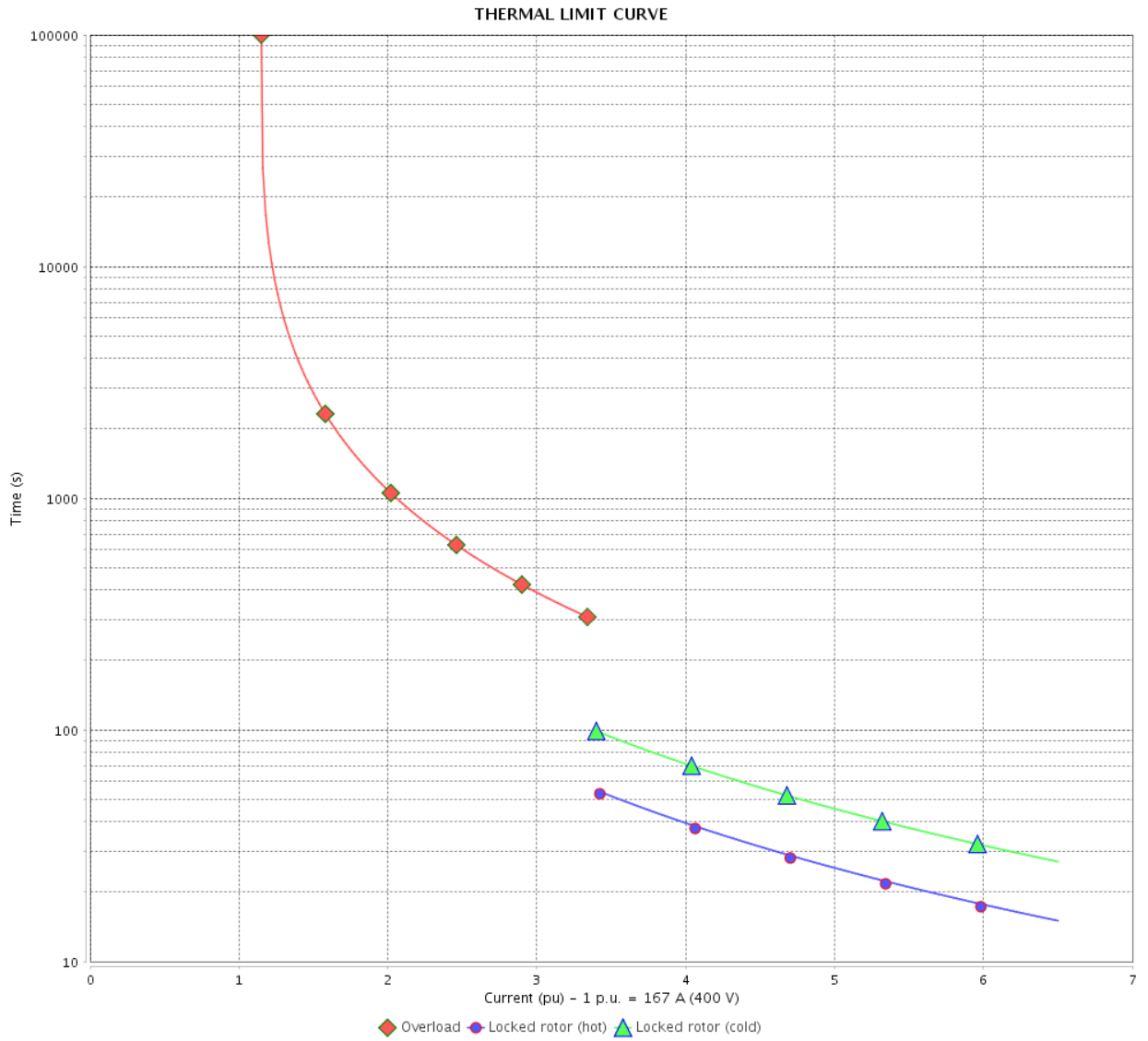

Rev.	Changes Summary	Performed	Checked	Date
Performed by		Page		Revision
Checked by		21 / 36		
Date		13/04/2022		

# THERMAL LIMIT CURVE



## Three Phase Induction Motor - Squirrel Cage

Customer :

Product line : NEMA Premium Efficiency Three-Phase  
Product code : 11457762  
Catalog # : 15012ET3GRB447T-W22

Performance : 415 V 50 Hz 6P IE3

Rated current	: 165 A	Moment of inertia (J)	: 134 sq.ft.lb
LRC	: 7.0	Duty cycle	: Cont.(S1)
Rated torque	: 663 ft.lb	Insulation class	: F
Locked rotor torque	: 290 %	Service factor	: 1.00
Breakdown torque	: 290 %	Temperature rise	: 80 K
Rated speed	: 990 rpm	Design	: B

Heating constant

Cooling constant

Rev.	Changes Summary	Performed	Checked	Date
Performed by				
Checked by			Page	Revision
Date	13/04/2022		22 / 36	

# THERMAL LIMIT CURVE

Three Phase Induction Motor - Squirrel Cage



Customer : \_\_\_\_\_

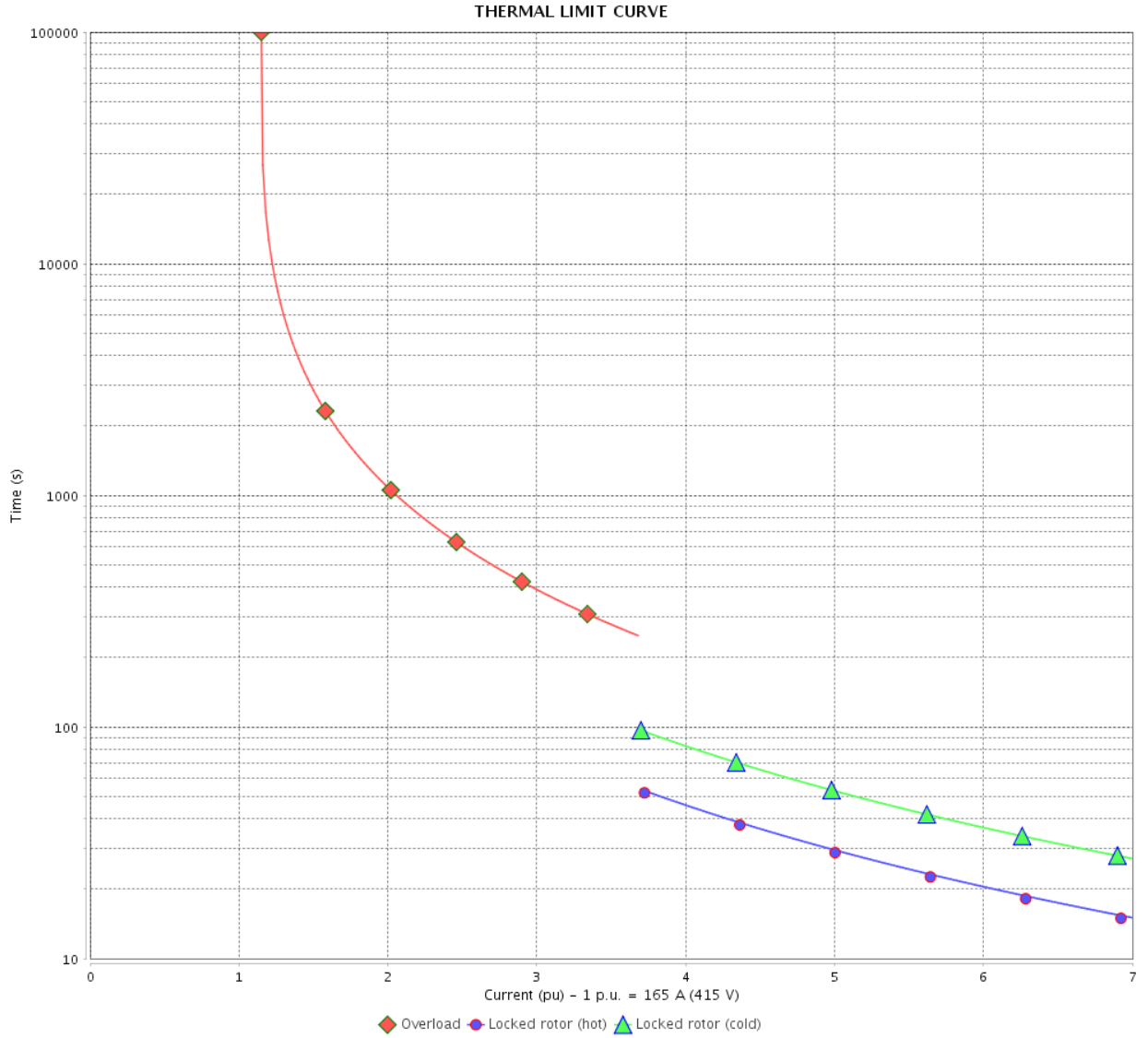

Rev.	Changes Summary	Performed	Checked	Date
Performed by		Page 23 / 36		Revision
Checked by				
Date				

# THERMAL LIMIT CURVE



## Three Phase Induction Motor - Squirrel Cage

Customer :

Product line : NEMA Premium Efficiency Three-Phase  
Product code : 11457762  
Catalog # : 15012ET3GRB447T-W22

Performance : 380 V 50 Hz 6P IE2

Rated current	: 211 A	Moment of inertia (J)	: 134 sq.ft.lb
LRC	: 5.0	Duty cycle	: Cont.(S1)
Rated torque	: 802 ft.lb	Insulation class	: F
Locked rotor torque	: 190 %	Service factor	: 1.00
Breakdown torque	: 200 %	Temperature rise	: 105 K
Rated speed	: 982 rpm	Design	: B

Heating constant

Cooling constant

Rev.	Changes Summary	Performed	Checked	Date
Performed by				
Checked by			Page	Revision
Date	13/04/2022		24 / 36	



# THERMAL LIMIT CURVE

Three Phase Induction Motor - Squirrel Cage



Customer : \_\_\_\_\_

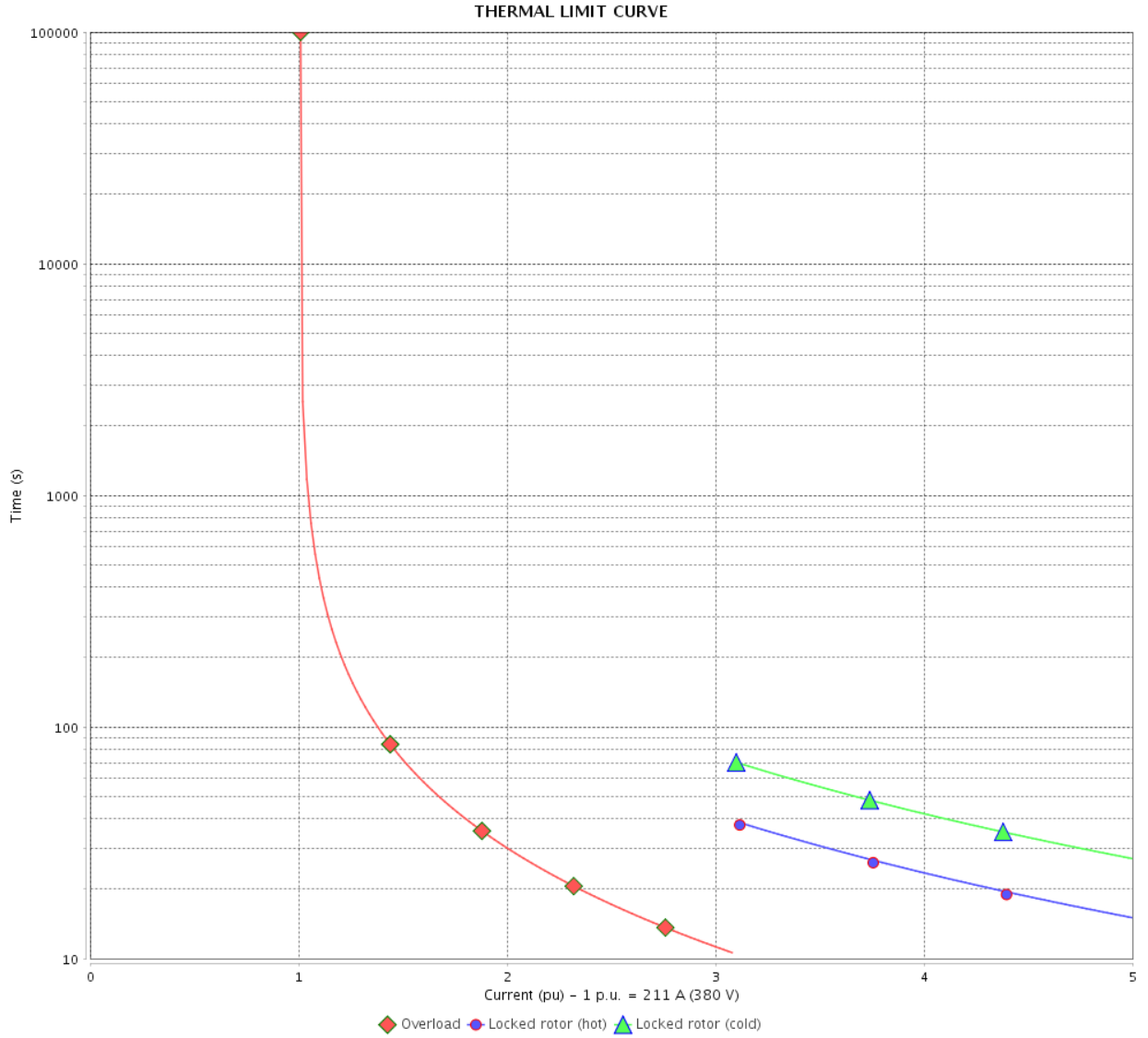

Rev.	Changes Summary	Performed	Checked	Date
Performed by				
Checked by				
Date				
			Page	Revision
			25 / 36	

# THERMAL LIMIT CURVE

## Three Phase Induction Motor - Squirrel Cage



Customer :

Product line : NEMA Premium Efficiency Three-Phase  
Product code : 11457762  
Catalog # : 15012ET3GRB447T-W22

Performance : 400 V 50 Hz 6P IE2

Rated current	: 201 A	Moment of inertia (J)	: 134 sq.ft.lb
LRC	: 5.5	Duty cycle	: Cont.(S1)
Rated torque	: 800 ft.lb	Insulation class	: F
Locked rotor torque	: 220 %	Service factor	: 1.00
Breakdown torque	: 229 %	Temperature rise	: 105 K
Rated speed	: 985 rpm	Design	: B

Heating constant

Cooling constant

Rev.	Changes Summary	Performed	Checked	Date
Performed by				
Checked by			Page	Revision
Date	13/04/2022		26 / 36	

# THERMAL LIMIT CURVE

Three Phase Induction Motor - Squirrel Cage



Customer : \_\_\_\_\_

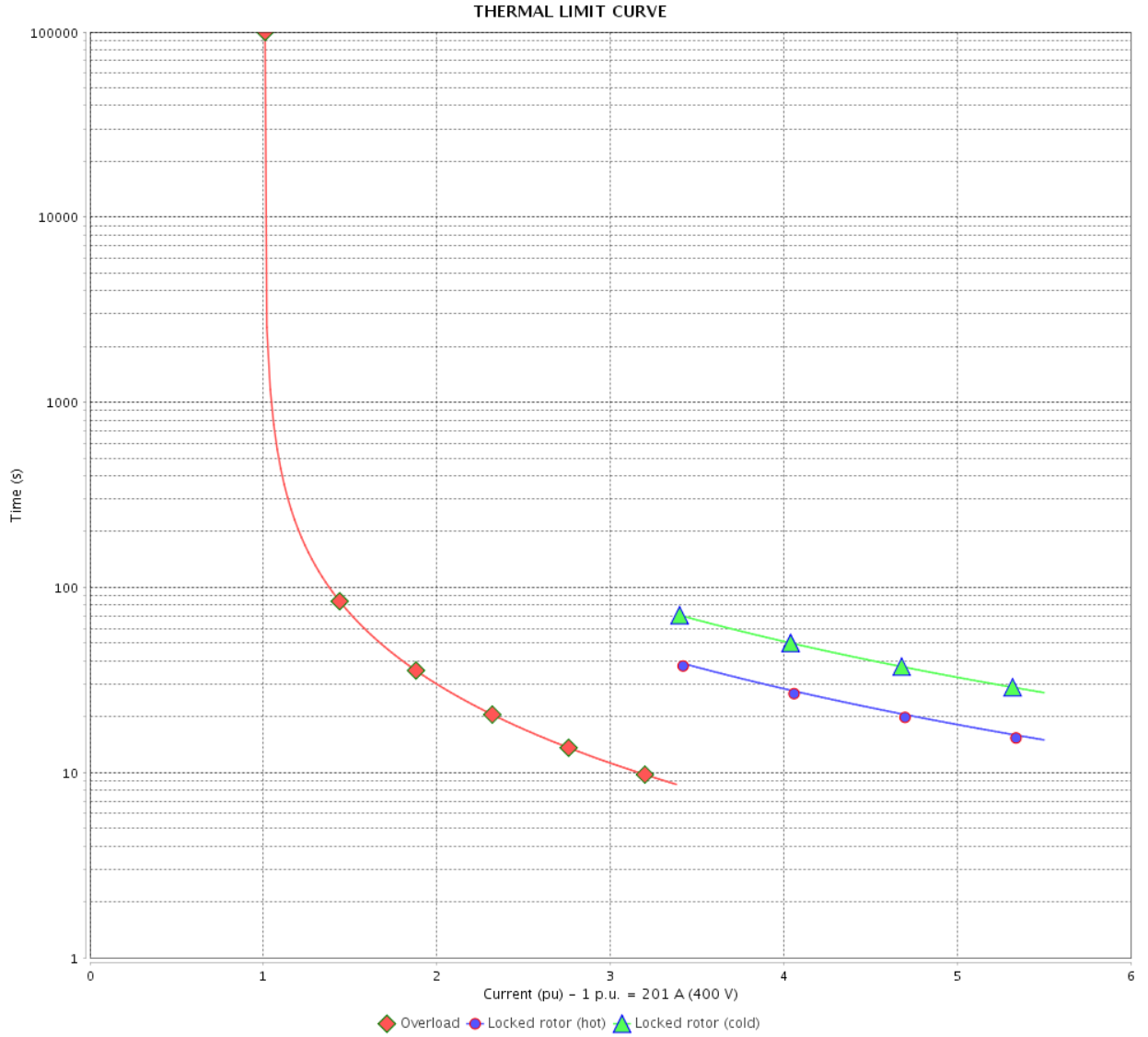

Rev.	Changes Summary	Performed	Checked	Date
Performed by		Page		Revision
Checked by		27 / 36		
Date	13/04/2022			

# THERMAL LIMIT CURVE



## Three Phase Induction Motor - Squirrel Cage

Customer :

Product line : NEMA Premium Efficiency Three-Phase  
Product code : 11457762  
Catalog # : 15012ET3GRB447T-W22

Performance : 415 V 50 Hz 6P IE2

Rated current	: 196 A	Moment of inertia (J)	: 134 sq.ft.lb
LRC	: 6.0	Duty cycle	: Cont.(S1)
Rated torque	: 799 ft.lb	Insulation class	: F
Locked rotor torque	: 240 %	Service factor	: 1.00
Breakdown torque	: 250 %	Temperature rise	: 105 K
Rated speed	: 986 rpm	Design	: B

Heating constant

Cooling constant

Rev.	Changes Summary	Performed	Checked	Date
Performed by				
Checked by			Page	Revision
Date	13/04/2022		28 / 36	

# THERMAL LIMIT CURVE

Three Phase Induction Motor - Squirrel Cage



Customer : \_\_\_\_\_

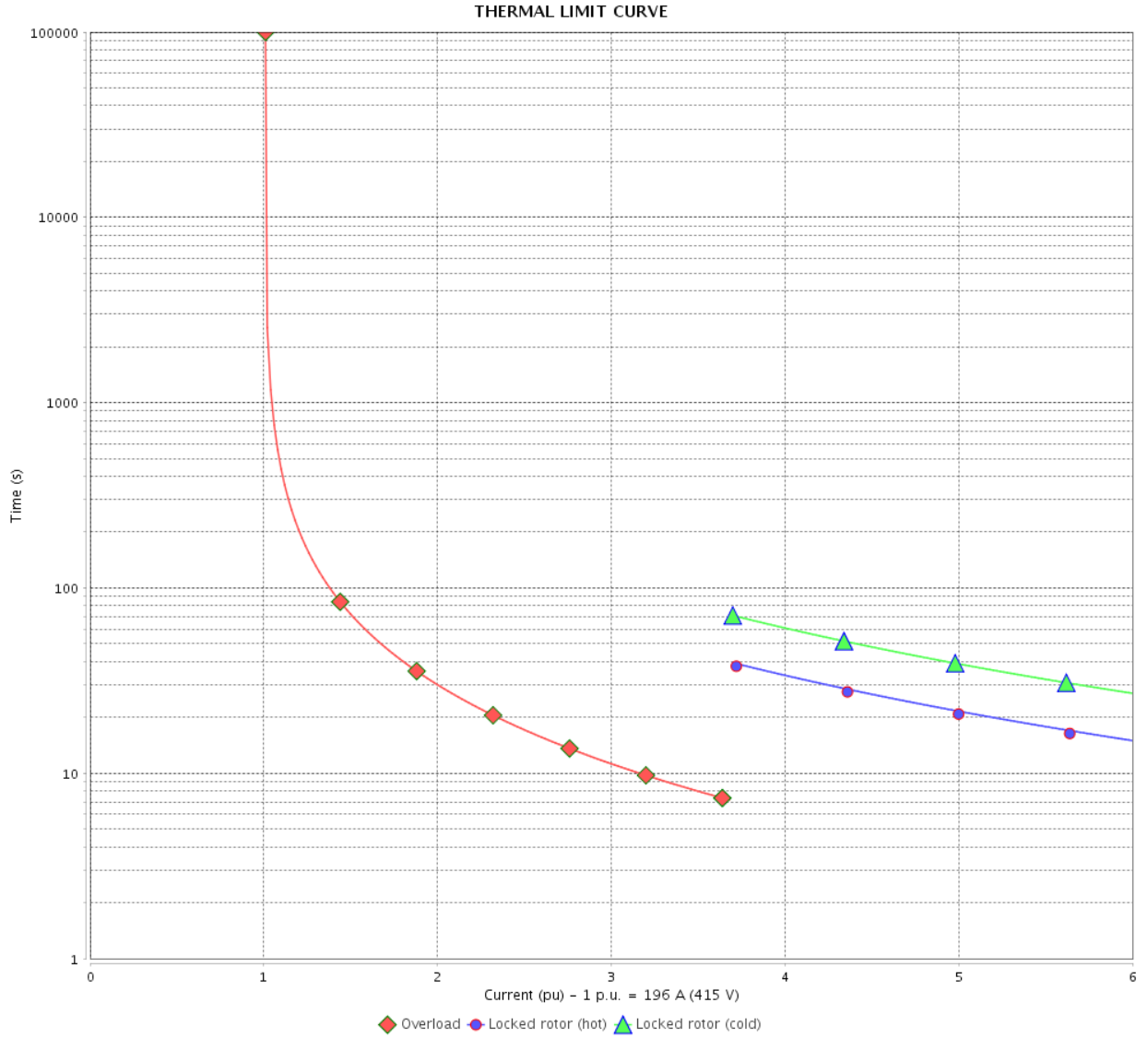

Rev.	Changes Summary	Performed	Checked	Date
Performed by		Page		Revision
Checked by		29 / 36		
Date		13/04/2022		

# VFD OPERATION CURVE

Three Phase Induction Motor - Squirrel Cage



Customer :

Product line : NEMA Premium Efficiency Three-Phase

Product code : 11457762

Catalog # : 15012ET3GRB447T-W22

VFD OPERATION CURVE

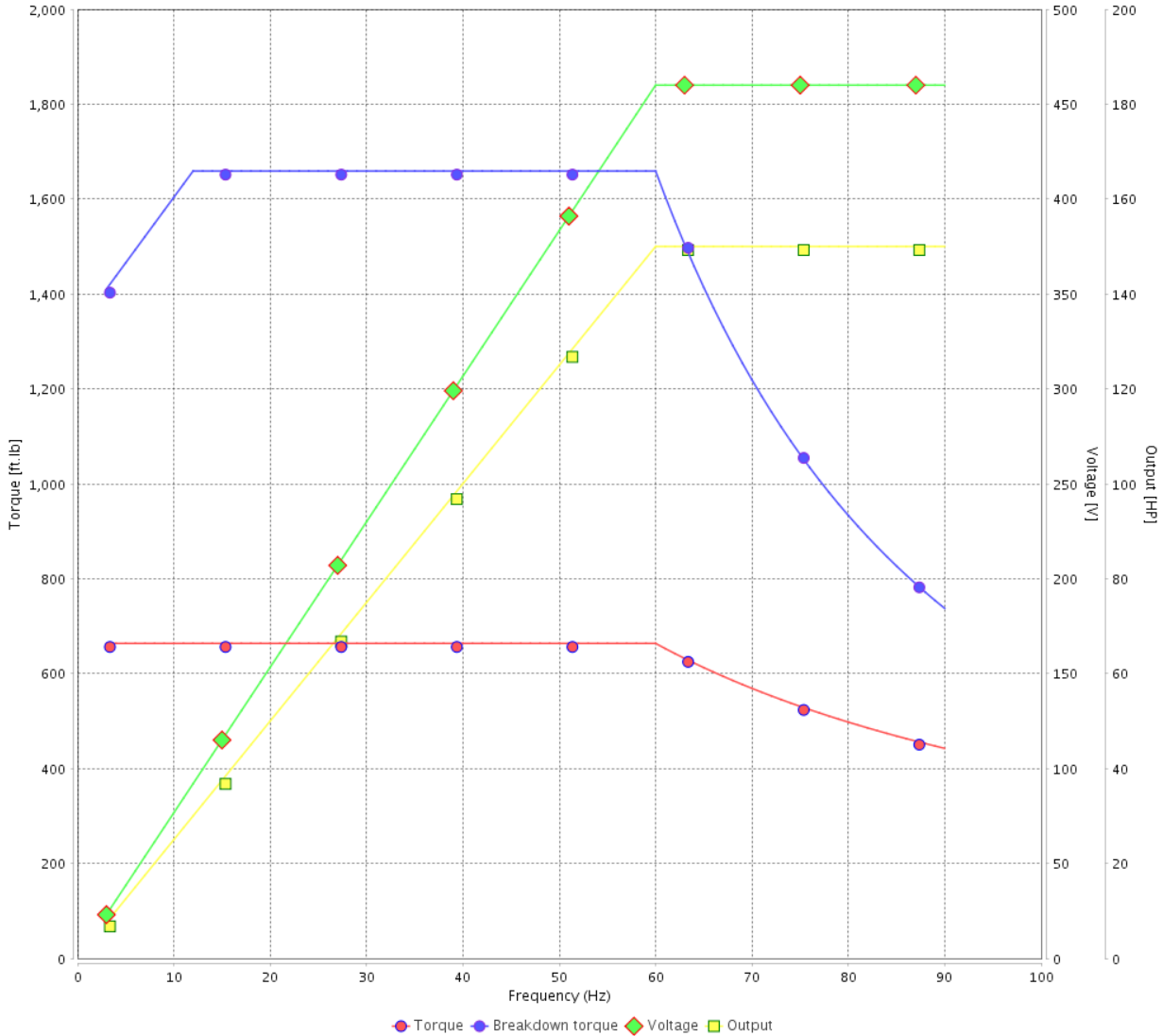

Performance : 460 V 60 Hz 6P

Rated current : 176 A  
 LRC : 6.2  
 Rated torque : 664 ft.lb  
 Locked rotor torque : 240 %  
 Breakdown torque : 250 %  
 Rated speed : 1187 rpm

Moment of inertia (J) : 134 sq.ft.lb  
 Duty cycle : Cont.(S1)  
 Insulation class : F  
 Service factor : 1.15  
 Temperature rise : 80 K  
 Design : B

Rev.	Changes Summary	Performed	Checked	Date
Performed by			Page	Revision
Checked by				
Date				
			30 / 36	

# VFD OPERATION CURVE

Three Phase Induction Motor - Squirrel Cage



Customer :

Product line : NEMA Premium Efficiency Three-Phase

Product code : 11457762

Catalog # : 15012ET3GRB447T-W22

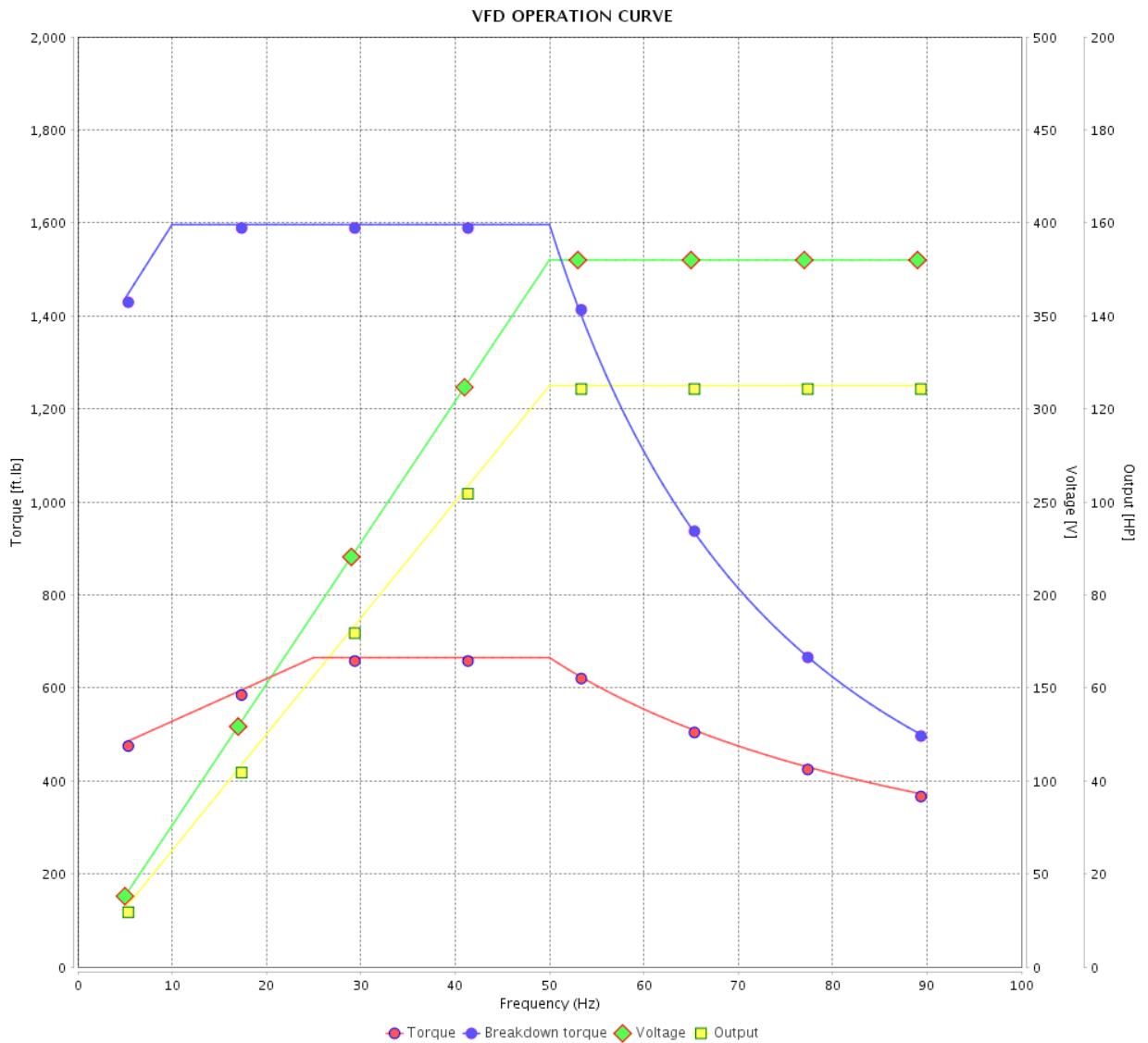

Performance : 380 V 50 Hz 6P IE3

Rated current : 174 A  
 LRC : 6.0  
 Rated torque : 665 ft.lb  
 Locked rotor torque : 240 %  
 Breakdown torque : 240 %  
 Rated speed : 987 rpm

Moment of inertia (J) : 134 sq.ft.lb  
 Duty cycle : Cont.(S1)  
 Insulation class : F  
 Service factor : 1.00  
 Temperature rise : 80 K  
 Design : B

Rev.	Changes Summary	Performed	Checked	Date
Performed by				Page 31 / 36
Checked by				
Date	13/04/2022			

# VFD OPERATION CURVE

Three Phase Induction Motor - Squirrel Cage



Customer :

Product line : NEMA Premium Efficiency Three-Phase

Product code : 11457762

Catalog # : 15012ET3GRB447T-W22

VFD OPERATION CURVE

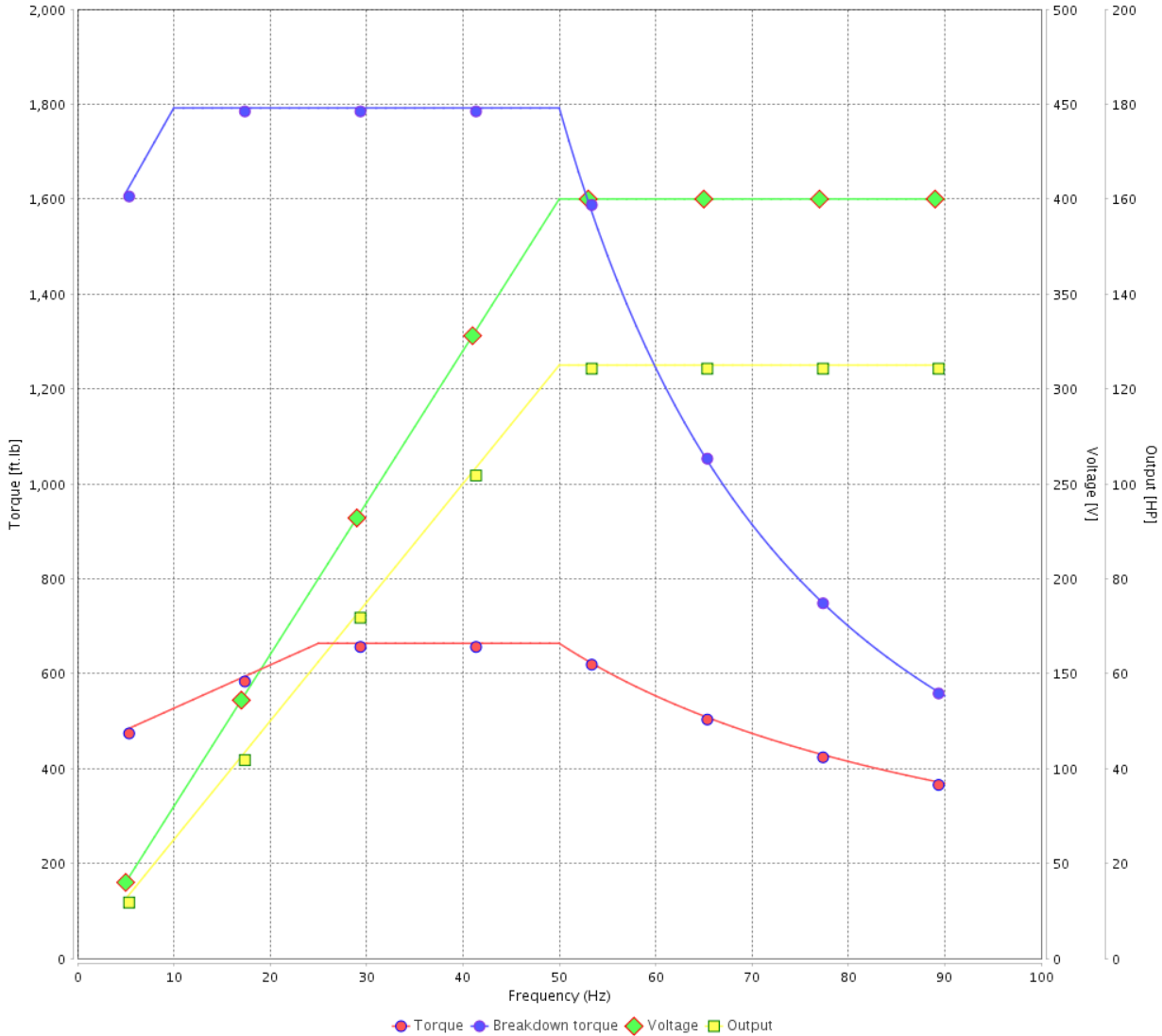

Performance : 400 V 50 Hz 6P IE3

Rated current	: 167 A	Moment of inertia (J)	: 134 sq.ft.lb
LRC	: 6.5	Duty cycle	: Cont.(S1)
Rated torque	: 664 ft.lb	Insulation class	: F
Locked rotor torque	: 270 %	Service factor	: 1.00
Breakdown torque	: 270 %	Temperature rise	: 80 K
Rated speed	: 989 rpm	Design	: B

Rev.	Changes Summary	Performed	Checked	Date
Performed by			Page 32 / 36	Revision
Checked by				
Date	13/04/2022			



# VFD OPERATION CURVE

Three Phase Induction Motor - Squirrel Cage



Customer :

Product line : NEMA Premium Efficiency Three-Phase

Product code : 11457762

Catalog # : 15012ET3GRB447T-W22

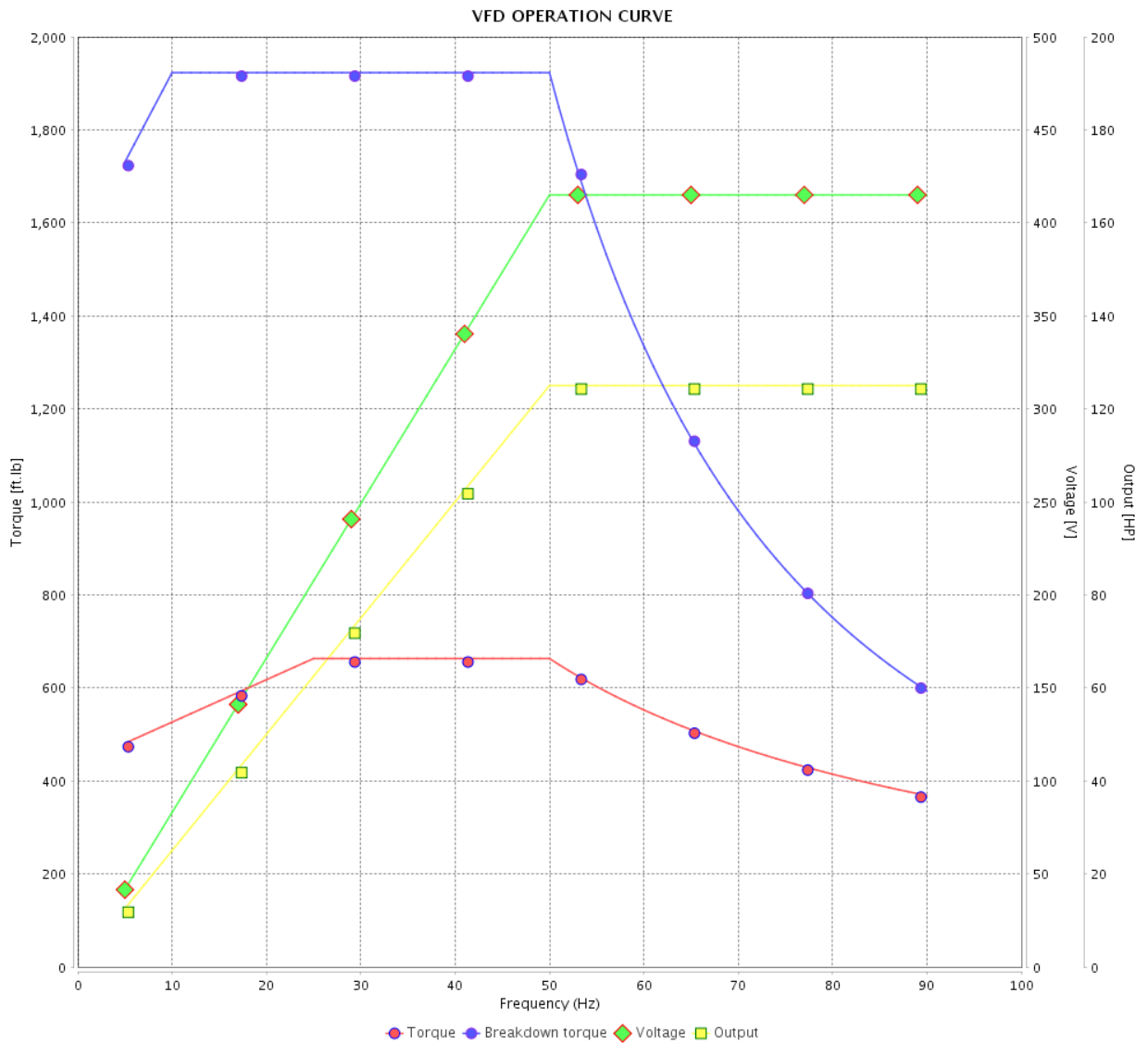

Performance : 415 V 50 Hz 6P IE3

Rated current : 165 A  
 LRC : 7.0  
 Rated torque : 663 ft.lb  
 Locked rotor torque : 290 %  
 Breakdown torque : 290 %  
 Rated speed : 990 rpm

Moment of inertia (J) : 134 sq.ft.lb  
 Duty cycle : Cont.(S1)  
 Insulation class : F  
 Service factor : 1.00  
 Temperature rise : 80 K  
 Design : B

Rev.	Changes Summary	Performed	Checked	Date
Performed by			Page 33 / 36	Revision
Checked by				
Date	13/04/2022			

# VFD OPERATION CURVE

Three Phase Induction Motor - Squirrel Cage



Customer :

Product line : NEMA Premium Efficiency Three-Phase

Product code : 11457762

Catalog # : 15012ET3GRB447T-W22

VFD OPERATION CURVE

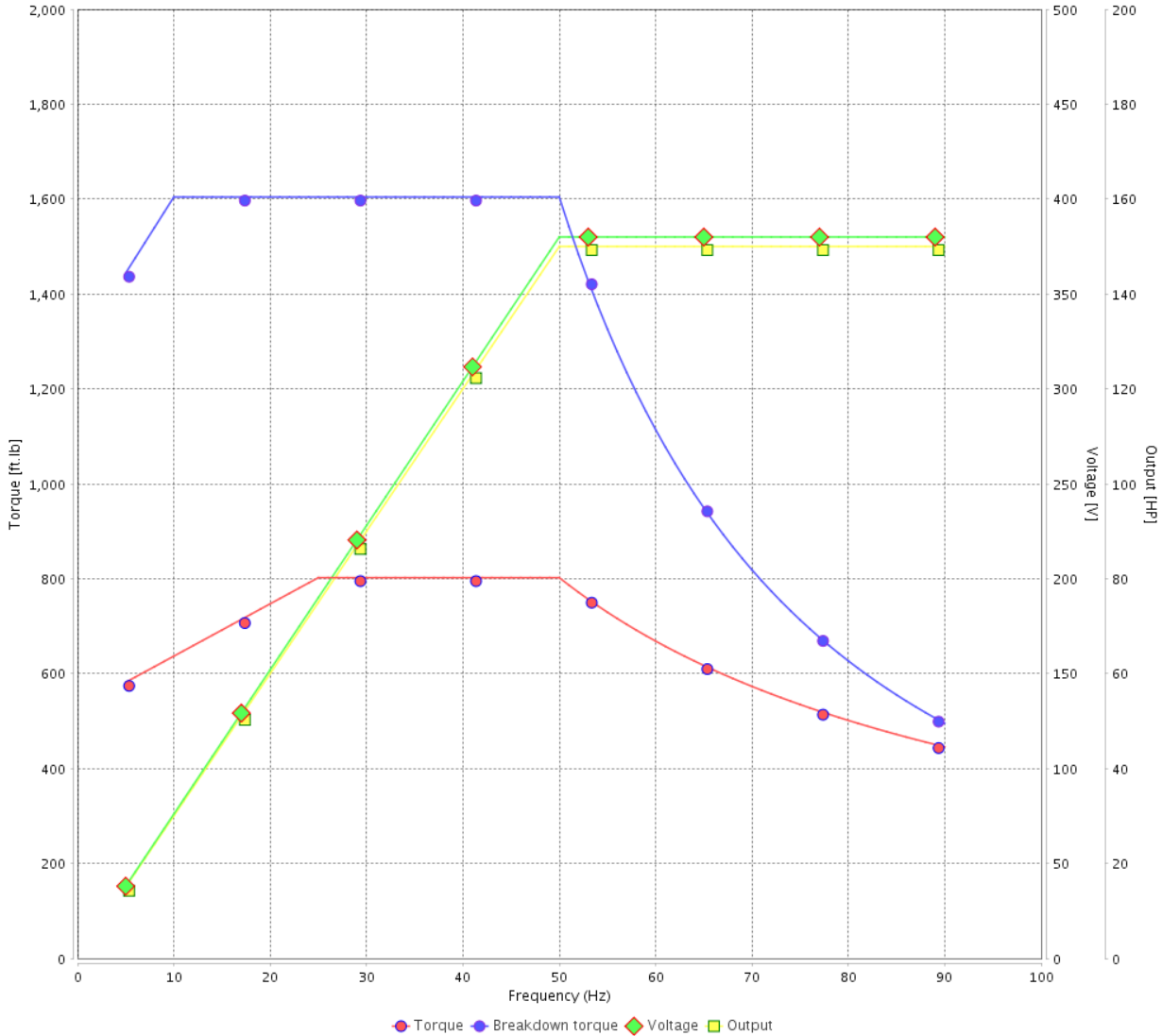

Performance : 380 V 50 Hz 6P IE2

Rated current	: 211 A	Moment of inertia (J)	: 134 sq.ft.lb
LRC	: 5.0	Duty cycle	: Cont.(S1)
Rated torque	: 802 ft.lb	Insulation class	: F
Locked rotor torque	: 190 %	Service factor	: 1.00
Breakdown torque	: 200 %	Temperature rise	: 105 K
Rated speed	: 982 rpm	Design	: B

Rev.	Changes Summary	Performed	Checked	Date
Performed by			Page 34 / 36	Revision
Checked by				
Date	13/04/2022			

# VFD OPERATION CURVE

## Three Phase Induction Motor - Squirrel Cage



Customer : \_\_\_\_\_

Product line : NEMA Premium Efficiency Three-Phase  
 Product code : 11457762  
 Catalog # : 15012ET3GRB447T-W22

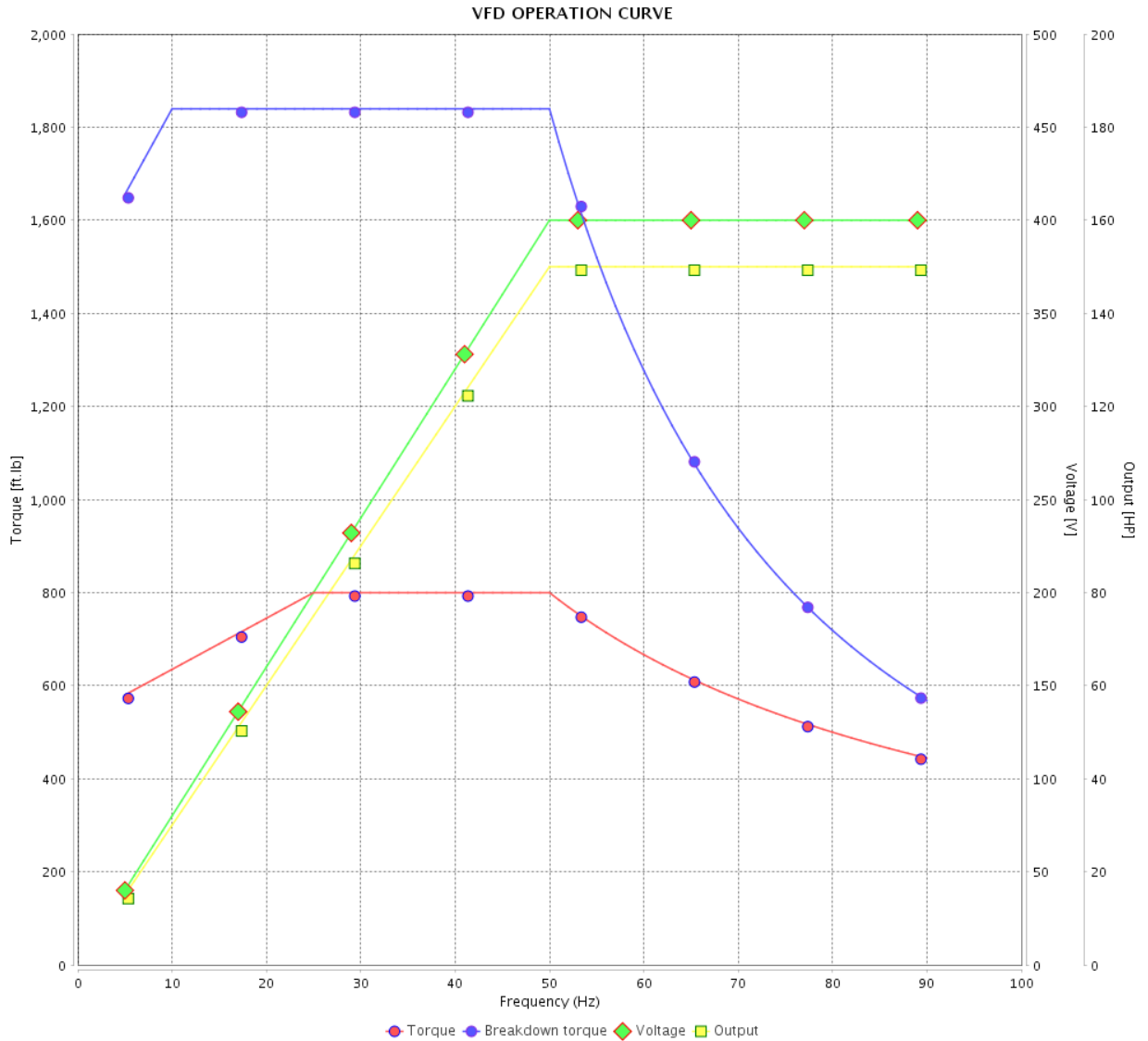

Performance : 400 V 50 Hz 6P IE2

Rated current	: 201 A	Moment of inertia (J)	: 134 sq.ft.lb
LRC	: 5.5	Duty cycle	: Cont.(S1)
Rated torque	: 800 ft.lb	Insulation class	: F
Locked rotor torque	: 220 %	Service factor	: 1.00
Breakdown torque	: 229 %	Temperature rise	: 105 K
Rated speed	: 985 rpm	Design	: B

Rev.	Changes Summary	Performed	Checked	Date
Performed by			Page 35 / 36	Revision
Checked by				
Date	13/04/2022			

# VFD OPERATION CURVE

Three Phase Induction Motor - Squirrel Cage



Customer :

Product line : NEMA Premium Efficiency Three-Phase

Product code : 11457762

Catalog # : 15012ET3GRB447T-W22

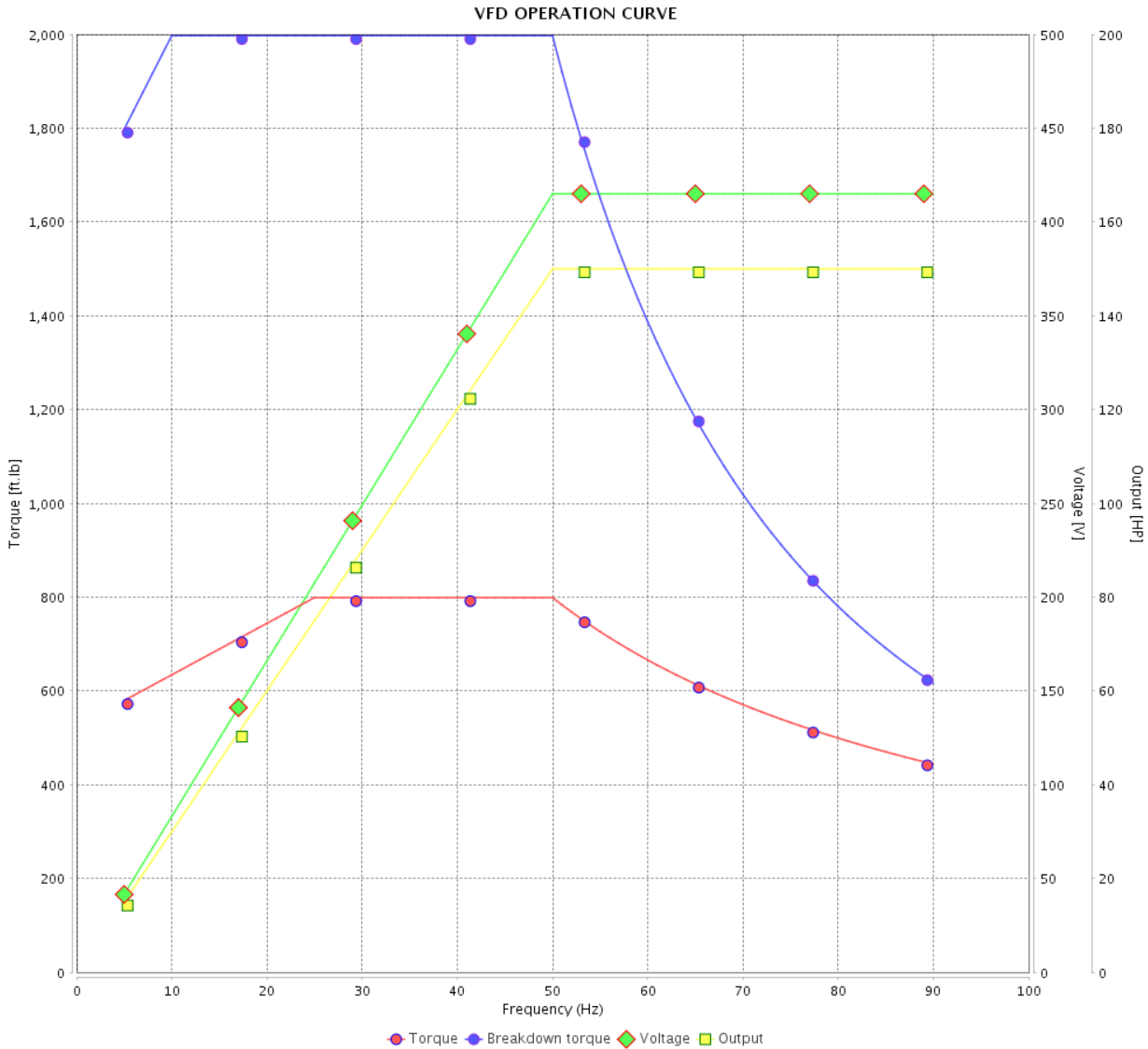

Performance : 415 V 50 Hz 6P IE2

Rated current	: 196 A	Moment of inertia (J)	: 134 sq.ft.lb
LRC	: 6.0	Duty cycle	: Cont.(S1)
Rated torque	: 799 ft.lb	Insulation class	: F
Locked rotor torque	: 240 %	Service factor	: 1.00
Breakdown torque	: 250 %	Temperature rise	: 105 K
Rated speed	: 986 rpm	Design	: B

Rev.	Changes Summary	Performed	Checked	Date
Performed by			Page	Revision
Checked by			36 / 36	
Date	13/04/2022			

EIXO/SHAFT	
PADRÃO/STANDARD	X
OPCIONAL/OPTIONAL	
ESPECIAL/SPECIAL	

Dimensões em polegada  
Dimensions in inches

THIS IS AN UPDATED REVISION, THE PREVIOUS ONE MUST BE DISREGARDED.

A

B

C

D

E

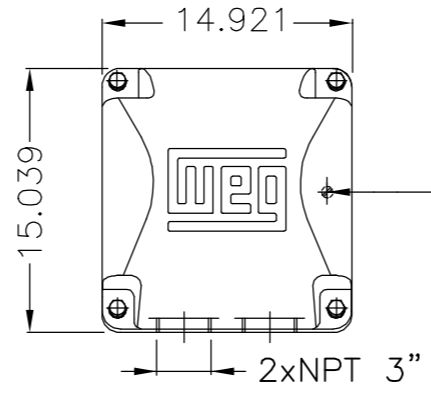
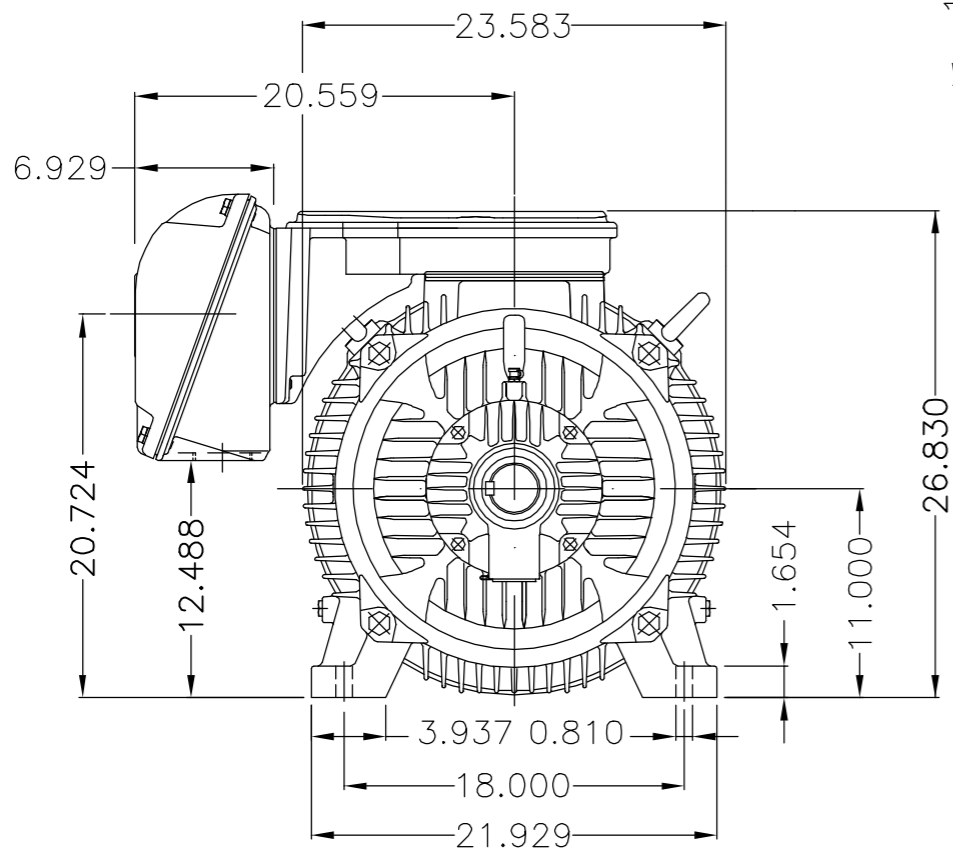

Main terminal box

Grounding for leads 35-70 mm<sup>2</sup> / 1-2/0 AWG

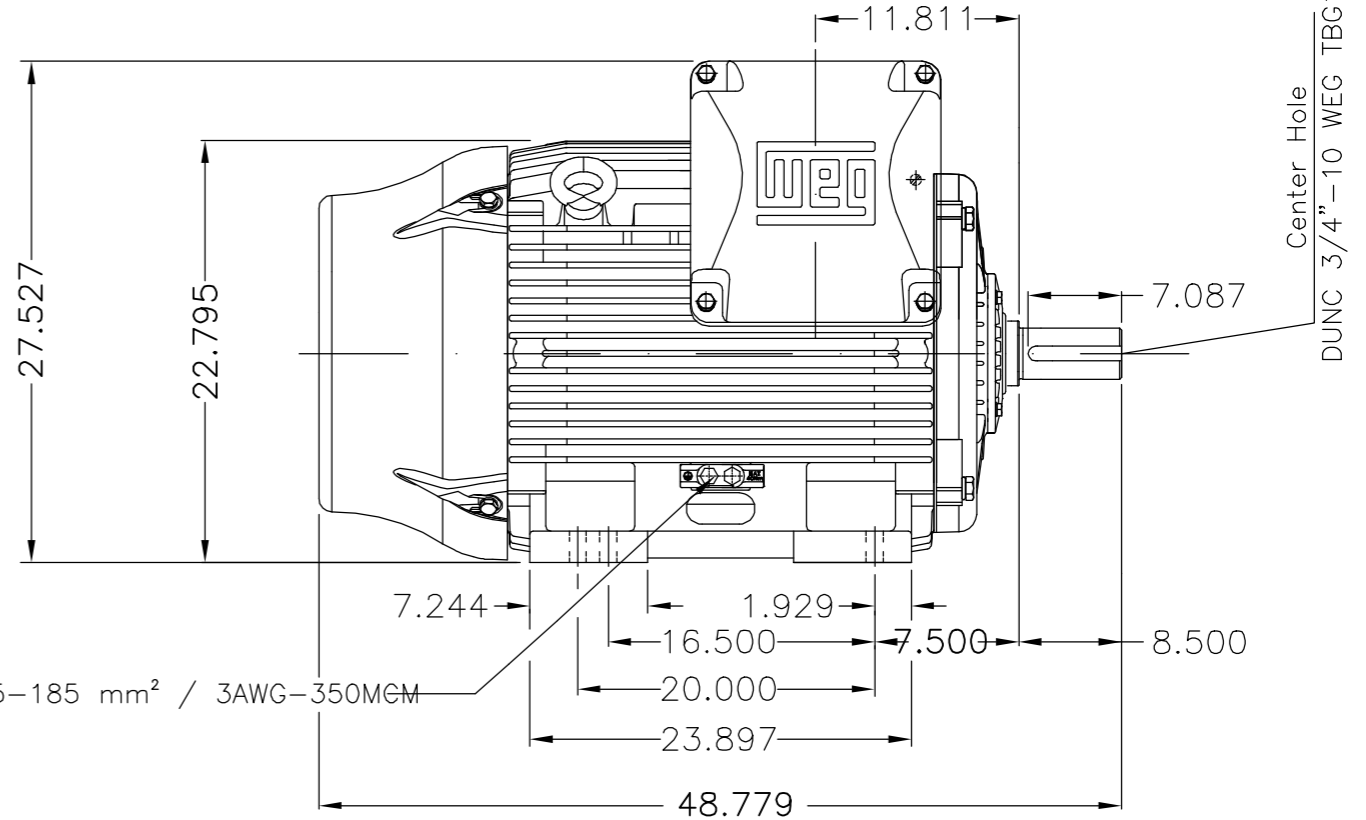

Grounding for leads 25-185 mm<sup>2</sup> / 3AWG-350MCM

Center Hole  
DUNC 3/4"-10 WEG TBG12

Fixar o conduto no suporte com abraçadeiras.  
Fasten the conduit on support with cables ties.

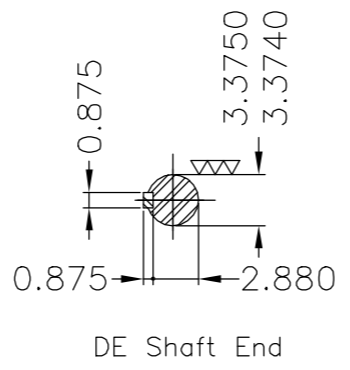
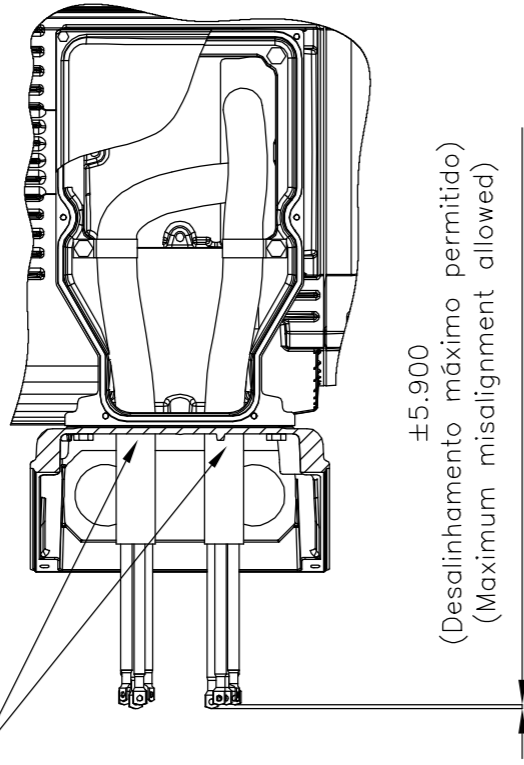

Linha do motor: Crusher Duty / Motor purpose: Crusher Duty						
Rolamento dianteiro de rolos / DE roller bearing						
Conduite para cabos no interior do suporte da caixa de ligação						
Cables conduit inside terminal box support						
Dispositivo de travamento de eixo / Shaft locking device						
Cor RAL 5009 / Color RAL 5009						
Plano de pintura 203A / Painting plan 203A						
Forma construtiva B3D / Mounting B3R(D)						
<b>WEG EQUIPAMENTOS ELETRICOS S/A</b>						

500001331189	ADIC.NOTA CONDUITE/ADD NOTE CONDUIT	MENSOR	EANJOS	05.07.2017	03			
500001323616	ALTERADO CONFORME CLAIM 414658625	MENSOR	JMANENTE	20.06.2017	02			
ECM	LOC	SUMMARY OF MODIFICATIONS		EXECUTED	CHECKED	RELEASED	DATE	VER
EXECUTED	GABRIELID	THREE PHASE W22 MOTOR		10004923855				
CHECKED		FRAME 445/7T IP55 TEFC		000   04				
RELEASED	JMANENTE							
REL DT	09.05.2017	WMO	Jaragua do Sul	Product Engineering	SHEET	1 / 1		

200 HP	06 Poles	60Hz	414668751	D
150 HP	06 Poles	60Hz	414668751	C
250 HP	04 Poles	60Hz	414658029	B
200 HP	04 Poles	60Hz	414668751	A

MADE IN MEXICO  
11457762



**NEMA**  
Premium  
W22



FOR SAFE AREA  
Mod.TE1BFOXON  
CC029A





Class I, Div 2, Gr A, B, C and D - T3  
Class I, Zone 2, IIC - T3  
Class II, Div 2, Gr F and G - T3C  
For use on PWM: Gr. A, B, C, D and F,  
VT 1000:1, CT 20:1, 1.00SF - T3

MODEL 15012ET3GRB447T-W22

Inverter Duty Motor  
Severe Duty

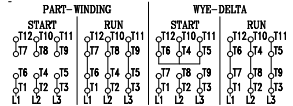
PH3	60Hz	Fr. 445/7T	1000m.a.s.l.	IP55	TEFC	2286lb
V 460				A 176		
HP 150				kW 110		
SF 1.15				SFA 202		
RPM 1187				PF 0.82		
AMB 40°C				INS cl. F DT80K	NEMA NOM EFF 95.8%	
DUTY CONT.				DES B Code G		



-  → NU-319-C3 (45g)
-  → 6316-C3 (34g)

 MOBIL POLYREX EM (9000h)