

DATA SHEET

Three Phase Induction Motor - Squirrel Cage



Customer							
Product line		: NEMA Premium Efficiency Three-Phase		Product code :		11584442	
				Catalog # :		15012ST3QIERB447T-W2	
Frame		: 445/7T		Cooling method		: IC411 - TEFC	
Insulation class		: F		Mounting		: F-1	
Duty cycle		: Cont.(S1)		Rotation ¹		: Both (CW and CCW)	
Ambient temperature		: -20°C to +40°C		Starting method		: Direct On Line	
Altitude		: 1000 m.a.s.l.		Approx. weight ²		: 2353 lb	
Protection degree		: IP55		Moment of inertia (J)		: 134 sq.ft.lb	
Design		: B					
Output [HP]	150	125	125	125	150	150	150
Poles	6	6	6	6	6	6	6
Frequency [Hz]	60	50	50	50	50	50	50
Rated voltage [V]	460	380	400	415	380	400	415
Rated current [A]	176	174	167	165	211	201	196
L. R. Amperes [A]	1074	1027	1069	1139	1034	1085	1156
LRC [A]	6.1x(Code G)	5.9x(Code F)	6.4x(Code G)	6.9x(Code H)	4.9x(Code E)	5.4x(Code F)	5.9x(Code F)
No load current [A]	65.0	64.2	69.2	73.1	64.2	69.2	73.1
Rated speed [RPM]	1185	985	985	990	985	985	990
Slip [%]	1.25	1.50	1.50	1.00	1.50	1.50	1.00
Rated torque [ft.lb]	665	666	666	663	800	800	796
Locked rotor torque [%]	229	210	229	250	170	190	210
Breakdown torque [%]	250	270	290	330	220	240	270
Service factor	1.15	1.00	1.00	1.00	1.00	1.00	1.00
Temperature rise	80 K	105 K	105 K	80 K	105 K	105 K	105 K
Locked rotor time	36s (cold)	27s (cold)	27s (cold)	27s (cold)	27s (cold)	27s (cold)	27s (cold)
	20s (hot)	15s (hot)	15s (hot)	15s (hot)	15s (hot)	15s (hot)	15s (hot)
Noise level ²	69.0 dB(A)						
Efficiency (%)	25%	94.5	94.8	94.3	94.4	95.3	94.9
	50%	95.0	94.8	94.5	94.5	95.0	95.0
	75%	95.4	95.1	95.1	95.1	95.0	95.0
	100%	95.8	94.9	95.1	95.1	94.5	95.0
Power Factor	25%	0.44	0.44	0.41	0.38	0.50	0.47
	50%	0.67	0.67	0.64	0.60	0.73	0.70
	75%	0.78	0.79	0.76	0.74	0.82	0.80
	100%	0.82	0.83	0.82	0.80	0.84	0.83
Bearing type	: Drive end		: Non drive end		Foundation loads		
	: NU-319 C3		: 6316 C3		Max. traction : 4550 lb		
	: Inpro/Seal		: Inpro/Seal		Max. compression : 6903 lb		
	: 9000 h		: 16000 h				
	: 45 g		: 34 g				
Lubricant type		: Mobil Polyrex EM					
Notes							
This revision replaces and cancel the previous one, which must be eliminated. (1) Looking the motor from the shaft end. (2) Measured at 1m and with tolerance of +3dB(A). (3) Approximate weight subject to changes after manufacturing process. (4) At 100% of full load.				These are average values based on tests with sinusoidal power supply, subject to the tolerances stipulated in NEMA MG-1.			
Rev.	Changes Summary			Performed	Checked	Date	
Performed by							
Checked by					Page	Revision	
Date	13/04/2022				1 / 36		

TORQUE AND CURRENT VS SPEED CURVE

Three Phase Induction Motor - Squirrel Cage



Customer :

Product line : NEMA Premium Efficiency Three-Phase

Product code : 11584442

Catalog # : 15012ST3QIERB447T-W2

TORQUE AND CURRENT VS SPEED CURVE

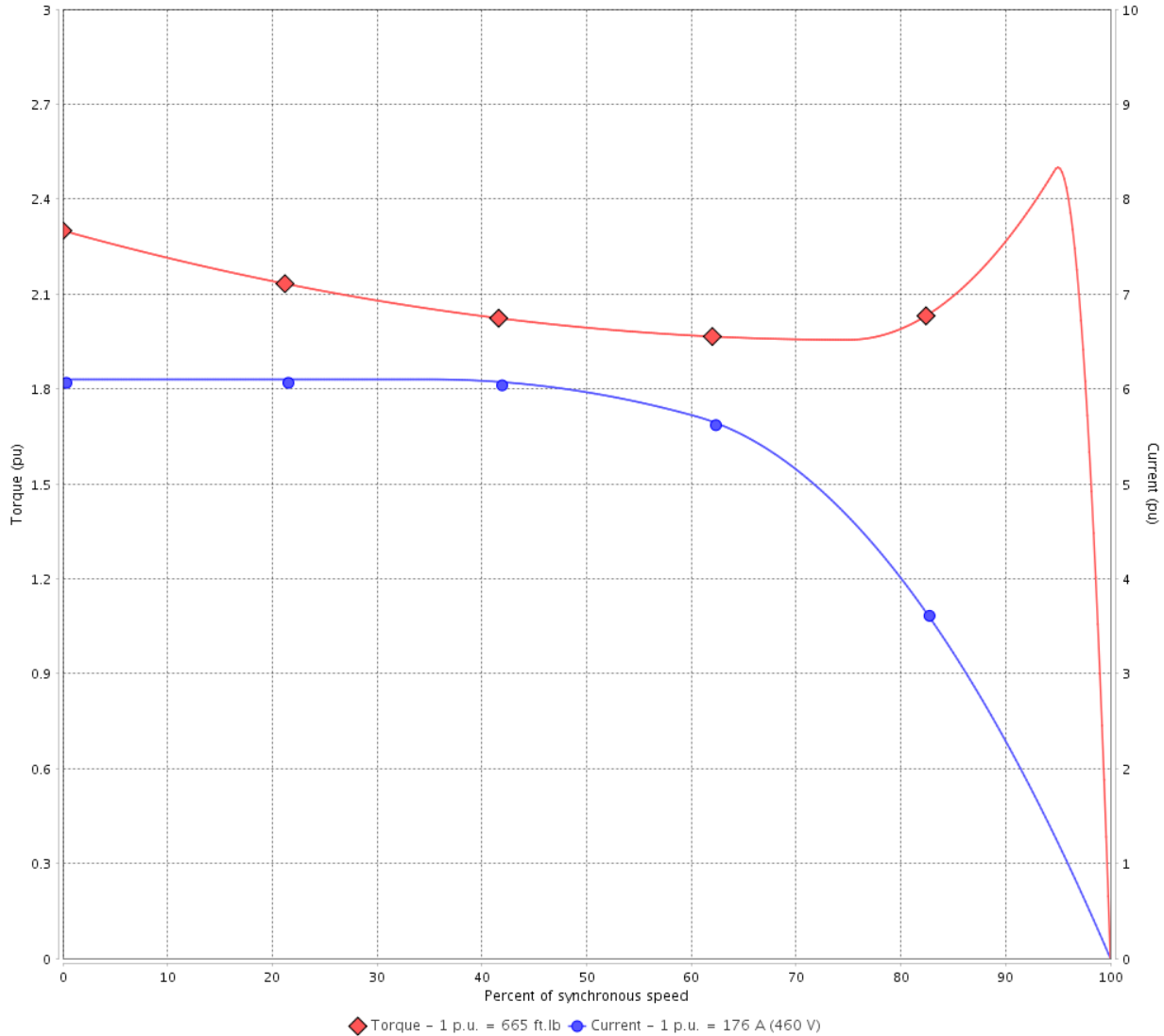

Performance : 460 V 60 Hz 6P

Rated current	: 176 A	Moment of inertia (J)	: 134 sq.ft.lb
LRC	: 6.1	Duty cycle	: Cont.(S1)
Rated torque	: 665 ft.lb	Insulation class	: F
Locked rotor torque	: 229 %	Service factor	: 1.15
Breakdown torque	: 250 %	Temperature rise	: 80 K
Rated speed	: 1185 rpm	Design	: B

Locked rotor time : 36s (cold) 20s (hot)

Rev.	Changes Summary	Performed	Checked	Date
Performed by			Page 2 / 36	Revision
Checked by				
Date	13/04/2022			

TORQUE AND CURRENT VS SPEED CURVE



Three Phase Induction Motor - Squirrel Cage

Customer :

Product line : NEMA Premium Efficiency Three-Phase

Product code : 11584442

Catalog # : 15012ST3QIERB447T-W2

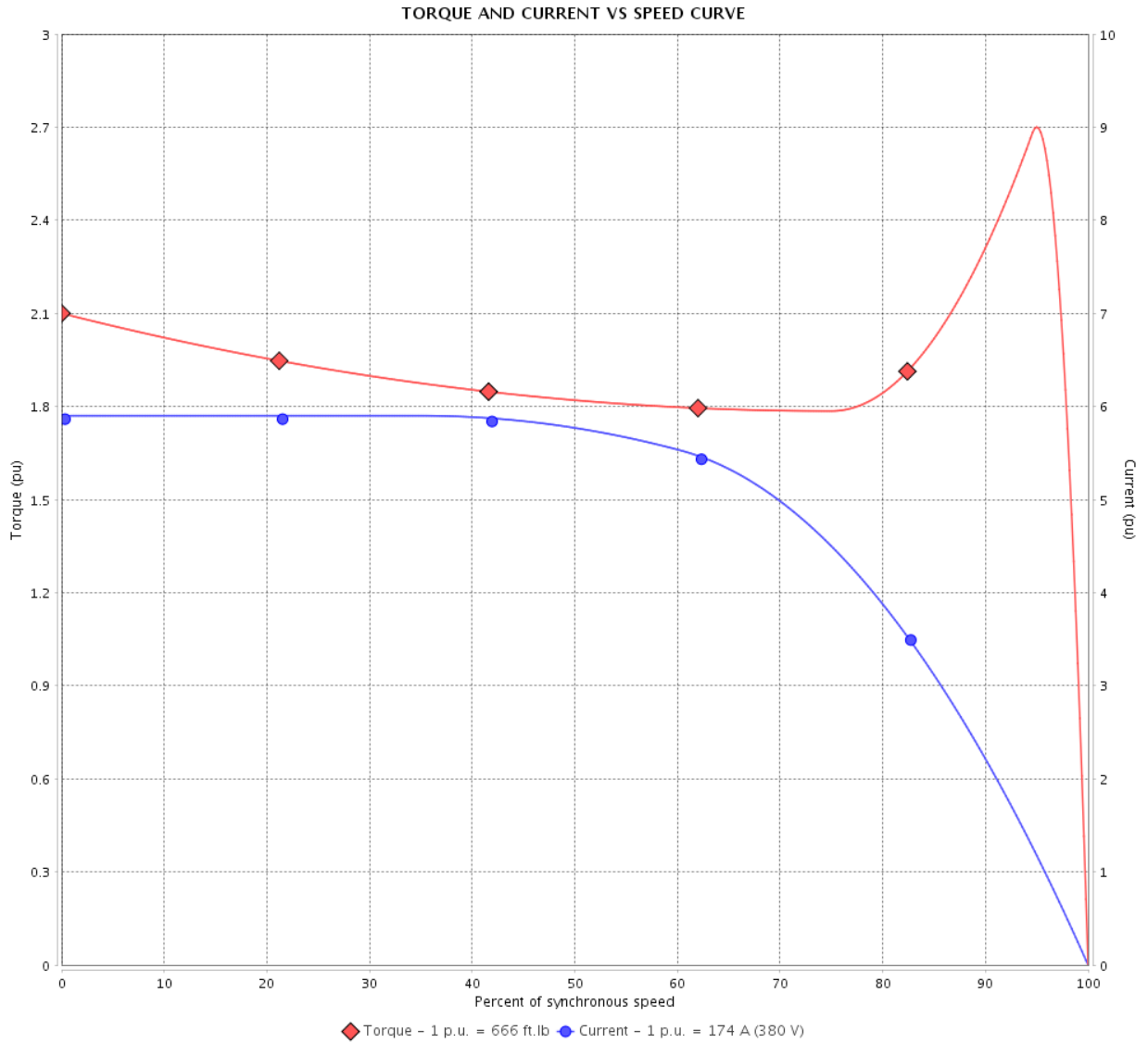

Performance : 380 V 50 Hz 6P IE3

Rated current	: 174 A	Moment of inertia (J)	: 134 sq.ft.lb
LRC	: 5.9	Duty cycle	: Cont.(S1)
Rated torque	: 666 ft.lb	Insulation class	: F
Locked rotor torque	: 210 %	Service factor	: 1.00
Breakdown torque	: 270 %	Temperature rise	: 105 K
Rated speed	: 985 rpm	Design	: B

Locked rotor time : 27s (cold) 15s (hot)

Rev.	Changes Summary	Performed	Checked	Date
Performed by			Page 3 / 36	Revision
Checked by				
Date	13/04/2022			

TORQUE AND CURRENT VS SPEED CURVE

Three Phase Induction Motor - Squirrel Cage



Customer :

Product line : NEMA Premium Efficiency Three-Phase

Product code : 11584442

Catalog # : 15012ST3QIERB447T-W2

TORQUE AND CURRENT VS SPEED CURVE

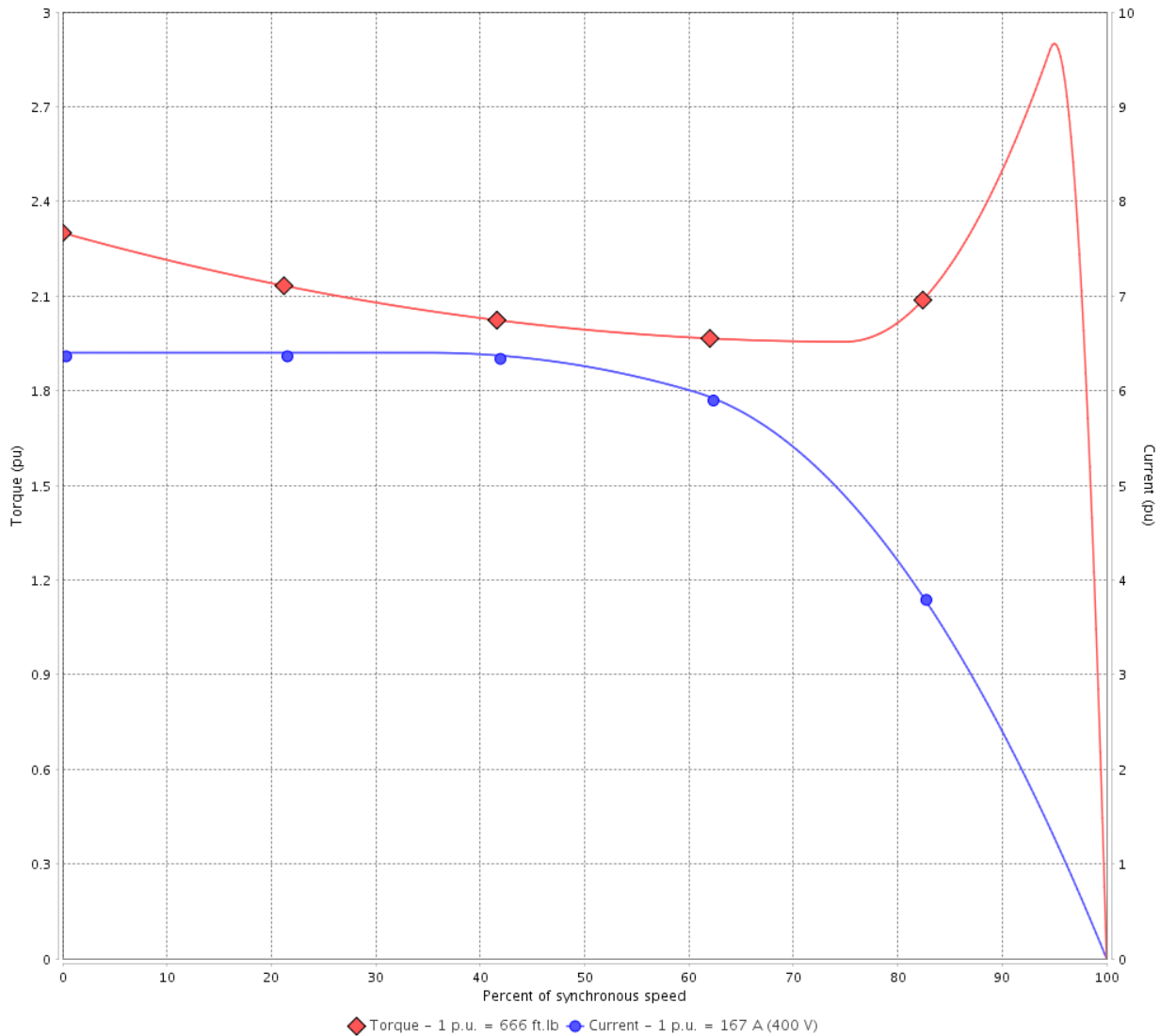

Performance : 400 V 50 Hz 6P IE3

Rated current	: 167 A	Moment of inertia (J)	: 134 sq.ft.lb
LRC	: 6.4	Duty cycle	: Cont.(S1)
Rated torque	: 666 ft.lb	Insulation class	: F
Locked rotor torque	: 229 %	Service factor	: 1.00
Breakdown torque	: 290 %	Temperature rise	: 105 K
Rated speed	: 985 rpm	Design	: B

Locked rotor time : 27s (cold) 15s (hot)

Rev.	Changes Summary	Performed	Checked	Date
Performed by			Page 4 / 36	Revision
Checked by				
Date	13/04/2022			

TORQUE AND CURRENT VS SPEED CURVE



Three Phase Induction Motor - Squirrel Cage

Customer :

Product line : NEMA Premium Efficiency Three-Phase

Product code : 11584442

Catalog # : 15012ST3QIERB447T-W2

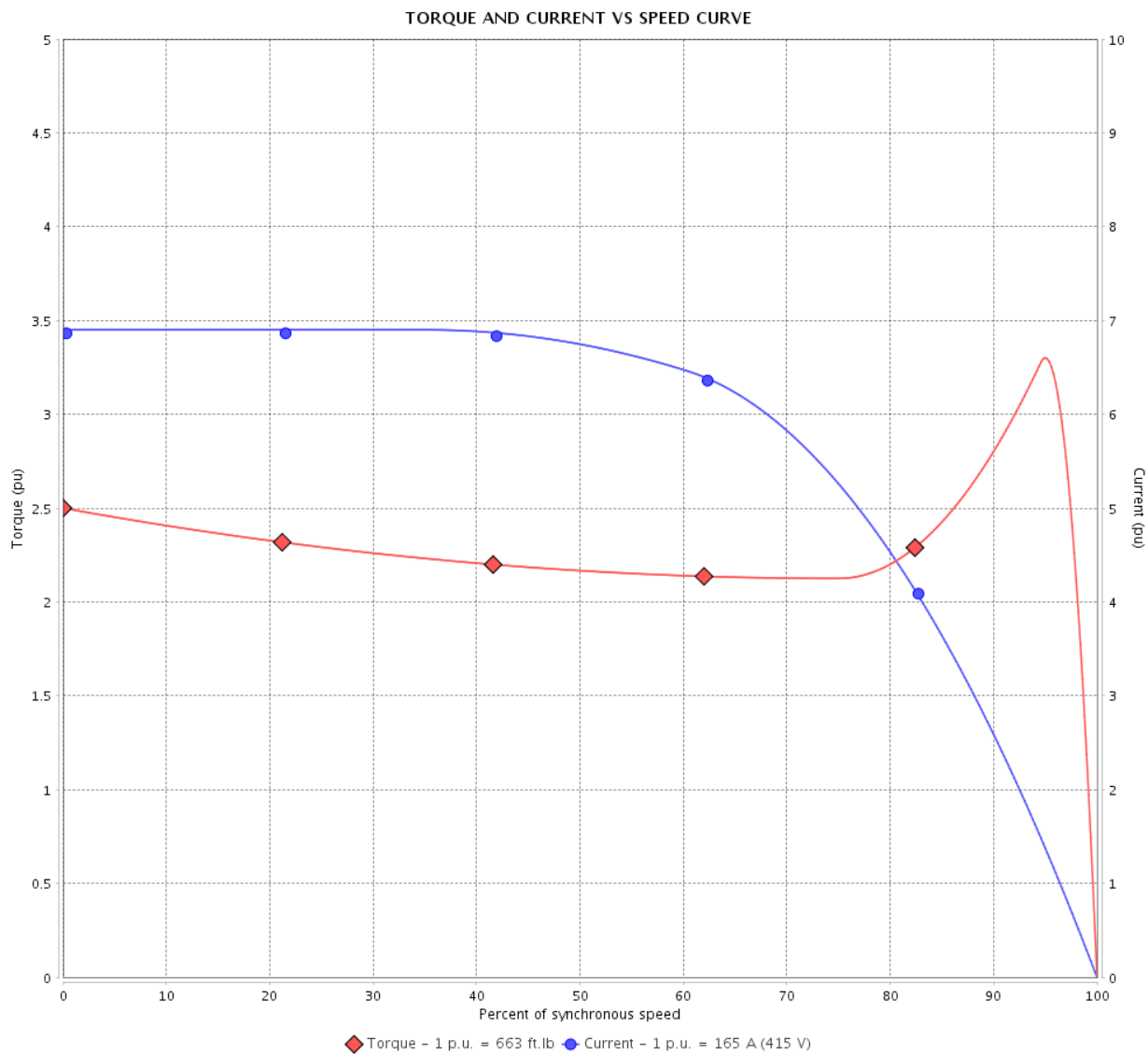

Performance : 415 V 50 Hz 6P IE3

Rated current	: 165 A	Moment of inertia (J)	: 134 sq.ft.lb
LRC	: 6.9	Duty cycle	: Cont.(S1)
Rated torque	: 663 ft.lb	Insulation class	: F
Locked rotor torque	: 250 %	Service factor	: 1.00
Breakdown torque	: 330 %	Temperature rise	: 80 K
Rated speed	: 990 rpm	Design	: B

Locked rotor time : 27s (cold) 15s (hot)

Rev.	Changes Summary	Performed	Checked	Date
Performed by			Page 5 / 36	Revision
Checked by				
Date	13/04/2022			

TORQUE AND CURRENT VS SPEED CURVE

Three Phase Induction Motor - Squirrel Cage



Customer :

Product line : NEMA Premium Efficiency Three-Phase

Product code : 11584442

Catalog # : 15012ST3QIERB447T-W2

TORQUE AND CURRENT VS SPEED CURVE

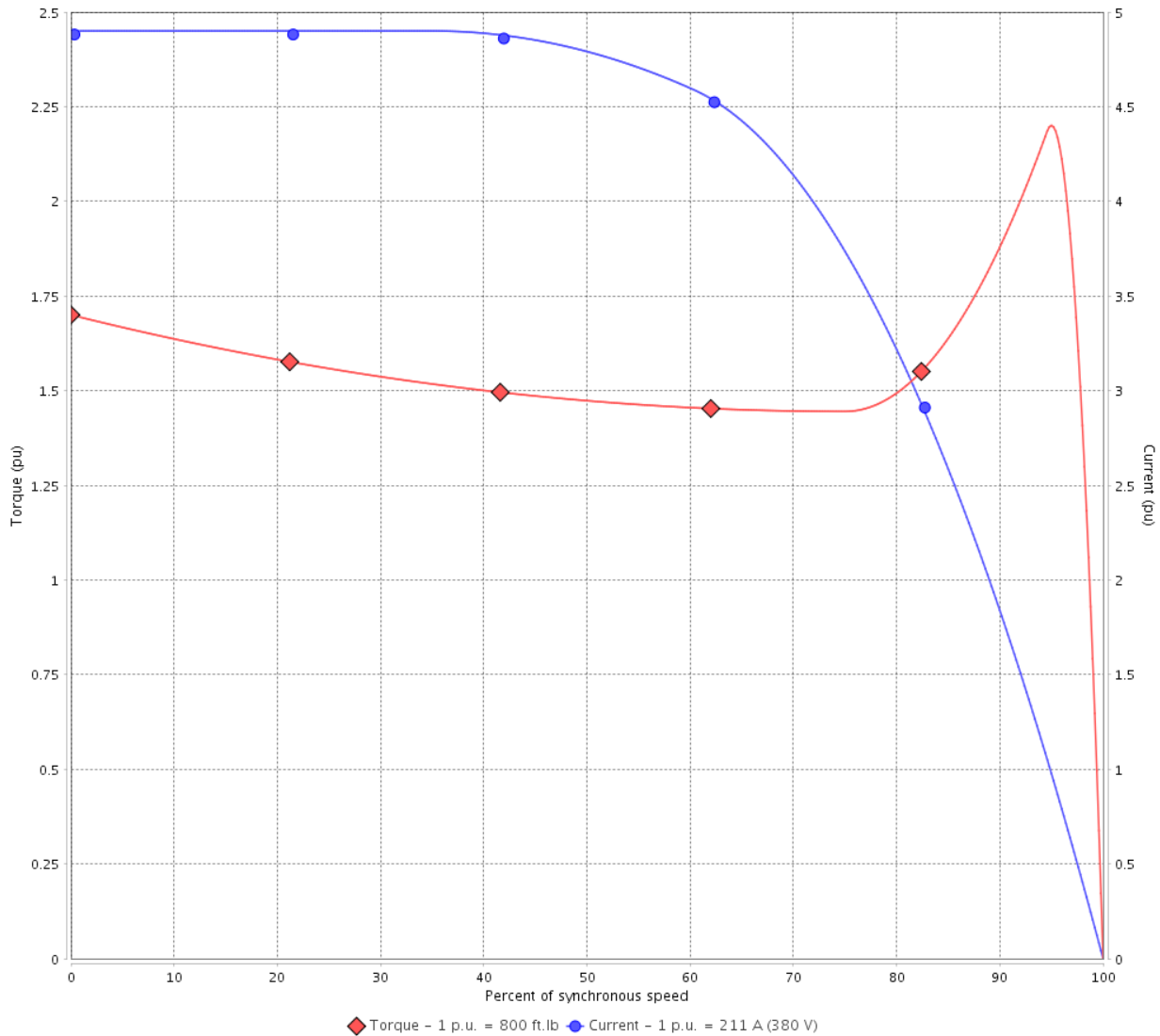

Performance : 380 V 50 Hz 6P IE2

Rated current	: 211 A	Moment of inertia (J)	: 134 sq.ft.lb
LRC	: 4.9	Duty cycle	: Cont.(S1)
Rated torque	: 800 ft.lb	Insulation class	: F
Locked rotor torque	: 170 %	Service factor	: 1.00
Breakdown torque	: 220 %	Temperature rise	: 105 K
Rated speed	: 985 rpm	Design	: B

Locked rotor time : 27s (cold) 15s (hot)

Rev.	Changes Summary	Performed	Checked	Date
Performed by			Page 6 / 36	Revision
Checked by				
Date	13/04/2022			

TORQUE AND CURRENT VS SPEED CURVE



Three Phase Induction Motor - Squirrel Cage

Customer :

Product line : NEMA Premium Efficiency Three-Phase

Product code : 11584442

Catalog # : 15012ST3QIERB447T-W2

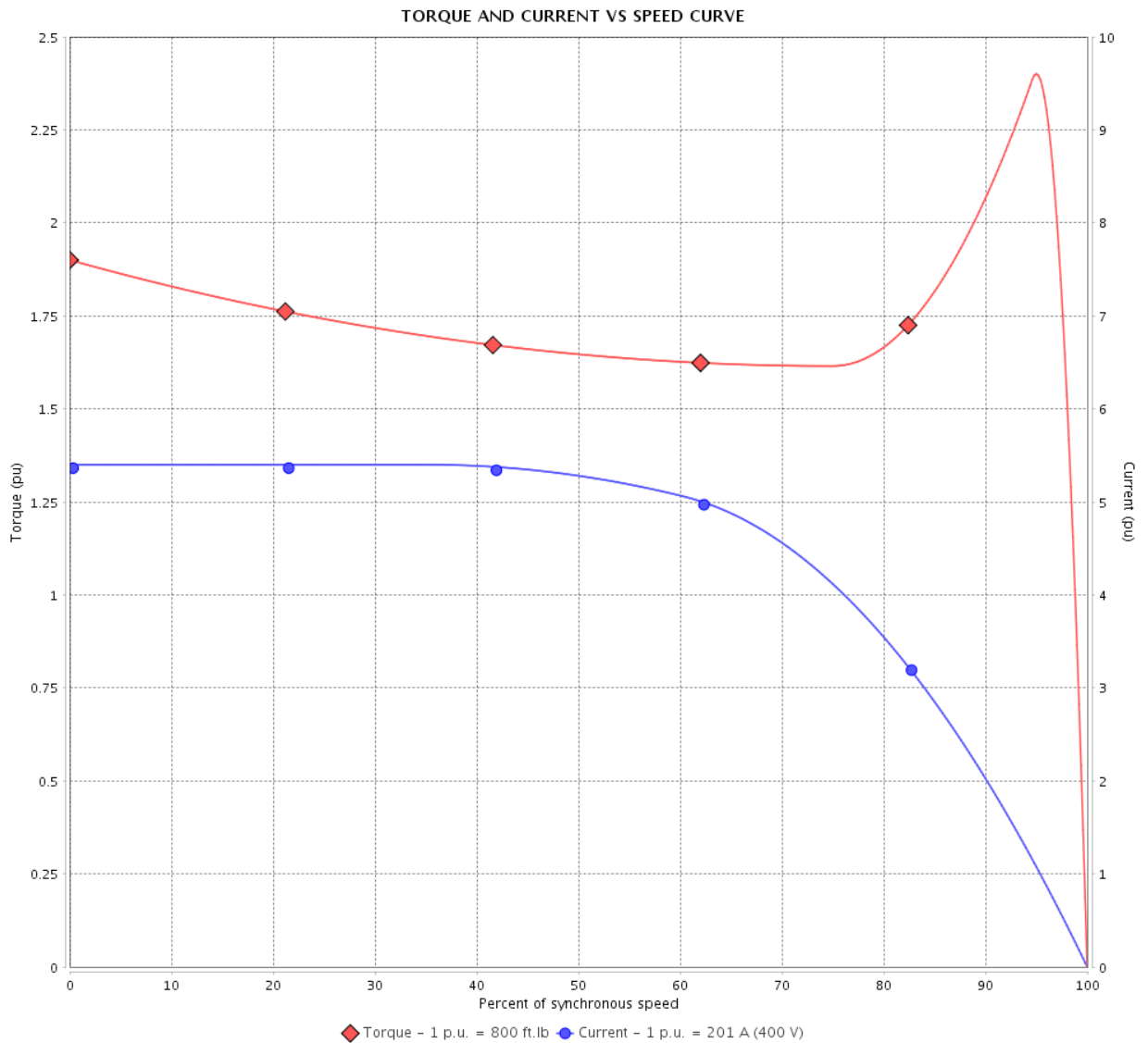

Performance : 400 V 50 Hz 6P IE2

Rated current	: 201 A	Moment of inertia (J)	: 134 sq.ft.lb
LRC	: 5.4	Duty cycle	: Cont.(S1)
Rated torque	: 800 ft.lb	Insulation class	: F
Locked rotor torque	: 190 %	Service factor	: 1.00
Breakdown torque	: 240 %	Temperature rise	: 105 K
Rated speed	: 985 rpm	Design	: B

Locked rotor time : 27s (cold) 15s (hot)

Rev.	Changes Summary	Performed	Checked	Date
Performed by			Page 7 / 36	Revision
Checked by				
Date	13/04/2022			

TORQUE AND CURRENT VS SPEED CURVE

Three Phase Induction Motor - Squirrel Cage



Customer :

Product line : NEMA Premium Efficiency Three-Phase

Product code : 11584442

Catalog # : 15012ST3QIERB447T-W2

TORQUE AND CURRENT VS SPEED CURVE

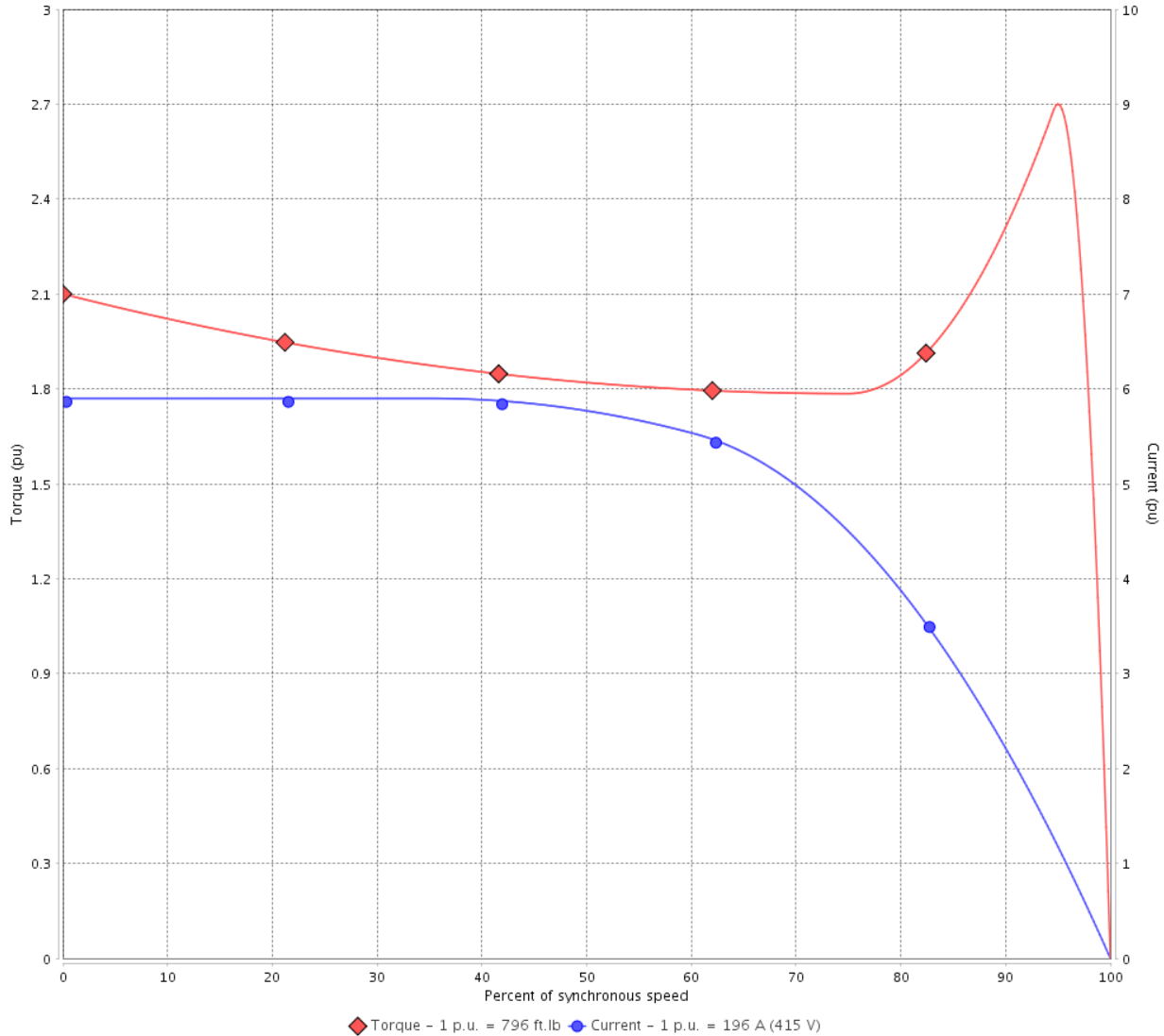

Performance : 415 V 50 Hz 6P IE2

Rated current	: 196 A	Moment of inertia (J)	: 134 sq.ft.lb
LRC	: 5.9	Duty cycle	: Cont.(S1)
Rated torque	: 796 ft.lb	Insulation class	: F
Locked rotor torque	: 210 %	Service factor	: 1.00
Breakdown torque	: 270 %	Temperature rise	: 105 K
Rated speed	: 990 rpm	Design	: B

Locked rotor time : 27s (cold) 15s (hot)

Rev.	Changes Summary	Performed	Checked	Date
Performed by			Page 8 / 36	Revision
Checked by				
Date	13/04/2022			

LOAD PERFORMANCE CURVE

Three Phase Induction Motor - Squirrel Cage



Customer : _____

Product line : NEMA Premium Efficiency Three-Phase

Product code : 11584442

Catalog # : 15012ST3QIERB447T-W2

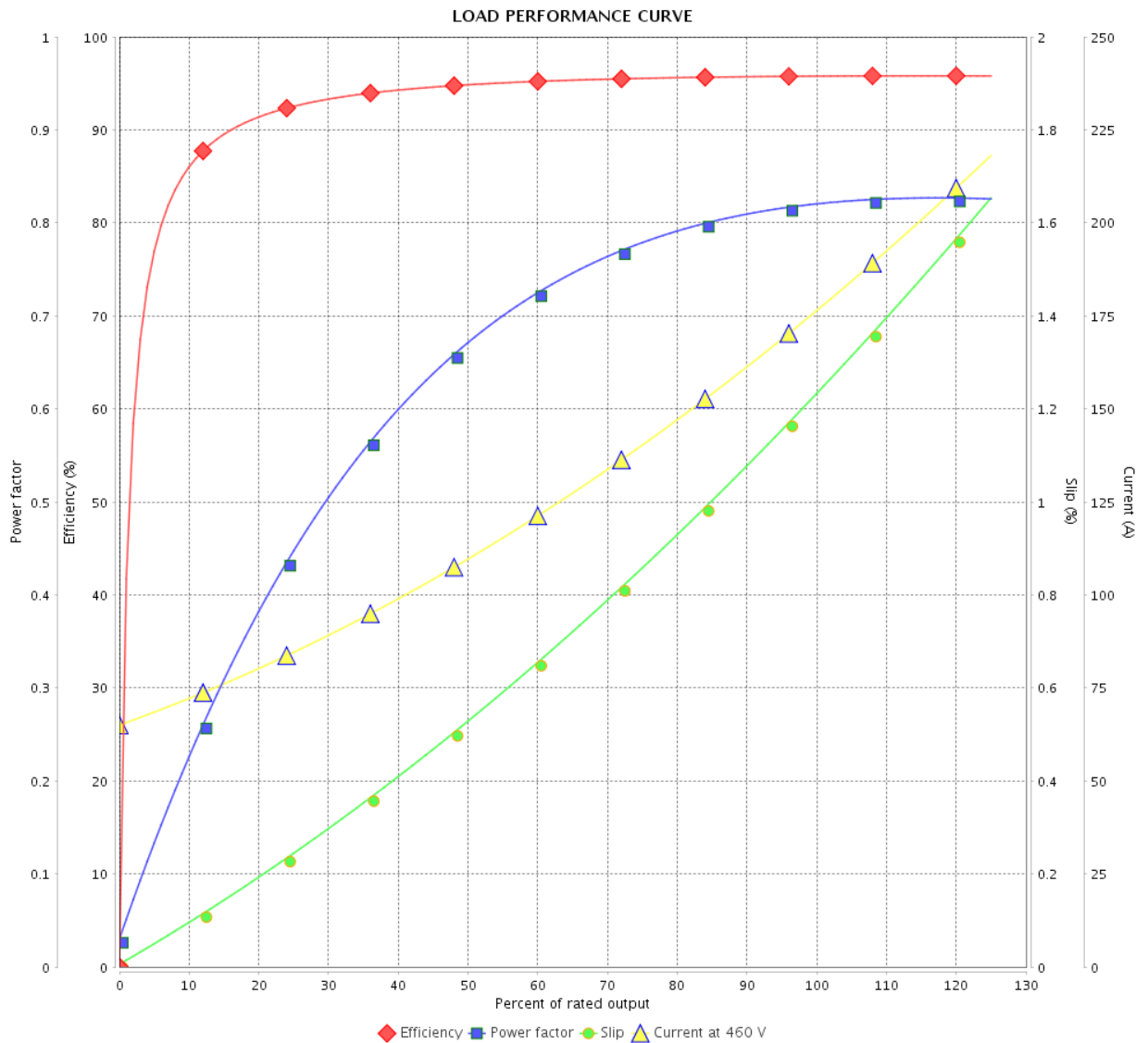

Performance : 460 V 60 Hz 6P

Rated current : 176 A
 LRC : 6.1
 Rated torque : 665 ft.lb
 Locked rotor torque : 229 %
 Breakdown torque : 250 %
 Rated speed : 1185 rpm

Moment of inertia (J) : 134 sq.ft.lb
 Duty cycle : Cont.(S1)
 Insulation class : F
 Service factor : 1.15
 Temperature rise : 80 K
 Design : B

Rev.	Changes Summary	Performed	Checked	Date
Performed by		Page		Revision
Checked by		9 / 36		
Date		13/04/2022		

LOAD PERFORMANCE CURVE

Three Phase Induction Motor - Squirrel Cage



Customer :

Product line : NEMA Premium Efficiency Three-Phase

Product code : 11584442

Catalog # : 15012ST3QIERB447T-W2

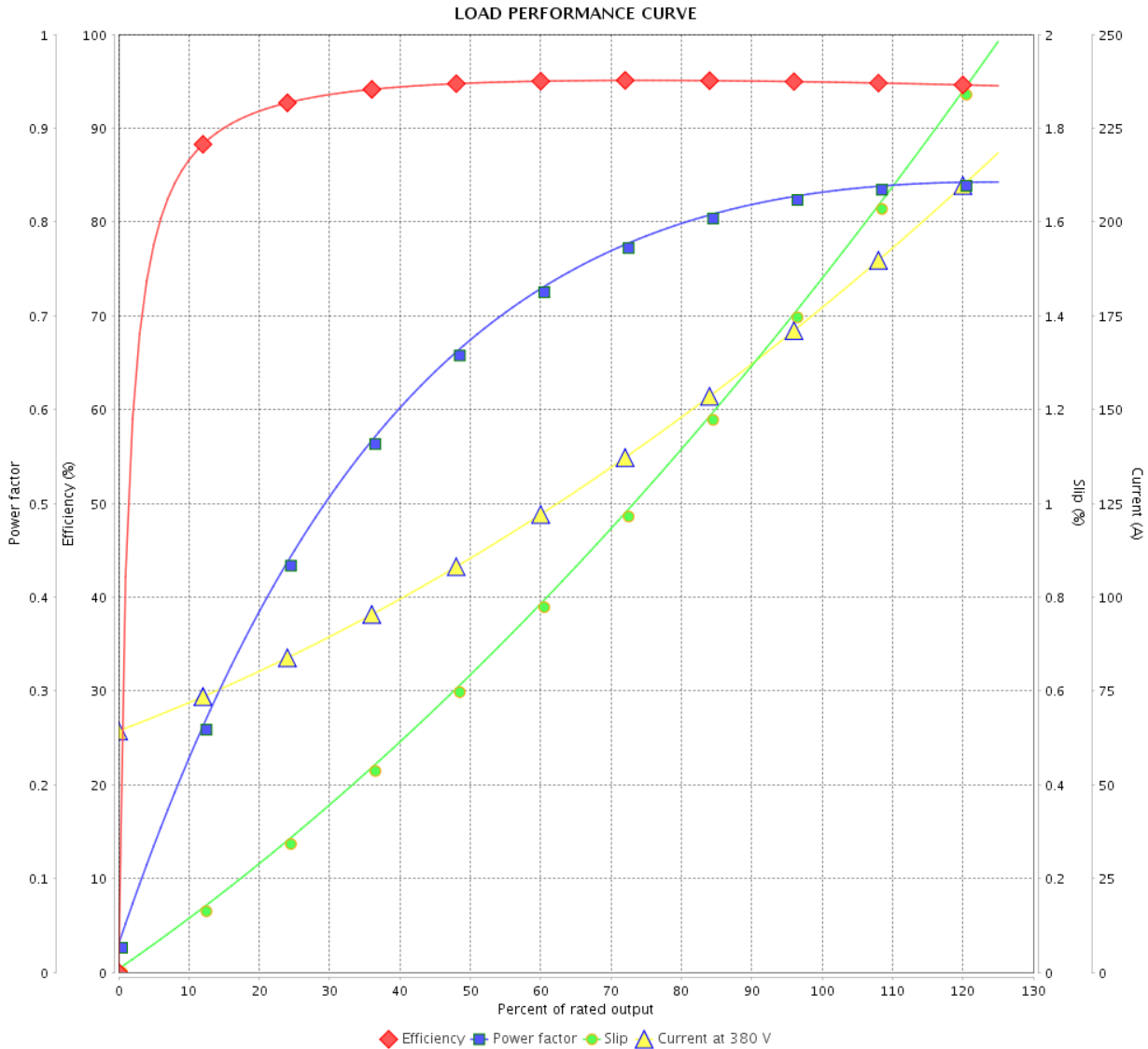

Performance : 380 V 50 Hz 6P IE3

Rated current	: 174 A	Moment of inertia (J)	: 134 sq.ft.lb
LRC	: 5.9	Duty cycle	: Cont.(S1)
Rated torque	: 666 ft.lb	Insulation class	: F
Locked rotor torque	: 210 %	Service factor	: 1.00
Breakdown torque	: 270 %	Temperature rise	: 105 K
Rated speed	: 985 rpm	Design	: B

Rev.	Changes Summary	Performed	Checked	Date
Performed by			Page	Revision
Checked by			10 / 36	
Date	13/04/2022			

LOAD PERFORMANCE CURVE

Three Phase Induction Motor - Squirrel Cage



Customer :

Product line : NEMA Premium Efficiency Three-Phase

Product code : 11584442

Catalog # : 15012ST3QIERB447T-W2

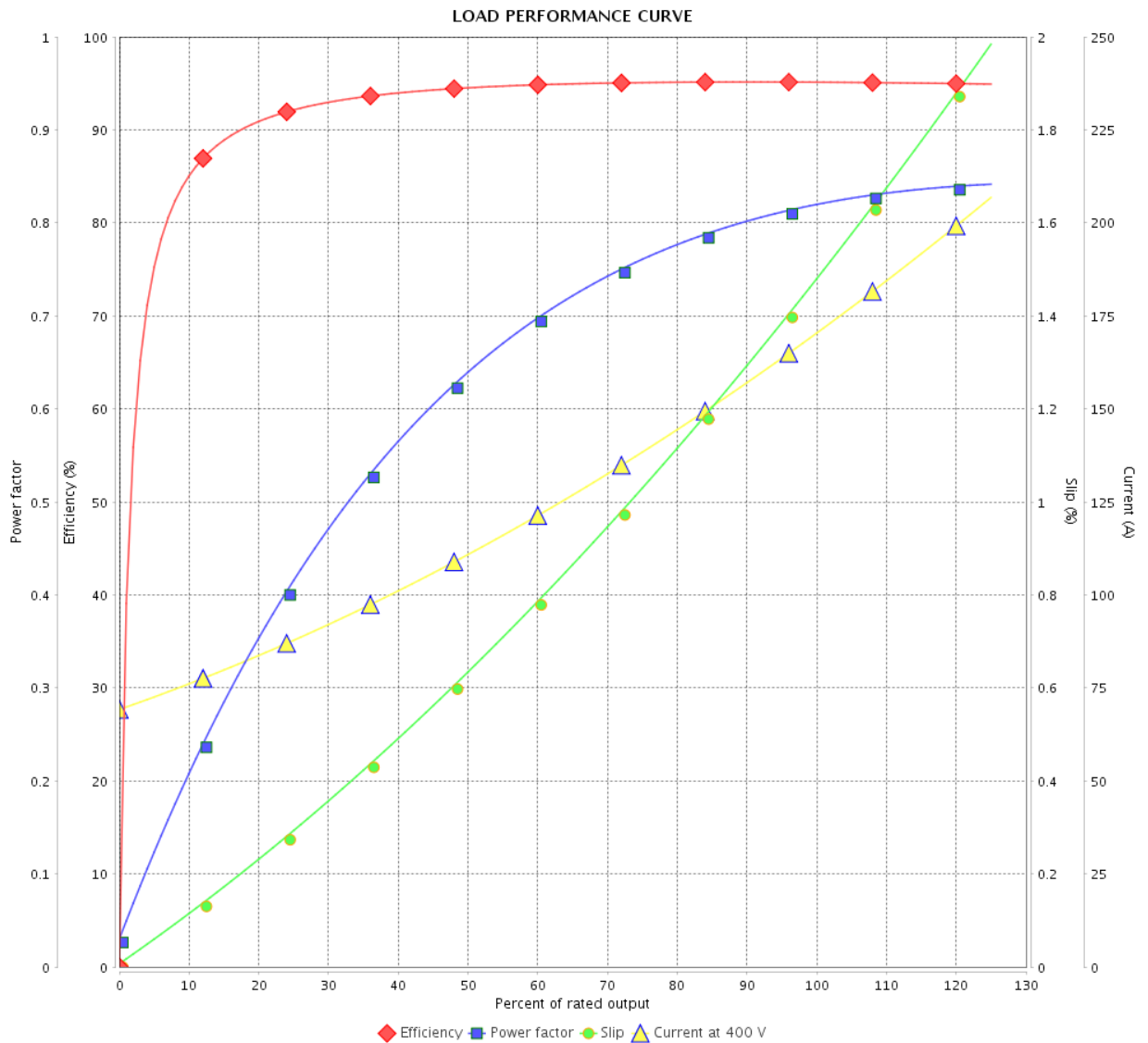

Performance : 400 V 50 Hz 6P IE3

Rated current : 167 A
 LRC : 6.4
 Rated torque : 666 ft.lb
 Locked rotor torque : 229 %
 Breakdown torque : 290 %
 Rated speed : 985 rpm

Moment of inertia (J) : 134 sq.ft.lb
 Duty cycle : Cont.(S1)
 Insulation class : F
 Service factor : 1.00
 Temperature rise : 105 K
 Design : B

Rev.	Changes Summary	Performed	Checked	Date
Performed by		Page		Revision
Checked by		11 / 36		
Date		13/04/2022		

LOAD PERFORMANCE CURVE

Three Phase Induction Motor - Squirrel Cage



Customer :

Product line : NEMA Premium Efficiency Three-Phase

Product code : 11584442

Catalog # : 15012ST3QIERB447T-W2

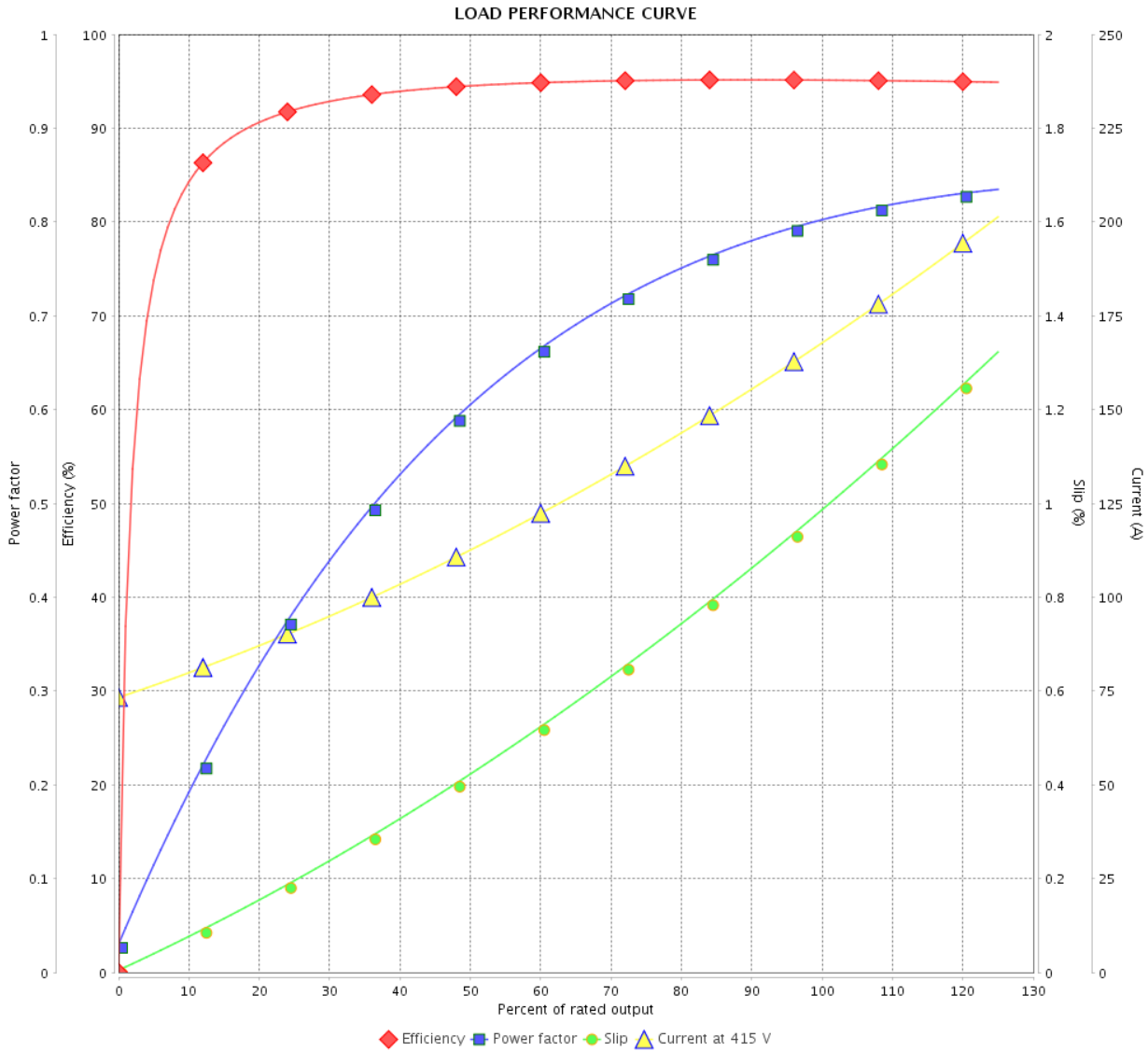

Performance : 415 V 50 Hz 6P IE3

Rated current	: 165 A	Moment of inertia (J)	: 134 sq.ft.lb
LRC	: 6.9	Duty cycle	: Cont.(S1)
Rated torque	: 663 ft.lb	Insulation class	: F
Locked rotor torque	: 250 %	Service factor	: 1.00
Breakdown torque	: 330 %	Temperature rise	: 80 K
Rated speed	: 990 rpm	Design	: B

Rev.	Changes Summary	Performed	Checked	Date
Performed by			Page 12 / 36	Revision
Checked by				
Date	13/04/2022			

LOAD PERFORMANCE CURVE

Three Phase Induction Motor - Squirrel Cage



Customer :

Product line : NEMA Premium Efficiency Three-Phase

Product code : 11584442

Catalog # : 15012ST3QIERB447T-W2

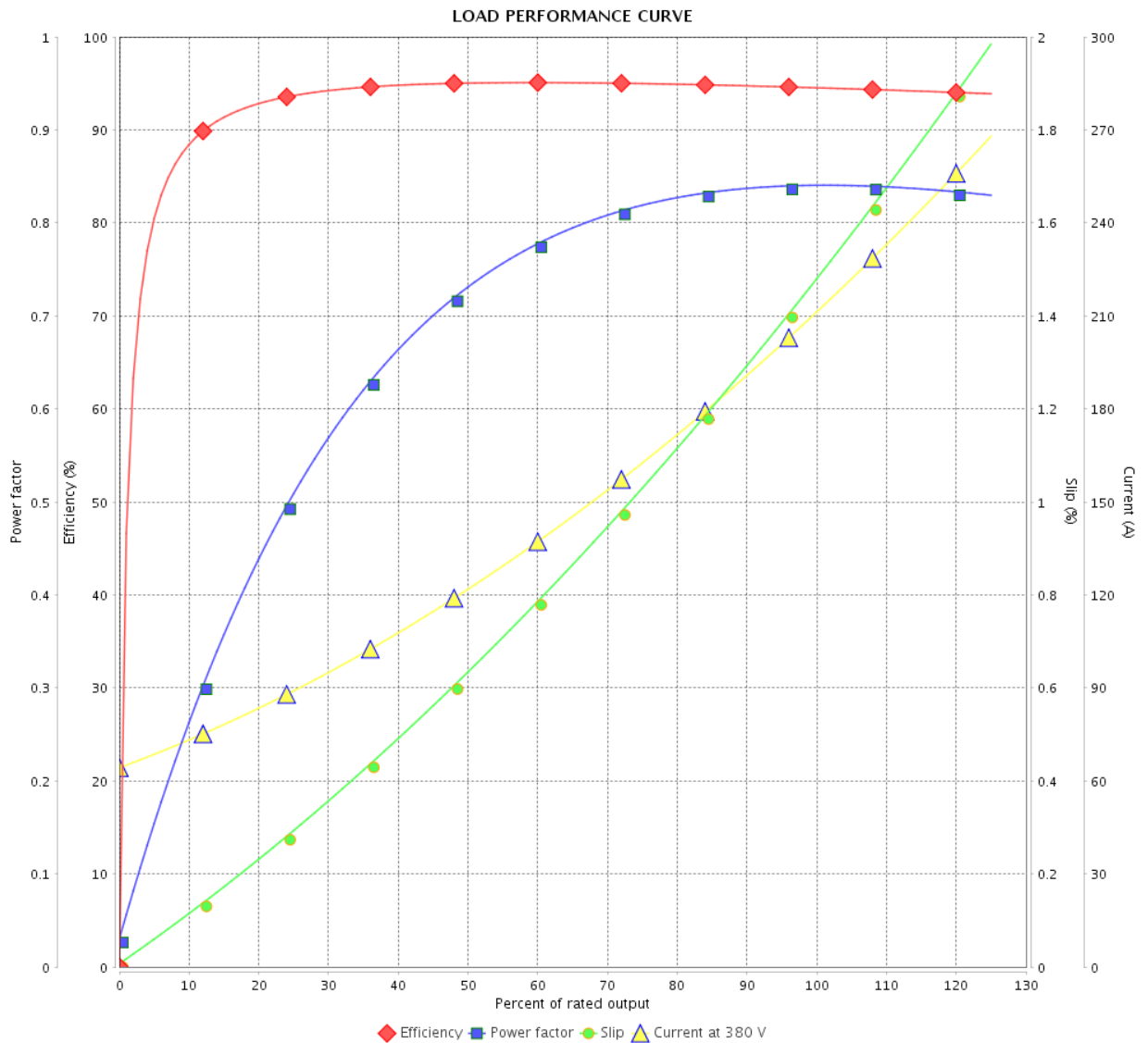

Performance : 380 V 50 Hz 6P IE2

Rated current : 211 A
 LRC : 4.9
 Rated torque : 800 ft.lb
 Locked rotor torque : 170 %
 Breakdown torque : 220 %
 Rated speed : 985 rpm

Moment of inertia (J) : 134 sq.ft.lb
 Duty cycle : Cont.(S1)
 Insulation class : F
 Service factor : 1.00
 Temperature rise : 105 K
 Design : B

Rev.	Changes Summary	Performed	Checked	Date
Performed by		Page		Revision
Checked by		13 / 36		
Date		13/04/2022		

LOAD PERFORMANCE CURVE

Three Phase Induction Motor - Squirrel Cage



Customer :

Product line : NEMA Premium Efficiency Three-Phase

Product code : 11584442

Catalog # : 15012ST3QIERB447T-W2

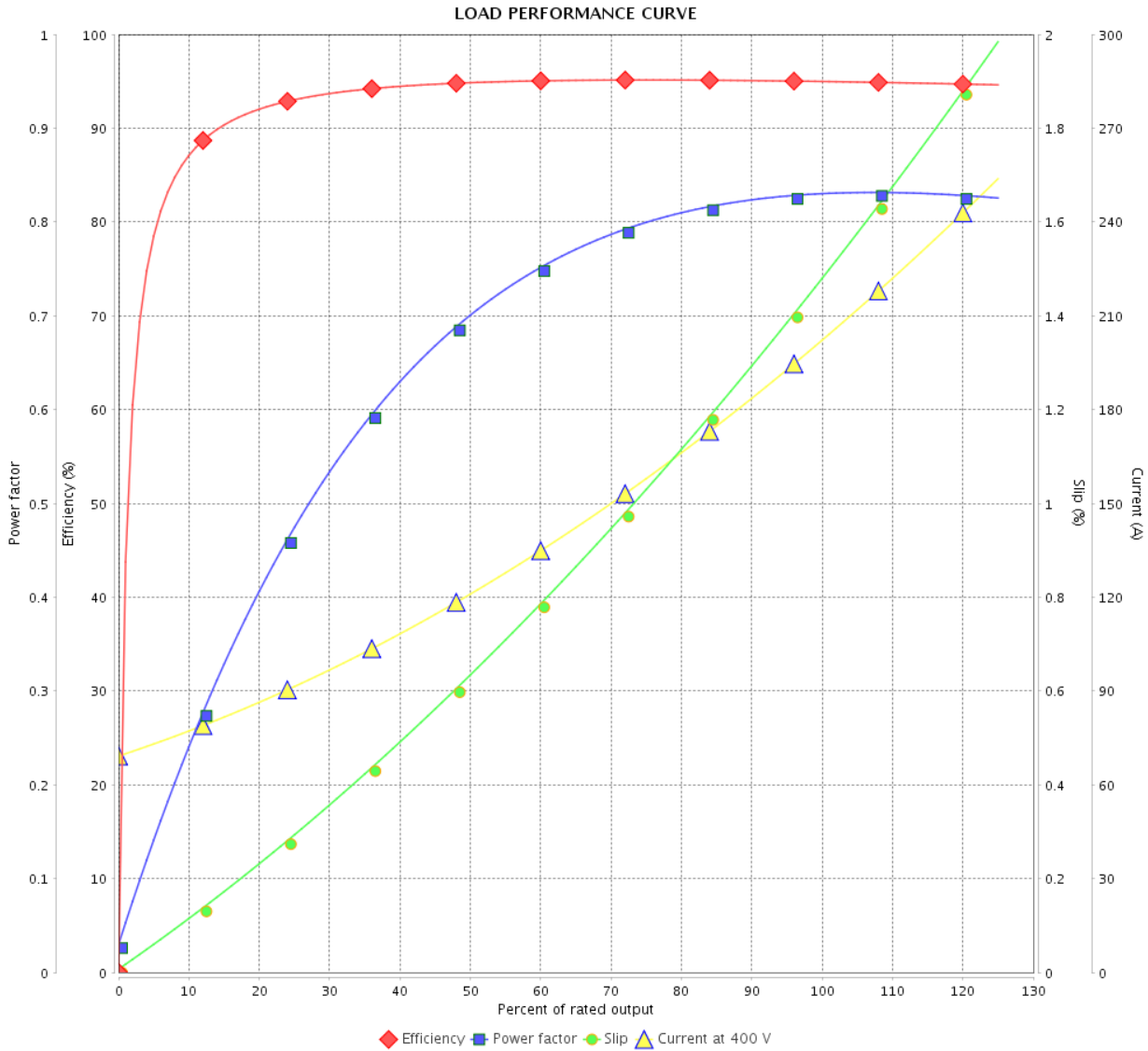

Performance : 400 V 50 Hz 6P IE2

Rated current : 201 A
 LRC : 5.4
 Rated torque : 800 ft.lb
 Locked rotor torque : 190 %
 Breakdown torque : 240 %
 Rated speed : 985 rpm

Moment of inertia (J) : 134 sq.ft.lb
 Duty cycle : Cont.(S1)
 Insulation class : F
 Service factor : 1.00
 Temperature rise : 105 K
 Design : B

Rev.	Changes Summary	Performed	Checked	Date
Performed by			Page 14 / 36	Revision
Checked by				
Date	13/04/2022			

LOAD PERFORMANCE CURVE

Three Phase Induction Motor - Squirrel Cage



Customer : _____

Product line : NEMA Premium Efficiency Three-Phase

Product code : 11584442

Catalog # : 15012ST3QIERB447T-W2

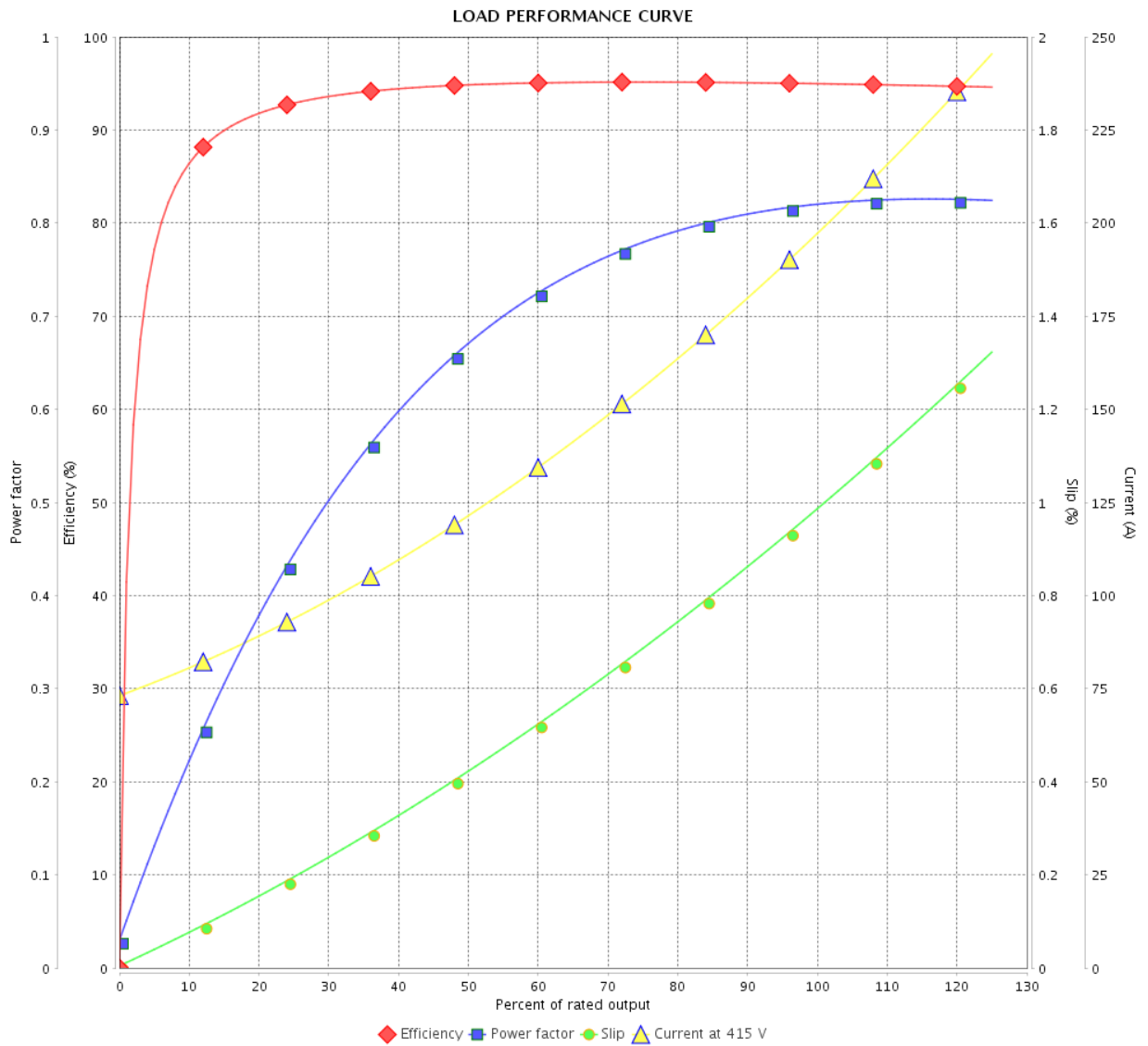

Performance : 415 V 50 Hz 6P IE2

Rated current : 196 A
 LRC : 5.9
 Rated torque : 796 ft.lb
 Locked rotor torque : 210 %
 Breakdown torque : 270 %
 Rated speed : 990 rpm

Moment of inertia (J) : 134 sq.ft.lb
 Duty cycle : Cont.(S1)
 Insulation class : F
 Service factor : 1.00
 Temperature rise : 105 K
 Design : B

Rev.	Changes Summary	Performed	Checked	Date
Performed by		Page		Revision
Checked by		15 / 36		
Date		13/04/2022		

THERMAL LIMIT CURVE

Three Phase Induction Motor - Squirrel Cage



Customer :

Product line : NEMA Premium Efficiency Three-Phase
Product code : 11584442
Catalog # : 15012ST3QIERB447T-W2

Performance : 460 V 60 Hz 6P

Rated current	: 176 A	Moment of inertia (J)	: 134 sq.ft.lb
LRC	: 6.1	Duty cycle	: Cont.(S1)
Rated torque	: 665 ft.lb	Insulation class	: F
Locked rotor torque	: 229 %	Service factor	: 1.15
Breakdown torque	: 250 %	Temperature rise	: 80 K
Rated speed	: 1185 rpm	Design	: B

Heating constant

Cooling constant

Rev.	Changes Summary	Performed	Checked	Date
Performed by				
Checked by			Page	Revision
Date	13/04/2022		16 / 36	

THERMAL LIMIT CURVE

Three Phase Induction Motor - Squirrel Cage



Customer : _____

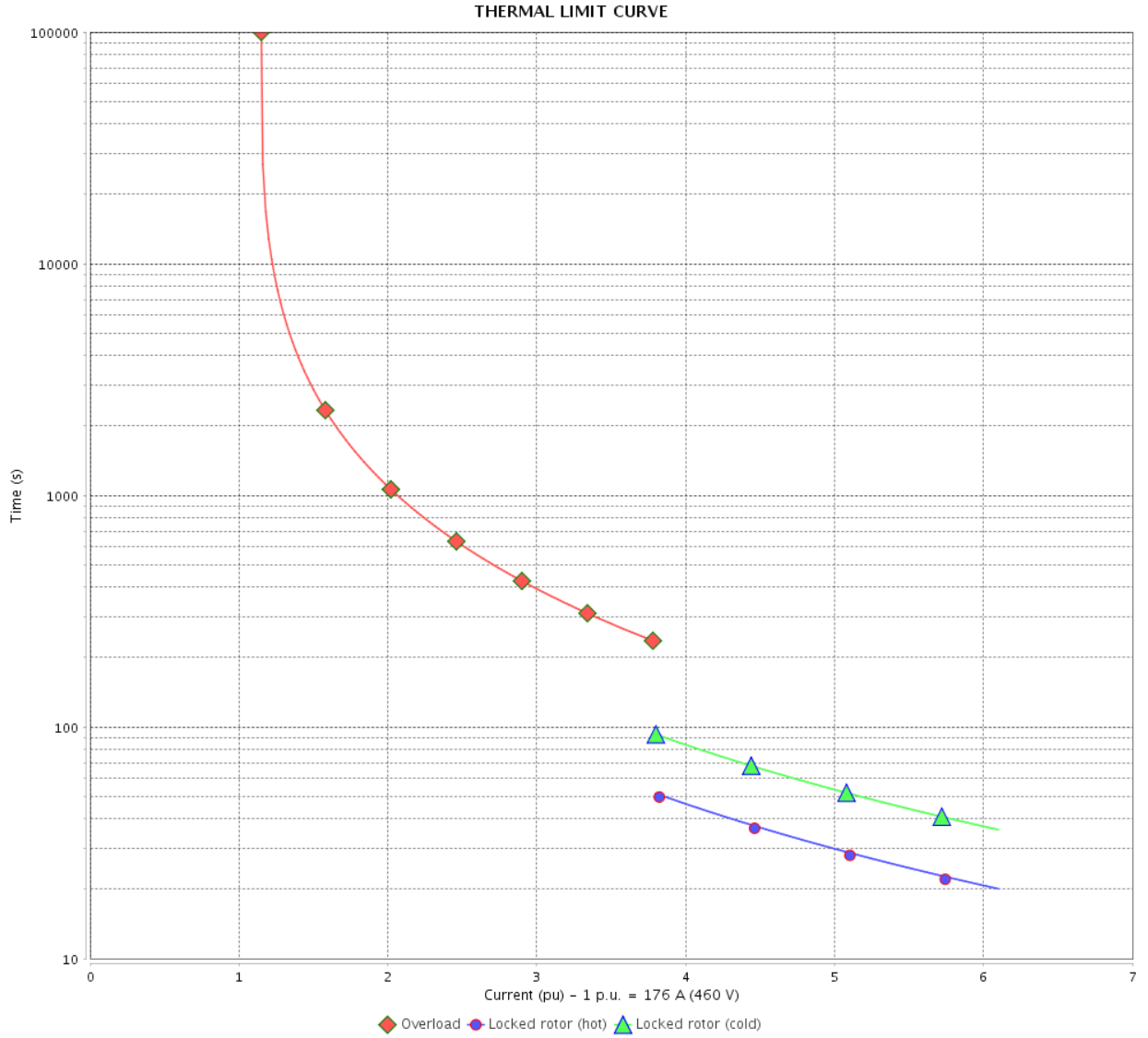

Rev.	Changes Summary	Performed	Checked	Date
Performed by		Page 17 / 36		Revision
Checked by				
Date				

THERMAL LIMIT CURVE

Three Phase Induction Motor - Squirrel Cage



Customer :

Product line : NEMA Premium Efficiency Three-Phase
Product code : 11584442
Catalog # : 15012ST3QIERB447T-W2

Performance : 380 V 50 Hz 6P IE3

Rated current	: 174 A	Moment of inertia (J)	: 134 sq.ft.lb
LRC	: 5.9	Duty cycle	: Cont.(S1)
Rated torque	: 666 ft.lb	Insulation class	: F
Locked rotor torque	: 210 %	Service factor	: 1.00
Breakdown torque	: 270 %	Temperature rise	: 105 K
Rated speed	: 985 rpm	Design	: B

Heating constant

Cooling constant

Rev.	Changes Summary	Performed	Checked	Date
Performed by				
Checked by			Page	Revision
Date	13/04/2022		18 / 36	

THERMAL LIMIT CURVE

Three Phase Induction Motor - Squirrel Cage



Customer : _____

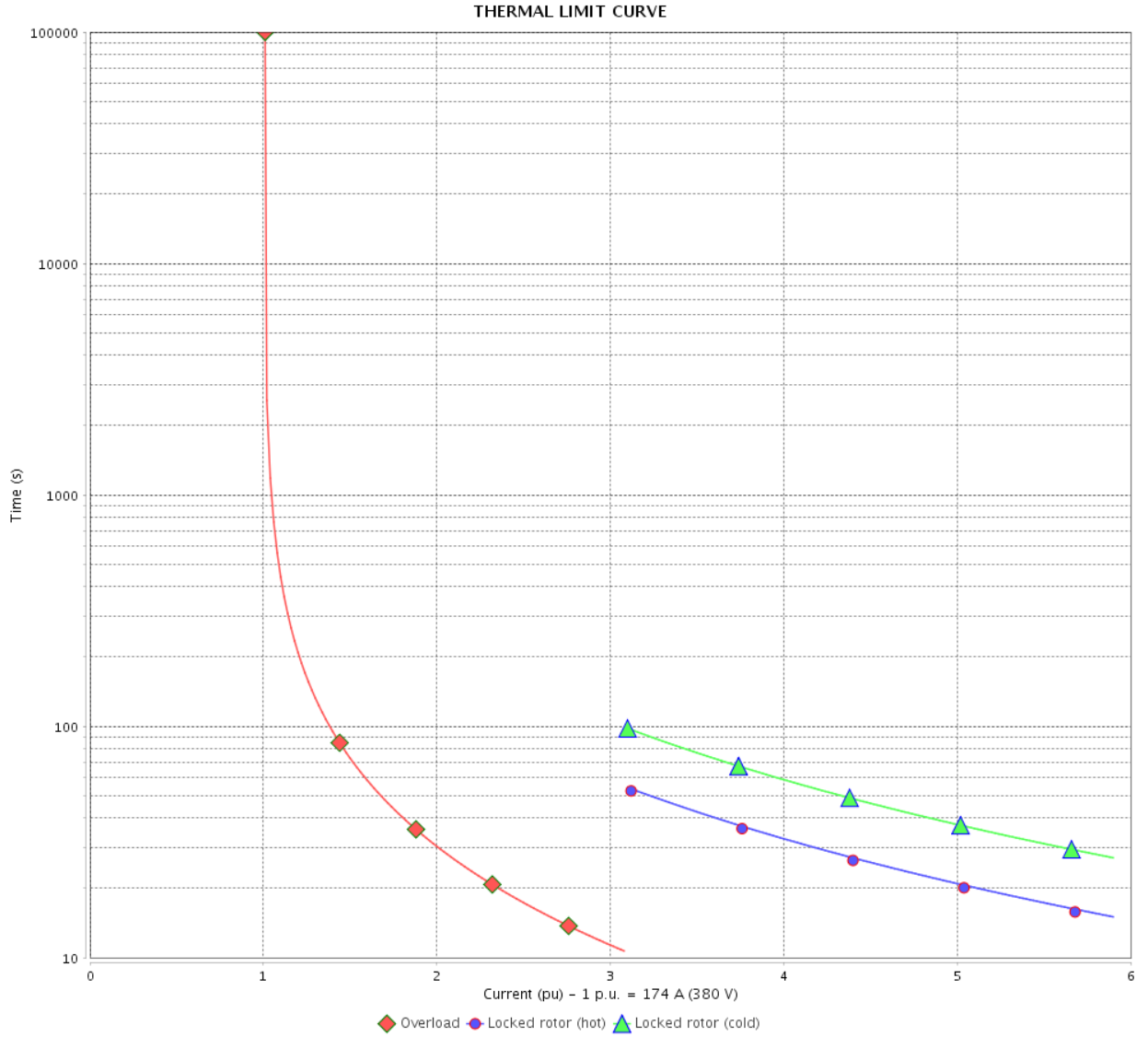

Rev.	Changes Summary	Performed	Checked	Date
Performed by		Page		Revision
Checked by		19 / 36		
Date		13/04/2022		

THERMAL LIMIT CURVE

Three Phase Induction Motor - Squirrel Cage



Customer :

Product line : NEMA Premium Efficiency Three-Phase
Product code : 11584442
Catalog # : 15012ST3QIERB447T-W2

Performance : 400 V 50 Hz 6P IE3

Rated current	: 167 A	Moment of inertia (J)	: 134 sq.ft.lb
LRC	: 6.4	Duty cycle	: Cont.(S1)
Rated torque	: 666 ft.lb	Insulation class	: F
Locked rotor torque	: 229 %	Service factor	: 1.00
Breakdown torque	: 290 %	Temperature rise	: 105 K
Rated speed	: 985 rpm	Design	: B

Heating constant

Cooling constant

Rev.	Changes Summary	Performed	Checked	Date
Performed by				
Checked by			Page	Revision
Date	13/04/2022		20 / 36	

THERMAL LIMIT CURVE

Three Phase Induction Motor - Squirrel Cage



Customer : _____

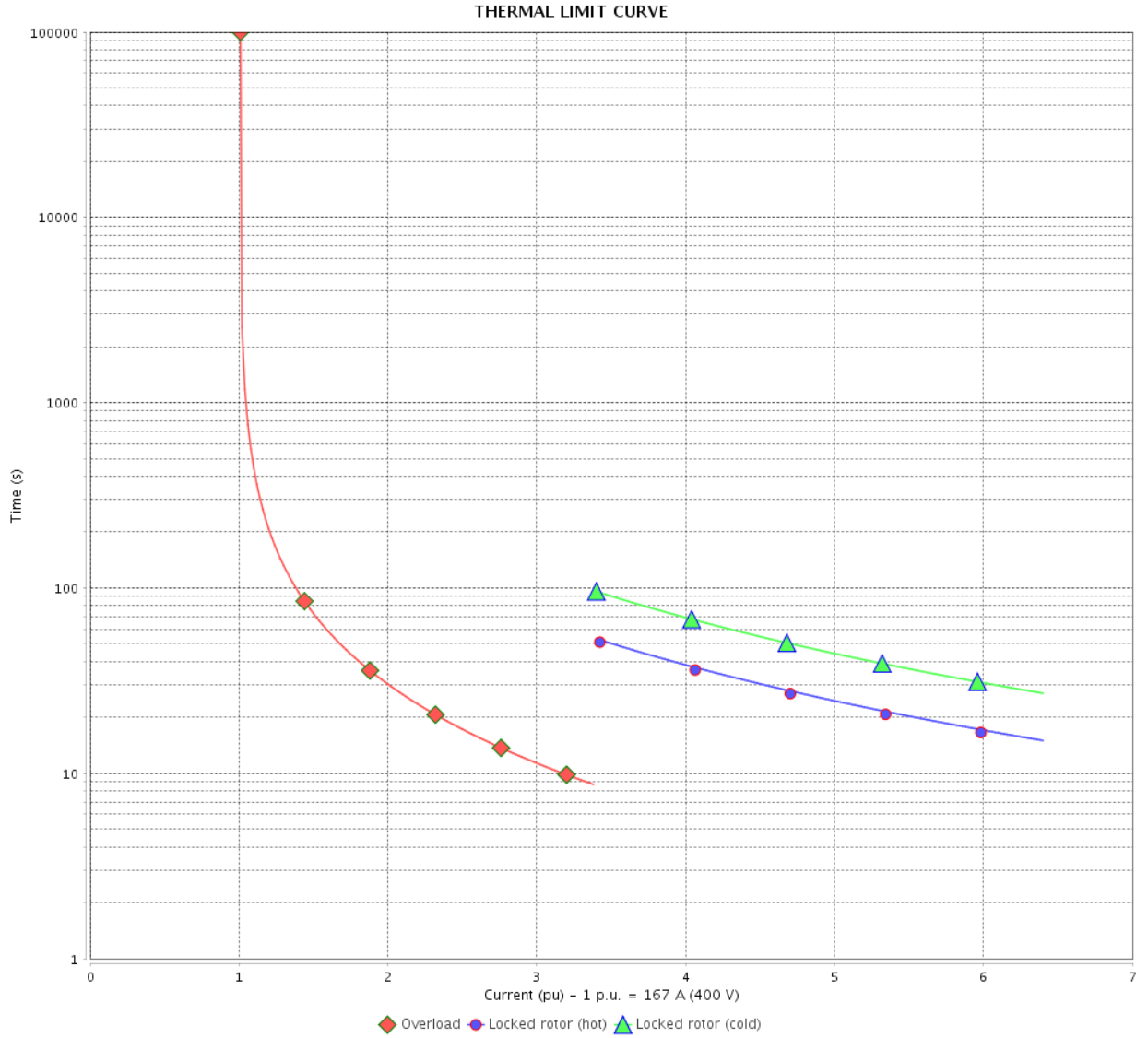

Rev.	Changes Summary	Performed	Checked	Date
Performed by		Page		Revision
Checked by		21 / 36		
Date		13/04/2022		

THERMAL LIMIT CURVE

Three Phase Induction Motor - Squirrel Cage



Customer :

Product line : NEMA Premium Efficiency Three-Phase
Product code : 11584442
Catalog # : 15012ST3QIERB447T-W2

Performance : 415 V 50 Hz 6P IE3

Rated current	: 165 A	Moment of inertia (J)	: 134 sq.ft.lb
LRC	: 6.9	Duty cycle	: Cont.(S1)
Rated torque	: 663 ft.lb	Insulation class	: F
Locked rotor torque	: 250 %	Service factor	: 1.00
Breakdown torque	: 330 %	Temperature rise	: 80 K
Rated speed	: 990 rpm	Design	: B

Heating constant

Cooling constant

Rev.	Changes Summary	Performed	Checked	Date
Performed by				
Checked by			Page	Revision
Date	13/04/2022		22 / 36	

THERMAL LIMIT CURVE

Three Phase Induction Motor - Squirrel Cage



Customer : _____

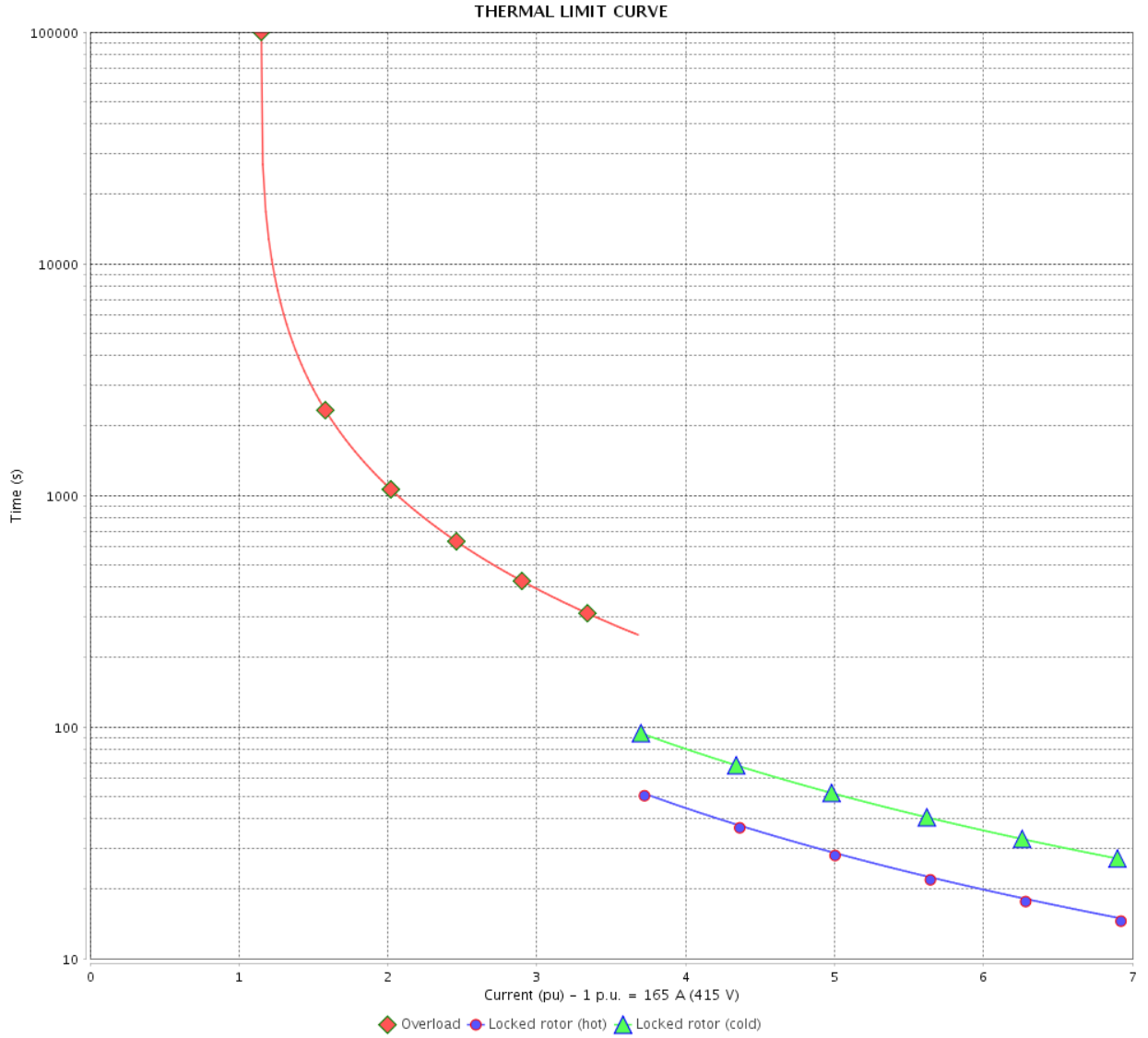

Rev.	Changes Summary	Performed	Checked	Date
Performed by		Page 23 / 36		Revision
Checked by				
Date				

THERMAL LIMIT CURVE

Three Phase Induction Motor - Squirrel Cage



Customer :

Product line : NEMA Premium Efficiency Three-Phase
Product code : 11584442
Catalog # : 15012ST3QIERB447T-W2

Performance : 380 V 50 Hz 6P IE2

Rated current	: 211 A	Moment of inertia (J)	: 134 sq.ft.lb
LRC	: 4.9	Duty cycle	: Cont.(S1)
Rated torque	: 800 ft.lb	Insulation class	: F
Locked rotor torque	: 170 %	Service factor	: 1.00
Breakdown torque	: 220 %	Temperature rise	: 105 K
Rated speed	: 985 rpm	Design	: B

Heating constant

Cooling constant

Rev.	Changes Summary	Performed	Checked	Date
Performed by				
Checked by			Page	Revision
Date	13/04/2022		24 / 36	

THERMAL LIMIT CURVE

Three Phase Induction Motor - Squirrel Cage



Customer : _____

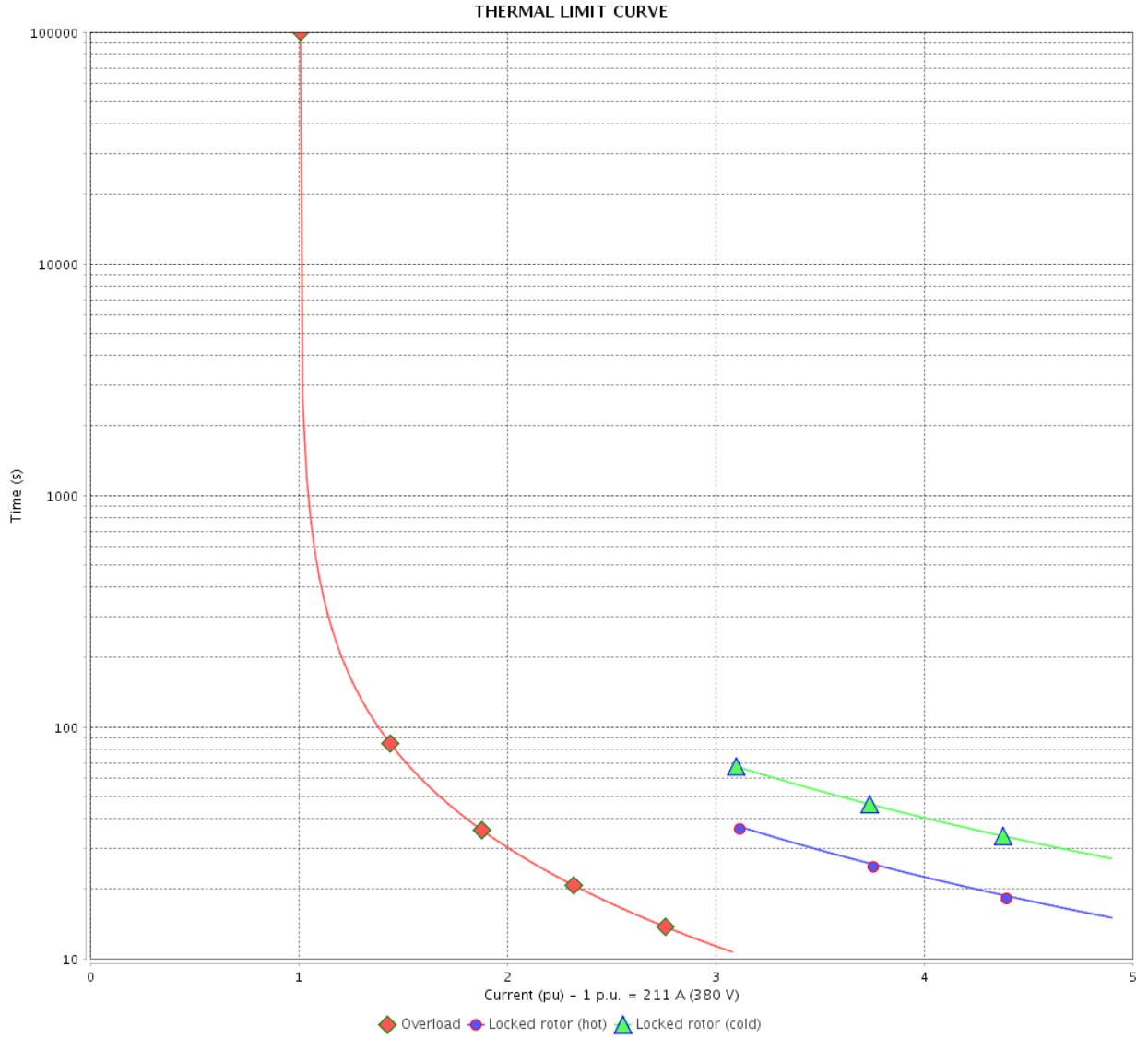

Rev.	Changes Summary	Performed	Checked	Date
Performed by				
Checked by				
Date				
			Page	Revision
			25 / 36	

THERMAL LIMIT CURVE

Three Phase Induction Motor - Squirrel Cage



Customer :

Product line : NEMA Premium Efficiency Three-Phase
Product code : 11584442
Catalog # : 15012ST3QIERB447T-W2

Performance : 400 V 50 Hz 6P IE2

Rated current	: 201 A	Moment of inertia (J)	: 134 sq.ft.lb
LRC	: 5.4	Duty cycle	: Cont.(S1)
Rated torque	: 800 ft.lb	Insulation class	: F
Locked rotor torque	: 190 %	Service factor	: 1.00
Breakdown torque	: 240 %	Temperature rise	: 105 K
Rated speed	: 985 rpm	Design	: B

Heating constant

Cooling constant

Rev.	Changes Summary	Performed	Checked	Date
Performed by				
Checked by			Page	Revision
Date	13/04/2022		26 / 36	

THERMAL LIMIT CURVE

Three Phase Induction Motor - Squirrel Cage



Customer : _____

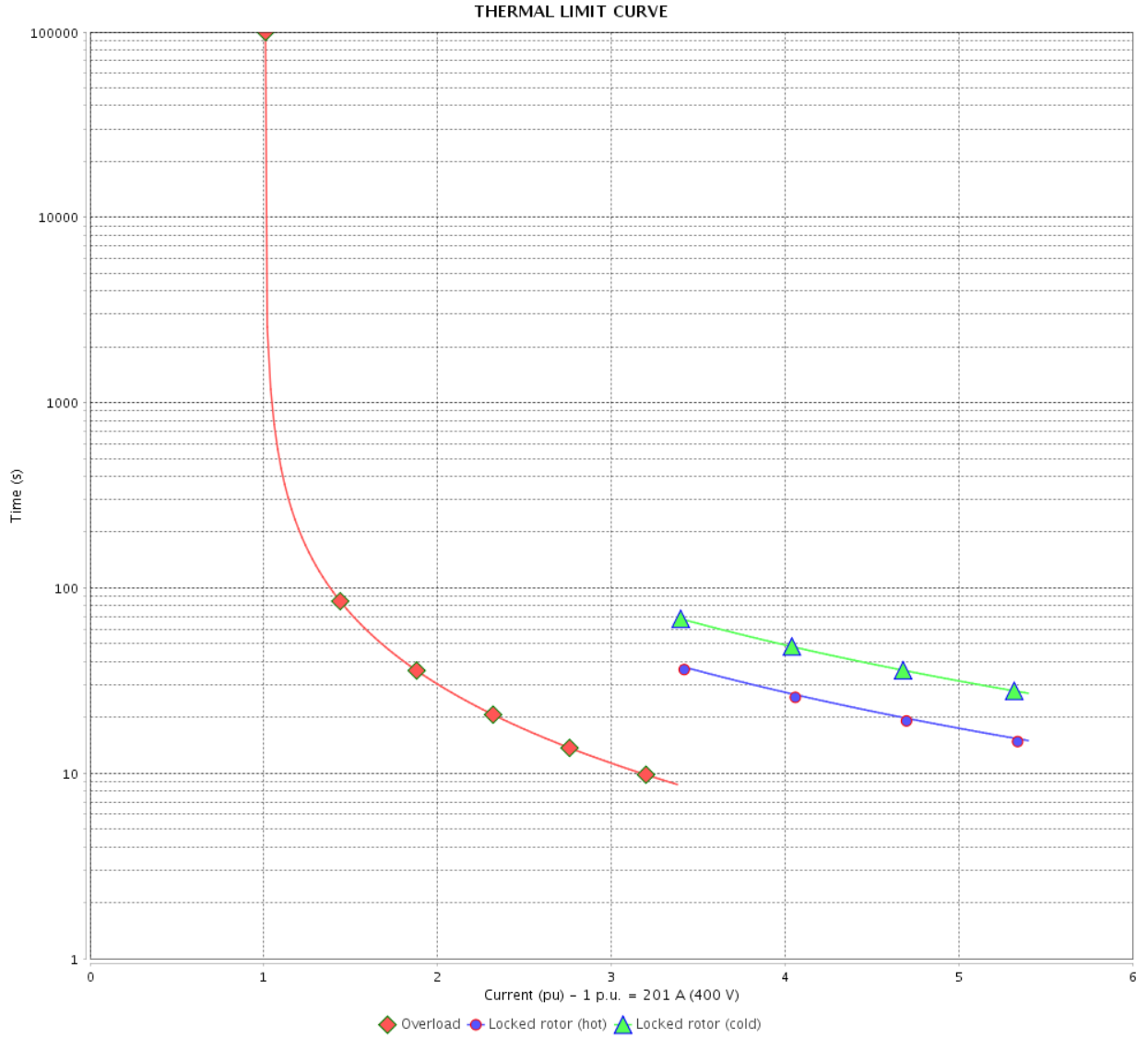

Rev.	Changes Summary	Performed	Checked	Date
Performed by		Page		Revision
Checked by		27 / 36		
Date		13/04/2022		

THERMAL LIMIT CURVE



Three Phase Induction Motor - Squirrel Cage

Customer :

Product line : NEMA Premium Efficiency Three-Phase
Product code : 11584442
Catalog # : 15012ST3QIERB447T-W2

Performance : 415 V 50 Hz 6P IE2

Rated current	: 196 A	Moment of inertia (J)	: 134 sq.ft.lb
LRC	: 5.9	Duty cycle	: Cont.(S1)
Rated torque	: 796 ft.lb	Insulation class	: F
Locked rotor torque	: 210 %	Service factor	: 1.00
Breakdown torque	: 270 %	Temperature rise	: 105 K
Rated speed	: 990 rpm	Design	: B

Heating constant

Cooling constant

Rev.	Changes Summary	Performed	Checked	Date
Performed by				
Checked by			Page	Revision
Date	13/04/2022		28 / 36	

THERMAL LIMIT CURVE

Three Phase Induction Motor - Squirrel Cage



Customer : _____

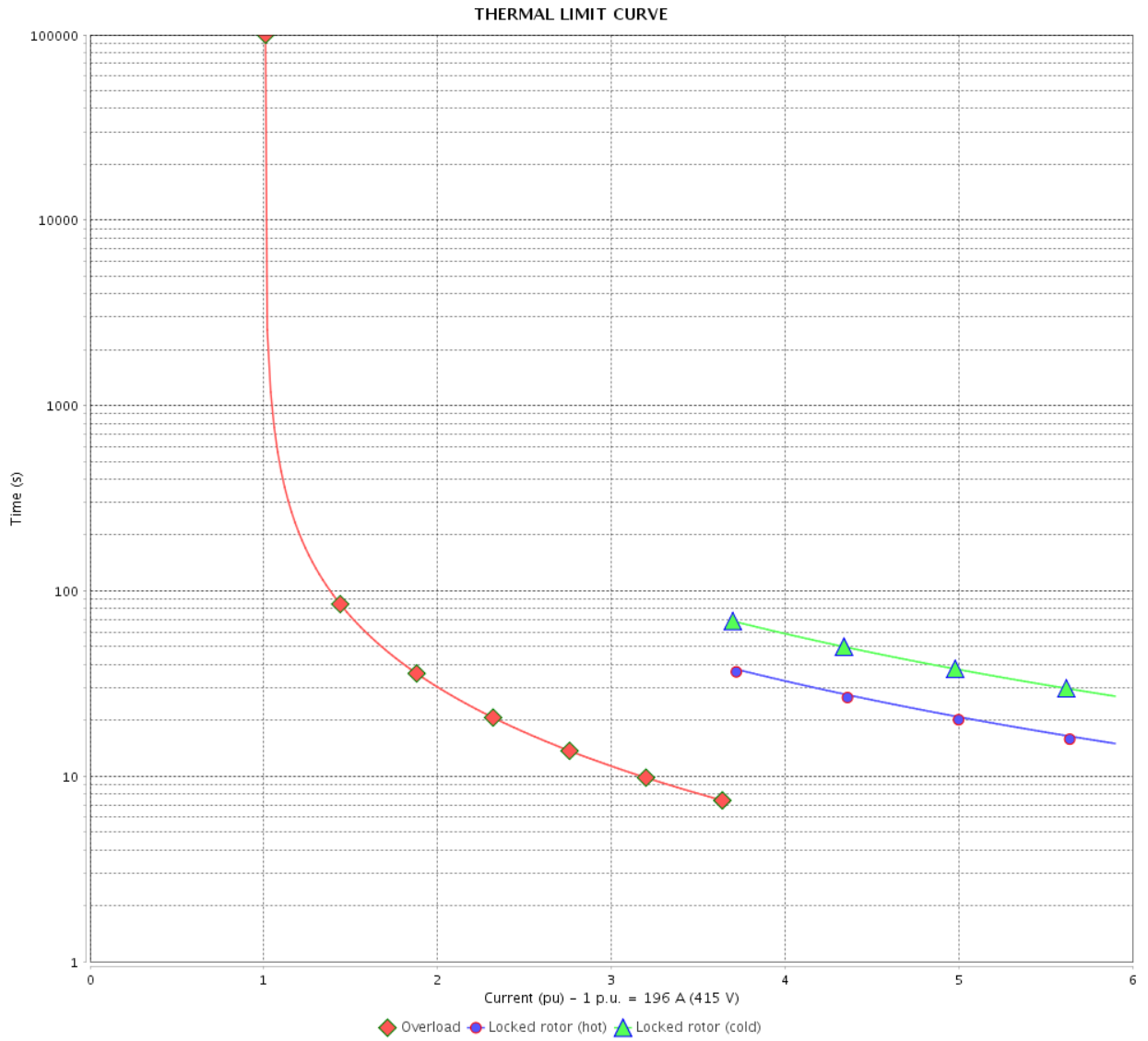

Rev.	Changes Summary	Performed	Checked	Date
Performed by				
Checked by				
Date				
			Page	Revision
			29 / 36	

VFD OPERATION CURVE

Three Phase Induction Motor - Squirrel Cage



Customer :

Product line : NEMA Premium Efficiency Three-Phase

Product code : 11584442

Catalog # : 15012ST3QIERB447T-W2

VFD OPERATION CURVE

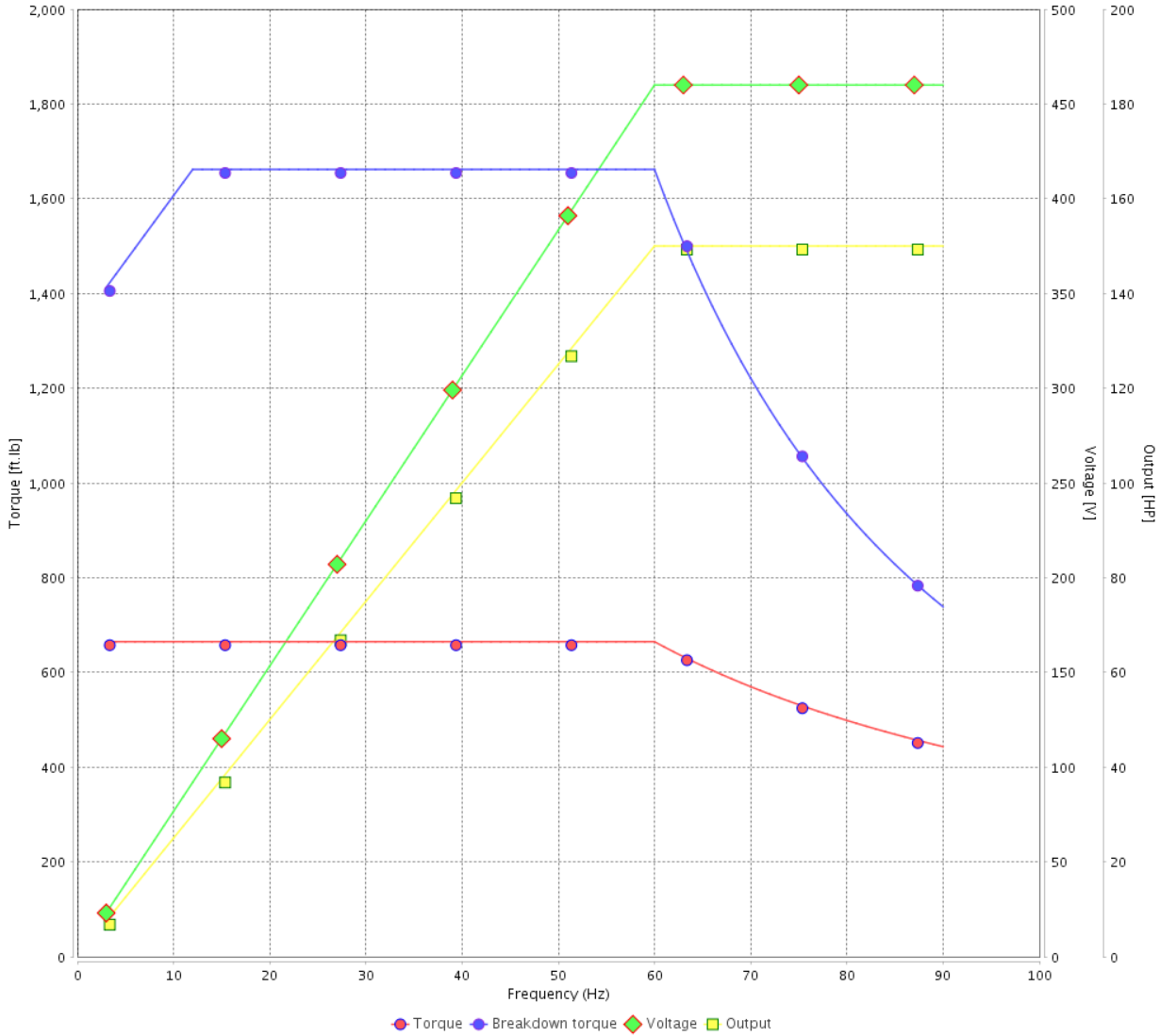

Performance : 460 V 60 Hz 6P

Rated current : 176 A
 LRC : 6.1
 Rated torque : 665 ft.lb
 Locked rotor torque : 229 %
 Breakdown torque : 250 %
 Rated speed : 1185 rpm

Moment of inertia (J) : 134 sq.ft.lb
 Duty cycle : Cont.(S1)
 Insulation class : F
 Service factor : 1.15
 Temperature rise : 80 K
 Design : B

Rev.	Changes Summary	Performed	Checked	Date
Performed by			Page	Revision
Checked by				
Date				

VFD OPERATION CURVE

Three Phase Induction Motor - Squirrel Cage



Customer :

Product line : NEMA Premium Efficiency Three-Phase

Product code : 11584442

Catalog # : 15012ST3QIERB447T-W2

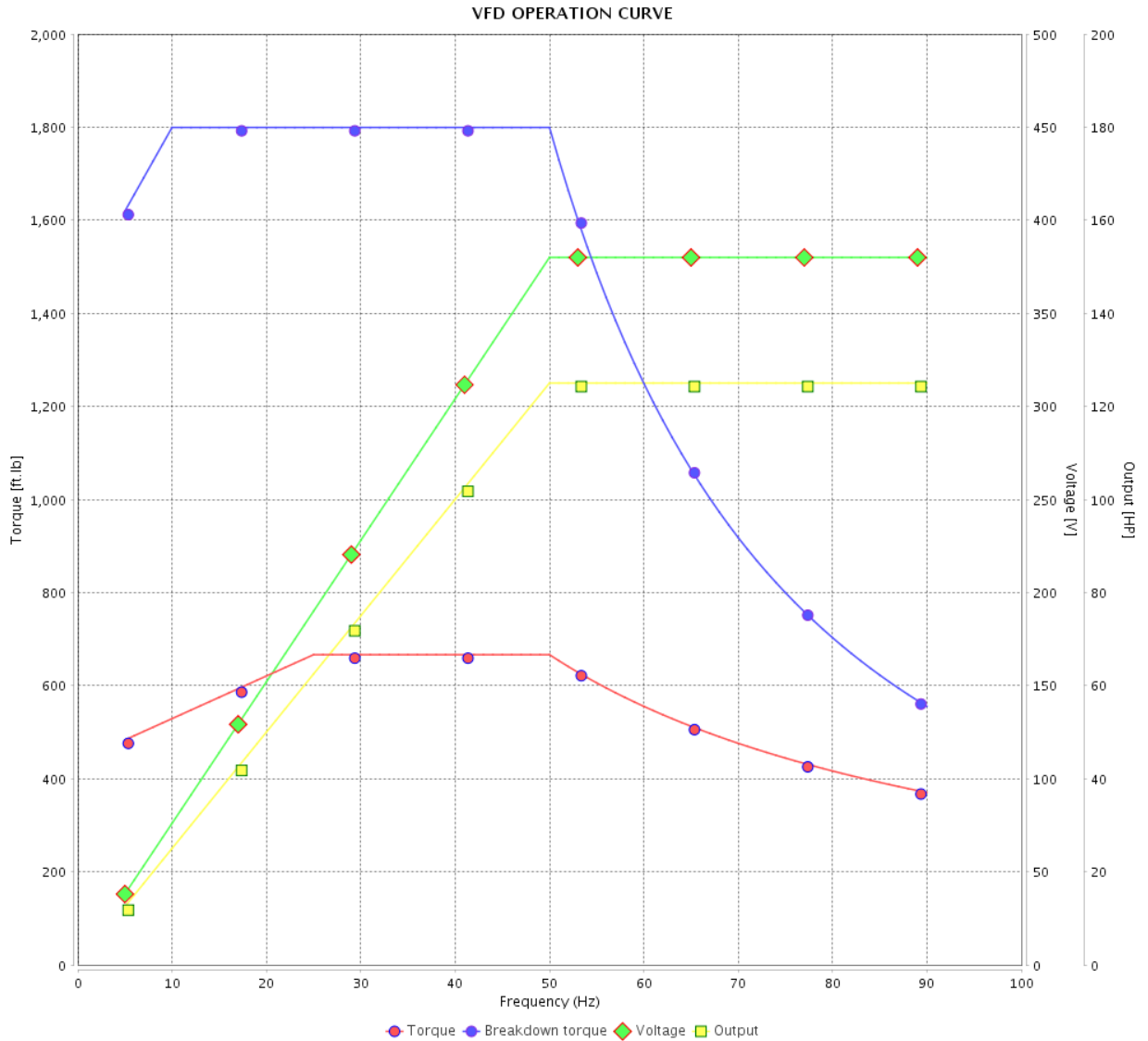

Performance : 380 V 50 Hz 6P IE3

Rated current : 174 A
 LRC : 5.9
 Rated torque : 666 ft.lb
 Locked rotor torque : 210 %
 Breakdown torque : 270 %
 Rated speed : 985 rpm

Moment of inertia (J) : 134 sq.ft.lb
 Duty cycle : Cont.(S1)
 Insulation class : F
 Service factor : 1.00
 Temperature rise : 105 K
 Design : B

Rev.	Changes Summary	Performed	Checked	Date
Performed by				Page 31 / 36
Checked by				
Date	13/04/2022			

VFD OPERATION CURVE

Three Phase Induction Motor - Squirrel Cage



Customer :

Product line : NEMA Premium Efficiency Three-Phase

Product code : 11584442

Catalog # : 15012ST3QIERB447T-W2

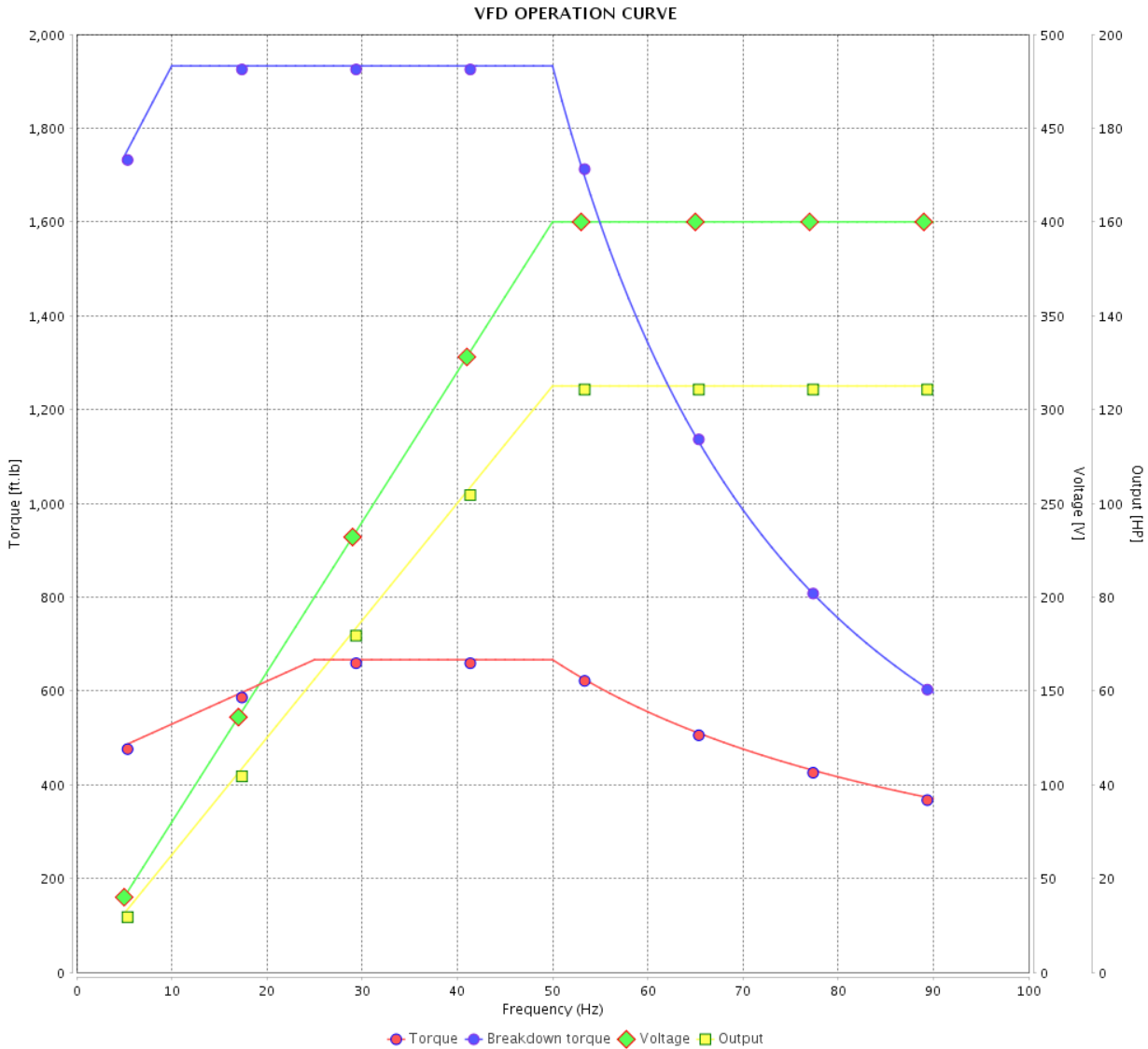

Performance : 400 V 50 Hz 6P IE3

Rated current	: 167 A	Moment of inertia (J)	: 134 sq.ft.lb
LRC	: 6.4	Duty cycle	: Cont.(S1)
Rated torque	: 666 ft.lb	Insulation class	: F
Locked rotor torque	: 229 %	Service factor	: 1.00
Breakdown torque	: 290 %	Temperature rise	: 105 K
Rated speed	: 985 rpm	Design	: B

Rev.	Changes Summary	Performed	Checked	Date
Performed by		Page		Revision
Checked by		32 / 36		
Date	13/04/2022			

VFD OPERATION CURVE

Three Phase Induction Motor - Squirrel Cage



Customer : _____

Product line : NEMA Premium Efficiency Three-Phase

Product code : 11584442

Catalog # : 15012ST3QIERB447T-W2

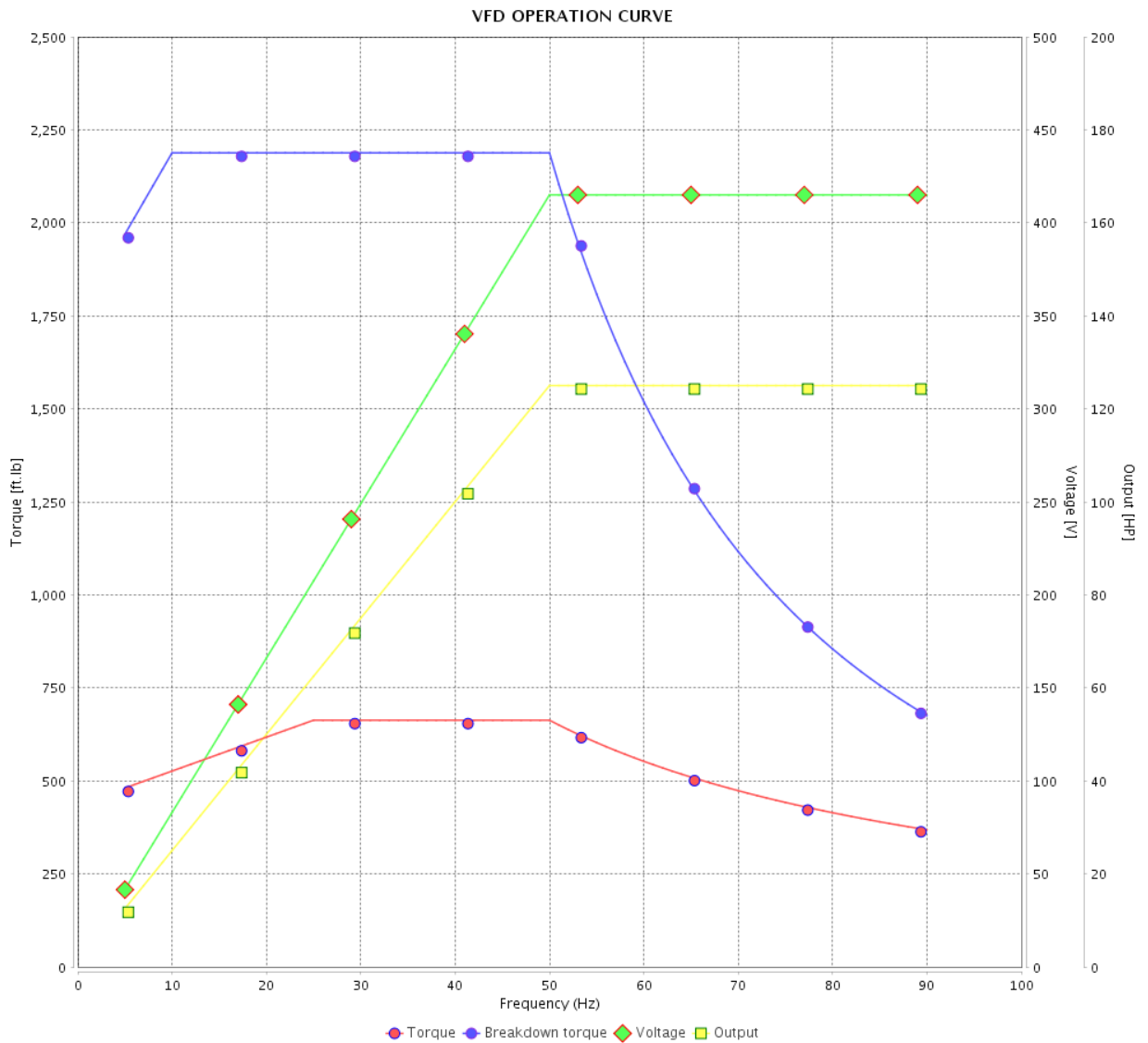

Performance : 415 V 50 Hz 6P IE3

Rated current : 165 A
 LRC : 6.9
 Rated torque : 663 ft.lb
 Locked rotor torque : 250 %
 Breakdown torque : 330 %
 Rated speed : 990 rpm

Moment of inertia (J) : 134 sq.ft.lb
 Duty cycle : Cont.(S1)
 Insulation class : F
 Service factor : 1.00
 Temperature rise : 80 K
 Design : B

Rev.	Changes Summary	Performed	Checked	Date
Performed by		Page		Revision
Checked by		33 / 36		
Date		13/04/2022		

VFD OPERATION CURVE

Three Phase Induction Motor - Squirrel Cage



Customer :

Product line : NEMA Premium Efficiency Three-Phase

Product code : 11584442

Catalog # : 15012ST3QIERB447T-W2

VFD OPERATION CURVE

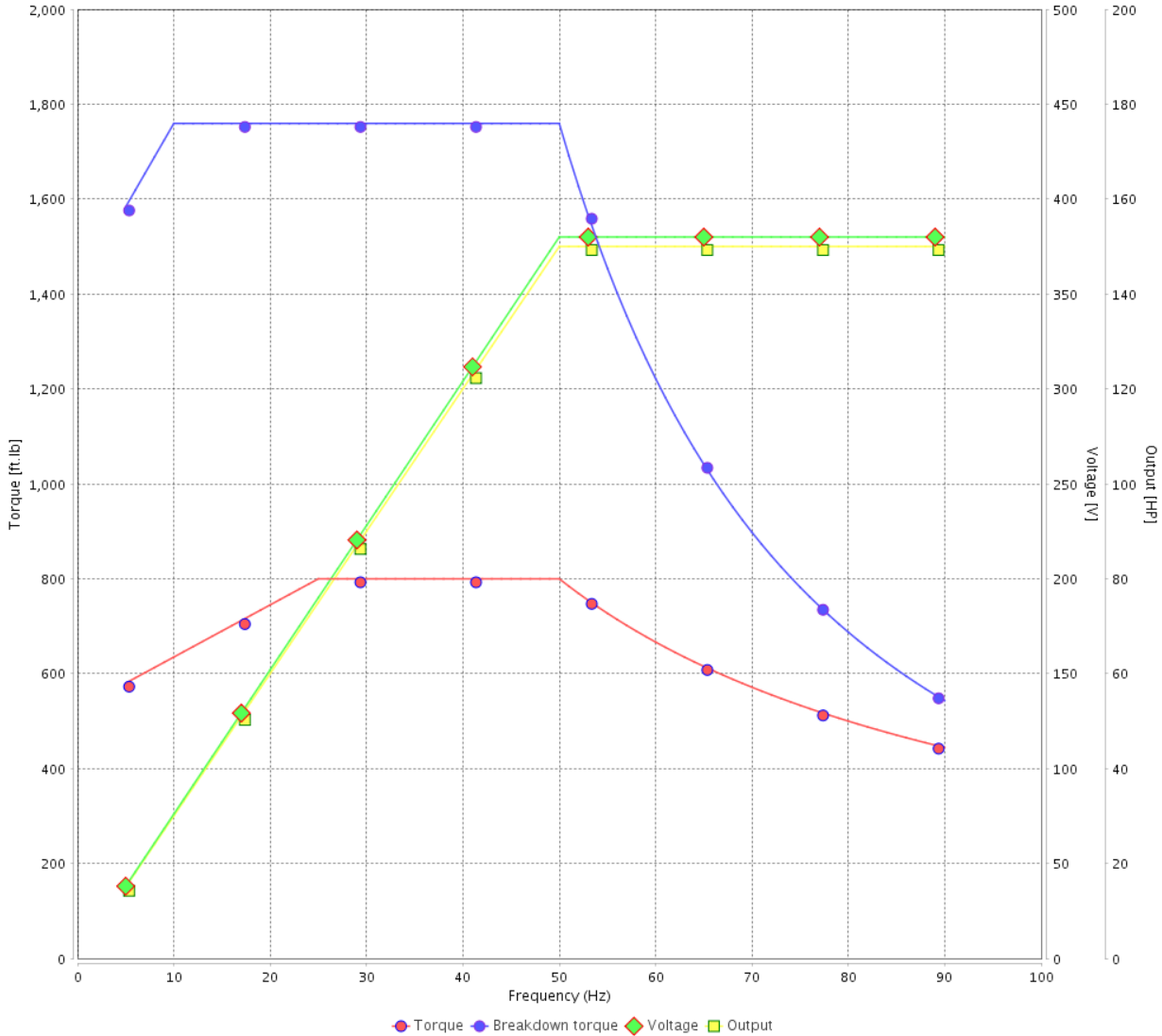

Performance : 380 V 50 Hz 6P IE2

Rated current	: 211 A	Moment of inertia (J)	: 134 sq.ft.lb
LRC	: 4.9	Duty cycle	: Cont.(S1)
Rated torque	: 800 ft.lb	Insulation class	: F
Locked rotor torque	: 170 %	Service factor	: 1.00
Breakdown torque	: 220 %	Temperature rise	: 105 K
Rated speed	: 985 rpm	Design	: B

Rev.	Changes Summary	Performed	Checked	Date
Performed by			Page	Revision
Checked by			34 / 36	
Date	13/04/2022			

VFD OPERATION CURVE

Three Phase Induction Motor - Squirrel Cage



Customer : _____

Product line : NEMA Premium Efficiency Three-Phase

Product code : 11584442

Catalog # : 15012ST3QIERB447T-W2

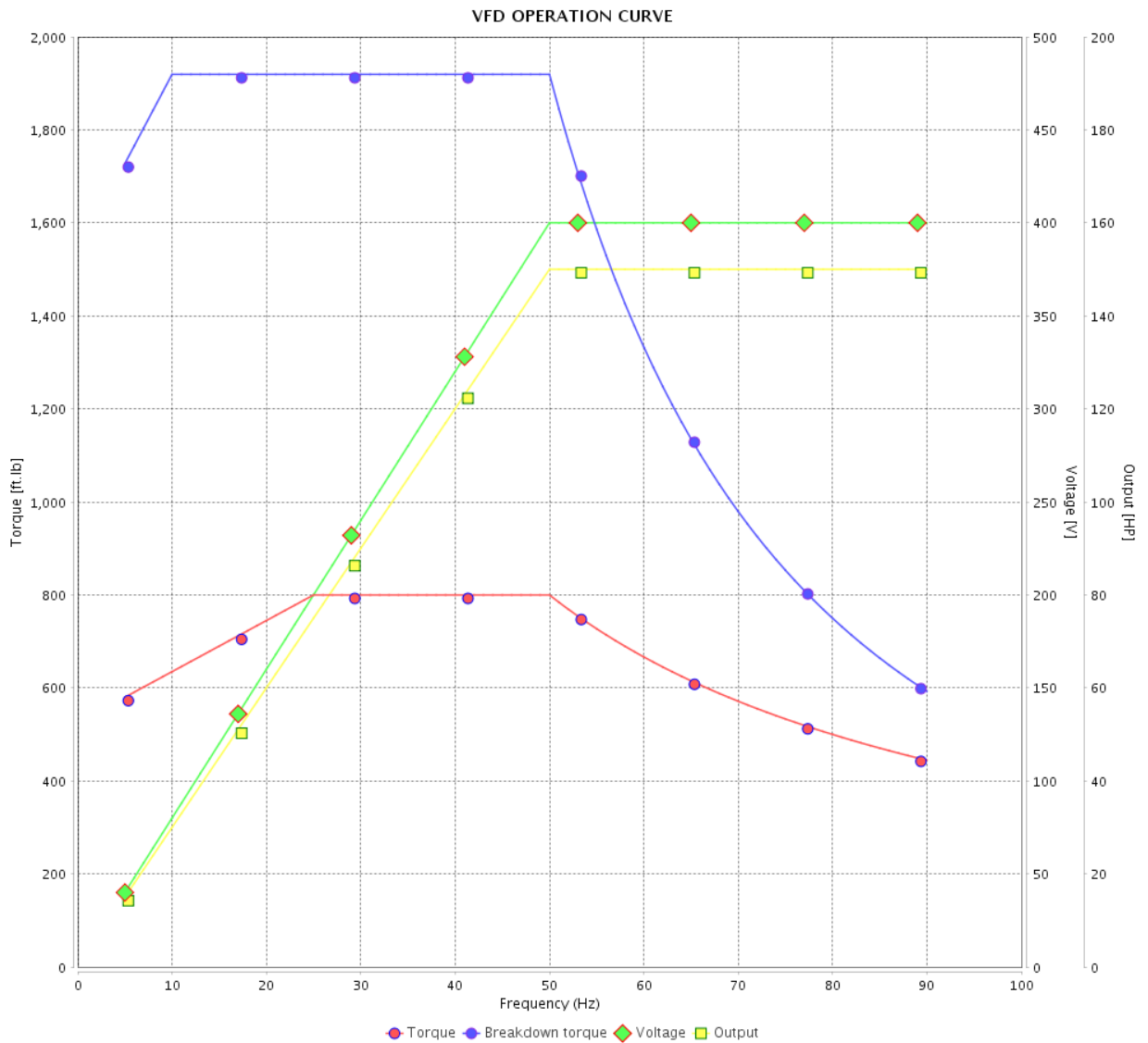

Performance : 400 V 50 Hz 6P IE2

Rated current : 201 A
 LRC : 5.4
 Rated torque : 800 ft.lb
 Locked rotor torque : 190 %
 Breakdown torque : 240 %
 Rated speed : 985 rpm

Moment of inertia (J) : 134 sq.ft.lb
 Duty cycle : Cont.(S1)
 Insulation class : F
 Service factor : 1.00
 Temperature rise : 105 K
 Design : B

Rev.	Changes Summary	Performed	Checked	Date
Performed by			Page 35 / 36	Revision
Checked by				
Date	13/04/2022			

VFD OPERATION CURVE

Three Phase Induction Motor - Squirrel Cage



Customer :

Product line : NEMA Premium Efficiency Three-Phase

Product code : 11584442

Catalog # : 15012ST3QIERB447T-W2

VFD OPERATION CURVE

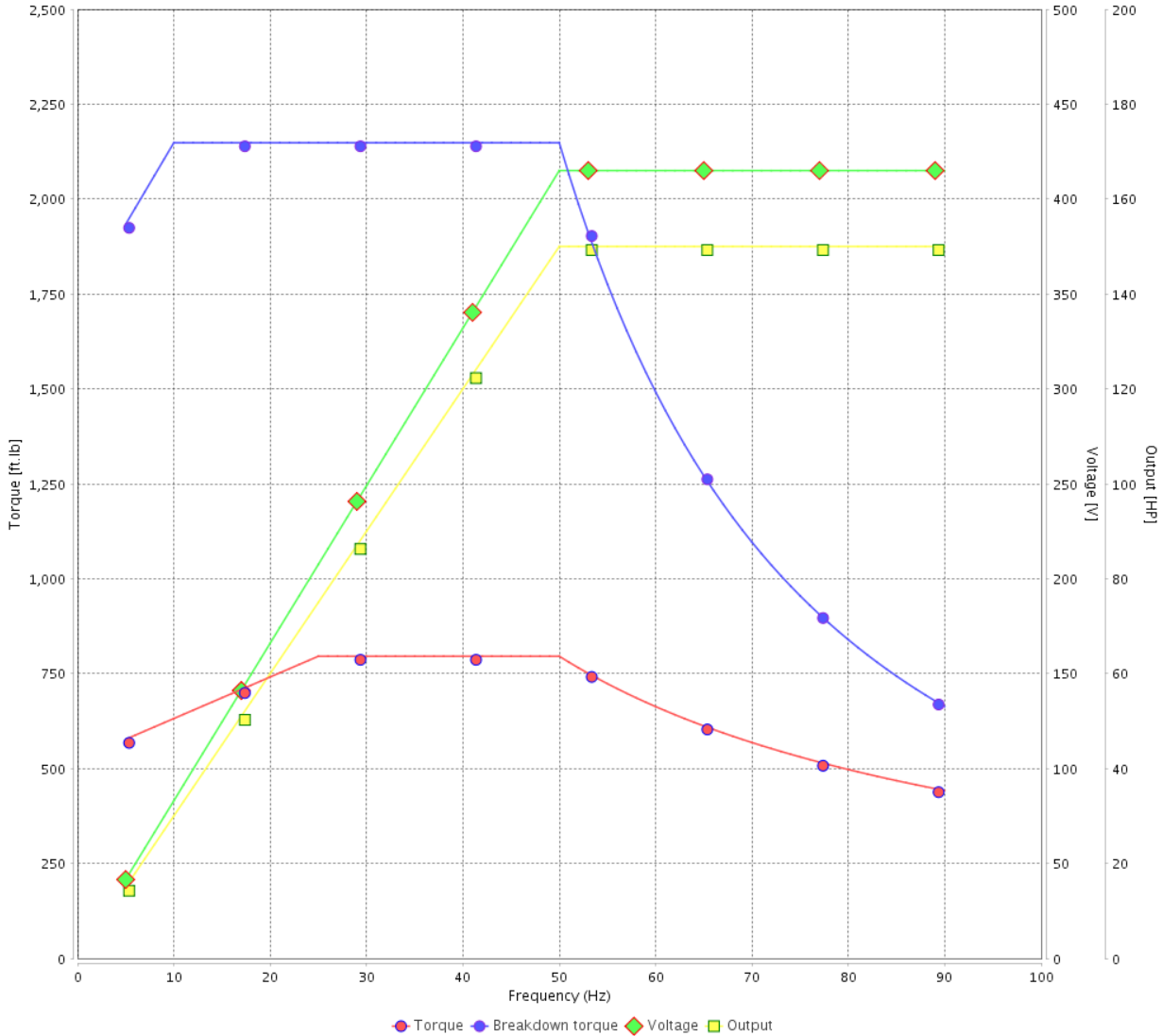

Performance : 415 V 50 Hz 6P IE2

Rated current	: 196 A	Moment of inertia (J)	: 134 sq.ft.lb
LRC	: 5.9	Duty cycle	: Cont.(S1)
Rated torque	: 796 ft.lb	Insulation class	: F
Locked rotor torque	: 210 %	Service factor	: 1.00
Breakdown torque	: 270 %	Temperature rise	: 105 K
Rated speed	: 990 rpm	Design	: B

Rev.	Changes Summary	Performed	Checked	Date
Performed by			Page	Revision
Checked by			36 / 36	
Date	13/04/2022			

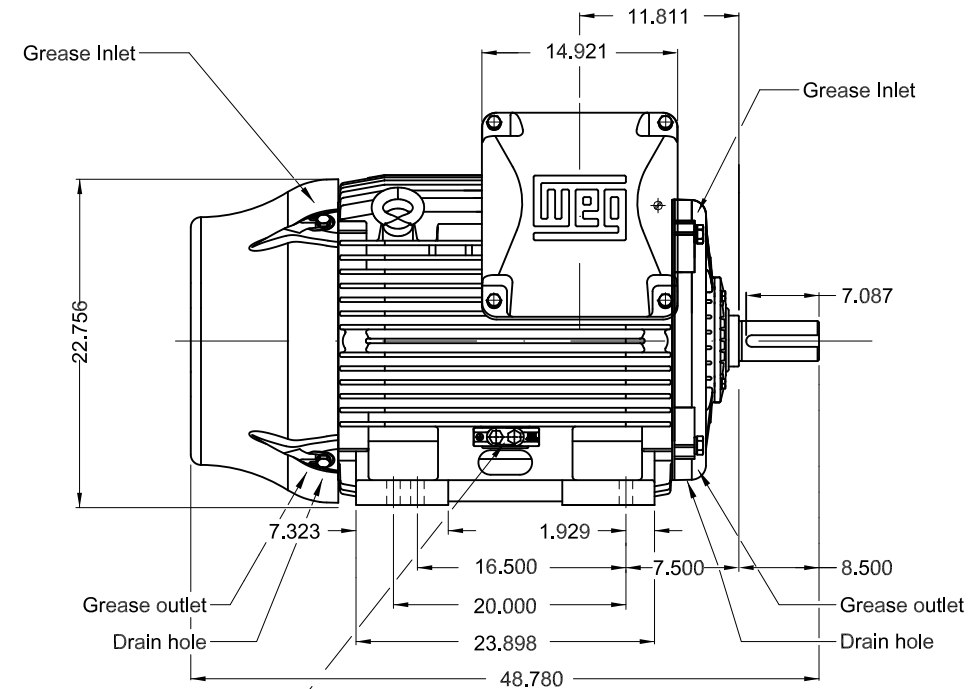
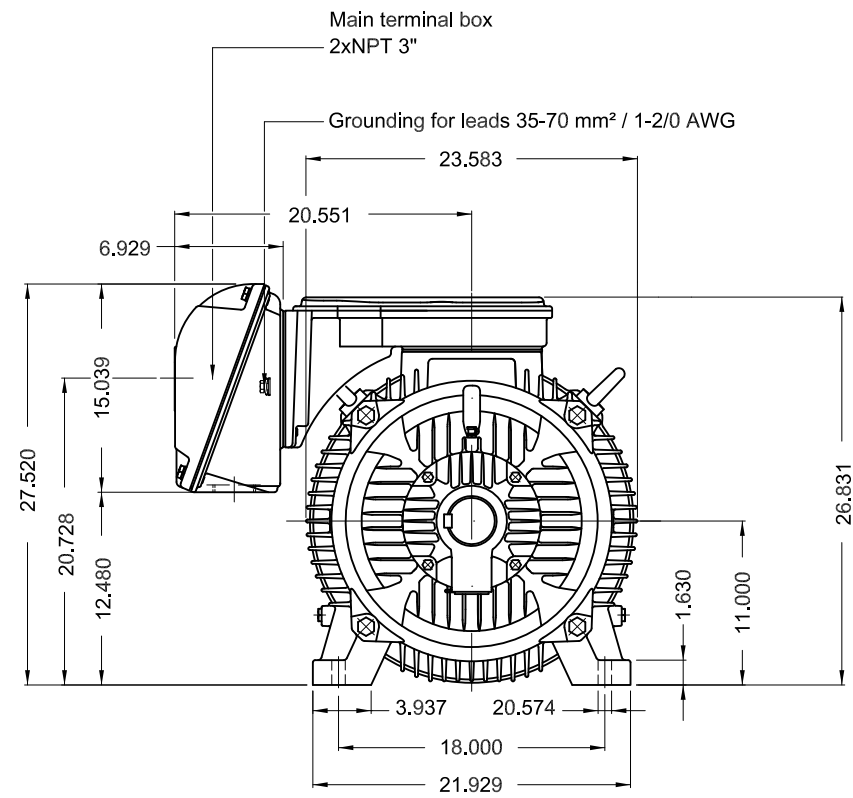

Grounding for leads 25-185 mm² / 3AWG-350MCM

150 HP 06 Poles 60 Hz

A

- Bronze fan
- DE roller bearing
- Shaft locking device
- Color RAL 5009
- Painting plan 202E
- Mounting NEMA F-1
- Mounting B3R(D)

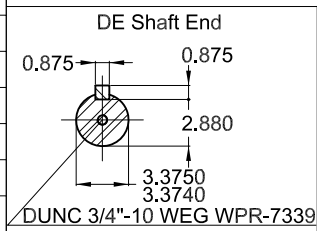

ECM	LOC	SUMMARY OF MODIFICATIONS	EXECUTED	CHECKED	RELEASED	DATE	VER
EXECUTED	PIRWBUSER	THREE PH. MOTOR IEEE 841 W22 PREM. EFF.					
CHECKED		FRAME 445/7T IP55 TEFC					
RELEASED							
REL DT.	WMO	Jaragua do Sul	Product Engineering				

PREVIEW
WDD



SHEET 1 / 1

Dimensions in inches

XME A3



NEMA
Premium
W22



FOR SAFE AREA
Mod.TE1BFOXON
CC029A



Class I, Div 2, Gr A, B, C and D - T3
Class I, Zone 2, IIC - T3
Class II, Div 2, Gr F and G - T3C
For use on PWM: Gr. A, B, C, D and F,
VT 1000:1, CT 20:1, 1.00SF - T3

MODEL 15012ST3QIERB447T-W2



Inverter Duty Motor
Severe Duty

MADE IN BRAZIL
11584442

PH3 60Hz Fr. 445/7T 1000m.a.s.l. IP55 TEFC 2354lb

V 460

A 176

HP 150

kW 110

SF 1.15

SFA 202

RPM 1185

PF 0.82

AMB 40°C

INS cl. F DT80K

NEMA NOM EFF 95.8%

DUTY CONT.

DES B Code G

GUARANT. EFF 95.0%

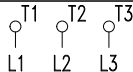

460V



→ NU-319-C3 (45g) 95RU03X30

→ 6316-C3 (34g) 80BC03X30



MOBIL POLYREX EM (9000h)

