

DATA SHEET



Three Phase Induction Motor - Squirrel Cage

Customer							
Product line	: NEMA Premium Efficiency Three-Phase			Product code :	11536355		
				Catalog # :	15018ET3E445T-W22		
Frame	: 444/5T			Cooling method	: IC411 - TEFC		
Insulation class	: F			Mounting	: F-1		
Duty cycle	: Cont.(S1)			Rotation ¹	: Both (CW and CCW)		
Ambient temperature	: -20°C to +40°C			Starting method	: Direct On Line		
Altitude	: 1000 m.a.s.l.			Approx. weight ²	: 1856 lb		
Protection degree	: IP55			Moment of inertia (J)	: 66.7 sq.ft.lb		
Design	: B						
Output [HP]	150	125	125	125	150	150	150
Poles	4	4	4	4	4	4	4
Frequency [Hz]	60	50	50	50	50	50	50
Rated voltage [V]	230/460	380	400	415	380	400	415
Rated current [A]	340/170	170	163	159	205	194	189
L. R. Amperes [A]	2244/1122	1190	1127	1192	1189	1125	1191
LRC [A]	6.6x(Code G)	7.0x(Code G)	6.9x(Code G)	7.5x(Code H)	5.8x(Code F)	5.8x(Code F)	6.3x(Code G)
No load current [A]	116/58.0	58.0	61.2	64.0	58.0	61.2	64.0
Rated speed [RPM]	1780	1480	1480	1480	1475	1475	1480
Slip [%]	1.11	1.33	1.33	1.33	1.67	1.67	1.33
Rated torque [ft.lb]	443	444	444	444	534	534	532
Locked rotor torque [%]	200	190	220	229	160	180	190
Breakdown torque [%]	250	240	260	290	200	220	240
Service factor	1.15	1.00	1.00	1.00	1.00	1.00	1.00
Temperature rise	80 K	80 K	80 K	80 K	105 K	105 K	105 K
Locked rotor time	48s (cold) 27s (hot)	32s (cold) 18s (hot)	32s (cold) 18s (hot)	32s (cold) 18s (hot)	32s (cold) 18s (hot)	32s (cold) 18s (hot)	32s (cold) 18s (hot)
Noise level ²	73.0 dB(A)	69.0 dB(A)	69.0 dB(A)	69.0 dB(A)	69.0 dB(A)	69.0 dB(A)	69.0 dB(A)
Efficiency (%)	25%	95.3	95.1	95.1	94.6	95.6	95.3
	50%	95.4	95.1	95.1	94.8	95.4	95.4
	75%	95.8	95.5	95.5	95.5	95.4	95.4
	100%	95.8	95.3	95.3	95.5	95.0	95.4
Power Factor	25%	0.49	0.49	0.45	0.43	0.55	0.49
	50%	0.74	0.73	0.70	0.68	0.79	0.74
	75%	0.82	0.83	0.81	0.79	0.85	0.82
	100%	0.85	0.86	0.85	0.84	0.86	0.85
Bearing type	: 6319 C3	Drive end	: 6316 C3	Non drive end	Foundation loads		
Sealing	: WSeal		: WSeal		Max. traction	: 2477 lb	
Lubrication interval	: 8000 h		: 10000 h		Max. compression	: 4333 lb	
Lubricant amount	: 45 g		: 34 g				
Lubricant type	: Mobil Polyrex EM						
Notes							
USABLE @208V 376A SF 1.00 SFA 376A							
This revision replaces and cancel the previous one, which must be eliminated. (1) Looking the motor from the shaft end. (2) Measured at 1m and with tolerance of +3dB(A). (3) Approximate weight subject to changes after manufacturing process. (4) At 100% of full load.				These are average values based on tests with sinusoidal power supply, subject to the tolerances stipulated in NEMA MG-1.			
Rev.	Changes Summary			Performed	Checked	Date	
Performed by							
Checked by					Page	Revision	
Date	13/04/2022				1 / 36		

TORQUE AND CURRENT VS SPEED CURVE

Three Phase Induction Motor - Squirrel Cage



Customer :

Product line : NEMA Premium Efficiency Three-Phase

Product code : 11536355

Catalog # : 15018ET3E445T-W22

TORQUE AND CURRENT VS SPEED CURVE

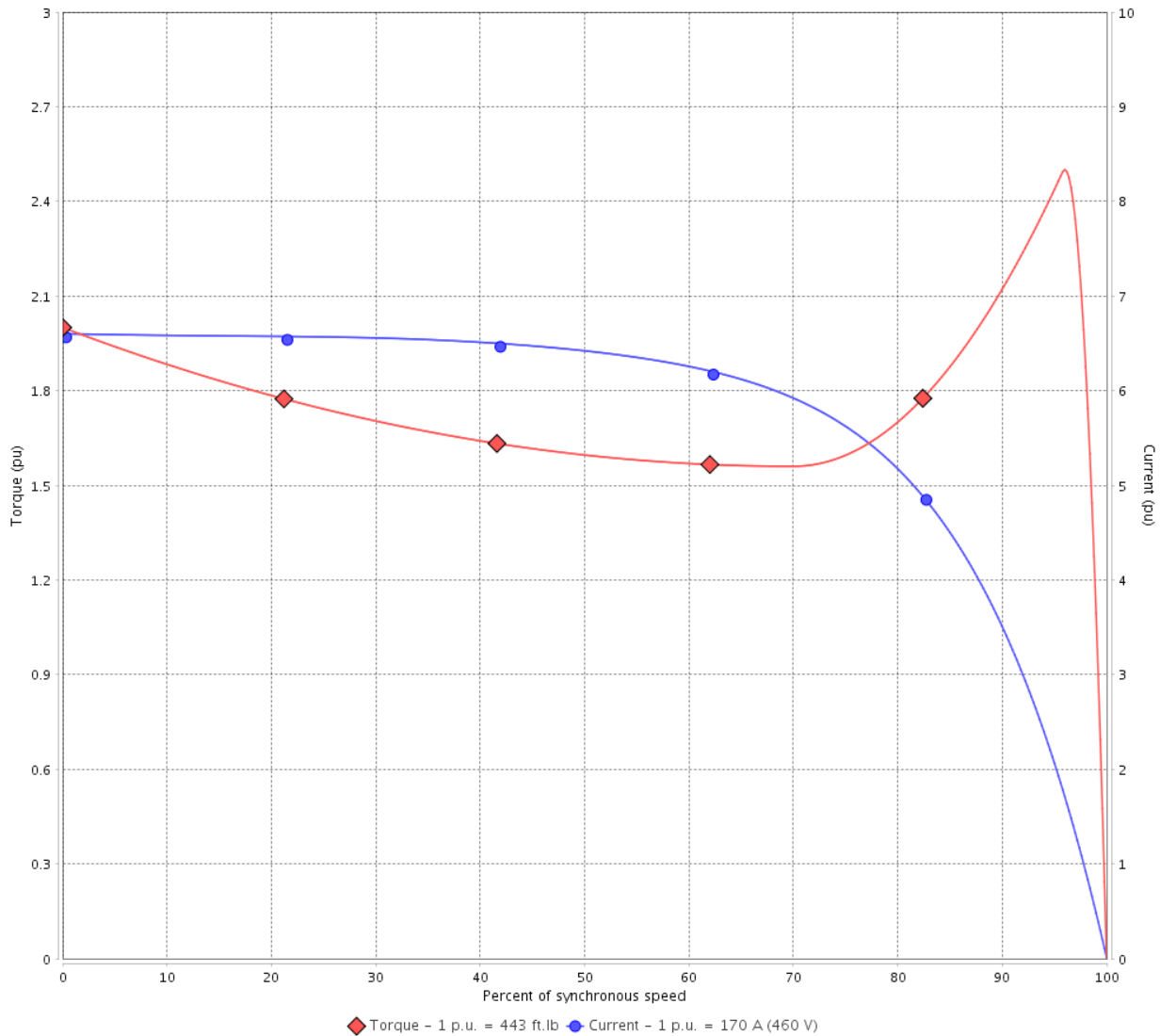

Performance : 230/460 V 60 Hz 4P

Rated current	: 340/170 A	Moment of inertia (J)	: 66.7 sq.ft.lb
LRC	: 6.6	Duty cycle	: Cont.(S1)
Rated torque	: 443 ft.lb	Insulation class	: F
Locked rotor torque	: 200 %	Service factor	: 1.15
Breakdown torque	: 250 %	Temperature rise	: 80 K
Rated speed	: 1780 rpm	Design	: B

Locked rotor time : 48s (cold) 27s (hot)

Rev.	Changes Summary	Performed	Checked	Date
Performed by			Page 2 / 36	Revision
Checked by				
Date	13/04/2022			

TORQUE AND CURRENT VS SPEED CURVE



Three Phase Induction Motor - Squirrel Cage

Customer :

Product line : NEMA Premium Efficiency Three-Phase

Product code : 11536355

Catalog # : 15018ET3E445T-W22

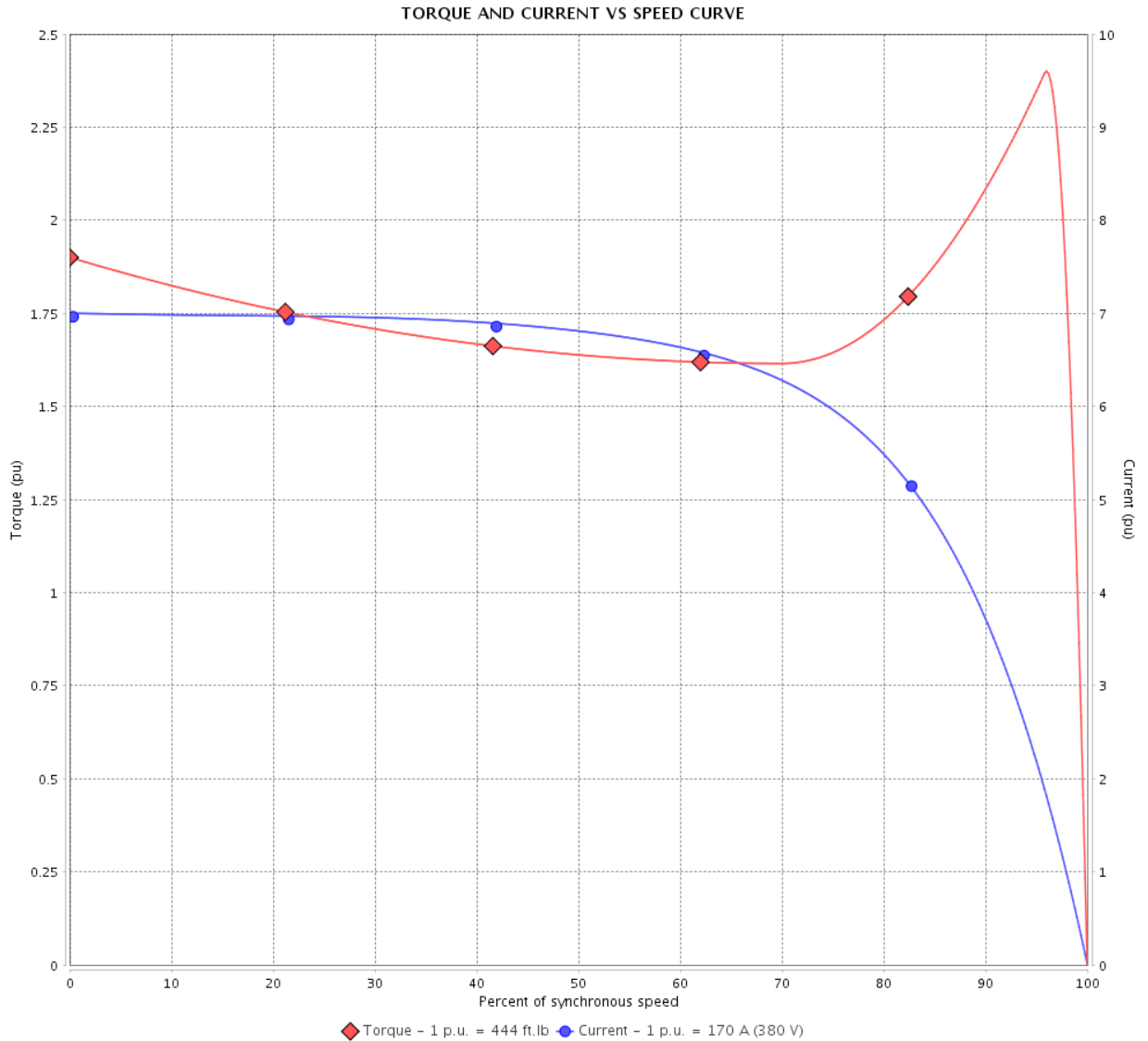

Performance : 380 V 50 Hz 4P IE3

Rated current	: 170 A	Moment of inertia (J)	: 66.7 sq.ft.lb
LRC	: 7.0	Duty cycle	: Cont.(S1)
Rated torque	: 444 ft.lb	Insulation class	: F
Locked rotor torque	: 190 %	Service factor	: 1.00
Breakdown torque	: 240 %	Temperature rise	: 80 K
Rated speed	: 1480 rpm	Design	: B

Locked rotor time : 32s (cold) 18s (hot)

Rev.	Changes Summary	Performed	Checked	Date
Performed by			Page 3 / 36	Revision
Checked by				
Date	13/04/2022			

TORQUE AND CURRENT VS SPEED CURVE

Three Phase Induction Motor - Squirrel Cage



Customer :

Product line : NEMA Premium Efficiency Three-Phase

Product code : 11536355

Catalog # : 15018ET3E445T-W22

TORQUE AND CURRENT VS SPEED CURVE

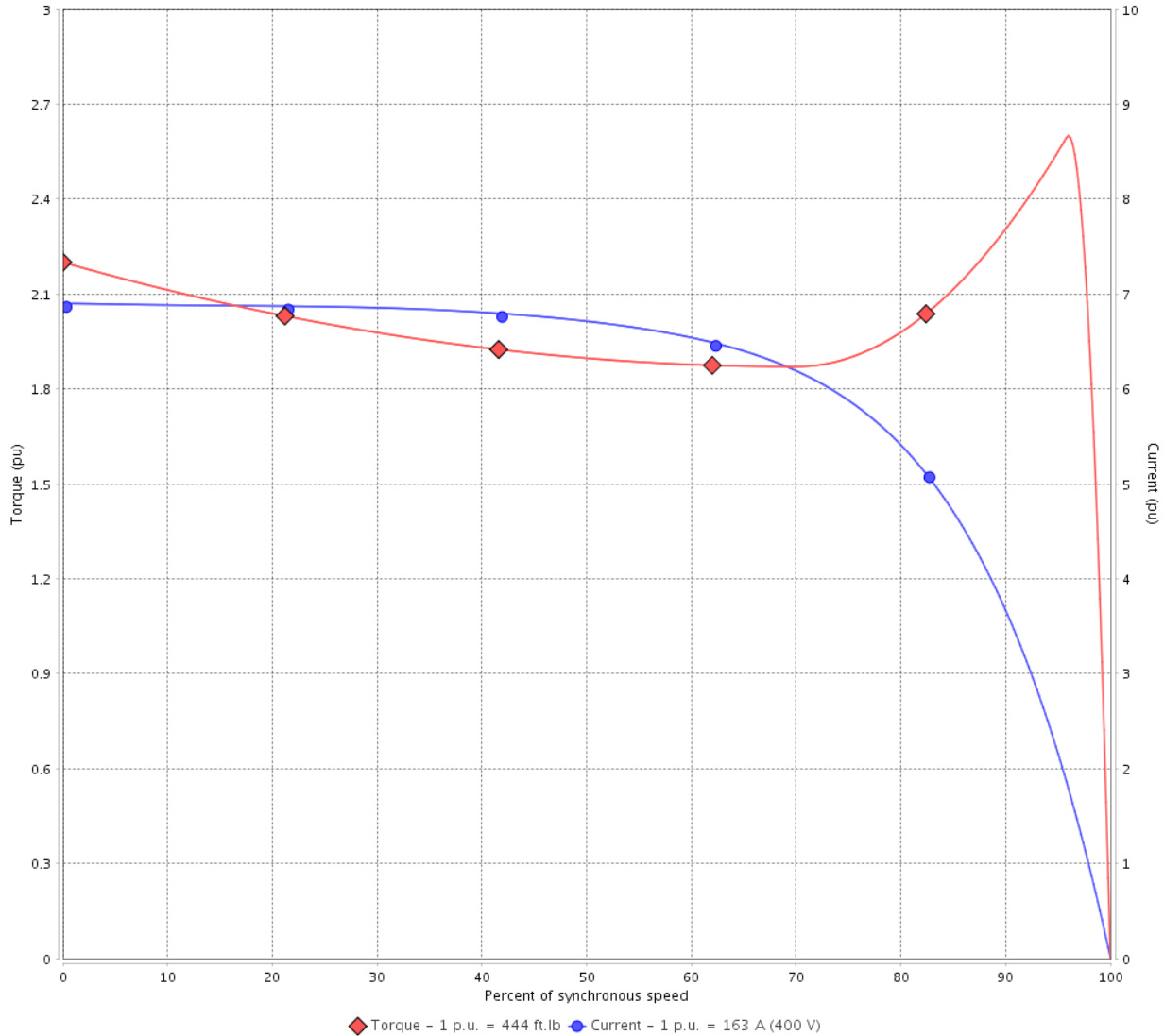

Performance : 400 V 50 Hz 4P IE3

Rated current	: 163 A	Moment of inertia (J)	: 66.7 sq.ft.lb
LRC	: 6.9	Duty cycle	: Cont.(S1)
Rated torque	: 444 ft.lb	Insulation class	: F
Locked rotor torque	: 220 %	Service factor	: 1.00
Breakdown torque	: 260 %	Temperature rise	: 80 K
Rated speed	: 1480 rpm	Design	: B

Locked rotor time : 32s (cold) 18s (hot)

Rev.	Changes Summary	Performed	Checked	Date
Performed by			Page 4 / 36	Revision
Checked by				
Date	13/04/2022			

TORQUE AND CURRENT VS SPEED CURVE



Three Phase Induction Motor - Squirrel Cage

Customer :

Product line : NEMA Premium Efficiency Three-Phase

Product code : 11536355

Catalog # : 15018ET3E445T-W22

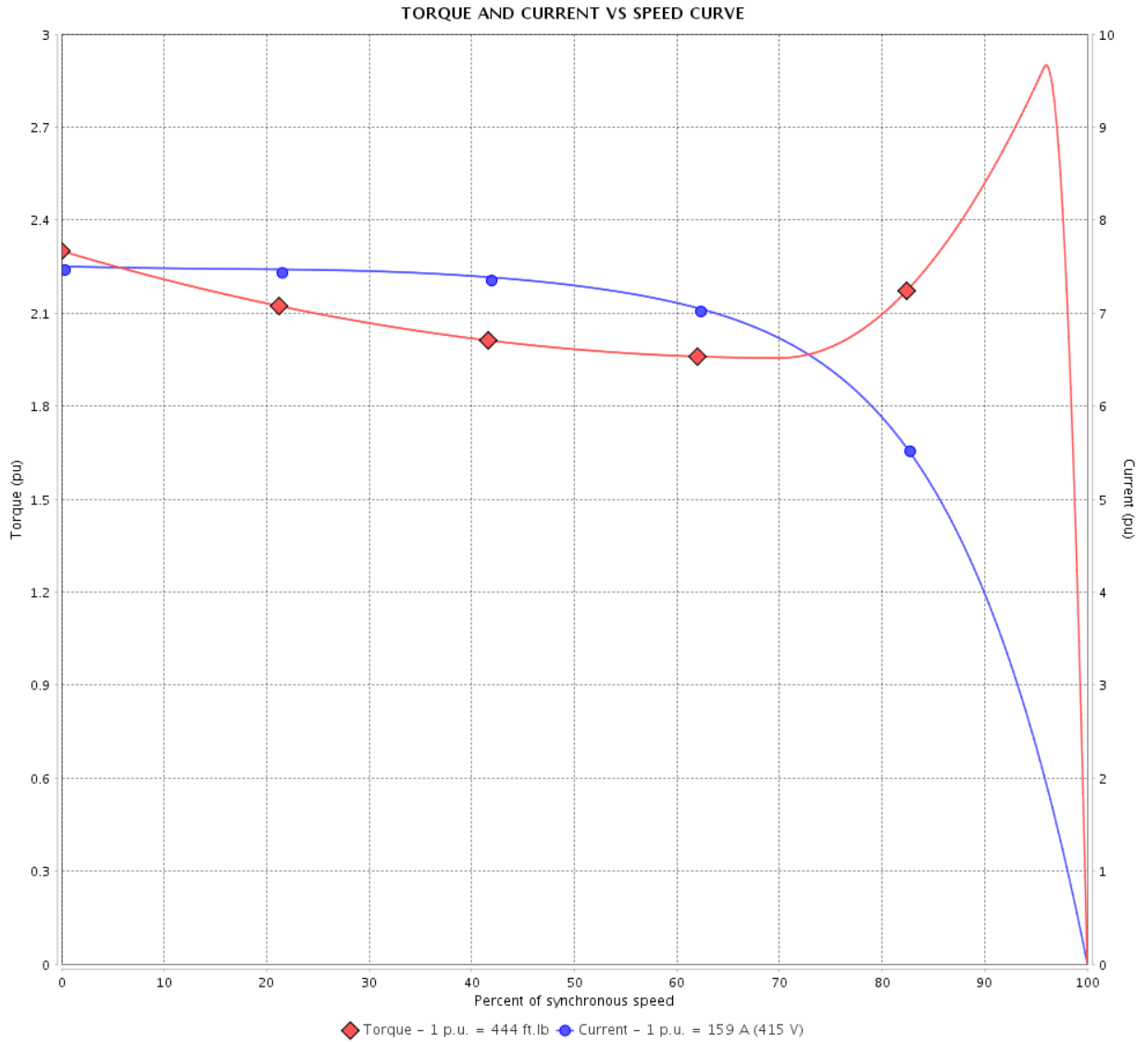

Performance : 415 V 50 Hz 4P IE3

Rated current	: 159 A	Moment of inertia (J)	: 66.7 sq.ft.lb
LRC	: 7.5	Duty cycle	: Cont.(S1)
Rated torque	: 444 ft.lb	Insulation class	: F
Locked rotor torque	: 229 %	Service factor	: 1.00
Breakdown torque	: 290 %	Temperature rise	: 80 K
Rated speed	: 1480 rpm	Design	: B

Locked rotor time : 32s (cold) 18s (hot)

Rev.	Changes Summary	Performed	Checked	Date
Performed by			Page 5 / 36	Revision
Checked by				
Date	13/04/2022			

TORQUE AND CURRENT VS SPEED CURVE

Three Phase Induction Motor - Squirrel Cage



Customer :

Product line : NEMA Premium Efficiency Three-Phase

Product code : 11536355

Catalog # : 15018ET3E445T-W22

TORQUE AND CURRENT VS SPEED CURVE

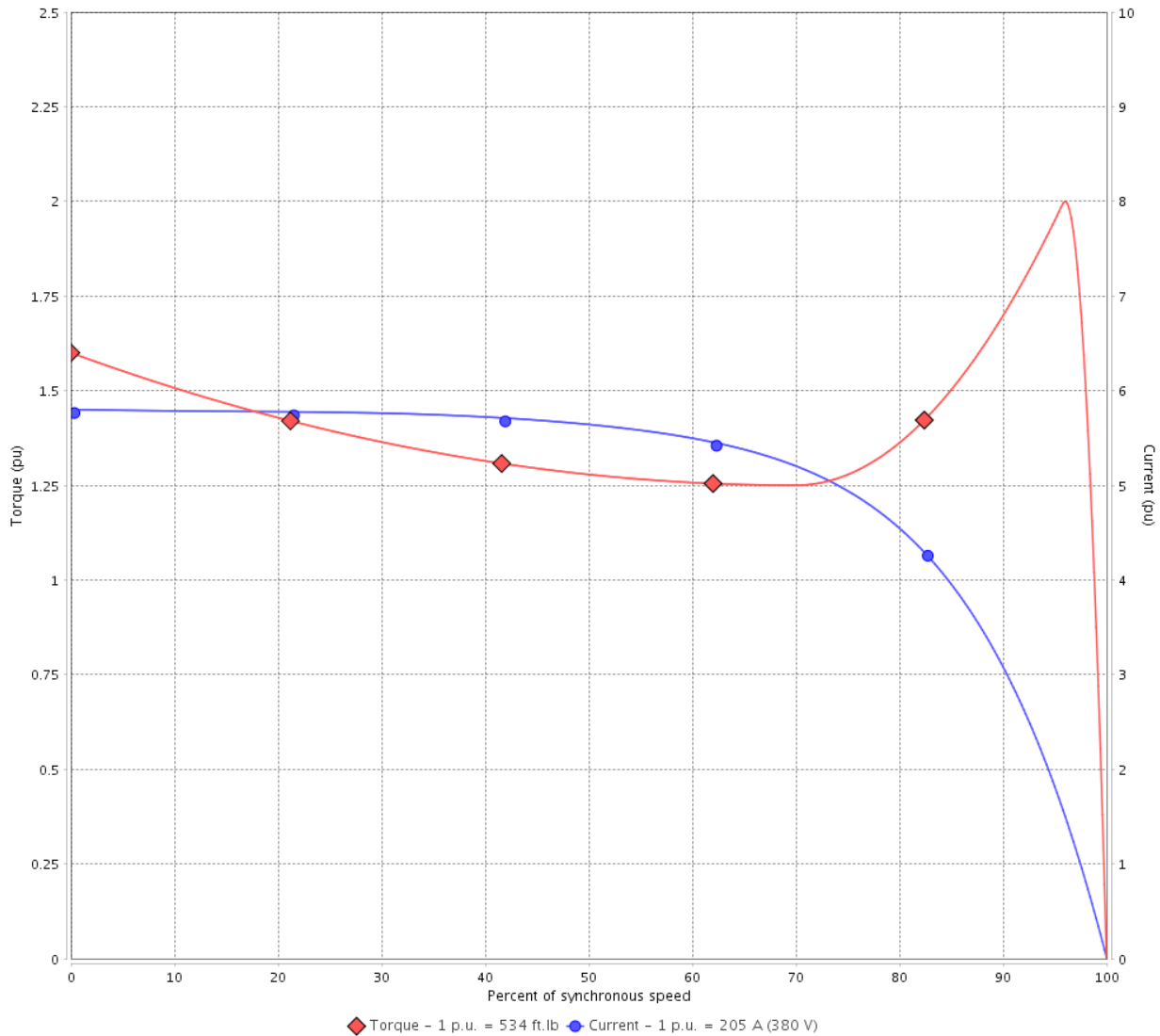

Performance : 380 V 50 Hz 4P IE2

Rated current	: 205 A	Moment of inertia (J)	: 66.7 sq.ft.lb
LRC	: 5.8	Duty cycle	: Cont.(S1)
Rated torque	: 534 ft.lb	Insulation class	: F
Locked rotor torque	: 160 %	Service factor	: 1.00
Breakdown torque	: 200 %	Temperature rise	: 105 K
Rated speed	: 1475 rpm	Design	: B

Locked rotor time : 32s (cold) 18s (hot)

Rev.	Changes Summary	Performed	Checked	Date
Performed by			Page 6 / 36	Revision
Checked by				
Date	13/04/2022			

TORQUE AND CURRENT VS SPEED CURVE



Three Phase Induction Motor - Squirrel Cage

Customer :

Product line : NEMA Premium Efficiency Three-Phase

Product code : 11536355

Catalog # : 15018ET3E445T-W22

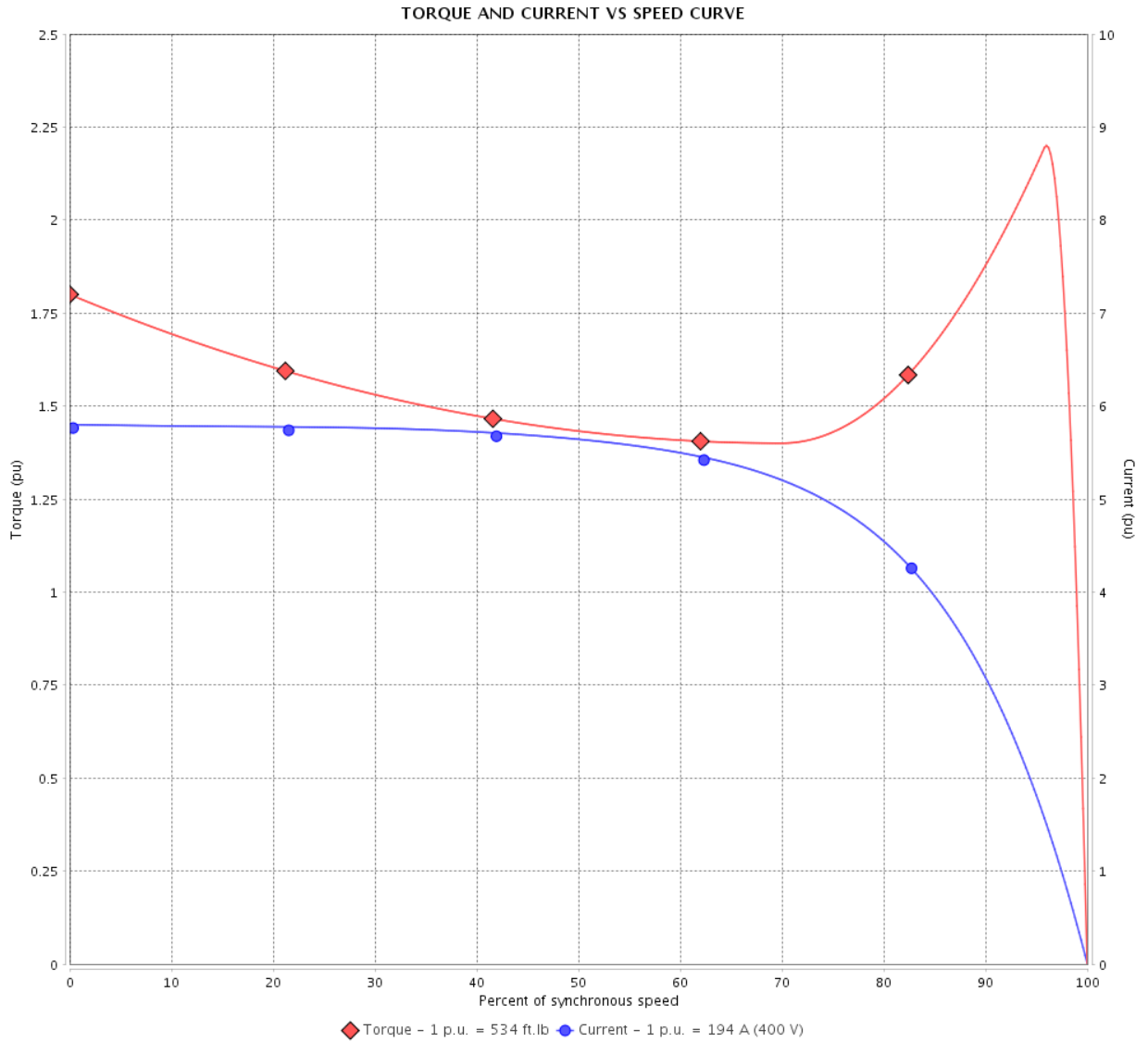

Performance : 400 V 50 Hz 4P IE2

Rated current	: 194 A	Moment of inertia (J)	: 66.7 sq.ft.lb
LRC	: 5.8	Duty cycle	: Cont.(S1)
Rated torque	: 534 ft.lb	Insulation class	: F
Locked rotor torque	: 180 %	Service factor	: 1.00
Breakdown torque	: 220 %	Temperature rise	: 105 K
Rated speed	: 1475 rpm	Design	: B

Locked rotor time : 32s (cold) 18s (hot)

Rev.	Changes Summary	Performed	Checked	Date
Performed by			Page 7 / 36	Revision
Checked by				
Date	13/04/2022			

TORQUE AND CURRENT VS SPEED CURVE

Three Phase Induction Motor - Squirrel Cage



Customer :

Product line : NEMA Premium Efficiency Three-Phase

Product code : 11536355

Catalog # : 15018ET3E445T-W22

TORQUE AND CURRENT VS SPEED CURVE

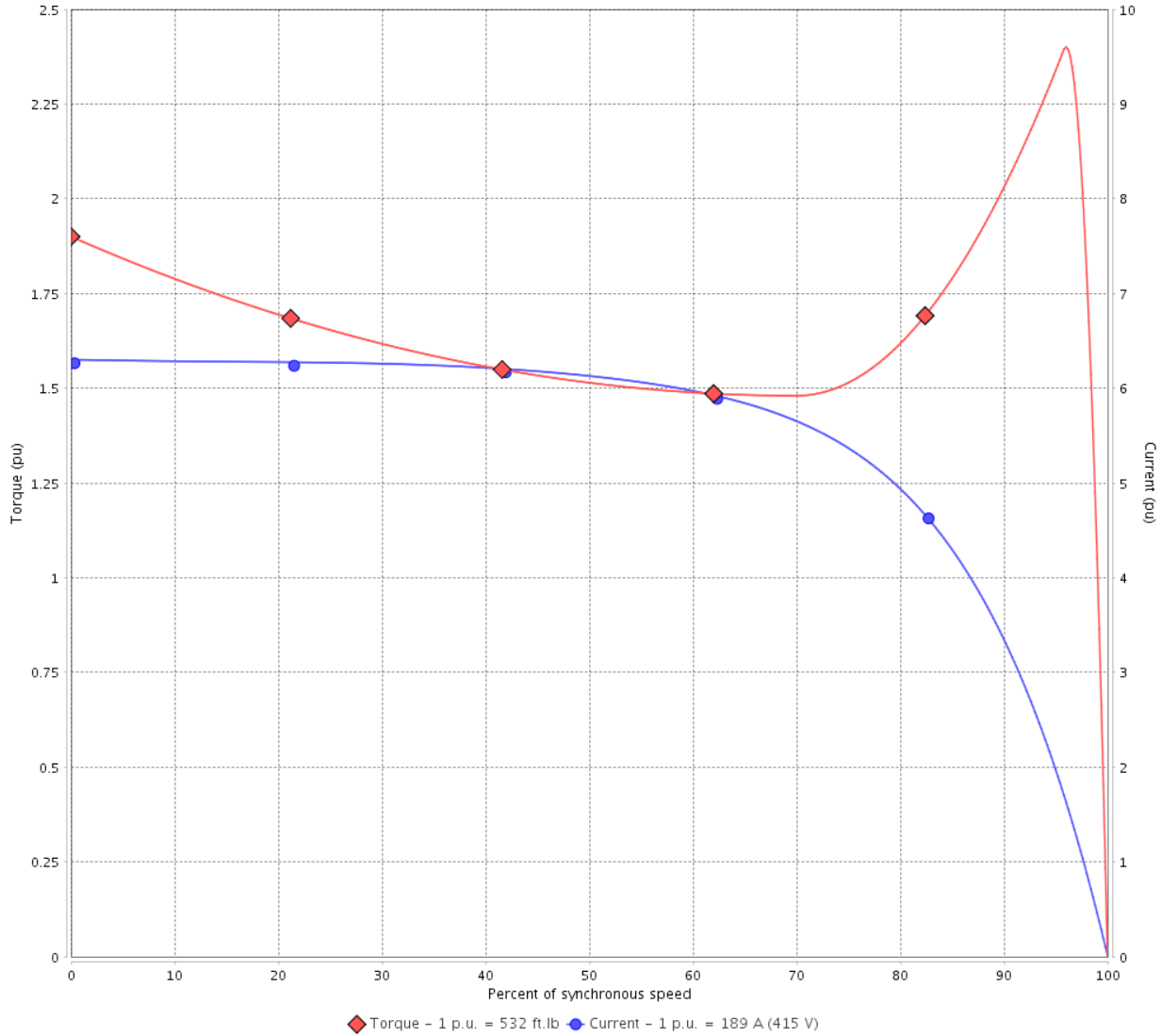

Performance : 415 V 50 Hz 4P IE3

Rated current	: 189 A	Moment of inertia (J)	: 66.7 sq.ft.lb
LRC	: 6.3	Duty cycle	: Cont.(S1)
Rated torque	: 532 ft.lb	Insulation class	: F
Locked rotor torque	: 190 %	Service factor	: 1.00
Breakdown torque	: 240 %	Temperature rise	: 105 K
Rated speed	: 1480 rpm	Design	: B

Locked rotor time : 32s (cold) 18s (hot)

Rev.	Changes Summary	Performed	Checked	Date
Performed by			Page 8 / 36	Revision
Checked by				
Date	13/04/2022			

LOAD PERFORMANCE CURVE

Three Phase Induction Motor - Squirrel Cage



Customer : _____

Product line : NEMA Premium Efficiency Three-Phase

Product code : 11536355

Catalog # : 15018ET3E445T-W22

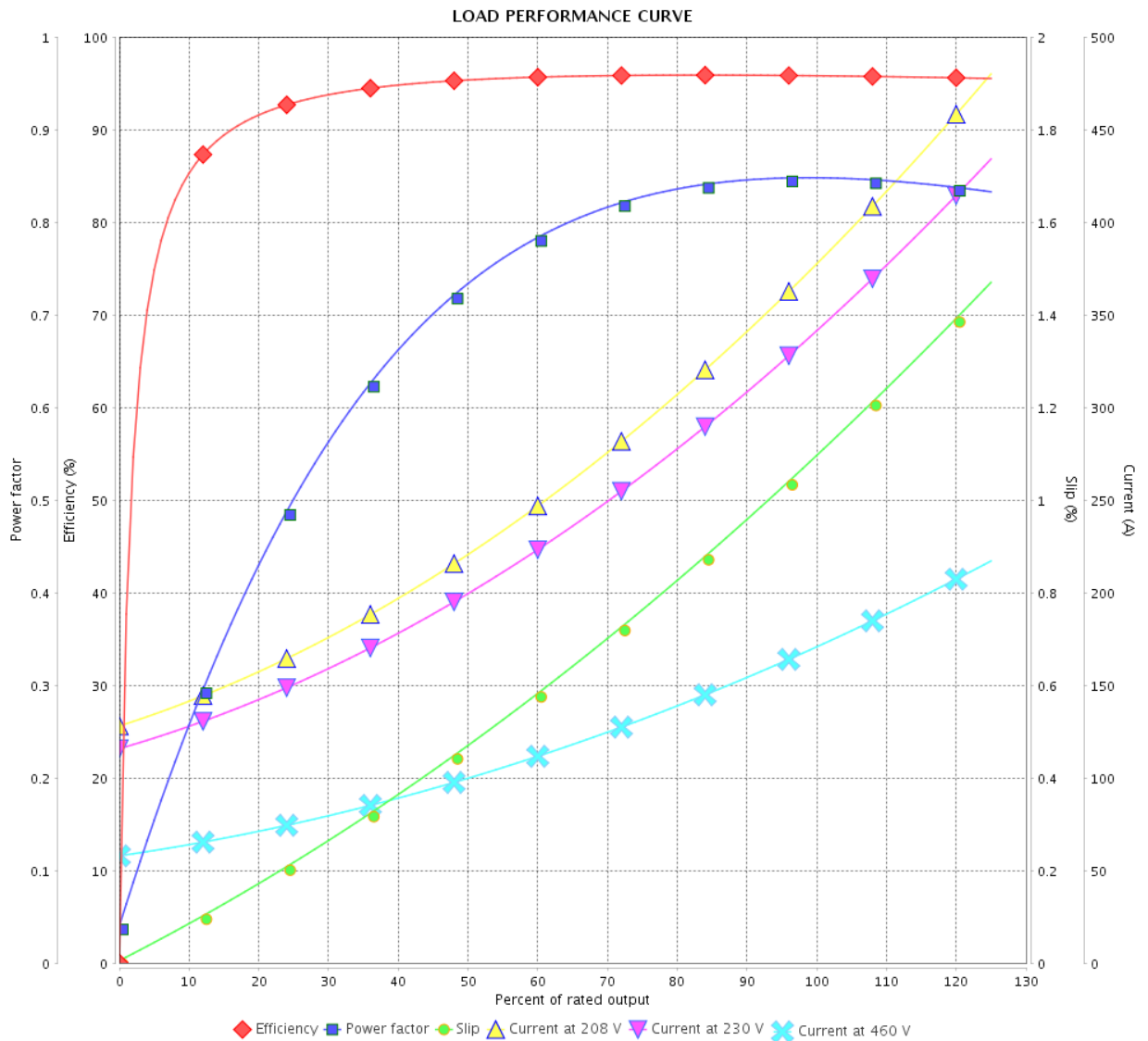

Performance : 230/460 V 60 Hz 4P

Rated current : 340/170 A
 LRC : 6.6
 Rated torque : 443 ft.lb
 Locked rotor torque : 200 %
 Breakdown torque : 250 %
 Rated speed : 1780 rpm

Moment of inertia (J) : 66.7 sq.ft.lb
 Duty cycle : Cont.(S1)
 Insulation class : F
 Service factor : 1.15
 Temperature rise : 80 K
 Design : B

Rev.	Changes Summary	Performed	Checked	Date
Performed by		Page		Revision
Checked by		9 / 36		
Date		13/04/2022		

LOAD PERFORMANCE CURVE

Three Phase Induction Motor - Squirrel Cage



Customer :

Product line : NEMA Premium Efficiency Three-Phase

Product code : 11536355

Catalog # : 15018ET3E445T-W22

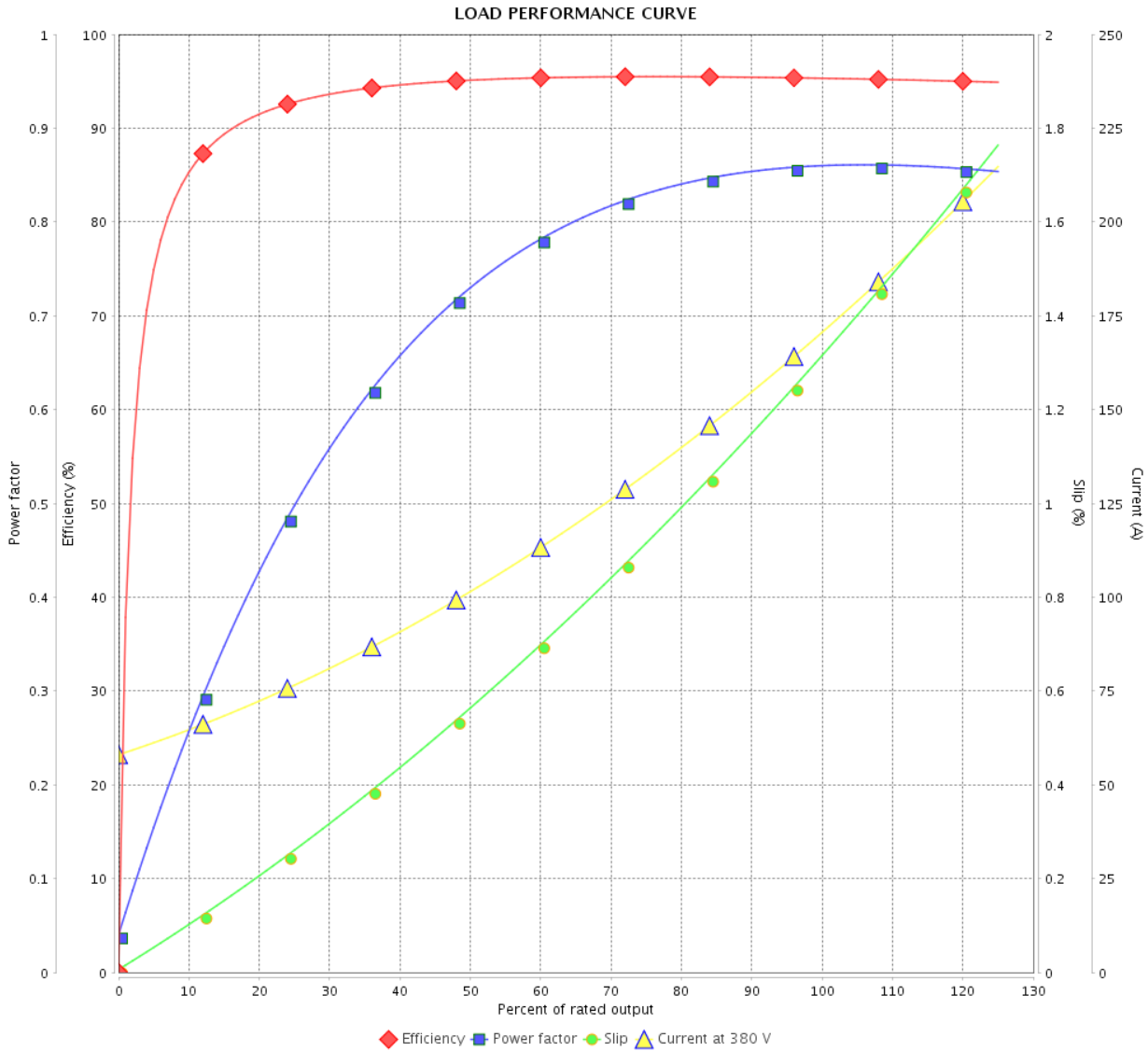

Performance : 380 V 50 Hz 4P IE3

Rated current	: 170 A	Moment of inertia (J)	: 66.7 sq.ft.lb
LRC	: 7.0	Duty cycle	: Cont.(S1)
Rated torque	: 444 ft.lb	Insulation class	: F
Locked rotor torque	: 190 %	Service factor	: 1.00
Breakdown torque	: 240 %	Temperature rise	: 80 K
Rated speed	: 1480 rpm	Design	: B

Rev.	Changes Summary	Performed	Checked	Date
Performed by			Page 10 / 36	Revision
Checked by				
Date	13/04/2022			

LOAD PERFORMANCE CURVE

Three Phase Induction Motor - Squirrel Cage



Customer : _____

Product line : NEMA Premium Efficiency Three-Phase

Product code : 11536355

Catalog # : 15018ET3E445T-W22

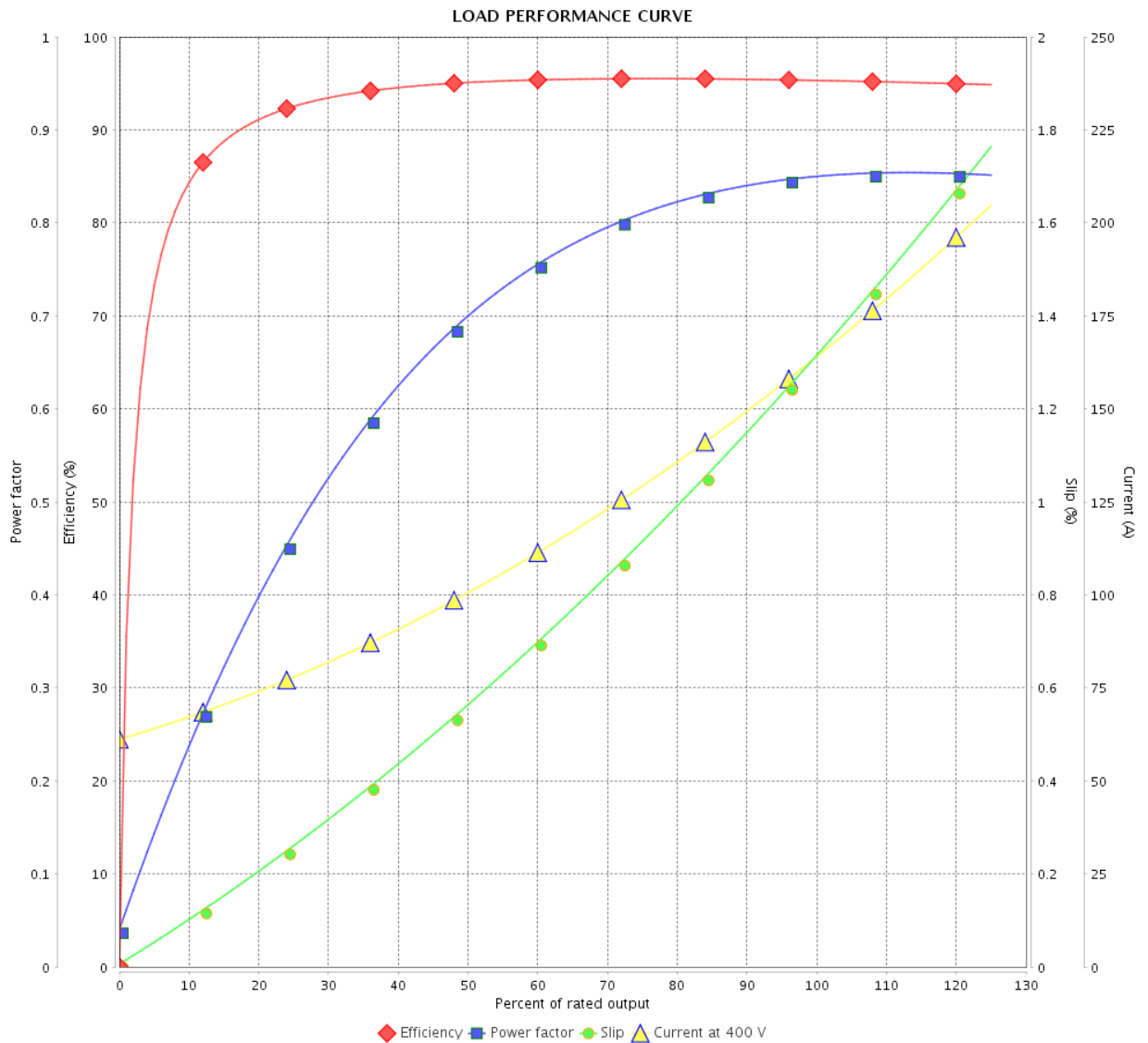

Performance : 400 V 50 Hz 4P IE3

Rated current : 163 A
 LRC : 6.9
 Rated torque : 444 ft.lb
 Locked rotor torque : 220 %
 Breakdown torque : 260 %
 Rated speed : 1480 rpm

Moment of inertia (J) : 66.7 sq.ft.lb
 Duty cycle : Cont.(S1)
 Insulation class : F
 Service factor : 1.00
 Temperature rise : 80 K
 Design : B

Rev.	Changes Summary	Performed	Checked	Date
Performed by		Page		Revision
Checked by		11 / 36		
Date		13/04/2022		

LOAD PERFORMANCE CURVE

Three Phase Induction Motor - Squirrel Cage



Customer : _____

Product line : NEMA Premium Efficiency Three-Phase

Product code : 11536355

Catalog # : 15018ET3E445T-W22

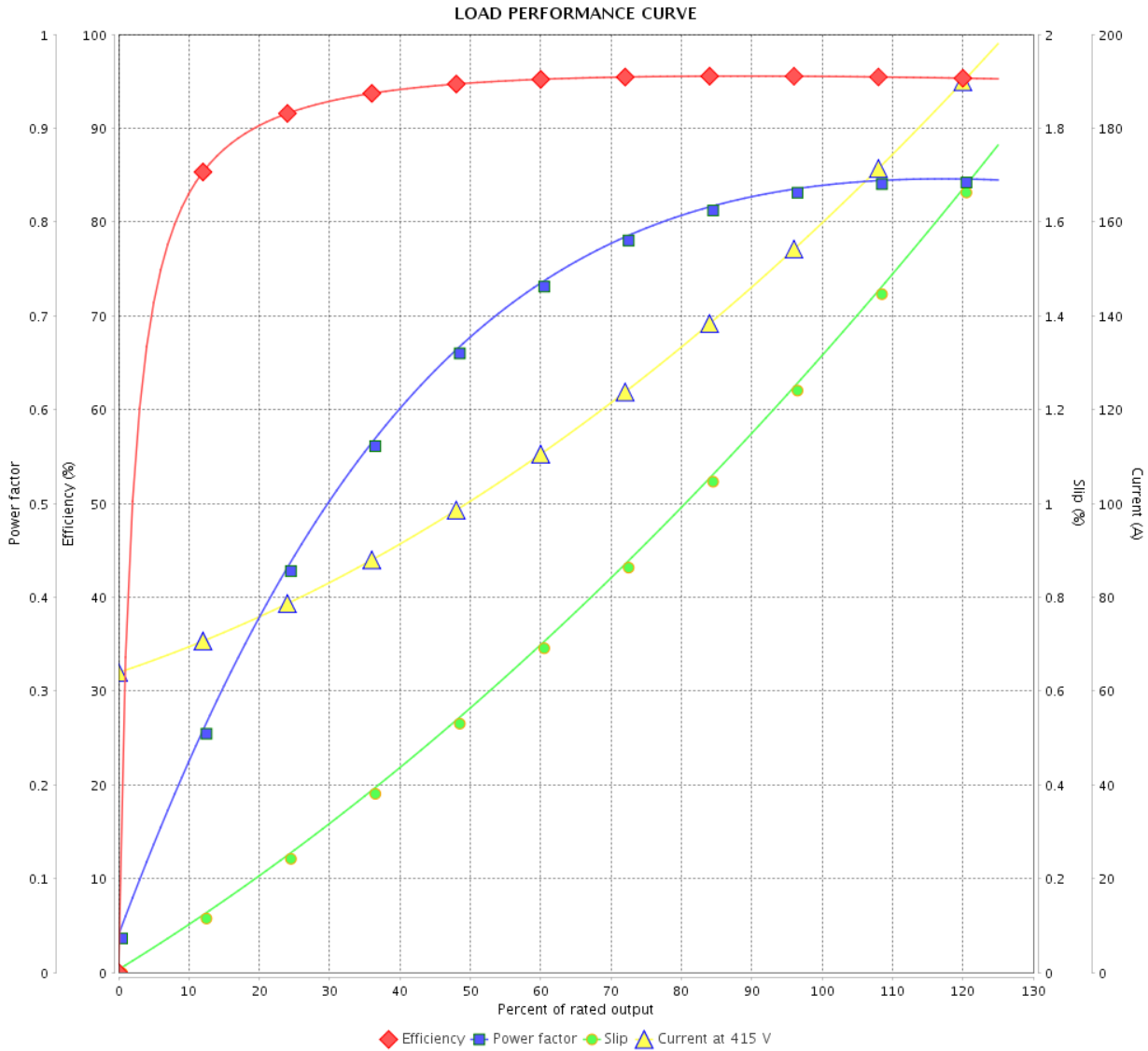

Performance : 415 V 50 Hz 4P IE3

Rated current : 159 A
 LRC : 7.5
 Rated torque : 444 ft.lb
 Locked rotor torque : 229 %
 Breakdown torque : 290 %
 Rated speed : 1480 rpm

Moment of inertia (J) : 66.7 sq.ft.lb
 Duty cycle : Cont.(S1)
 Insulation class : F
 Service factor : 1.00
 Temperature rise : 80 K
 Design : B

Rev.	Changes Summary	Performed	Checked	Date
Performed by			Page 12 / 36	Revision
Checked by				
Date	13/04/2022			

LOAD PERFORMANCE CURVE

Three Phase Induction Motor - Squirrel Cage



Customer :

Product line : NEMA Premium Efficiency Three-Phase

Product code : 11536355

Catalog # : 15018ET3E445T-W22

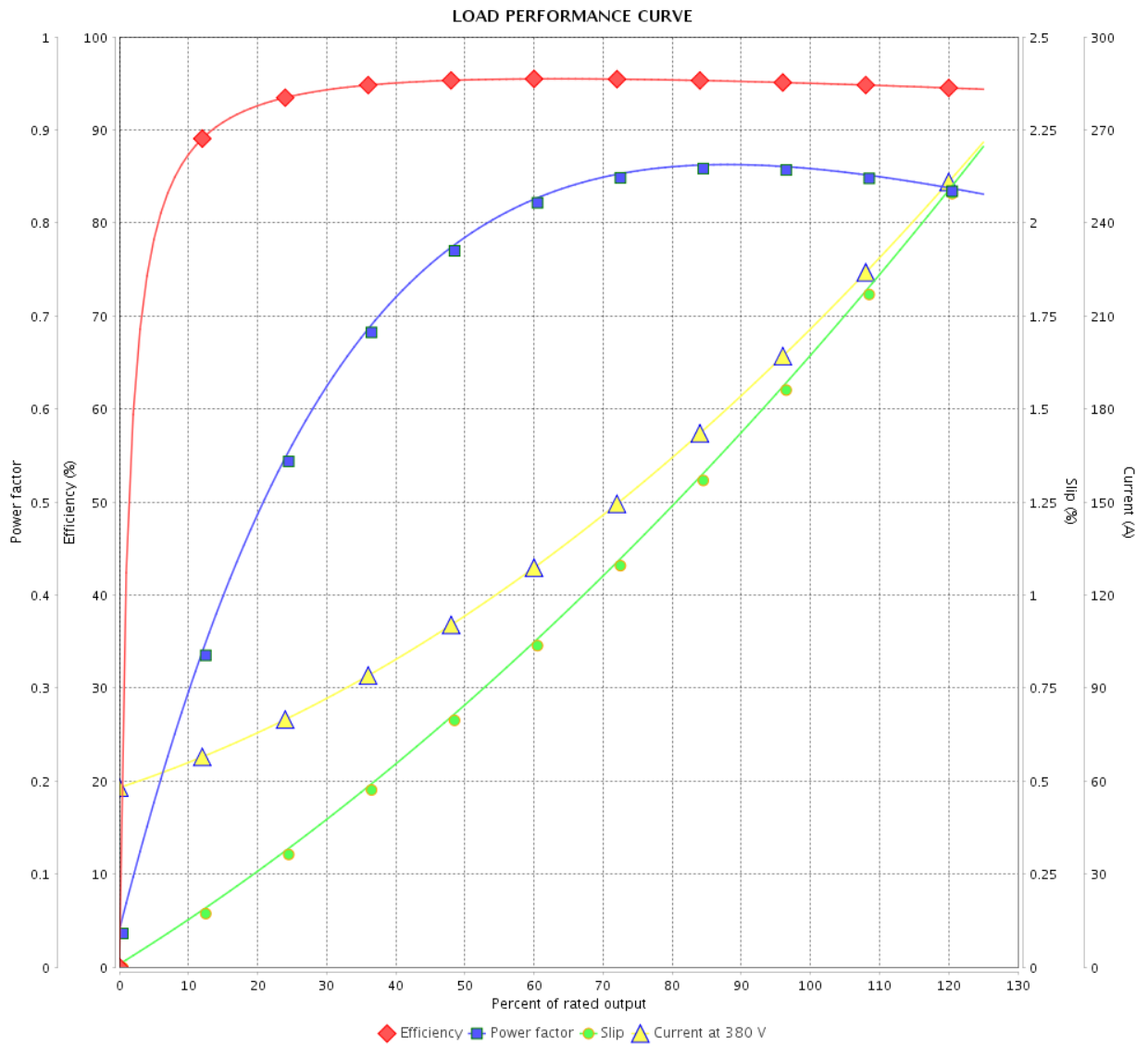

Performance : 380 V 50 Hz 4P IE2

Rated current : 205 A
 LRC : 5.8
 Rated torque : 534 ft.lb
 Locked rotor torque : 160 %
 Breakdown torque : 200 %
 Rated speed : 1475 rpm

Moment of inertia (J) : 66.7 sq.ft.lb
 Duty cycle : Cont.(S1)
 Insulation class : F
 Service factor : 1.00
 Temperature rise : 105 K
 Design : B

Rev.	Changes Summary	Performed	Checked	Date
Performed by		Page		Revision
Checked by		13 / 36		
Date		13/04/2022		

LOAD PERFORMANCE CURVE

Three Phase Induction Motor - Squirrel Cage



Customer :

Product line : NEMA Premium Efficiency Three-Phase

Product code : 11536355

Catalog # : 15018ET3E445T-W22

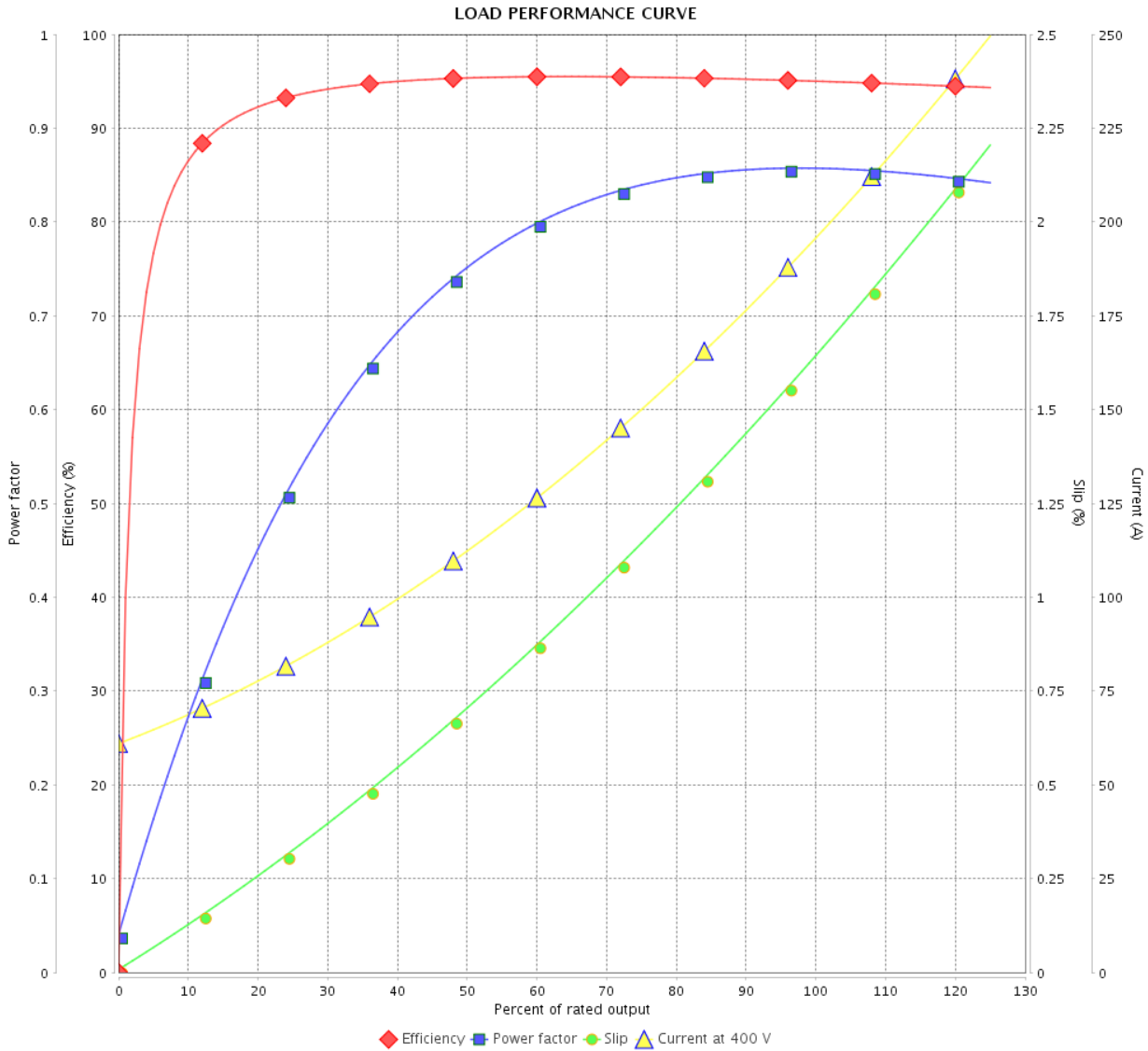

Performance : 400 V 50 Hz 4P IE2

Rated current	: 194 A	Moment of inertia (J)	: 66.7 sq.ft.lb
LRC	: 5.8	Duty cycle	: Cont.(S1)
Rated torque	: 534 ft.lb	Insulation class	: F
Locked rotor torque	: 180 %	Service factor	: 1.00
Breakdown torque	: 220 %	Temperature rise	: 105 K
Rated speed	: 1475 rpm	Design	: B

Rev.	Changes Summary	Performed	Checked	Date
Performed by			Page 14 / 36	Revision
Checked by				
Date	13/04/2022			

LOAD PERFORMANCE CURVE

Three Phase Induction Motor - Squirrel Cage



Customer : _____

Product line : NEMA Premium Efficiency Three-Phase

Product code : 11536355

Catalog # : 15018ET3E445T-W22

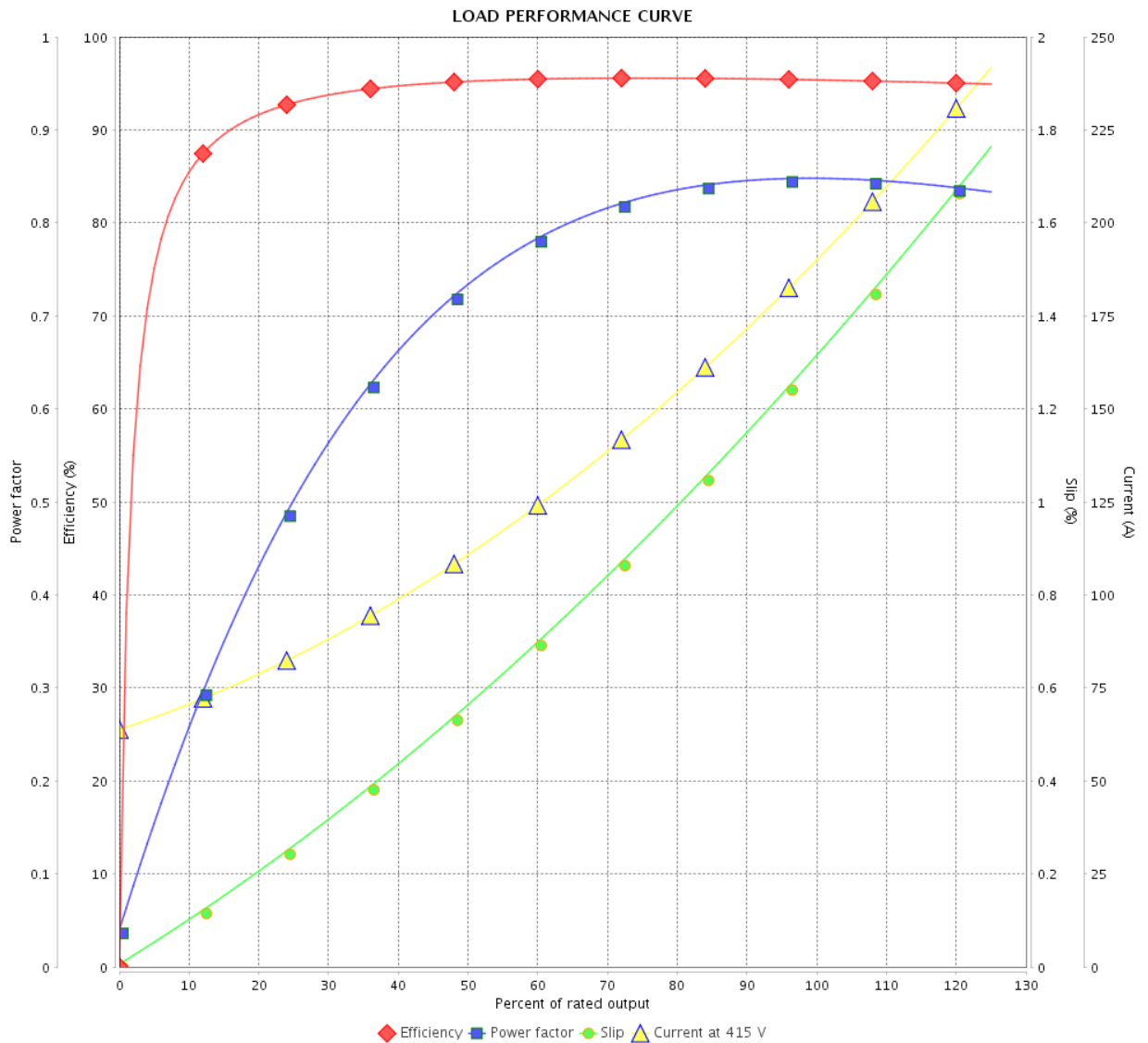

Performance : 415 V 50 Hz 4P IE3

Rated current : 189 A
 LRC : 6.3
 Rated torque : 532 ft.lb
 Locked rotor torque : 190 %
 Breakdown torque : 240 %
 Rated speed : 1480 rpm

Moment of inertia (J) : 66.7 sq.ft.lb
 Duty cycle : Cont.(S1)
 Insulation class : F
 Service factor : 1.00
 Temperature rise : 105 K
 Design : B

Rev.	Changes Summary	Performed	Checked	Date
Performed by		Page		Revision
Checked by		15 / 36		
Date		13/04/2022		

THERMAL LIMIT CURVE



Three Phase Induction Motor - Squirrel Cage

Customer :

Product line : NEMA Premium Efficiency Three-Phase
 Product code : 11536355
 Catalog # : 15018ET3E445T-W22

Performance : 230/460 V 60 Hz 4P

Rated current : 340/170 A	Moment of inertia (J) : 66.7 sq.ft.lb
LRC : 6.6	Duty cycle : Cont.(S1)
Rated torque : 443 ft.lb	Insulation class : F
Locked rotor torque : 200 %	Service factor : 1.15
Breakdown torque : 250 %	Temperature rise : 80 K
Rated speed : 1780 rpm	Design : B

Heating constant

Cooling constant

Rev.	Changes Summary	Performed	Checked	Date
Performed by			Page 16 / 36	Revision
Checked by				
Date	13/04/2022			

THERMAL LIMIT CURVE

Three Phase Induction Motor - Squirrel Cage



Customer : _____

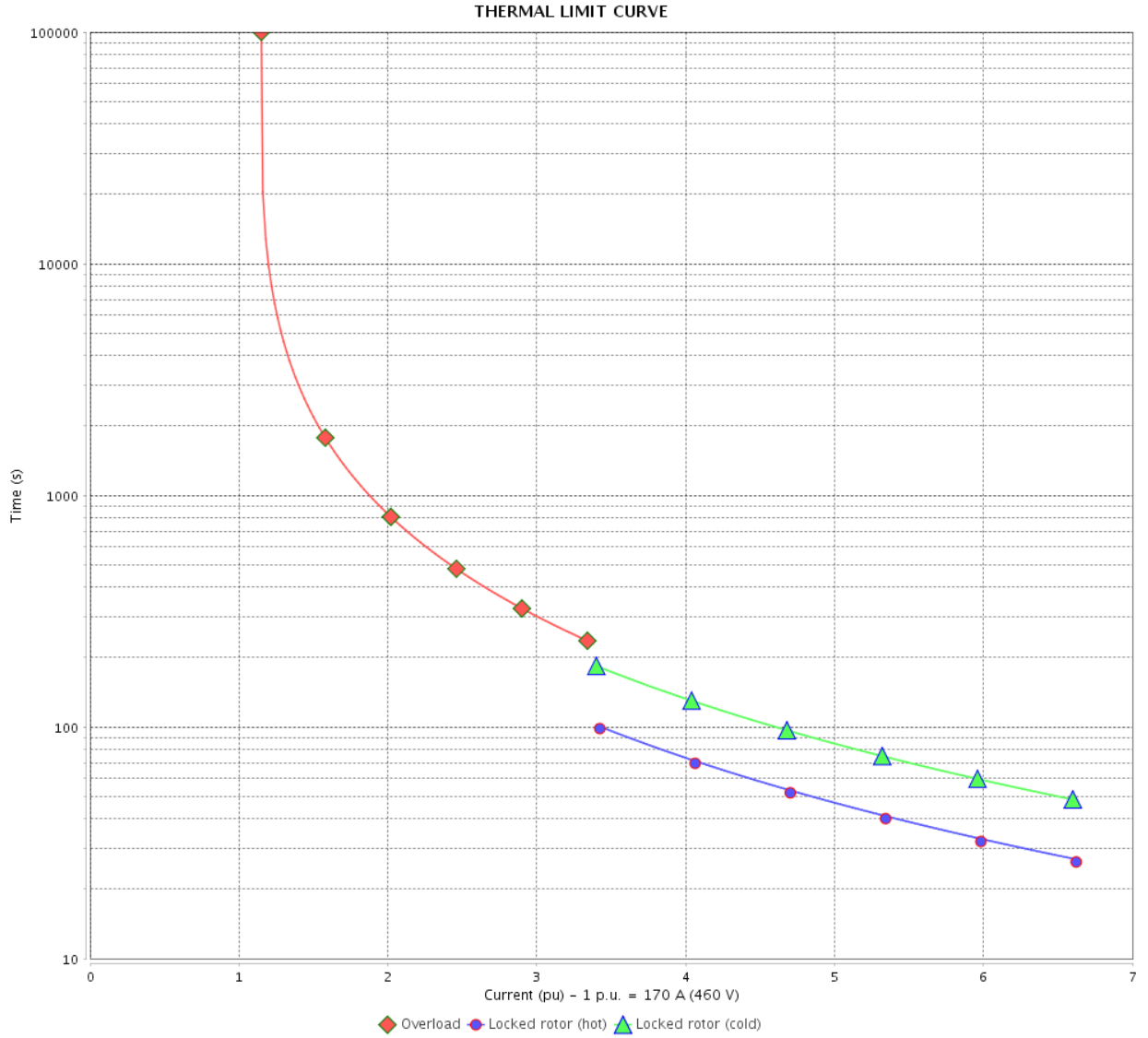

Rev.	Changes Summary	Performed	Checked	Date
Performed by		Page 17 / 36		Revision
Checked by				
Date				

THERMAL LIMIT CURVE

Three Phase Induction Motor - Squirrel Cage



Customer :

Product line : NEMA Premium Efficiency Three-Phase
Product code : 11536355
Catalog # : 15018ET3E445T-W22

Performance : 380 V 50 Hz 4P IE3

Rated current	: 170 A	Moment of inertia (J)	: 66.7 sq.ft.lb
LRC	: 7.0	Duty cycle	: Cont.(S1)
Rated torque	: 444 ft.lb	Insulation class	: F
Locked rotor torque	: 190 %	Service factor	: 1.00
Breakdown torque	: 240 %	Temperature rise	: 80 K
Rated speed	: 1480 rpm	Design	: B

Heating constant

Cooling constant

Rev.	Changes Summary	Performed	Checked	Date
Performed by				
Checked by			Page	Revision
Date	13/04/2022		18 / 36	

THERMAL LIMIT CURVE

Three Phase Induction Motor - Squirrel Cage



Customer : _____

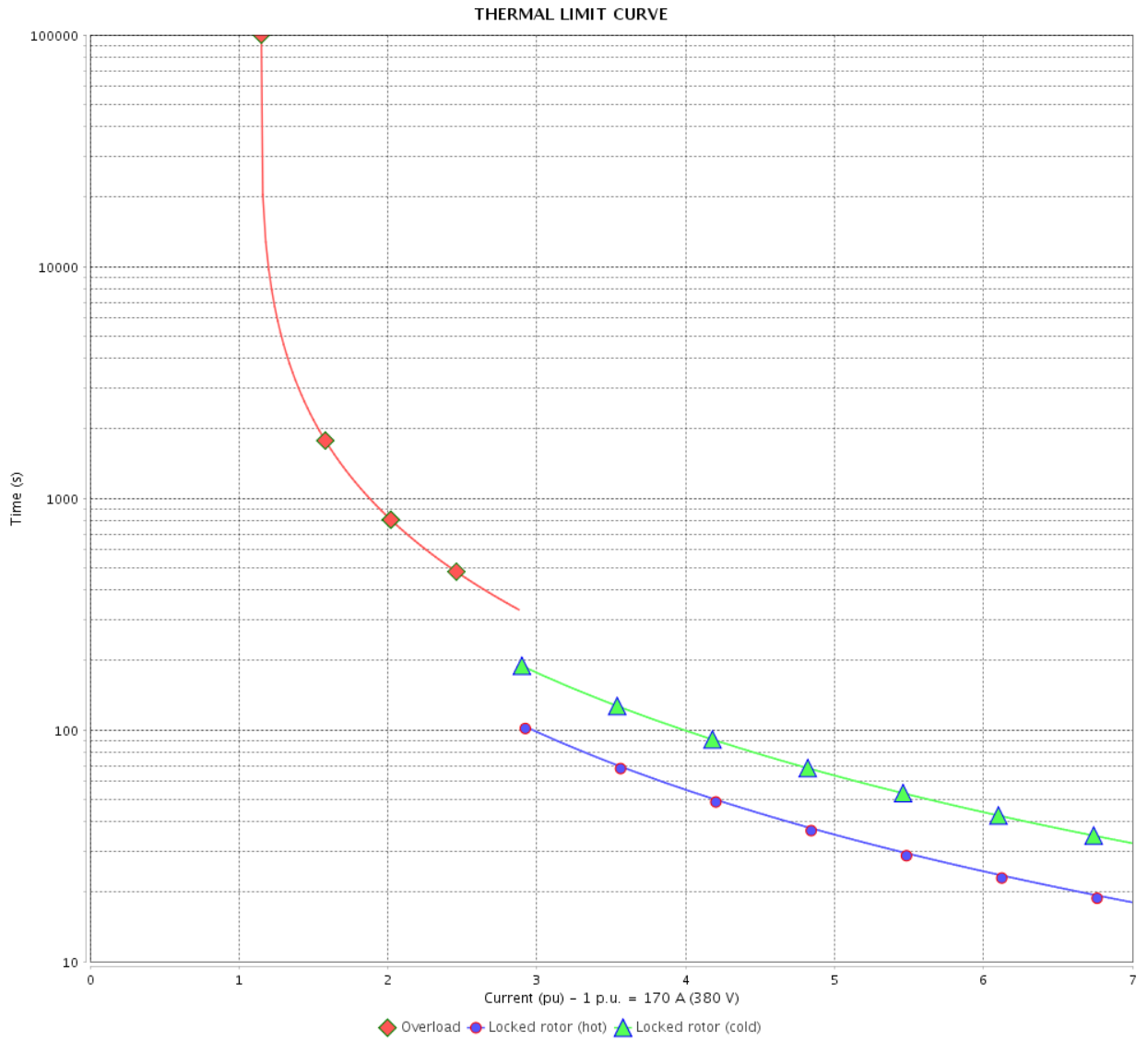

Rev.	Changes Summary	Performed	Checked	Date
Performed by		Page 19 / 36		Revision
Checked by				
Date				

THERMAL LIMIT CURVE

Three Phase Induction Motor - Squirrel Cage



Customer :

Product line : NEMA Premium Efficiency Three-Phase
Product code : 11536355
Catalog # : 15018ET3E445T-W22

Performance : 400 V 50 Hz 4P IE3

Rated current	: 163 A	Moment of inertia (J)	: 66.7 sq.ft.lb
LRC	: 6.9	Duty cycle	: Cont.(S1)
Rated torque	: 444 ft.lb	Insulation class	: F
Locked rotor torque	: 220 %	Service factor	: 1.00
Breakdown torque	: 260 %	Temperature rise	: 80 K
Rated speed	: 1480 rpm	Design	: B

Heating constant

Cooling constant

Rev.	Changes Summary	Performed	Checked	Date
Performed by				
Checked by			Page	Revision
Date	13/04/2022		20 / 36	

THERMAL LIMIT CURVE

Three Phase Induction Motor - Squirrel Cage



Customer : _____

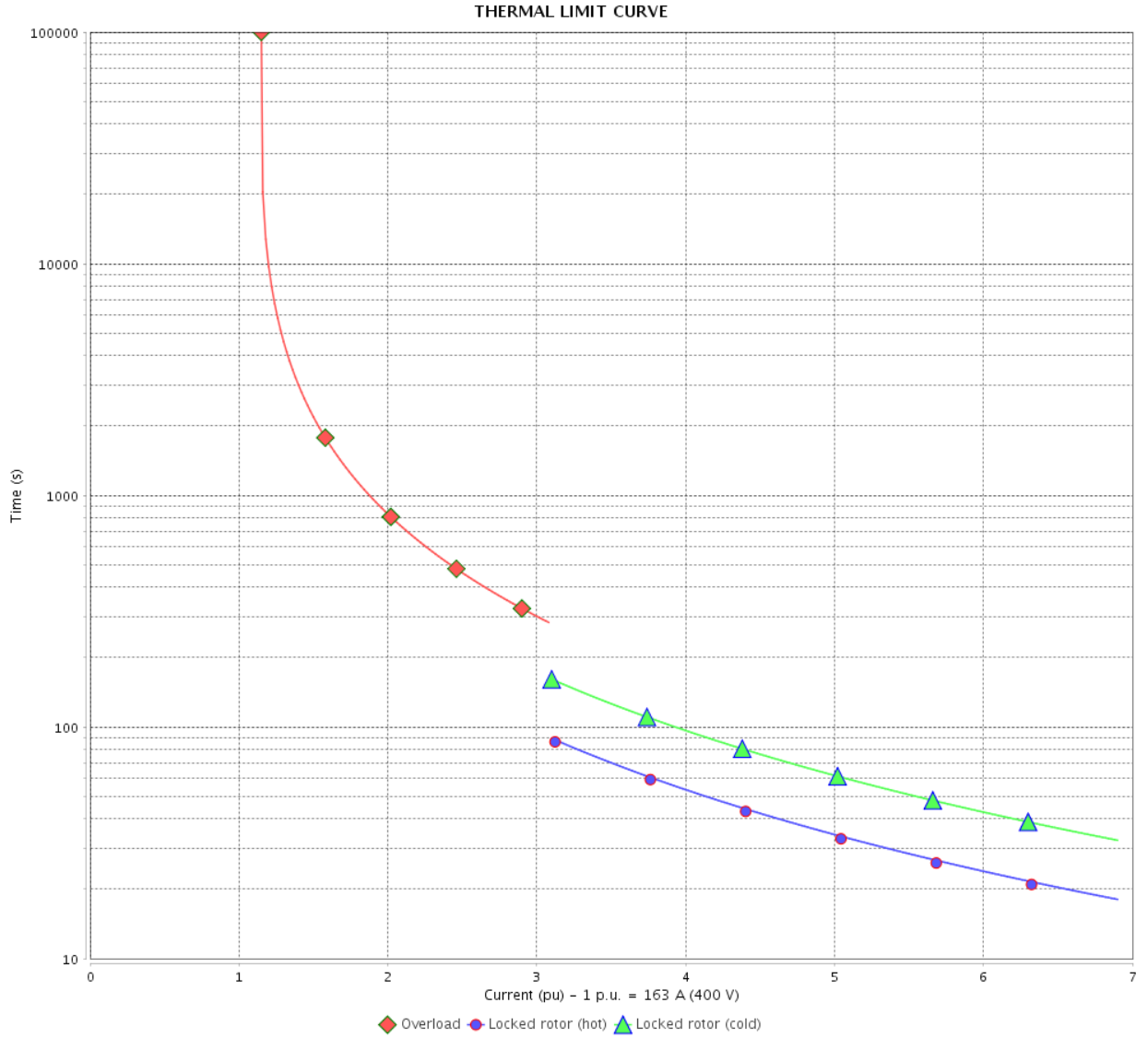

Rev.	Changes Summary	Performed	Checked	Date
Performed by		Page 21 / 36		Revision
Checked by				
Date				

THERMAL LIMIT CURVE

Three Phase Induction Motor - Squirrel Cage



Customer :

Product line : NEMA Premium Efficiency Three-Phase
Product code : 11536355
Catalog # : 15018ET3E445T-W22

Performance : 415 V 50 Hz 4P IE3

Rated current : 159 A	Moment of inertia (J) : 66.7 sq.ft.lb
LRC : 7.5	Duty cycle : Cont.(S1)
Rated torque : 444 ft.lb	Insulation class : F
Locked rotor torque : 229 %	Service factor : 1.00
Breakdown torque : 290 %	Temperature rise : 80 K
Rated speed : 1480 rpm	Design : B

Heating constant

Cooling constant

Rev.	Changes Summary	Performed	Checked	Date
Performed by			Page	Revision
Checked by				
Date				
			22 / 36	

THERMAL LIMIT CURVE

Three Phase Induction Motor - Squirrel Cage



Customer : _____

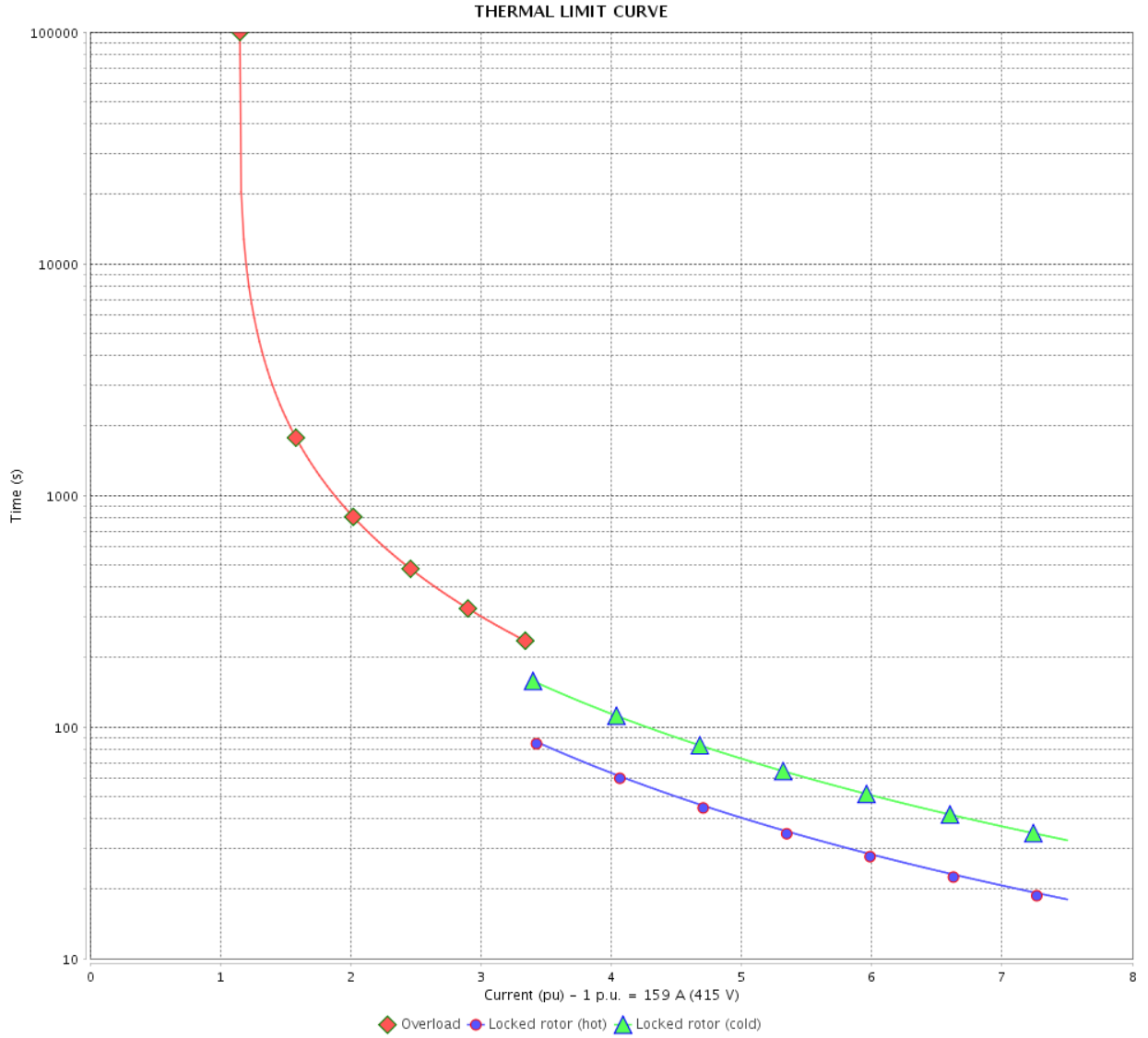

Rev.	Changes Summary	Performed	Checked	Date
Performed by		Page		Revision
Checked by		23 / 36		
Date		13/04/2022		

THERMAL LIMIT CURVE

Three Phase Induction Motor - Squirrel Cage



Customer :

Product line : NEMA Premium Efficiency Three-Phase
Product code : 11536355
Catalog # : 15018ET3E445T-W22

Performance : 380 V 50 Hz 4P IE2

Rated current	: 205 A	Moment of inertia (J)	: 66.7 sq.ft.lb
LRC	: 5.8	Duty cycle	: Cont.(S1)
Rated torque	: 534 ft.lb	Insulation class	: F
Locked rotor torque	: 160 %	Service factor	: 1.00
Breakdown torque	: 200 %	Temperature rise	: 105 K
Rated speed	: 1475 rpm	Design	: B

Heating constant

Cooling constant

Rev.	Changes Summary	Performed	Checked	Date
Performed by				
Checked by			Page	Revision
Date	13/04/2022		24 / 36	

THERMAL LIMIT CURVE

Three Phase Induction Motor - Squirrel Cage



Customer : _____

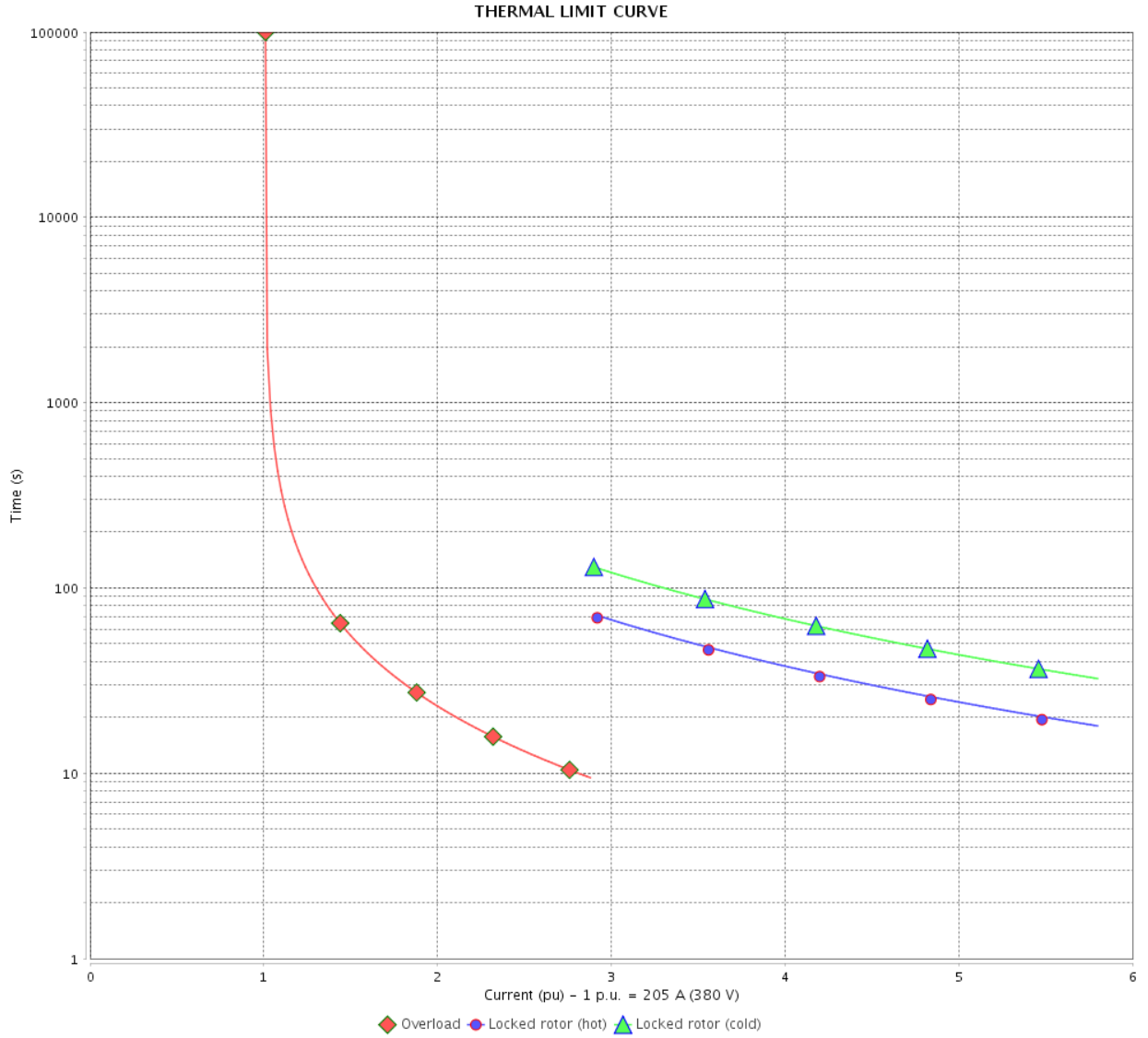

Rev.	Changes Summary	Performed	Checked	Date
Performed by		Page Revision 25 / 36		
Checked by				
Date				

THERMAL LIMIT CURVE



Three Phase Induction Motor - Squirrel Cage

Customer :

Product line : NEMA Premium Efficiency Three-Phase
Product code : 11536355
Catalog # : 15018ET3E445T-W22

Performance : 400 V 50 Hz 4P IE2

Rated current	: 194 A	Moment of inertia (J)	: 66.7 sq.ft.lb
LRC	: 5.8	Duty cycle	: Cont.(S1)
Rated torque	: 534 ft.lb	Insulation class	: F
Locked rotor torque	: 180 %	Service factor	: 1.00
Breakdown torque	: 220 %	Temperature rise	: 105 K
Rated speed	: 1475 rpm	Design	: B

Heating constant

Cooling constant

Rev.	Changes Summary	Performed	Checked	Date
Performed by				
Checked by			Page	Revision
Date	13/04/2022		26 / 36	

THERMAL LIMIT CURVE

Three Phase Induction Motor - Squirrel Cage



Customer : _____

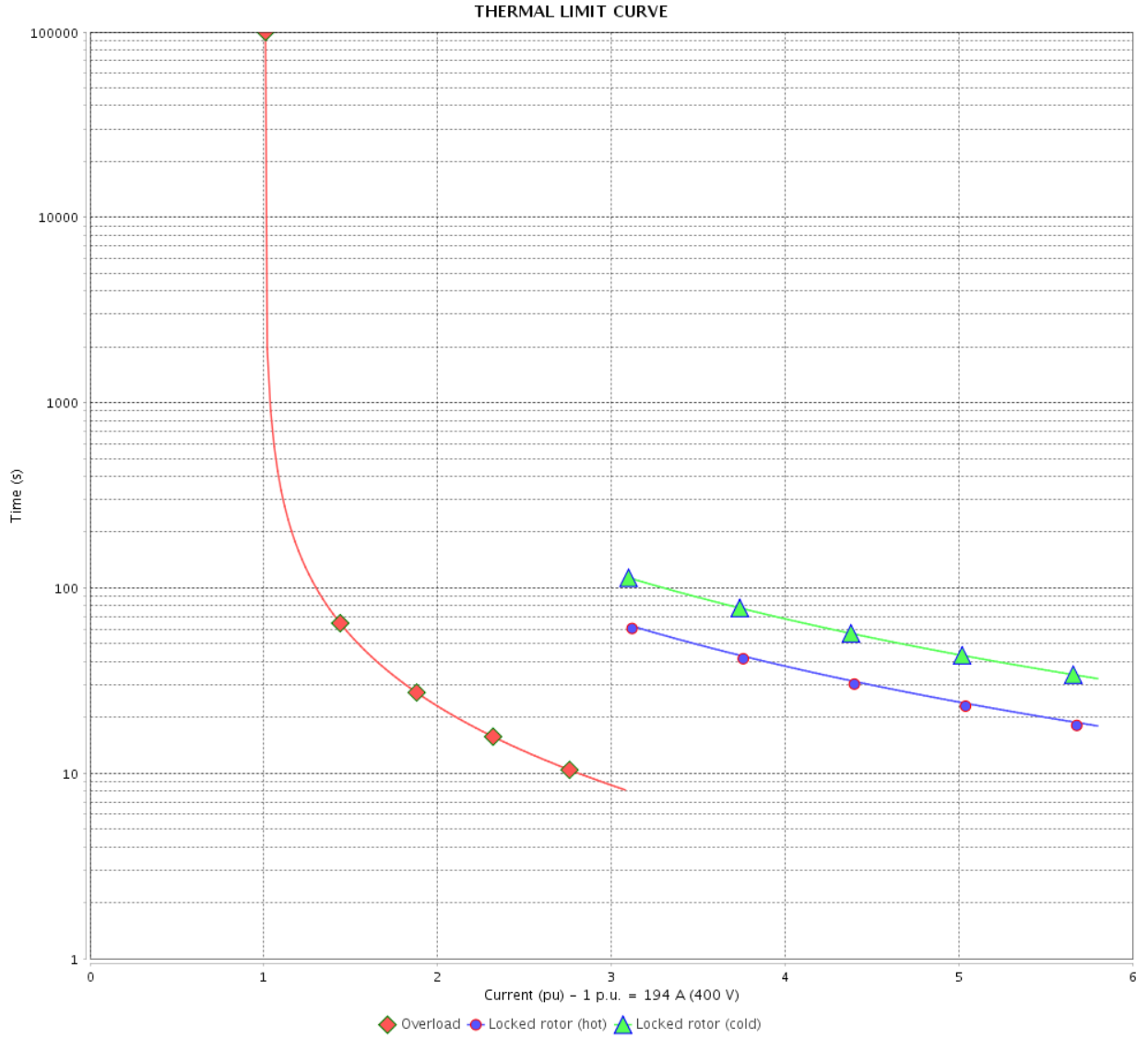

Rev.	Changes Summary	Performed	Checked	Date
Performed by		Page 27 / 36		Revision
Checked by				
Date				

THERMAL LIMIT CURVE

Three Phase Induction Motor - Squirrel Cage



Customer :

Product line : NEMA Premium Efficiency Three-Phase
Product code : 11536355
Catalog # : 15018ET3E445T-W22

Performance : 415 V 50 Hz 4P IE3

Rated current	: 189 A	Moment of inertia (J)	: 66.7 sq.ft.lb
LRC	: 6.3	Duty cycle	: Cont.(S1)
Rated torque	: 532 ft.lb	Insulation class	: F
Locked rotor torque	: 190 %	Service factor	: 1.00
Breakdown torque	: 240 %	Temperature rise	: 105 K
Rated speed	: 1480 rpm	Design	: B

Heating constant

Cooling constant

Rev.	Changes Summary	Performed	Checked	Date
Performed by				
Checked by			Page	Revision
Date	13/04/2022		28 / 36	

THERMAL LIMIT CURVE

Three Phase Induction Motor - Squirrel Cage



Customer : _____

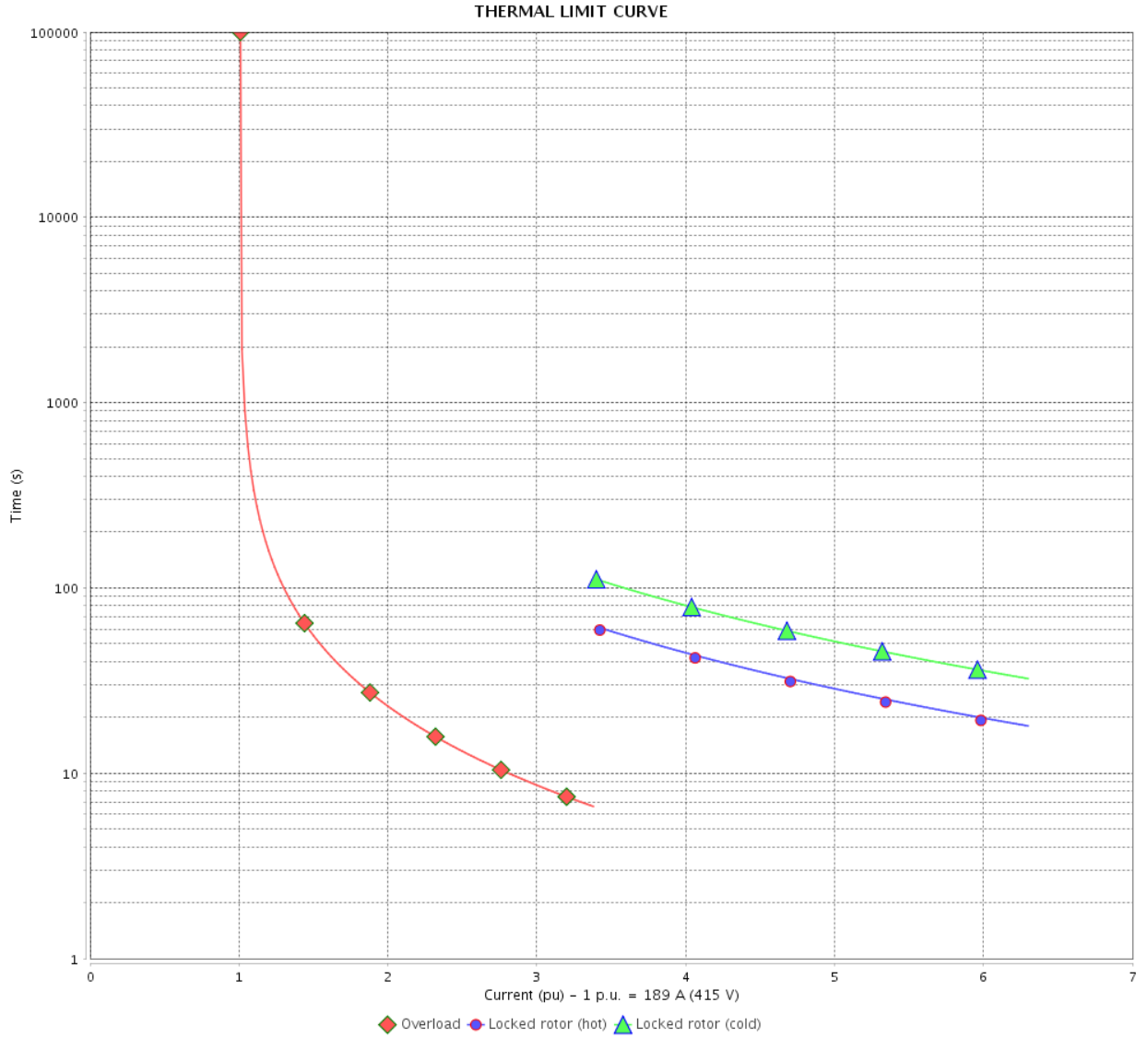

Rev.	Changes Summary	Performed	Checked	Date
Performed by		Page		Revision
Checked by		29 / 36		
Date		13/04/2022		

VFD OPERATION CURVE

Three Phase Induction Motor - Squirrel Cage



Customer : _____

Product line : NEMA Premium Efficiency Three-Phase

Product code : 11536355

Catalog # : 15018ET3E445T-W22

VFD OPERATION CURVE

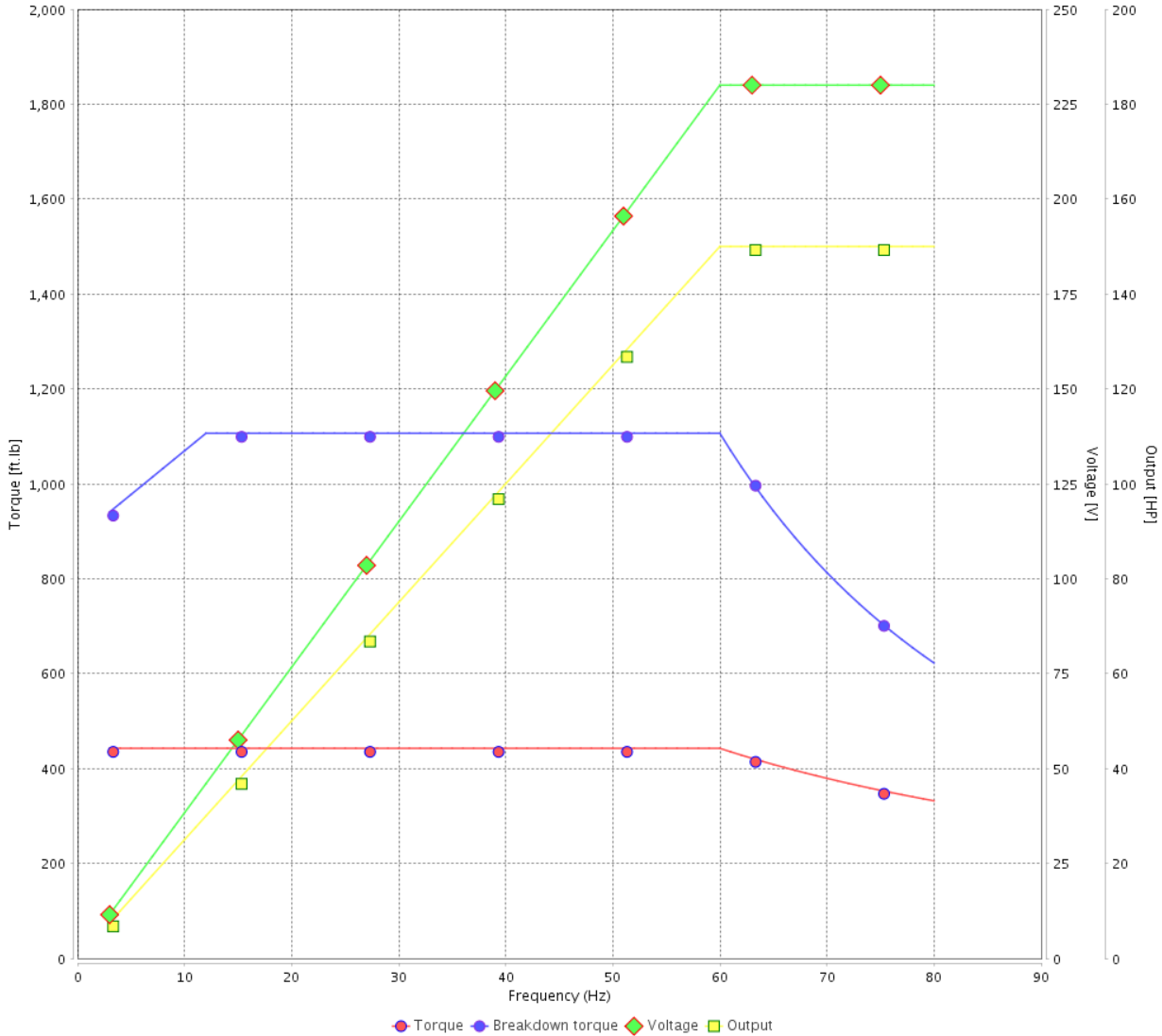

Performance : 230/460 V 60 Hz 4P

Rated current : 340/170 A
 LRC : 6.6
 Rated torque : 443 ft.lb
 Locked rotor torque : 200 %
 Breakdown torque : 250 %
 Rated speed : 1780 rpm

Moment of inertia (J) : 66.7 sq.ft.lb
 Duty cycle : Cont.(S1)
 Insulation class : F
 Service factor : 1.15
 Temperature rise : 80 K
 Design : B

Rev.	Changes Summary	Performed	Checked	Date
Performed by			Page 30 / 36	Revision
Checked by				
Date	13/04/2022			

VFD OPERATION CURVE

Three Phase Induction Motor - Squirrel Cage



Customer :

Product line : NEMA Premium Efficiency Three-Phase
 Product code : 11536355
 Catalog # : 15018ET3E445T-W22

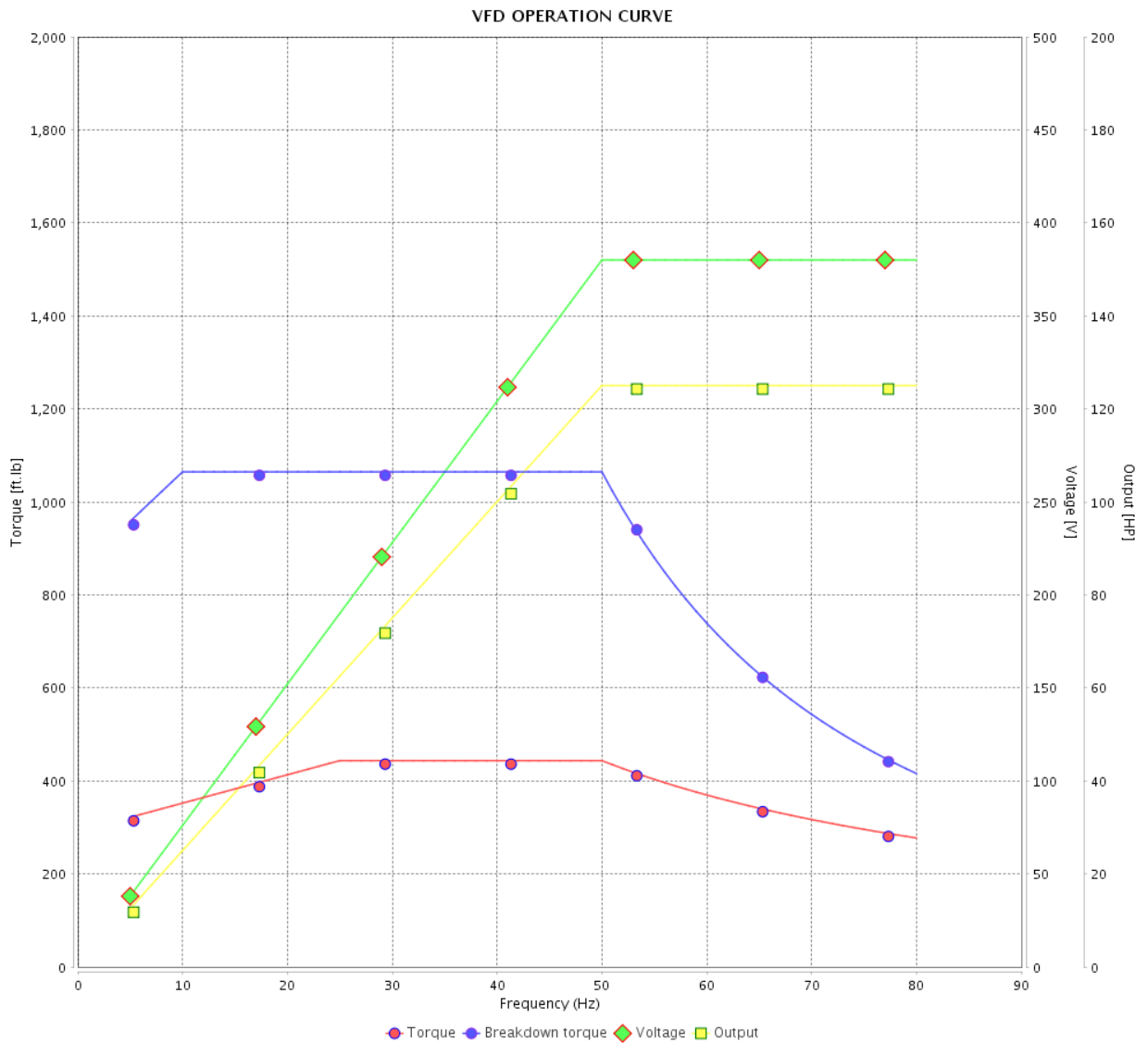

Performance : 380 V 50 Hz 4P IE3

Rated current	: 170 A	Moment of inertia (J)	: 66.7 sq.ft.lb
LRC	: 7.0	Duty cycle	: Cont.(S1)
Rated torque	: 444 ft.lb	Insulation class	: F
Locked rotor torque	: 190 %	Service factor	: 1.00
Breakdown torque	: 240 %	Temperature rise	: 80 K
Rated speed	: 1480 rpm	Design	: B

Rev.	Changes Summary	Performed	Checked	Date
Performed by		Page		Revision
Checked by		31 / 36		
Date	13/04/2022			

VFD OPERATION CURVE

Three Phase Induction Motor - Squirrel Cage



Customer :

Product line : NEMA Premium Efficiency Three-Phase

Product code : 11536355

Catalog # : 15018ET3E445T-W22

VFD OPERATION CURVE

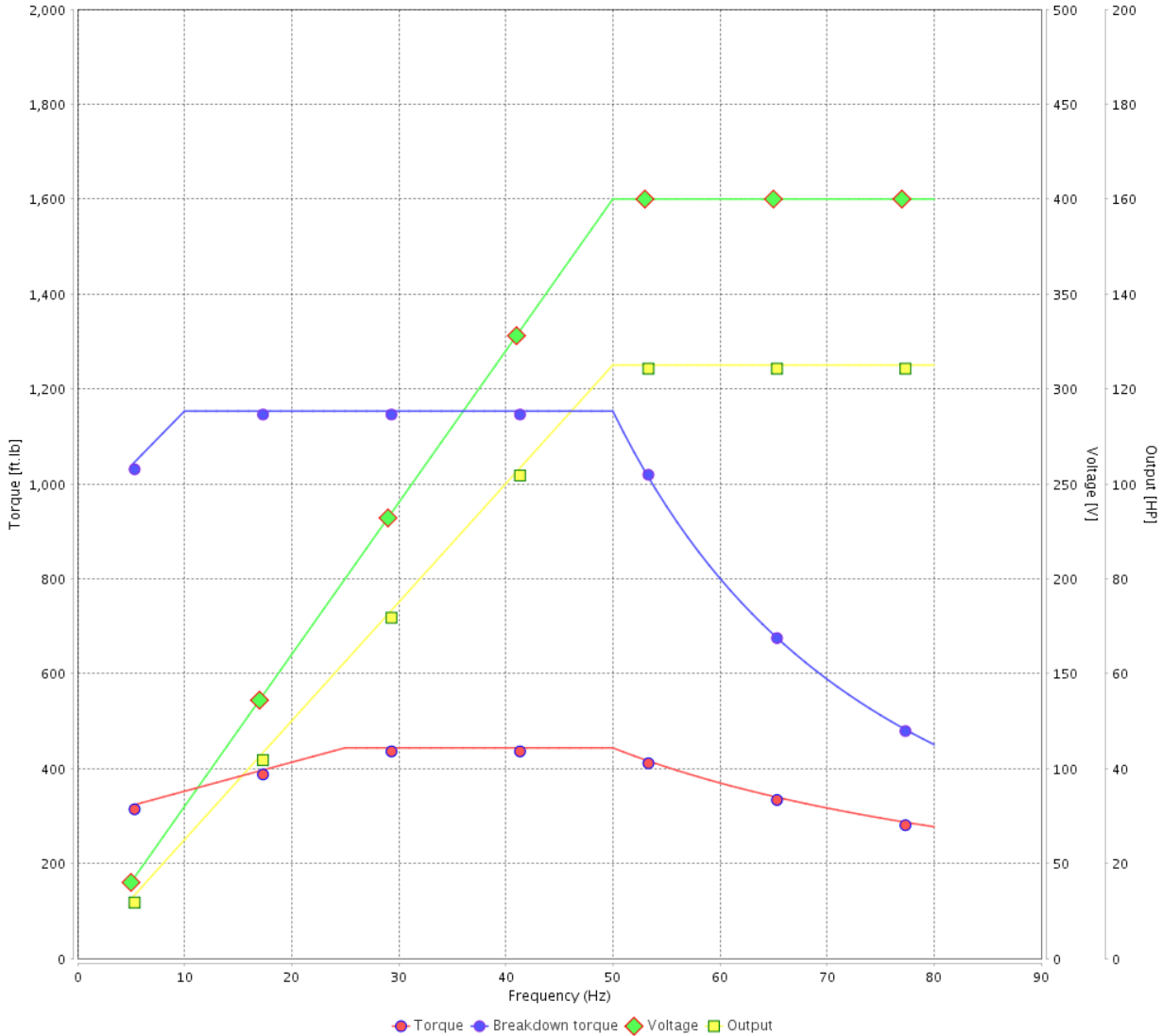

Performance : 400 V 50 Hz 4P IE3

Rated current	: 163 A	Moment of inertia (J)	: 66.7 sq.ft.lb
LRC	: 6.9	Duty cycle	: Cont.(S1)
Rated torque	: 444 ft.lb	Insulation class	: F
Locked rotor torque	: 220 %	Service factor	: 1.00
Breakdown torque	: 260 %	Temperature rise	: 80 K
Rated speed	: 1480 rpm	Design	: B

Rev.	Changes Summary	Performed	Checked	Date
Performed by			Page	Revision
Checked by			32 / 36	
Date	13/04/2022			

VFD OPERATION CURVE

Three Phase Induction Motor - Squirrel Cage



Customer :

Product line : NEMA Premium Efficiency Three-Phase

Product code : 11536355

Catalog # : 15018ET3E445T-W22

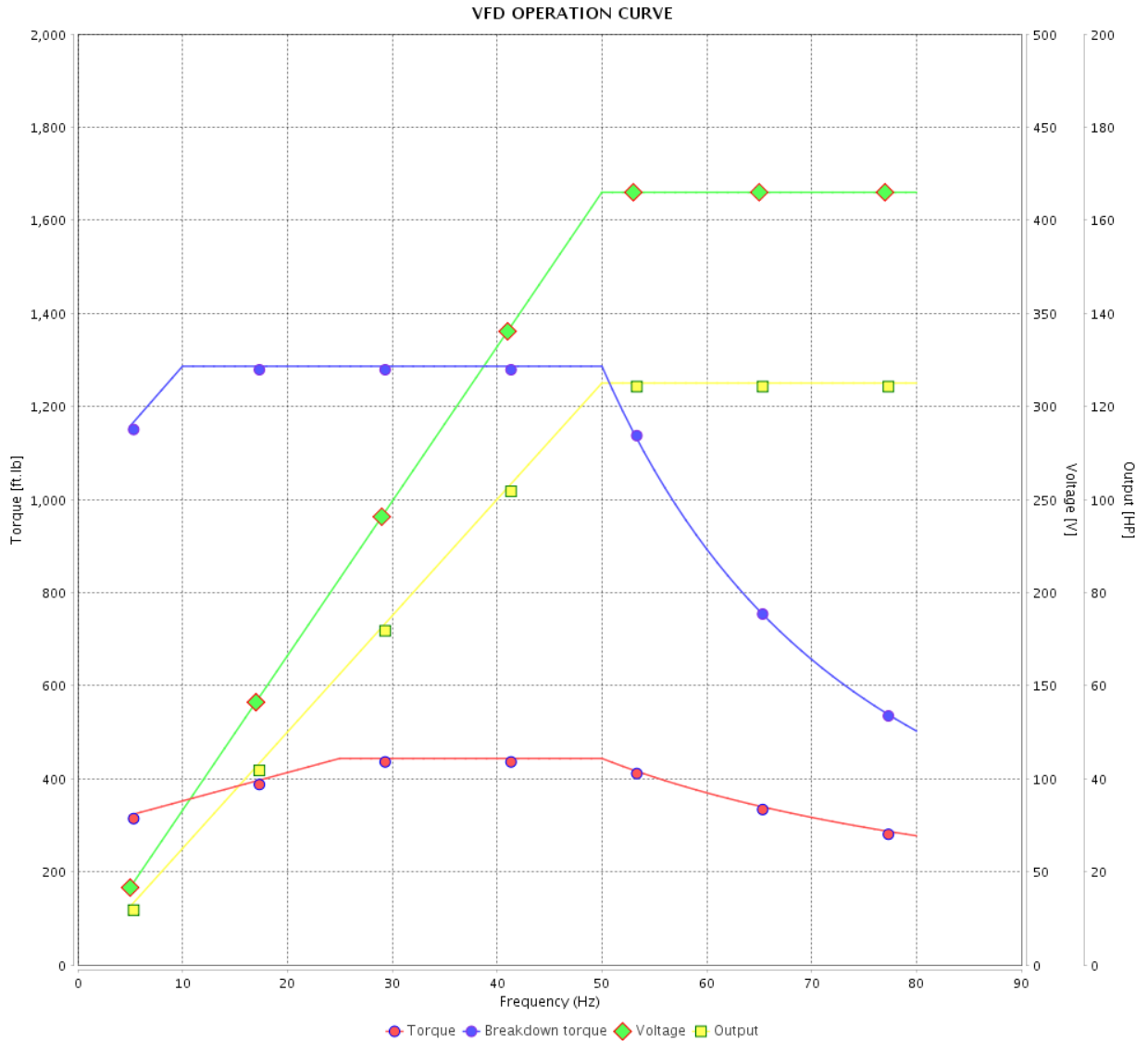

Performance : 415 V 50 Hz 4P IE3

Rated current : 159 A
 LRC : 7.5
 Rated torque : 444 ft.lb
 Locked rotor torque : 229 %
 Breakdown torque : 290 %
 Rated speed : 1480 rpm

Moment of inertia (J) : 66.7 sq.ft.lb
 Duty cycle : Cont.(S1)
 Insulation class : F
 Service factor : 1.00
 Temperature rise : 80 K
 Design : B

Rev.	Changes Summary	Performed	Checked	Date
Performed by		Page		Revision
Checked by		33 / 36		
Date		13/04/2022		

VFD OPERATION CURVE

Three Phase Induction Motor - Squirrel Cage



Customer :

Product line : NEMA Premium Efficiency Three-Phase

Product code : 11536355

Catalog # : 15018ET3E445T-W22

VFD OPERATION CURVE

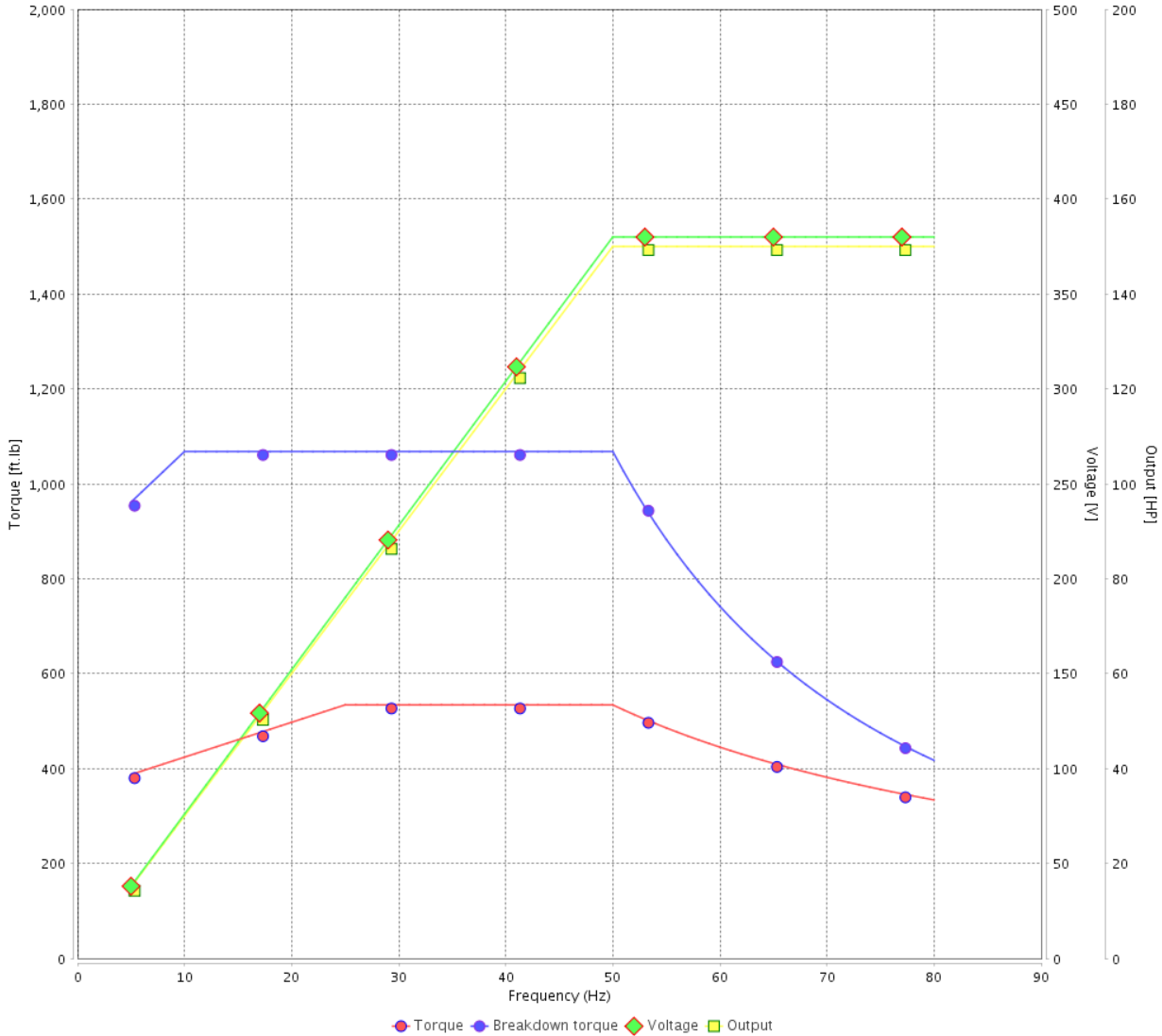

Performance : 380 V 50 Hz 4P IE2

Rated current	: 205 A	Moment of inertia (J)	: 66.7 sq.ft.lb
LRC	: 5.8	Duty cycle	: Cont.(S1)
Rated torque	: 534 ft.lb	Insulation class	: F
Locked rotor torque	: 160 %	Service factor	: 1.00
Breakdown torque	: 200 %	Temperature rise	: 105 K
Rated speed	: 1475 rpm	Design	: B

Rev.	Changes Summary	Performed	Checked	Date
Performed by			Page	Revision
Checked by			34 / 36	
Date	13/04/2022			

VFD OPERATION CURVE

Three Phase Induction Motor - Squirrel Cage



Customer : _____

Product line : NEMA Premium Efficiency Three-Phase Product code : 11536355
 Catalog # : 15018ET3E445T-W22

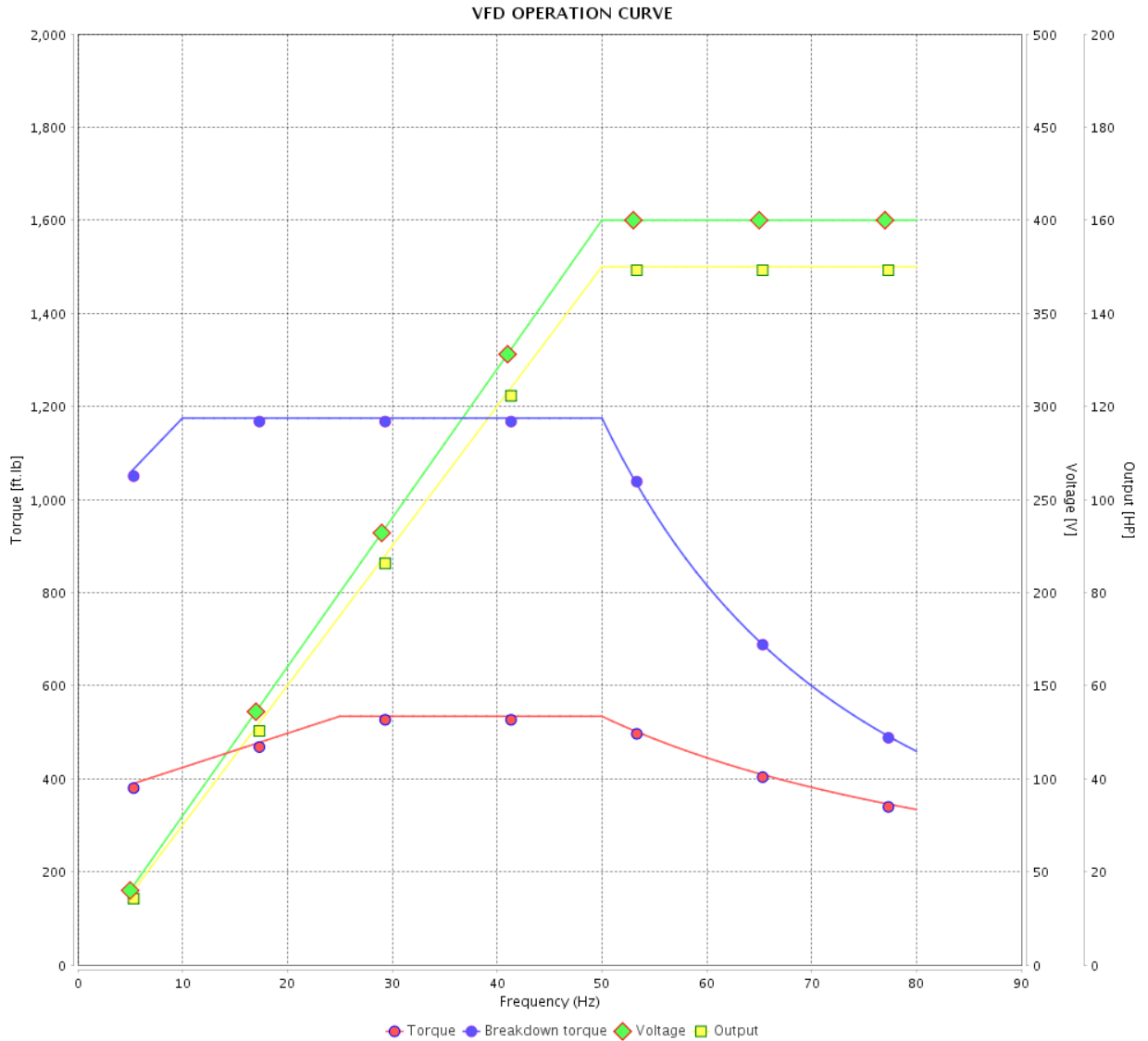

Performance : 400 V 50 Hz 4P IE2

Rated current	: 194 A	Moment of inertia (J)	: 66.7 sq.ft.lb
LRC	: 5.8	Duty cycle	: Cont.(S1)
Rated torque	: 534 ft.lb	Insulation class	: F
Locked rotor torque	: 180 %	Service factor	: 1.00
Breakdown torque	: 220 %	Temperature rise	: 105 K
Rated speed	: 1475 rpm	Design	: B

Rev.	Changes Summary	Performed	Checked	Date
Performed by			Page 35 / 36	Revision
Checked by				
Date	13/04/2022			

VFD OPERATION CURVE

Three Phase Induction Motor - Squirrel Cage



Customer : _____

Product line : NEMA Premium Efficiency Three-Phase

Product code : 11536355

Catalog # : 15018ET3E445T-W22

VFD OPERATION CURVE

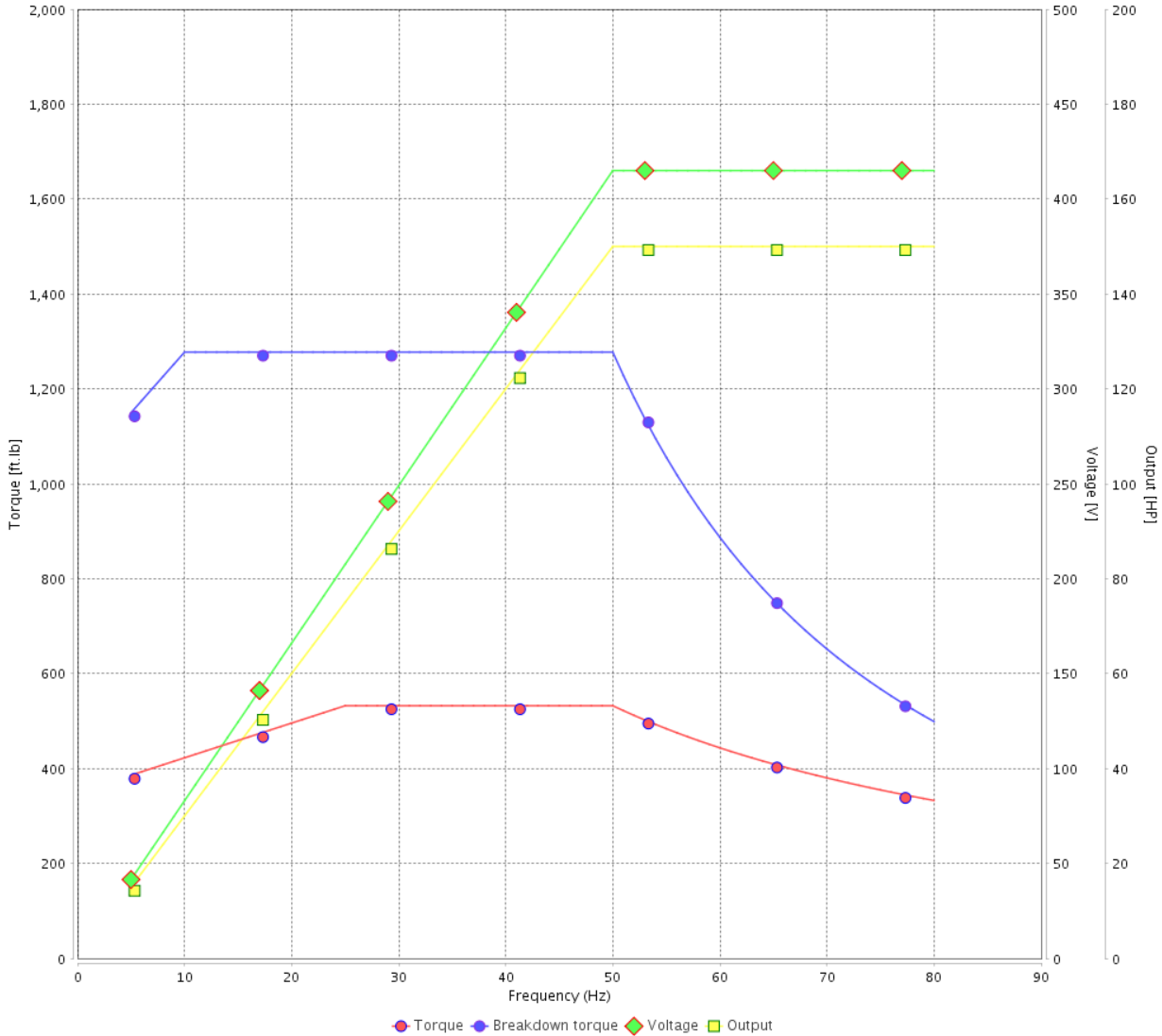

Performance : 415 V 50 Hz 4P IE3

Rated current : 189 A
 LRC : 6.3
 Rated torque : 532 ft.lb
 Locked rotor torque : 190 %
 Breakdown torque : 240 %
 Rated speed : 1480 rpm

Moment of inertia (J) : 66.7 sq.ft.lb
 Duty cycle : Cont.(S1)
 Insulation class : F
 Service factor : 1.00
 Temperature rise : 105 K
 Design : B

Rev.	Changes Summary	Performed	Checked	Date
Performed by			Page 36 / 36	Revision
Checked by				
Date	13/04/2022			

1 2 3 4 5 6

A

B

C

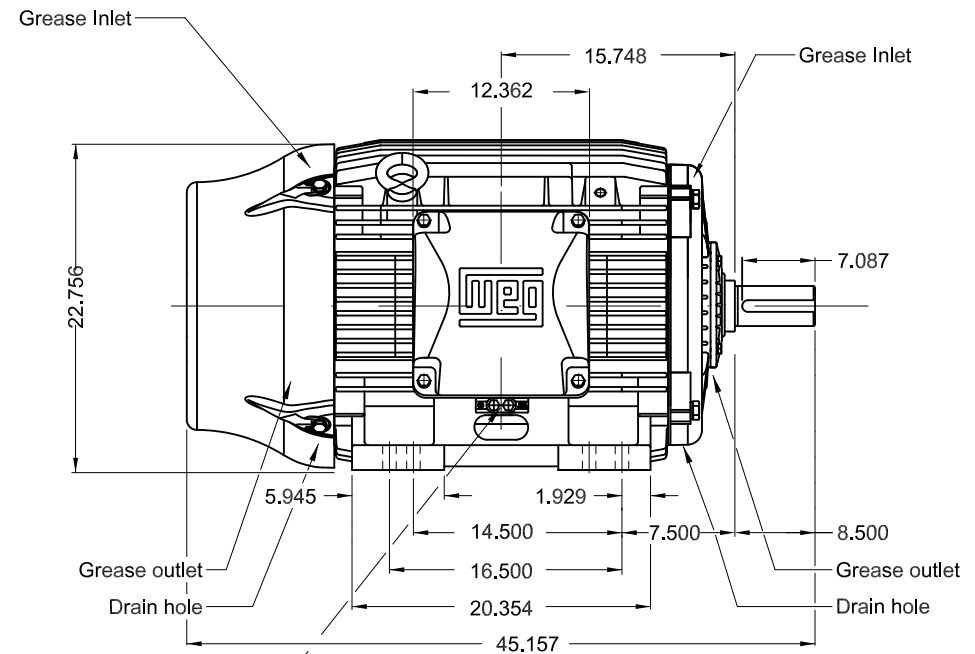
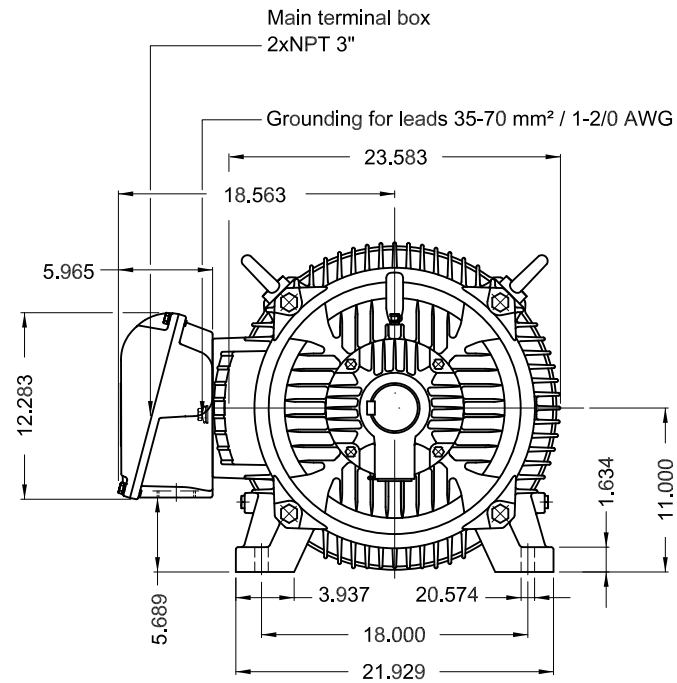

Grounding for leads 25-185 mm² / 3AWG-350MCM

D

E

150 HP 04 Poles 60 Hz A

Color RAL 5009
Painting plan 203A
Mounting B3R(D)

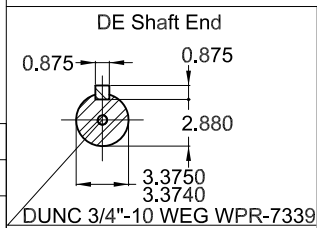

ECM	LOC	SUMMARY OF MODIFICATIONS	EXECUTED	CHECKED	RELEASED	DATE	VER
EXECUTED	PIRWUSER	THREE PH. MOTOR W22 PREM. EFF.					
CHECKED		FRAME 444/5T IP55 TEFC					
RELEASED							
REL DT.	WMO	Jaragua do Sul	Product Engineering	SHEET	1 / 1		

PREVIEW
WDD





FOR SAFE AREA
Mod.TE1BFOXON
CC029A



For use on 60Hz
Class I, Div 2, Gr A, B, C and D - T3
Class I, Zone 2, IIC - T3
Class II, Div 2, Gr F and G - T3C
For use on PWM: Gr. A, B, C, D and F,
VT 1000:1, CT 20:1, 1.00SF - T3A

MODEL 15018ET3E445T-W22

Inverter Duty Motor
Severe Duty

PH3 60Hz Fr. 444/5T 1000m.a.s.l. IP55 TEFC 1855lb

V 230/460

A 340/170

HP 150

kW 110

SF 1.15

SFA 391/195

RPM 1780

PF 0.85

AMB 40°C

INS cl. F DT80K

NEMA NOM EFF 95.8%

DUTY CONT.

DES B Code G

USABLE @208V 376A SF 1.00

150HP 110kW 50Hz 380V 205A 1475RPM SF 1.00 EFF 95.0% (IE2)

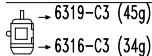
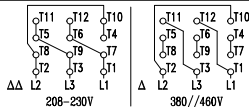

MOBIL POLYREX EM (8000h)

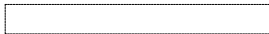

MADE IN MEXICO
11536355