

DATA SHEET



Three Phase Induction Motor - Squirrel Cage

Customer							
Product line	: NEMA Premium Efficiency Three-Phase	Product code	: 13693143				
		Catalog #	: 15018ET3E445TC-W22G				
Frame	: 444/5TC	Cooling method	: IC411 - TEFC				
Insulation class	: F	Mounting	: F-1				
Duty cycle	: Cont.(S1)	Rotation ¹	: Both (CW and CCW)				
Ambient temperature	: -20°C to +40°C	Starting method	: Direct On Line				
Altitude	: 1000 m.a.s.l.	Approx. weight ²	: 1676 lb				
Protection degree	: IP55	Moment of inertia (J)	: 66.7 sq.ft.lb				
Design	: B						
Output [HP]	150	125	125	125	150	150	150
Poles	4	4	4	4	4	4	4
Frequency [Hz]	60	50	50	50	50	50	50
Rated voltage [V]	230/460	380	400	415	380	400	415
Rated current [A]	340/170	170	163	159	205	194	189
L. R. Amperes [A]	2244/1122	1190	1127	1192	1189	1125	1191
LRC [A]	6.6x(Code G)	7.0x(Code G)	6.9x(Code G)	7.5x(Code H)	5.8x(Code F)	5.8x(Code F)	6.3x(Code G)
No load current [A]	116/58.0	58.0	61.2	64.0	58.0	61.2	64.0
Rated speed [RPM]	1780	1480	1480	1480	1475	1475	1480
Slip [%]	1.11	1.33	1.33	1.33	1.67	1.67	1.33
Rated torque [ft.lb]	443	444	444	444	534	534	532
Locked rotor torque [%]	200	190	220	229	160	180	190
Breakdown torque [%]	250	240	260	290	200	220	240
Service factor	1.15	1.00	1.00	1.00	1.00	1.00	1.00
Temperature rise	80 K	80 K	80 K	80 K	105 K	105 K	105 K
Locked rotor time	48s (cold) 27s (hot)	32s (cold) 18s (hot)	32s (cold) 18s (hot)	32s (cold) 18s (hot)	32s (cold) 18s (hot)	32s (cold) 18s (hot)	32s (cold) 18s (hot)
Noise level ²	73.0 dB(A)	69.0 dB(A)	69.0 dB(A)	69.0 dB(A)	69.0 dB(A)	69.0 dB(A)	69.0 dB(A)
Efficiency (%)	25%	95.3	95.1	95.1	94.6	95.6	95.3
	50%	95.4	95.1	95.1	94.8	95.4	95.4
	75%	95.8	95.5	95.5	95.5	95.4	95.4
	100%	95.8	95.3	95.3	95.5	95.0	95.4
Power Factor	25%	0.49	0.49	0.45	0.43	0.55	0.49
	50%	0.74	0.73	0.70	0.68	0.79	0.74
	75%	0.82	0.83	0.81	0.79	0.85	0.82
	100%	0.85	0.86	0.85	0.84	0.86	0.85
Bearing type	: Drive end 6319 C3	Non drive end 6316 C3	Foundation loads				
Sealing	: WSeal	WSeal	Max. traction : 2567 lb				
Lubrication interval	: 8000 h	10000 h	Max. compression : 4243 lb				
Lubricant amount	: 45 g	34 g					
Lubricant type	: Mobil Polyrex EM						
Notes							
USABLE @208V 376A SF 1.00 SFA 376A							
This revision replaces and cancel the previous one, which must be eliminated. (1) Looking the motor from the shaft end. (2) Measured at 1m and with tolerance of +3dB(A). (3) Approximate weight subject to changes after manufacturing process. (4) At 100% of full load.				These are average values based on tests with sinusoidal power supply, subject to the tolerances stipulated in NEMA MG-1.			
Rev.	Changes Summary			Performed	Checked	Date	
Performed by							
Checked by					Page	Revision	
Date	13/04/2022				1 / 36		

TORQUE AND CURRENT VS SPEED CURVE

Three Phase Induction Motor - Squirrel Cage



Customer :

Product line : NEMA Premium Efficiency Three-Phase

Product code : 13693143

Catalog # : 15018ET3E445TC-W22G

TORQUE AND CURRENT VS SPEED CURVE

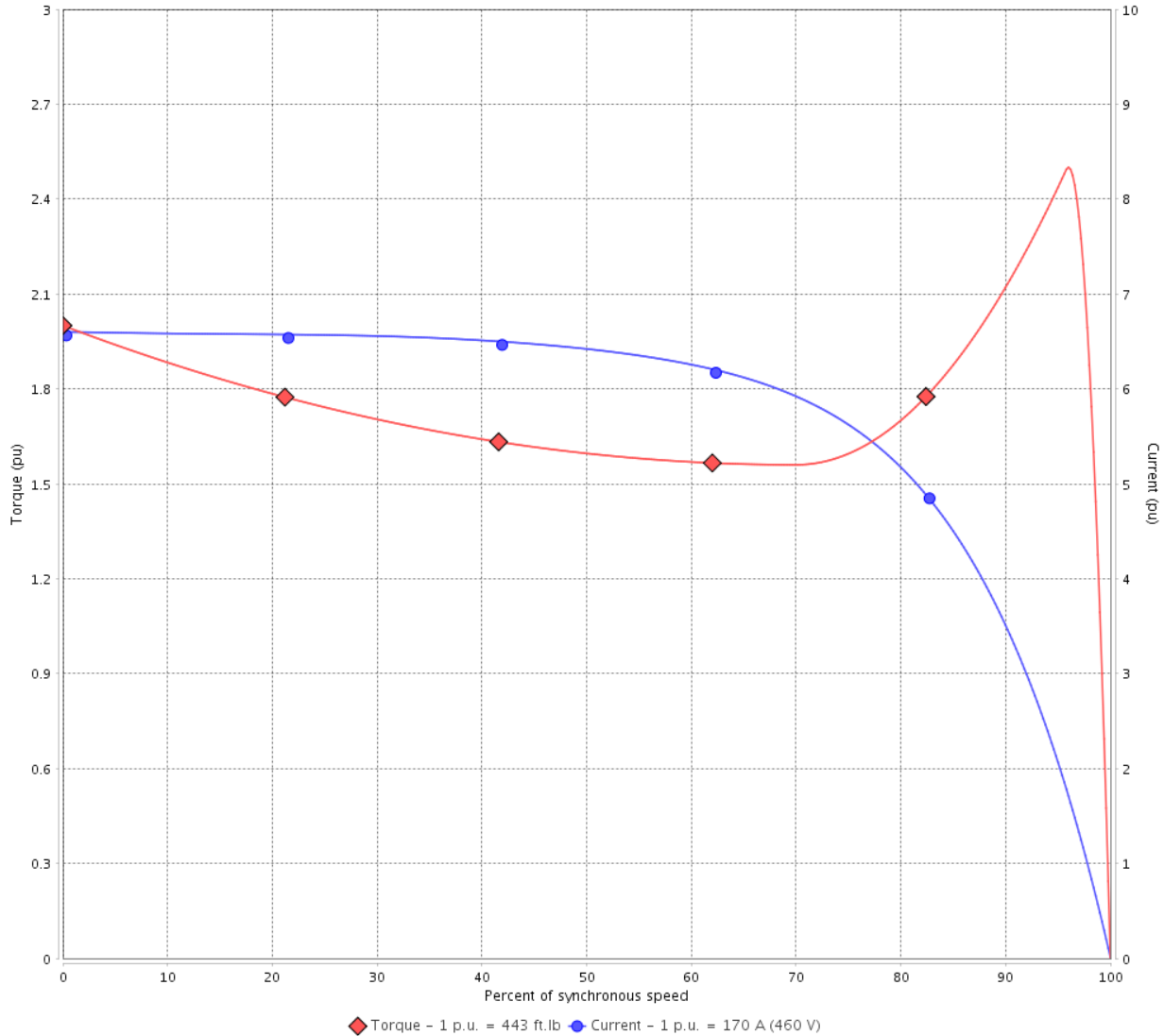

Performance : 230/460 V 60 Hz 4P

Rated current	: 340/170 A	Moment of inertia (J)	: 66.7 sq.ft.lb
LRC	: 6.6	Duty cycle	: Cont.(S1)
Rated torque	: 443 ft.lb	Insulation class	: F
Locked rotor torque	: 200 %	Service factor	: 1.15
Breakdown torque	: 250 %	Temperature rise	: 80 K
Rated speed	: 1780 rpm	Design	: B

Locked rotor time : 48s (cold) 27s (hot)

Rev.	Changes Summary	Performed	Checked	Date
Performed by			Page 2 / 36	Revision
Checked by				
Date	13/04/2022			

TORQUE AND CURRENT VS SPEED CURVE



Three Phase Induction Motor - Squirrel Cage

Customer :

Product line : NEMA Premium Efficiency Three-Phase
 Product code : 13693143
 Catalog # : 15018ET3E445TC-W22G

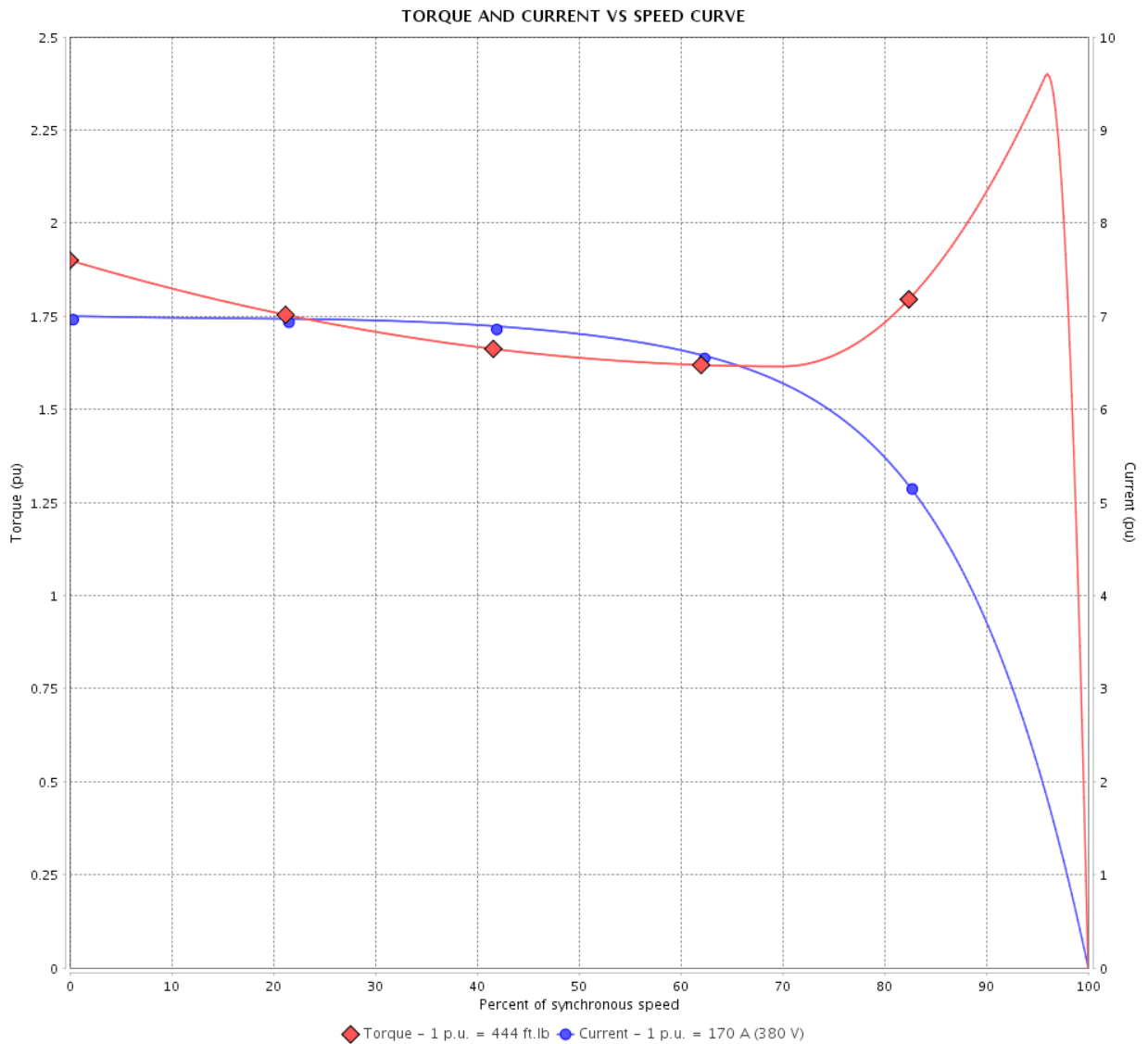

Performance : 380 V 50 Hz 4P IE3

Rated current	: 170 A	Moment of inertia (J)	: 66.7 sq.ft.lb
LRC	: 7.0	Duty cycle	: Cont.(S1)
Rated torque	: 444 ft.lb	Insulation class	: F
Locked rotor torque	: 190 %	Service factor	: 1.00
Breakdown torque	: 240 %	Temperature rise	: 80 K
Rated speed	: 1480 rpm	Design	: B

Locked rotor time : 32s (cold) 18s (hot)

Rev.	Changes Summary	Performed	Checked	Date
Performed by			Page 3 / 36	Revision
Checked by				
Date	13/04/2022			

TORQUE AND CURRENT VS SPEED CURVE

Three Phase Induction Motor - Squirrel Cage



Customer :

Product line : NEMA Premium Efficiency Three-Phase

Product code : 13693143

Catalog # : 15018ET3E445TC-W22G

TORQUE AND CURRENT VS SPEED CURVE

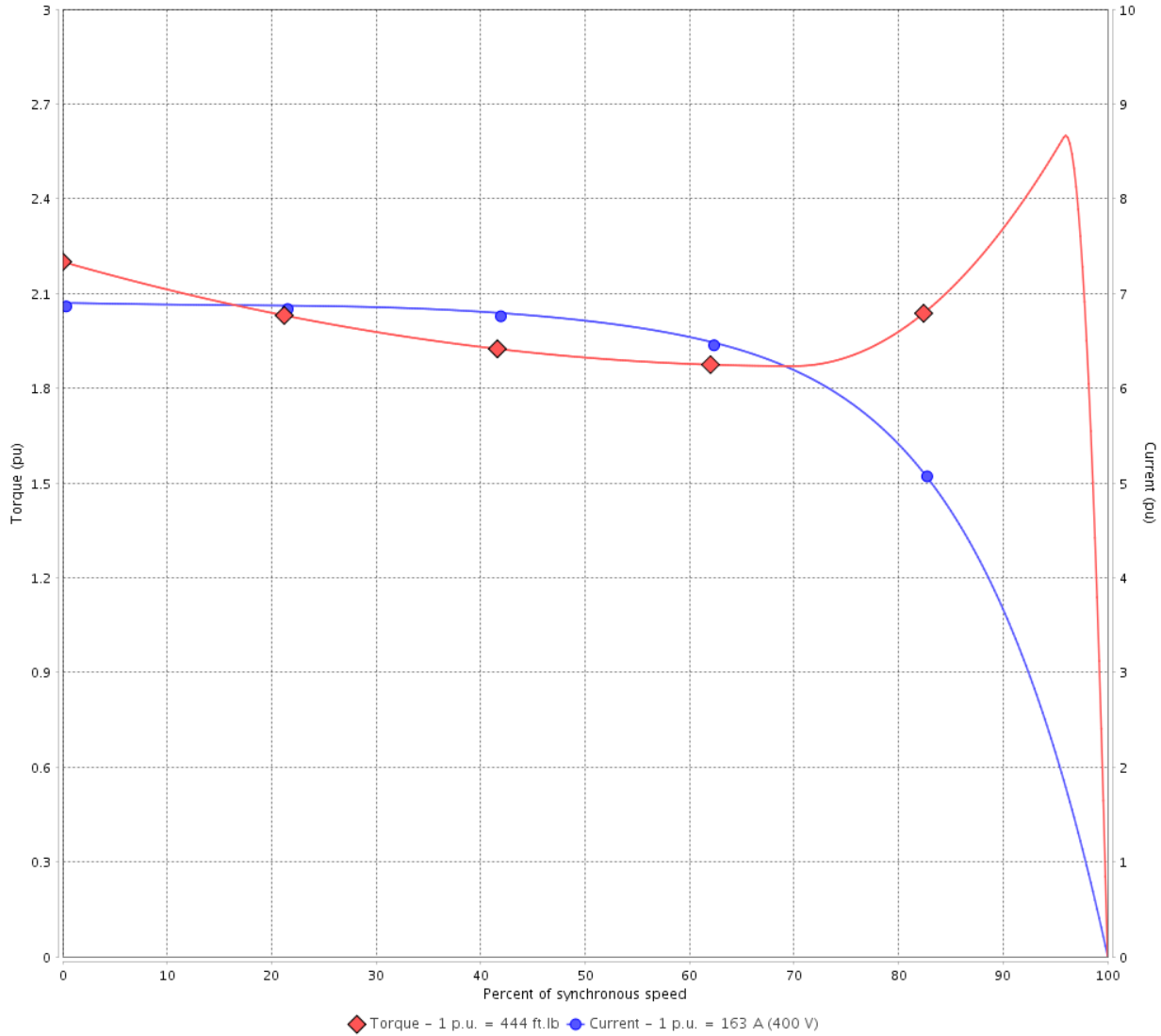

Performance : 400 V 50 Hz 4P IE3

Rated current	: 163 A	Moment of inertia (J)	: 66.7 sq.ft.lb
LRC	: 6.9	Duty cycle	: Cont.(S1)
Rated torque	: 444 ft.lb	Insulation class	: F
Locked rotor torque	: 220 %	Service factor	: 1.00
Breakdown torque	: 260 %	Temperature rise	: 80 K
Rated speed	: 1480 rpm	Design	: B

Locked rotor time : 32s (cold) 18s (hot)

Rev.	Changes Summary	Performed	Checked	Date
Performed by			Page 4 / 36	Revision
Checked by				
Date	13/04/2022			

TORQUE AND CURRENT VS SPEED CURVE



Three Phase Induction Motor - Squirrel Cage

Customer :

Product line : NEMA Premium Efficiency Three-Phase

Product code : 13693143

Catalog # : 15018ET3E445TC-W22G

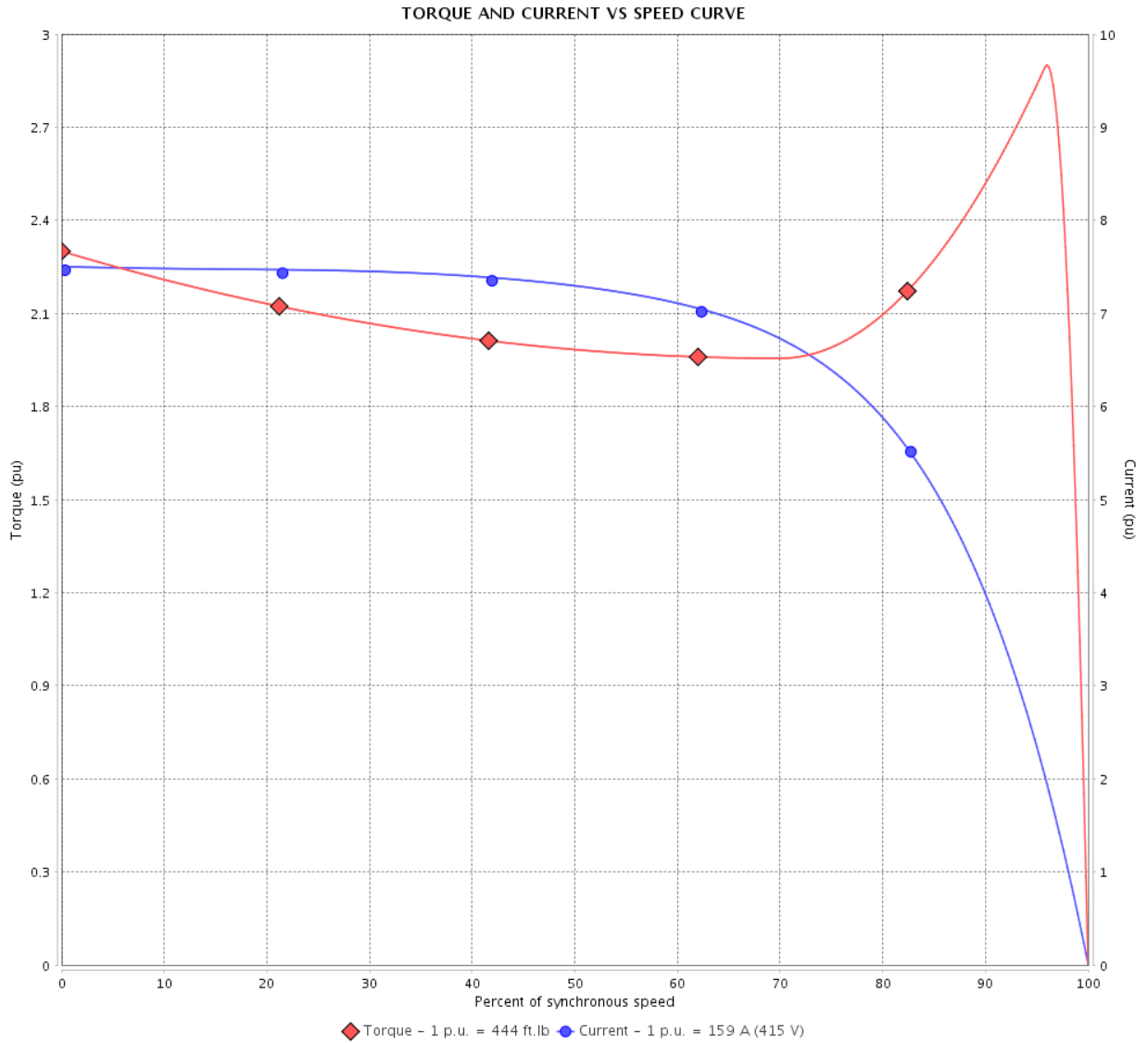

Performance : 415 V 50 Hz 4P IE3

Rated current	: 159 A	Moment of inertia (J)	: 66.7 sq.ft.lb
LRC	: 7.5	Duty cycle	: Cont.(S1)
Rated torque	: 444 ft.lb	Insulation class	: F
Locked rotor torque	: 229 %	Service factor	: 1.00
Breakdown torque	: 290 %	Temperature rise	: 80 K
Rated speed	: 1480 rpm	Design	: B

Locked rotor time : 32s (cold) 18s (hot)

Rev.	Changes Summary	Performed	Checked	Date
Performed by			Page 5 / 36	Revision
Checked by				
Date	13/04/2022			

TORQUE AND CURRENT VS SPEED CURVE

Three Phase Induction Motor - Squirrel Cage



Customer :

Product line : NEMA Premium Efficiency Three-Phase

Product code : 13693143

Catalog # : 15018ET3E445TC-W22G

TORQUE AND CURRENT VS SPEED CURVE

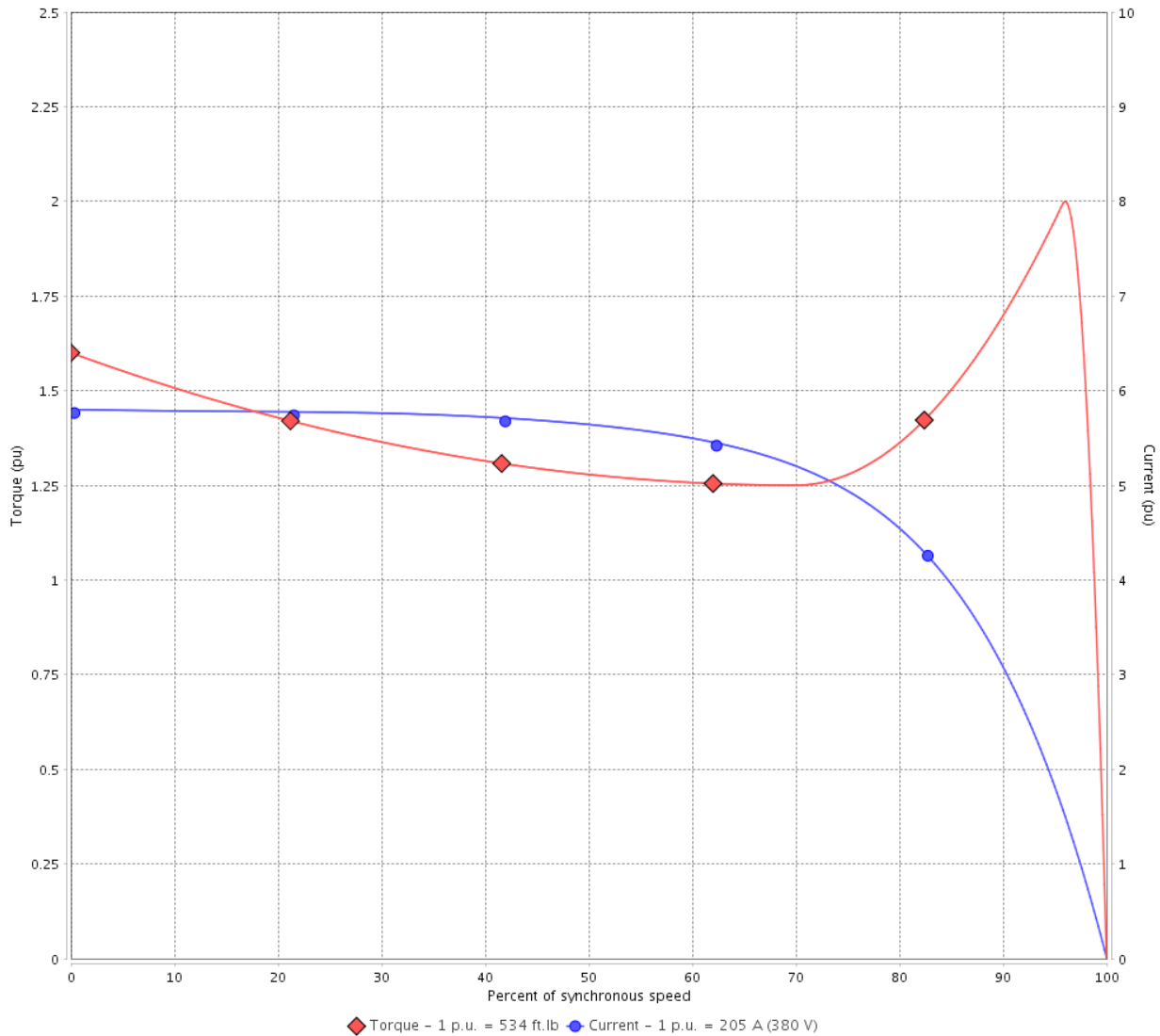

Performance : 380 V 50 Hz 4P IE2

Rated current	: 205 A	Moment of inertia (J)	: 66.7 sq.ft.lb
LRC	: 5.8	Duty cycle	: Cont.(S1)
Rated torque	: 534 ft.lb	Insulation class	: F
Locked rotor torque	: 160 %	Service factor	: 1.00
Breakdown torque	: 200 %	Temperature rise	: 105 K
Rated speed	: 1475 rpm	Design	: B

Locked rotor time : 32s (cold) 18s (hot)

Rev.	Changes Summary	Performed	Checked	Date
Performed by			Page 6 / 36	Revision
Checked by				
Date	13/04/2022			

TORQUE AND CURRENT VS SPEED CURVE



Three Phase Induction Motor - Squirrel Cage

Customer :

Product line : NEMA Premium Efficiency Three-Phase

Product code : 13693143

Catalog # : 15018ET3E445TC-W22G

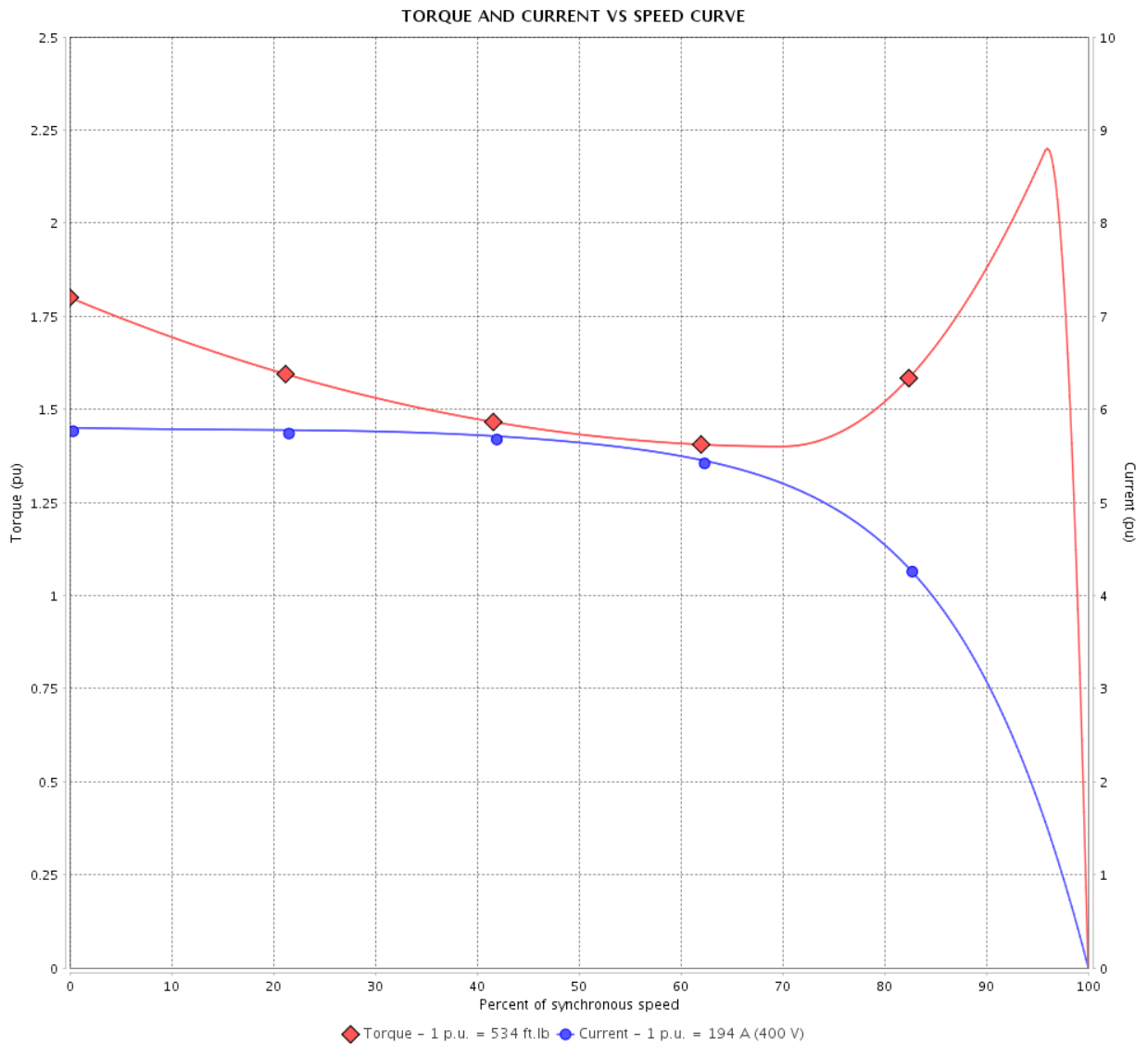

Performance : 400 V 50 Hz 4P IE2

Rated current	: 194 A	Moment of inertia (J)	: 66.7 sq.ft.lb
LRC	: 5.8	Duty cycle	: Cont.(S1)
Rated torque	: 534 ft.lb	Insulation class	: F
Locked rotor torque	: 180 %	Service factor	: 1.00
Breakdown torque	: 220 %	Temperature rise	: 105 K
Rated speed	: 1475 rpm	Design	: B

Locked rotor time : 32s (cold) 18s (hot)

Rev.	Changes Summary	Performed	Checked	Date
Performed by			Page 7 / 36	Revision
Checked by				
Date	13/04/2022			

TORQUE AND CURRENT VS SPEED CURVE

Three Phase Induction Motor - Squirrel Cage



Customer :

Product line : NEMA Premium Efficiency Three-Phase

Product code : 13693143

Catalog # : 15018ET3E445TC-W22G

TORQUE AND CURRENT VS SPEED CURVE

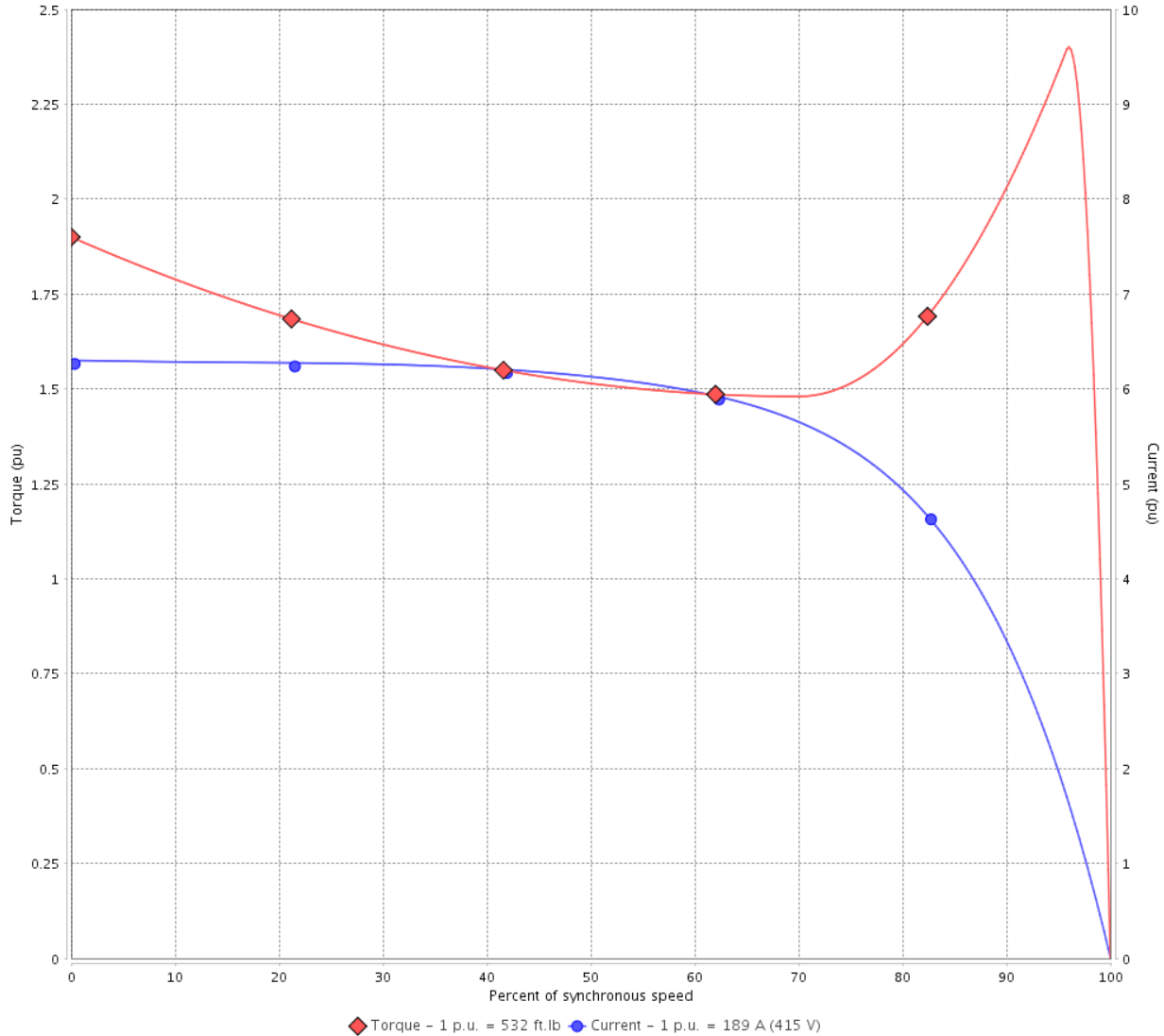

Performance : 415 V 50 Hz 4P IE3

Rated current	: 189 A	Moment of inertia (J)	: 66.7 sq.ft.lb
LRC	: 6.3	Duty cycle	: Cont.(S1)
Rated torque	: 532 ft.lb	Insulation class	: F
Locked rotor torque	: 190 %	Service factor	: 1.00
Breakdown torque	: 240 %	Temperature rise	: 105 K
Rated speed	: 1480 rpm	Design	: B

Locked rotor time : 32s (cold) 18s (hot)

Rev.	Changes Summary	Performed	Checked	Date
Performed by			Page 8 / 36	Revision
Checked by				
Date	13/04/2022			

LOAD PERFORMANCE CURVE

Three Phase Induction Motor - Squirrel Cage



Customer :

Product line : NEMA Premium Efficiency Three-Phase

Product code : 13693143

Catalog # : 15018ET3E445TC-W22G

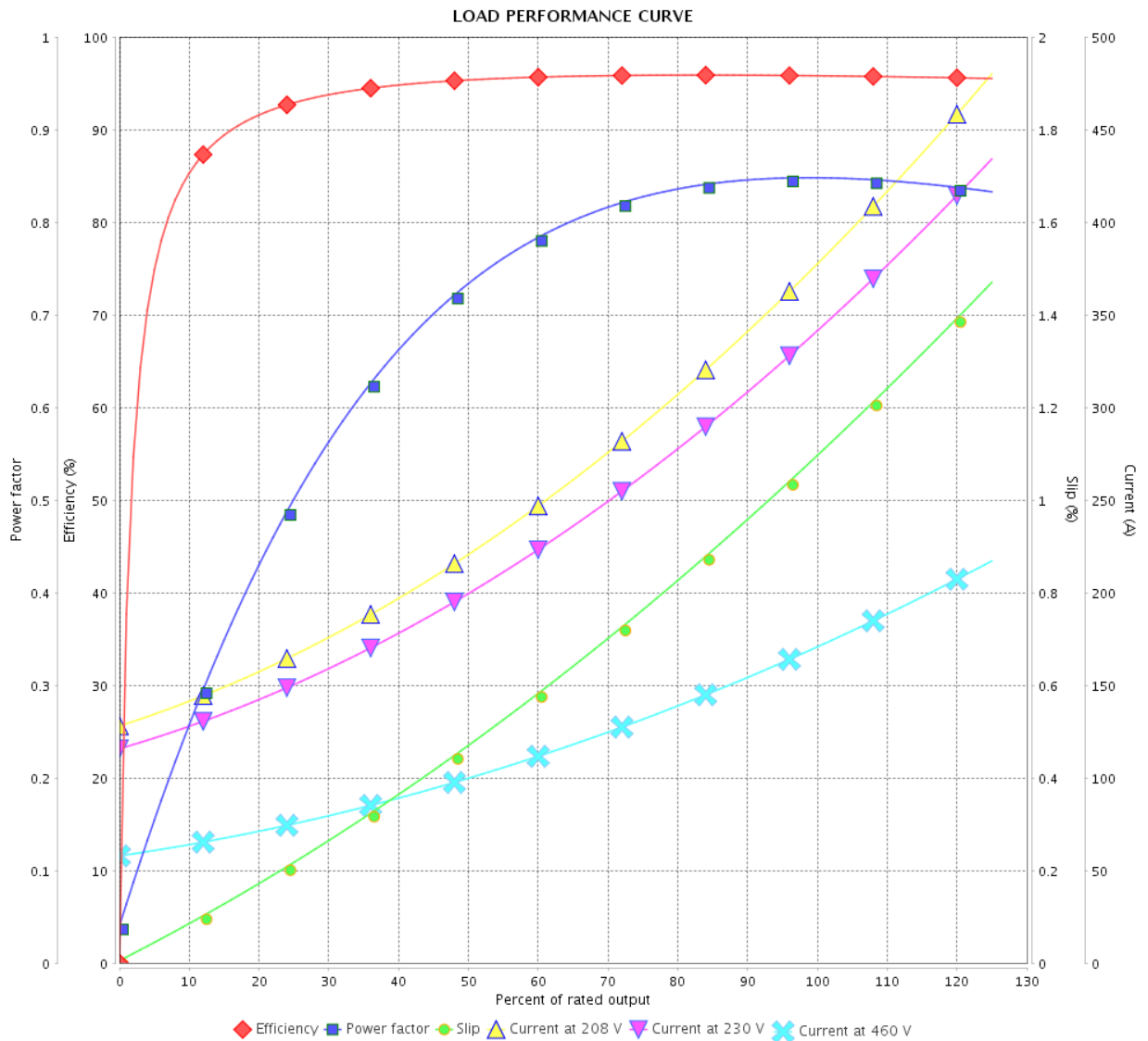

Performance : 230/460 V 60 Hz 4P

Rated current : 340/170 A
 LRC : 6.6
 Rated torque : 443 ft.lb
 Locked rotor torque : 200 %
 Breakdown torque : 250 %
 Rated speed : 1780 rpm

Moment of inertia (J) : 66.7 sq.ft.lb
 Duty cycle : Cont.(S1)
 Insulation class : F
 Service factor : 1.15
 Temperature rise : 80 K
 Design : B

Rev.	Changes Summary	Performed	Checked	Date
Performed by			Page	Revision
Checked by				
Date				

LOAD PERFORMANCE CURVE

Three Phase Induction Motor - Squirrel Cage



Customer :

Product line : NEMA Premium Efficiency Three-Phase

Product code : 13693143

Catalog # : 15018ET3E445TC-W22G

LOAD PERFORMANCE CURVE

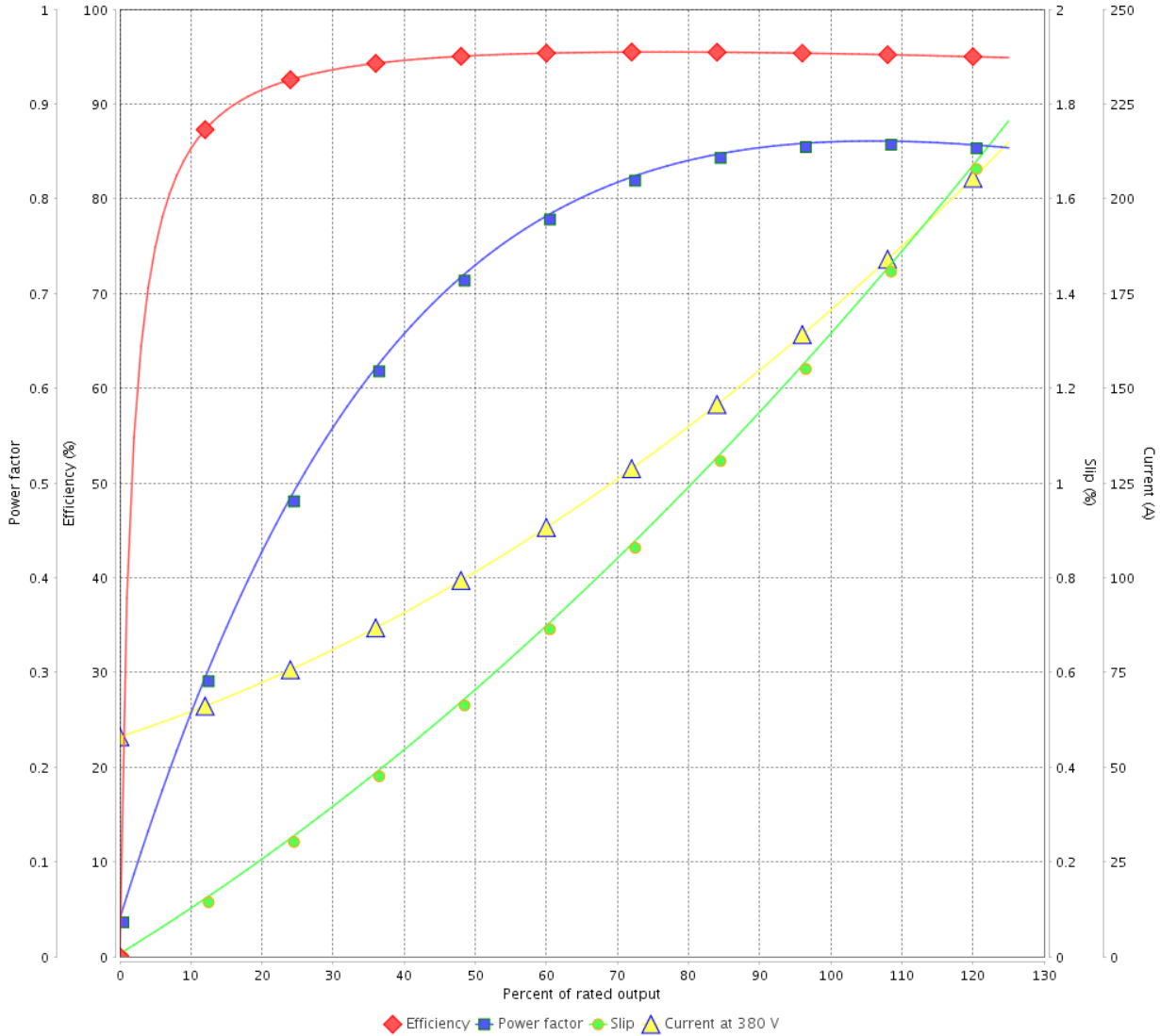

Performance : 380 V 50 Hz 4P IE3

Rated current : 170 A
 LRC : 7.0
 Rated torque : 444 ft.lb
 Locked rotor torque : 190 %
 Breakdown torque : 240 %
 Rated speed : 1480 rpm

Moment of inertia (J) : 66.7 sq.ft.lb
 Duty cycle : Cont.(S1)
 Insulation class : F
 Service factor : 1.00
 Temperature rise : 80 K
 Design : B

Rev.	Changes Summary	Performed	Checked	Date
Performed by		Page		Revision
Checked by		10 / 36		
Date		13/04/2022		

LOAD PERFORMANCE CURVE

Three Phase Induction Motor - Squirrel Cage



Customer : _____

Product line : NEMA Premium Efficiency Three-Phase Product code : 13693143
 Catalog # : 15018ET3E445TC-W22G

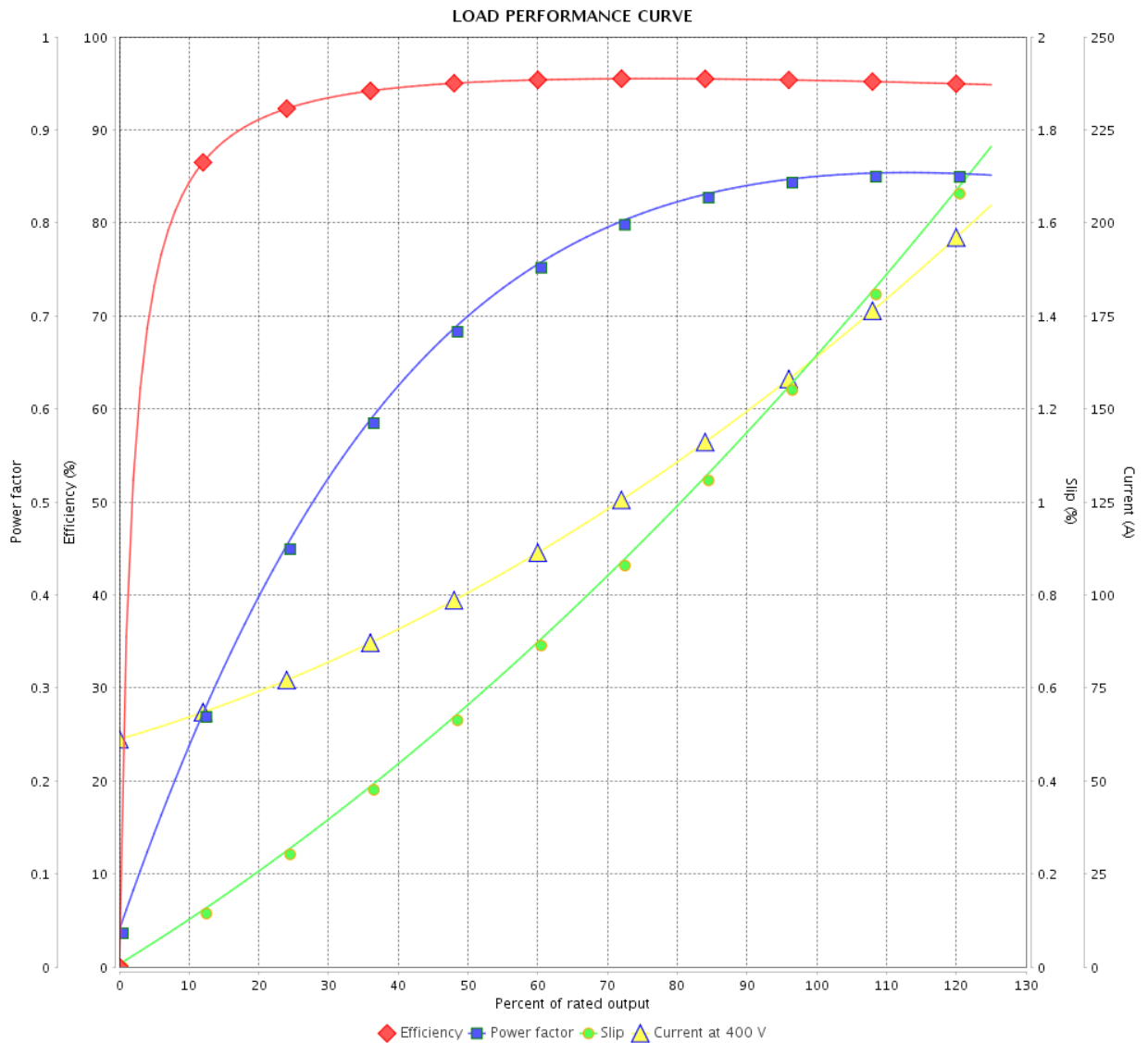

Performance : 400 V 50 Hz 4P IE3

Rated current : 163 A	Moment of inertia (J) : 66.7 sq.ft.lb
LRC : 6.9	Duty cycle : Cont.(S1)
Rated torque : 444 ft.lb	Insulation class : F
Locked rotor torque : 220 %	Service factor : 1.00
Breakdown torque : 260 %	Temperature rise : 80 K
Rated speed : 1480 rpm	Design : B

Rev.	Changes Summary	Performed	Checked	Date
Performed by			Page	Revision
Checked by				
Date				

LOAD PERFORMANCE CURVE

Three Phase Induction Motor - Squirrel Cage



Customer :

Product line : NEMA Premium Efficiency Three-Phase

Product code : 13693143

Catalog # : 15018ET3E445TC-W22G

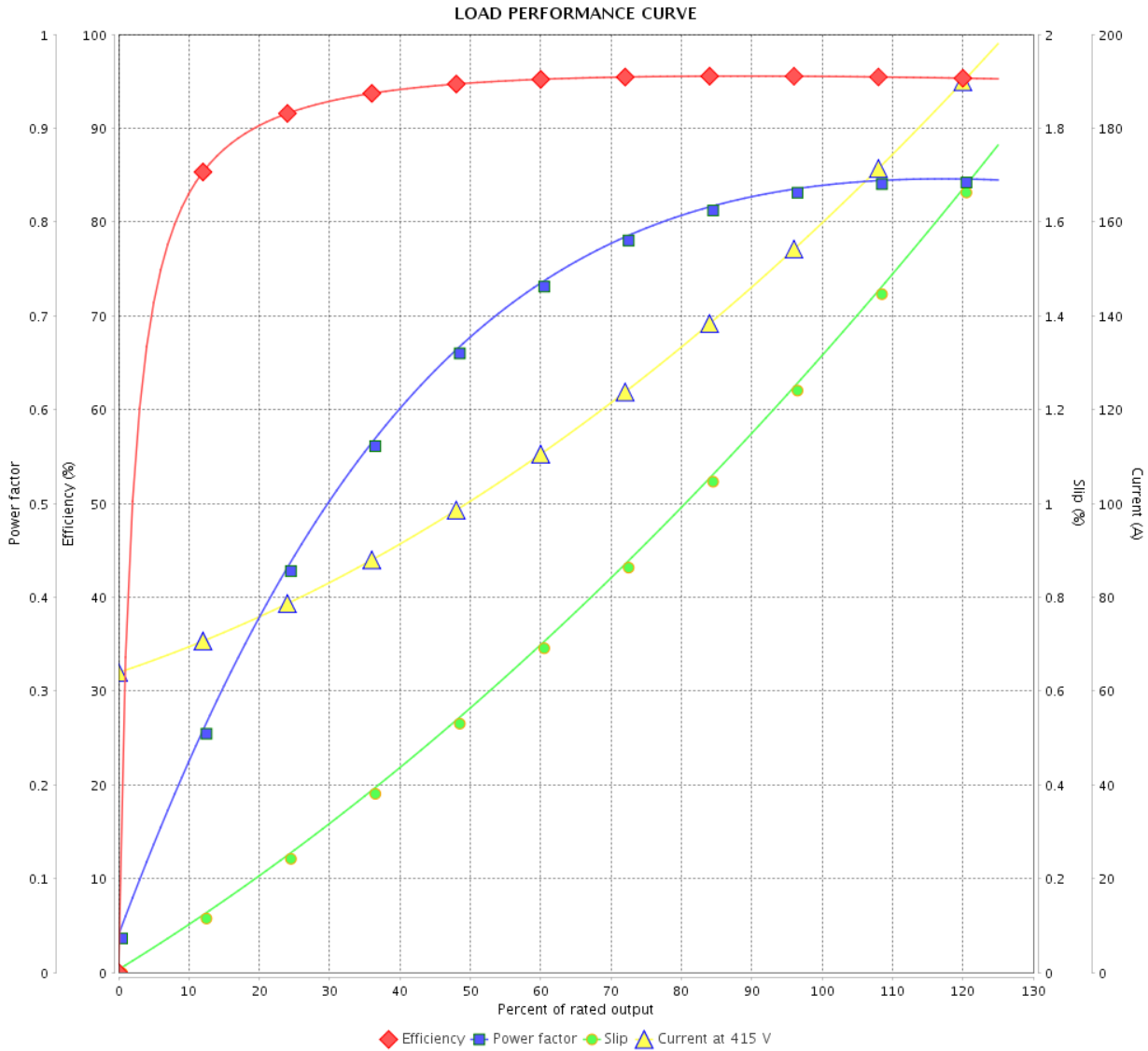

Performance : 415 V 50 Hz 4P IE3

Rated current : 159 A
 LRC : 7.5
 Rated torque : 444 ft.lb
 Locked rotor torque : 229 %
 Breakdown torque : 290 %
 Rated speed : 1480 rpm

Moment of inertia (J) : 66.7 sq.ft.lb
 Duty cycle : Cont.(S1)
 Insulation class : F
 Service factor : 1.00
 Temperature rise : 80 K
 Design : B

Rev.	Changes Summary	Performed	Checked	Date
Performed by		Page		Revision
Checked by		12 / 36		
Date	13/04/2022			

LOAD PERFORMANCE CURVE

Three Phase Induction Motor - Squirrel Cage



Customer :

Product line : NEMA Premium Efficiency Three-Phase

Product code : 13693143

Catalog # : 15018ET3E445TC-W22G

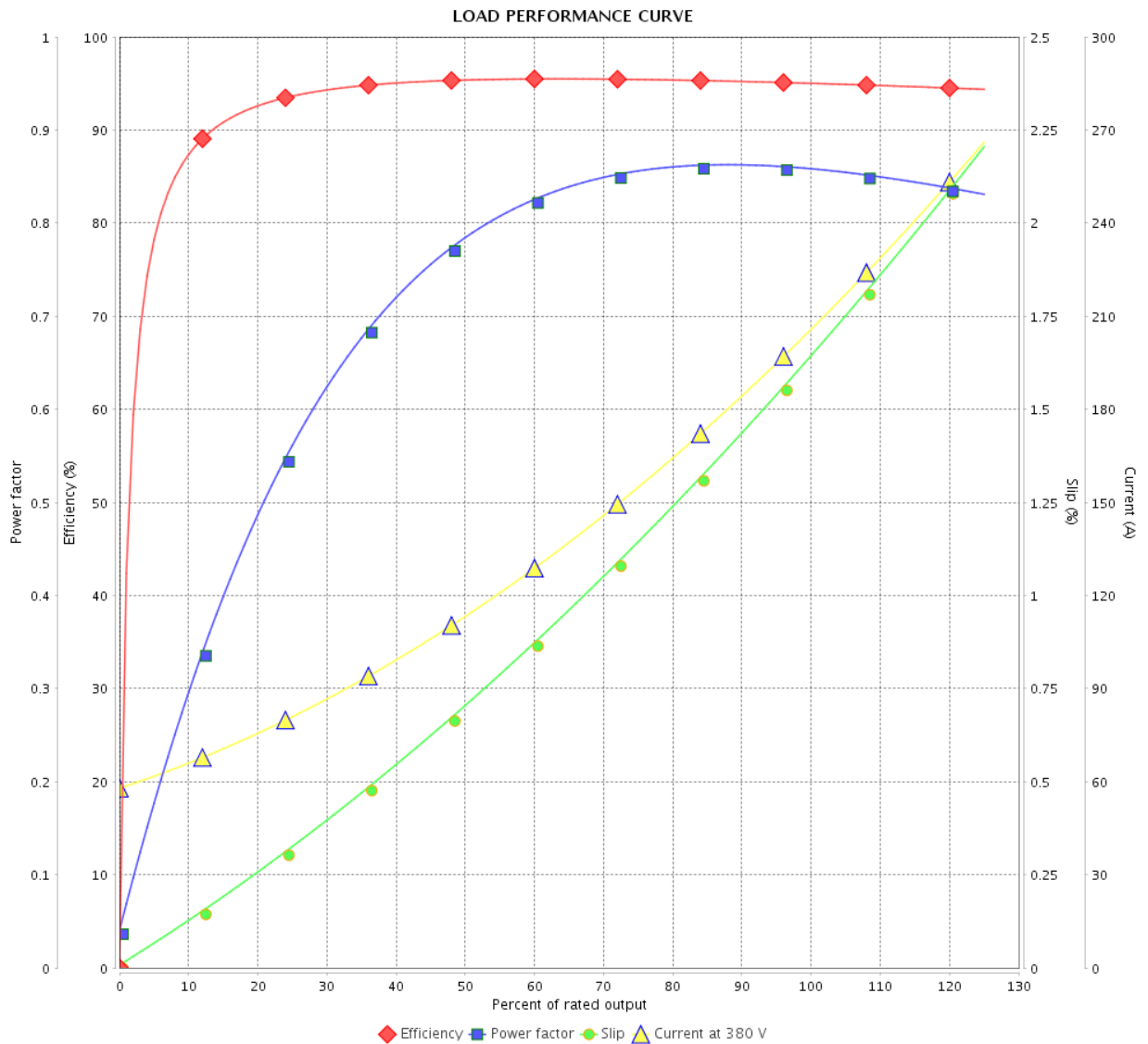

Performance : 380 V 50 Hz 4P IE2

Rated current : 205 A
 LRC : 5.8
 Rated torque : 534 ft.lb
 Locked rotor torque : 160 %
 Breakdown torque : 200 %
 Rated speed : 1475 rpm

Moment of inertia (J) : 66.7 sq.ft.lb
 Duty cycle : Cont.(S1)
 Insulation class : F
 Service factor : 1.00
 Temperature rise : 105 K
 Design : B

Rev.	Changes Summary	Performed	Checked	Date
Performed by			Page	Revision
Checked by				
Date				

LOAD PERFORMANCE CURVE

Three Phase Induction Motor - Squirrel Cage



Customer :

Product line : NEMA Premium Efficiency Three-Phase

Product code : 13693143

Catalog # : 15018ET3E445TC-W22G

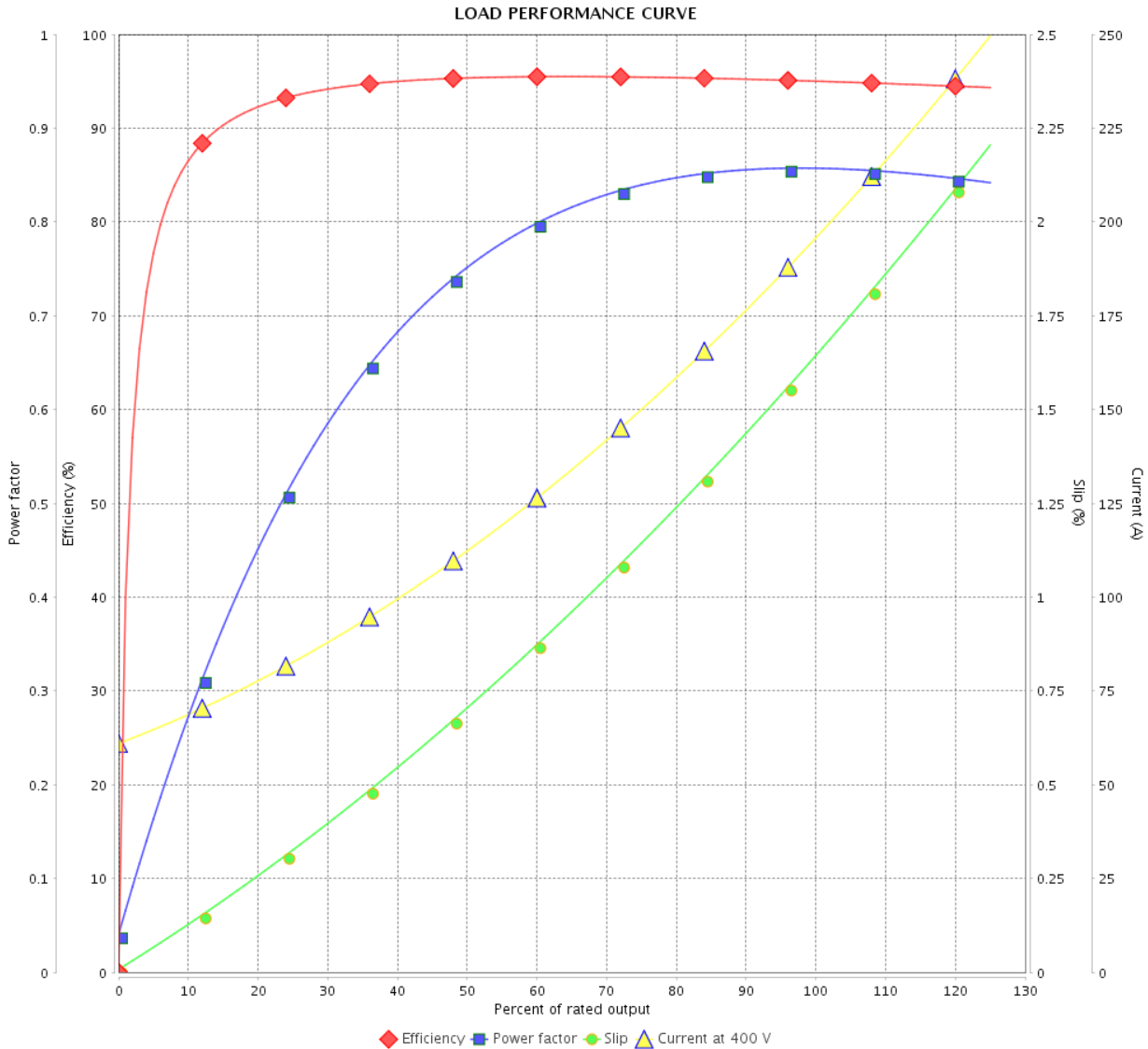

Performance : 400 V 50 Hz 4P IE2

Rated current	: 194 A	Moment of inertia (J)	: 66.7 sq.ft.lb
LRC	: 5.8	Duty cycle	: Cont.(S1)
Rated torque	: 534 ft.lb	Insulation class	: F
Locked rotor torque	: 180 %	Service factor	: 1.00
Breakdown torque	: 220 %	Temperature rise	: 105 K
Rated speed	: 1475 rpm	Design	: B

Rev.	Changes Summary	Performed	Checked	Date
Performed by			Page	Revision
Checked by			14 / 36	
Date	13/04/2022			

LOAD PERFORMANCE CURVE

Three Phase Induction Motor - Squirrel Cage



Customer :

Product line : NEMA Premium Efficiency Three-Phase

Product code : 13693143

Catalog # : 15018ET3E445TC-W22G

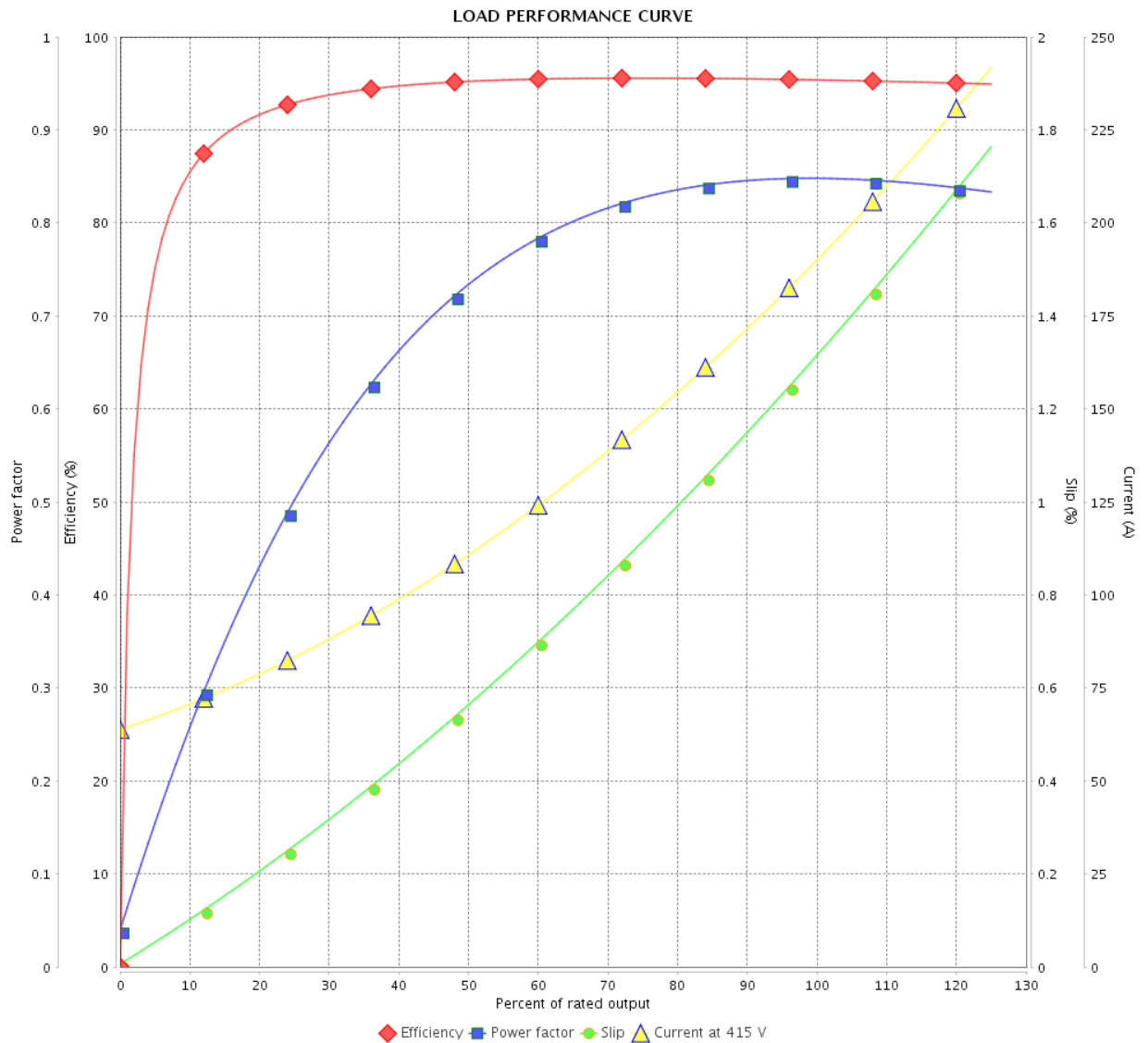

Performance : 415 V 50 Hz 4P IE3

Rated current : 189 A
 LRC : 6.3
 Rated torque : 532 ft.lb
 Locked rotor torque : 190 %
 Breakdown torque : 240 %
 Rated speed : 1480 rpm

Moment of inertia (J) : 66.7 sq.ft.lb
 Duty cycle : Cont.(S1)
 Insulation class : F
 Service factor : 1.00
 Temperature rise : 105 K
 Design : B

Rev.	Changes Summary	Performed	Checked	Date
Performed by			Page	Revision
Checked by				
Date				
			15 / 36	

THERMAL LIMIT CURVE



Three Phase Induction Motor - Squirrel Cage

Customer :

Product line : NEMA Premium Efficiency Three-Phase
 Product code : 13693143
 Catalog # : 15018ET3E445TC-W22G

Performance : 230/460 V 60 Hz 4P

Rated current : 340/170 A	Moment of inertia (J) : 66.7 sq.ft.lb
LRC : 6.6	Duty cycle : Cont.(S1)
Rated torque : 443 ft.lb	Insulation class : F
Locked rotor torque : 200 %	Service factor : 1.15
Breakdown torque : 250 %	Temperature rise : 80 K
Rated speed : 1780 rpm	Design : B

Heating constant

Cooling constant

Rev.	Changes Summary	Performed	Checked	Date
Performed by			Page 16 / 36	Revision
Checked by				
Date	13/04/2022			

THERMAL LIMIT CURVE

Three Phase Induction Motor - Squirrel Cage



Customer : _____

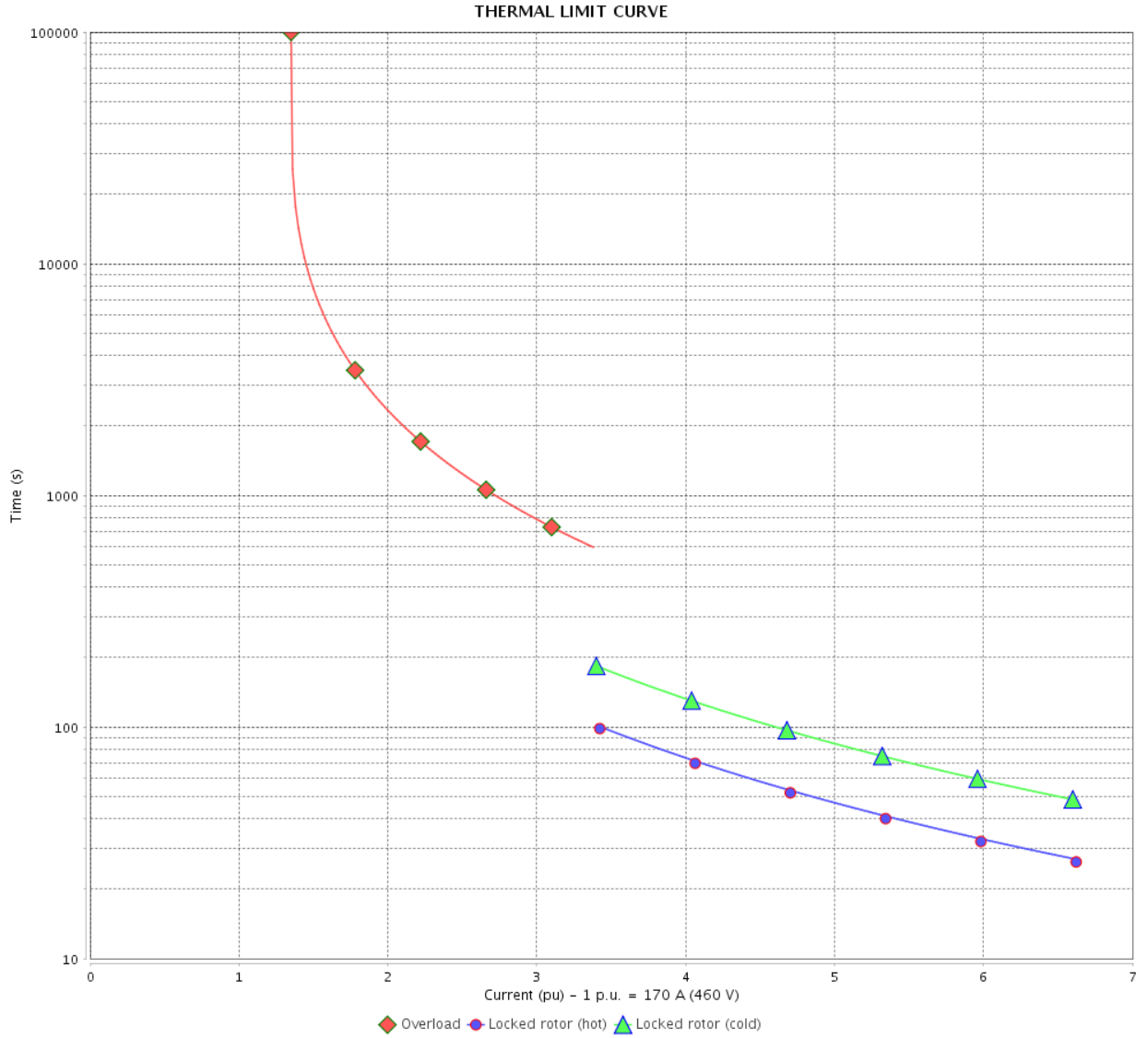

Rev.	Changes Summary	Performed	Checked	Date
Performed by		Page 17 / 36		Revision
Checked by				
Date				

THERMAL LIMIT CURVE



Three Phase Induction Motor - Squirrel Cage

Customer :

Product line : NEMA Premium Efficiency Three-Phase
Product code : 13693143
Catalog # : 15018ET3E445TC-W22G

Performance : 380 V 50 Hz 4P IE3

Rated current	: 170 A	Moment of inertia (J)	: 66.7 sq.ft.lb
LRC	: 7.0	Duty cycle	: Cont.(S1)
Rated torque	: 444 ft.lb	Insulation class	: F
Locked rotor torque	: 190 %	Service factor	: 1.00
Breakdown torque	: 240 %	Temperature rise	: 80 K
Rated speed	: 1480 rpm	Design	: B

Heating constant

Cooling constant

Rev.	Changes Summary	Performed	Checked	Date
Performed by				
Checked by			Page	Revision
Date	13/04/2022		18 / 36	

THERMAL LIMIT CURVE

Three Phase Induction Motor - Squirrel Cage



Customer : _____

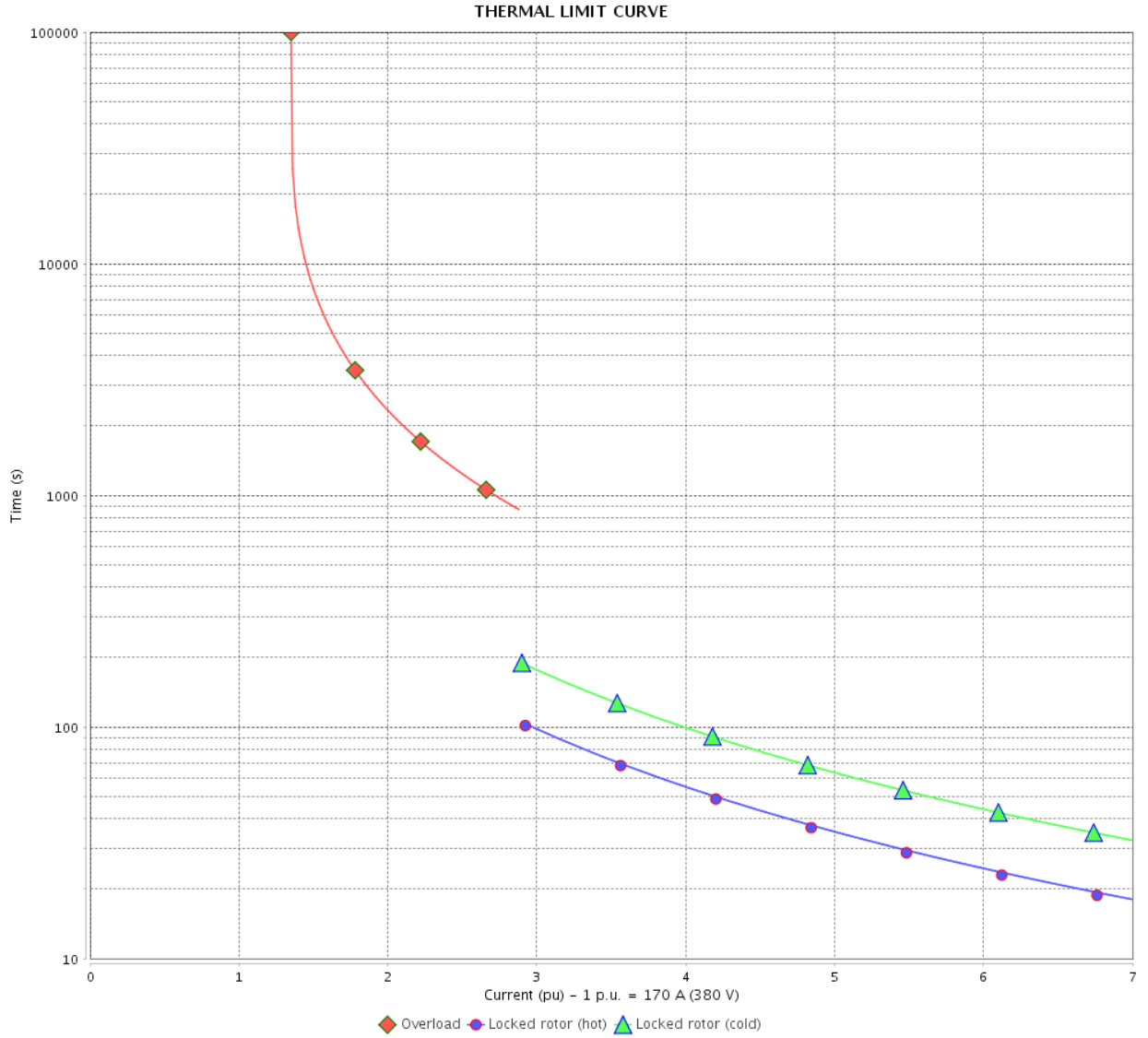

Rev.	Changes Summary	Performed	Checked	Date
Performed by		Page 19 / 36		Revision
Checked by				
Date				

THERMAL LIMIT CURVE

Three Phase Induction Motor - Squirrel Cage



Customer :

Product line : NEMA Premium Efficiency Three-Phase
Product code : 13693143
Catalog # : 15018ET3E445TC-W22G

Performance : 400 V 50 Hz 4P IE3

Rated current	: 163 A	Moment of inertia (J)	: 66.7 sq.ft.lb
LRC	: 6.9	Duty cycle	: Cont.(S1)
Rated torque	: 444 ft.lb	Insulation class	: F
Locked rotor torque	: 220 %	Service factor	: 1.00
Breakdown torque	: 260 %	Temperature rise	: 80 K
Rated speed	: 1480 rpm	Design	: B

Heating constant

Cooling constant

Rev.	Changes Summary	Performed	Checked	Date
Performed by				
Checked by			Page	Revision
Date	13/04/2022		20 / 36	

THERMAL LIMIT CURVE

Three Phase Induction Motor - Squirrel Cage



Customer : _____

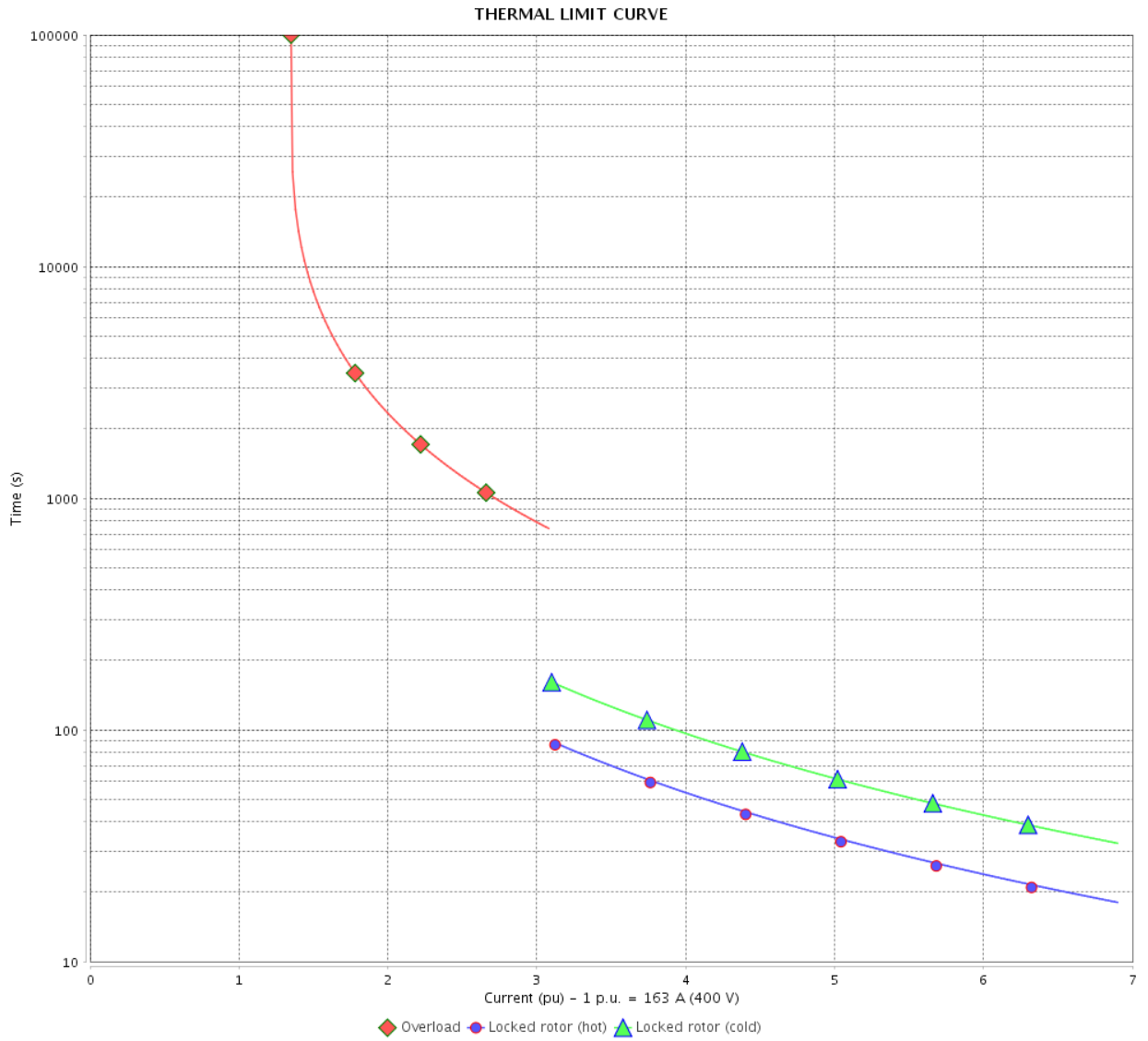

Rev.	Changes Summary	Performed	Checked	Date
Performed by		Page		Revision
Checked by		21 / 36		
Date		13/04/2022		

THERMAL LIMIT CURVE



Three Phase Induction Motor - Squirrel Cage

Customer :

Product line : NEMA Premium Efficiency Three-Phase
Product code : 13693143
Catalog # : 15018ET3E445TC-W22G

Performance : 415 V 50 Hz 4P IE3

Rated current	: 159 A	Moment of inertia (J)	: 66.7 sq.ft.lb
LRC	: 7.5	Duty cycle	: Cont.(S1)
Rated torque	: 444 ft.lb	Insulation class	: F
Locked rotor torque	: 229 %	Service factor	: 1.00
Breakdown torque	: 290 %	Temperature rise	: 80 K
Rated speed	: 1480 rpm	Design	: B

Heating constant

Cooling constant

Rev.	Changes Summary	Performed	Checked	Date
Performed by				
Checked by			Page	Revision
Date	13/04/2022		22 / 36	

THERMAL LIMIT CURVE

Three Phase Induction Motor - Squirrel Cage



Customer : _____

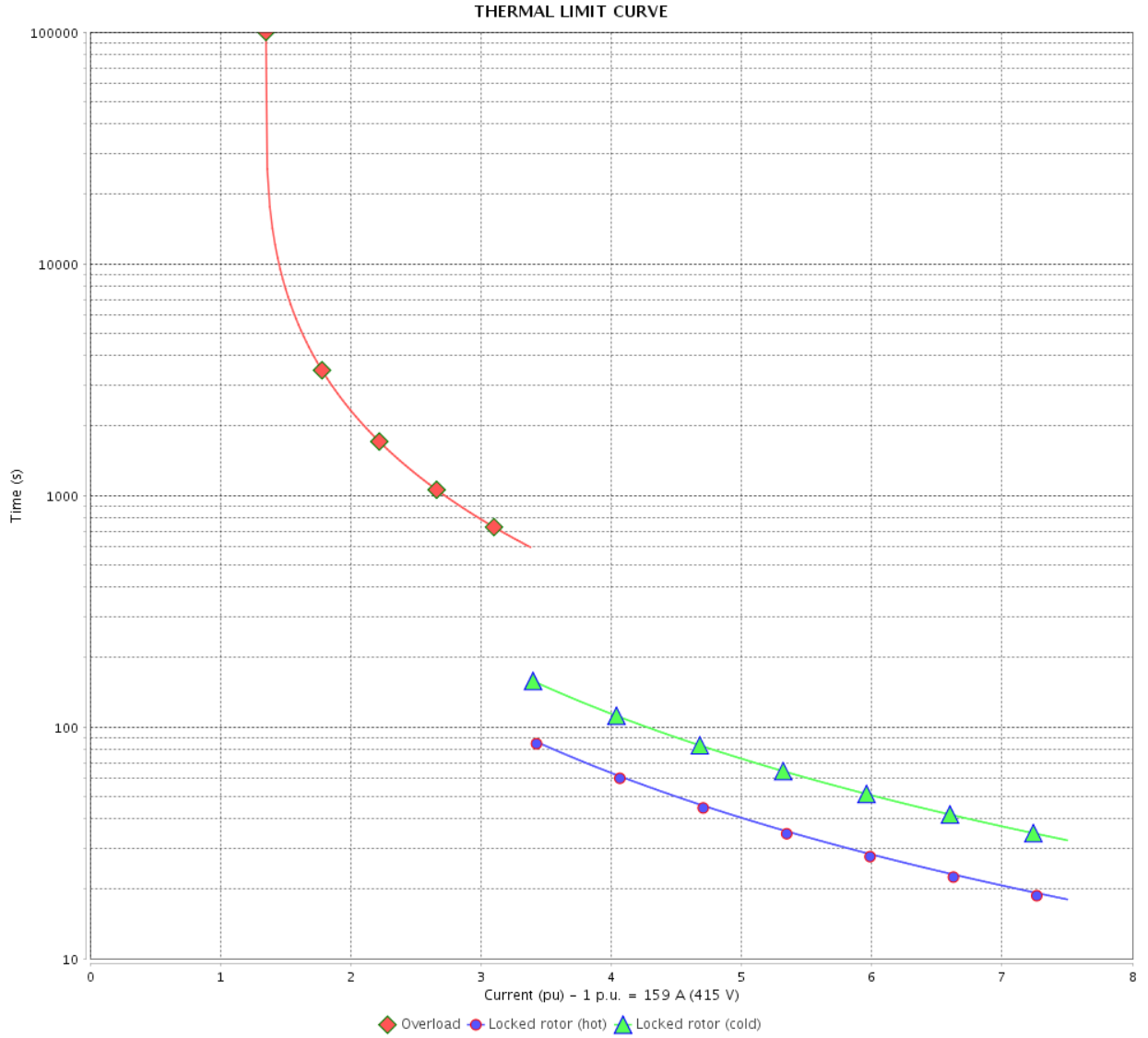

Rev.	Changes Summary	Performed	Checked	Date
Performed by		Page 23 / 36		Revision
Checked by				
Date				

THERMAL LIMIT CURVE



Three Phase Induction Motor - Squirrel Cage

Customer :

Product line : NEMA Premium Efficiency Three-Phase
Product code : 13693143
Catalog # : 15018ET3E445TC-W22G

Performance : 380 V 50 Hz 4P IE2

Rated current	: 205 A	Moment of inertia (J)	: 66.7 sq.ft.lb
LRC	: 5.8	Duty cycle	: Cont.(S1)
Rated torque	: 534 ft.lb	Insulation class	: F
Locked rotor torque	: 160 %	Service factor	: 1.00
Breakdown torque	: 200 %	Temperature rise	: 105 K
Rated speed	: 1475 rpm	Design	: B

Heating constant

Cooling constant

Rev.	Changes Summary	Performed	Checked	Date
Performed by				
Checked by			Page	Revision
Date	13/04/2022		24 / 36	

THERMAL LIMIT CURVE

Three Phase Induction Motor - Squirrel Cage



Customer : _____

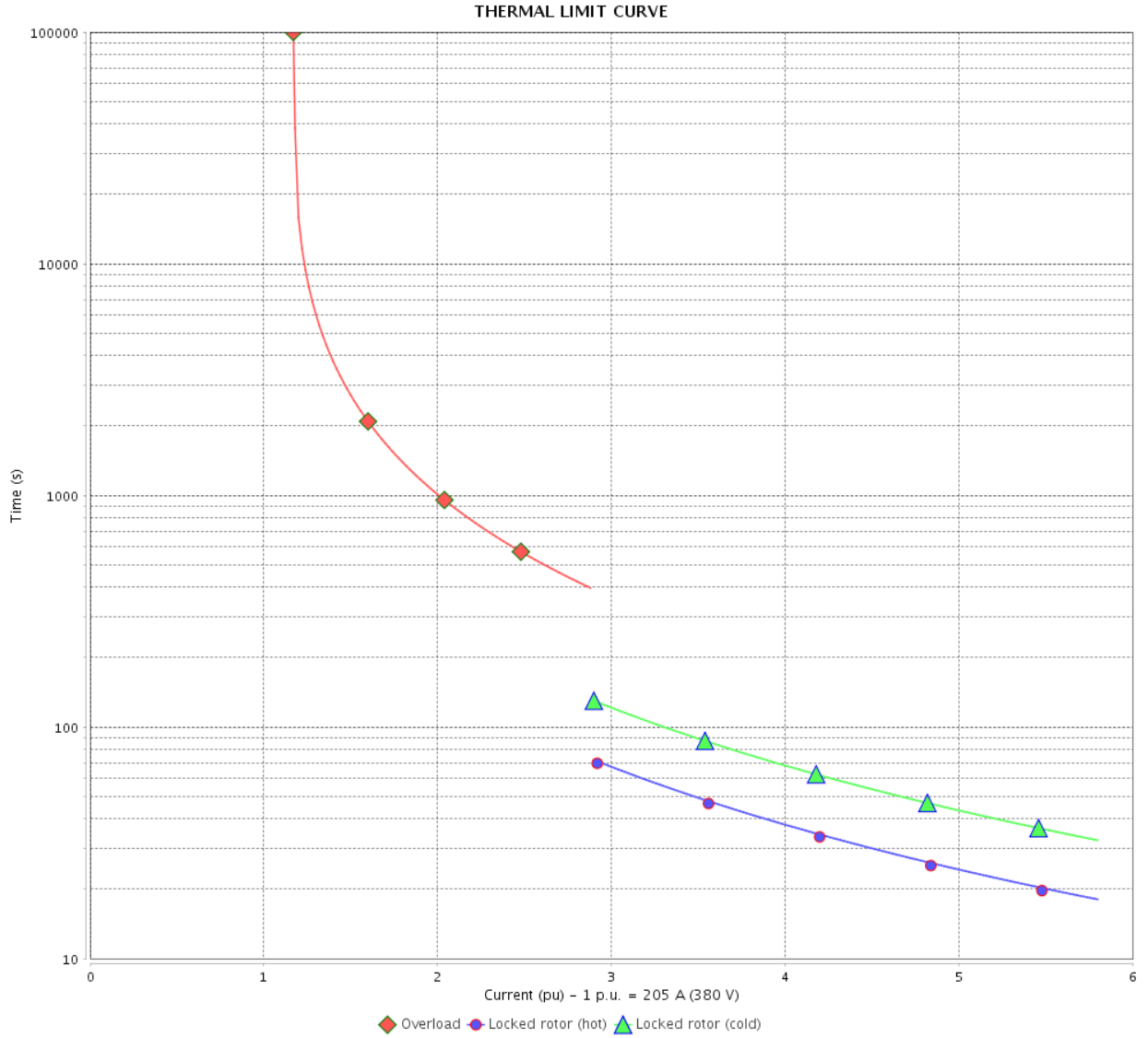

Rev.	Changes Summary	Performed	Checked	Date	
Performed by					
Checked by					
Date					13/04/2022
		Page	Revision		
		25 / 36			

THERMAL LIMIT CURVE



Three Phase Induction Motor - Squirrel Cage

Customer :

Product line : NEMA Premium Efficiency Three-Phase
Product code : 13693143
Catalog # : 15018ET3E445TC-W22G

Performance : 400 V 50 Hz 4P IE2

Rated current	: 194 A	Moment of inertia (J)	: 66.7 sq.ft.lb
LRC	: 5.8	Duty cycle	: Cont.(S1)
Rated torque	: 534 ft.lb	Insulation class	: F
Locked rotor torque	: 180 %	Service factor	: 1.00
Breakdown torque	: 220 %	Temperature rise	: 105 K
Rated speed	: 1475 rpm	Design	: B

Heating constant

Cooling constant

Rev.	Changes Summary	Performed	Checked	Date
Performed by				
Checked by			Page	Revision
Date	13/04/2022		26 / 36	

THERMAL LIMIT CURVE

Three Phase Induction Motor - Squirrel Cage



Customer : _____

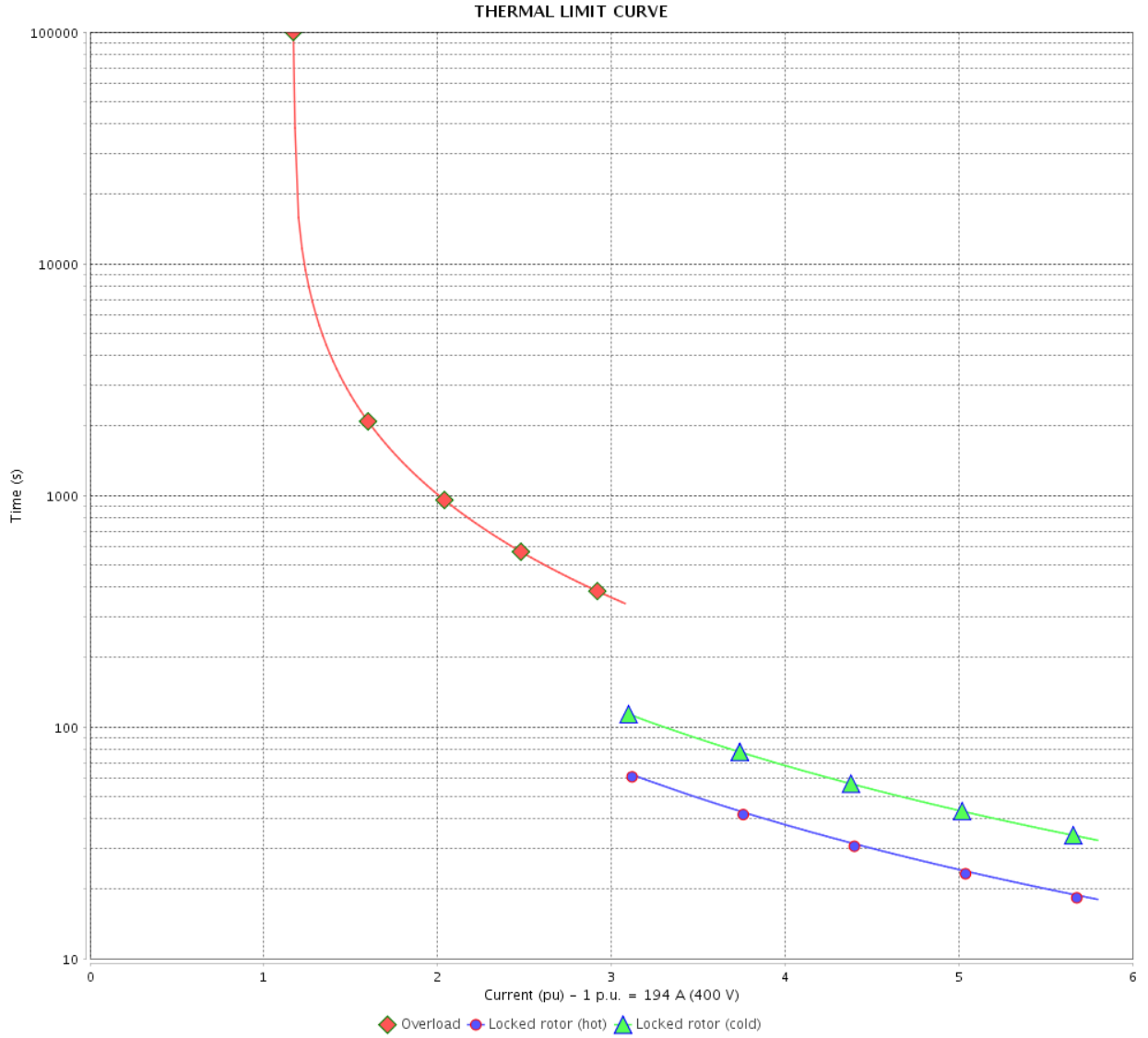

Rev.	Changes Summary	Performed	Checked	Date
Performed by				
Checked by				
Date				
			Page	Revision
			27 / 36	

THERMAL LIMIT CURVE



Three Phase Induction Motor - Squirrel Cage

Customer :

Product line : NEMA Premium Efficiency Three-Phase
 Product code : 13693143
 Catalog # : 15018ET3E445TC-W22G

Performance : 415 V 50 Hz 4P IE3

Rated current : 189 A	Moment of inertia (J) : 66.7 sq.ft.lb
LRC : 6.3	Duty cycle : Cont.(S1)
Rated torque : 532 ft.lb	Insulation class : F
Locked rotor torque : 190 %	Service factor : 1.00
Breakdown torque : 240 %	Temperature rise : 105 K
Rated speed : 1480 rpm	Design : B

Heating constant

Cooling constant

Rev.	Changes Summary	Performed	Checked	Date
Performed by			Page 28 / 36	Revision
Checked by				
Date	13/04/2022			

THERMAL LIMIT CURVE

Three Phase Induction Motor - Squirrel Cage



Customer : _____

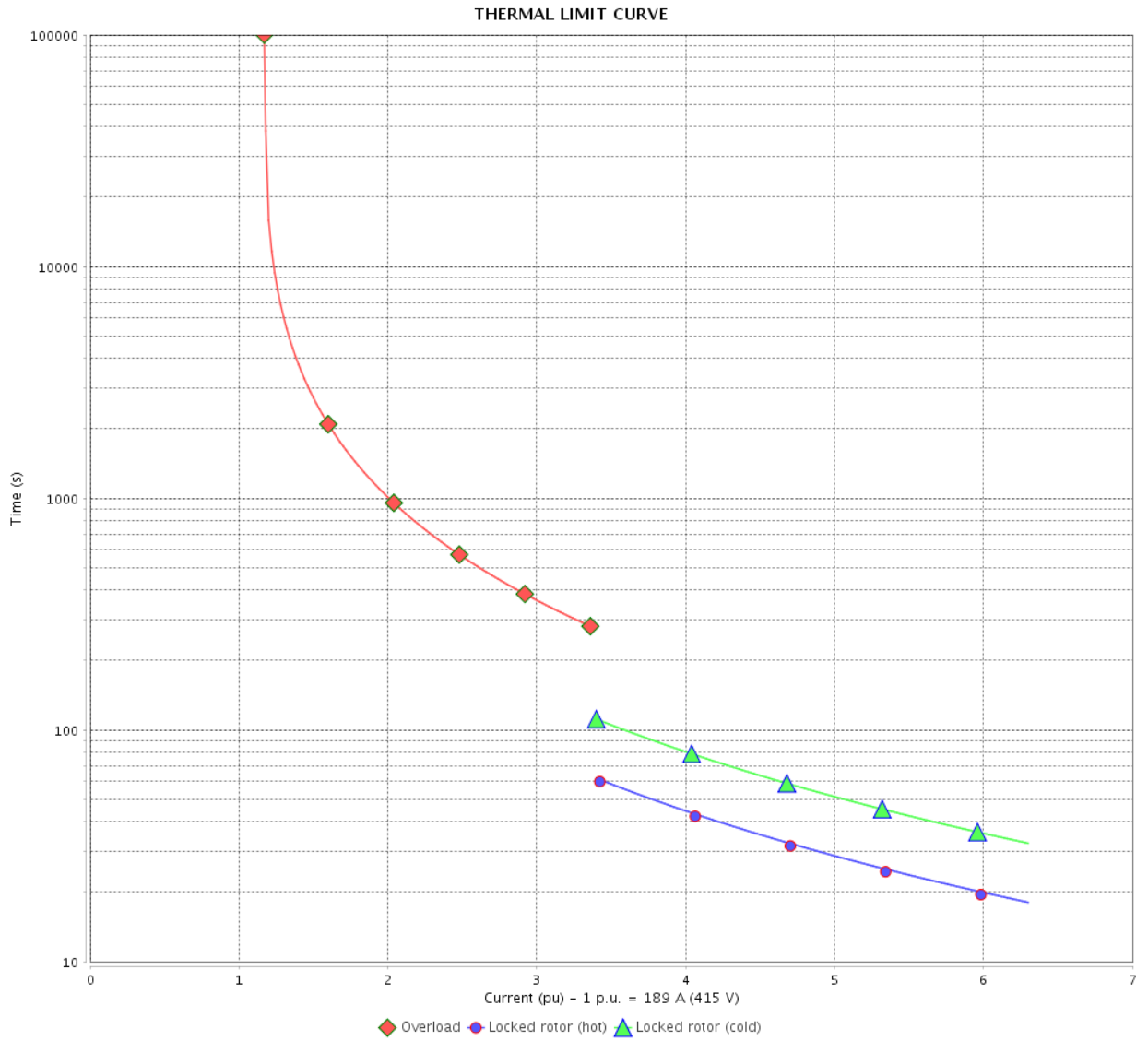

Rev.	Changes Summary	Performed	Checked	Date
Performed by		Page 29 / 36		Revision
Checked by				
Date				

VFD OPERATION CURVE

Three Phase Induction Motor - Squirrel Cage



Customer :

Product line : NEMA Premium Efficiency Three-Phase

Product code : 13693143

Catalog # : 15018ET3E445TC-W22G

VFD OPERATION CURVE

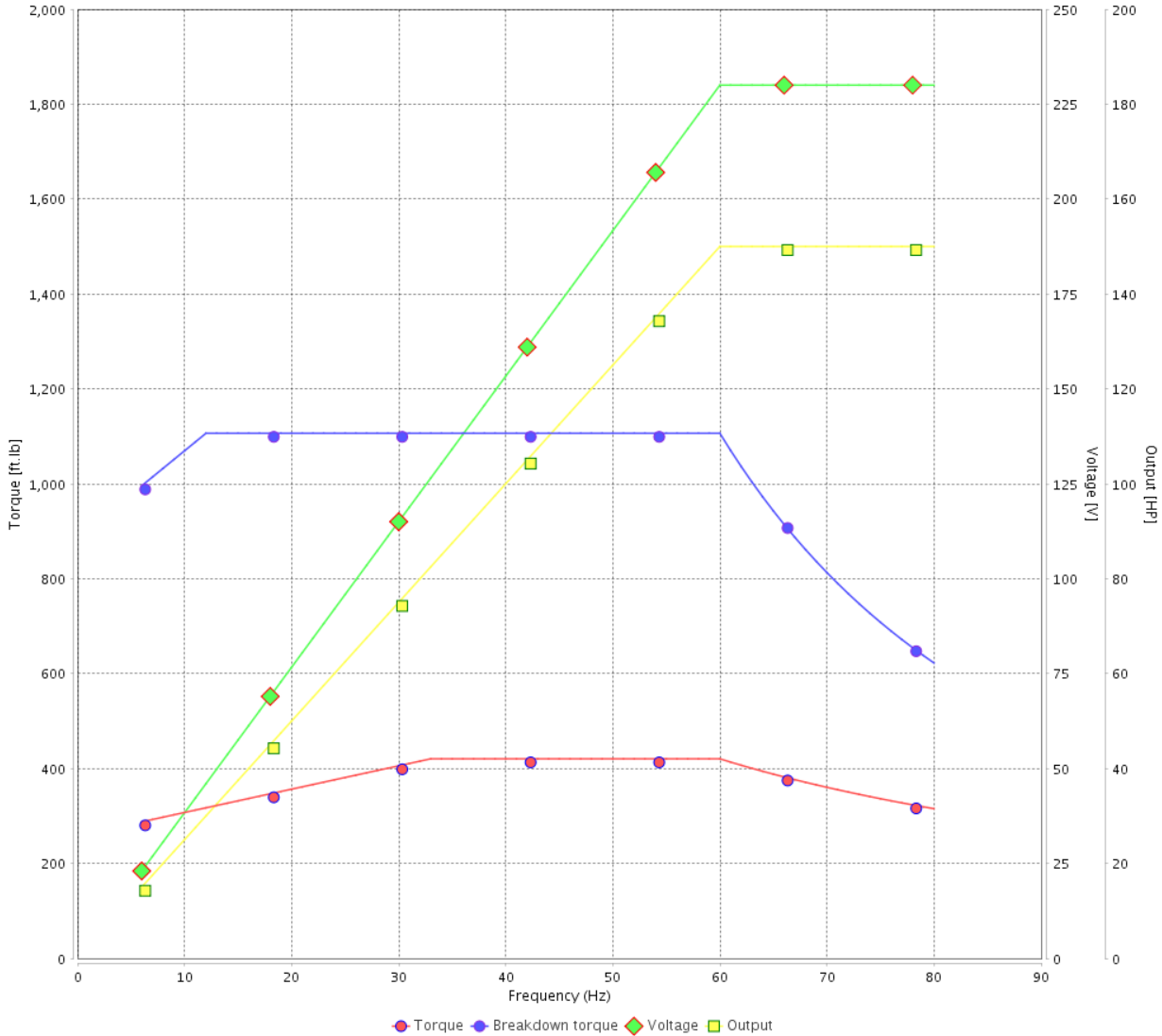

Performance : 230/460 V 60 Hz 4P

Rated current : 340/170 A
 LRC : 6.6
 Rated torque : 443 ft.lb
 Locked rotor torque : 200 %
 Breakdown torque : 250 %
 Rated speed : 1780 rpm

Moment of inertia (J) : 66.7 sq.ft.lb
 Duty cycle : Cont.(S1)
 Insulation class : F
 Service factor : 1.15
 Temperature rise : 80 K
 Design : B

Rev.	Changes Summary	Performed	Checked	Date
Performed by			Page 30 / 36	Revision
Checked by				
Date	13/04/2022			

VFD OPERATION CURVE

Three Phase Induction Motor - Squirrel Cage



Customer :

Product line : NEMA Premium Efficiency Three-Phase
 Product code : 13693143
 Catalog # : 15018ET3E445TC-W22G

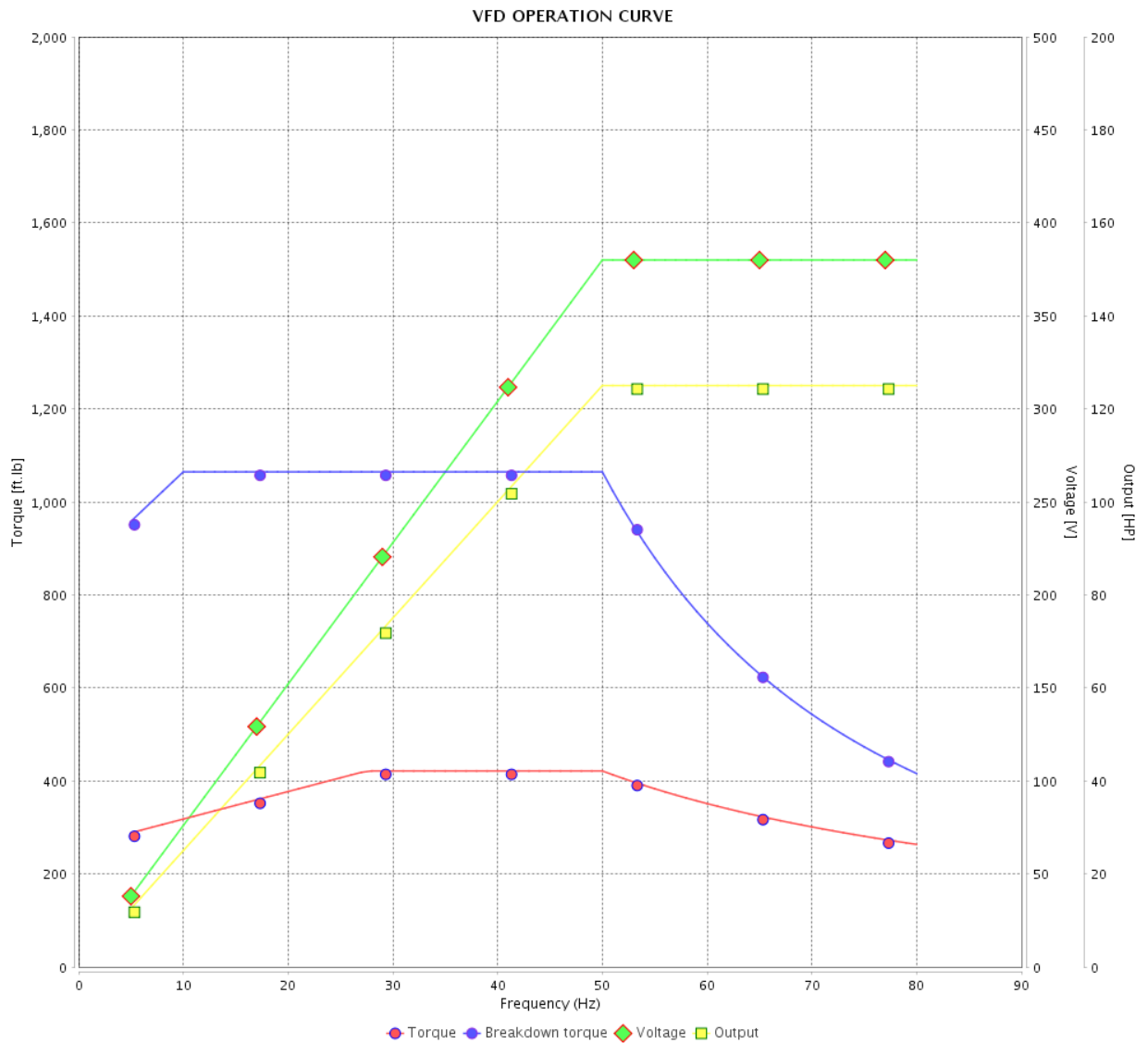

Performance : 380 V 50 Hz 4P IE3

Rated current	: 170 A	Moment of inertia (J)	: 66.7 sq.ft.lb
LRC	: 7.0	Duty cycle	: Cont.(S1)
Rated torque	: 444 ft.lb	Insulation class	: F
Locked rotor torque	: 190 %	Service factor	: 1.00
Breakdown torque	: 240 %	Temperature rise	: 80 K
Rated speed	: 1480 rpm	Design	: B

Rev.	Changes Summary	Performed	Checked	Date
Performed by			Page 31 / 36	Revision
Checked by				
Date	13/04/2022			

VFD OPERATION CURVE

Three Phase Induction Motor - Squirrel Cage



Customer :

Product line : NEMA Premium Efficiency Three-Phase

Product code : 13693143

Catalog # : 15018ET3E445TC-W22G

VFD OPERATION CURVE

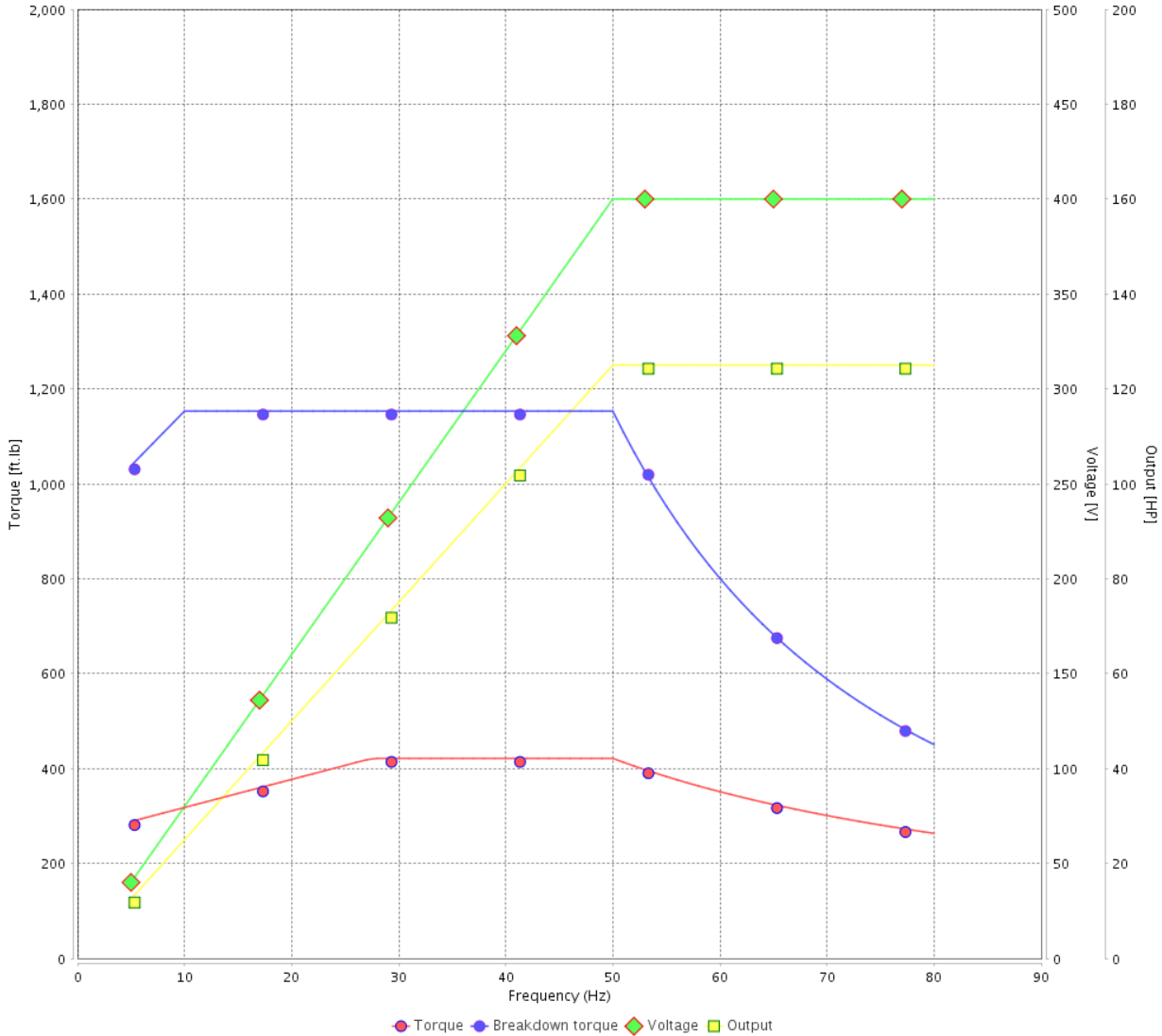

Performance : 400 V 50 Hz 4P IE3

Rated current : 163 A
 LRC : 6.9
 Rated torque : 444 ft.lb
 Locked rotor torque : 220 %
 Breakdown torque : 260 %
 Rated speed : 1480 rpm

Moment of inertia (J) : 66.7 sq.ft.lb
 Duty cycle : Cont.(S1)
 Insulation class : F
 Service factor : 1.00
 Temperature rise : 80 K
 Design : B

Rev.	Changes Summary	Performed	Checked	Date
Performed by			Page 32 / 36	Revision
Checked by				
Date	13/04/2022			

VFD OPERATION CURVE

Three Phase Induction Motor - Squirrel Cage



Customer : _____

Product line : NEMA Premium Efficiency Three-Phase
 Product code : 13693143
 Catalog # : 15018ET3E445TC-W22G

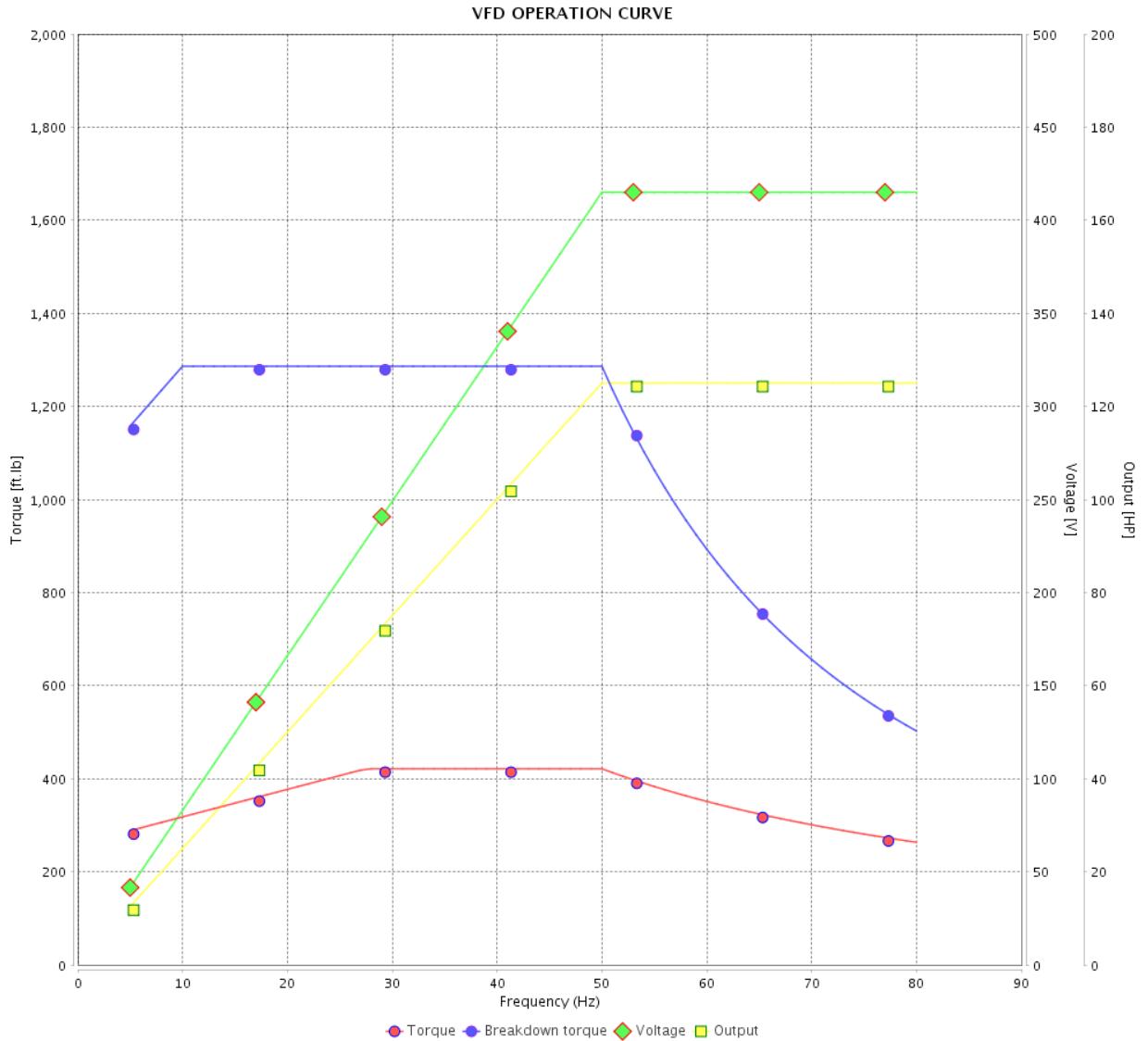

Performance : 415 V 50 Hz 4P IE3

Rated current : 159 A	Moment of inertia (J) : 66.7 sq.ft.lb
LRC : 7.5	Duty cycle : Cont.(S1)
Rated torque : 444 ft.lb	Insulation class : F
Locked rotor torque : 229 %	Service factor : 1.00
Breakdown torque : 290 %	Temperature rise : 80 K
Rated speed : 1480 rpm	Design : B

Rev.	Changes Summary	Performed	Checked	Date
Performed by			Page 33 / 36	Revision
Checked by				
Date	13/04/2022			

VFD OPERATION CURVE

Three Phase Induction Motor - Squirrel Cage



Customer :

Product line : NEMA Premium Efficiency Three-Phase

Product code : 13693143

Catalog # : 15018ET3E445TC-W22G

VFD OPERATION CURVE

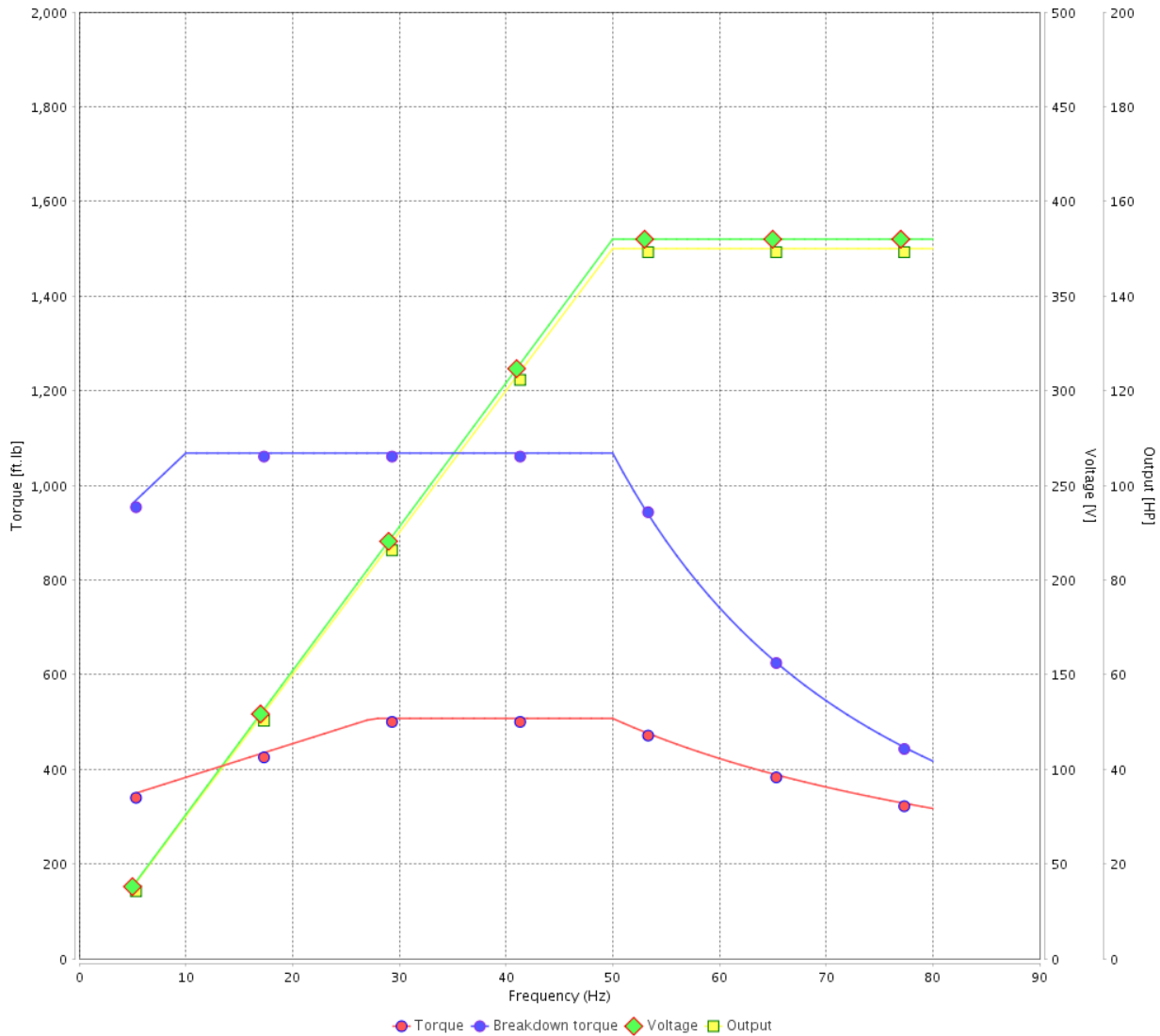

Performance : 380 V 50 Hz 4P IE2

Rated current	: 205 A	Moment of inertia (J)	: 66.7 sq.ft.lb
LRC	: 5.8	Duty cycle	: Cont.(S1)
Rated torque	: 534 ft.lb	Insulation class	: F
Locked rotor torque	: 160 %	Service factor	: 1.00
Breakdown torque	: 200 %	Temperature rise	: 105 K
Rated speed	: 1475 rpm	Design	: B

Rev.	Changes Summary	Performed	Checked	Date
Performed by		Page		Revision
Checked by		34 / 36		
Date	13/04/2022			

VFD OPERATION CURVE

Three Phase Induction Motor - Squirrel Cage



Customer : _____

Product line : NEMA Premium Efficiency Three-Phase Product code : 13693143
 Catalog # : 15018ET3E445TC-W22G

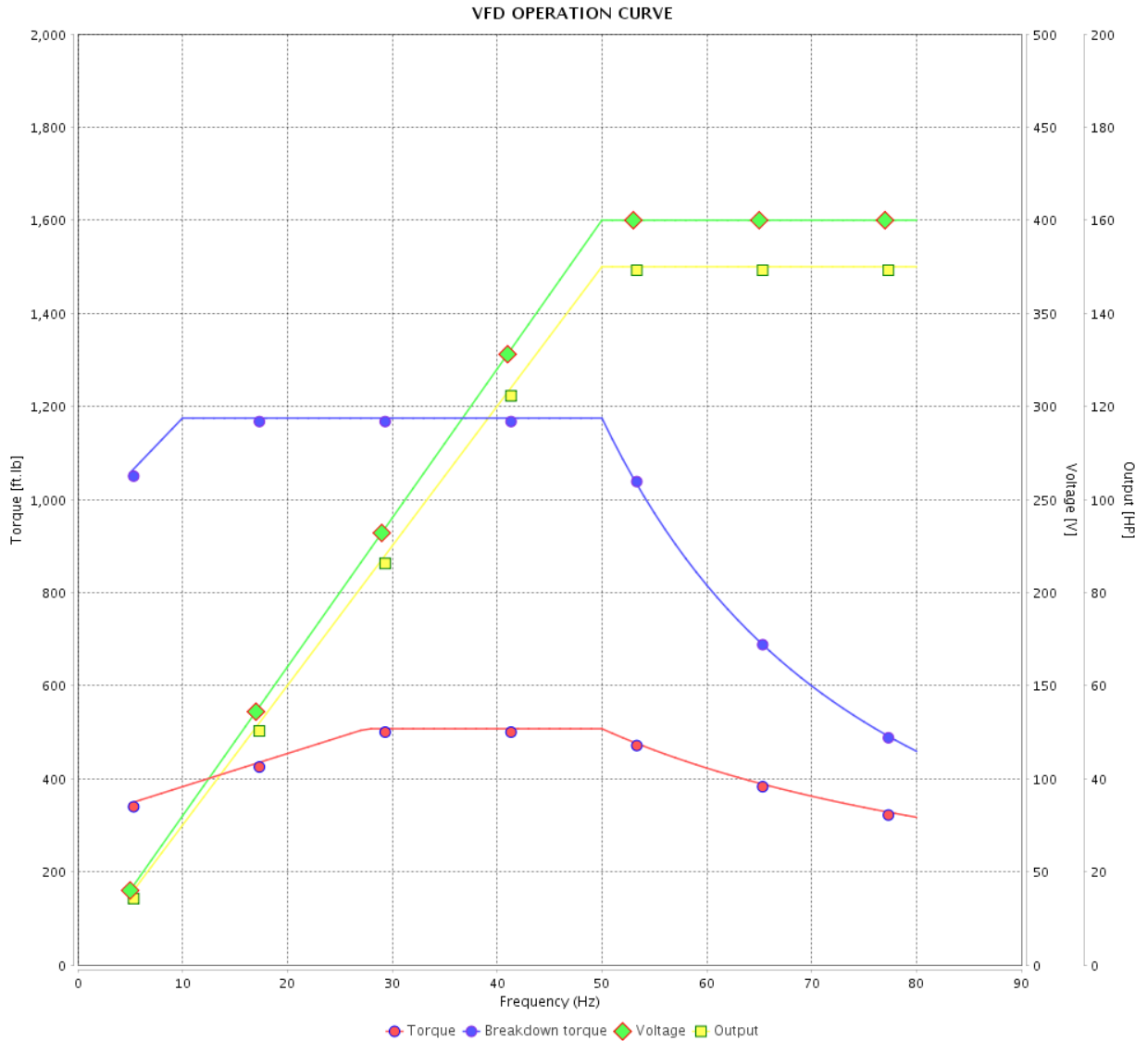

Performance : 400 V 50 Hz 4P IE2

Rated current	: 194 A	Moment of inertia (J)	: 66.7 sq.ft.lb
LRC	: 5.8	Duty cycle	: Cont.(S1)
Rated torque	: 534 ft.lb	Insulation class	: F
Locked rotor torque	: 180 %	Service factor	: 1.00
Breakdown torque	: 220 %	Temperature rise	: 105 K
Rated speed	: 1475 rpm	Design	: B

Rev.	Changes Summary	Performed	Checked	Date
Performed by			Page 35 / 36	Revision
Checked by				
Date	13/04/2022			

VFD OPERATION CURVE

Three Phase Induction Motor - Squirrel Cage



Customer :

Product line : NEMA Premium Efficiency Three-Phase

Product code : 13693143

Catalog # : 15018ET3E445TC-W22G

VFD OPERATION CURVE

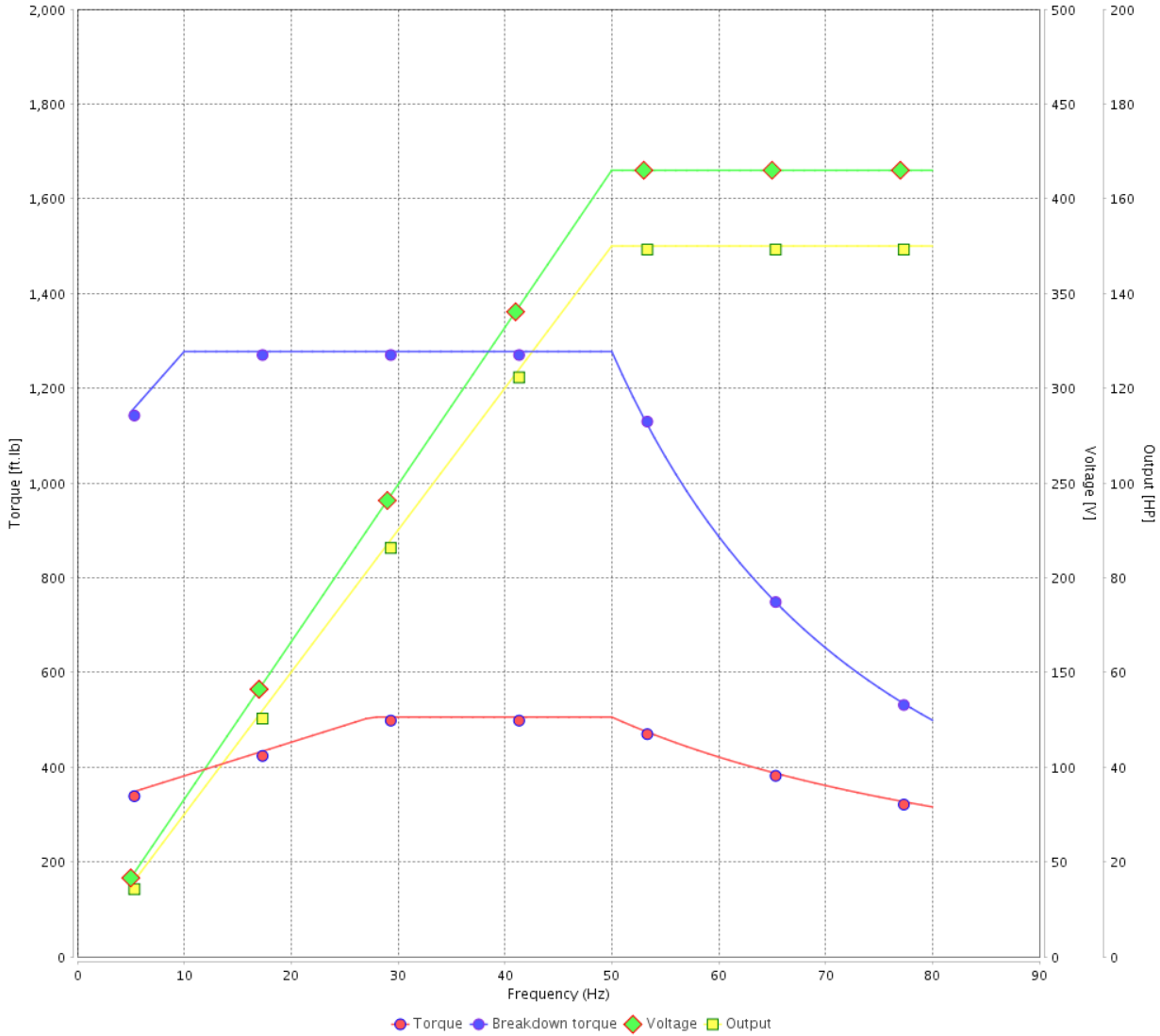

Performance : 415 V 50 Hz 4P IE3

Rated current	: 189 A	Moment of inertia (J)	: 66.7 sq.ft.lb
LRC	: 6.3	Duty cycle	: Cont.(S1)
Rated torque	: 532 ft.lb	Insulation class	: F
Locked rotor torque	: 190 %	Service factor	: 1.00
Breakdown torque	: 240 %	Temperature rise	: 105 K
Rated speed	: 1480 rpm	Design	: B

Rev.	Changes Summary	Performed	Checked	Date
Performed by			Page 36 / 36	Revision
Checked by				
Date	13/04/2022			

1 2 3 4 5 6

A

B

C

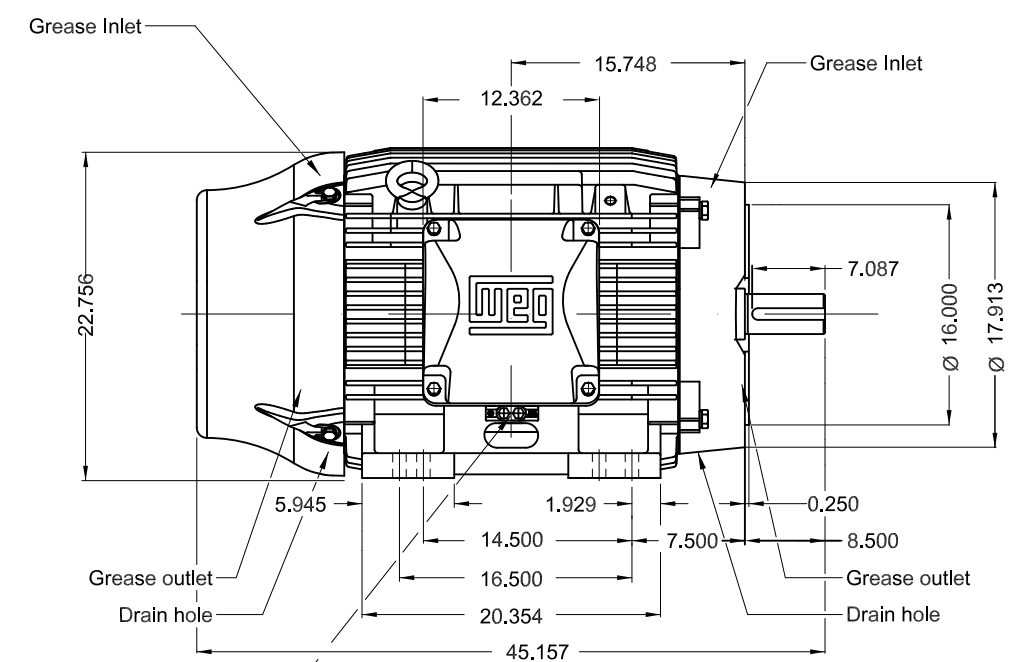
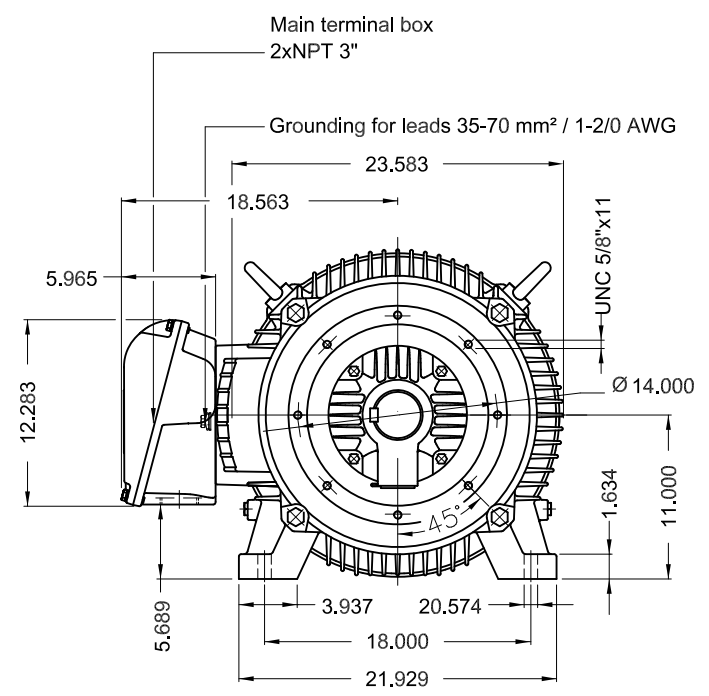

D

E

- Internal AEGIS ground ring on the DE
- Color RAL 5009
- Painting plan 203A
- Mounting NEMA F-1
- Mounting B34R(D)

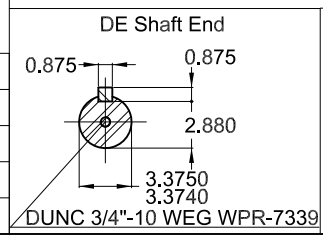

150 HP 04 Poles 60 Hz A

ECM	LOC	SUMMARY OF MODIFICATIONS	EXECUTED	CHECKED	RELEASED	DATE	VER
EXECUTED	PIRWUSER	THREE PH. MOTOR W22 PREM. EFF.					
CHECKED		FRAME 444/5TC IP55 TEFC					
RELEASED							
REL DT.	WMO	Jaragua do Sul	Product Engineering	SHEET	1 / 1		

PREVIEW
WDD

