

# DATA SHEET



## Three Phase Induction Motor - Squirrel Cage

Customer :								
Product line	: NEMA Premium Efficiency Three-Phase	Product code :	11356111					
		Catalog # :	15036ET3G445TS-W22					
Frame	: 444/5TS	Cooling method	: IC411 - TEFC					
Insulation class	: F	Mounting	: F-1					
Duty cycle	: Cont.(S1)	Rotation <sup>1</sup>	: Both (CW and CCW)					
Ambient temperature	: -20°C to +40°C	Starting method	: Direct On Line					
Altitude	: 1000 m.a.s.l.	Approx. weight <sup>2</sup>	: 1750 lb					
Protection degree	: IP55	Moment of inertia (J)	: 39.1 sq.ft.lb					
Design	: B							
Output [HP]	150	125	125	125	150	150	150	
Poles	2	2	2	2	2	2	2	
Frequency [Hz]	60	50	50	50	50	50	50	
Rated voltage [V]	460	380	400	415	380	400	415	
Rated current [A]	163	162	154	148	200	189	182	
L. R. Amperes [A]	1060	988	1063	1080	1020	1077	1110	
LRC [A]	6.5x(Code G)	6.1x(Code F)	6.9x(Code G)	7.3x(Code G)	5.1x(Code D)	5.7x(Code E)	6.1x(Code F)	
No load current [A]	41.0	41.0	43.1	45.1	41.0	43.1	45.1	
Rated speed [RPM]	3570	2965	2970	2970	2960	2965	2965	
Slip [%]	0.83	1.17	1.00	1.00	1.33	1.17	1.17	
Rated torque [ft.lb]	221	221	221	221	266	266	266	
Locked rotor torque [%]	180	170	190	200	140	160	170	
Breakdown torque [%]	240	229	250	280	190	210	229	
Service factor	1.15	1.00	1.00	1.00	1.00	1.00	1.00	
Temperature rise	80 K	80 K	80 K	80 K	105 K	105 K	80 K	
Locked rotor time	39s (cold) 22s (hot)	30s (cold) 17s (hot)	30s (cold) 17s (hot)	30s (cold) 17s (hot)	30s (cold) 17s (hot)	30s (cold) 17s (hot)	30s (cold) 17s (hot)	
Noise level <sup>2</sup>	81.0 dB(A)	77.0 dB(A)	77.0 dB(A)	77.0 dB(A)	77.0 dB(A)	77.0 dB(A)	77.0 dB(A)	
Efficiency (%)	25%	94.0	93.0	93.9	93.9	94.3	94.8	94.8
	50%	94.1	93.7	94.1	94.1	94.1	94.5	94.5
	75%	95.0	94.4	94.9	94.9	94.5	95.0	95.0
	100%	95.0	95.0	95.0	95.0	94.1	94.5	94.5
Power Factor	25%	0.60	0.59	0.56	0.53	0.65	0.62	0.60
	50%	0.83	0.81	0.79	0.77	0.86	0.84	0.83
	75%	0.88	0.88	0.88	0.87	0.89	0.89	0.88
	100%	0.89	0.89	0.89	0.89	0.89	0.89	0.89
Bearing type	: Drive end : 6314 C3	Non drive end : 6314 C3	Foundation loads					
Sealing	: WSeal	WSeal	Max. traction	: 753 lb				
Lubrication interval	: 4000 h	4000 h	Max. compression	: 2504 lb				
Lubricant amount	: 27 g	27 g						
Lubricant type	: Mobil Polyrex EM							
Notes								
This revision replaces and cancel the previous one, which must be eliminated. (1) Looking the motor from the shaft end. (2) Measured at 1m and with tolerance of +3dB(A). (3) Approximate weight subject to changes after manufacturing process. (4) At 100% of full load.				These are average values based on tests with sinusoidal power supply, subject to the tolerances stipulated in NEMA MG-1.				
Rev.	Changes Summary			Performed	Checked	Date		
Performed by								
Checked by					Page	Revision		
Date	13/04/2022				1 / 36			

# TORQUE AND CURRENT VS SPEED CURVE

## Three Phase Induction Motor - Squirrel Cage



Customer :

Product line : NEMA Premium Efficiency Three-Phase

Product code : 11356111

Catalog # : 15036ET3G445TS-W22

TORQUE AND CURRENT VS SPEED CURVE

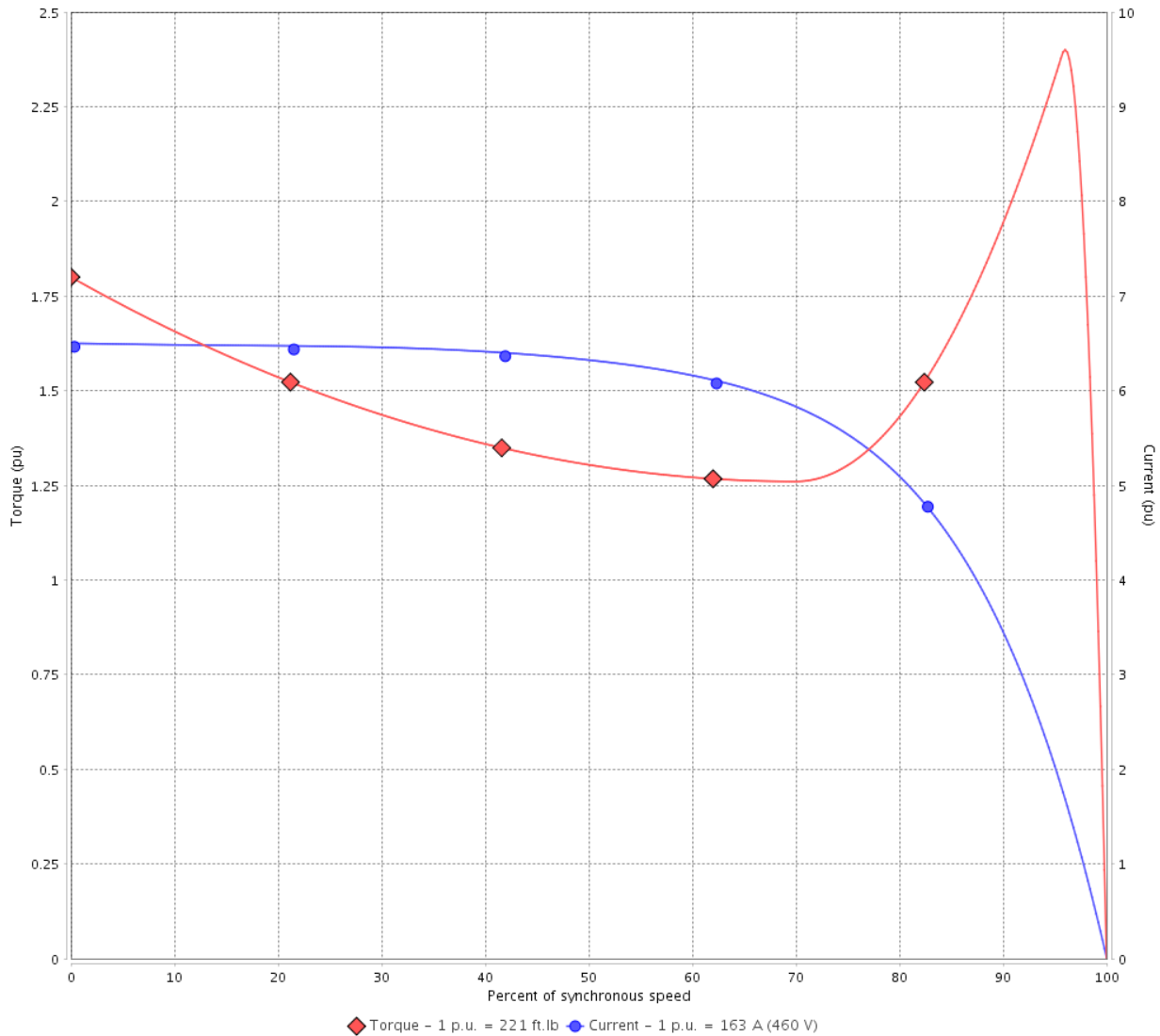

Performance : 460 V 60 Hz 2P

Rated current	: 163 A	Moment of inertia (J)	: 39.1 sq.ft.lb
LRC	: 6.5	Duty cycle	: Cont.(S1)
Rated torque	: 221 ft.lb	Insulation class	: F
Locked rotor torque	: 180 %	Service factor	: 1.15
Breakdown torque	: 240 %	Temperature rise	: 80 K
Rated speed	: 3570 rpm	Design	: B

Locked rotor time : 39s (cold) 22s (hot)

Rev.	Changes Summary	Performed	Checked	Date
Performed by			Page 2 / 36	Revision
Checked by				
Date	13/04/2022			

# TORQUE AND CURRENT VS SPEED CURVE



## Three Phase Induction Motor - Squirrel Cage

Customer :

Product line : NEMA Premium Efficiency Three-Phase

Product code : 11356111

Catalog # : 15036ET3G445TS-W22

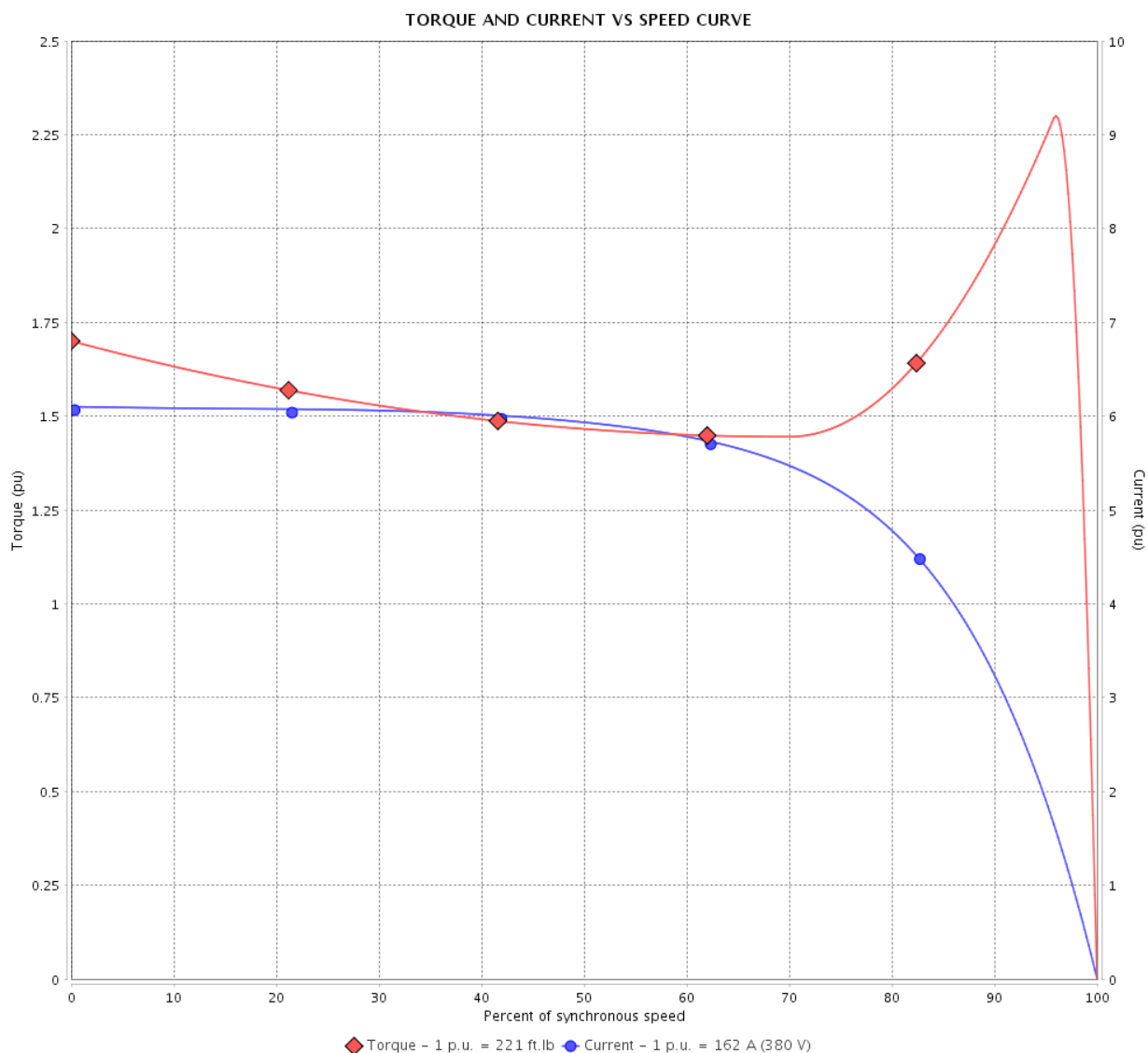

Performance : 380 V 50 Hz 2P IE3

Rated current	: 162 A	Moment of inertia (J)	: 39.1 sq.ft.lb
LRC	: 6.1	Duty cycle	: Cont.(S1)
Rated torque	: 221 ft.lb	Insulation class	: F
Locked rotor torque	: 170 %	Service factor	: 1.00
Breakdown torque	: 229 %	Temperature rise	: 80 K
Rated speed	: 2965 rpm	Design	: B

Locked rotor time : 30s (cold) 17s (hot)

Rev.	Changes Summary	Performed	Checked	Date
Performed by			Page 3 / 36	Revision
Checked by				
Date	13/04/2022			

# TORQUE AND CURRENT VS SPEED CURVE

## Three Phase Induction Motor - Squirrel Cage



Customer :

Product line : NEMA Premium Efficiency Three-Phase

Product code : 11356111

Catalog # : 15036ET3G445TS-W22

TORQUE AND CURRENT VS SPEED CURVE

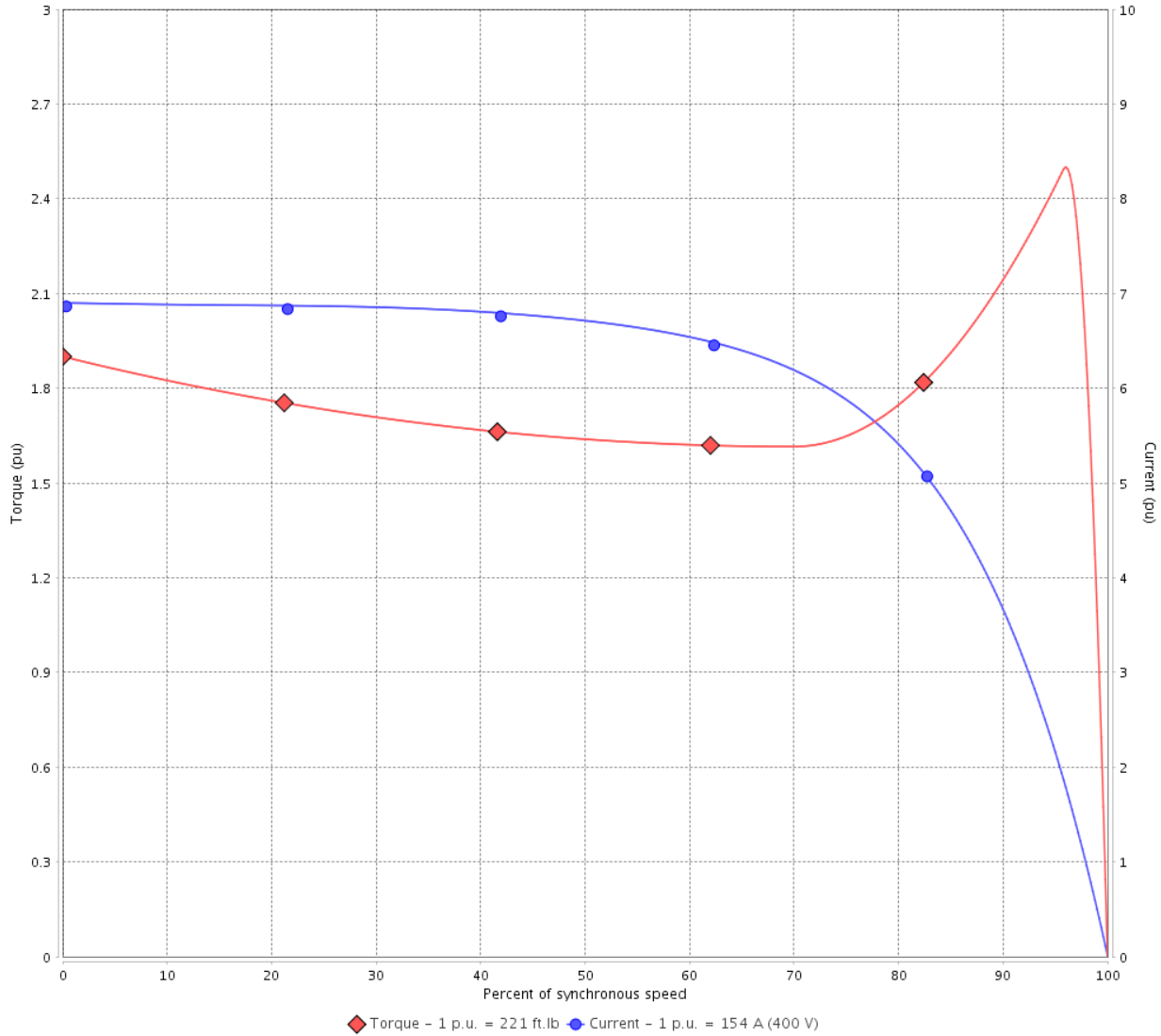

Performance : 400 V 50 Hz 2P IE3

Rated current	: 154 A	Moment of inertia (J)	: 39.1 sq.ft.lb
LRC	: 6.9	Duty cycle	: Cont.(S1)
Rated torque	: 221 ft.lb	Insulation class	: F
Locked rotor torque	: 190 %	Service factor	: 1.00
Breakdown torque	: 250 %	Temperature rise	: 80 K
Rated speed	: 2970 rpm	Design	: B

Locked rotor time : 30s (cold) 17s (hot)

Rev.	Changes Summary	Performed	Checked	Date
Performed by			Page 4 / 36	Revision
Checked by				
Date	13/04/2022			

# TORQUE AND CURRENT VS SPEED CURVE



## Three Phase Induction Motor - Squirrel Cage

Customer :

Product line : NEMA Premium Efficiency Three-Phase

Product code : 11356111

Catalog # : 15036ET3G445TS-W22

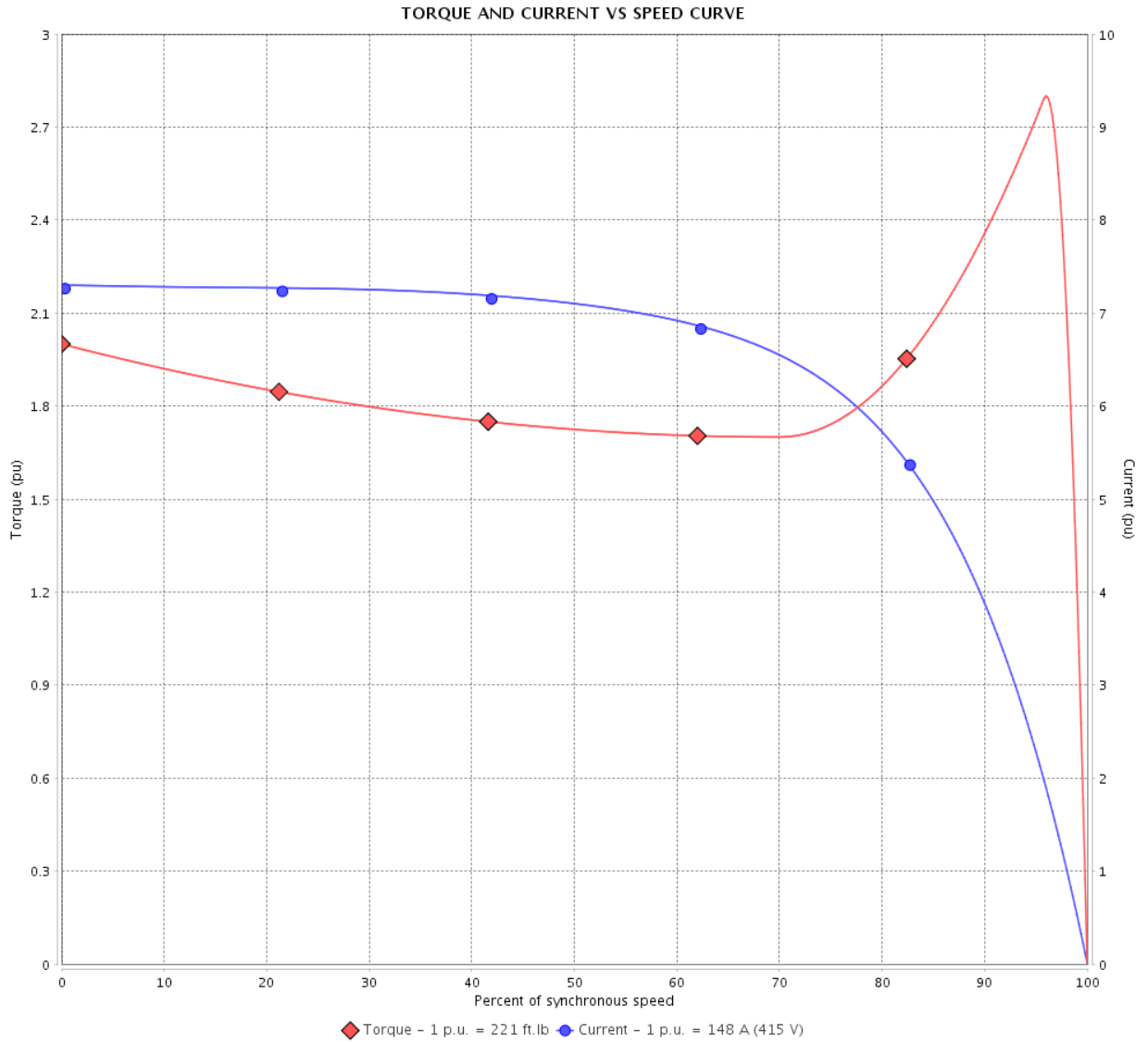

Performance : 415 V 50 Hz 2P IE3

Rated current	: 148 A	Moment of inertia (J)	: 39.1 sq.ft.lb
LRC	: 7.3	Duty cycle	: Cont.(S1)
Rated torque	: 221 ft.lb	Insulation class	: F
Locked rotor torque	: 200 %	Service factor	: 1.00
Breakdown torque	: 280 %	Temperature rise	: 80 K
Rated speed	: 2970 rpm	Design	: B

Locked rotor time : 30s (cold) 17s (hot)

Rev.	Changes Summary	Performed	Checked	Date
Performed by			Page 5 / 36	Revision
Checked by				
Date	13/04/2022			

# TORQUE AND CURRENT VS SPEED CURVE

## Three Phase Induction Motor - Squirrel Cage



Customer :

Product line : NEMA Premium Efficiency Three-Phase

Product code : 11356111

Catalog # : 15036ET3G445TS-W22

TORQUE AND CURRENT VS SPEED CURVE

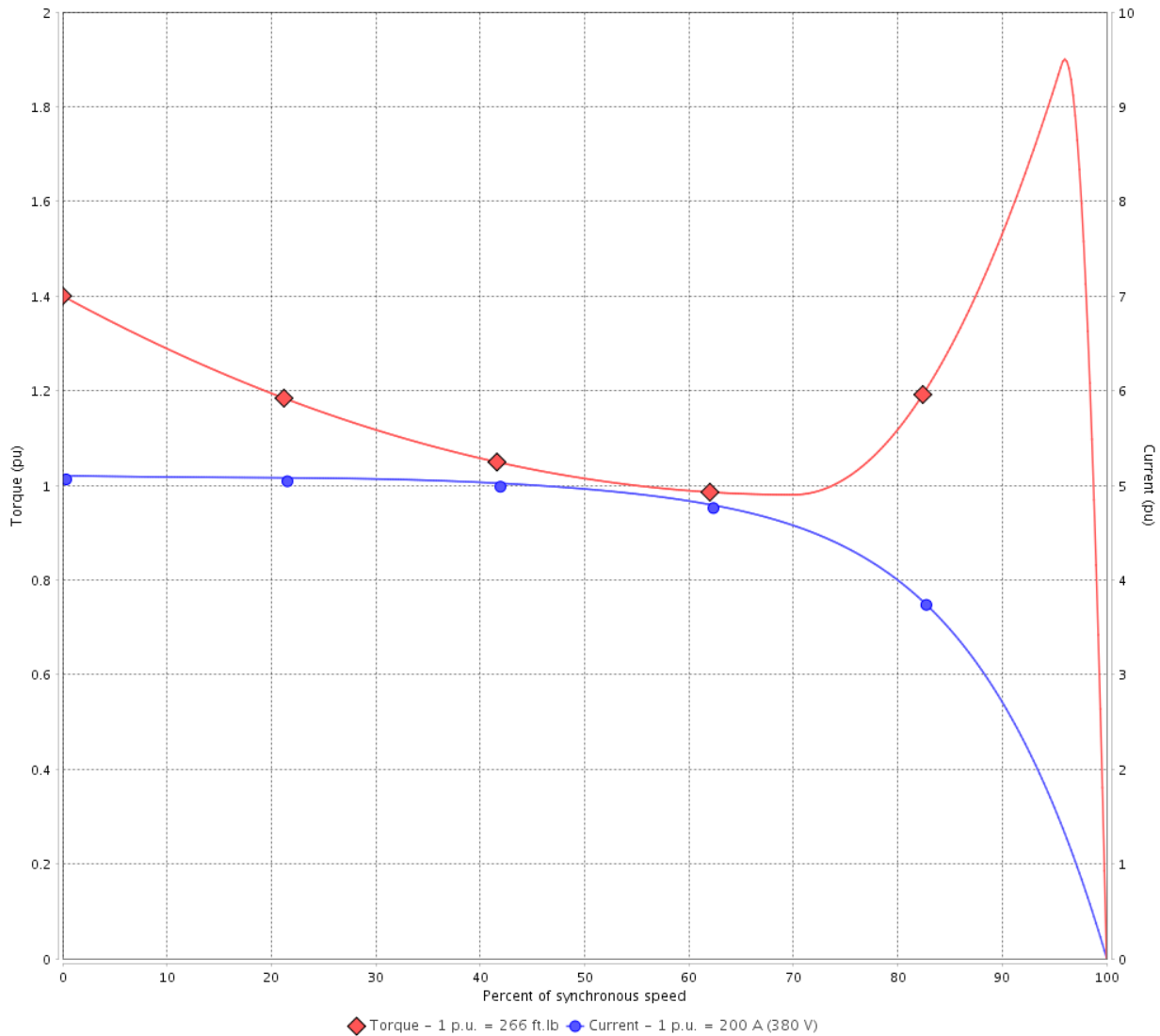

Performance : 380 V 50 Hz 2P IE1

Rated current	: 200 A	Moment of inertia (J)	: 39.1 sq.ft.lb
LRC	: 5.1	Duty cycle	: Cont.(S1)
Rated torque	: 266 ft.lb	Insulation class	: F
Locked rotor torque	: 140 %	Service factor	: 1.00
Breakdown torque	: 190 %	Temperature rise	: 105 K
Rated speed	: 2960 rpm	Design	: B

Locked rotor time : 30s (cold) 17s (hot)

Rev.	Changes Summary	Performed	Checked	Date
Performed by			Page 6 / 36	Revision
Checked by				
Date	13/04/2022			

# TORQUE AND CURRENT VS SPEED CURVE



## Three Phase Induction Motor - Squirrel Cage

Customer :

Product line : NEMA Premium Efficiency Three-Phase

Product code : 11356111

Catalog # : 15036ET3G445TS-W22

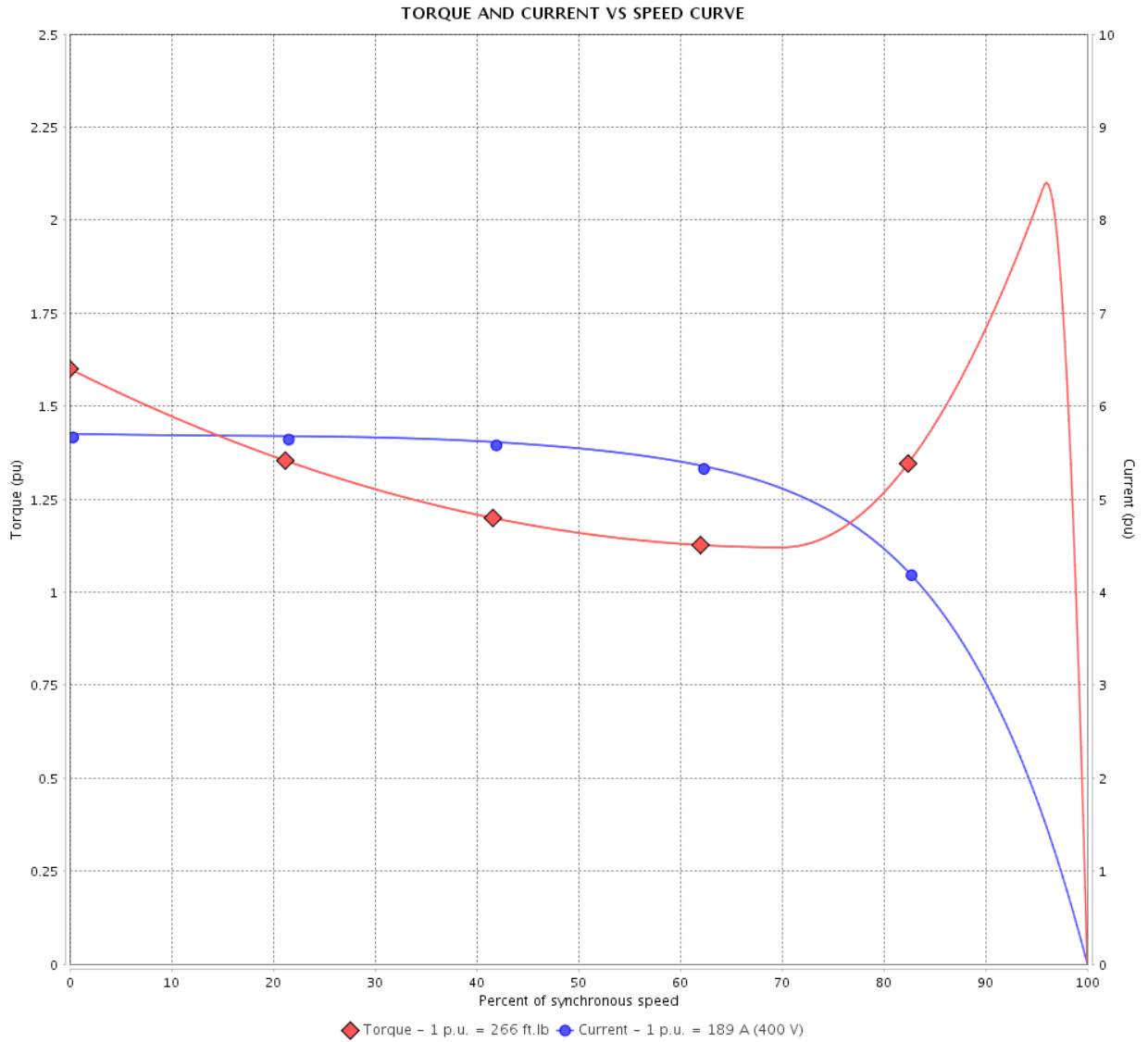

Performance : 400 V 50 Hz 2P IE2

Rated current	: 189 A	Moment of inertia (J)	: 39.1 sq.ft.lb
LRC	: 5.7	Duty cycle	: Cont.(S1)
Rated torque	: 266 ft.lb	Insulation class	: F
Locked rotor torque	: 160 %	Service factor	: 1.00
Breakdown torque	: 210 %	Temperature rise	: 105 K
Rated speed	: 2965 rpm	Design	: B

Locked rotor time : 30s (cold) 17s (hot)

Rev.	Changes Summary	Performed	Checked	Date
Performed by			Page 7 / 36	Revision
Checked by				
Date	13/04/2022			

# TORQUE AND CURRENT VS SPEED CURVE

Three Phase Induction Motor - Squirrel Cage



Customer :

Product line : NEMA Premium Efficiency Three-Phase

Product code : 11356111

Catalog # : 15036ET3G445TS-W22

TORQUE AND CURRENT VS SPEED CURVE

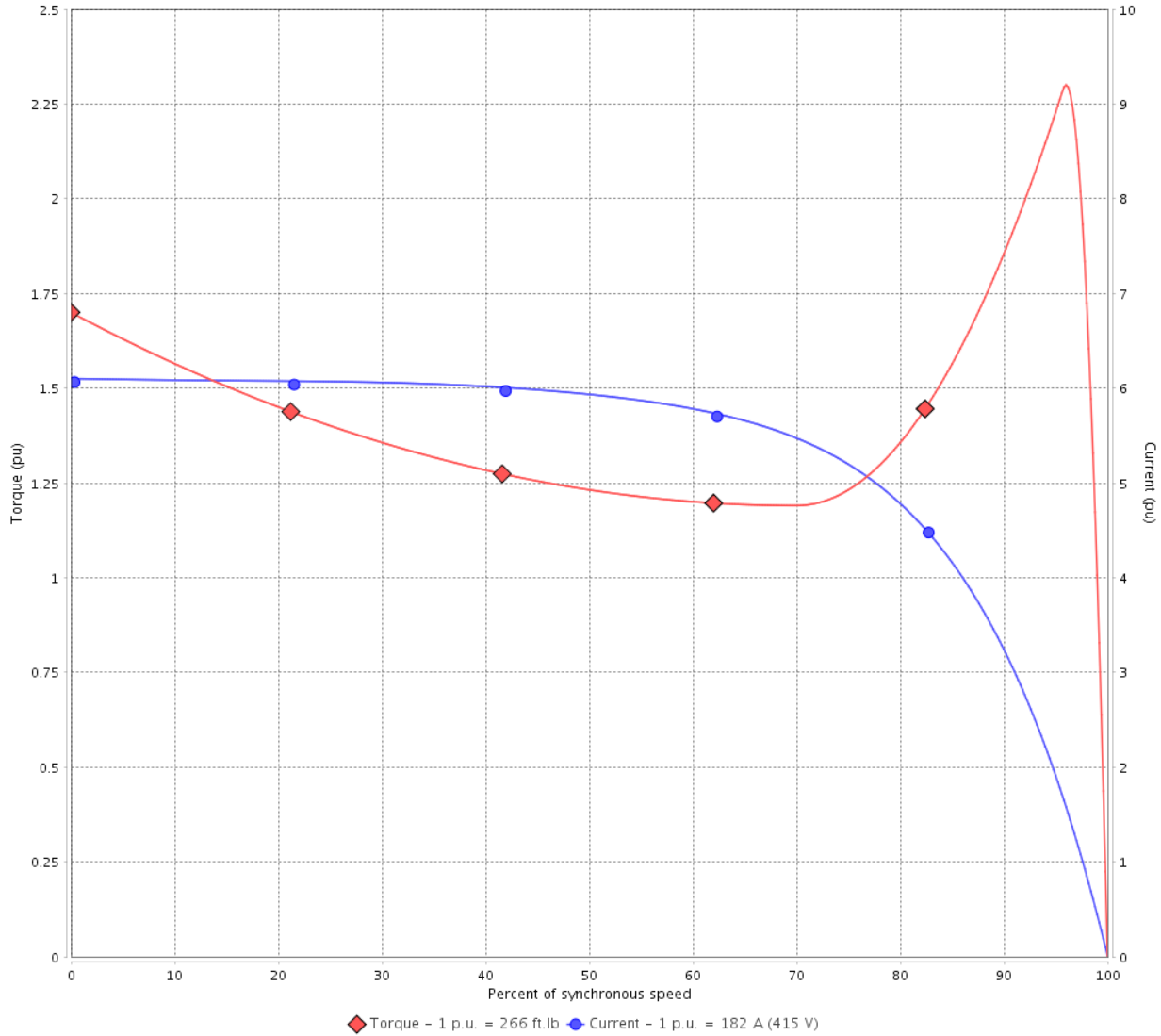

Performance : 415 V 50 Hz 2P IE2

Rated current	: 182 A	Moment of inertia (J)	: 39.1 sq.ft.lb
LRC	: 6.1	Duty cycle	: Cont.(S1)
Rated torque	: 266 ft.lb	Insulation class	: F
Locked rotor torque	: 170 %	Service factor	: 1.00
Breakdown torque	: 229 %	Temperature rise	: 80 K
Rated speed	: 2965 rpm	Design	: B

Locked rotor time : 30s (cold) 17s (hot)

Rev.	Changes Summary	Performed	Checked	Date
Performed by			Page	Revision
Checked by				
Date	13/04/2022			
			8 / 36	



# LOAD PERFORMANCE CURVE

## Three Phase Induction Motor - Squirrel Cage



Customer :

Product line : NEMA Premium Efficiency Three-Phase

Product code : 11356111

Catalog # : 15036ET3G445TS-W22

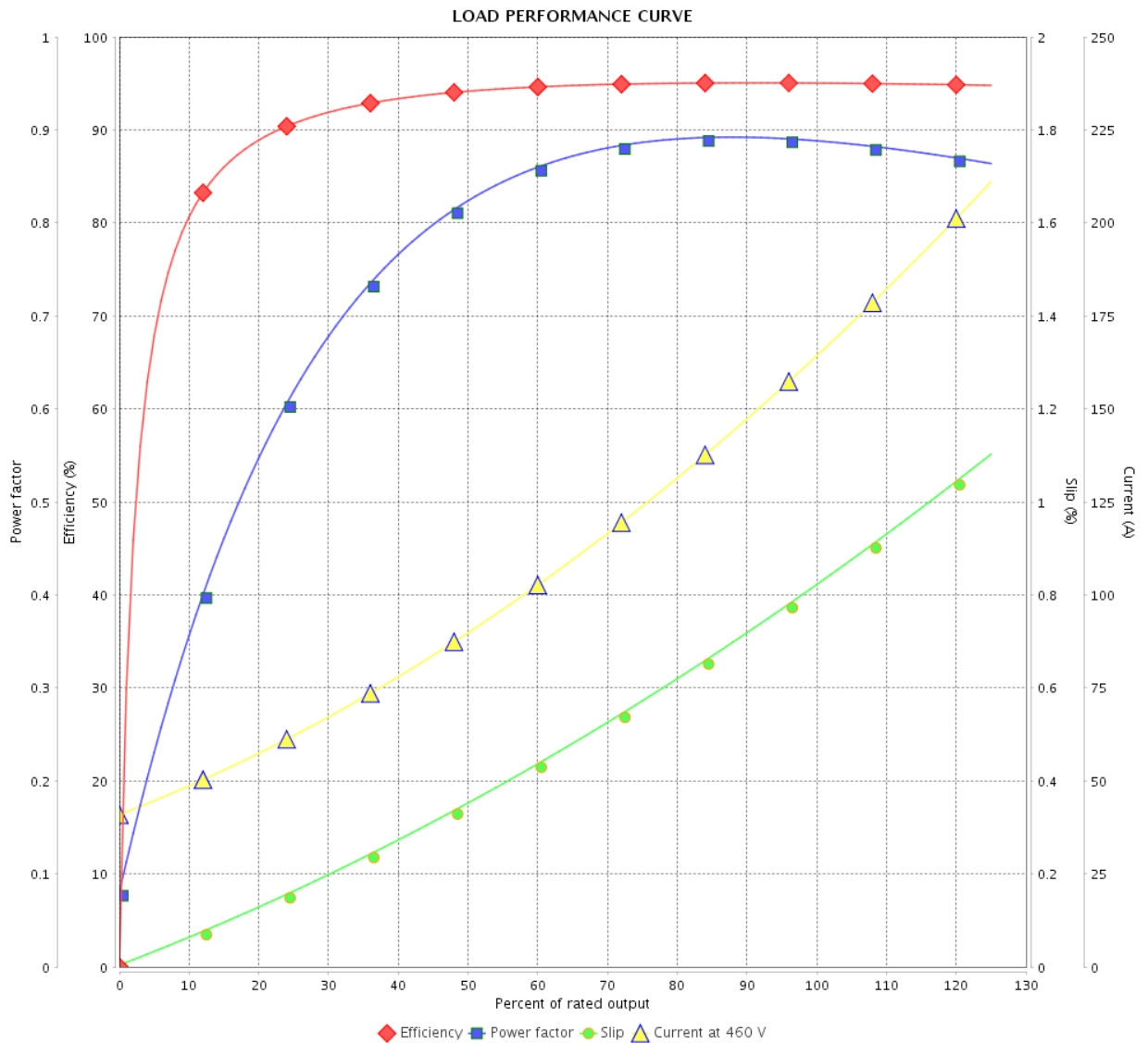

Performance : 460 V 60 Hz 2P

Rated current : 163 A  
 LRC : 6.5  
 Rated torque : 221 ft.lb  
 Locked rotor torque : 180 %  
 Breakdown torque : 240 %  
 Rated speed : 3570 rpm

Moment of inertia (J) : 39.1 sq.ft.lb  
 Duty cycle : Cont.(S1)  
 Insulation class : F  
 Service factor : 1.15  
 Temperature rise : 80 K  
 Design : B

Rev.	Changes Summary	Performed	Checked	Date
Performed by		Page		Revision
Checked by		9 / 36		
Date		13/04/2022		

# LOAD PERFORMANCE CURVE

Three Phase Induction Motor - Squirrel Cage



Customer :

Product line : NEMA Premium Efficiency Three-Phase

Product code : 11356111

Catalog # : 15036ET3G445TS-W22

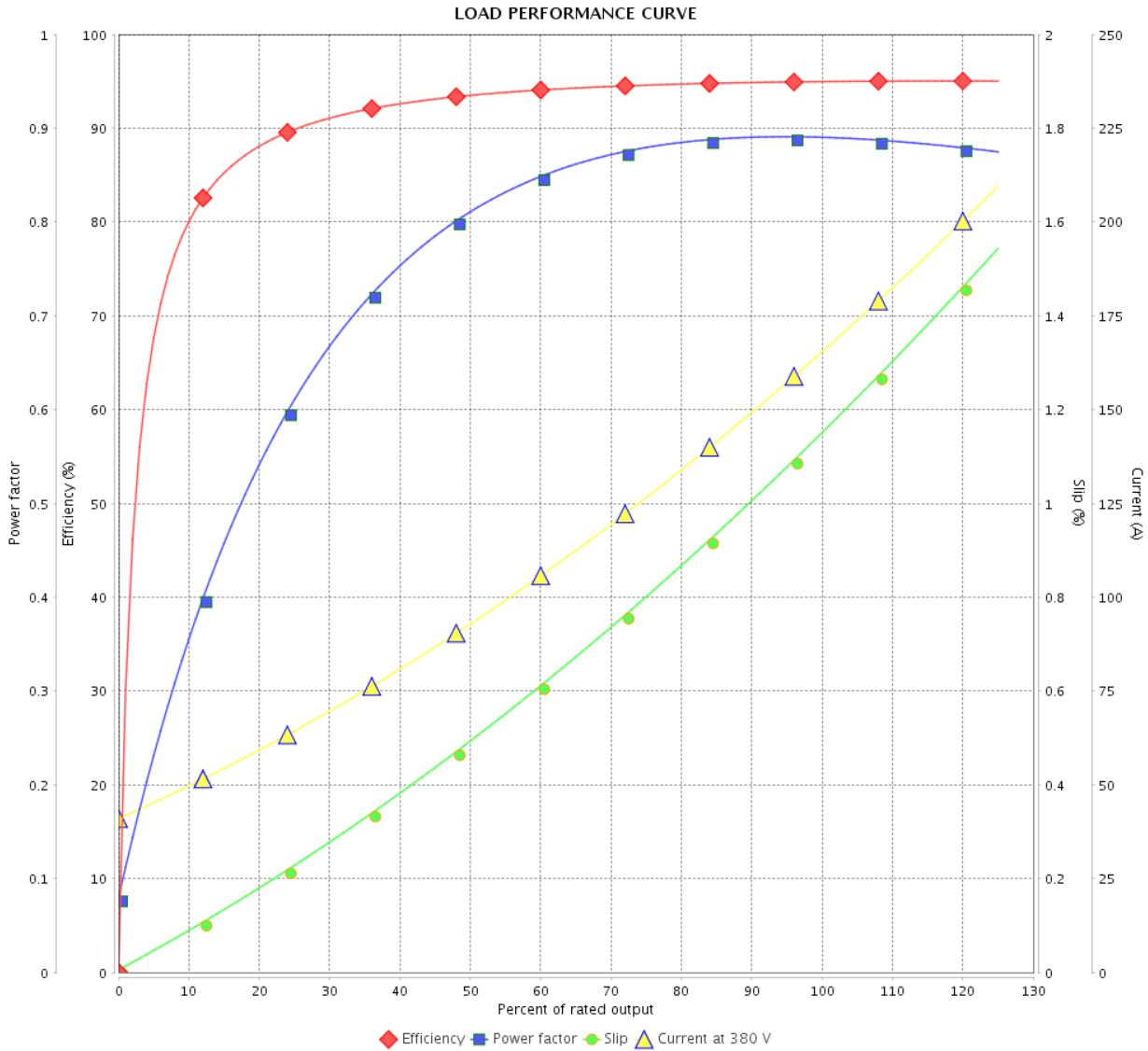

Performance : 380 V 50 Hz 2P IE3

Rated current : 162 A  
 LRC : 6.1  
 Rated torque : 221 ft.lb  
 Locked rotor torque : 170 %  
 Breakdown torque : 229 %  
 Rated speed : 2965 rpm

Moment of inertia (J) : 39.1 sq.ft.lb  
 Duty cycle : Cont.(S1)  
 Insulation class : F  
 Service factor : 1.00  
 Temperature rise : 80 K  
 Design : B

Rev.	Changes Summary	Performed	Checked	Date
Performed by		Page		Revision
Checked by		10 / 36		
Date	13/04/2022			

# LOAD PERFORMANCE CURVE

## Three Phase Induction Motor - Squirrel Cage



Customer :

Product line : NEMA Premium Efficiency Three-Phase

Product code : 11356111

Catalog # : 15036ET3G445TS-W22

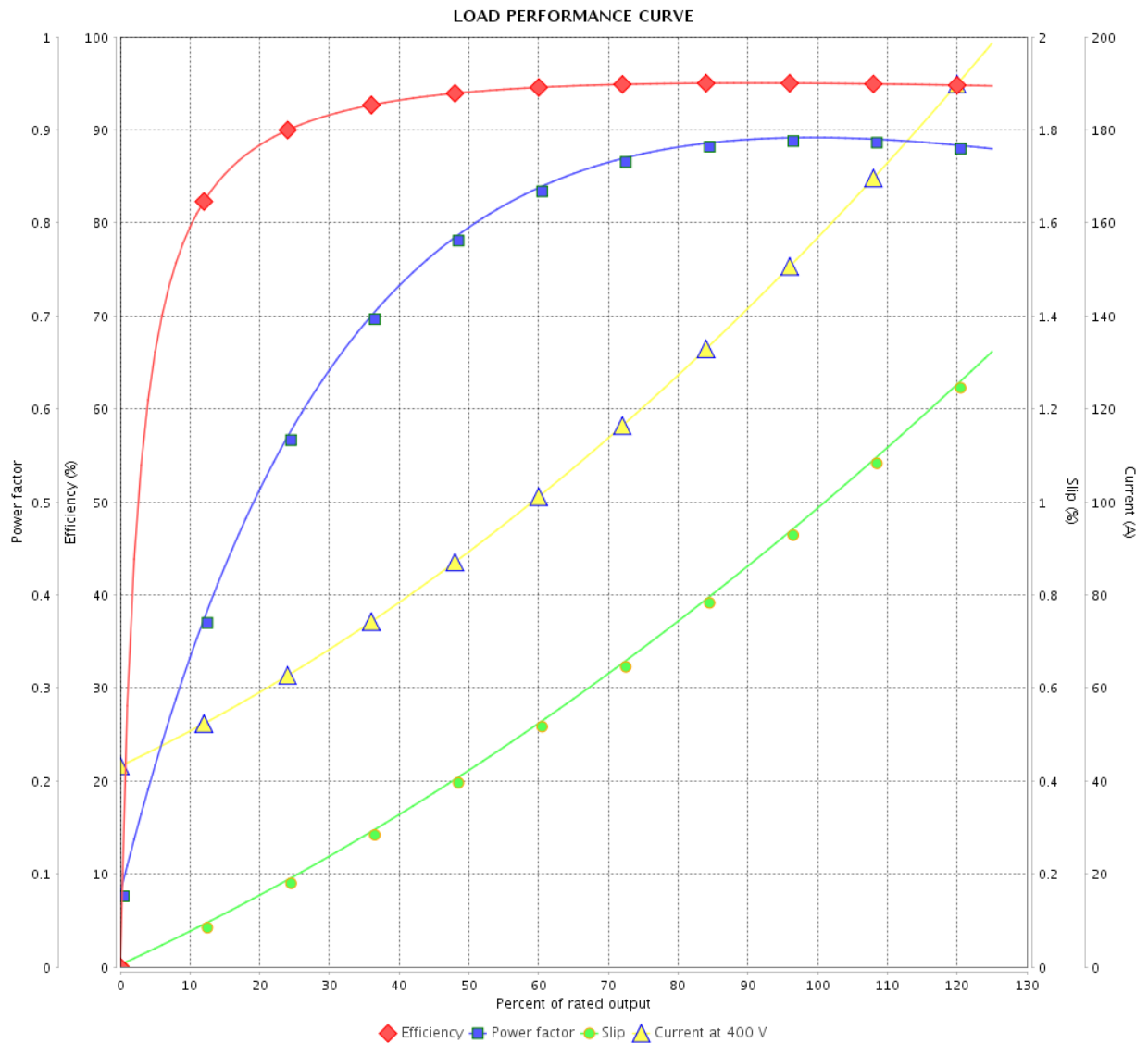

Performance : 400 V 50 Hz 2P IE3

Rated current : 154 A  
 LRC : 6.9  
 Rated torque : 221 ft.lb  
 Locked rotor torque : 190 %  
 Breakdown torque : 250 %  
 Rated speed : 2970 rpm

Moment of inertia (J) : 39.1 sq.ft.lb  
 Duty cycle : Cont.(S1)  
 Insulation class : F  
 Service factor : 1.00  
 Temperature rise : 80 K  
 Design : B

Rev.	Changes Summary	Performed	Checked	Date
Performed by		Page		Revision
Checked by		11 / 36		
Date		13/04/2022		

# LOAD PERFORMANCE CURVE

Three Phase Induction Motor - Squirrel Cage



Customer :

Product line : NEMA Premium Efficiency Three-Phase

Product code : 11356111

Catalog # : 15036ET3G445TS-W22

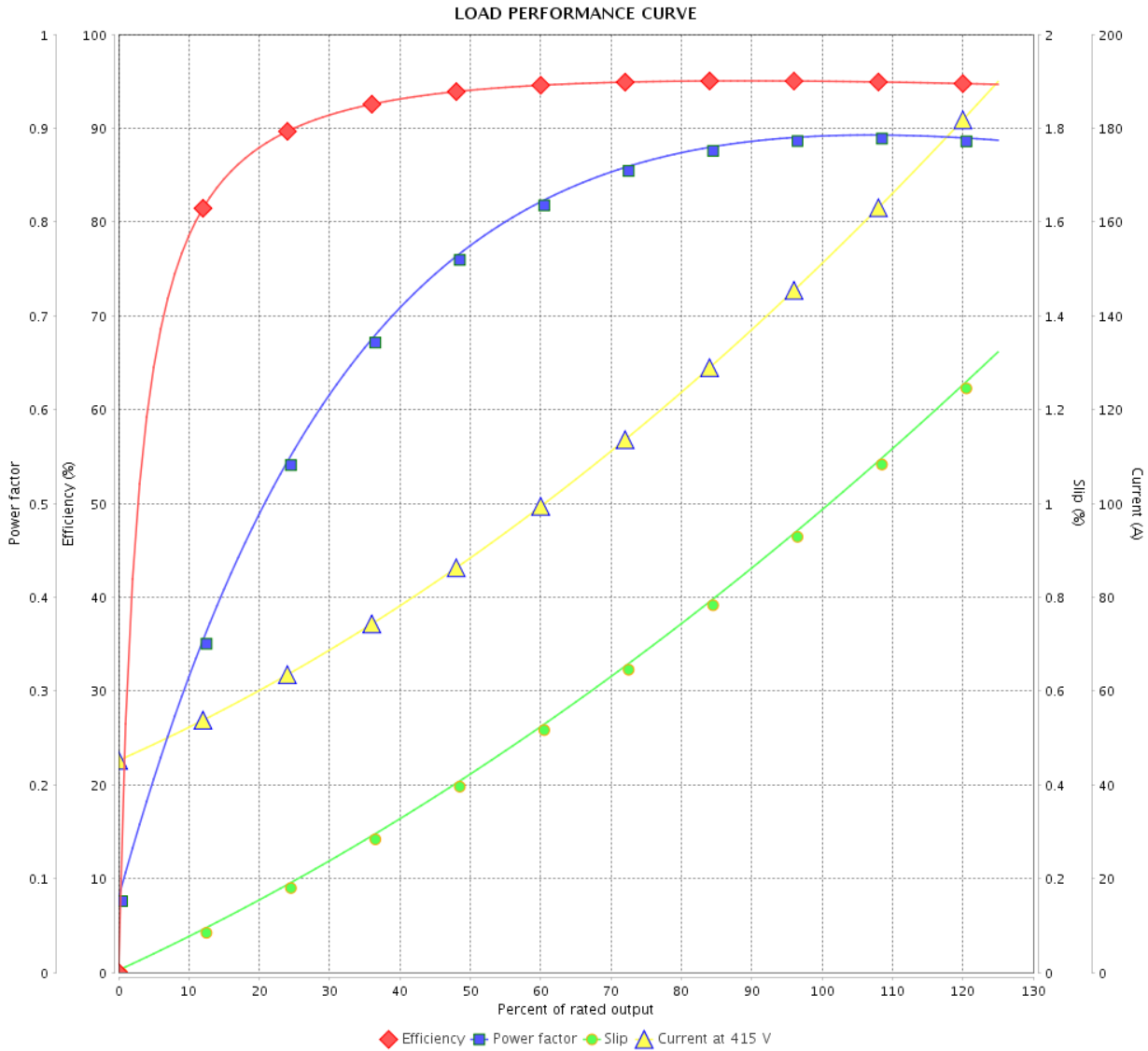

Performance : 415 V 50 Hz 2P IE3

Rated current : 148 A  
 LRC : 7.3  
 Rated torque : 221 ft.lb  
 Locked rotor torque : 200 %  
 Breakdown torque : 280 %  
 Rated speed : 2970 rpm

Moment of inertia (J) : 39.1 sq.ft.lb  
 Duty cycle : Cont.(S1)  
 Insulation class : F  
 Service factor : 1.00  
 Temperature rise : 80 K  
 Design : B

Rev.	Changes Summary	Performed	Checked	Date
Performed by		Page		Revision
Checked by		12 / 36		
Date		13/04/2022		

# LOAD PERFORMANCE CURVE

## Three Phase Induction Motor - Squirrel Cage



Customer :

Product line : NEMA Premium Efficiency Three-Phase

Product code : 11356111

Catalog # : 15036ET3G445TS-W22

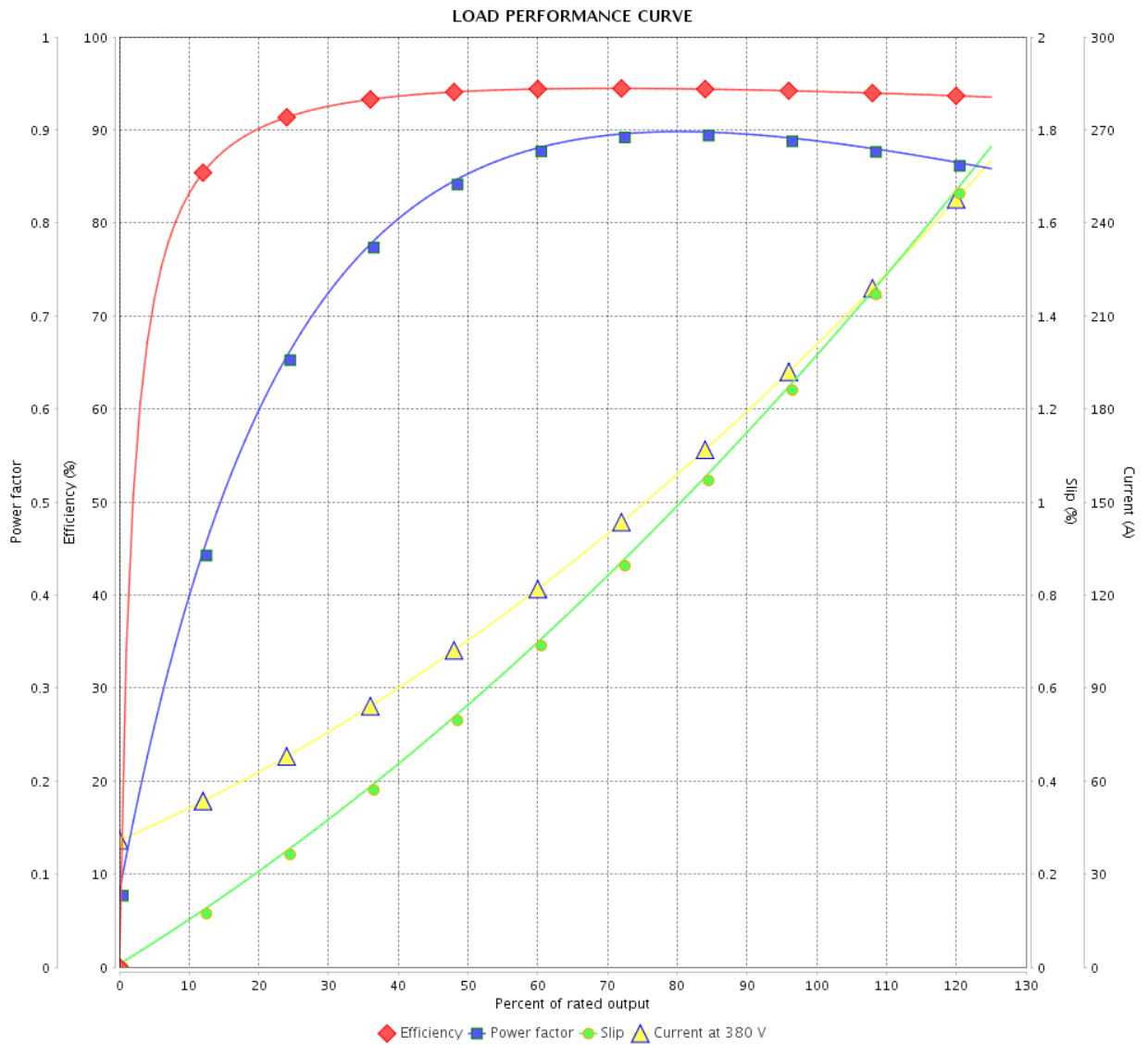

Performance : 380 V 50 Hz 2P IE1

Rated current : 200 A  
 LRC : 5.1  
 Rated torque : 266 ft.lb  
 Locked rotor torque : 140 %  
 Breakdown torque : 190 %  
 Rated speed : 2960 rpm

Moment of inertia (J) : 39.1 sq.ft.lb  
 Duty cycle : Cont.(S1)  
 Insulation class : F  
 Service factor : 1.00  
 Temperature rise : 105 K  
 Design : B

Rev.	Changes Summary	Performed	Checked	Date
Performed by		Page		Revision
Checked by		13 / 36		
Date		13 / 04 / 2022		

# LOAD PERFORMANCE CURVE

Three Phase Induction Motor - Squirrel Cage



Customer :

Product line : NEMA Premium Efficiency Three-Phase

Product code : 11356111

Catalog # : 15036ET3G445TS-W22

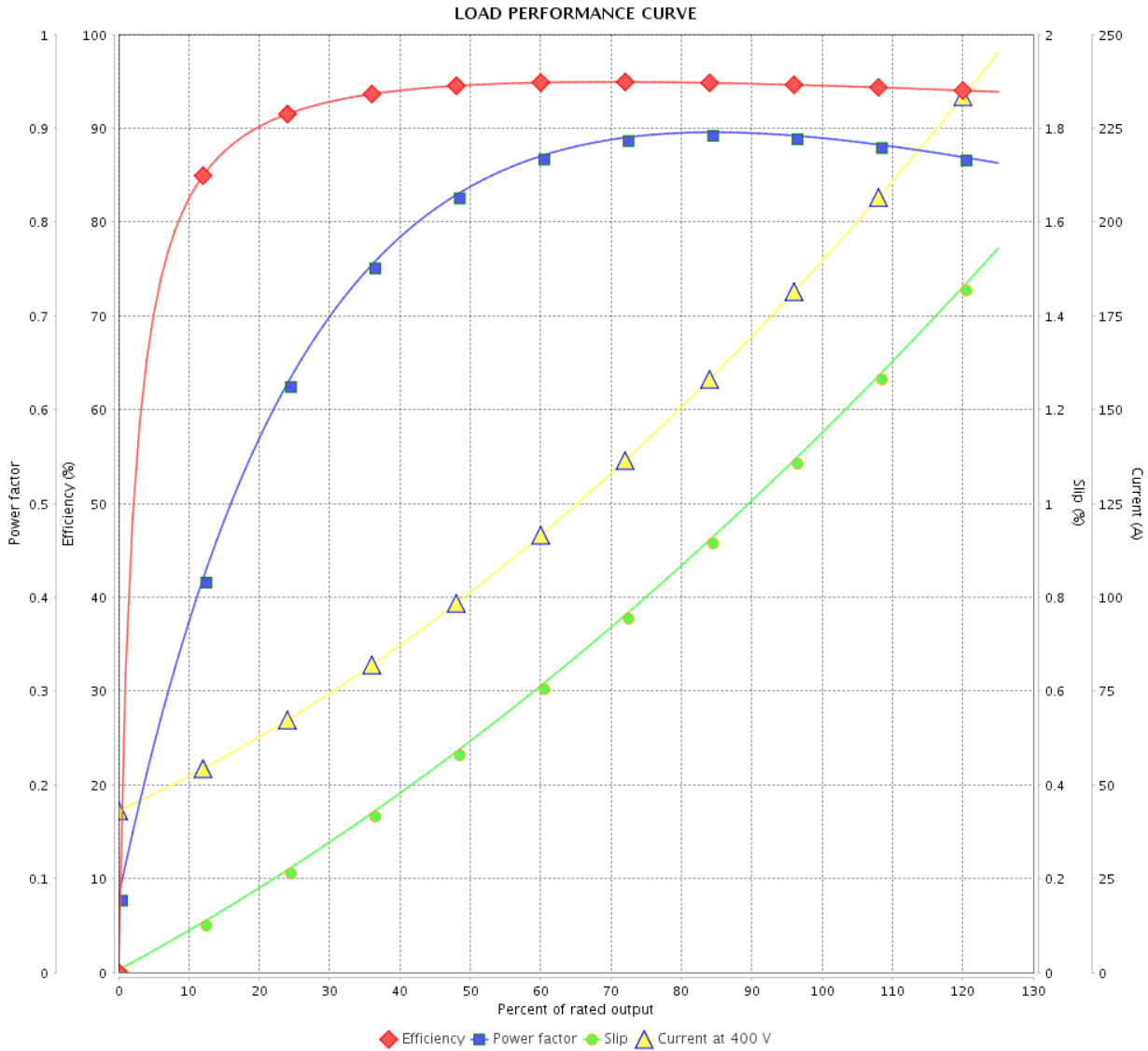

Performance : 400 V 50 Hz 2P IE2

Rated current : 189 A  
 LRC : 5.7  
 Rated torque : 266 ft.lb  
 Locked rotor torque : 160 %  
 Breakdown torque : 210 %  
 Rated speed : 2965 rpm

Moment of inertia (J) : 39.1 sq.ft.lb  
 Duty cycle : Cont.(S1)  
 Insulation class : F  
 Service factor : 1.00  
 Temperature rise : 105 K  
 Design : B

Rev.	Changes Summary	Performed	Checked	Date
Performed by				
Checked by				
Date				
			Page	Revision
			14 / 36	

# LOAD PERFORMANCE CURVE

## Three Phase Induction Motor - Squirrel Cage



Customer : \_\_\_\_\_

Product line : NEMA Premium Efficiency Three-Phase

Product code : 11356111

Catalog # : 15036ET3G445TS-W22

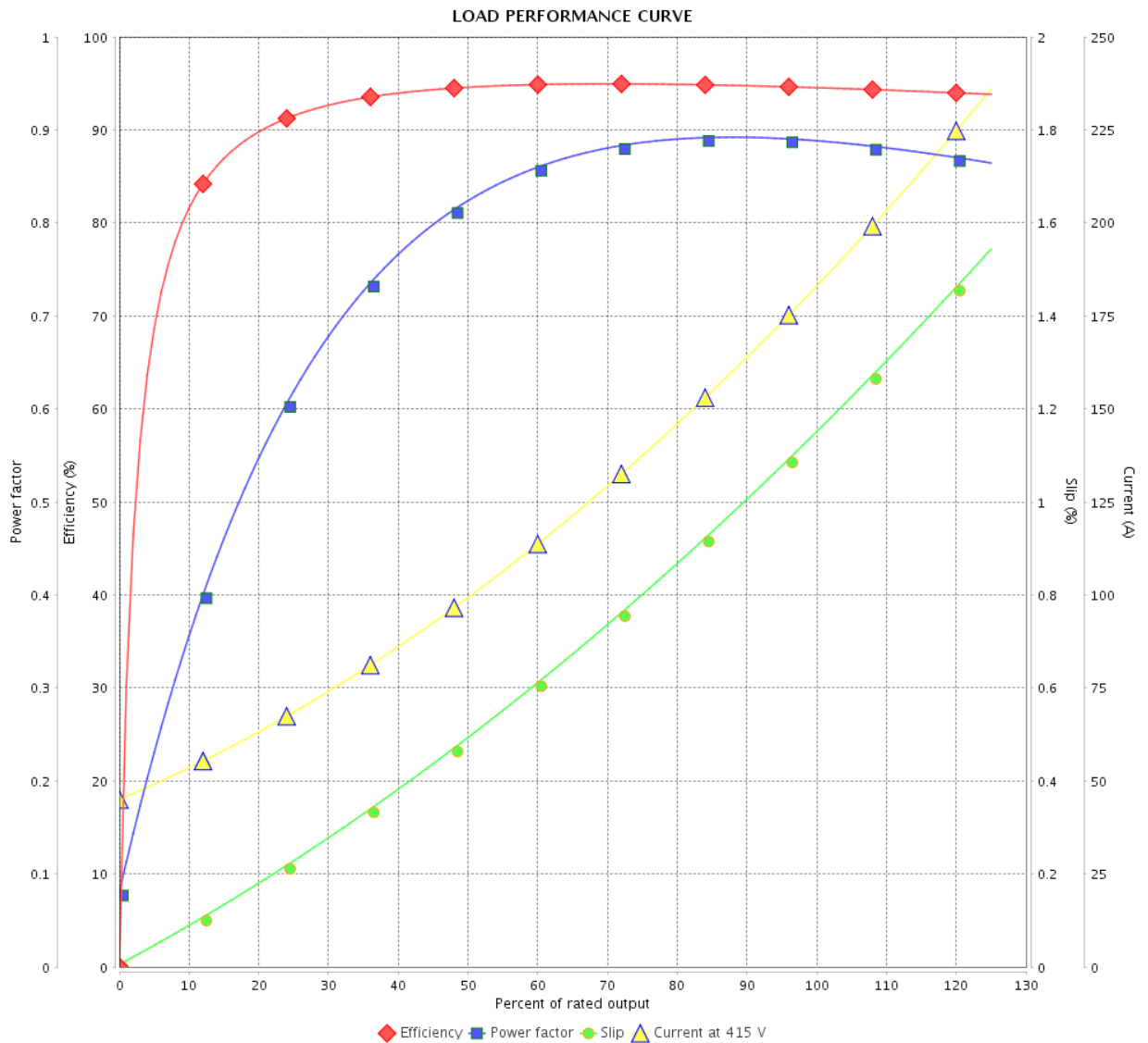

Performance : 415 V 50 Hz 2P IE2

Rated current : 182 A  
 LRC : 6.1  
 Rated torque : 266 ft.lb  
 Locked rotor torque : 170 %  
 Breakdown torque : 229 %  
 Rated speed : 2965 rpm

Moment of inertia (J) : 39.1 sq.ft.lb  
 Duty cycle : Cont.(S1)  
 Insulation class : F  
 Service factor : 1.00  
 Temperature rise : 80 K  
 Design : B

Rev.	Changes Summary	Performed	Checked	Date
Performed by		Page		Revision
Checked by		15 / 36		
Date		13/04/2022		

# THERMAL LIMIT CURVE



## Three Phase Induction Motor - Squirrel Cage

Customer :

Product line : NEMA Premium Efficiency Three-Phase  
Product code : 11356111  
Catalog # : 15036ET3G445TS-W22

Performance : 460 V 60 Hz 2P

Rated current	: 163 A	Moment of inertia (J)	: 39.1 sq.ft.lb
LRC	: 6.5	Duty cycle	: Cont.(S1)
Rated torque	: 221 ft.lb	Insulation class	: F
Locked rotor torque	: 180 %	Service factor	: 1.15
Breakdown torque	: 240 %	Temperature rise	: 80 K
Rated speed	: 3570 rpm	Design	: B

Heating constant

Cooling constant

Rev.	Changes Summary	Performed	Checked	Date
Performed by				
Checked by			Page	Revision
Date	13/04/2022		16 / 36	



# THERMAL LIMIT CURVE

Three Phase Induction Motor - Squirrel Cage



Customer : \_\_\_\_\_

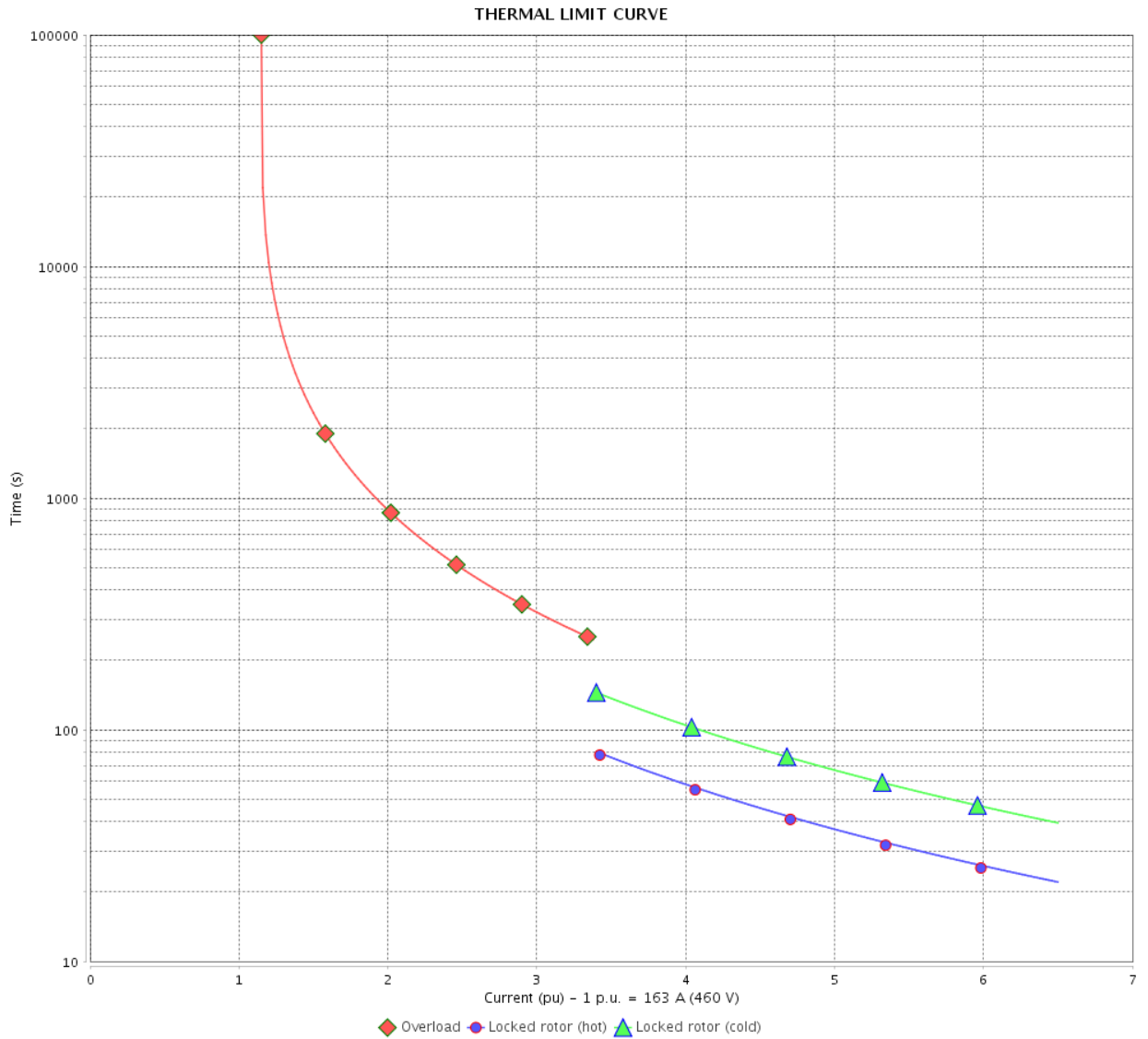

Rev.	Changes Summary	Performed	Checked	Date
Performed by		Page      Revision 17 / 36		
Checked by				
Date				

# THERMAL LIMIT CURVE



## Three Phase Induction Motor - Squirrel Cage

Customer :

Product line : NEMA Premium Efficiency Three-Phase  
 Product code : 11356111  
 Catalog # : 15036ET3G445TS-W22

Performance : 380 V 50 Hz 2P IE3

Rated current : 162 A	Moment of inertia (J) : 39.1 sq.ft.lb
LRC : 6.1	Duty cycle : Cont.(S1)
Rated torque : 221 ft.lb	Insulation class : F
Locked rotor torque : 170 %	Service factor : 1.00
Breakdown torque : 229 %	Temperature rise : 80 K
Rated speed : 2965 rpm	Design : B

Heating constant

Cooling constant

Rev.	Changes Summary	Performed	Checked	Date
Performed by			Page 18 / 36	Revision
Checked by				
Date	13/04/2022			

# THERMAL LIMIT CURVE

Three Phase Induction Motor - Squirrel Cage



Customer : \_\_\_\_\_

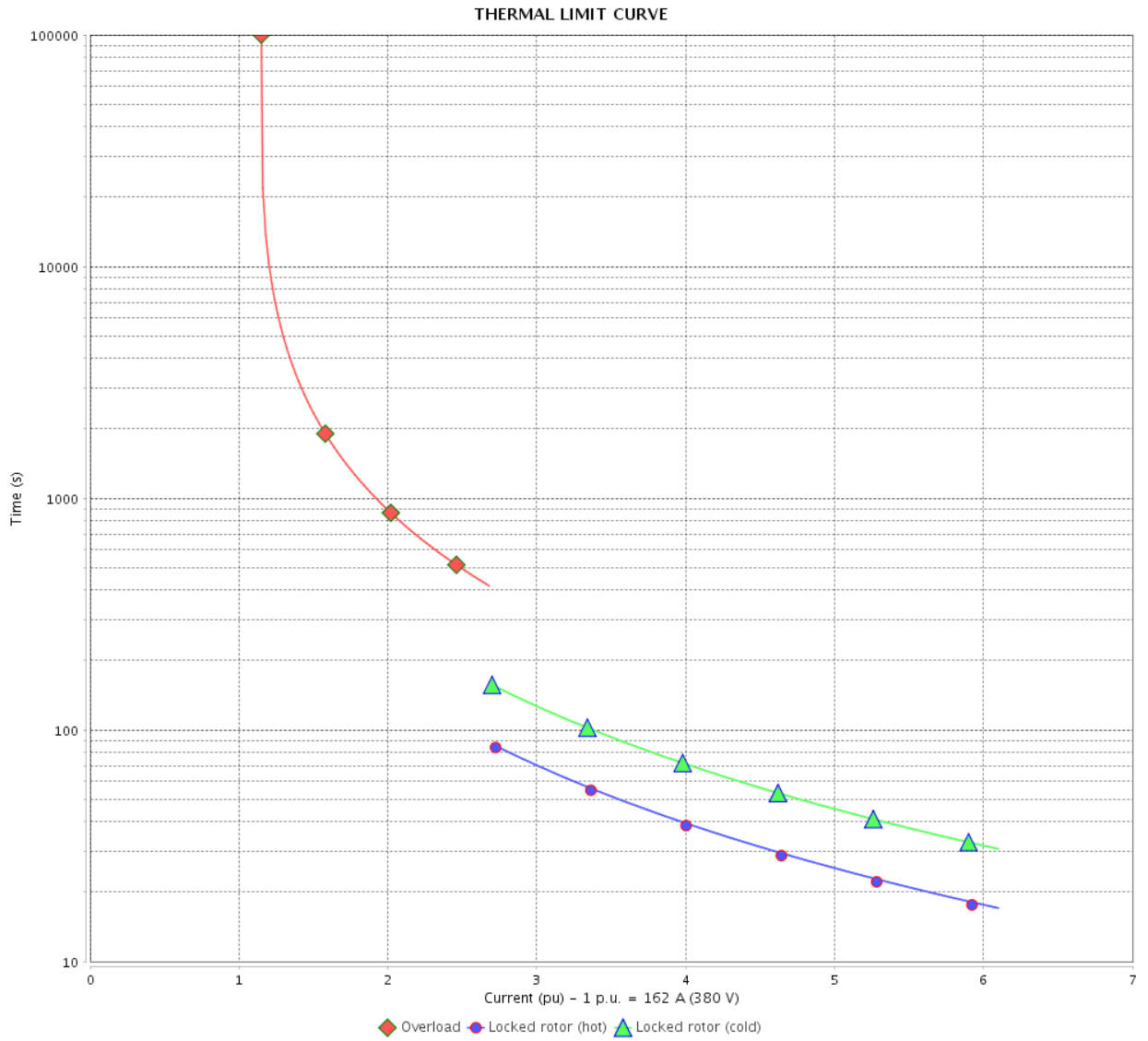

Rev.	Changes Summary	Performed	Checked	Date
Performed by		Page 19 / 36		Revision
Checked by				
Date				

# THERMAL LIMIT CURVE

## Three Phase Induction Motor - Squirrel Cage



Customer :

Product line : NEMA Premium Efficiency Three-Phase  
Product code : 11356111  
Catalog # : 15036ET3G445TS-W22

Performance : 400 V 50 Hz 2P IE3

Rated current	: 154 A	Moment of inertia (J)	: 39.1 sq.ft.lb
LRC	: 6.9	Duty cycle	: Cont.(S1)
Rated torque	: 221 ft.lb	Insulation class	: F
Locked rotor torque	: 190 %	Service factor	: 1.00
Breakdown torque	: 250 %	Temperature rise	: 80 K
Rated speed	: 2970 rpm	Design	: B

Heating constant

Cooling constant

Rev.	Changes Summary	Performed	Checked	Date
Performed by				
Checked by			Page	Revision
Date	13/04/2022		20 / 36	

# THERMAL LIMIT CURVE

Three Phase Induction Motor - Squirrel Cage



Customer : \_\_\_\_\_

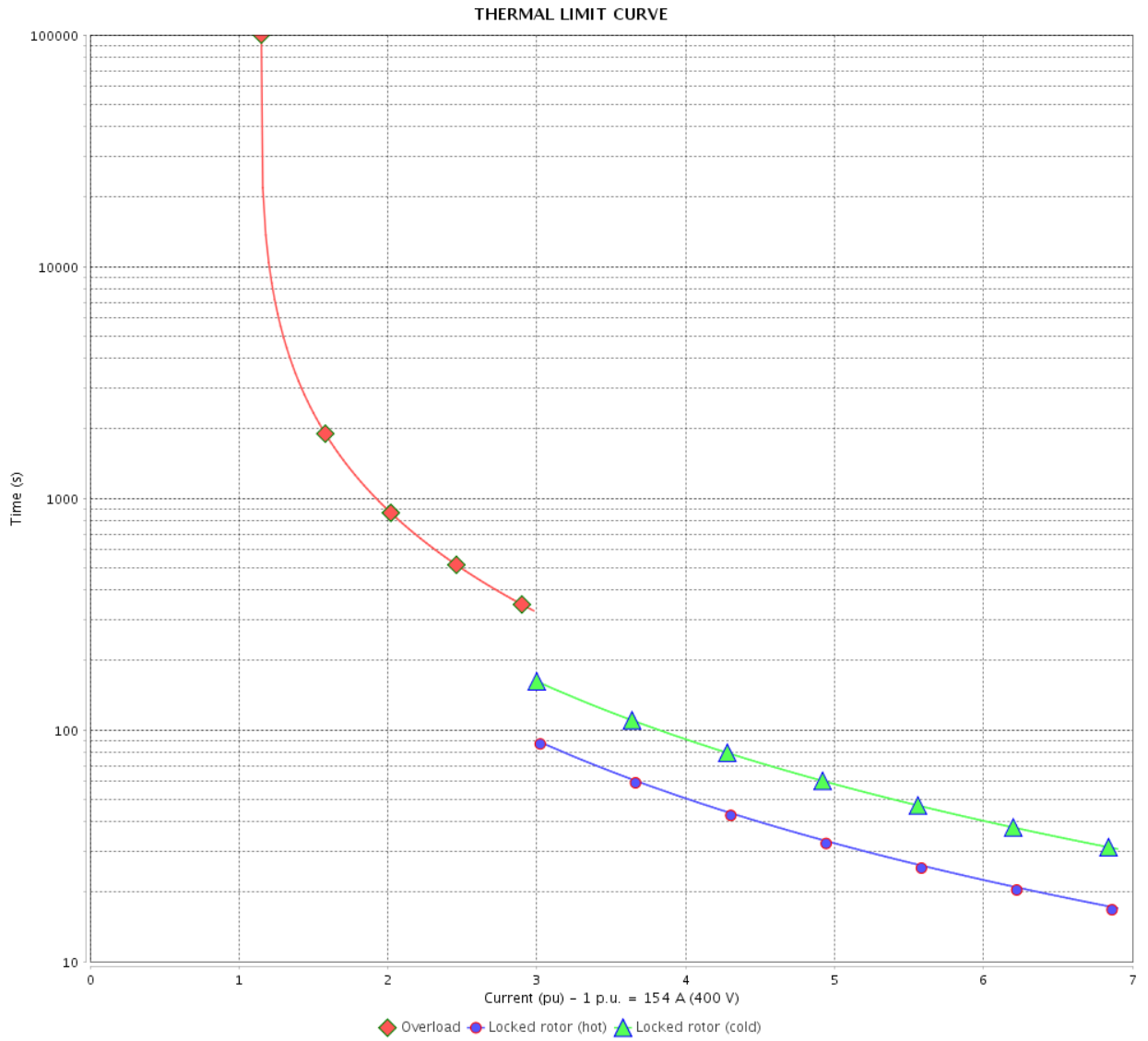

Rev.	Changes Summary	Performed	Checked	Date
Performed by		Page		Revision
Checked by		21 / 36		
Date		13/04/2022		

# THERMAL LIMIT CURVE



## Three Phase Induction Motor - Squirrel Cage

Customer :

Product line : NEMA Premium Efficiency Three-Phase  
Product code : 11356111  
Catalog # : 15036ET3G445TS-W22

Performance : 415 V 50 Hz 2P IE3

Rated current	: 148 A	Moment of inertia (J)	: 39.1 sq.ft.lb
LRC	: 7.3	Duty cycle	: Cont.(S1)
Rated torque	: 221 ft.lb	Insulation class	: F
Locked rotor torque	: 200 %	Service factor	: 1.00
Breakdown torque	: 280 %	Temperature rise	: 80 K
Rated speed	: 2970 rpm	Design	: B

Heating constant

Cooling constant

Rev.	Changes Summary	Performed	Checked	Date
Performed by				
Checked by			Page	Revision
Date	13/04/2022		22 / 36	

# THERMAL LIMIT CURVE

Three Phase Induction Motor - Squirrel Cage



Customer : \_\_\_\_\_

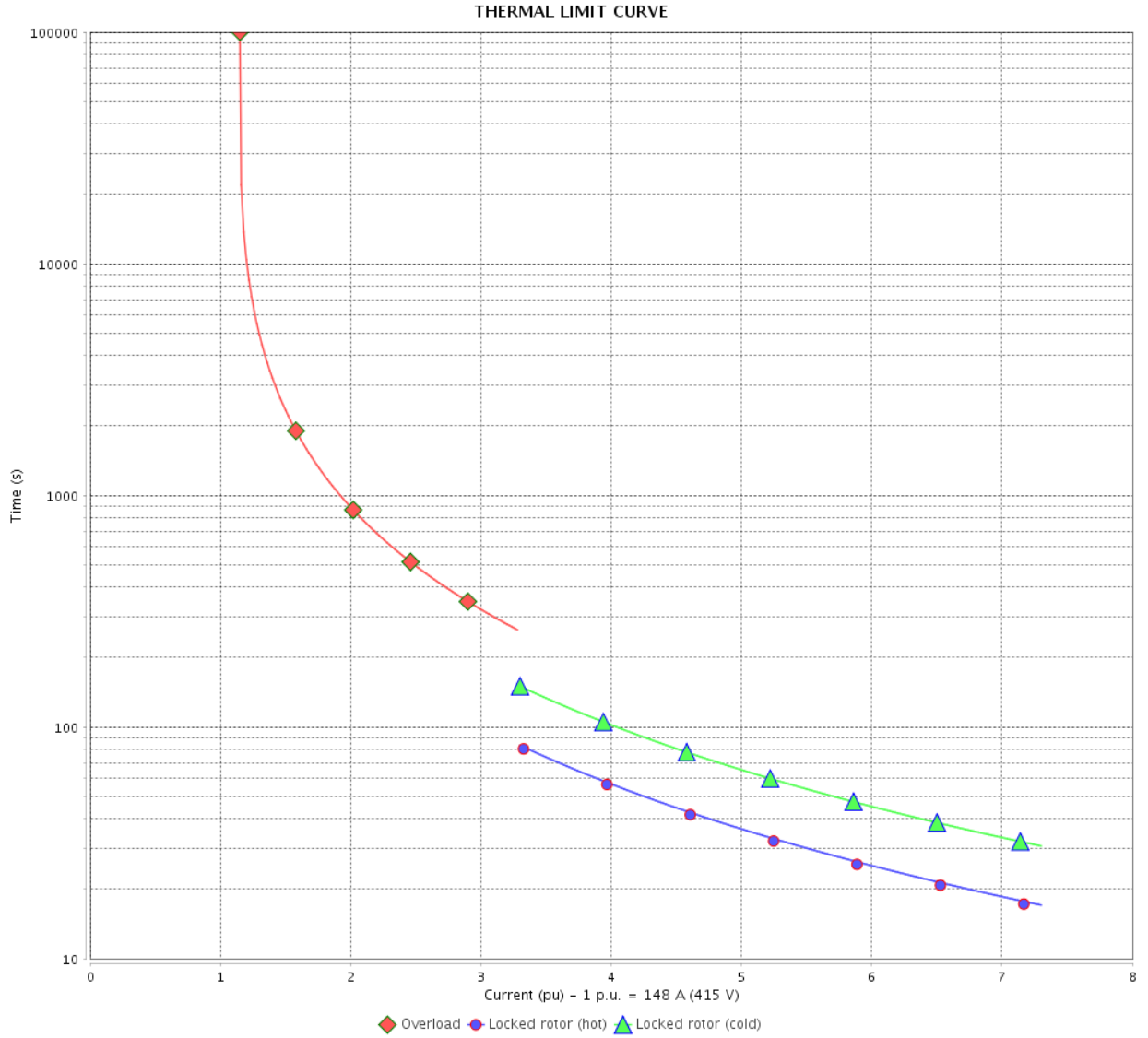

Rev.	Changes Summary	Performed	Checked	Date
Performed by		Page 23 / 36		Revision
Checked by				
Date				

# THERMAL LIMIT CURVE



## Three Phase Induction Motor - Squirrel Cage

Customer :

Product line : NEMA Premium Efficiency Three-Phase  
 Product code : 11356111  
 Catalog # : 15036ET3G445TS-W22

Performance : 380 V 50 Hz 2P IE1

Rated current : 200 A	Moment of inertia (J) : 39.1 sq.ft.lb
LRC : 5.1	Duty cycle : Cont.(S1)
Rated torque : 266 ft.lb	Insulation class : F
Locked rotor torque : 140 %	Service factor : 1.00
Breakdown torque : 190 %	Temperature rise : 105 K
Rated speed : 2960 rpm	Design : B

Heating constant

Cooling constant

Rev.	Changes Summary	Performed	Checked	Date
Performed by			Page 24 / 36	Revision
Checked by				
Date	13/04/2022			



# THERMAL LIMIT CURVE

Three Phase Induction Motor - Squirrel Cage



Customer : \_\_\_\_\_

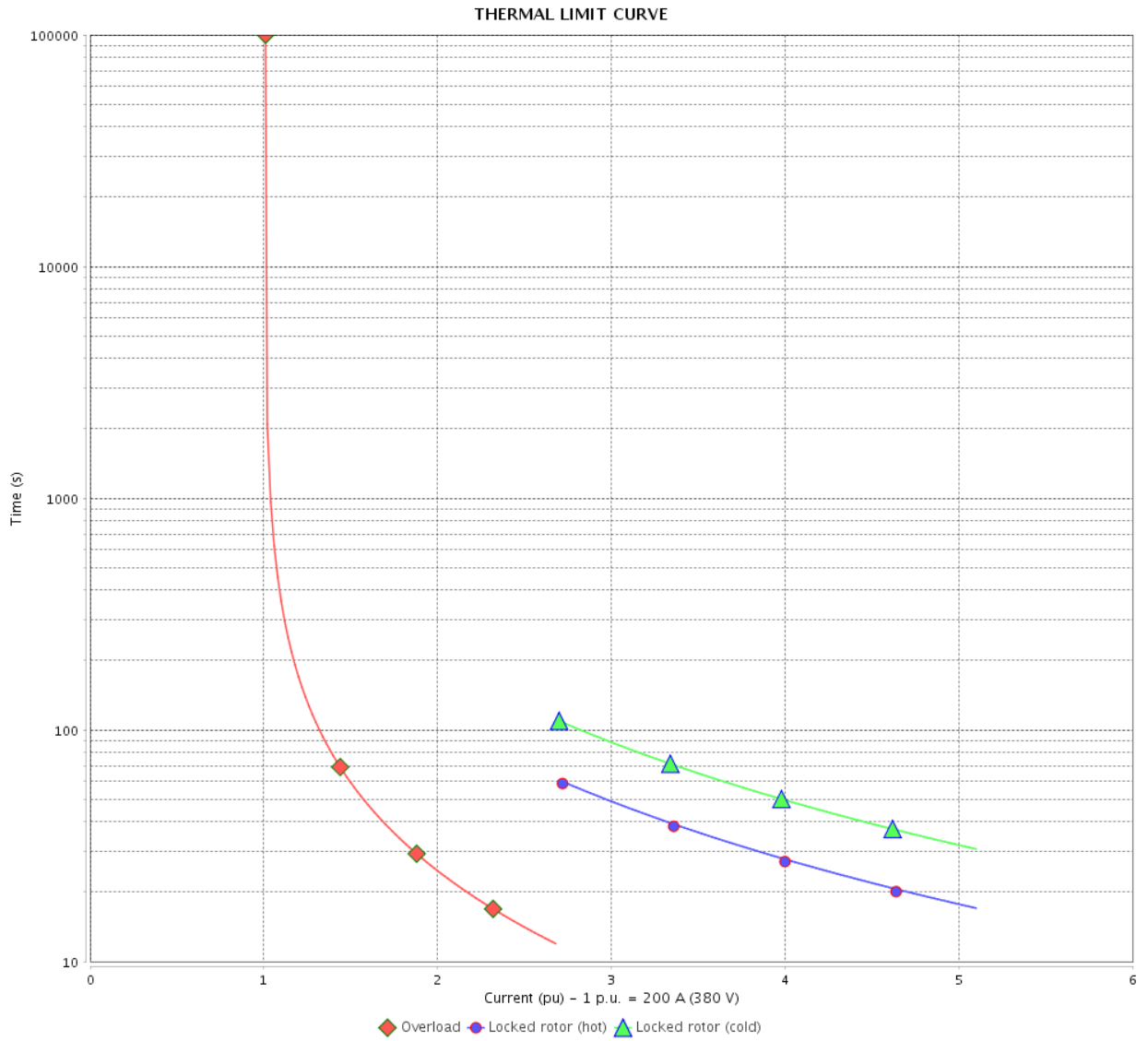

Rev.	Changes Summary	Performed	Checked	Date
Performed by				
Checked by				
Date				
			Page	Revision
			25 / 36	

# THERMAL LIMIT CURVE



## Three Phase Induction Motor - Squirrel Cage

Customer :

Product line : NEMA Premium Efficiency Three-Phase  
Product code : 11356111  
Catalog # : 15036ET3G445TS-W22

Performance : 400 V 50 Hz 2P IE2

Rated current	: 189 A	Moment of inertia (J)	: 39.1 sq.ft.lb
LRC	: 5.7	Duty cycle	: Cont.(S1)
Rated torque	: 266 ft.lb	Insulation class	: F
Locked rotor torque	: 160 %	Service factor	: 1.00
Breakdown torque	: 210 %	Temperature rise	: 105 K
Rated speed	: 2965 rpm	Design	: B

Heating constant

Cooling constant

Rev.	Changes Summary	Performed	Checked	Date
Performed by				
Checked by			Page	Revision
Date	13/04/2022		26 / 36	

# THERMAL LIMIT CURVE

Three Phase Induction Motor - Squirrel Cage



Customer : \_\_\_\_\_

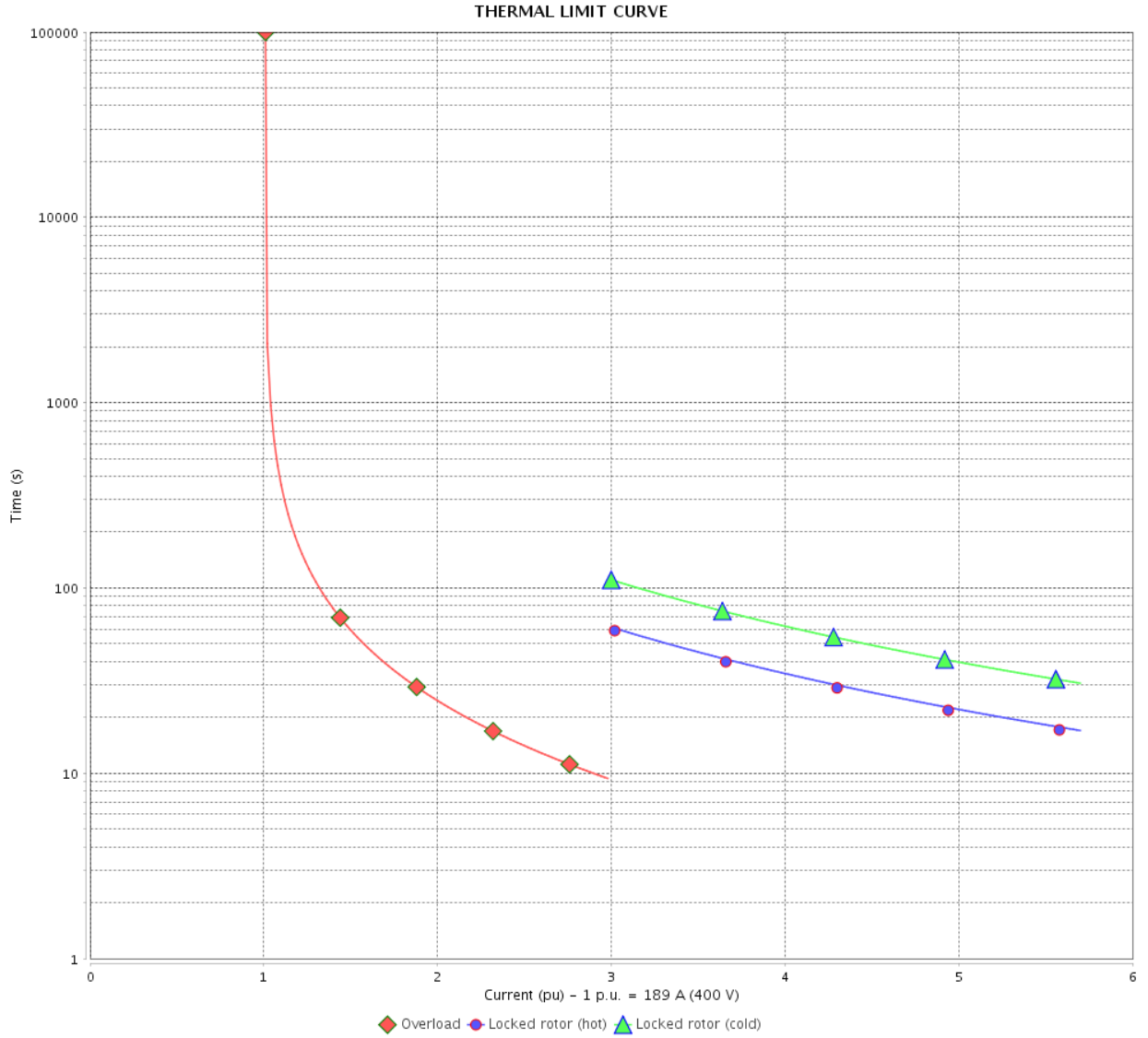

Rev.	Changes Summary	Performed	Checked	Date
Performed by		Page 27 / 36 Revision		
Checked by				
Date				

# THERMAL LIMIT CURVE

## Three Phase Induction Motor - Squirrel Cage



Customer :

Product line : NEMA Premium Efficiency Three-Phase  
Product code : 11356111  
Catalog # : 15036ET3G445TS-W22

Performance : 415 V 50 Hz 2P IE2

Rated current	: 182 A	Moment of inertia (J)	: 39.1 sq.ft.lb
LRC	: 6.1	Duty cycle	: Cont.(S1)
Rated torque	: 266 ft.lb	Insulation class	: F
Locked rotor torque	: 170 %	Service factor	: 1.00
Breakdown torque	: 229 %	Temperature rise	: 80 K
Rated speed	: 2965 rpm	Design	: B

Heating constant

Cooling constant

Rev.	Changes Summary	Performed	Checked	Date
Performed by				
Checked by			Page	Revision
Date	13/04/2022		28 / 36	

# THERMAL LIMIT CURVE

Three Phase Induction Motor - Squirrel Cage



Customer : \_\_\_\_\_

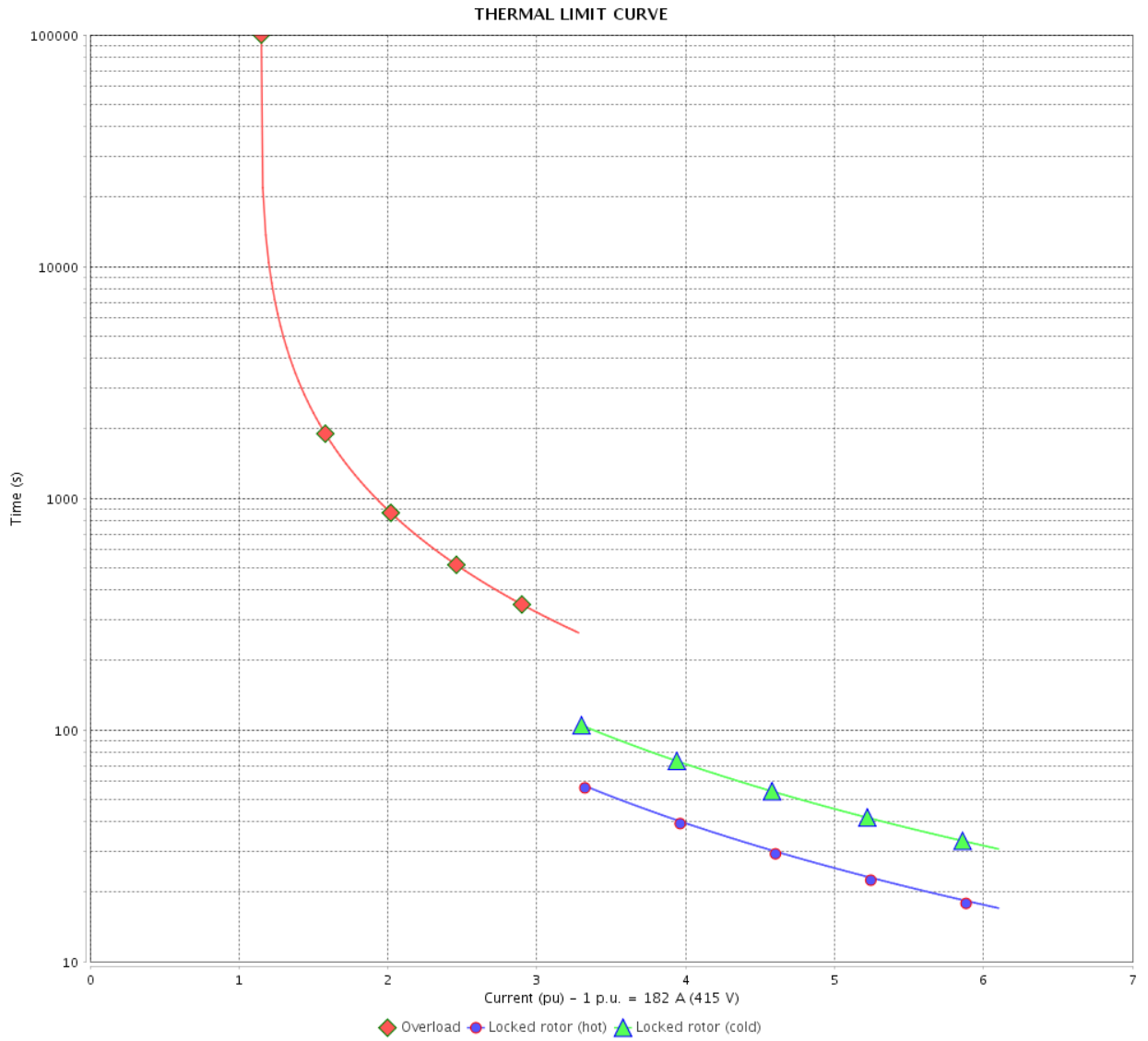

Rev.	Changes Summary	Performed	Checked	Date
Performed by		Page 29 / 36		Revision
Checked by				
Date				

# VFD OPERATION CURVE

Three Phase Induction Motor - Squirrel Cage



Customer :

Product line : NEMA Premium Efficiency Three-Phase

Product code : 11356111

Catalog # : 15036ET3G445TS-W22

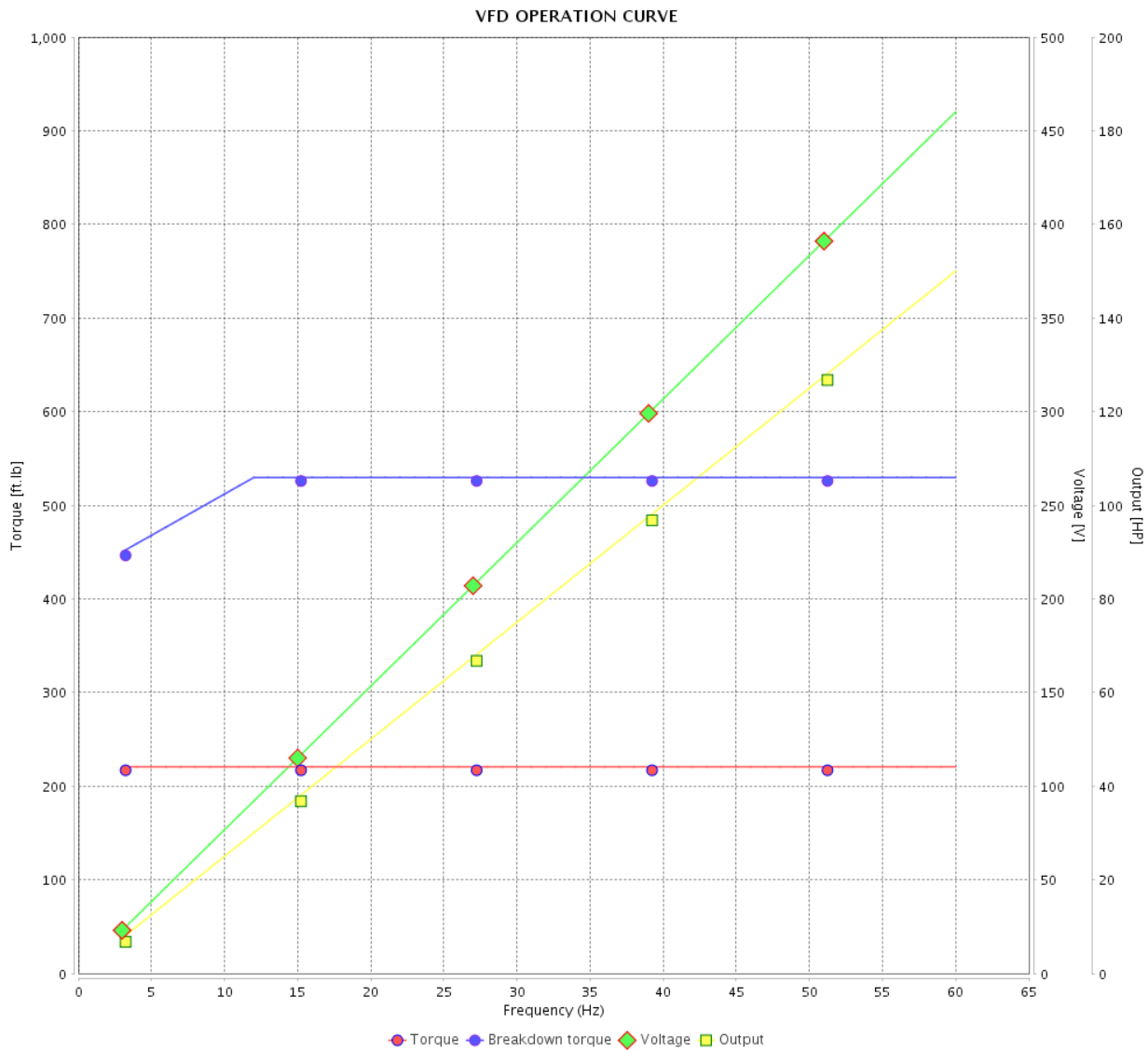

Performance : 460 V 60 Hz 2P

Rated current : 163 A  
 LRC : 6.5  
 Rated torque : 221 ft.lb  
 Locked rotor torque : 180 %  
 Breakdown torque : 240 %  
 Rated speed : 3570 rpm

Moment of inertia (J) : 39.1 sq.ft.lb  
 Duty cycle : Cont.(S1)  
 Insulation class : F  
 Service factor : 1.15  
 Temperature rise : 80 K  
 Design : B

Rev.	Changes Summary	Performed	Checked	Date
Performed by			Page	Revision
Checked by				
Date				
		30 / 36		

# VFD OPERATION CURVE

## Three Phase Induction Motor - Squirrel Cage



Customer :

Product line : NEMA Premium Efficiency Three-Phase  
 Product code : 11356111  
 Catalog # : 15036ET3G445TS-W22

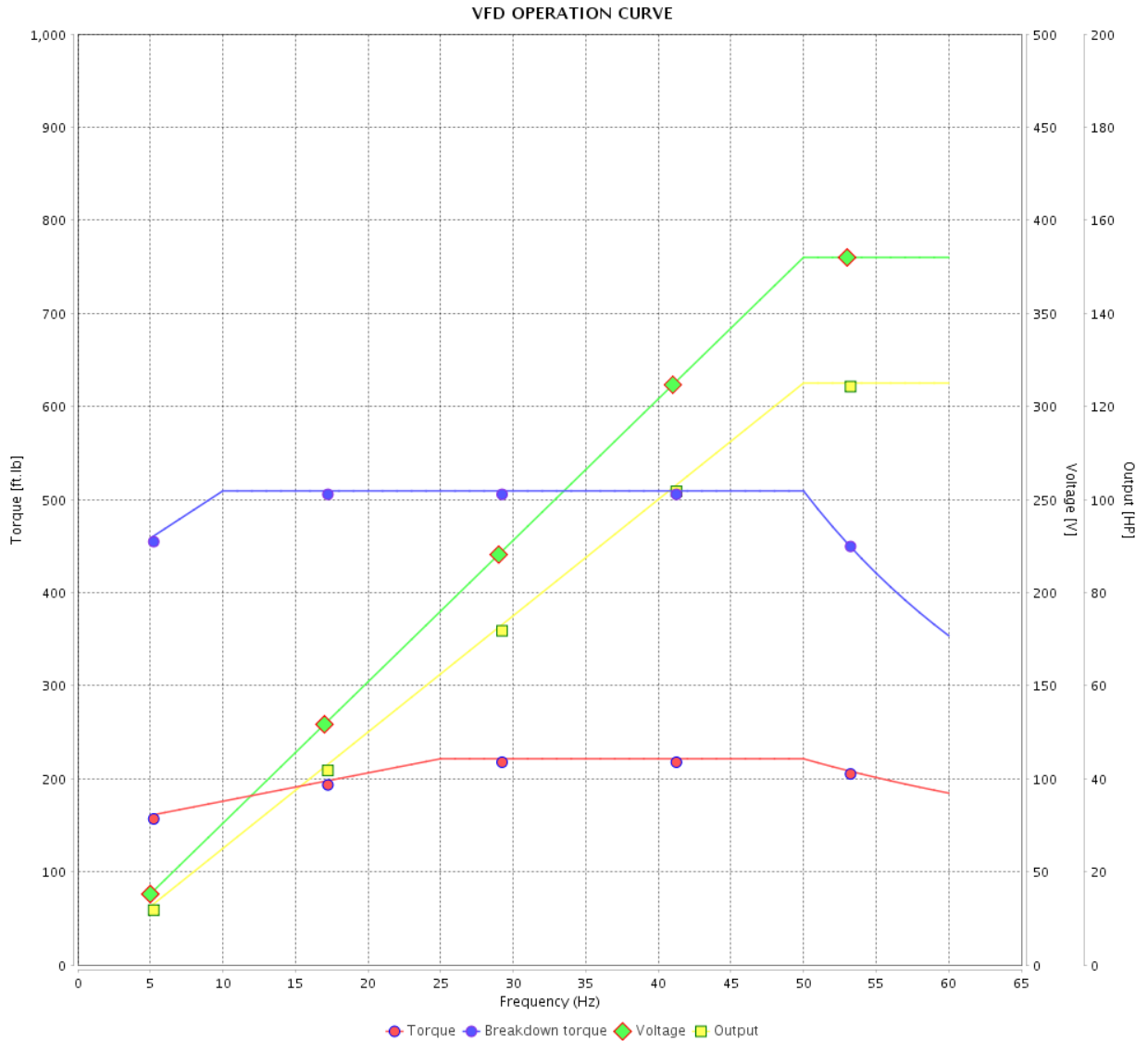

Performance : 380 V 50 Hz 2P IE3

Rated current	: 162 A	Moment of inertia (J)	: 39.1 sq.ft.lb
LRC	: 6.1	Duty cycle	: Cont.(S1)
Rated torque	: 221 ft.lb	Insulation class	: F
Locked rotor torque	: 170 %	Service factor	: 1.00
Breakdown torque	: 229 %	Temperature rise	: 80 K
Rated speed	: 2965 rpm	Design	: B

Rev.	Changes Summary	Performed	Checked	Date
Performed by			Page 31 / 36	Revision
Checked by				
Date	13/04/2022			

# VFD OPERATION CURVE

Three Phase Induction Motor - Squirrel Cage



Customer :

Product line : NEMA Premium Efficiency Three-Phase

Product code : 11356111

Catalog # : 15036ET3G445TS-W22

VFD OPERATION CURVE

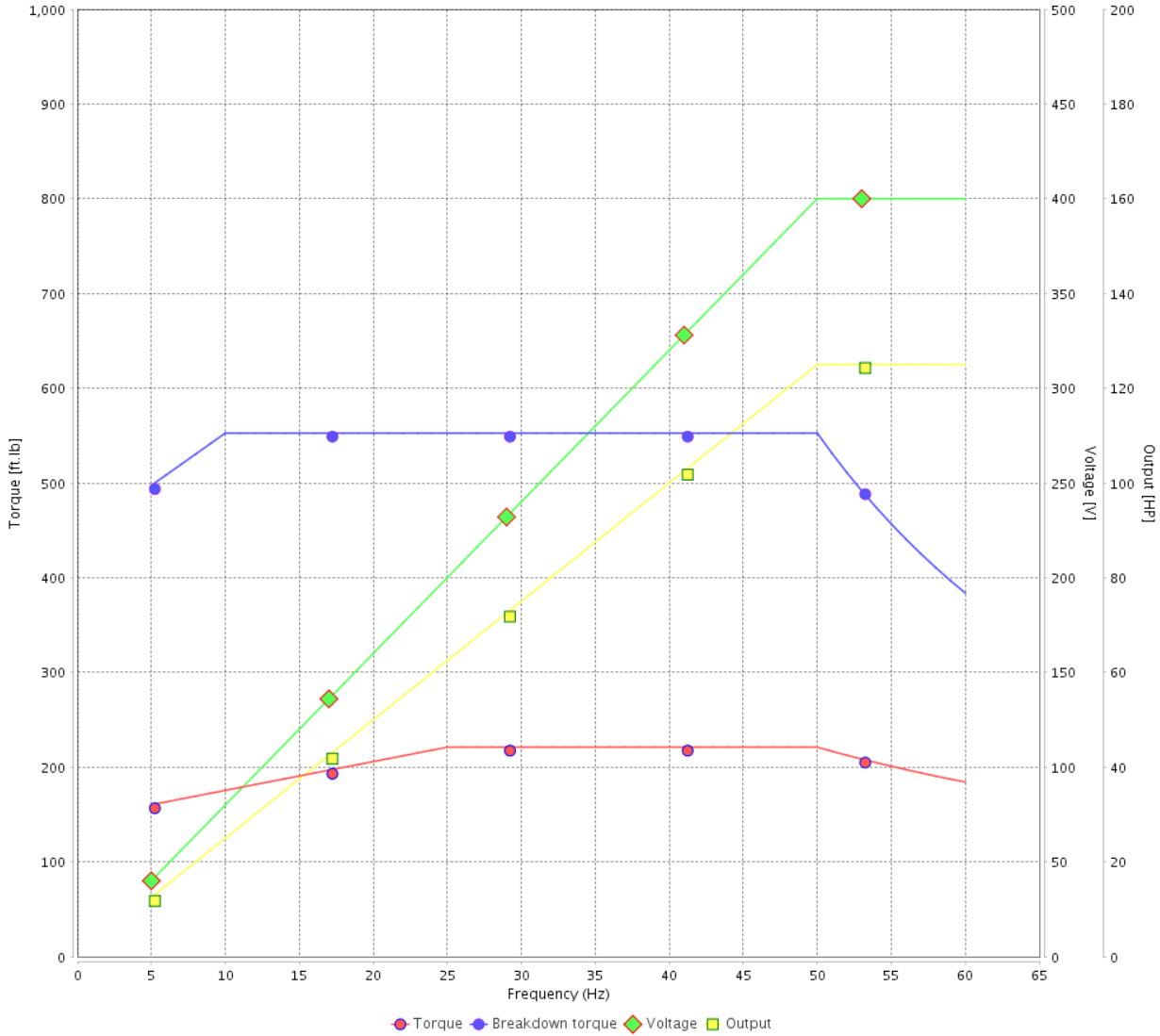

Performance : 400 V 50 Hz 2P IE3

Rated current : 154 A  
 LRC : 6.9  
 Rated torque : 221 ft.lb  
 Locked rotor torque : 190 %  
 Breakdown torque : 250 %  
 Rated speed : 2970 rpm

Moment of inertia (J) : 39.1 sq.ft.lb  
 Duty cycle : Cont.(S1)  
 Insulation class : F  
 Service factor : 1.00  
 Temperature rise : 80 K  
 Design : B

Rev.	Changes Summary	Performed	Checked	Date
Performed by			Page	Revision
Checked by				
Date				



# VFD OPERATION CURVE

## Three Phase Induction Motor - Squirrel Cage



Customer :

Product line : NEMA Premium Efficiency Three-Phase

Product code : 11356111

Catalog # : 15036ET3G445TS-W22

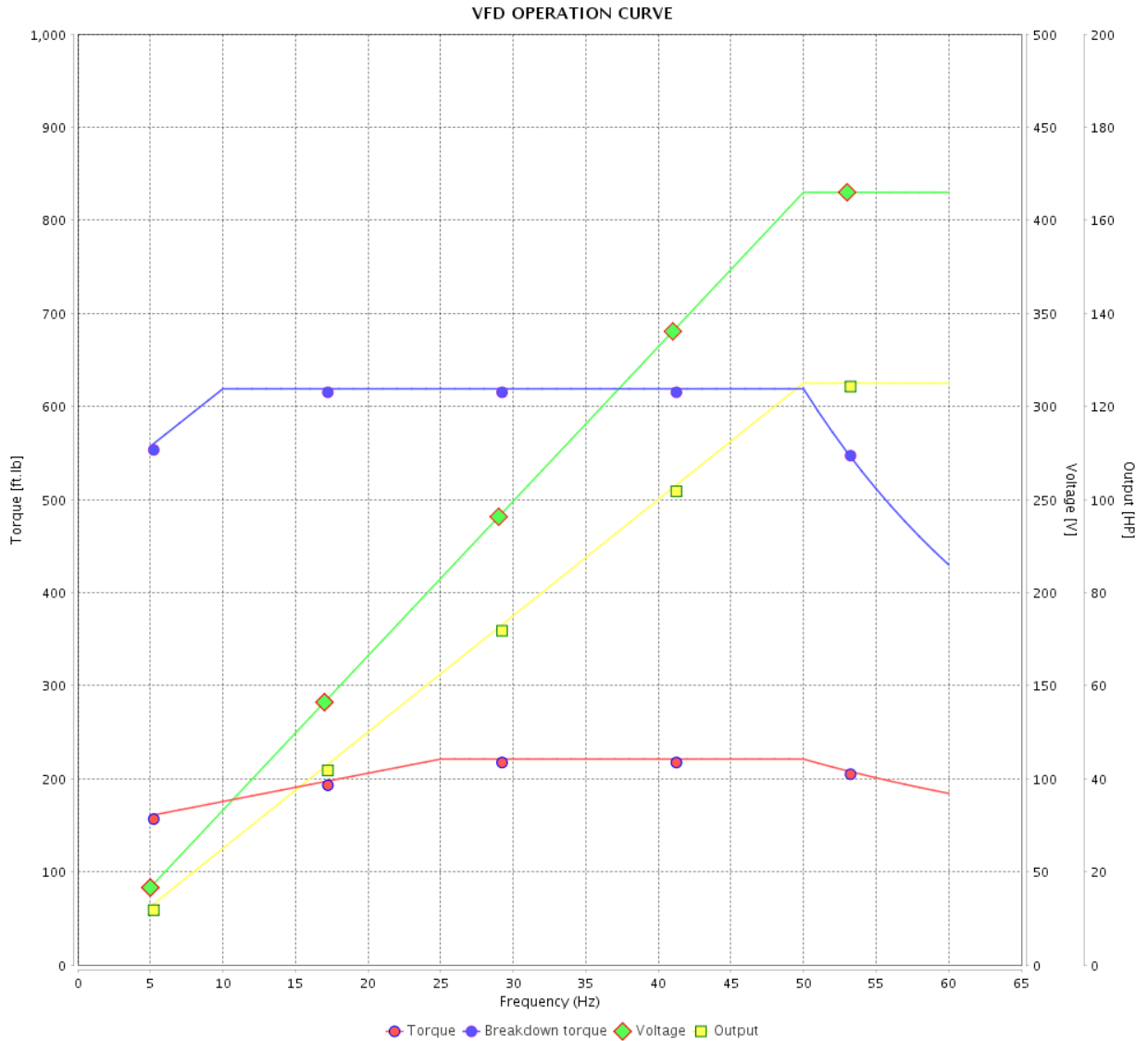

Performance : 415 V 50 Hz 2P IE3

Rated current : 148 A  
 LRC : 7.3  
 Rated torque : 221 ft.lb  
 Locked rotor torque : 200 %  
 Breakdown torque : 280 %  
 Rated speed : 2970 rpm

Moment of inertia (J) : 39.1 sq.ft.lb  
 Duty cycle : Cont.(S1)  
 Insulation class : F  
 Service factor : 1.00  
 Temperature rise : 80 K  
 Design : B

Rev.	Changes Summary	Performed	Checked	Date
Performed by			Page 33 / 36	Revision
Checked by				
Date	13/04/2022			

# VFD OPERATION CURVE

Three Phase Induction Motor - Squirrel Cage



Customer :

Product line : NEMA Premium Efficiency Three-Phase

Product code : 11356111

Catalog # : 15036ET3G445TS-W22

VFD OPERATION CURVE

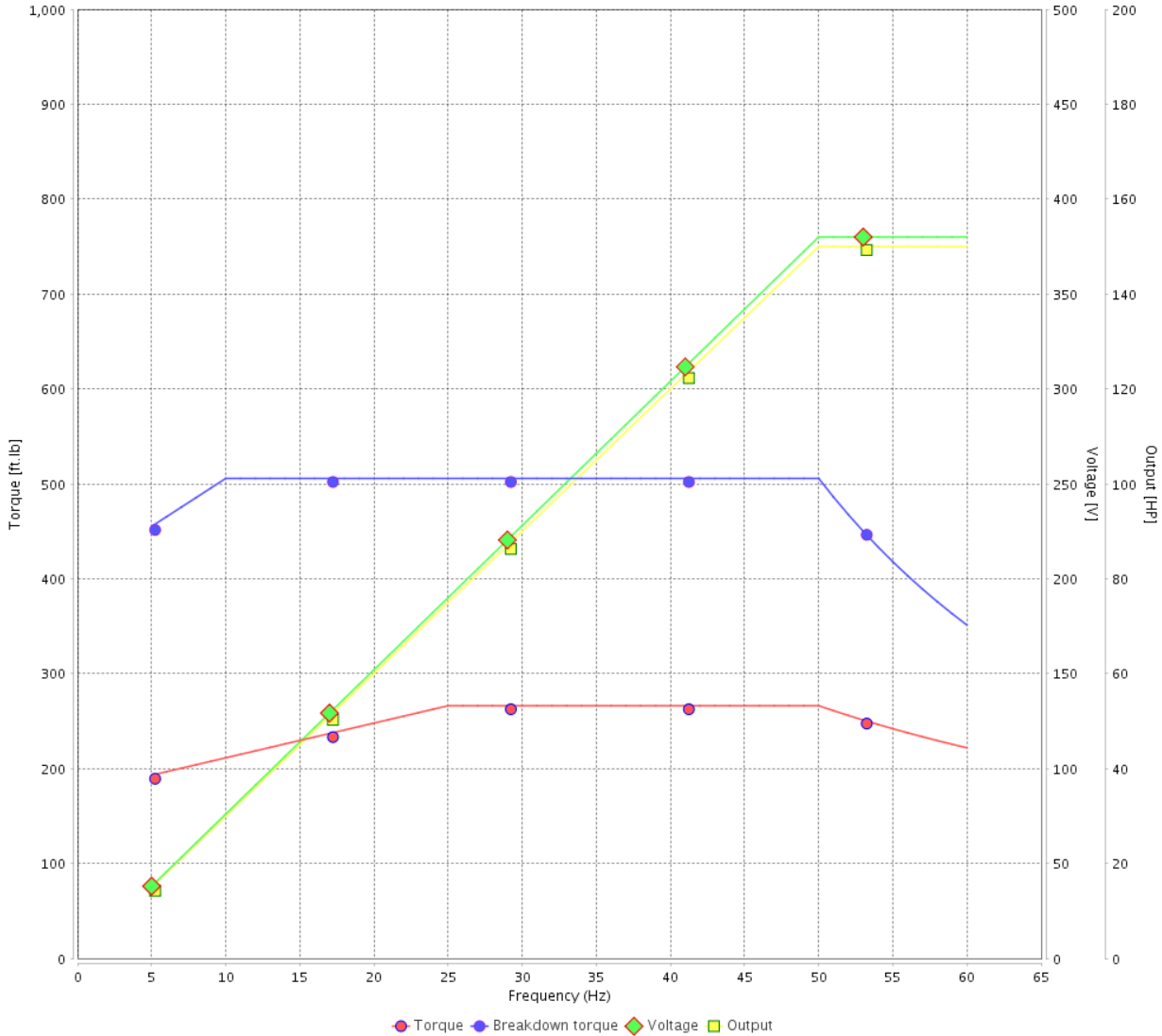

Performance : 380 V 50 Hz 2P IE1

Rated current	: 200 A	Moment of inertia (J)	: 39.1 sq.ft.lb
LRC	: 5.1	Duty cycle	: Cont.(S1)
Rated torque	: 266 ft.lb	Insulation class	: F
Locked rotor torque	: 140 %	Service factor	: 1.00
Breakdown torque	: 190 %	Temperature rise	: 105 K
Rated speed	: 2960 rpm	Design	: B

Rev.	Changes Summary	Performed	Checked	Date
Performed by			Page 34 / 36	Revision
Checked by				
Date	13/04/2022			

# VFD OPERATION CURVE

## Three Phase Induction Motor - Squirrel Cage



Customer :

Product line : NEMA Premium Efficiency Three-Phase

Product code : 11356111

Catalog # : 15036ET3G445TS-W22

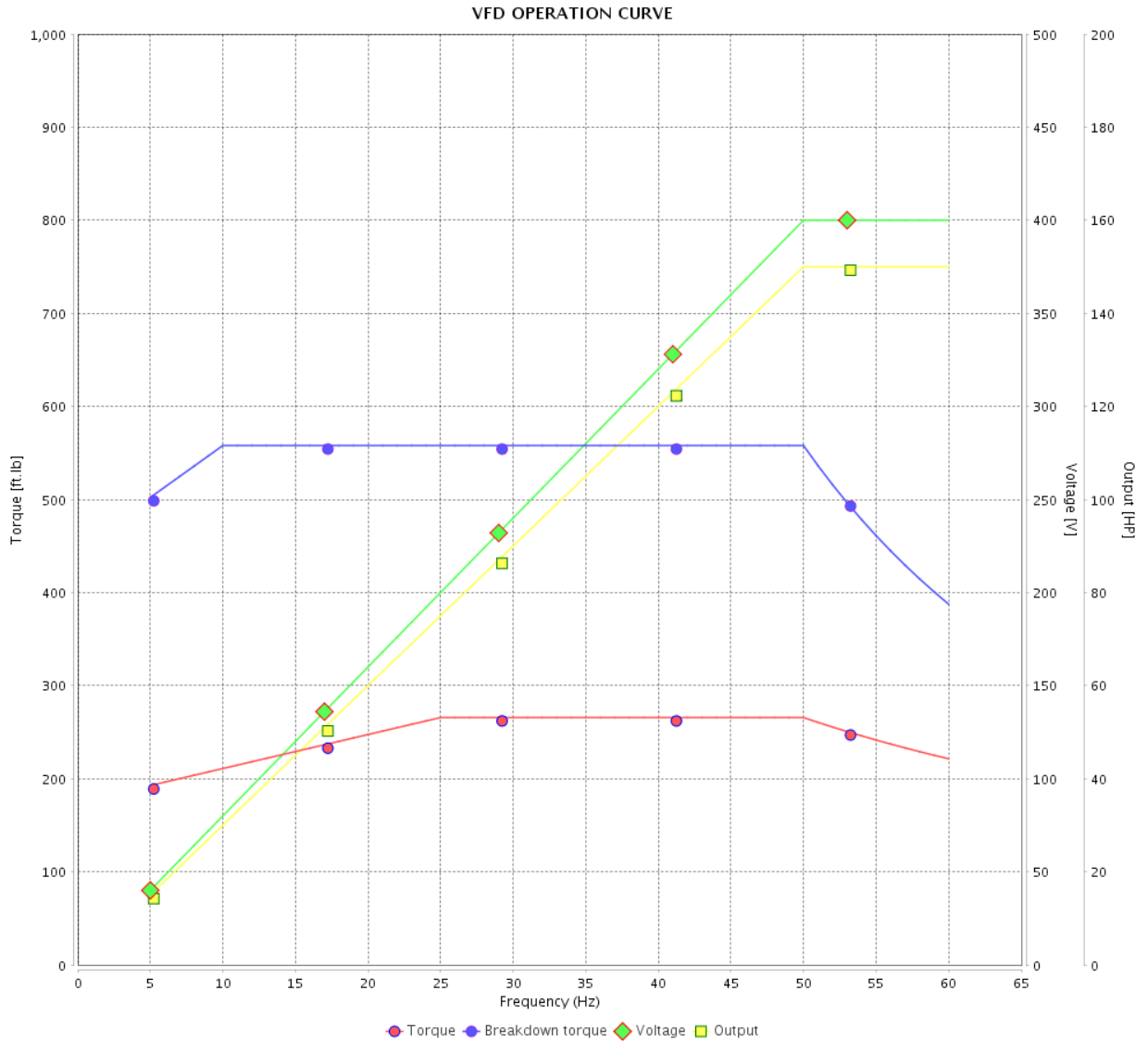

Performance : 400 V 50 Hz 2P IE2

Rated current : 189 A  
 LRC : 5.7  
 Rated torque : 266 ft.lb  
 Locked rotor torque : 160 %  
 Breakdown torque : 210 %  
 Rated speed : 2965 rpm

Moment of inertia (J) : 39.1 sq.ft.lb  
 Duty cycle : Cont.(S1)  
 Insulation class : F  
 Service factor : 1.00  
 Temperature rise : 105 K  
 Design : B

Rev.	Changes Summary	Performed	Checked	Date
Performed by			Page 35 / 36	Revision
Checked by				
Date	13/04/2022			

# VFD OPERATION CURVE

Three Phase Induction Motor - Squirrel Cage



Customer : \_\_\_\_\_

Product line : NEMA Premium Efficiency Three-Phase

Product code : 11356111

Catalog # : 15036ET3G445TS-W22

VFD OPERATION CURVE

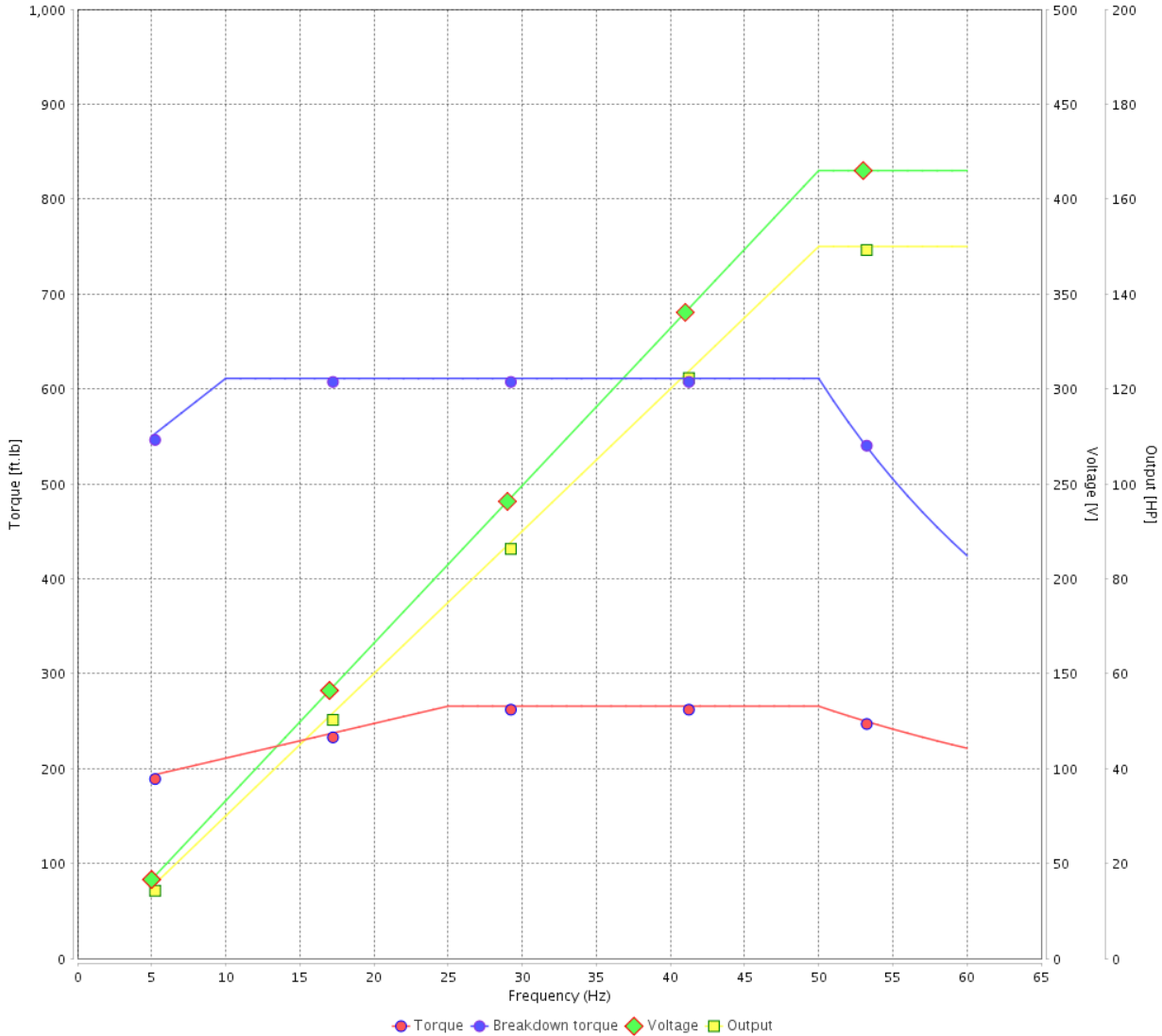

Performance : 415 V 50 Hz 2P IE2

Rated current : 182 A  
 LRC : 6.1  
 Rated torque : 266 ft.lb  
 Locked rotor torque : 170 %  
 Breakdown torque : 229 %  
 Rated speed : 2965 rpm

Moment of inertia (J) : 39.1 sq.ft.lb  
 Duty cycle : Cont.(S1)  
 Insulation class : F  
 Service factor : 1.00  
 Temperature rise : 80 K  
 Design : B

Rev.	Changes Summary	Performed	Checked	Date
Performed by			Page 36 / 36	Revision
Checked by				
Date	13/04/2022			

1 2 3 4 5 6

A

B

C

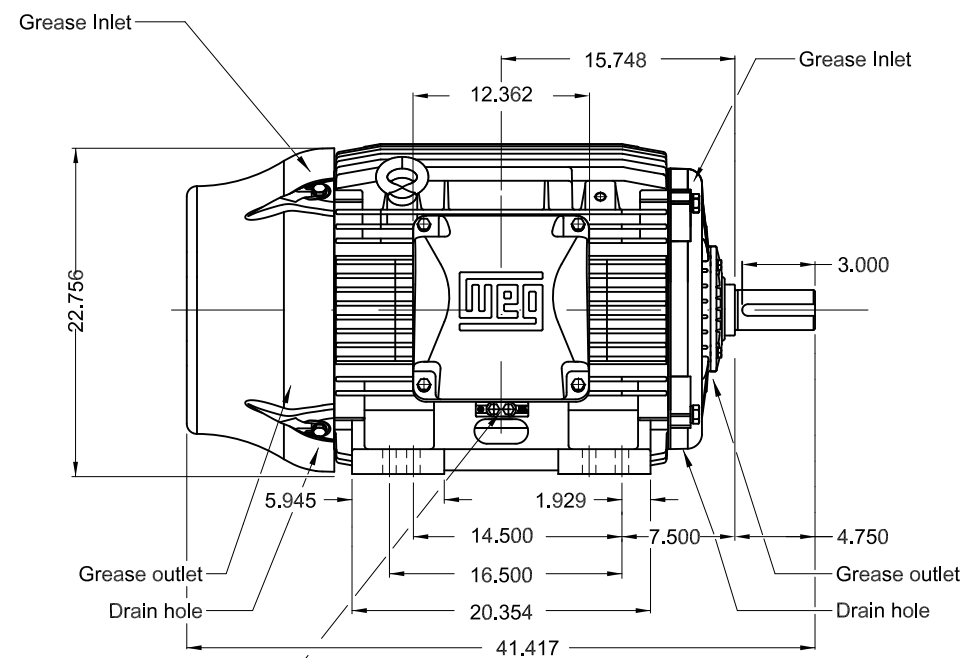
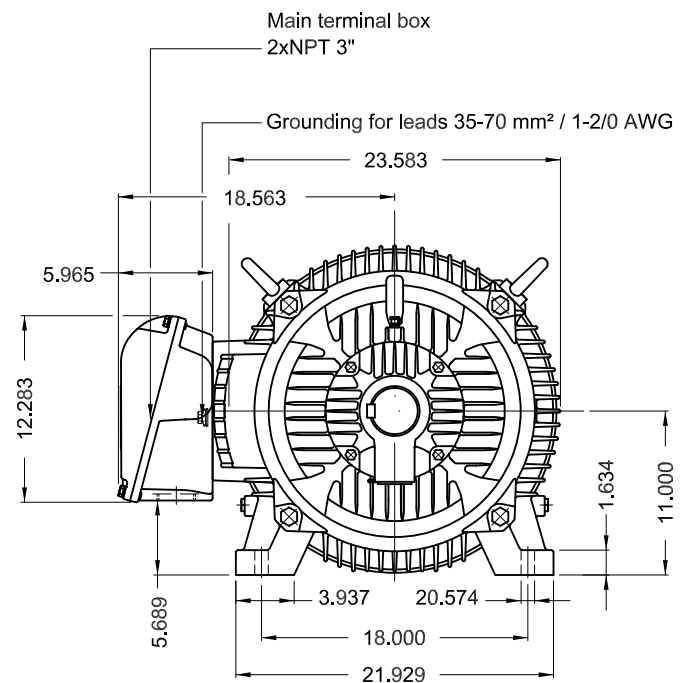

Grounding for leads 25-185 mm² / 3AWG-350MCM

D

E

150 HP 02 Poles 60 Hz A

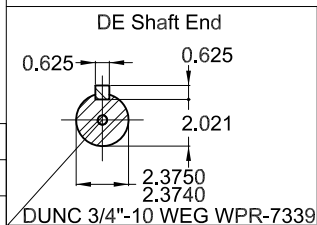

Color RAL 5009  
Painting plan 203A  
Mounting B3R(D)

ECM	LOC	SUMMARY OF MODIFICATIONS	EXECUTED	CHECKED	RELEASED	DATE	VER
EXECUTED	PIRWUSER	THREE PH. MOTOR W22 PREM. EFF.					
CHECKED		FRAME 444/5TS IP55 TEFC					
RELEASED							
REL DT.	WMO	Jaragua do Sul	Product Engineering	SHEET	1 / 1		

PREVIEW  
WDD



MADE IN MEXICO

11356111



**NEMA**  
Premium  
W22



FOR SAFE AREA  
Mod.TE1BFOXON  
CC029A



Class I, Div 2, Gr A, B, C and D - T3  
Class I, Zone 2, IIC - T3  
Class II, Div 2, Gr F and G - T3C  
For use on PWM: Gr. A, B, C, D and F,  
VT 1000:1, CT 20:1, 1.00SF - T3A

MODEL 15036ET3G445TS-W22

Inverter Duty Motor  
Severe Duty

PH3 60Hz Fr. 444/5TS 1000m.a.s.l. IP55 TEFC 1749lb

V 460

A 163

HP 150

kW 110

SF 1.15

SFA 187

RPM 3570

PF 0.89

AMB 40°C

INS cl. F DT80K

NEMA NOM EFF 95.0%

DUTY CONT.

DES B Code G

PART-WINDING



WYE-DELTA



→ 6314-C3 (27g)

→ 6314-C3 (27g)



MOBIL POLYREX EM (4000h)

