

DATA SHEET

Three Phase Induction Motor - Squirrel Cage



Customer					
Product line		: W40 NEMA Premium Efficiency Three-Phase		Product code : 14272544	
				Catalog # : 15036OT3G405TSC-W40	
Frame		: 404/5TSC		Cooling method : IC01 - ODP	
Insulation class		: F		Mounting : F-1	
Duty cycle		: Cont.(S1)		Rotation ¹ : Both (CW and CCW)	
Ambient temperature		: -20°C to +40°C		Starting method : Direct On Line	
Altitude		: 1000 m.a.s.l.		Approx. weight ² : 905 lb	
Protection degree		: IP23		Moment of inertia (J) : 8.80 sq.ft.lb	
Design		: B			
Output [HP]	150	100	100	100	100
Poles	2	2	2	2	2
Frequency [Hz]	60	50	50	50	50
Rated voltage [V]	460	380	400	415	415
Rated current [A]	167	137	133	133	133
L. R. Amperes [A]	1102	986	1051	1117	1117
LRC [A]	6.6x(Code G)	7.2x(Code H)	7.9x(Code J)	8.4x(Code K)	8.4x(Code K)
No load current [A]	40.0	43.8	43.7	48.9	48.9
Rated speed [RPM]	3552	2960	2965	2965	2965
Slip [%]	1.33	1.33	1.17	1.17	1.17
Rated torque [ft.lb]	222	177	177	177	177
Locked rotor torque [%]	200	229	250	270	270
Breakdown torque [%]	250	290	330	360	360
Service factor	1.25	1.00	1.00	1.00	1.00
Temperature rise	80 K	80 K	80 K	80 K	80 K
Locked rotor time	16s (cold) 9s (hot)	21s (cold) 12s (hot)	19s (cold) 11s (hot)	18s (cold) 10s (hot)	18s (cold) 10s (hot)
Noise level ²	84.0 dB(A)				
Efficiency (%)	25%	93.5	93.3	92.6	91.8
	50%	93.6	93.7	93.2	92.7
	75%	94.1	94.4	94.2	93.9
	100%	94.1	94.7	94.7	94.7
Power Factor	25%	0.58	0.51	0.47	0.43
	50%	0.79	0.76	0.70	0.65
	75%	0.86	0.85	0.81	0.77
	100%	0.88	0.88	0.86	0.83
Bearing type	: Drive end : 6314 C3	: Non drive end : 6212 Z C3	Foundation loads		
Sealing	: Without	: Without	Max. traction : 1459 lb		
	: Bearing Seal	: Bearing Seal	Max. compression : 2364 lb		
Lubrication interval	: 14418 h	: 20000 h			
Lubricant amount	: 27 g	: 13 g			
Lubricant type	: Mobil Polyrex EM				
Notes					
This revision replaces and cancel the previous one, which must be eliminated. (1) Looking the motor from the shaft end. (2) Measured at 1m and with tolerance of +3dB(A). (3) Approximate weight subject to changes after manufacturing process. (4) At 100% of full load.			These are average values based on tests with sinusoidal power supply, subject to the tolerances stipulated in NEMA MG-1.		
Rev.	Changes Summary		Performed	Checked	Date
Performed by					
Checked by				Page	Revision
Date	13/04/2022			1 / 21	

TORQUE AND CURRENT VS SPEED CURVE

Three Phase Induction Motor - Squirrel Cage



Customer :

Product line : W40 NEMA Premium Efficiency
Three-Phase

Product code : 14272544

Catalog # : 150360T3G405TSC-W40

TORQUE AND CURRENT VS SPEED CURVE

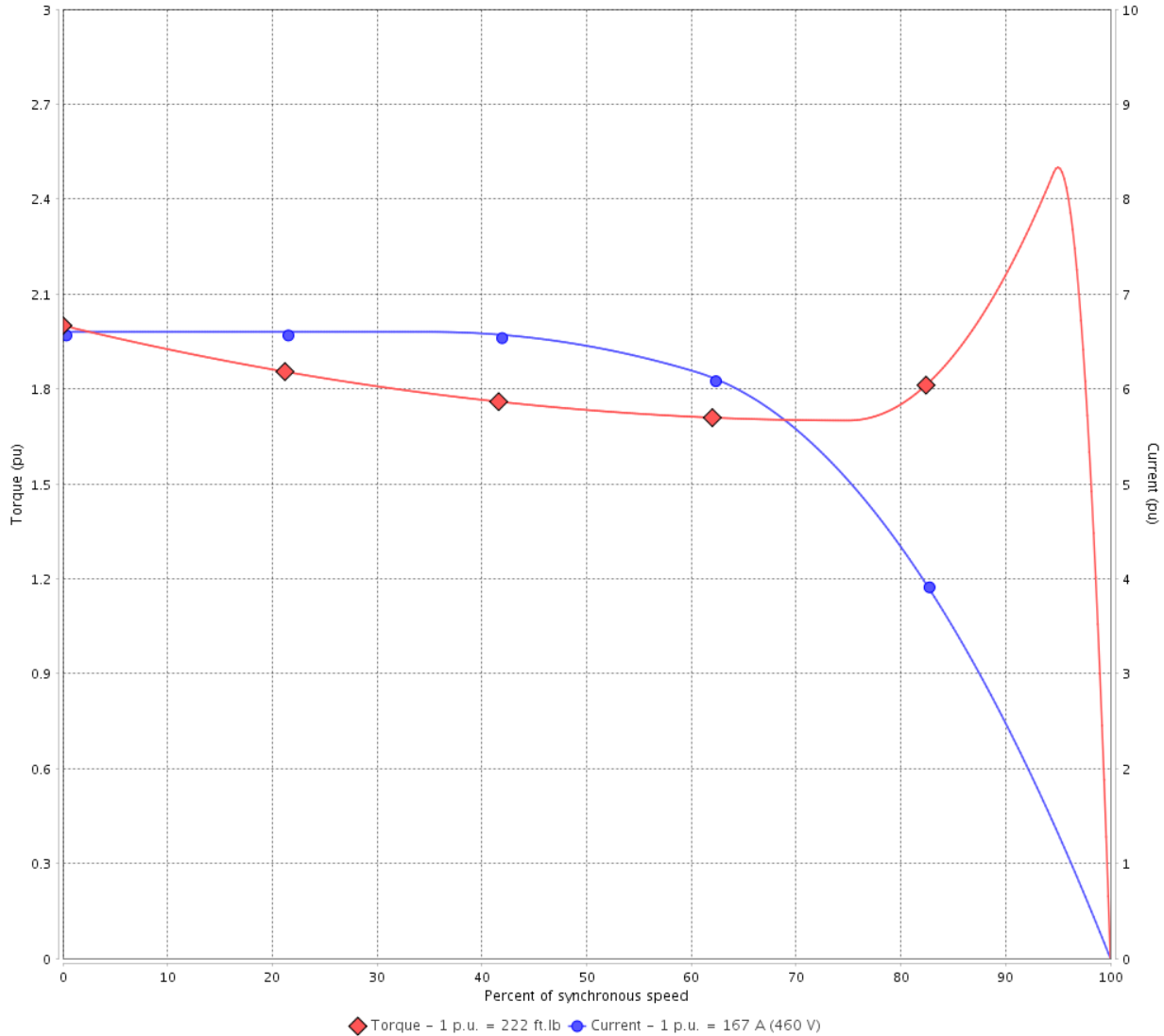

Performance : 460 V 60 Hz 2P

Rated current	: 167 A	Moment of inertia (J)	: 8.80 sq.ft.lb
LRC	: 6.6	Duty cycle	: Cont.(S1)
Rated torque	: 222 ft.lb	Insulation class	: F
Locked rotor torque	: 200 %	Service factor	: 1.25
Breakdown torque	: 250 %	Temperature rise	: 80 K
Rated speed	: 3552 rpm	Design	: B

Locked rotor time : 16s (cold) 9s (hot)

Rev.	Changes Summary	Performed	Checked	Date
Performed by			Page 2 / 21	Revision
Checked by				
Date	13/04/2022			

TORQUE AND CURRENT VS SPEED CURVE



Three Phase Induction Motor - Squirrel Cage

Customer :

Product line : W40 NEMA Premium Efficiency
Three-Phase

Product code : 14272544

Catalog # : 15036OT3G405TSC-W40

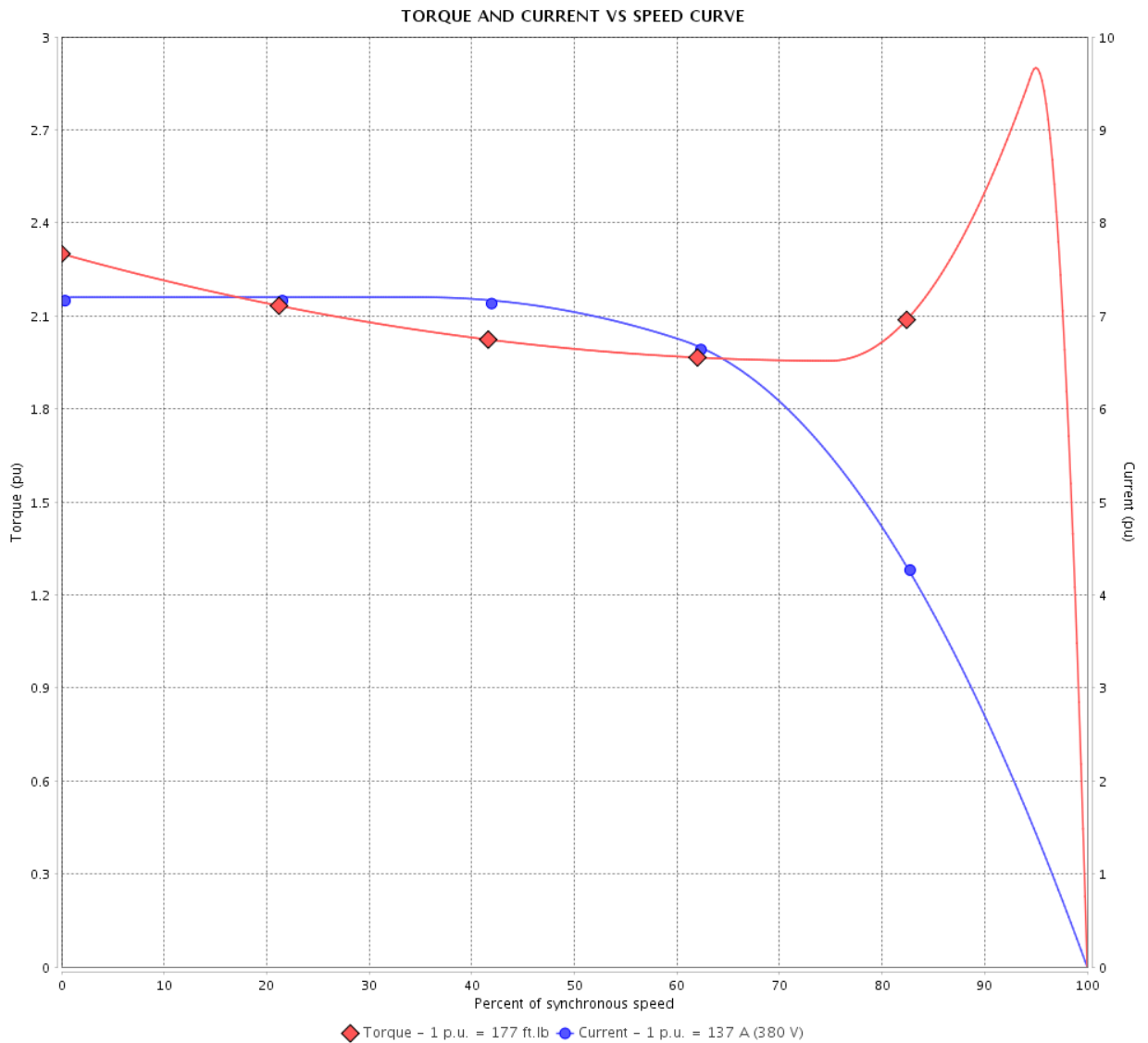

Performance : 380 V 50 Hz 2P IE3

Rated current	: 137 A	Moment of inertia (J)	: 8.80 sq.ft.lb
LRC	: 7.2	Duty cycle	: Cont.(S1)
Rated torque	: 177 ft.lb	Insulation class	: F
Locked rotor torque	: 229 %	Service factor	: 1.00
Breakdown torque	: 290 %	Temperature rise	: 80 K
Rated speed	: 2960 rpm	Design	: B

Locked rotor time : 21s (cold) 12s (hot)

Rev.	Changes Summary	Performed	Checked	Date
Performed by			Page 3 / 21	Revision
Checked by				
Date	13/04/2022			

TORQUE AND CURRENT VS SPEED CURVE

Three Phase Induction Motor - Squirrel Cage



Customer :

Product line : W40 NEMA Premium Efficiency
Three-Phase

Product code : 14272544

Catalog # : 15036OT3G405TSC-W40

TORQUE AND CURRENT VS SPEED CURVE

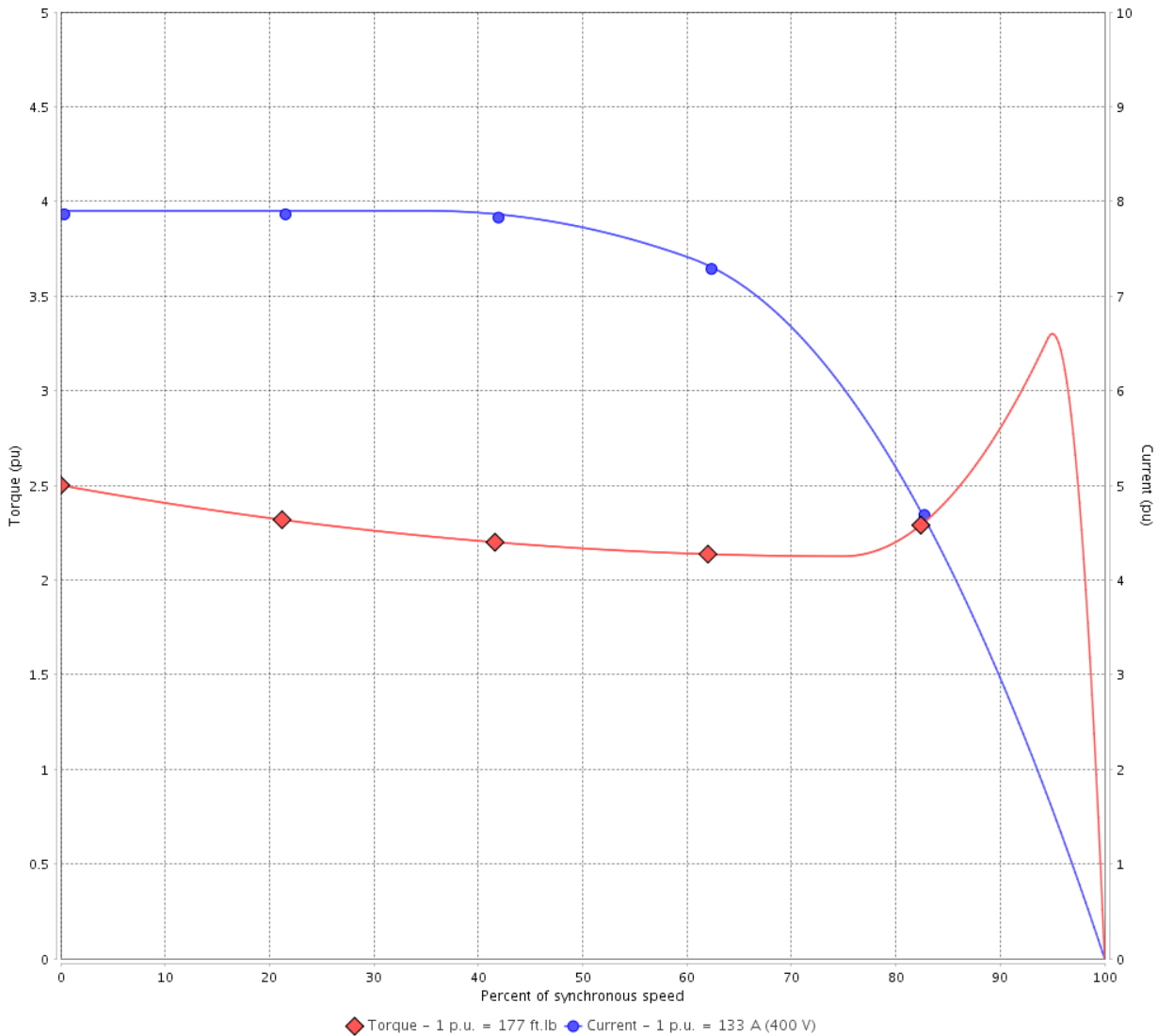

Performance : 400 V 50 Hz 2P IE3

Rated current	: 133 A	Moment of inertia (J)	: 8.80 sq.ft.lb
LRC	: 7.9	Duty cycle	: Cont.(S1)
Rated torque	: 177 ft.lb	Insulation class	: F
Locked rotor torque	: 250 %	Service factor	: 1.00
Breakdown torque	: 330 %	Temperature rise	: 80 K
Rated speed	: 2965 rpm	Design	: B

Locked rotor time : 19s (cold) 11s (hot)

Rev.	Changes Summary	Performed	Checked	Date
Performed by			Page 4 / 21	Revision
Checked by				
Date	13/04/2022			

TORQUE AND CURRENT VS SPEED CURVE



Three Phase Induction Motor - Squirrel Cage

Customer :

Product line : W40 NEMA Premium Efficiency
Three-Phase

Product code : 14272544

Catalog # : 15036OT3G405TSC-W40

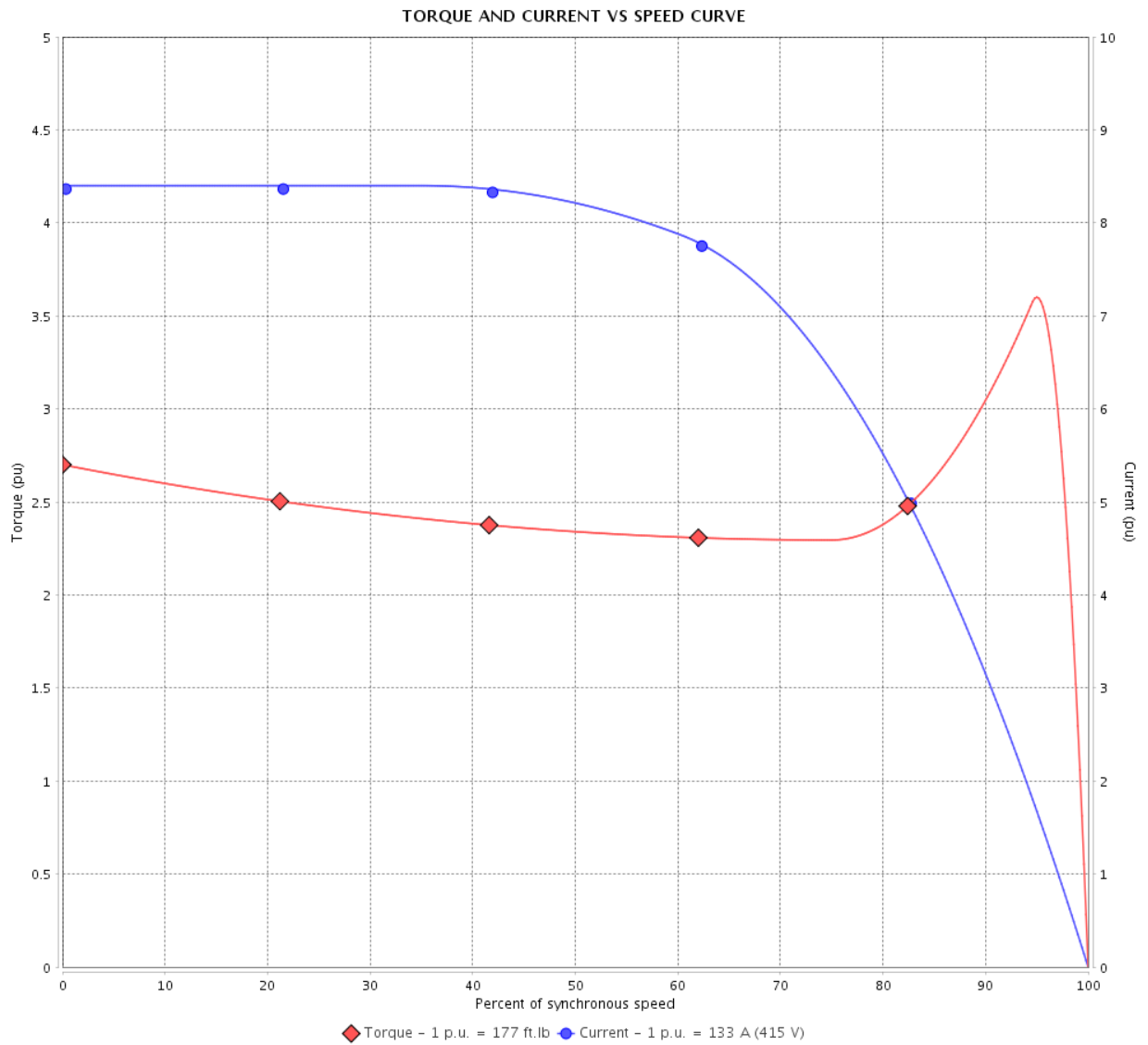

Performance : 415 V 50 Hz 2P IE3

Rated current	: 133 A	Moment of inertia (J)	: 8.80 sq.ft.lb
LRC	: 8.4	Duty cycle	: Cont.(S1)
Rated torque	: 177 ft.lb	Insulation class	: F
Locked rotor torque	: 270 %	Service factor	: 1.00
Breakdown torque	: 360 %	Temperature rise	: 80 K
Rated speed	: 2965 rpm	Design	: B

Locked rotor time : 18s (cold) 10s (hot)

Rev.	Changes Summary	Performed	Checked	Date
Performed by			Page 5 / 21	Revision
Checked by				
Date	13/04/2022			

LOAD PERFORMANCE CURVE

Three Phase Induction Motor - Squirrel Cage



Customer : _____

Product line : W40 NEMA Premium Efficiency
Three-Phase

Product code : 14272544

Catalog # : 15036OT3G405TSC-W40

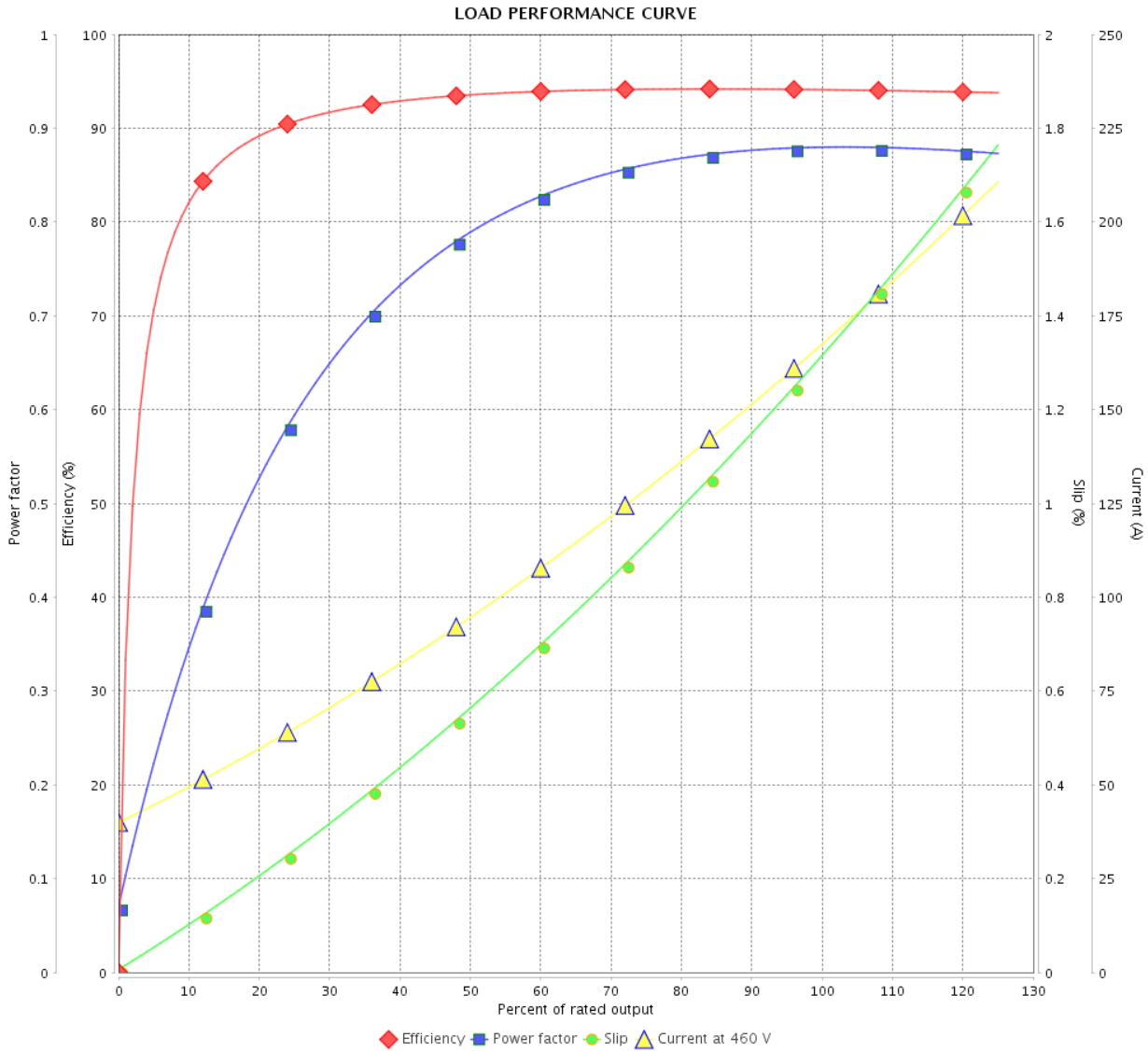

Performance : 460 V 60 Hz 2P

Rated current : 167 A
 LRC : 6.6
 Rated torque : 222 ft.lb
 Locked rotor torque : 200 %
 Breakdown torque : 250 %
 Rated speed : 3552 rpm

Moment of inertia (J) : 8.80 sq.ft.lb
 Duty cycle : Cont.(S1)
 Insulation class : F
 Service factor : 1.25
 Temperature rise : 80 K
 Design : B

Rev.	Changes Summary	Performed	Checked	Date
Performed by			Page 6 / 21	Revision
Checked by				
Date	13/04/2022			

LOAD PERFORMANCE CURVE

Three Phase Induction Motor - Squirrel Cage



Customer :

Product line : W40 NEMA Premium Efficiency Three-Phase

Product code : 14272544

Catalog # : 15036OT3G405TSC-W40

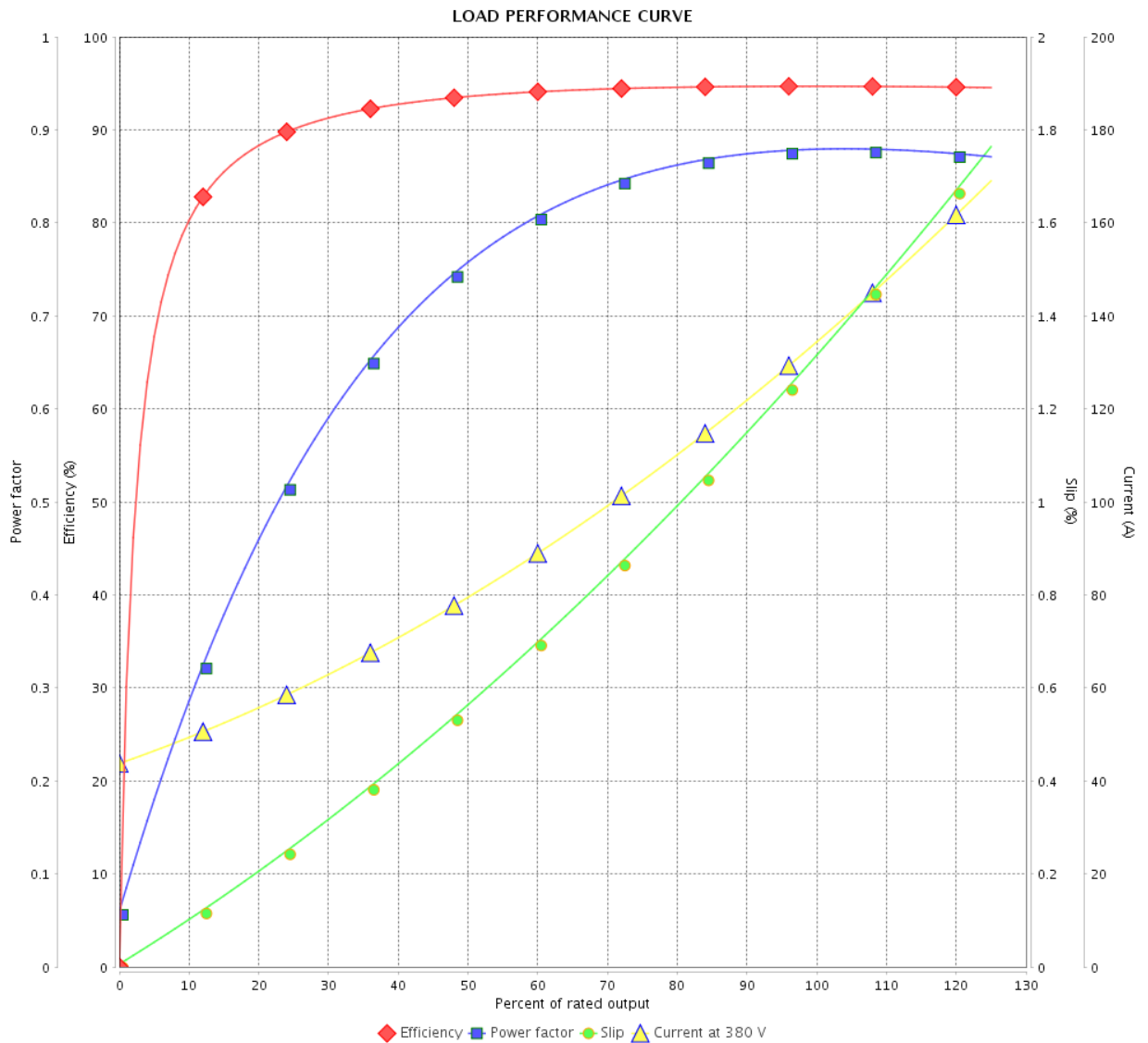

Performance : 380 V 50 Hz 2P IE3

Rated current : 137 A
 LRC : 7.2
 Rated torque : 177 ft.lb
 Locked rotor torque : 229 %
 Breakdown torque : 290 %
 Rated speed : 2960 rpm

Moment of inertia (J) : 8.80 sq.ft.lb
 Duty cycle : Cont.(S1)
 Insulation class : F
 Service factor : 1.00
 Temperature rise : 80 K
 Design : B

Rev.	Changes Summary	Performed	Checked	Date
Performed by				
Checked by				
Date				
		Page	Revision	
		7 / 21		

LOAD PERFORMANCE CURVE

Three Phase Induction Motor - Squirrel Cage



Customer :

Product line : W40 NEMA Premium Efficiency
Three-Phase

Product code : 14272544

Catalog # : 15036OT3G405TSC-W40

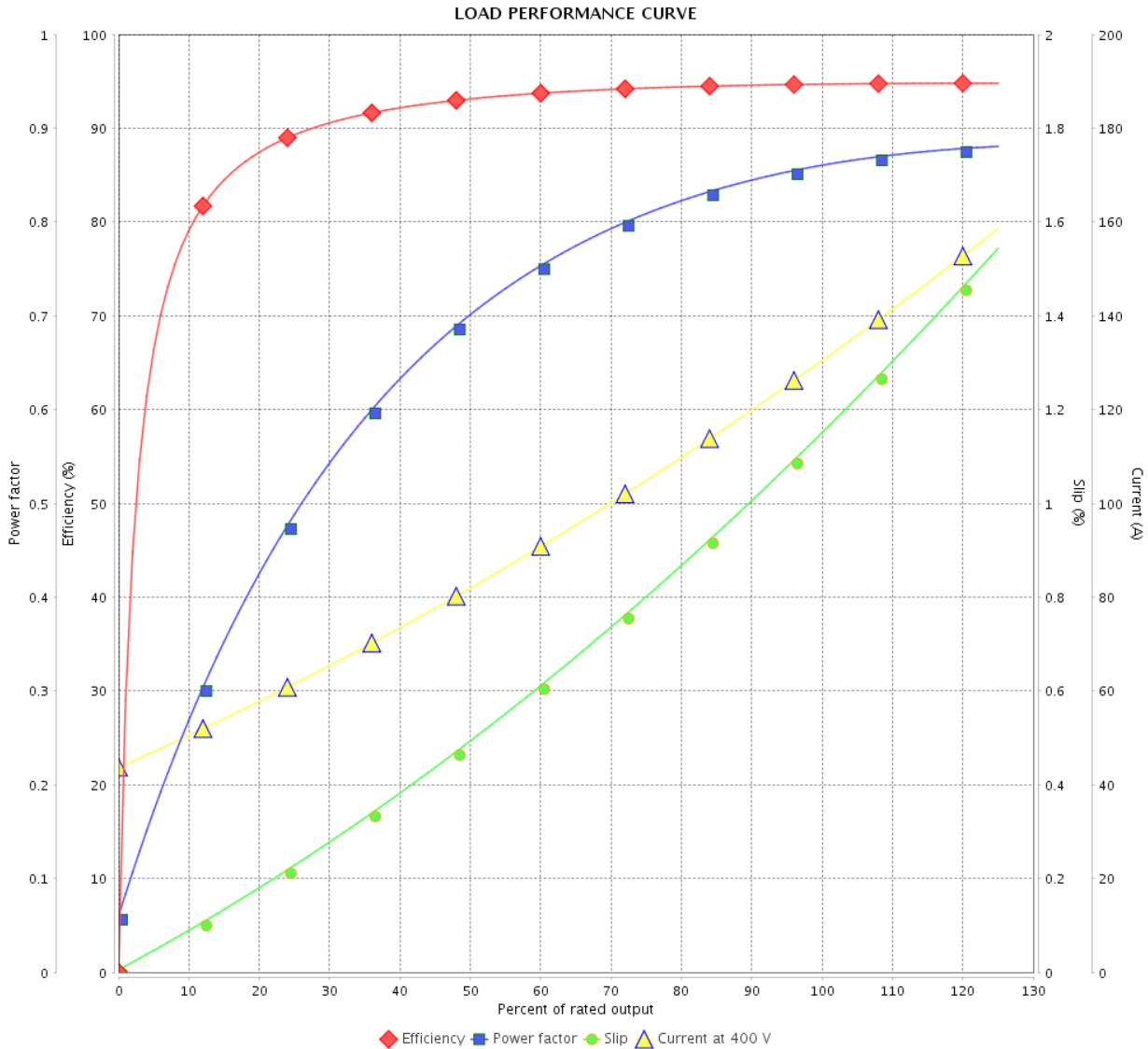

Performance : 400 V 50 Hz 2P IE3

Rated current	: 133 A	Moment of inertia (J)	: 8.80 sq.ft.lb
LRC	: 7.9	Duty cycle	: Cont.(S1)
Rated torque	: 177 ft.lb	Insulation class	: F
Locked rotor torque	: 250 %	Service factor	: 1.00
Breakdown torque	: 330 %	Temperature rise	: 80 K
Rated speed	: 2965 rpm	Design	: B

Rev.	Changes Summary	Performed	Checked	Date
Performed by			Page	Revision
Checked by			8 / 21	
Date	13/04/2022			

LOAD PERFORMANCE CURVE

Three Phase Induction Motor - Squirrel Cage



Customer :

Product line : W40 NEMA Premium Efficiency Three-Phase

Product code : 14272544

Catalog # : 15036OT3G405TSC-W40

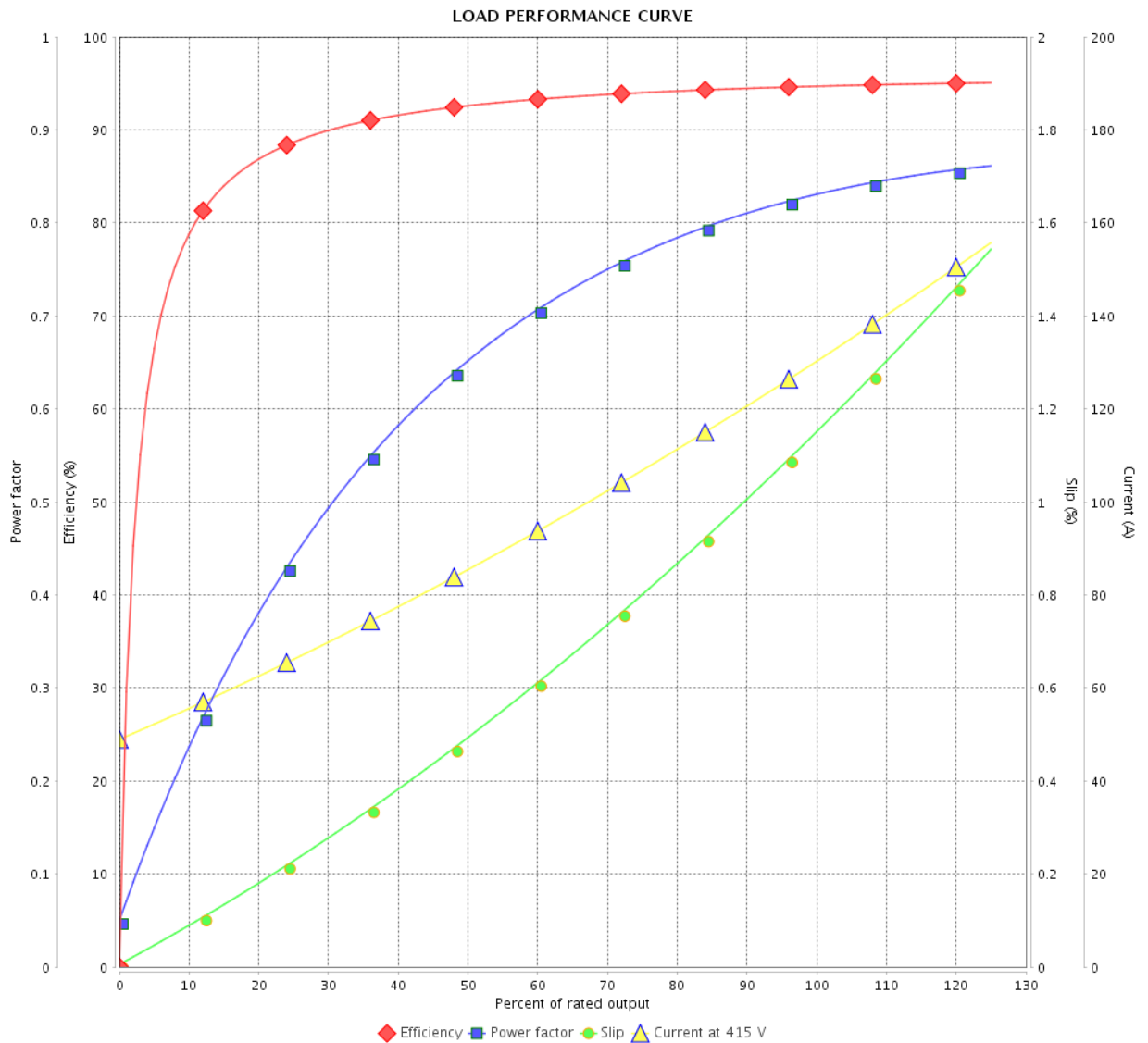

Performance : 415 V 50 Hz 2P IE3

Rated current : 133 A
 LRC : 8.4
 Rated torque : 177 ft.lb
 Locked rotor torque : 270 %
 Breakdown torque : 360 %
 Rated speed : 2965 rpm

Moment of inertia (J) : 8.80 sq.ft.lb
 Duty cycle : Cont.(S1)
 Insulation class : F
 Service factor : 1.00
 Temperature rise : 80 K
 Design : B

Rev.	Changes Summary	Performed	Checked	Date
Performed by			Page	Revision
Checked by				
Date				

THERMAL LIMIT CURVE



Three Phase Induction Motor - Squirrel Cage

Customer :

Product line : W40 NEMA Premium Efficiency
Three-Phase

Product code : 14272544

Catalog # : 15036OT3G405TSC-W40

Performance : 460 V 60 Hz 2P

Rated current	: 167 A	Moment of inertia (J)	: 8.80 sq.ft.lb
LRC	: 6.6	Duty cycle	: Cont.(S1)
Rated torque	: 222 ft.lb	Insulation class	: F
Locked rotor torque	: 200 %	Service factor	: 1.25
Breakdown torque	: 250 %	Temperature rise	: 80 K
Rated speed	: 3552 rpm	Design	: B

Heating constant

Cooling constant

Rev.	Changes Summary	Performed	Checked	Date
Performed by				
Checked by			Page	Revision
Date	13/04/2022		10 / 21	

THERMAL LIMIT CURVE

Three Phase Induction Motor - Squirrel Cage



Customer : _____

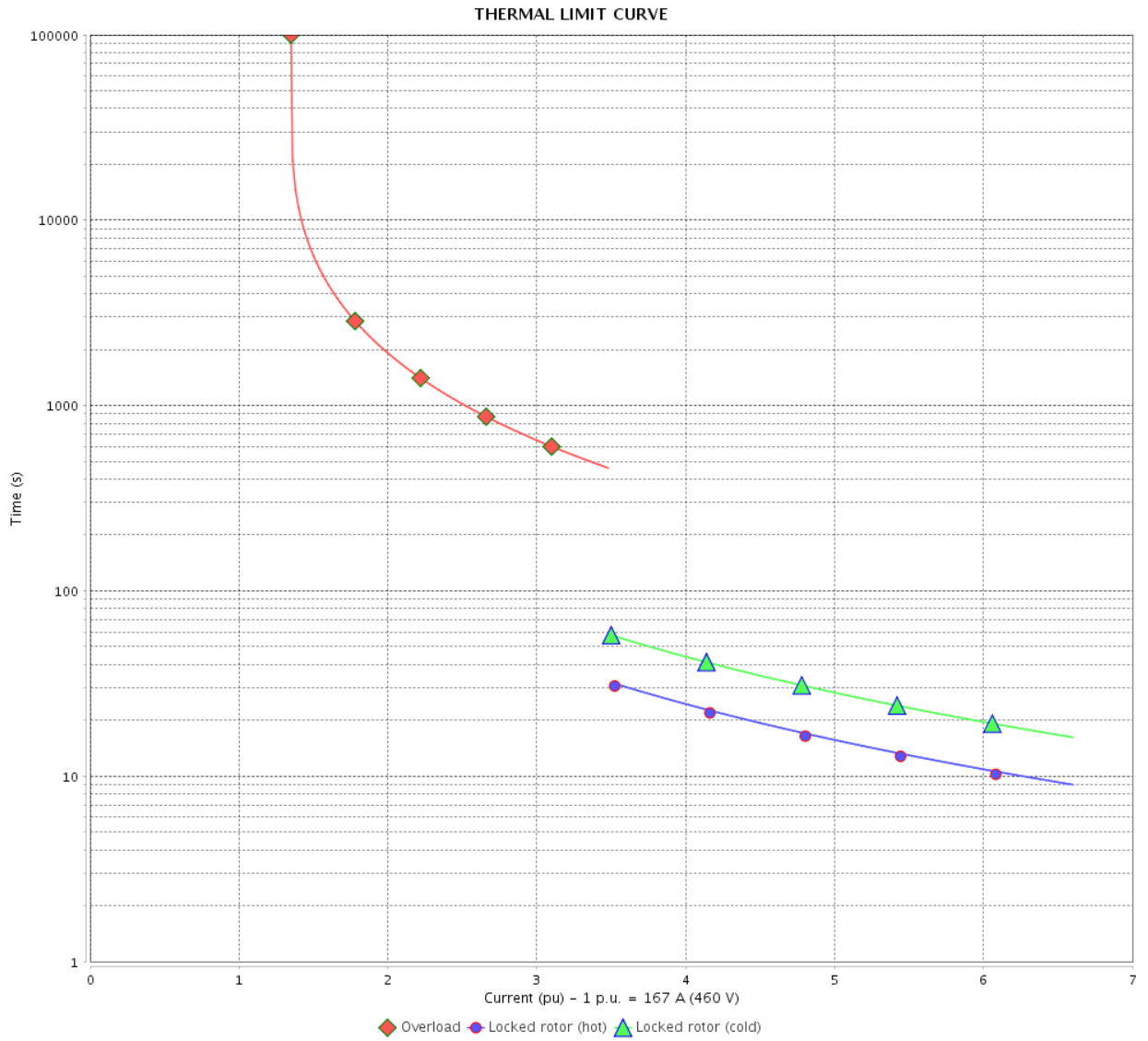

Rev.	Changes Summary	Performed	Checked	Date
Performed by				
Checked by				
Date				
			Page	Revision
			11 / 21	

THERMAL LIMIT CURVE

Three Phase Induction Motor - Squirrel Cage



Customer :

Product line : W40 NEMA Premium Efficiency
Three-Phase

Product code : 14272544

Catalog # : 15036OT3G405TSC-W40

Performance : 380 V 50 Hz 2P IE3

Rated current	: 137 A	Moment of inertia (J)	: 8.80 sq.ft.lb
LRC	: 7.2	Duty cycle	: Cont.(S1)
Rated torque	: 177 ft.lb	Insulation class	: F
Locked rotor torque	: 229 %	Service factor	: 1.00
Breakdown torque	: 290 %	Temperature rise	: 80 K
Rated speed	: 2960 rpm	Design	: B

Heating constant

Cooling constant

Rev.	Changes Summary	Performed	Checked	Date
Performed by				
Checked by			Page	Revision
Date	13/04/2022		12 / 21	

THERMAL LIMIT CURVE

Three Phase Induction Motor - Squirrel Cage



Customer : _____

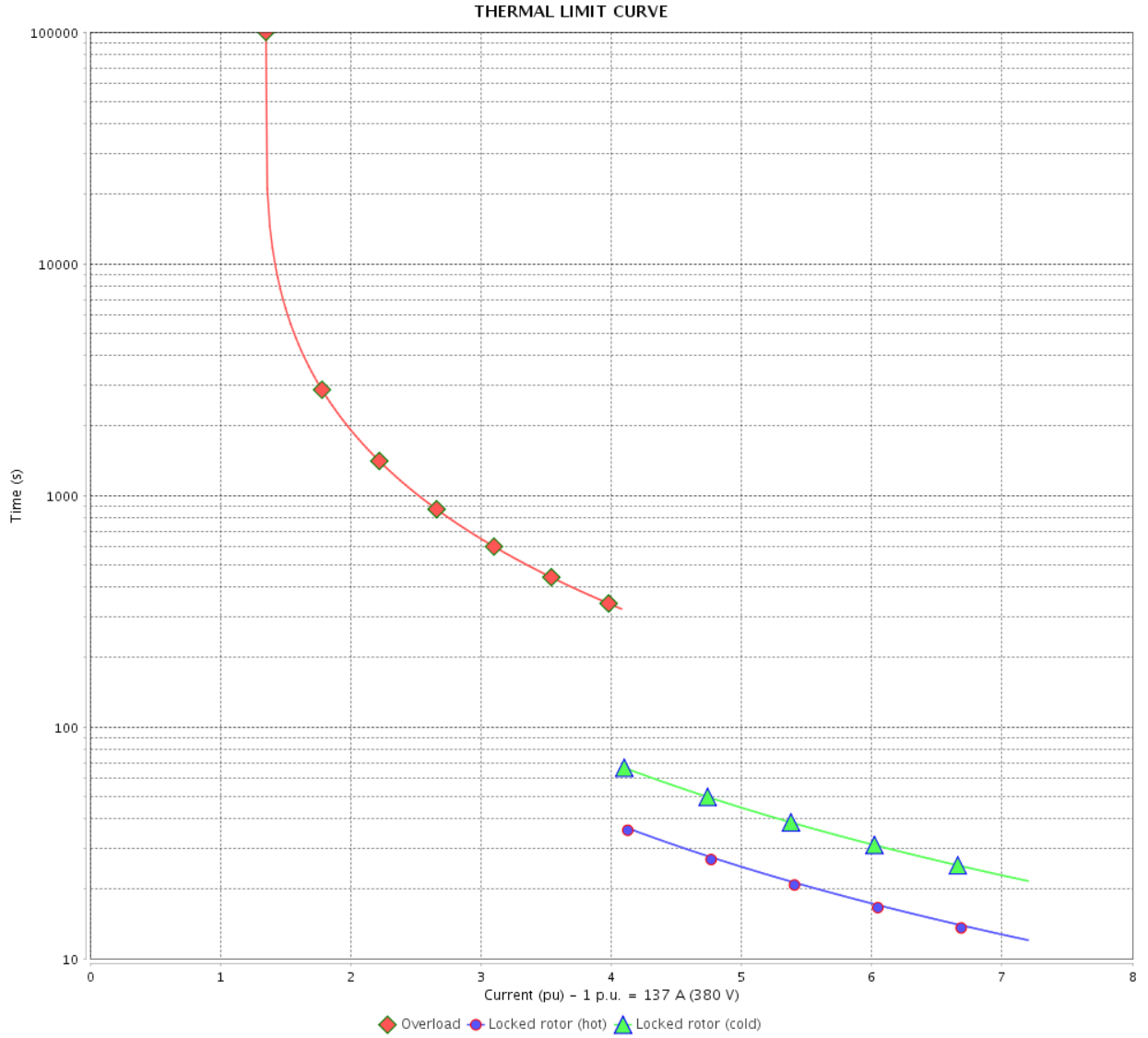

Rev.	Changes Summary	Performed	Checked	Date
Performed by		Page 13 / 21		Revision
Checked by				
Date				

THERMAL LIMIT CURVE



Three Phase Induction Motor - Squirrel Cage

Customer :

Product line : W40 NEMA Premium Efficiency
Three-Phase

Product code : 14272544

Catalog # : 15036OT3G405TSC-W40

Performance : 400 V 50 Hz 2P IE3

Rated current	: 133 A	Moment of inertia (J)	: 8.80 sq.ft.lb
LRC	: 7.9	Duty cycle	: Cont.(S1)
Rated torque	: 177 ft.lb	Insulation class	: F
Locked rotor torque	: 250 %	Service factor	: 1.00
Breakdown torque	: 330 %	Temperature rise	: 80 K
Rated speed	: 2965 rpm	Design	: B

Heating constant

Cooling constant

Rev.	Changes Summary	Performed	Checked	Date
Performed by				
Checked by			Page	Revision
Date	13/04/2022		14 / 21	

THERMAL LIMIT CURVE

Three Phase Induction Motor - Squirrel Cage



Customer : _____

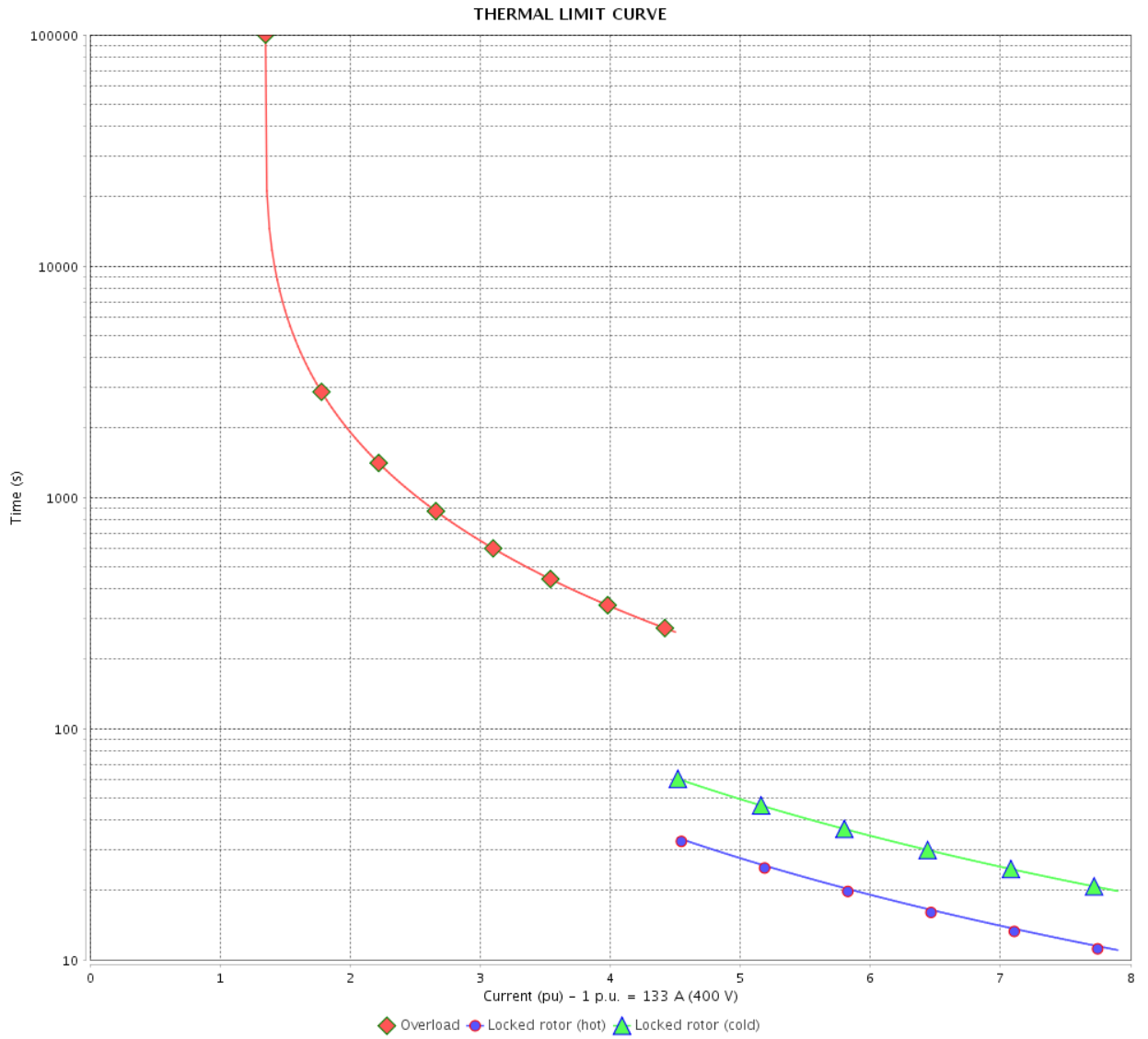

Rev.	Changes Summary	Performed	Checked	Date
Performed by		Page		Revision
Checked by		15 / 21		
Date		13/04/2022		

THERMAL LIMIT CURVE

Three Phase Induction Motor - Squirrel Cage



Customer :

Product line : W40 NEMA Premium Efficiency
Three-Phase

Product code : 14272544

Catalog # : 15036OT3G405TSC-W40

Performance : 415 V 50 Hz 2P IE3

Rated current	: 133 A	Moment of inertia (J)	: 8.80 sq.ft.lb
LRC	: 8.4	Duty cycle	: Cont.(S1)
Rated torque	: 177 ft.lb	Insulation class	: F
Locked rotor torque	: 270 %	Service factor	: 1.00
Breakdown torque	: 360 %	Temperature rise	: 80 K
Rated speed	: 2965 rpm	Design	: B

Heating constant

Cooling constant

Rev.	Changes Summary	Performed	Checked	Date
Performed by				
Checked by			Page	Revision
Date	13/04/2022		16 / 21	

THERMAL LIMIT CURVE

Three Phase Induction Motor - Squirrel Cage



Customer : _____

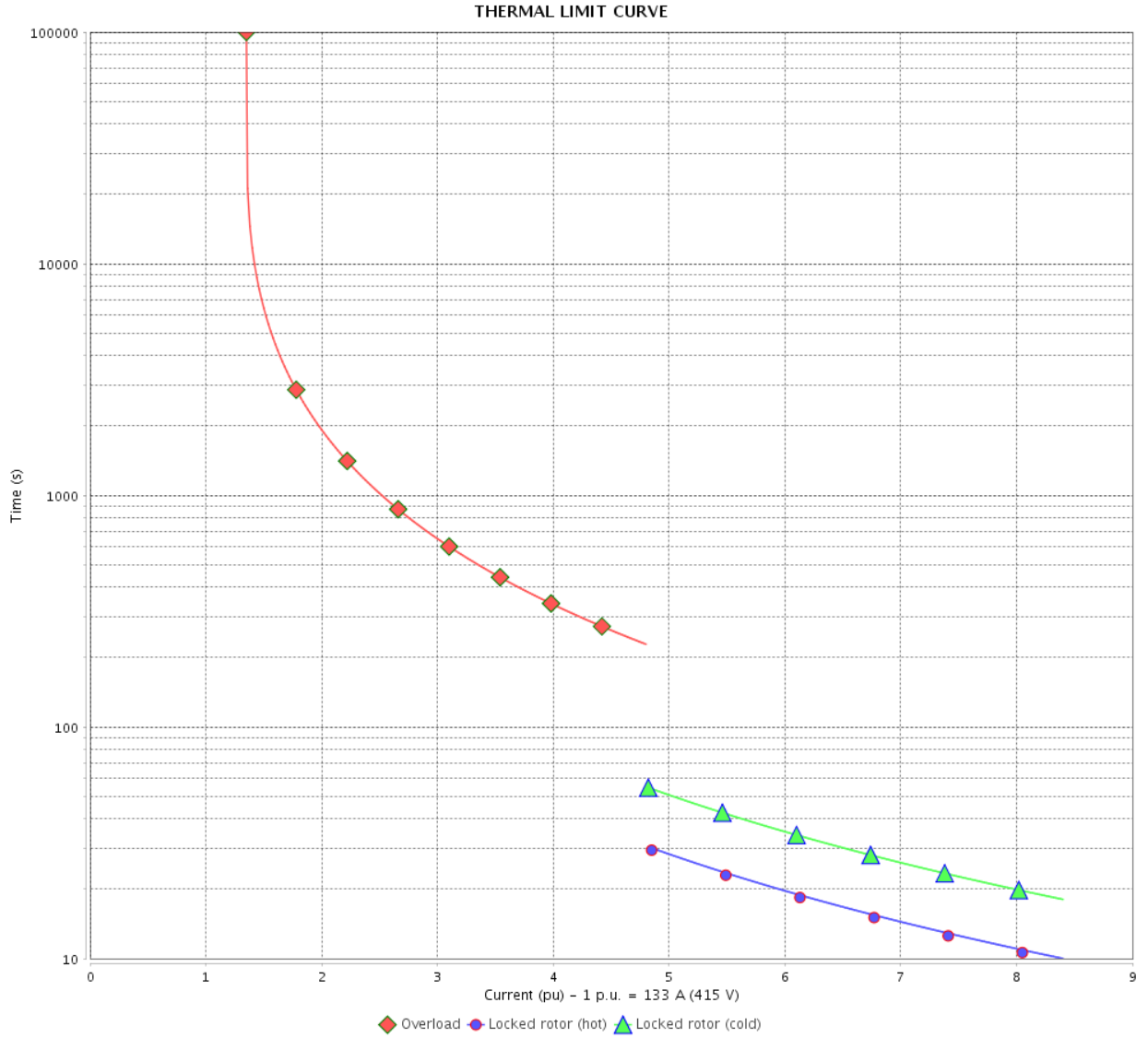

Rev.	Changes Summary	Performed	Checked	Date
Performed by		Page		Revision
Checked by		17 / 21		
Date		13/04/2022		

VFD OPERATION CURVE

Three Phase Induction Motor - Squirrel Cage



Customer :

Product line : W40 NEMA Premium Efficiency
Three-Phase

Product code : 14272544

Catalog # : 15036OT3G405TSC-W40

VFD OPERATION CURVE

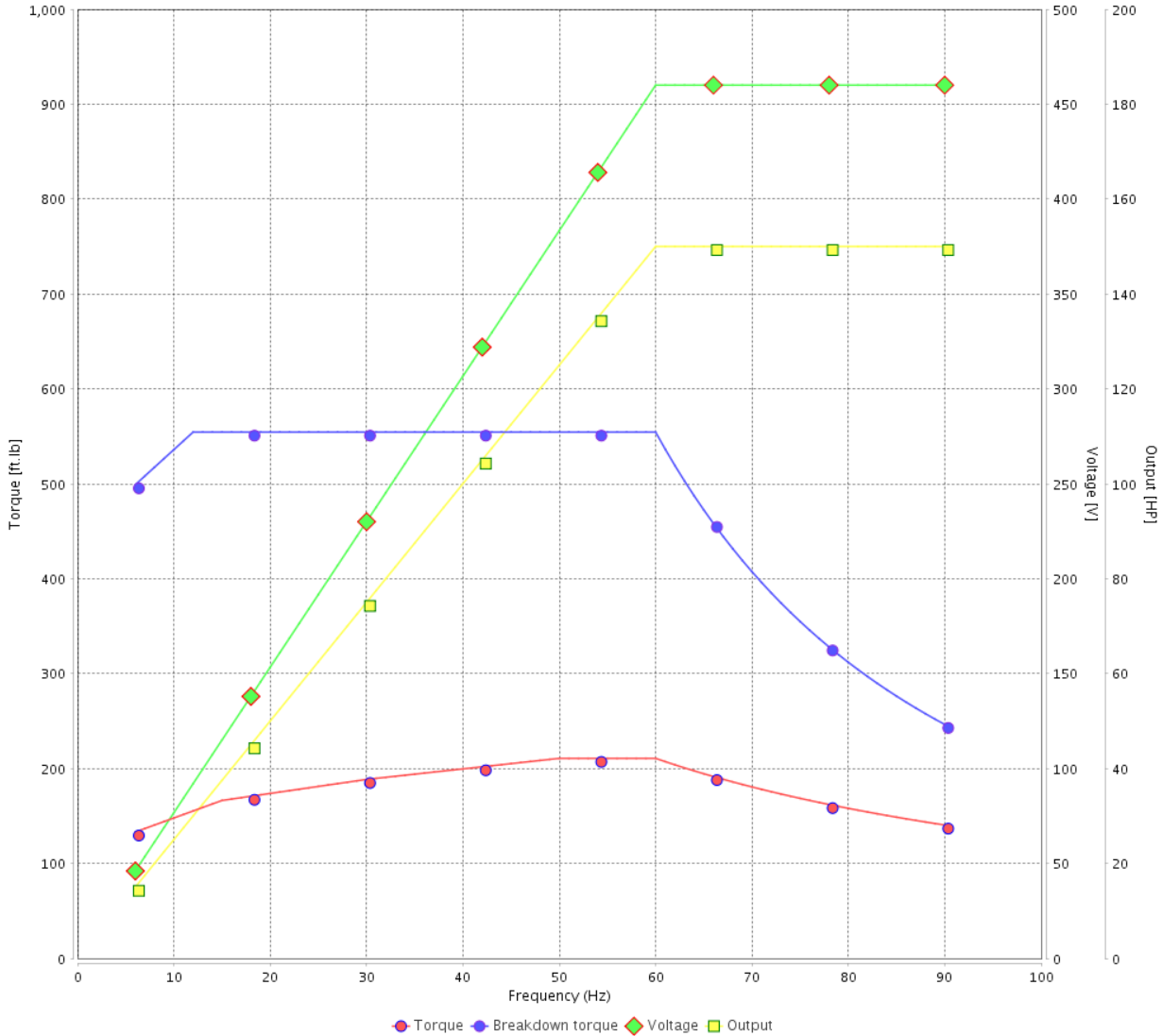

Performance : 460 V 60 Hz 2P

Rated current : 167 A
LRC : 6.6
Rated torque : 222 ft.lb
Locked rotor torque : 200 %
Breakdown torque : 250 %
Rated speed : 3552 rpm

Moment of inertia (J) : 8.80 sq.ft.lb
Duty cycle : Cont.(S1)
Insulation class : F
Service factor : 1.25
Temperature rise : 80 K
Design : B

Rev.	Changes Summary	Performed	Checked	Date
Performed by			Page 18 / 21	Revision
Checked by				
Date	13/04/2022			

VFD OPERATION CURVE

Three Phase Induction Motor - Squirrel Cage



Customer :

Product line : W40 NEMA Premium Efficiency
Three-Phase

Product code : 14272544

Catalog # : 15036OT3G405TSC-W40

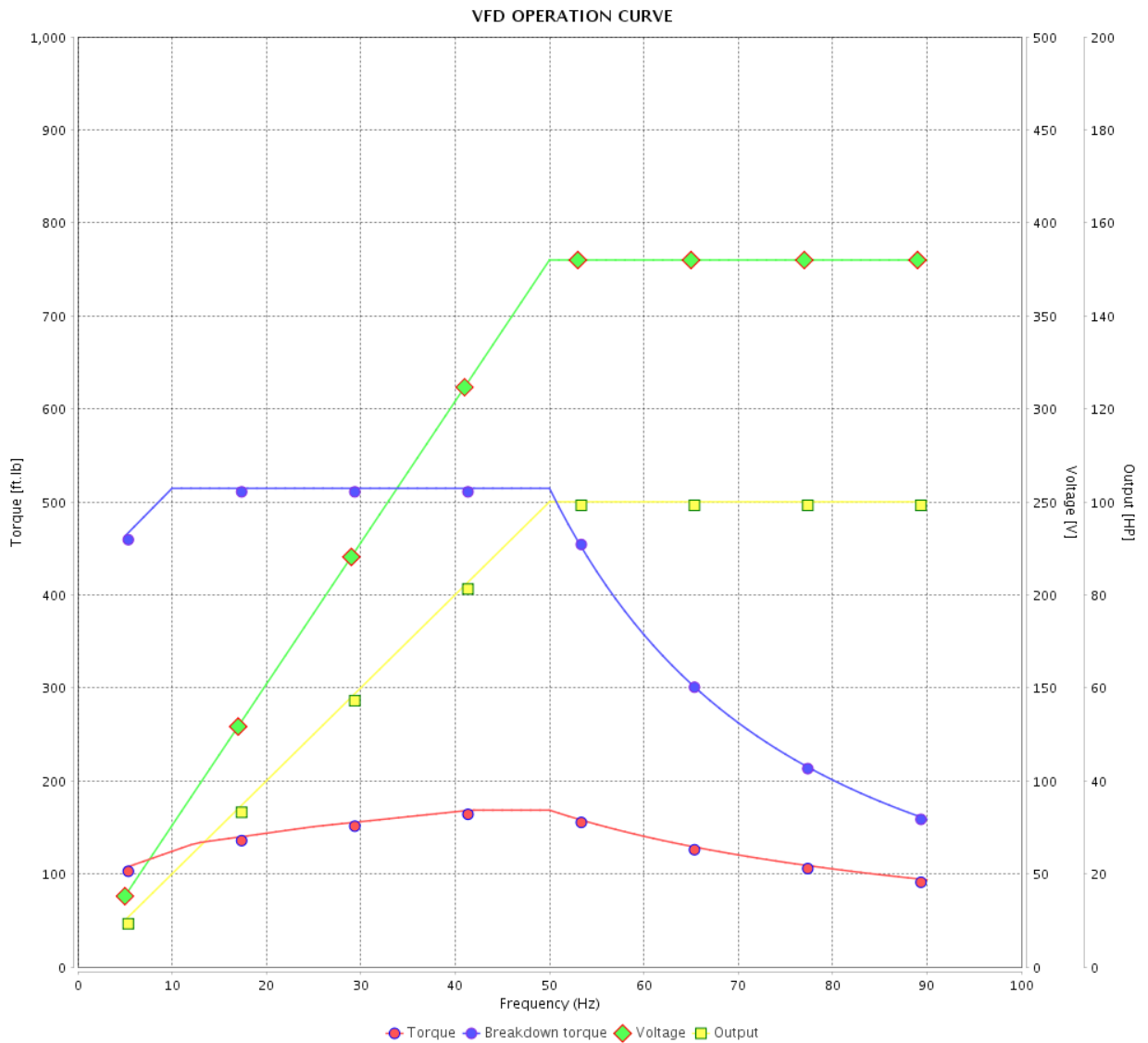

Performance : 380 V 50 Hz 2P IE3

Rated current : 137 A
LRC : 7.2
Rated torque : 177 ft.lb
Locked rotor torque : 229 %
Breakdown torque : 290 %
Rated speed : 2960 rpm

Moment of inertia (J) : 8.80 sq.ft.lb
Duty cycle : Cont.(S1)
Insulation class : F
Service factor : 1.00
Temperature rise : 80 K
Design : B

Rev.	Changes Summary	Performed	Checked	Date
Performed by			Page 19 / 21	Revision
Checked by				
Date	13/04/2022			

VFD OPERATION CURVE

Three Phase Induction Motor - Squirrel Cage



Customer :

Product line : W40 NEMA Premium Efficiency Three-Phase

Product code : 14272544

Catalog # : 15036OT3G405TSC-W40

VFD OPERATION CURVE

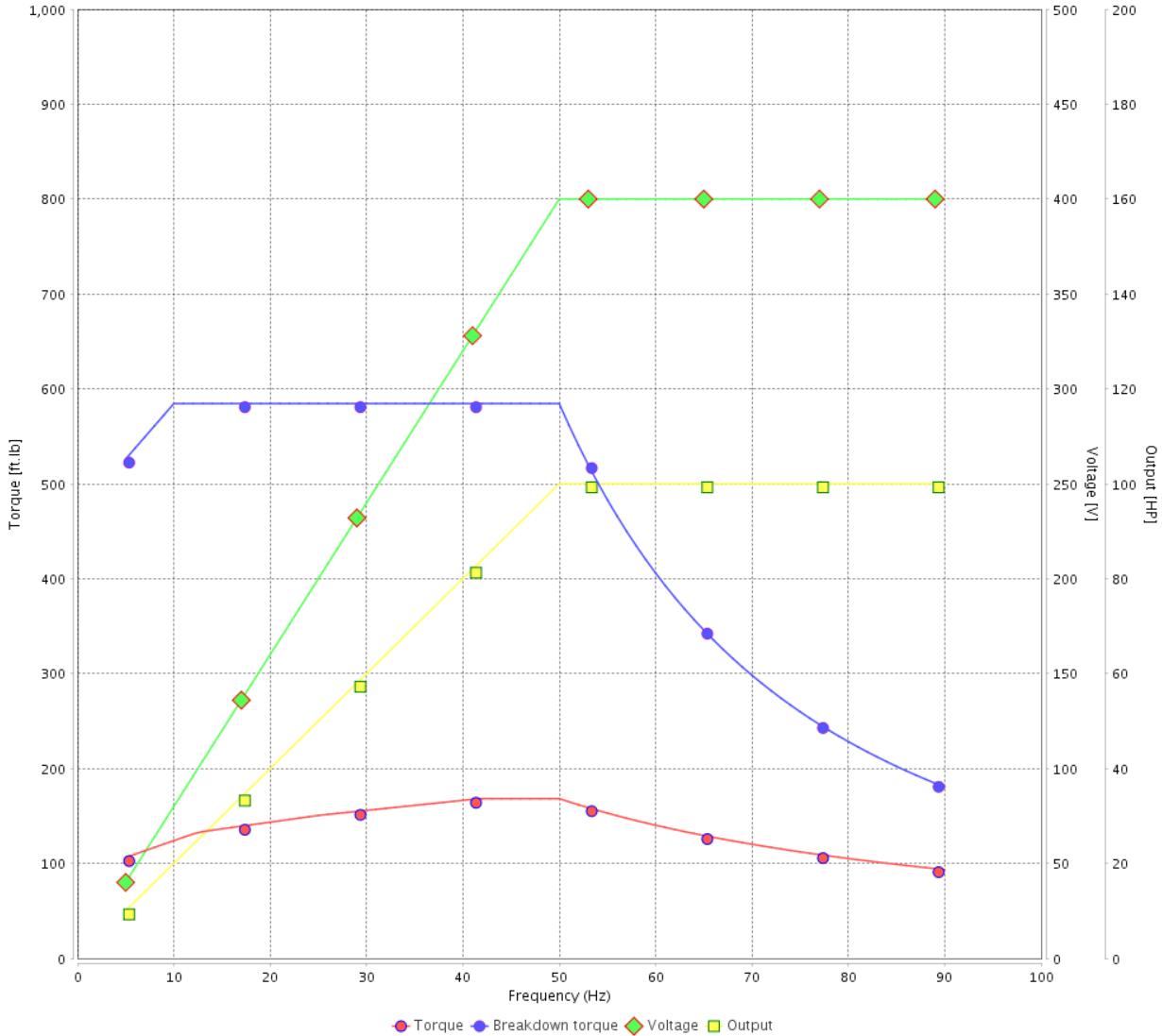

Performance : 400 V 50 Hz 2P IE3

Rated current : 133 A
 LRC : 7.9
 Rated torque : 177 ft.lb
 Locked rotor torque : 250 %
 Breakdown torque : 330 %
 Rated speed : 2965 rpm

Moment of inertia (J) : 8.80 sq.ft.lb
 Duty cycle : Cont.(S1)
 Insulation class : F
 Service factor : 1.00
 Temperature rise : 80 K
 Design : B

Rev.	Changes Summary	Performed	Checked	Date
Performed by			Page 20 / 21	Revision
Checked by				
Date	13/04/2022			

VFD OPERATION CURVE

Three Phase Induction Motor - Squirrel Cage



Customer :

Product line : W40 NEMA Premium Efficiency
Three-Phase

Product code : 14272544

Catalog # : 15036OT3G405TSC-W40

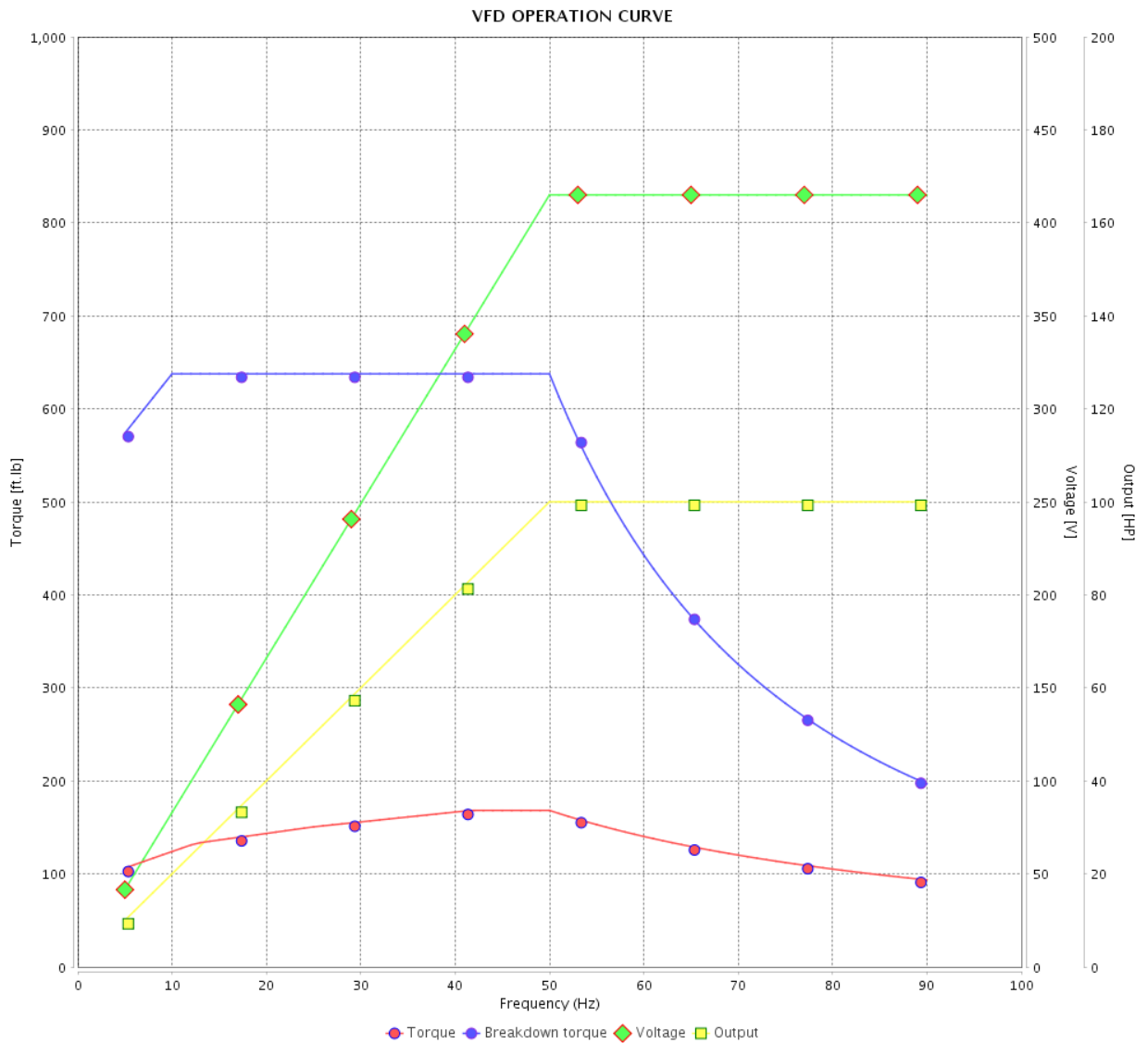

Performance : 415 V 50 Hz 2P IE3

Rated current : 133 A
LRC : 8.4
Rated torque : 177 ft.lb
Locked rotor torque : 270 %
Breakdown torque : 360 %
Rated speed : 2965 rpm

Moment of inertia (J) : 8.80 sq.ft.lb
Duty cycle : Cont.(S1)
Insulation class : F
Service factor : 1.00
Temperature rise : 80 K
Design : B

Rev.	Changes Summary	Performed	Checked	Date
Performed by			Page 21 / 21	Revision
Checked by				
Date	13/04/2022			

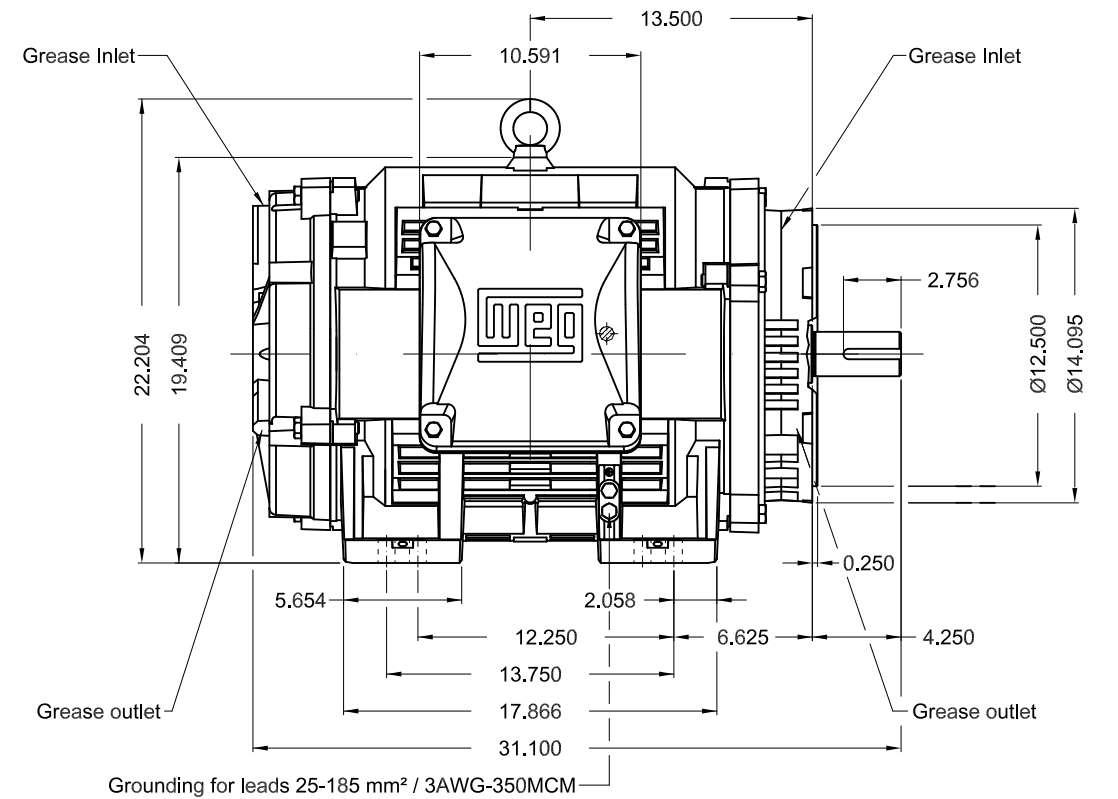
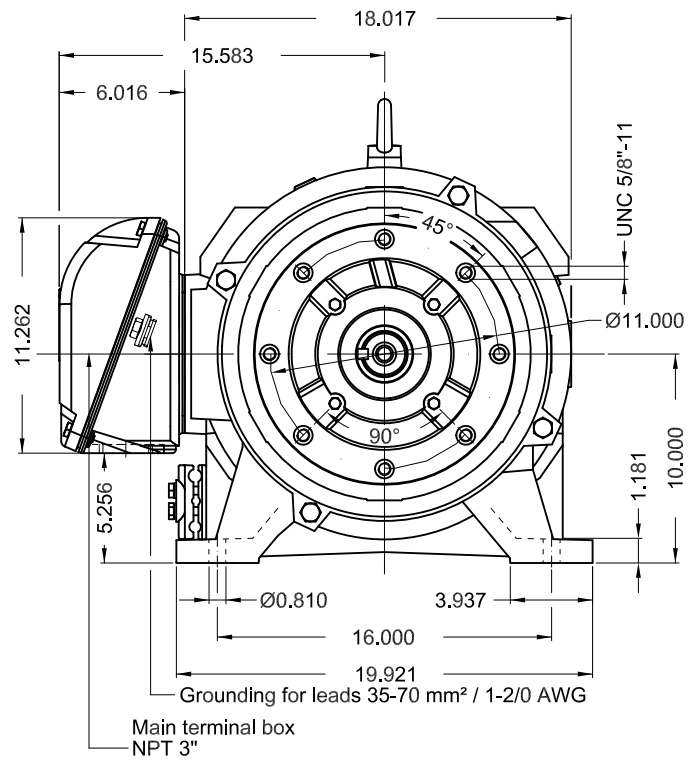

Color RAL 5009
 Painting plan 203A
 Mounting NEMA F-1
 Mounting B34R(D)

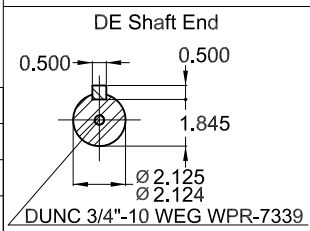

150 HP 02 Poles 60 Hz

A

1:9

ECM	LOC	SUMMARY OF MODIFICATIONS	EXECUTED	CHECKED	RELEASED	DATE	VER
EXECUTED	PIRWBUSER	THREE PH. MOTOR W40 PREM. EFF.					
CHECKED		FRAME 404/5TSC IP23 ODP					
RELEASED							
REL DT.		WMO Jaragua do Sul	Product Engineering				

PREVIEW
 WDD



SHEET 1 / 1