

DATA SHEET

Three Phase Induction Motor - Squirrel Cage



Customer :					
Product line	: NEMA Premium Efficiency Three-Phase	Product code :	12389902		
		Catalog # :	20018ST3QIERB447T-W2		
Frame	: 445/7T	Cooling method	: IC411 - TEFC		
Insulation class	: F	Mounting	: F-1		
Duty cycle	: Cont.(S1)	Rotation ¹	: Both (CW and CCW)		
Ambient temperature	: -20°C to +40°C	Starting method	: Direct On Line		
Altitude	: 1000 m.a.s.l.	Approx. weight ²	: 2328 lb		
Protection degree	: IP55	Moment of inertia (J)	: 76.2 sq.ft.lb		
Design	: B				
Output [HP]	200	200	200	200	
Poles	4	4	4	4	
Frequency [Hz]	60	50	50	50	
Rated voltage [V]	460	380	400	415	
Rated current [A]	230	279	264	257	
L. R. Amperes [A]	1564	1423	1478	1568	
LRC [A]	6.8x(Code G)	5.1x(Code E)	5.6x(Code F)	6.1x(Code G)	
No load current [A]	70.0	69.0	75.0	79.0	
Rated speed [RPM]	1785	1475	1480	1480	
Slip [%]	0.83	1.67	1.33	1.33	
Rated torque [ft.lb]	588	712	710	710	
Locked rotor torque [%]	229	170	190	210	
Breakdown torque [%]	250	200	220	240	
Service factor	1.15	1.00	1.00	1.00	
Temperature rise	80 K	105 K	105 K	105 K	
Locked rotor time	28s (cold) 16s (hot)	18s (cold) 10s (hot)	18s (cold) 10s (hot)	18s (cold) 10s (hot)	
Noise level ²	73.0 dB(A)				
Efficiency (%)	25%	95.7	94.3	94.9	94.9
	50%	95.8	94.5	95.0	95.0
	75%	96.2	95.0	95.4	95.4
	100%	96.2	95.0	95.4	95.4
Power Factor	25%	0.50	0.56	0.53	0.50
	50%	0.73	0.78	0.76	0.73
	75%	0.82	0.85	0.84	0.82
	100%	0.85	0.86	0.86	0.85
Bearing type	: <u>Drive end</u> NU-319 C3	<u>Non drive end</u> 6316 C3	Foundation loads		
Sealing	: Inpro/Seal	Inpro/Seal	Max. traction	: 3376 lb	
Lubrication interval	: 5000 h	10000 h	Max. compression	: 5704 lb	
Lubricant amount	: 45 g	34 g			
Lubricant type	: Mobil Polyrex EM				
Notes					
This revision replaces and cancel the previous one, which must be eliminated. (1) Looking the motor from the shaft end. (2) Measured at 1m and with tolerance of +3dB(A). (3) Approximate weight subject to changes after manufacturing process. (4) At 100% of full load.			These are average values based on tests with sinusoidal power supply, subject to the tolerances stipulated in NEMA MG-1.		
Rev.	Changes Summary		Performed	Checked	Date
Performed by					
Checked by				Page	Revision
Date	14/04/2022			1 / 21	

TORQUE AND CURRENT VS SPEED CURVE

Three Phase Induction Motor - Squirrel Cage



Customer :

Product line : NEMA Premium Efficiency Three-Phase

Product code : 12389902

Catalog # : 20018ST3QIERB447T-W2

TORQUE AND CURRENT VS SPEED CURVE

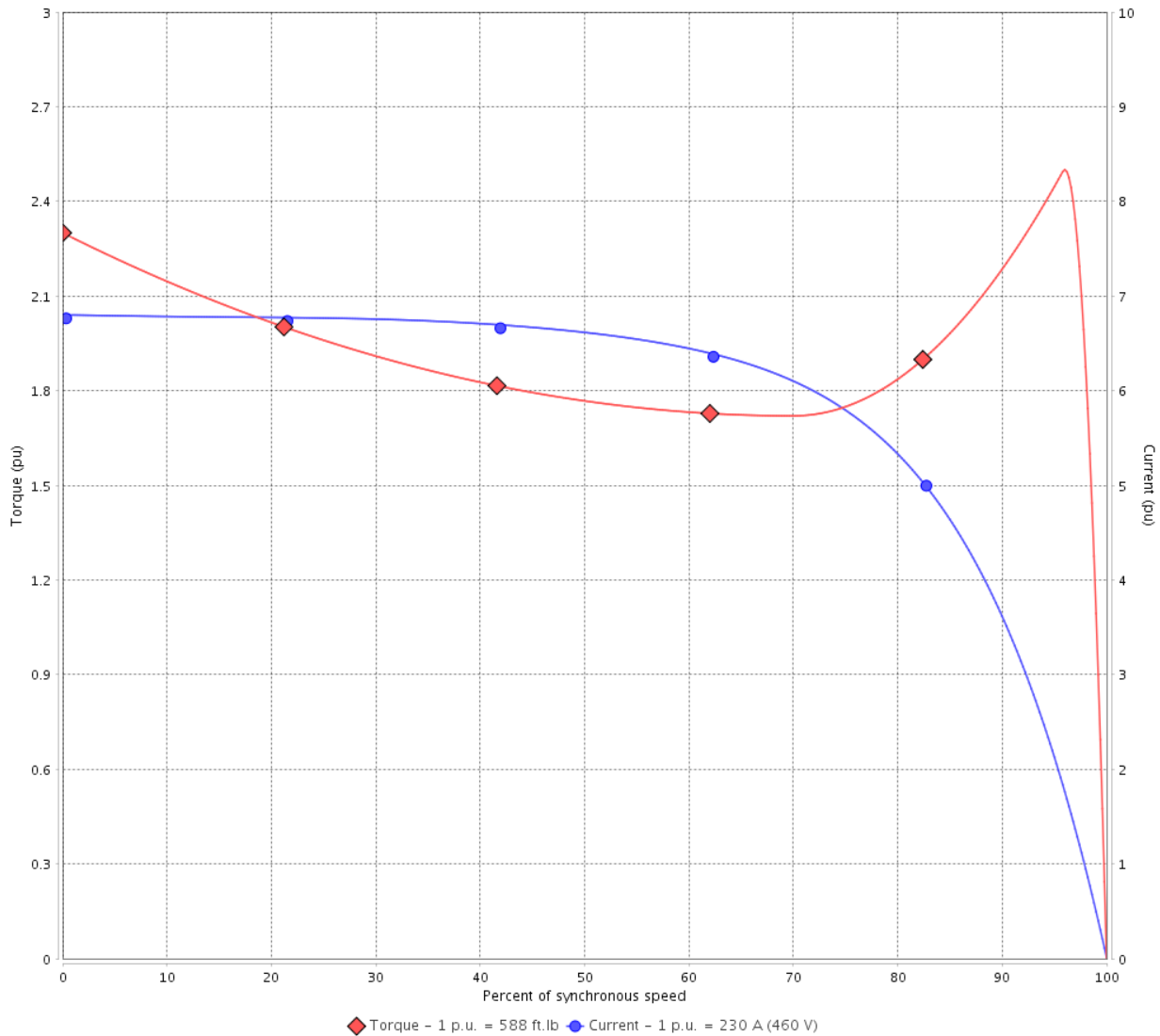

Performance : 460 V 60 Hz 4P

Rated current	: 230 A	Moment of inertia (J)	: 76.2 sq.ft.lb
LRC	: 6.8	Duty cycle	: Cont.(S1)
Rated torque	: 588 ft.lb	Insulation class	: F
Locked rotor torque	: 229 %	Service factor	: 1.15
Breakdown torque	: 250 %	Temperature rise	: 80 K
Rated speed	: 1785 rpm	Design	: B

Locked rotor time : 28s (cold) 16s (hot)

Rev.	Changes Summary	Performed	Checked	Date
Performed by			Page 2 / 21	Revision
Checked by				
Date	14/04/2022			

TORQUE AND CURRENT VS SPEED CURVE



Three Phase Induction Motor - Squirrel Cage

Customer :

Product line : NEMA Premium Efficiency Three-Phase

Product code : 12389902

Catalog # : 20018ST3QIERB447T-W2

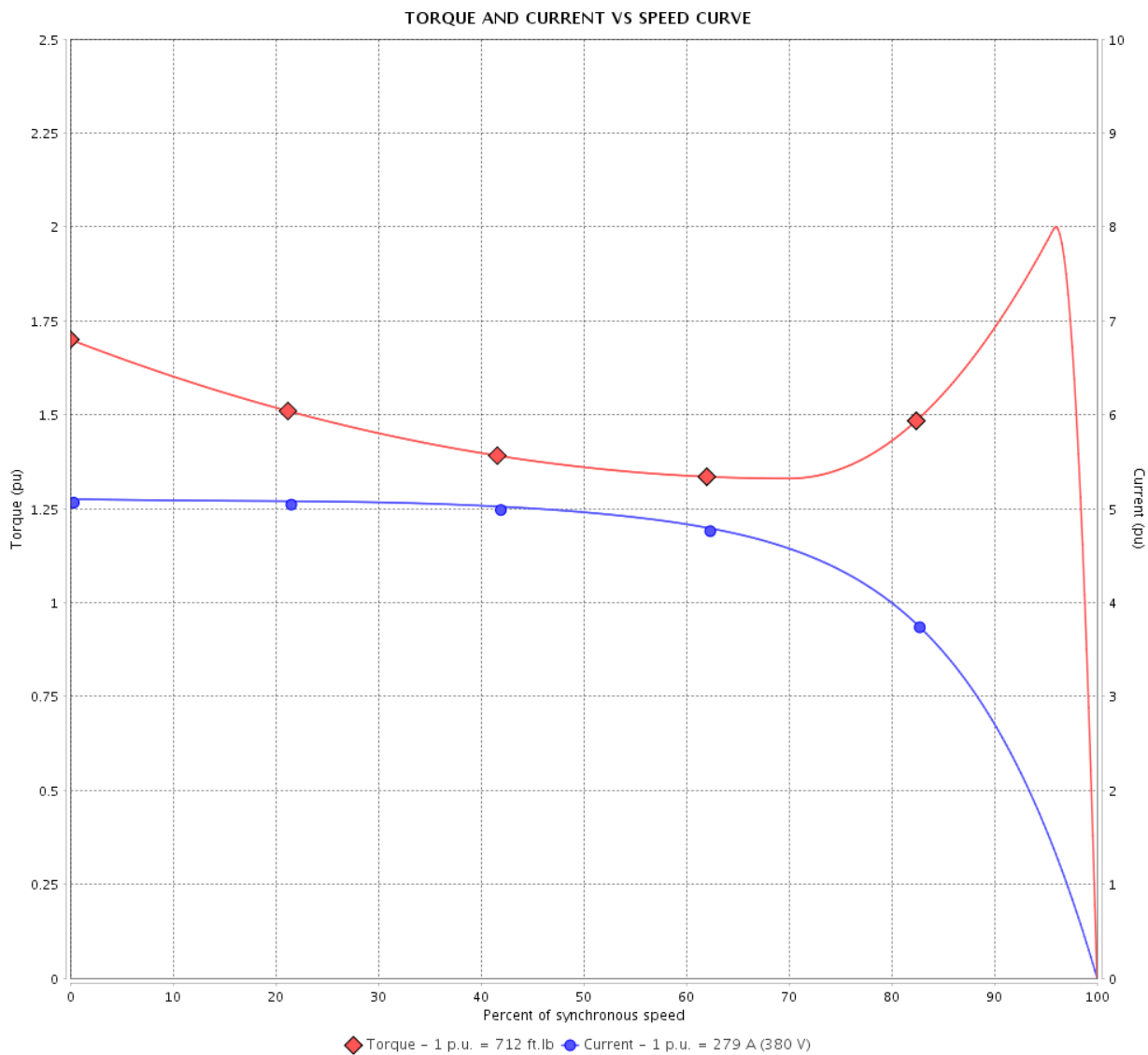

Performance : 380 V 50 Hz 4P IE2

Rated current	: 279 A	Moment of inertia (J)	: 76.2 sq.ft.lb
LRC	: 5.1	Duty cycle	: Cont.(S1)
Rated torque	: 712 ft.lb	Insulation class	: F
Locked rotor torque	: 170 %	Service factor	: 1.00
Breakdown torque	: 200 %	Temperature rise	: 105 K
Rated speed	: 1475 rpm	Design	: B

Locked rotor time : 18s (cold) 10s (hot)

Rev.	Changes Summary	Performed	Checked	Date
Performed by			Page 3 / 21	Revision
Checked by				
Date	14/04/2022			

TORQUE AND CURRENT VS SPEED CURVE

Three Phase Induction Motor - Squirrel Cage



Customer :

Product line : NEMA Premium Efficiency Three-Phase

Product code : 12389902

Catalog # : 20018ST3QIERB447T-W2

TORQUE AND CURRENT VS SPEED CURVE

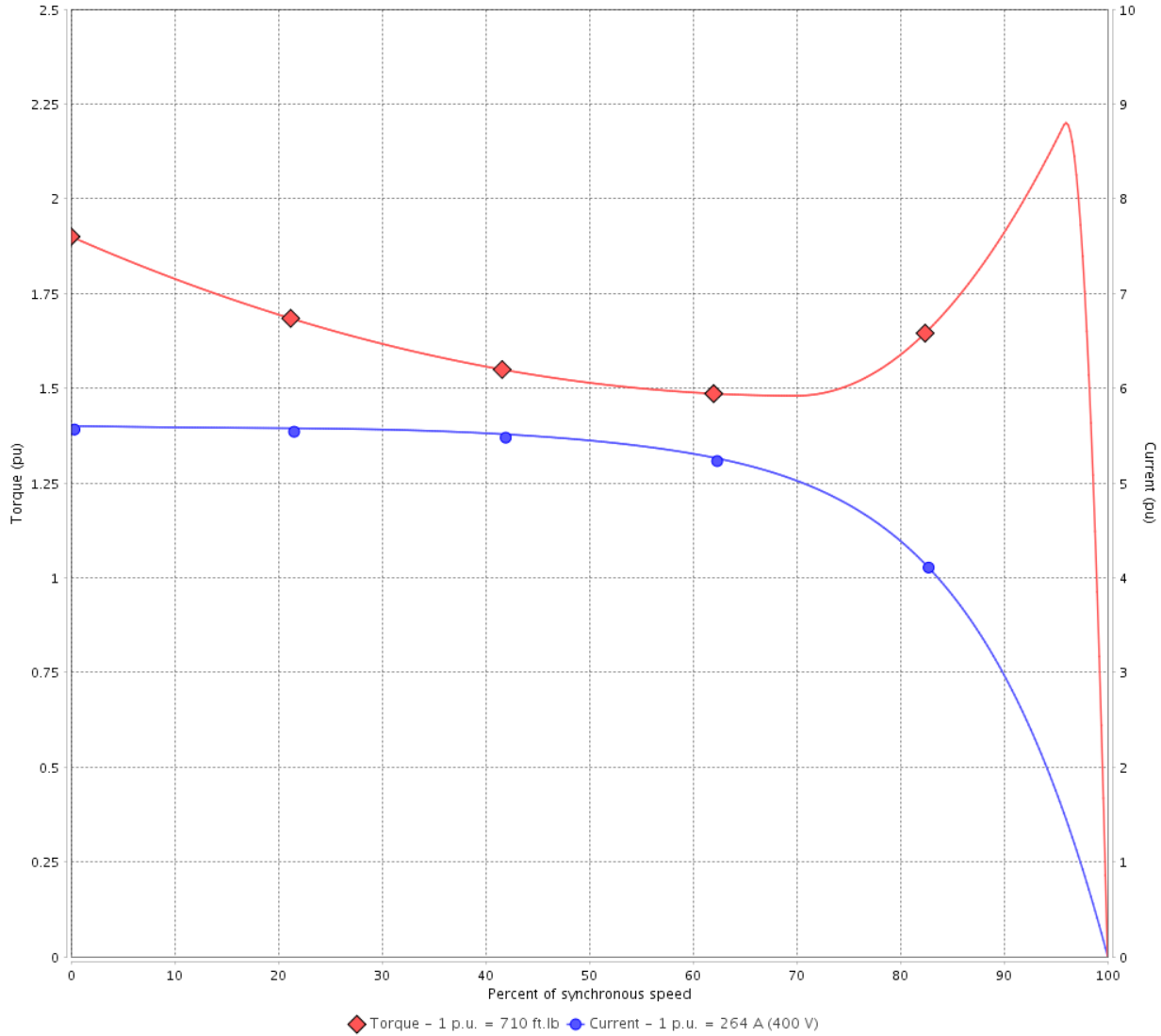

Performance : 400 V 50 Hz 4P IE2

Rated current	: 264 A	Moment of inertia (J)	: 76.2 sq.ft.lb
LRC	: 5.6	Duty cycle	: Cont.(S1)
Rated torque	: 710 ft.lb	Insulation class	: F
Locked rotor torque	: 190 %	Service factor	: 1.00
Breakdown torque	: 220 %	Temperature rise	: 105 K
Rated speed	: 1480 rpm	Design	: B

Locked rotor time : 18s (cold) 10s (hot)

Rev.	Changes Summary	Performed	Checked	Date
Performed by			Page 4 / 21	Revision
Checked by				
Date	14/04/2022			

TORQUE AND CURRENT VS SPEED CURVE



Three Phase Induction Motor - Squirrel Cage

Customer :

Product line : NEMA Premium Efficiency Three-Phase

Product code : 12389902

Catalog # : 20018ST3QIERB447T-W2

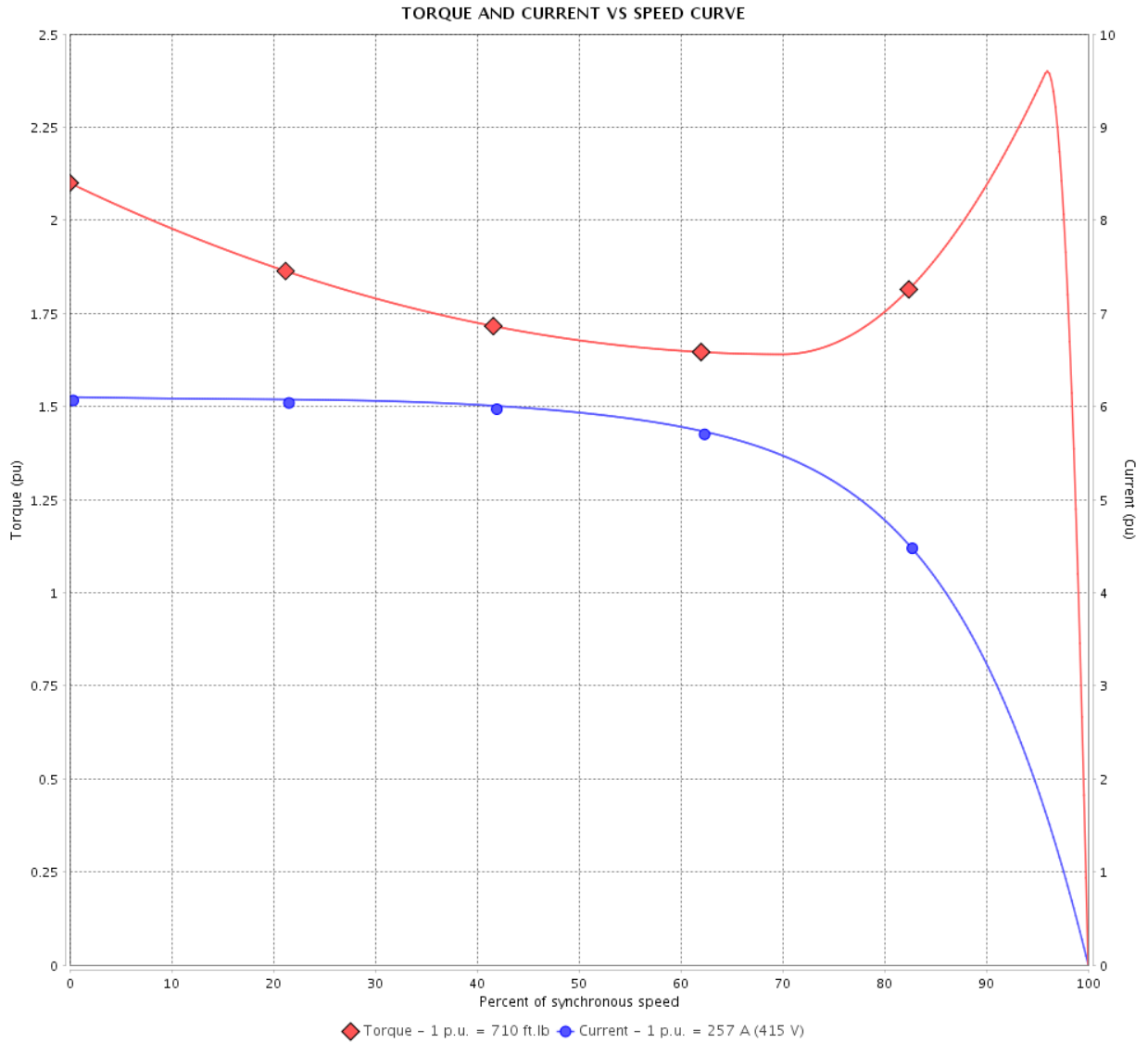

Performance : 415 V 50 Hz 4P IE2

Rated current	: 257 A	Moment of inertia (J)	: 76.2 sq.ft.lb
LRC	: 6.1	Duty cycle	: Cont.(S1)
Rated torque	: 710 ft.lb	Insulation class	: F
Locked rotor torque	: 210 %	Service factor	: 1.00
Breakdown torque	: 240 %	Temperature rise	: 105 K
Rated speed	: 1480 rpm	Design	: B

Locked rotor time : 18s (cold) 10s (hot)

Rev.	Changes Summary	Performed	Checked	Date
Performed by			Page 5 / 21	Revision
Checked by				
Date	14/04/2022			

LOAD PERFORMANCE CURVE

Three Phase Induction Motor - Squirrel Cage



Customer :

Product line : NEMA Premium Efficiency Three-Phase

Product code : 12389902

Catalog # : 20018ST3QIERB447T-W2

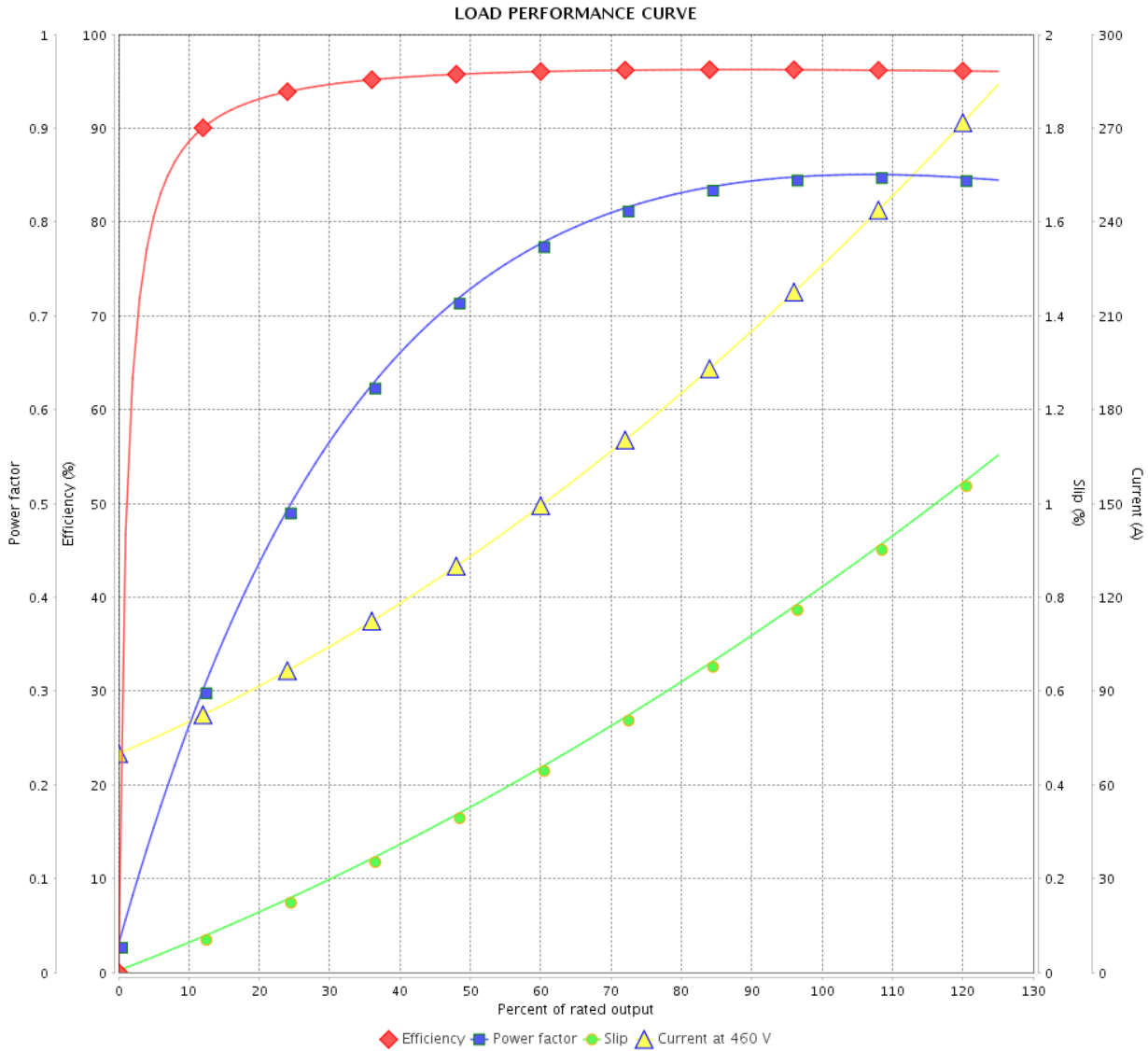

Performance : 460 V 60 Hz 4P

Rated current : 230 A
 LRC : 6.8
 Rated torque : 588 ft.lb
 Locked rotor torque : 229 %
 Breakdown torque : 250 %
 Rated speed : 1785 rpm

Moment of inertia (J) : 76.2 sq.ft.lb
 Duty cycle : Cont.(S1)
 Insulation class : F
 Service factor : 1.15
 Temperature rise : 80 K
 Design : B

Rev.	Changes Summary	Performed	Checked	Date
Performed by		Page		Revision
Checked by		6 / 21		
Date		14/04/2022		

LOAD PERFORMANCE CURVE

Three Phase Induction Motor - Squirrel Cage



Customer : _____

Product line : NEMA Premium Efficiency Three-Phase

Product code : 12389902

Catalog # : 20018ST3QIERB447T-W2

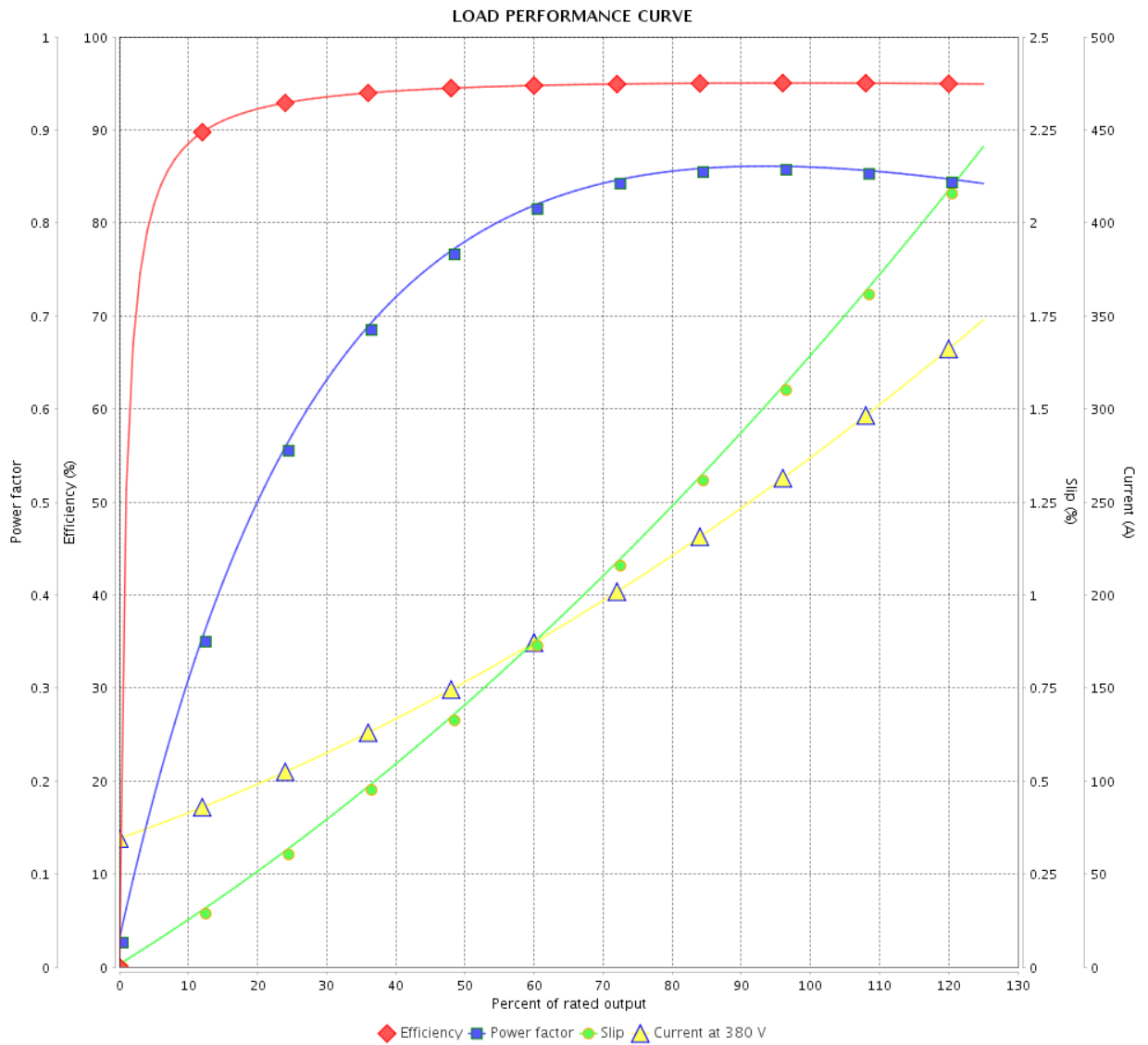

Performance : 380 V 50 Hz 4P IE2

Rated current : 279 A
 LRC : 5.1
 Rated torque : 712 ft.lb
 Locked rotor torque : 170 %
 Breakdown torque : 200 %
 Rated speed : 1475 rpm

Moment of inertia (J) : 76.2 sq.ft.lb
 Duty cycle : Cont.(S1)
 Insulation class : F
 Service factor : 1.00
 Temperature rise : 105 K
 Design : B

Rev.	Changes Summary	Performed	Checked	Date
Performed by			Page	Revision
Checked by				
Date				

LOAD PERFORMANCE CURVE

Three Phase Induction Motor - Squirrel Cage



Customer :

Product line : NEMA Premium Efficiency Three-Phase

Product code : 12389902

Catalog # : 20018ST3QIERB447T-W2

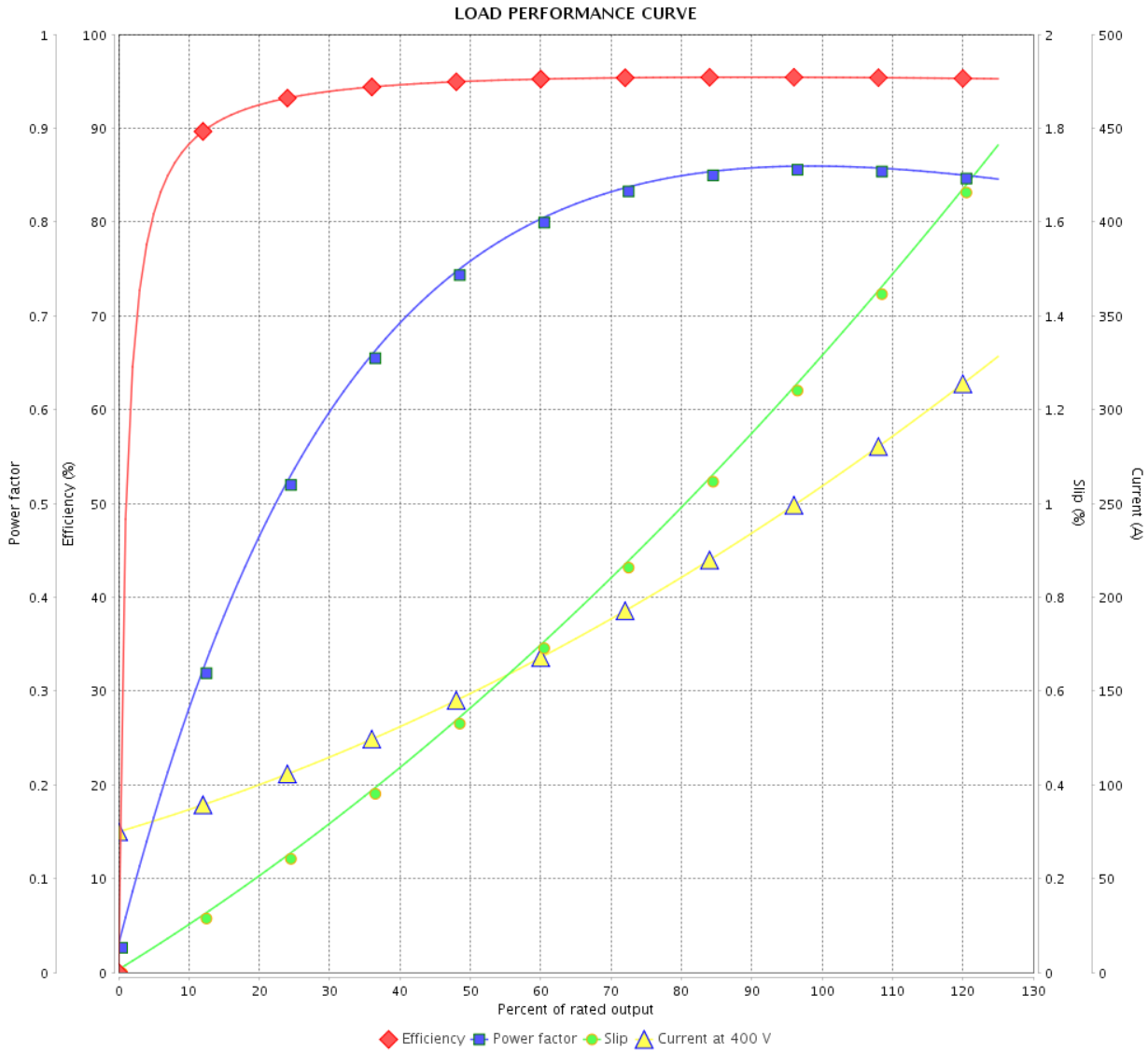

Performance : 400 V 50 Hz 4P IE2

Rated current : 264 A
 LRC : 5.6
 Rated torque : 710 ft.lb
 Locked rotor torque : 190 %
 Breakdown torque : 220 %
 Rated speed : 1480 rpm

Moment of inertia (J) : 76.2 sq.ft.lb
 Duty cycle : Cont.(S1)
 Insulation class : F
 Service factor : 1.00
 Temperature rise : 105 K
 Design : B

Rev.	Changes Summary	Performed	Checked	Date
Performed by		Page		Revision
Checked by		8 / 21		
Date		14/04/2022		

LOAD PERFORMANCE CURVE

Three Phase Induction Motor - Squirrel Cage



Customer :

Product line : NEMA Premium Efficiency Three-Phase

Product code : 12389902

Catalog # : 20018ST3QIERB447T-W2

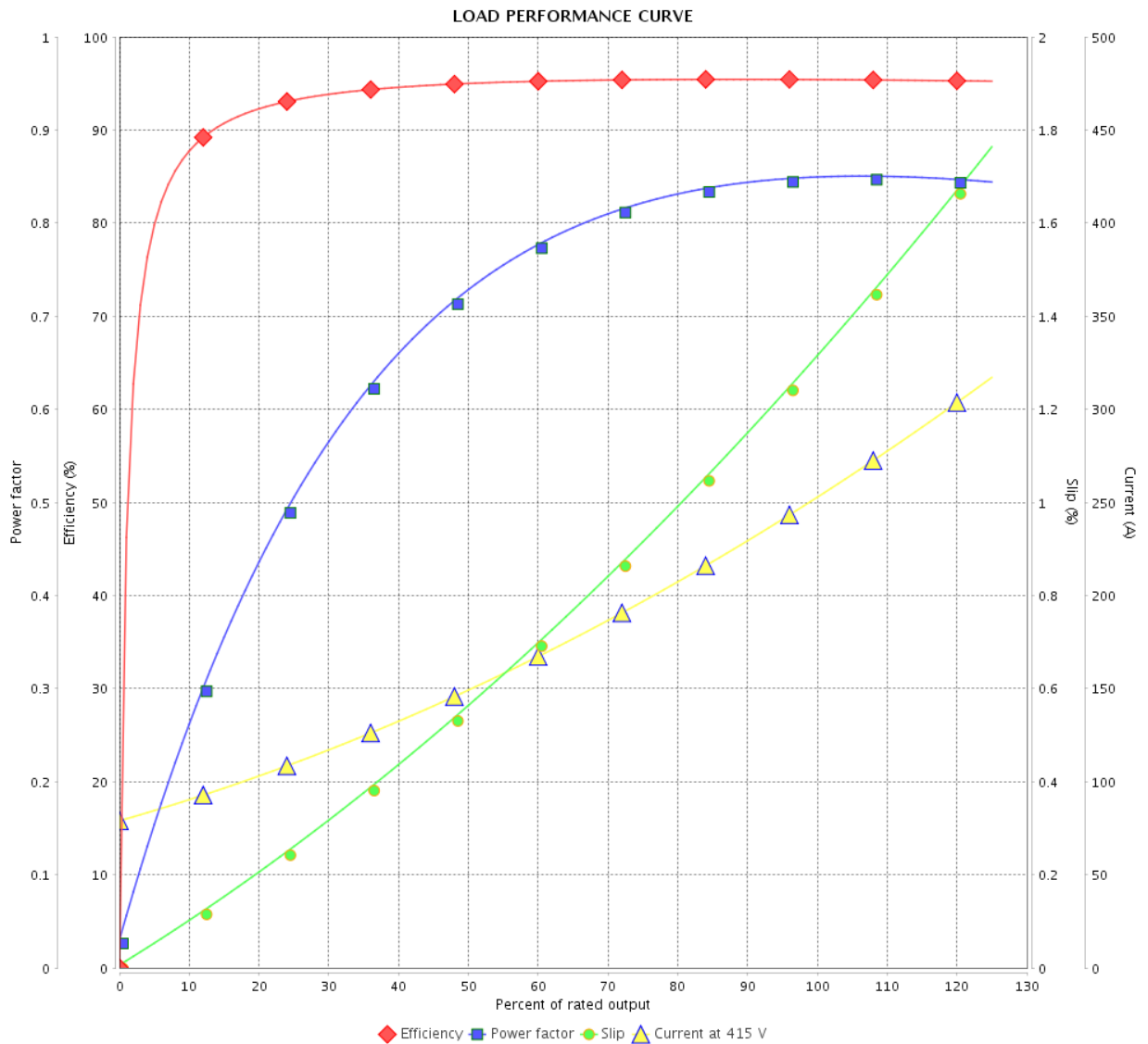

Performance : 415 V 50 Hz 4P IE2

Rated current : 257 A
 LRC : 6.1
 Rated torque : 710 ft.lb
 Locked rotor torque : 210 %
 Breakdown torque : 240 %
 Rated speed : 1480 rpm

Moment of inertia (J) : 76.2 sq.ft.lb
 Duty cycle : Cont.(S1)
 Insulation class : F
 Service factor : 1.00
 Temperature rise : 105 K
 Design : B

Rev.	Changes Summary	Performed	Checked	Date
Performed by			Page	Revision
Checked by			9 / 21	
Date	14/04/2022			

THERMAL LIMIT CURVE

Three Phase Induction Motor - Squirrel Cage



Customer :

Product line : NEMA Premium Efficiency Three-Phase

Product code : 12389902

Catalog # : 20018ST3QIERB447T-W2

Performance : 460 V 60 Hz 4P

Rated current	: 230 A	Moment of inertia (J)	: 76.2 sq.ft.lb
LRC	: 6.8	Duty cycle	: Cont.(S1)
Rated torque	: 588 ft.lb	Insulation class	: F
Locked rotor torque	: 229 %	Service factor	: 1.15
Breakdown torque	: 250 %	Temperature rise	: 80 K
Rated speed	: 1785 rpm	Design	: B

Heating constant

Cooling constant

Rev.	Changes Summary	Performed	Checked	Date
Performed by				
Checked by			Page	Revision
Date	14/04/2022		10 / 21	

THERMAL LIMIT CURVE

Three Phase Induction Motor - Squirrel Cage



Customer : _____

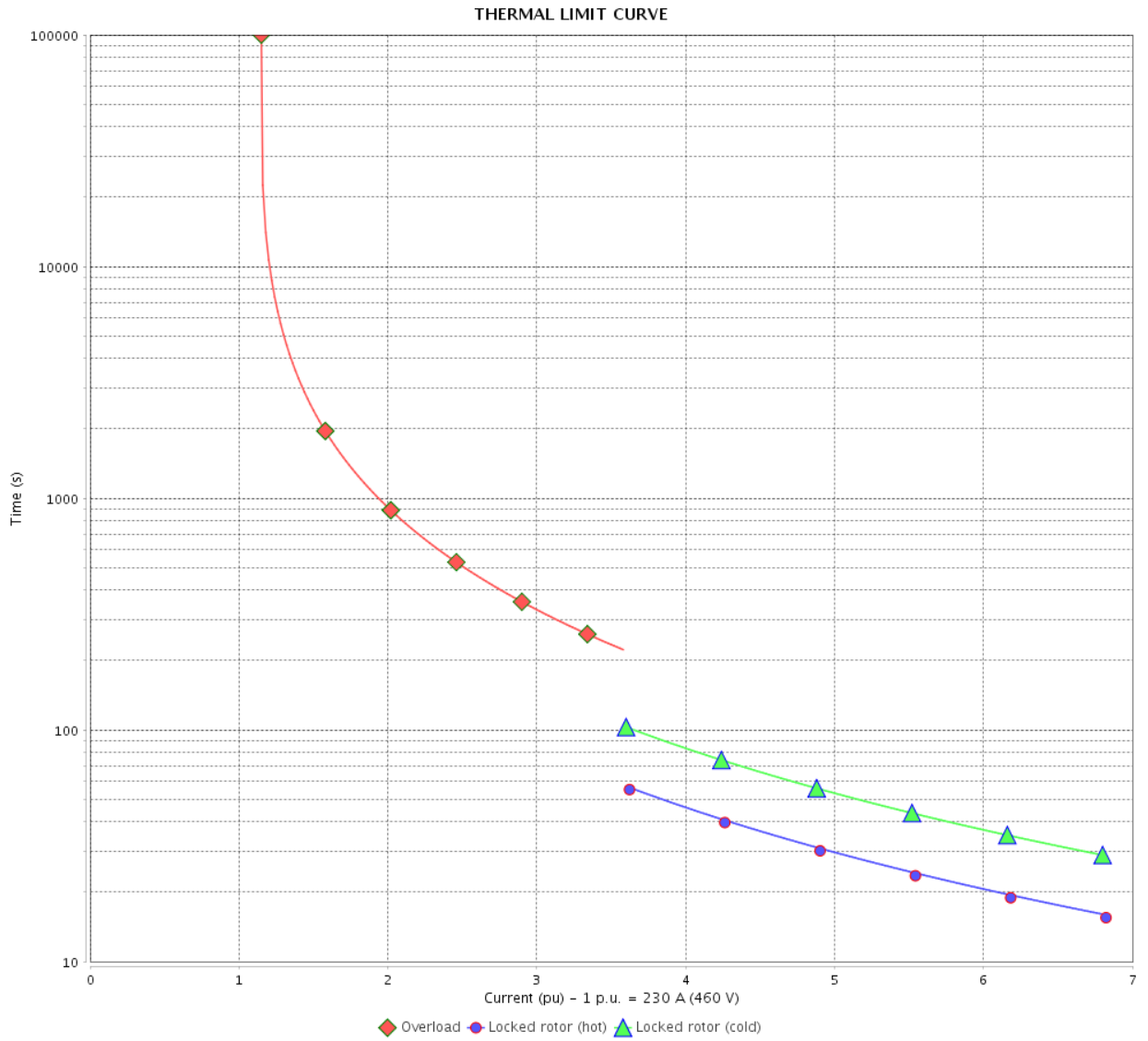

Rev.	Changes Summary	Performed	Checked	Date
Performed by				Page 11 / 21
Checked by				
Date	14/04/2022			
				Revision

THERMAL LIMIT CURVE

Three Phase Induction Motor - Squirrel Cage



Customer :

Product line : NEMA Premium Efficiency Three-Phase

Product code : 12389902

Catalog # : 20018ST3QIERB447T-W2

Performance : 380 V 50 Hz 4P IE2

Rated current	: 279 A	Moment of inertia (J)	: 76.2 sq.ft.lb
LRC	: 5.1	Duty cycle	: Cont.(S1)
Rated torque	: 712 ft.lb	Insulation class	: F
Locked rotor torque	: 170 %	Service factor	: 1.00
Breakdown torque	: 200 %	Temperature rise	: 105 K
Rated speed	: 1475 rpm	Design	: B

Heating constant

Cooling constant

Rev.	Changes Summary	Performed	Checked	Date
Performed by				
Checked by			Page	Revision
Date	14/04/2022		12 / 21	

THERMAL LIMIT CURVE

Three Phase Induction Motor - Squirrel Cage



Customer : _____

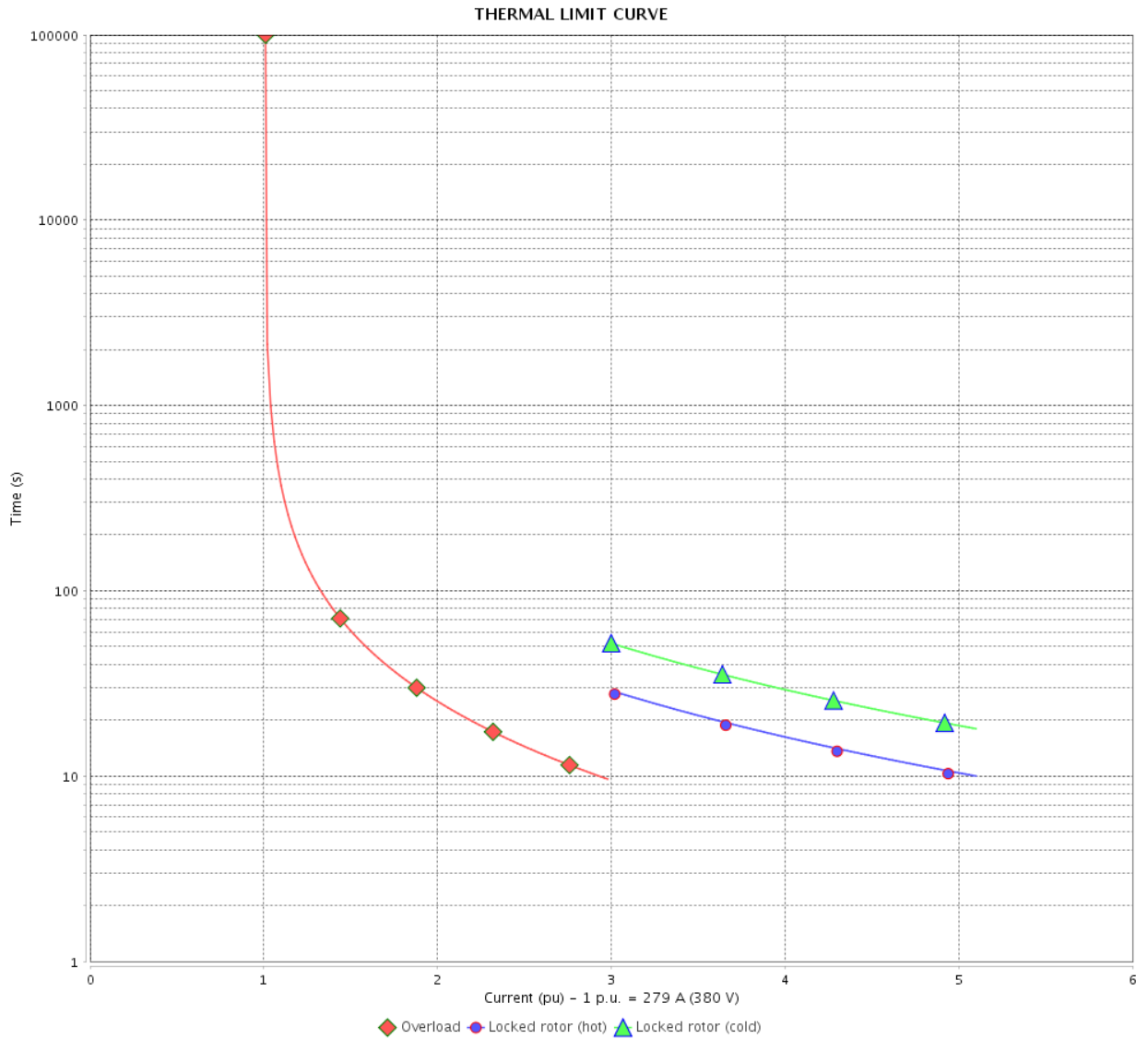

Rev.	Changes Summary	Performed	Checked	Date
Performed by				
Checked by				
Date				
			Page	Revision
			13 / 21	

THERMAL LIMIT CURVE



Three Phase Induction Motor - Squirrel Cage

Customer :

Product line : NEMA Premium Efficiency Three-Phase
Product code : 12389902
Catalog # : 20018ST3QIERB447T-W2

Performance : 400 V 50 Hz 4P IE2

Rated current	: 264 A	Moment of inertia (J)	: 76.2 sq.ft.lb
LRC	: 5.6	Duty cycle	: Cont.(S1)
Rated torque	: 710 ft.lb	Insulation class	: F
Locked rotor torque	: 190 %	Service factor	: 1.00
Breakdown torque	: 220 %	Temperature rise	: 105 K
Rated speed	: 1480 rpm	Design	: B

Heating constant

Cooling constant

Rev.	Changes Summary	Performed	Checked	Date
Performed by				
Checked by			Page	Revision
Date	14/04/2022		14 / 21	

THERMAL LIMIT CURVE

Three Phase Induction Motor - Squirrel Cage



Customer : _____

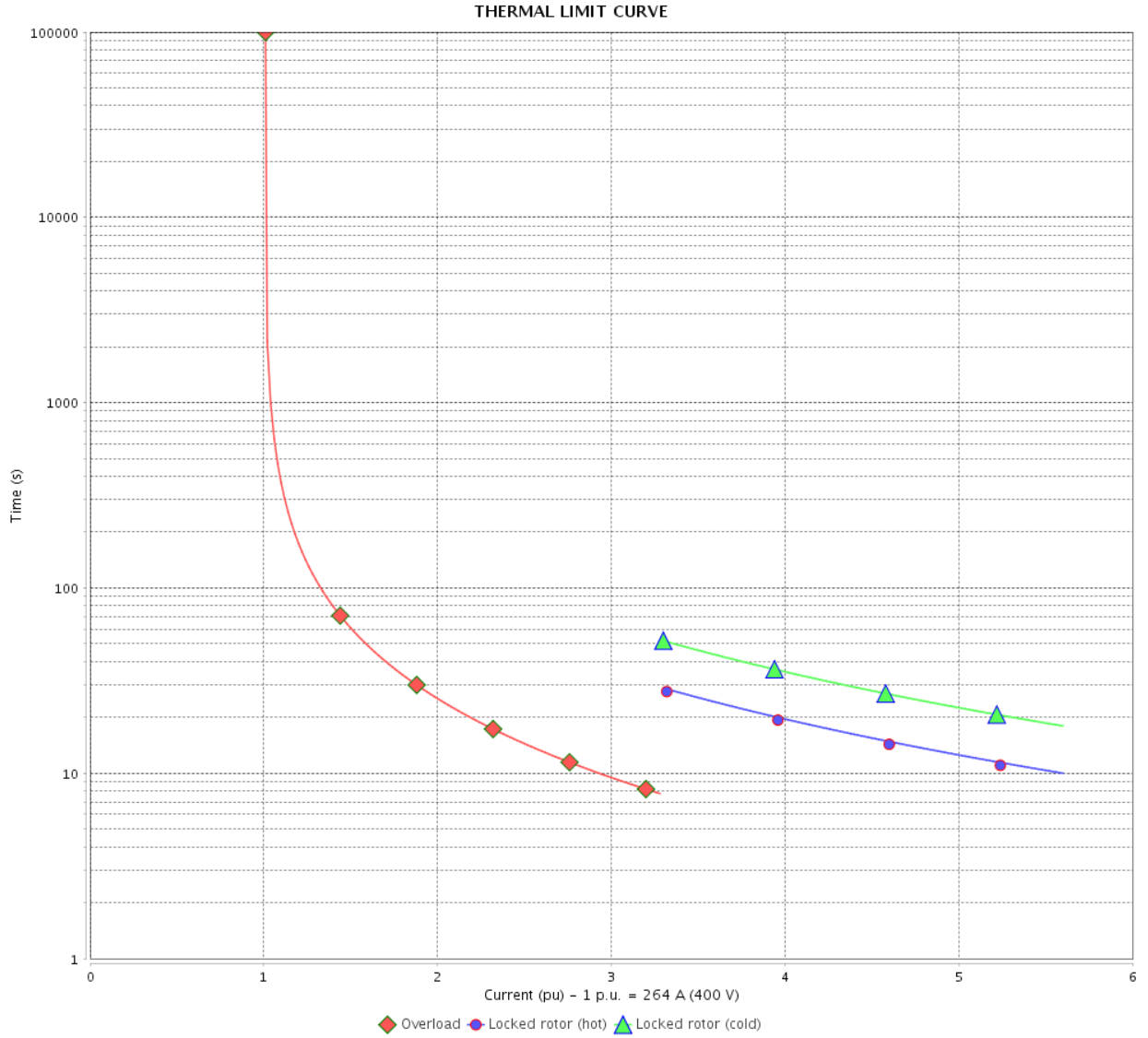

Rev.	Changes Summary	Performed	Checked	Date
Performed by		Page		Revision
Checked by		15 / 21		
Date	14/04/2022			

THERMAL LIMIT CURVE

Three Phase Induction Motor - Squirrel Cage



Customer :

Product line : NEMA Premium Efficiency Three-Phase
Product code : 12389902
Catalog # : 20018ST3QIERB447T-W2

Performance : 415 V 50 Hz 4P IE2

Rated current	: 257 A	Moment of inertia (J)	: 76.2 sq.ft.lb
LRC	: 6.1	Duty cycle	: Cont.(S1)
Rated torque	: 710 ft.lb	Insulation class	: F
Locked rotor torque	: 210 %	Service factor	: 1.00
Breakdown torque	: 240 %	Temperature rise	: 105 K
Rated speed	: 1480 rpm	Design	: B

Heating constant

Cooling constant

Rev.	Changes Summary	Performed	Checked	Date
Performed by				
Checked by			Page	Revision
Date	14/04/2022		16 / 21	

THERMAL LIMIT CURVE

Three Phase Induction Motor - Squirrel Cage



Customer : _____

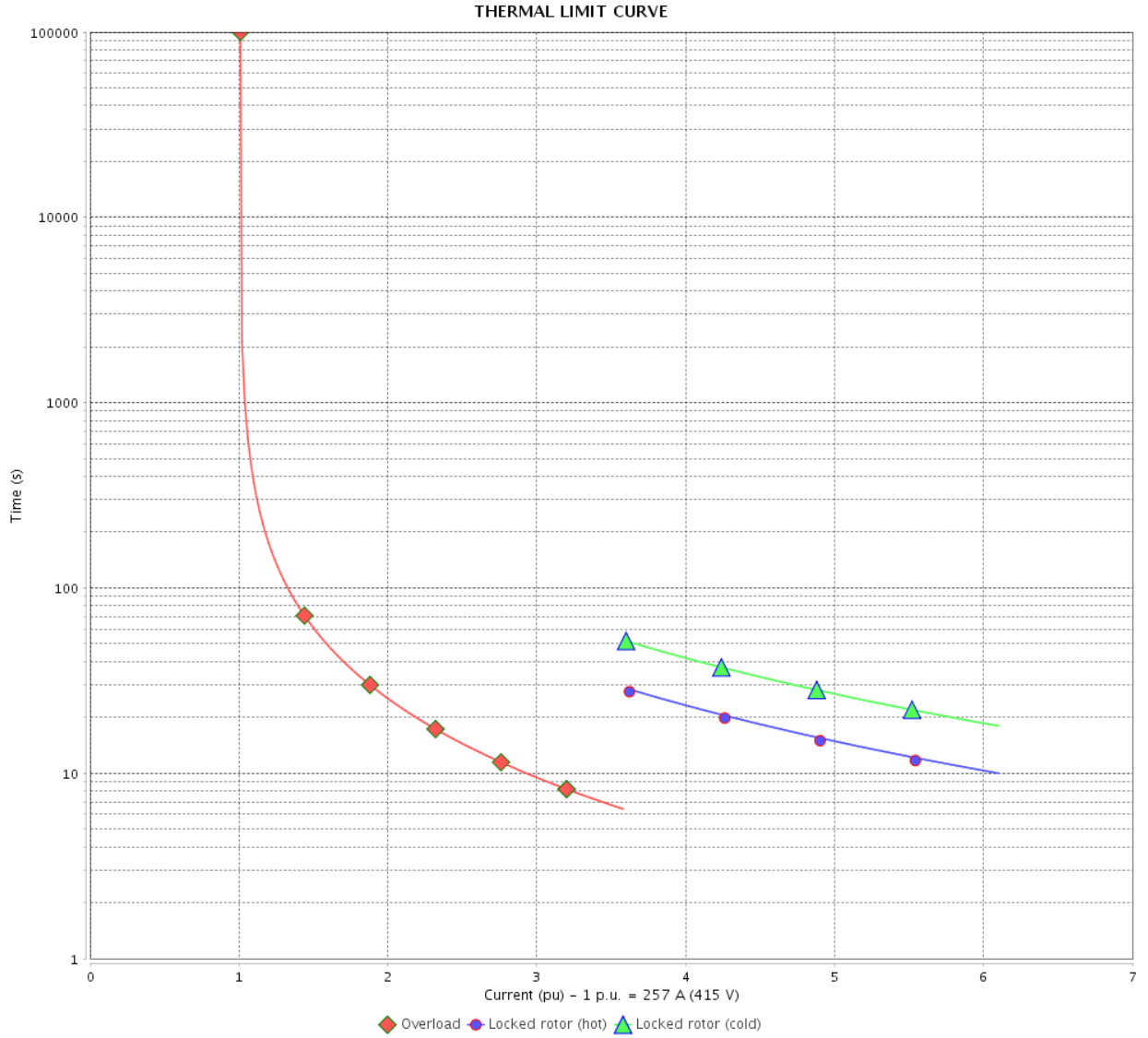

Rev.	Changes Summary	Performed	Checked	Date
Performed by				
Checked by				
Date				
			Page	Revision
			17 / 21	

VFD OPERATION CURVE

Three Phase Induction Motor - Squirrel Cage



Customer : _____

Product line : NEMA Premium Efficiency Three-Phase

Product code : 12389902

Catalog # : 20018ST3QIERB447T-W2

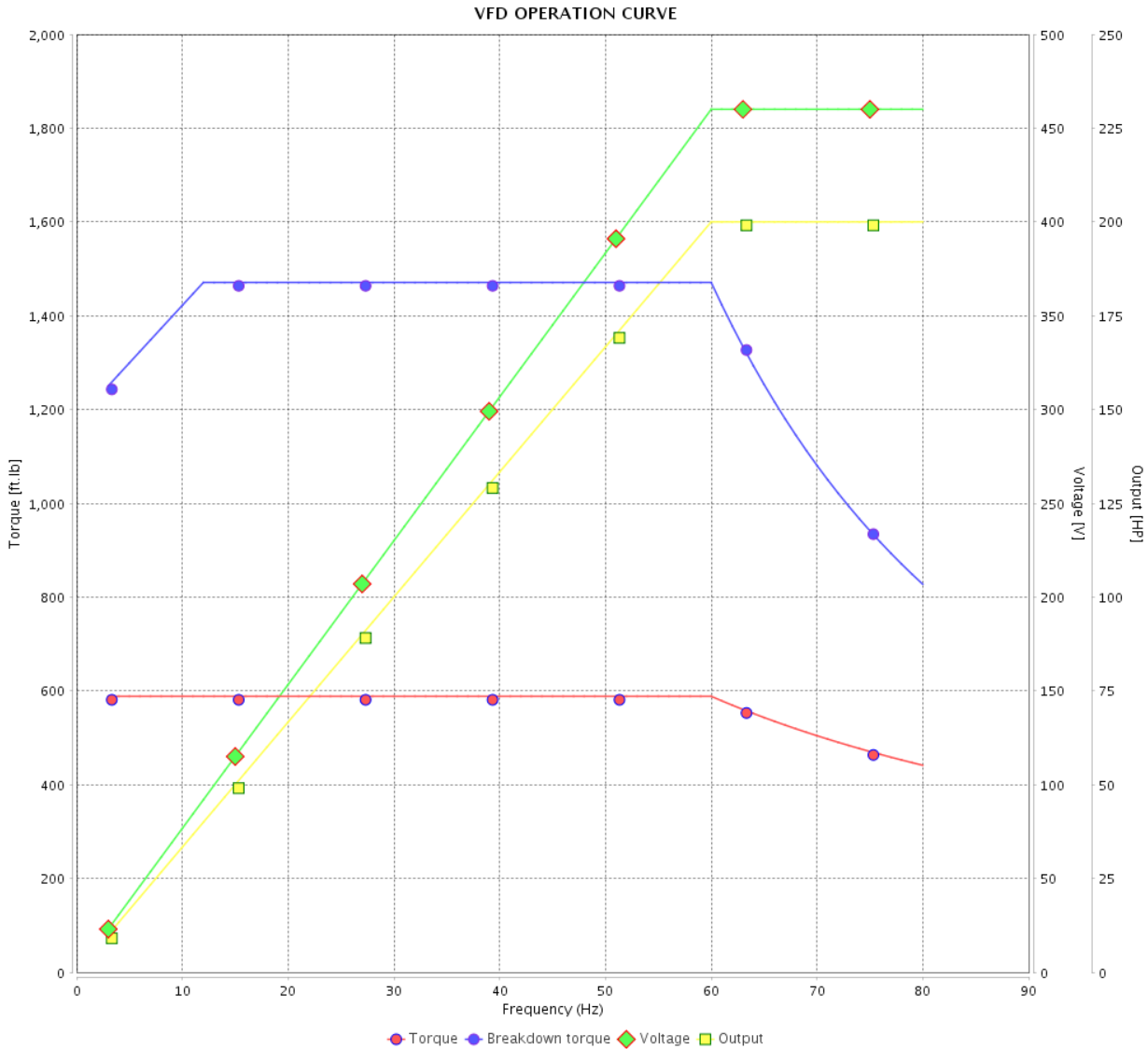

Performance : 460 V 60 Hz 4P

Rated current : 230 A
 LRC : 6.8
 Rated torque : 588 ft.lb
 Locked rotor torque : 229 %
 Breakdown torque : 250 %
 Rated speed : 1785 rpm

Moment of inertia (J) : 76.2 sq.ft.lb
 Duty cycle : Cont.(S1)
 Insulation class : F
 Service factor : 1.15
 Temperature rise : 80 K
 Design : B

Rev.	Changes Summary	Performed	Checked	Date
Performed by			Page 18 / 21	Revision
Checked by				
Date	14/04/2022			

VFD OPERATION CURVE

Three Phase Induction Motor - Squirrel Cage



Customer :

Product line : NEMA Premium Efficiency Three-Phase

Product code : 12389902

Catalog # : 20018ST3QIERB447T-W2

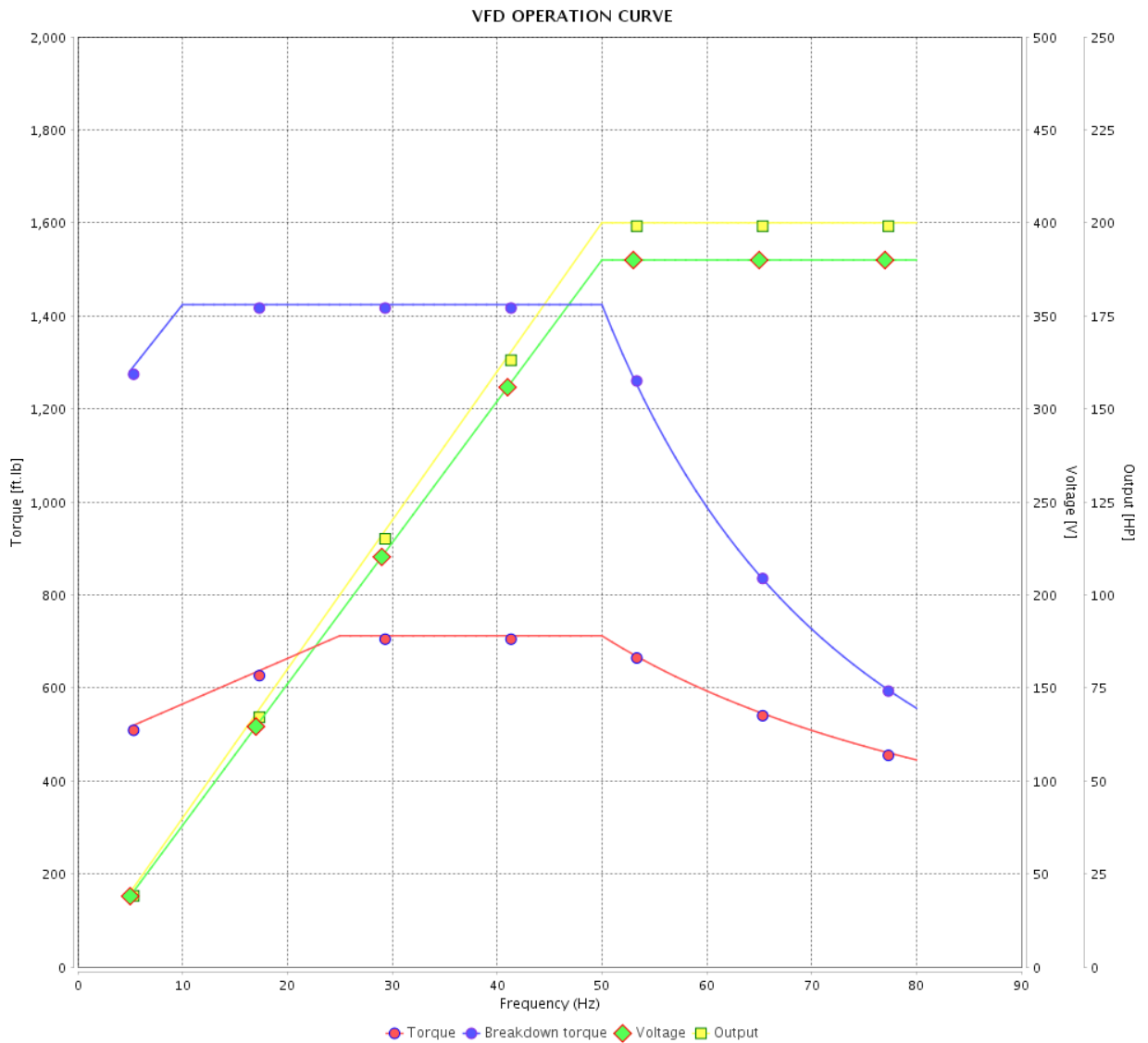

Performance : 380 V 50 Hz 4P IE2

Rated current : 279 A
 LRC : 5.1
 Rated torque : 712 ft.lb
 Locked rotor torque : 170 %
 Breakdown torque : 200 %
 Rated speed : 1475 rpm

Moment of inertia (J) : 76.2 sq.ft.lb
 Duty cycle : Cont.(S1)
 Insulation class : F
 Service factor : 1.00
 Temperature rise : 105 K
 Design : B

Rev.	Changes Summary	Performed	Checked	Date
Performed by			Page	Revision
Checked by			19 / 21	
Date	14/04/2022			

VFD OPERATION CURVE

Three Phase Induction Motor - Squirrel Cage



Customer : _____

Product line : NEMA Premium Efficiency Three-Phase

Product code : 12389902

Catalog # : 20018ST3QIERB447T-W2

VFD OPERATION CURVE

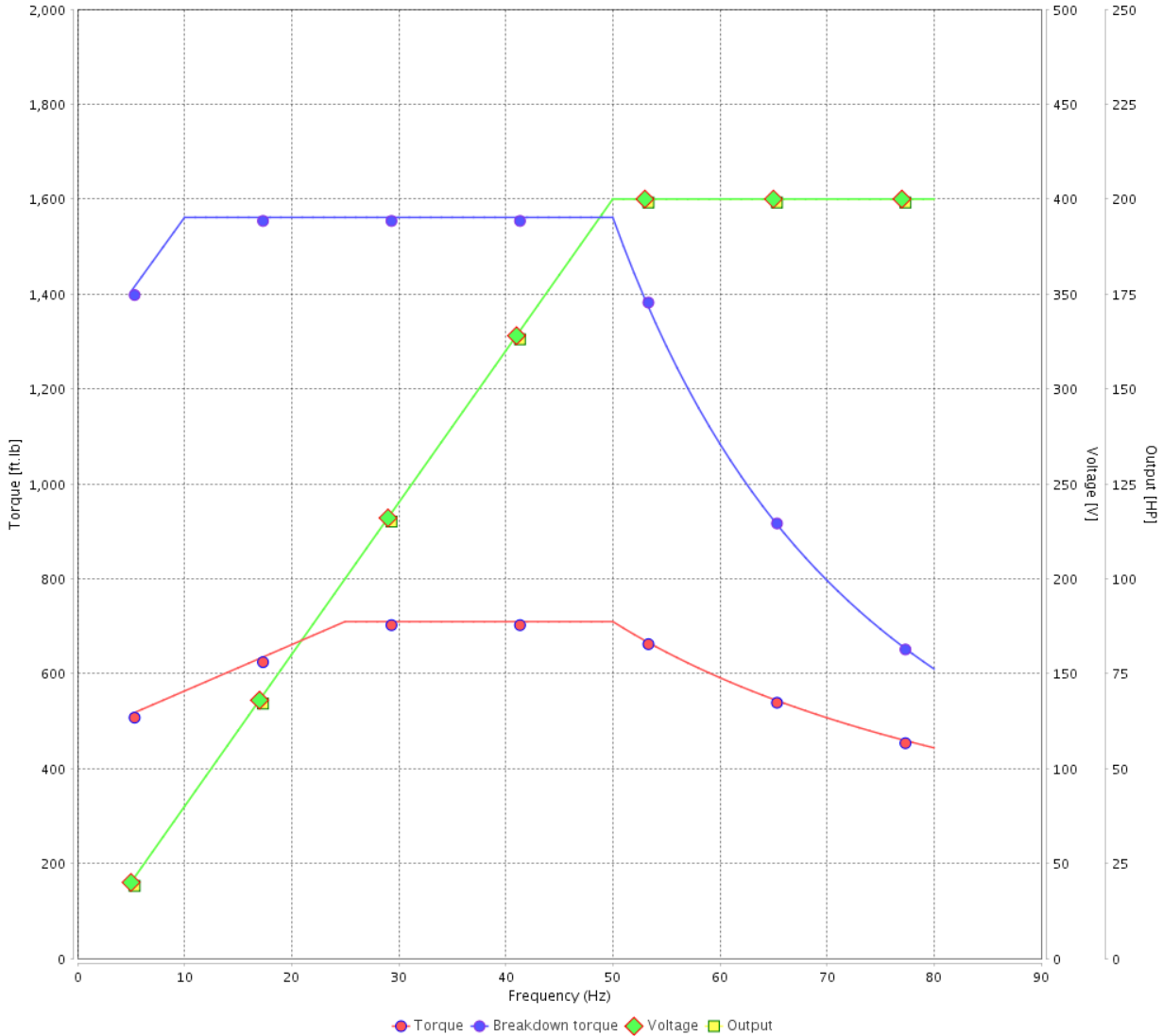

Performance : 400 V 50 Hz 4P IE2

Rated current : 264 A
 LRC : 5.6
 Rated torque : 710 ft.lb
 Locked rotor torque : 190 %
 Breakdown torque : 220 %
 Rated speed : 1480 rpm

Moment of inertia (J) : 76.2 sq.ft.lb
 Duty cycle : Cont.(S1)
 Insulation class : F
 Service factor : 1.00
 Temperature rise : 105 K
 Design : B

Rev.	Changes Summary	Performed	Checked	Date
Performed by			Page 20 / 21	Revision
Checked by				
Date	14/04/2022			

VFD OPERATION CURVE

Three Phase Induction Motor - Squirrel Cage



Customer :

Product line : NEMA Premium Efficiency Three-Phase

Product code : 12389902

Catalog # : 20018ST3QIERB447T-W2

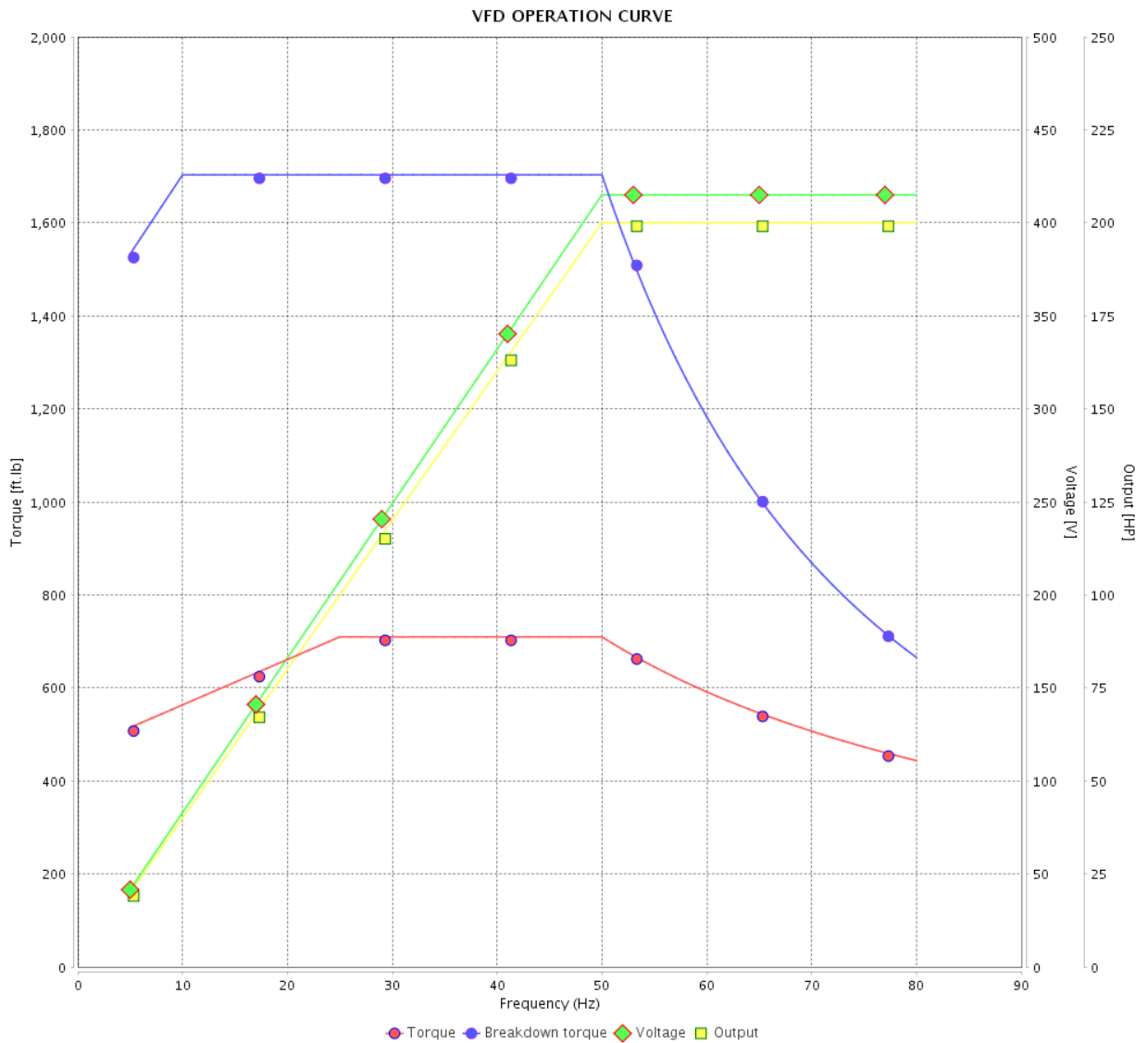

Performance : 415 V 50 Hz 4P IE2

Rated current : 257 A
 LRC : 6.1
 Rated torque : 710 ft.lb
 Locked rotor torque : 210 %
 Breakdown torque : 240 %
 Rated speed : 1480 rpm

Moment of inertia (J) : 76.2 sq.ft.lb
 Duty cycle : Cont.(S1)
 Insulation class : F
 Service factor : 1.00
 Temperature rise : 105 K
 Design : B

Rev.	Changes Summary	Performed	Checked	Date
Performed by				Page 21 / 21
Checked by				
Date	14/04/2022			

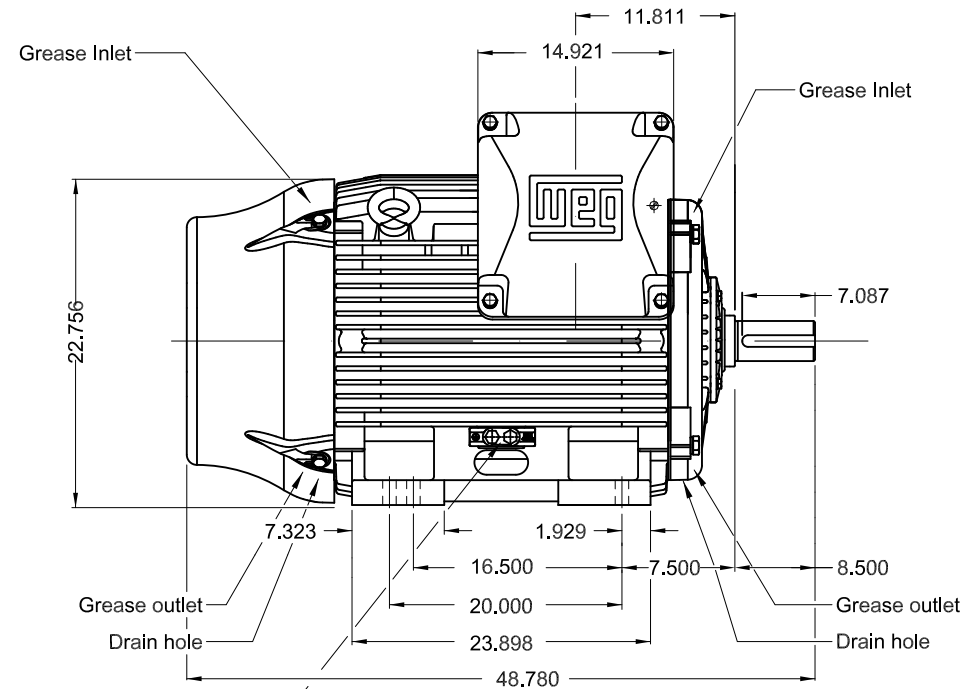
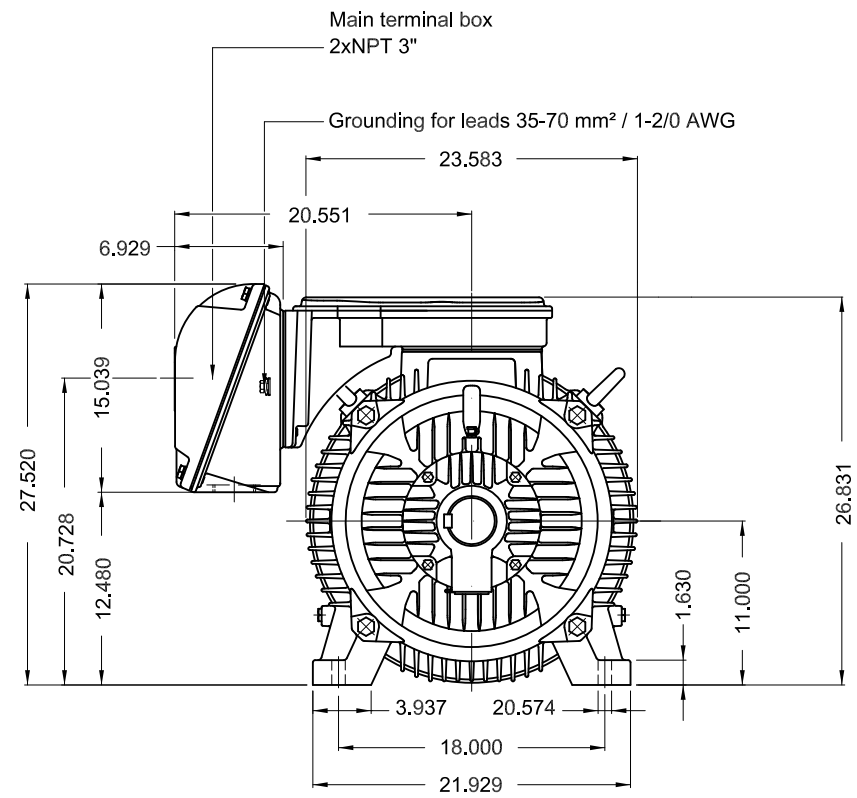

Grounding for leads 25-185 mm² / 3AWG-350MCM

200 HP 04 Poles 60 Hz

A

- Bronze fan
- DE roller bearing
- Shaft locking device
- Color RAL 5009
- Painting plan 202E
- Mounting B3R(D)

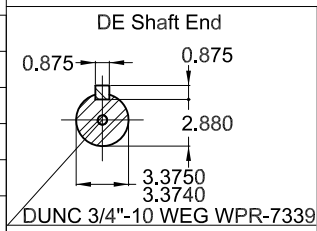

ECM	LOC	SUMMARY OF MODIFICATIONS	EXECUTED	CHECKED	RELEASED	DATE	VER
EXECUTED	PIRWBUSER	THREE PH. MOTOR IEEE 841 W22 PREM. EFF.					
CHECKED		FRAME 445/7T IP55 TEFC					
RELEASED							
REL DT.	WMO	Jaragua do Sul	Product Engineering				

PREVIEW
WDD



SHEET 1 / 1

Dimensions in inches

XME A3



NEMA
Premium
W22



FOR SAFE AREA
Mod.TE1BFOXON
CC029A



Class I, Div 2, Gr A, B, C and D - T3
Class I, Zone 2, IIC - T3
Class II, Div 2, Gr F and G - T3C
For use on PWM: Gr. A, B, C, D and F,
VT 1000:1, CT 20:1, 1.00SF - T3

MODEL 20018ST3QIERB447T-W2

Inverter Duty Motor
Severe Duty



PH3 60Hz Fr. 445/7T 1000m.a.s.l. IP55 TEFC 2239lb

V 460

A 230

HP 200

kW 150

SF 1.15

SFA 265

RPM 1785

PF 0.85

AMB 40°C

INS cl. F DT80K

NEMA NOM EFF 96.2%

DUTY CONT.

DES B Code G

GUARANT. EFF 95.4%

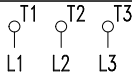

460V



→ NU-319-C3 (45g) 95RU03X30

→ 6316-C3 (34g) 80BC03X30



MOBIL POLYREX EM (5000h)

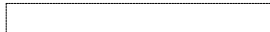

MADE IN BRAZIL
12389902