

DATA SHEET



Three Phase Induction Motor - Squirrel Cage

Customer								
Product line	: NEMA Premium Efficiency Three-Phase	Product code	: 11431289					
		Catalog #	: 20036ET3G447TS-W22					
Frame	: 445/7TS	Cooling method	: IC411 - TEFC					
Insulation class	: F	Mounting	: F-1					
Duty cycle	: Cont.(S1)	Rotation ¹	: Both (CW and CCW)					
Ambient temperature	: -20°C to +40°C	Starting method	: Direct On Line					
Altitude	: 1000 m.a.s.l.	Approx. weight ²	: 2047 lb					
Protection degree	: IP55	Moment of inertia (J)	: 44.7 sq.ft.lb					
Design	: B							
Output [HP]	200	150	150	150	200	200	200	
Poles	2	2	2	2	2	2	2	
Frequency [Hz]	60	50	50	50	50	50	50	
Rated voltage [V]	460	380	400	415	380	400	415	
Rated current [A]	219	193	183	178	268	253	244	
L. R. Amperes [A]	1424	1312	1391	1477	1447	1543	1635	
LRC [A]	6.5x(Code G)	6.8x(Code G)	7.6x(Code H)	8.3x(Code H)	5.4x(Code E)	6.1x(Code F)	6.7x(Code G)	
No load current [A]	45.0	44.0	47.0	49.3	42.0	45.0	47.0	
Rated speed [RPM]	3570	2975	2980	2980	2960	2965	2970	
Slip [%]	0.83	0.83	0.67	0.67	1.33	1.17	1.00	
Rated torque [ft.lb]	294	265	264	264	355	354	354	
Locked rotor torque [%]	210	210	220	229	160	180	200	
Breakdown torque [%]	229	260	290	320	190	220	229	
Service factor	1.15	1.15	1.15	1.15	1.00	1.00	1.00	
Temperature rise	80 K	80 K	80 K	80 K	105 K	105 K	105 K	
Locked rotor time	25s (cold) 14s (hot)	50s (cold) 28s (hot)	46s (cold) 26s (hot)	43s (cold) 24s (hot)	18s (cold) 10s (hot)	18s (cold) 10s (hot)	18s (cold) 10s (hot)	
Noise level ²	81.0 dB(A)							
Efficiency (%)	25%	94.9	94.9	94.9	94.9	95.3	94.9	95.2
	50%	95.0	95.0	95.0	95.0	95.0	95.0	95.0
	75%	95.4	95.2	95.3	95.3	95.0	95.0	95.4
	100%	95.4	95.2	95.3	95.3	94.5	95.0	95.0
Power Factor	25%	0.64	0.63	0.59	0.57	0.70	0.67	0.65
	50%	0.86	0.85	0.83	0.82	0.88	0.87	0.86
	75%	0.89	0.90	0.89	0.88	0.90	0.89	0.89
	100%	0.90	0.91	0.91	0.90	0.90	0.90	0.90
Bearing type	: Drive end : 6314 C3	Non drive end : 6314 C3	Foundation loads					
Sealing	: WSeal	WSeal	Max. traction : 1144 lb					
Lubrication interval	: 4000 h	4000 h	Max. compression : 3191 lb					
Lubricant amount	: 27 g	27 g						
Lubricant type	: Mobil Polyrex EM							
Notes								
This revision replaces and cancel the previous one, which must be eliminated. (1) Looking the motor from the shaft end. (2) Measured at 1m and with tolerance of +3dB(A). (3) Approximate weight subject to changes after manufacturing process. (4) At 100% of full load.				These are average values based on tests with sinusoidal power supply, subject to the tolerances stipulated in NEMA MG-1.				
Rev.	Changes Summary			Performed	Checked	Date		
Performed by								
Checked by					Page	Revision		
Date	14/04/2022				1 / 36			

TORQUE AND CURRENT VS SPEED CURVE

Three Phase Induction Motor - Squirrel Cage



Customer :

Product line : NEMA Premium Efficiency Three-Phase

Product code : 11431289

Catalog # : 20036ET3G447TS-W22

TORQUE AND CURRENT VS SPEED CURVE

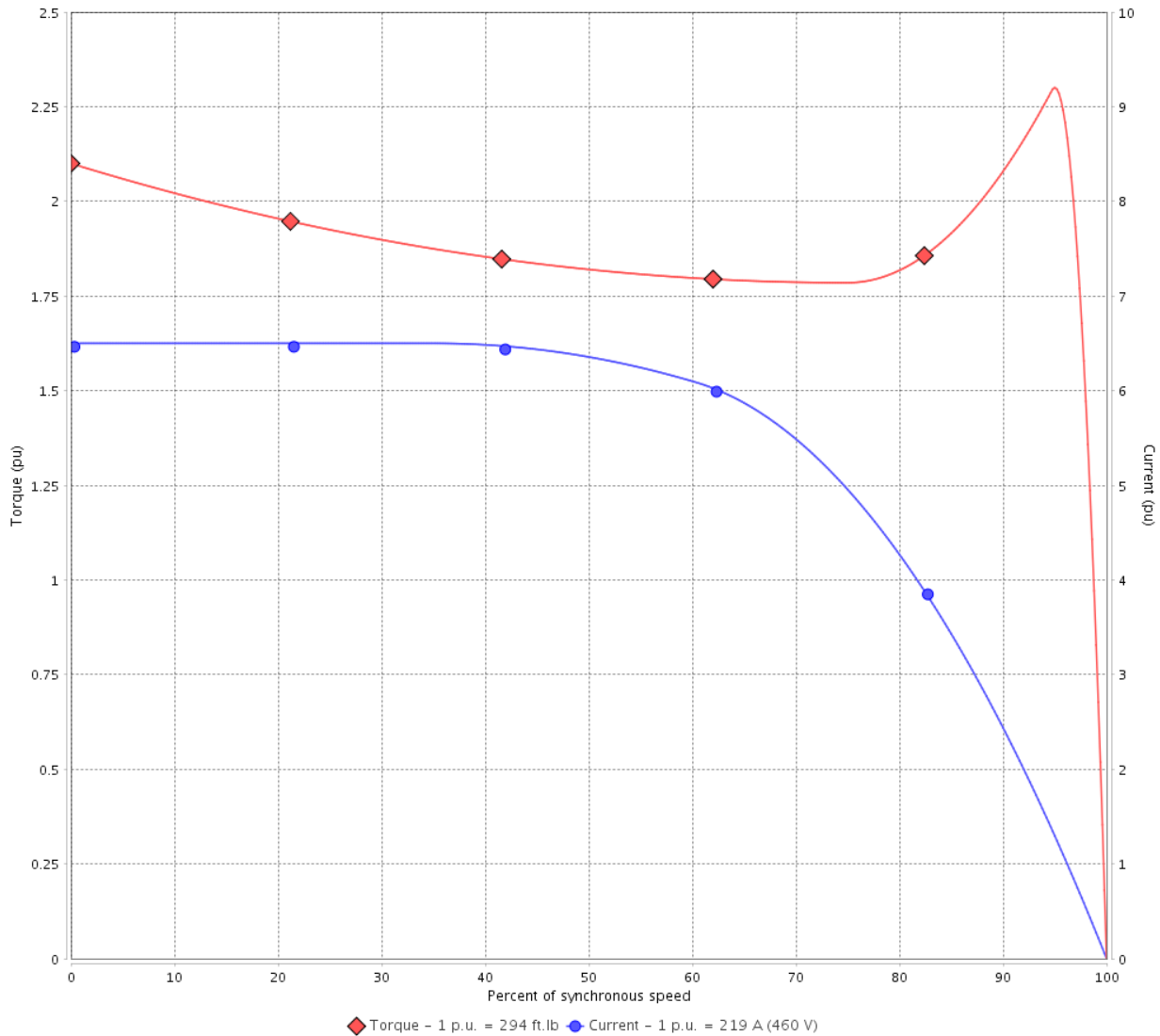

Performance : 460 V 60 Hz 2P

Rated current	: 219 A	Moment of inertia (J)	: 44.7 sq.ft.lb
LRC	: 6.5	Duty cycle	: Cont.(S1)
Rated torque	: 294 ft.lb	Insulation class	: F
Locked rotor torque	: 210 %	Service factor	: 1.15
Breakdown torque	: 229 %	Temperature rise	: 80 K
Rated speed	: 3570 rpm	Design	: B

Locked rotor time : 25s (cold) 14s (hot)

Rev.	Changes Summary	Performed	Checked	Date
Performed by			Page 2 / 36	Revision
Checked by				
Date	14/04/2022			

TORQUE AND CURRENT VS SPEED CURVE



Three Phase Induction Motor - Squirrel Cage

Customer :

Product line : NEMA Premium Efficiency Three-Phase

Product code : 11431289

Catalog # : 20036ET3G447TS-W22

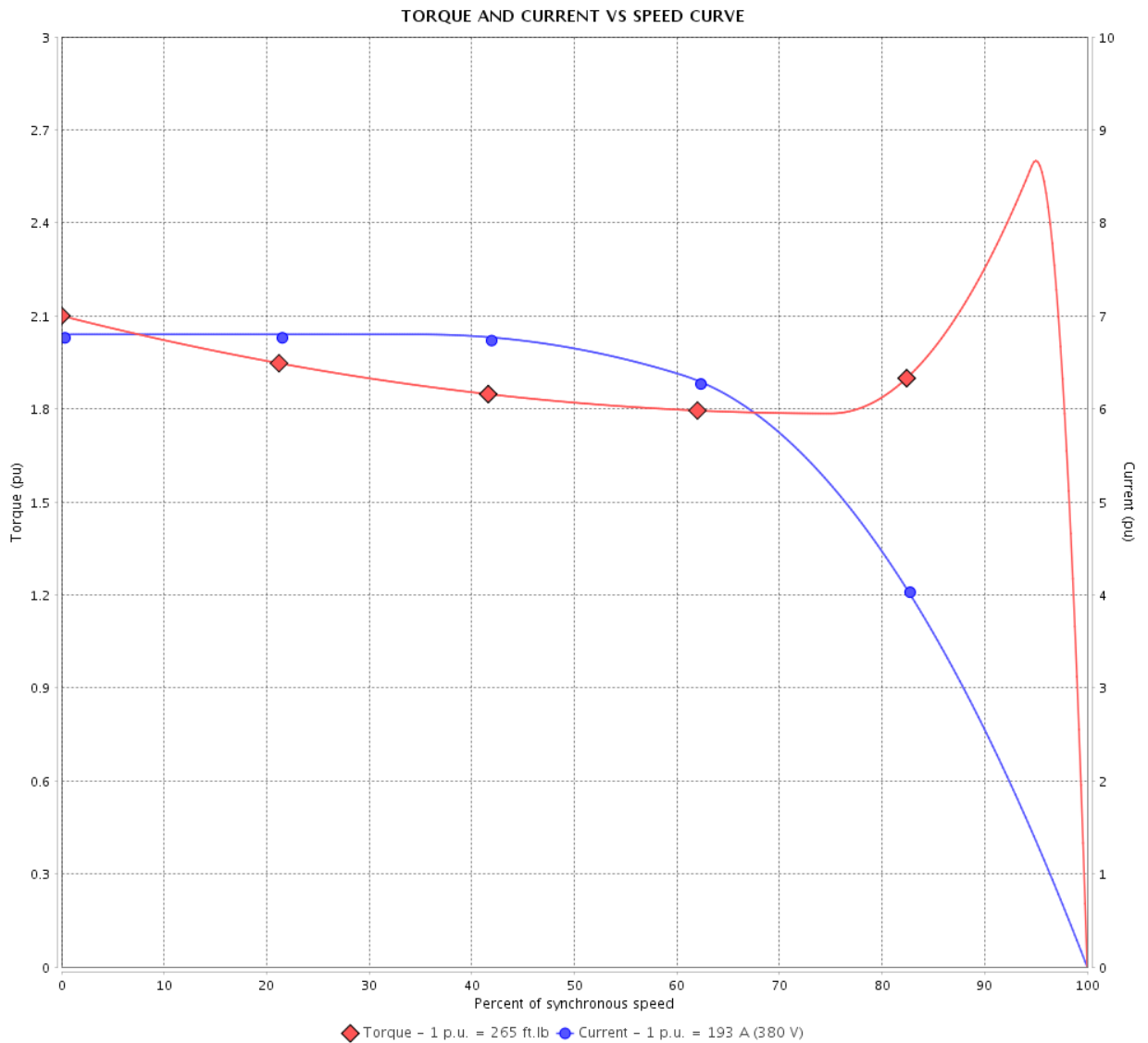

Performance : 380 V 50 Hz 2P IE3

Rated current	: 193 A	Moment of inertia (J)	: 44.7 sq.ft.lb
LRC	: 6.8	Duty cycle	: Cont.(S1)
Rated torque	: 265 ft.lb	Insulation class	: F
Locked rotor torque	: 210 %	Service factor	: 1.15
Breakdown torque	: 260 %	Temperature rise	: 80 K
Rated speed	: 2975 rpm	Design	: B

Locked rotor time : 50s (cold) 28s (hot)

Rev.	Changes Summary	Performed	Checked	Date
Performed by			Page 3 / 36	Revision
Checked by				
Date	14/04/2022			

TORQUE AND CURRENT VS SPEED CURVE

Three Phase Induction Motor - Squirrel Cage



Customer :

Product line : NEMA Premium Efficiency Three-Phase

Product code : 11431289

Catalog # : 20036ET3G447TS-W22

TORQUE AND CURRENT VS SPEED CURVE

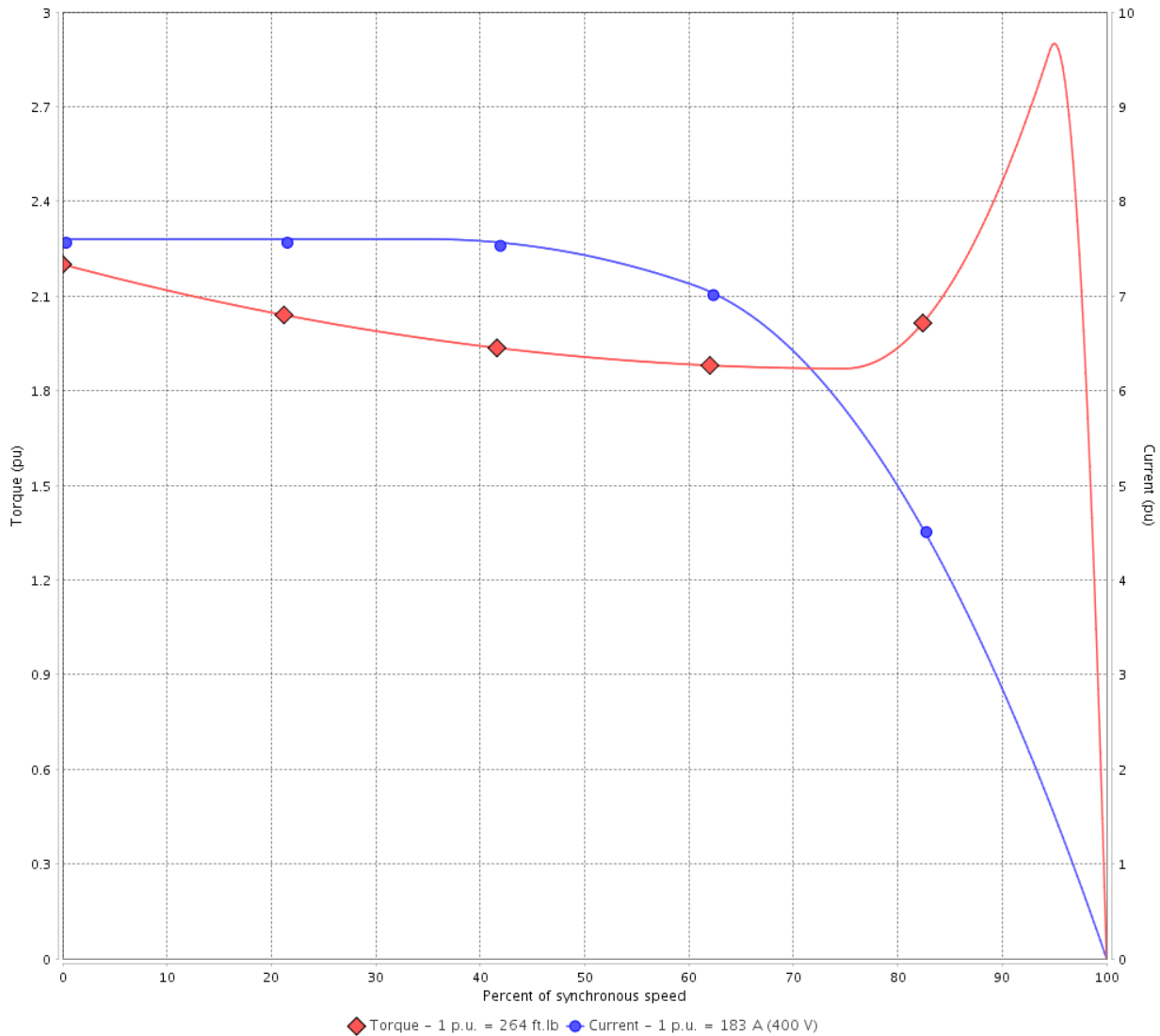

Performance : 400 V 50 Hz 2P IE3

Rated current	: 183 A	Moment of inertia (J)	: 44.7 sq.ft.lb
LRC	: 7.6	Duty cycle	: Cont.(S1)
Rated torque	: 264 ft.lb	Insulation class	: F
Locked rotor torque	: 220 %	Service factor	: 1.15
Breakdown torque	: 290 %	Temperature rise	: 80 K
Rated speed	: 2980 rpm	Design	: B

Locked rotor time : 46s (cold) 26s (hot)

Rev.	Changes Summary	Performed	Checked	Date
Performed by			Page 4 / 36	Revision
Checked by				
Date	14/04/2022			

TORQUE AND CURRENT VS SPEED CURVE



Three Phase Induction Motor - Squirrel Cage

Customer :

Product line : NEMA Premium Efficiency Three-Phase

Product code : 11431289

Catalog # : 20036ET3G447TS-W22

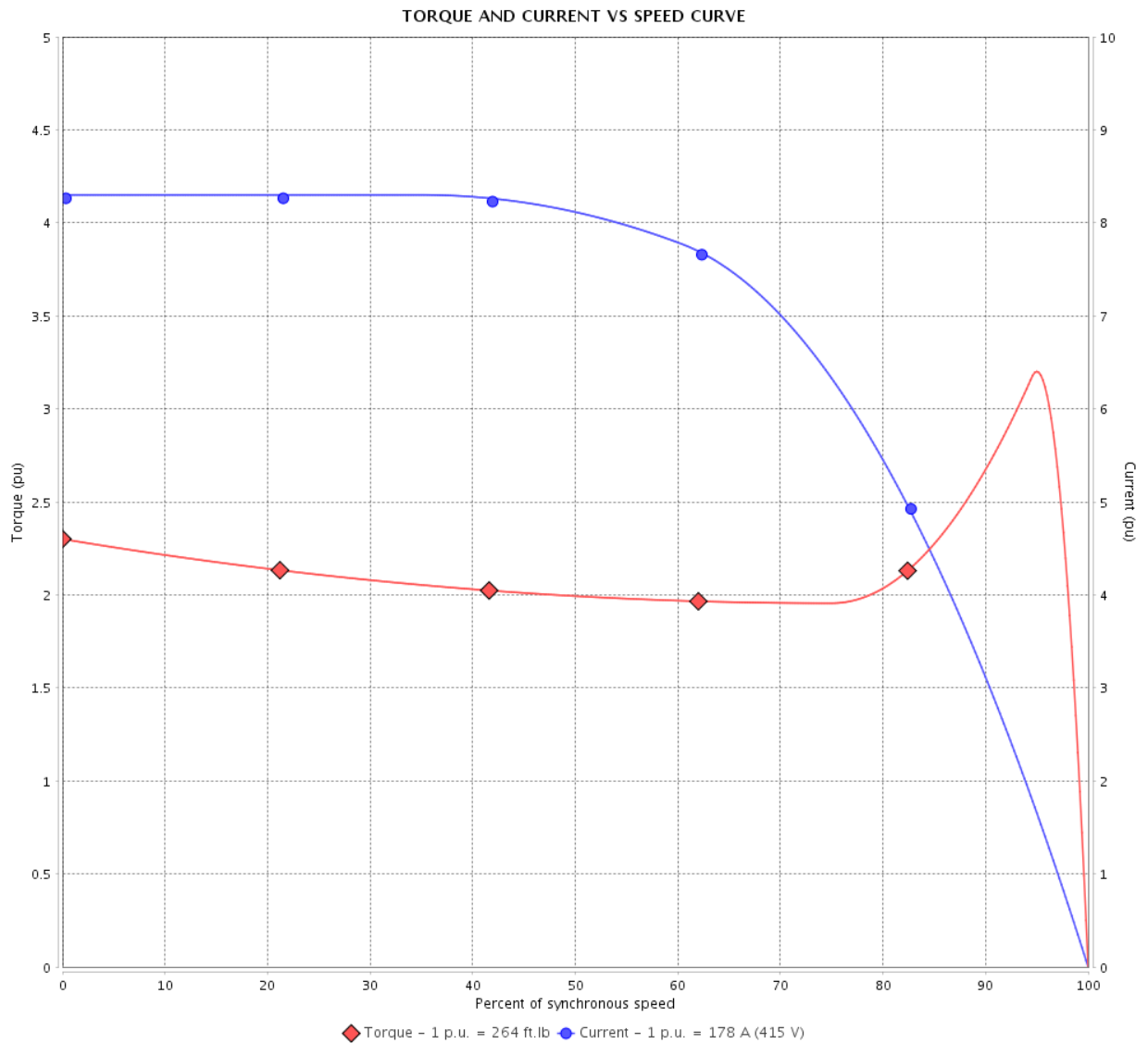

Performance : 415 V 50 Hz 2P IE3

Rated current	: 178 A	Moment of inertia (J)	: 44.7 sq.ft.lb
LRC	: 8.3	Duty cycle	: Cont.(S1)
Rated torque	: 264 ft.lb	Insulation class	: F
Locked rotor torque	: 229 %	Service factor	: 1.15
Breakdown torque	: 320 %	Temperature rise	: 80 K
Rated speed	: 2980 rpm	Design	: B

Locked rotor time : 43s (cold) 24s (hot)

Rev.	Changes Summary	Performed	Checked	Date
Performed by			Page	Revision
Checked by				
Date	14/04/2022			
			5 / 36	

TORQUE AND CURRENT VS SPEED CURVE

Three Phase Induction Motor - Squirrel Cage



Customer :

Product line : NEMA Premium Efficiency Three-Phase

Product code : 11431289

Catalog # : 20036ET3G447TS-W22

TORQUE AND CURRENT VS SPEED CURVE

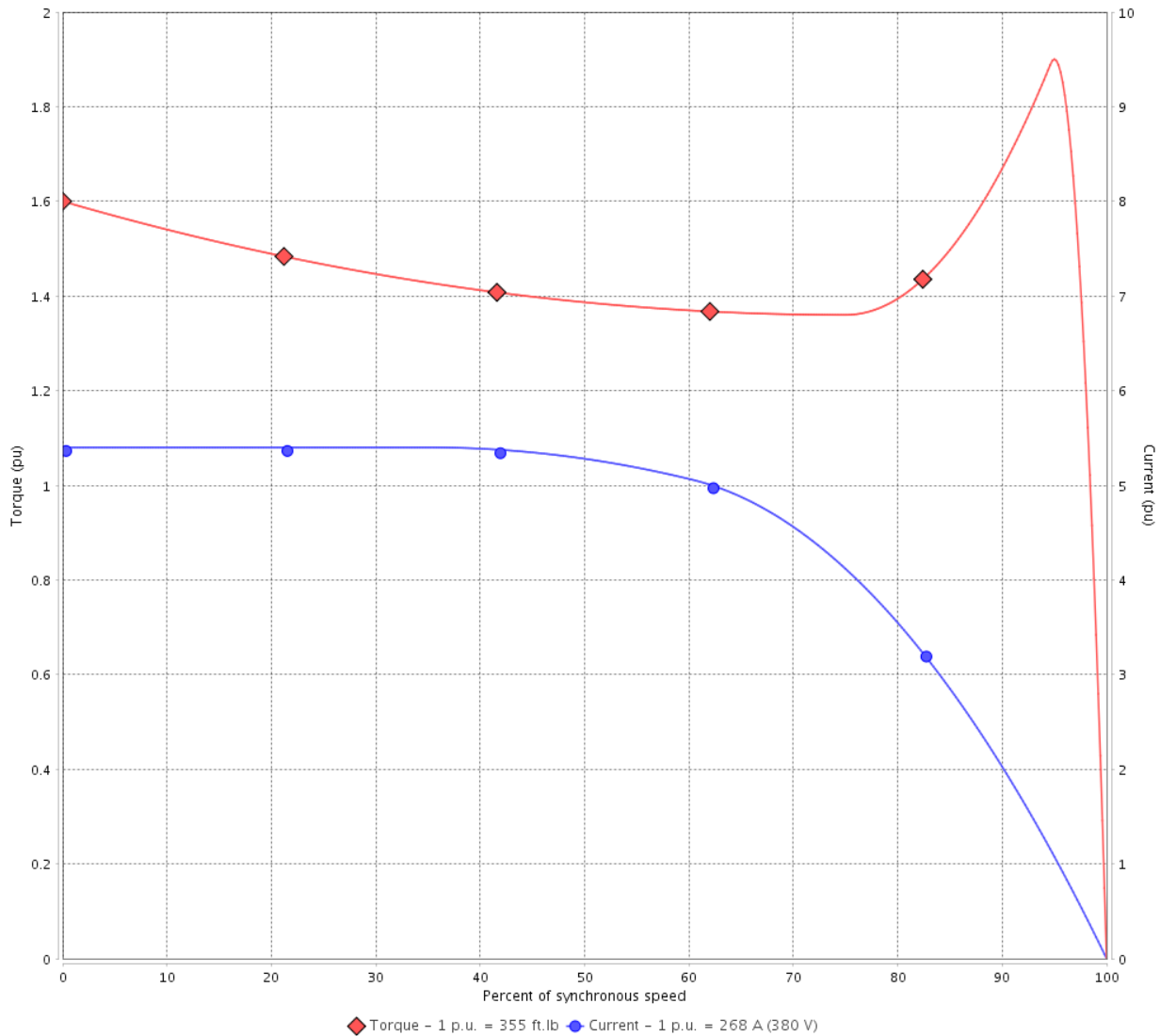

Performance : 380 V 50 Hz 2P IE1

Rated current	: 268 A	Moment of inertia (J)	: 44.7 sq.ft.lb
LRC	: 5.4	Duty cycle	: Cont.(S1)
Rated torque	: 355 ft.lb	Insulation class	: F
Locked rotor torque	: 160 %	Service factor	: 1.00
Breakdown torque	: 190 %	Temperature rise	: 105 K
Rated speed	: 2960 rpm	Design	: B

Locked rotor time : 18s (cold) 10s (hot)

Rev.	Changes Summary	Performed	Checked	Date
Performed by			Page 6 / 36	Revision
Checked by				
Date	14/04/2022			

TORQUE AND CURRENT VS SPEED CURVE



Three Phase Induction Motor - Squirrel Cage

Customer :

Product line : NEMA Premium Efficiency Three-Phase

Product code : 11431289

Catalog # : 20036ET3G447TS-W22

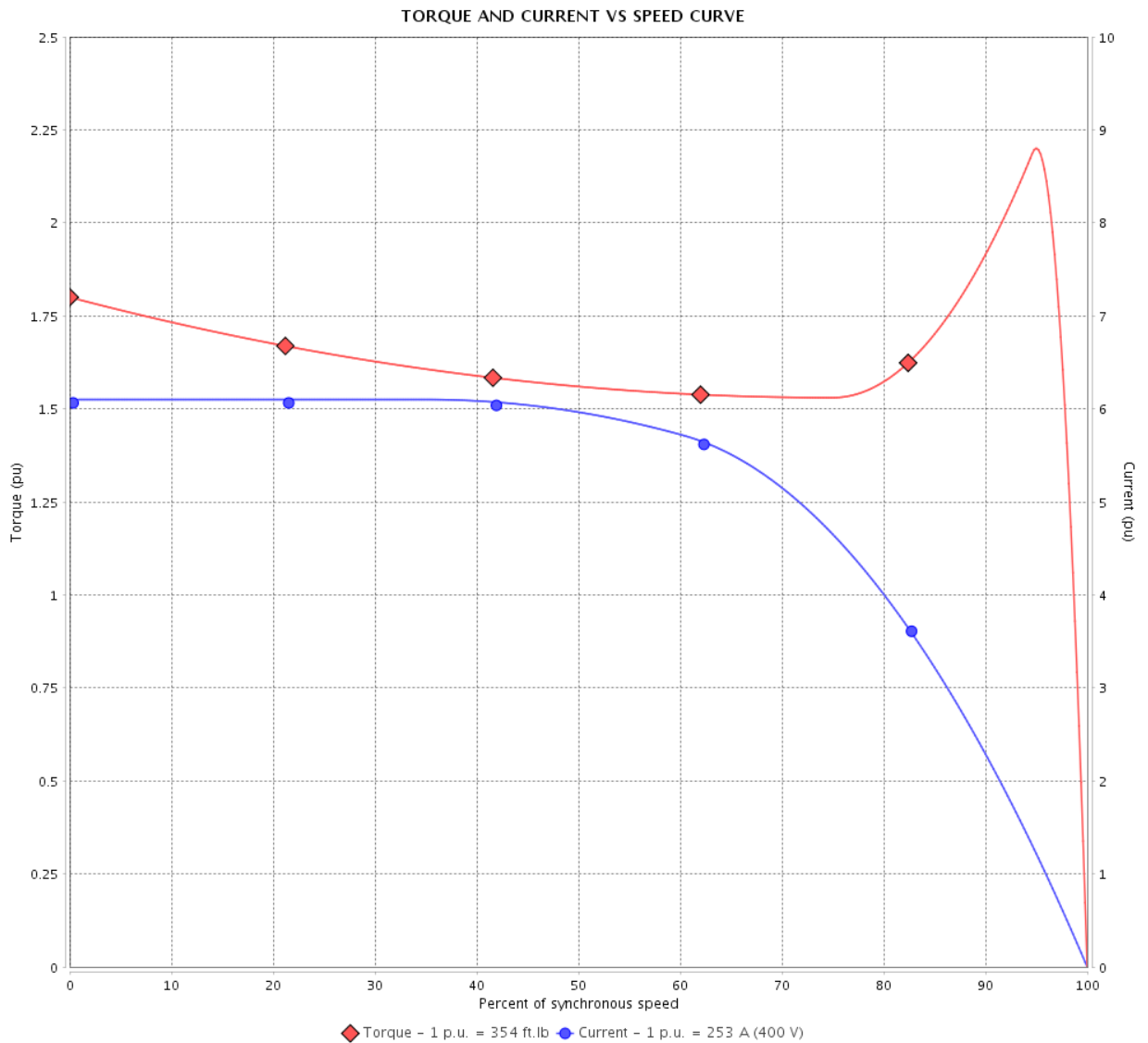

Performance : 400 V 50 Hz 2P IE2

Rated current	: 253 A	Moment of inertia (J)	: 44.7 sq.ft.lb
LRC	: 6.1	Duty cycle	: Cont.(S1)
Rated torque	: 354 ft.lb	Insulation class	: F
Locked rotor torque	: 180 %	Service factor	: 1.00
Breakdown torque	: 220 %	Temperature rise	: 105 K
Rated speed	: 2965 rpm	Design	: B

Locked rotor time : 18s (cold) 10s (hot)

Rev.	Changes Summary	Performed	Checked	Date
Performed by			Page 7 / 36	Revision
Checked by				
Date	14/04/2022			

TORQUE AND CURRENT VS SPEED CURVE

Three Phase Induction Motor - Squirrel Cage



Customer :

Product line : NEMA Premium Efficiency Three-Phase

Product code : 11431289

Catalog # : 20036ET3G447TS-W22

TORQUE AND CURRENT VS SPEED CURVE

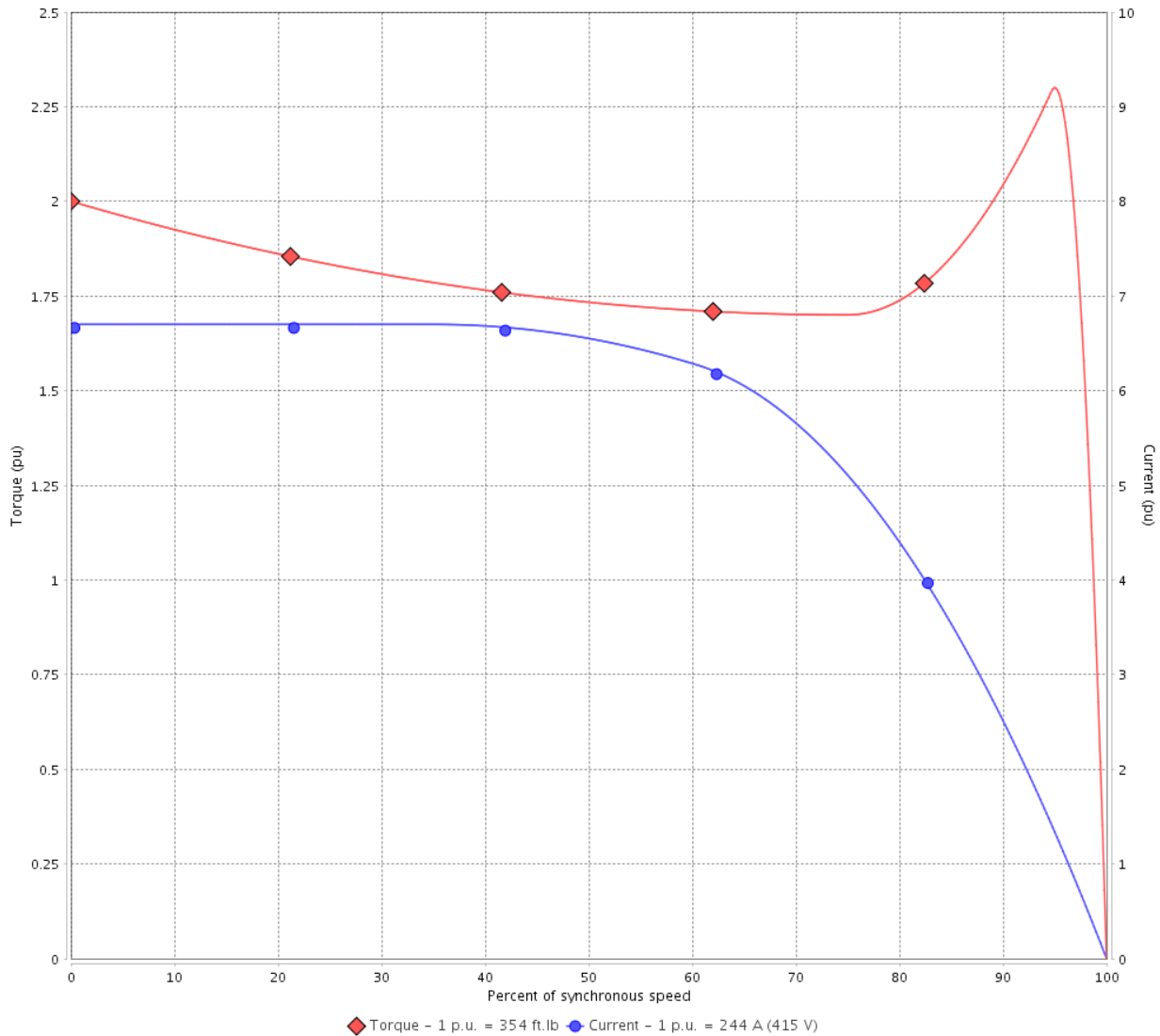

Performance : 415 V 50 Hz 2P IE2

Rated current	: 244 A	Moment of inertia (J)	: 44.7 sq.ft.lb
LRC	: 6.7	Duty cycle	: Cont.(S1)
Rated torque	: 354 ft.lb	Insulation class	: F
Locked rotor torque	: 200 %	Service factor	: 1.00
Breakdown torque	: 229 %	Temperature rise	: 105 K
Rated speed	: 2970 rpm	Design	: B

Locked rotor time : 18s (cold) 10s (hot)

Rev.	Changes Summary	Performed	Checked	Date
Performed by			Page 8 / 36	Revision
Checked by				
Date	14/04/2022			

LOAD PERFORMANCE CURVE

Three Phase Induction Motor - Squirrel Cage



Customer : _____

Product line : NEMA Premium Efficiency Three-Phase

Product code : 11431289

Catalog # : 20036ET3G447TS-W22

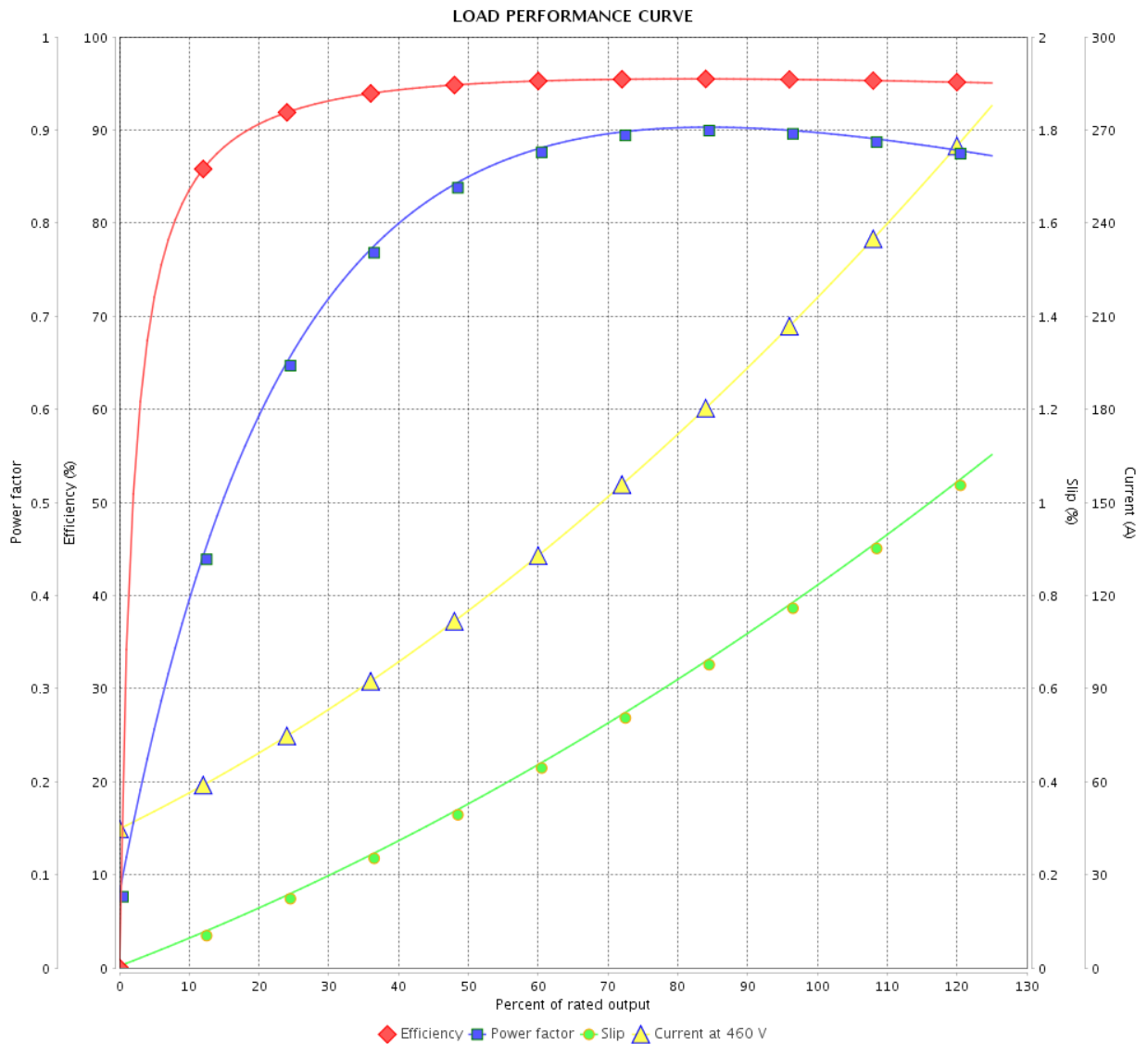

Performance : 460 V 60 Hz 2P

Rated current : 219 A
 LRC : 6.5
 Rated torque : 294 ft.lb
 Locked rotor torque : 210 %
 Breakdown torque : 229 %
 Rated speed : 3570 rpm

Moment of inertia (J) : 44.7 sq.ft.lb
 Duty cycle : Cont.(S1)
 Insulation class : F
 Service factor : 1.15
 Temperature rise : 80 K
 Design : B

Rev.	Changes Summary	Performed	Checked	Date
Performed by				
Checked by				
Date				
		Page	Revision	
		9 / 36		

LOAD PERFORMANCE CURVE

Three Phase Induction Motor - Squirrel Cage



Customer : _____

Product line : NEMA Premium Efficiency Three-Phase

Product code : 11431289

Catalog # : 20036ET3G447TS-W22

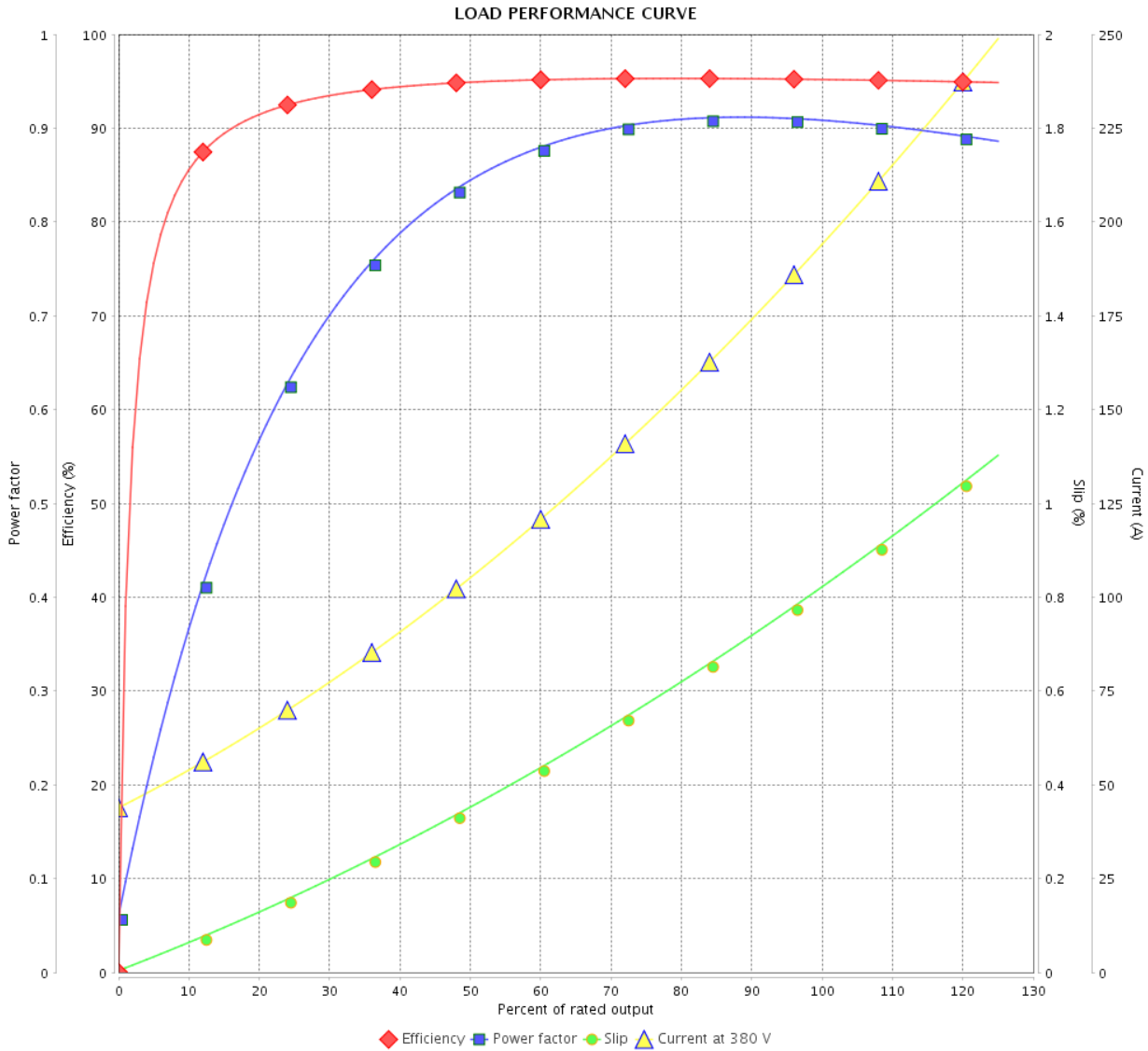

Performance : 380 V 50 Hz 2P IE3

Rated current : 193 A
 LRC : 6.8
 Rated torque : 265 ft.lb
 Locked rotor torque : 210 %
 Breakdown torque : 260 %
 Rated speed : 2975 rpm

Moment of inertia (J) : 44.7 sq.ft.lb
 Duty cycle : Cont.(S1)
 Insulation class : F
 Service factor : 1.15
 Temperature rise : 80 K
 Design : B

Rev.	Changes Summary	Performed	Checked	Date
Performed by			Page	Revision
Checked by				
Date				

LOAD PERFORMANCE CURVE

Three Phase Induction Motor - Squirrel Cage



Customer : _____

Product line : NEMA Premium Efficiency Three-Phase

Product code : 11431289

Catalog # : 20036ET3G447TS-W22

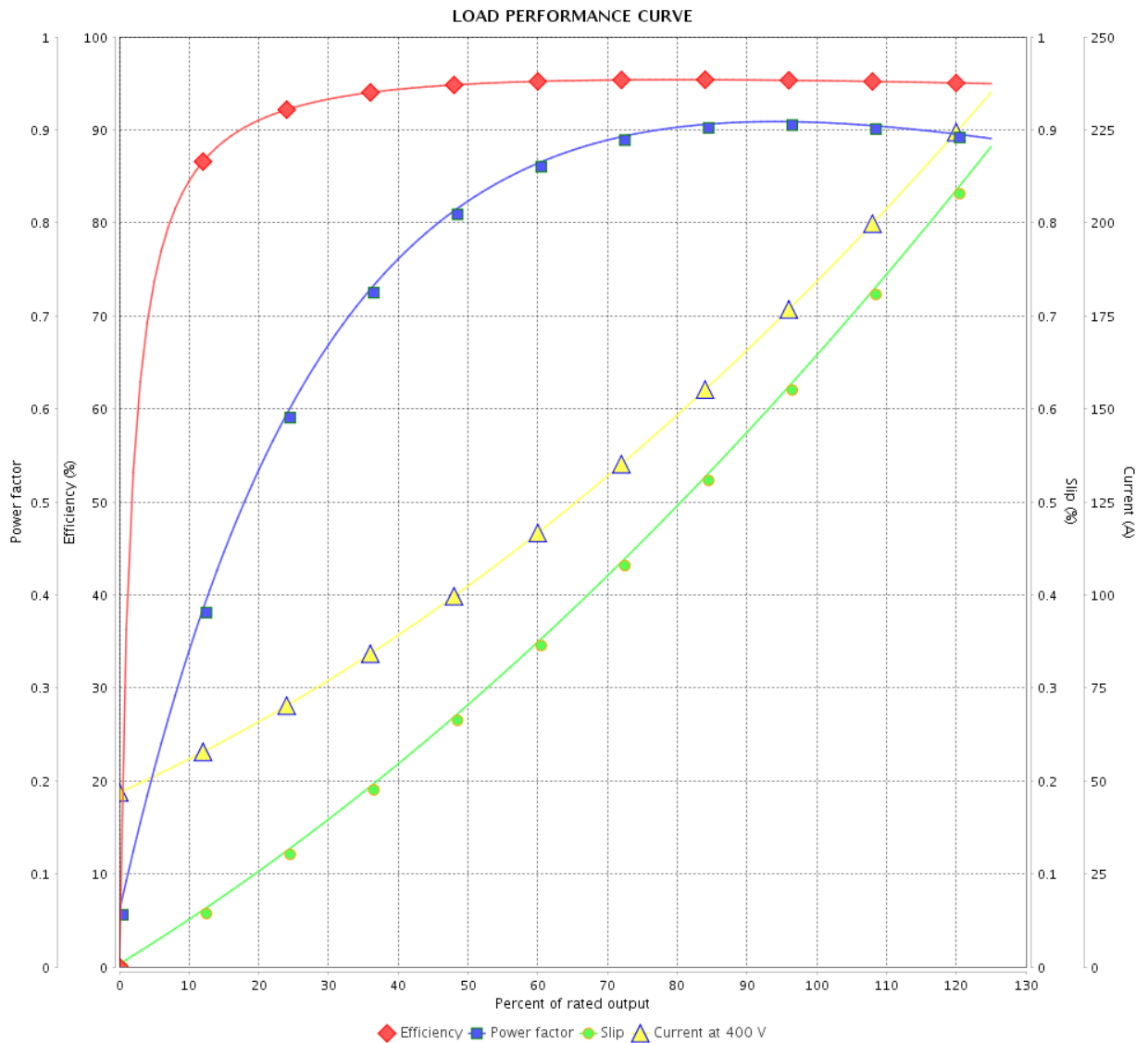

Performance : 400 V 50 Hz 2P IE3

Rated current : 183 A
 LRC : 7.6
 Rated torque : 264 ft.lb
 Locked rotor torque : 220 %
 Breakdown torque : 290 %
 Rated speed : 2980 rpm

Moment of inertia (J) : 44.7 sq.ft.lb
 Duty cycle : Cont.(S1)
 Insulation class : F
 Service factor : 1.15
 Temperature rise : 80 K
 Design : B

Rev.	Changes Summary	Performed	Checked	Date
Performed by		Page		Revision
Checked by		11 / 36		
Date		14/04/2022		

LOAD PERFORMANCE CURVE

Three Phase Induction Motor - Squirrel Cage



Customer : _____

Product line : NEMA Premium Efficiency Three-Phase

Product code : 11431289

Catalog # : 20036ET3G447TS-W22

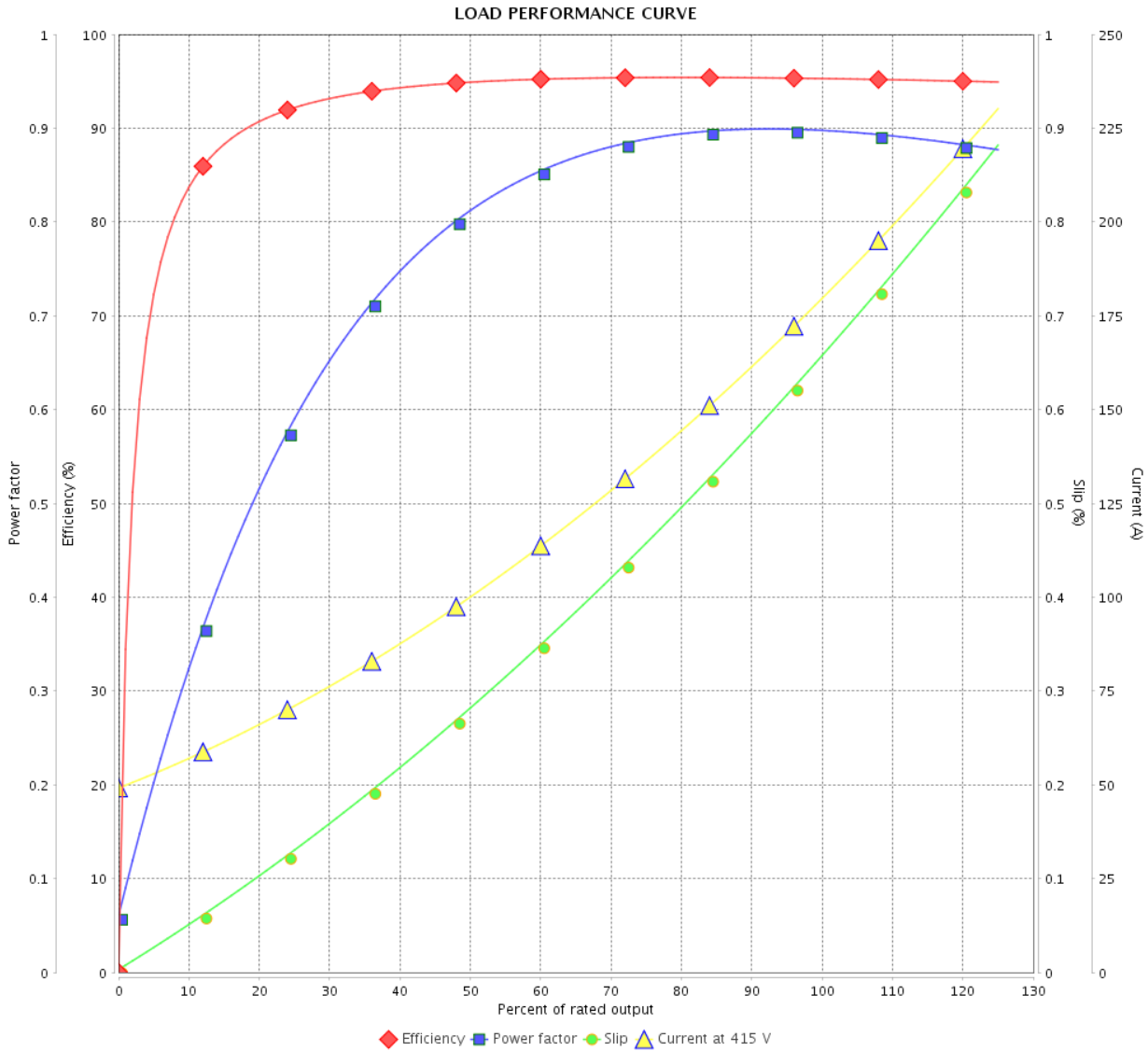

Performance : 415 V 50 Hz 2P IE3

Rated current : 178 A
 LRC : 8.3
 Rated torque : 264 ft.lb
 Locked rotor torque : 229 %
 Breakdown torque : 320 %
 Rated speed : 2980 rpm

Moment of inertia (J) : 44.7 sq.ft.lb
 Duty cycle : Cont.(S1)
 Insulation class : F
 Service factor : 1.15
 Temperature rise : 80 K
 Design : B

Rev.	Changes Summary	Performed	Checked	Date
Performed by				
Checked by				
Date				
		Page	Revision	
		12 / 36		

LOAD PERFORMANCE CURVE

Three Phase Induction Motor - Squirrel Cage



Customer : _____

Product line : NEMA Premium Efficiency Three-Phase

Product code : 11431289

Catalog # : 20036ET3G447TS-W22

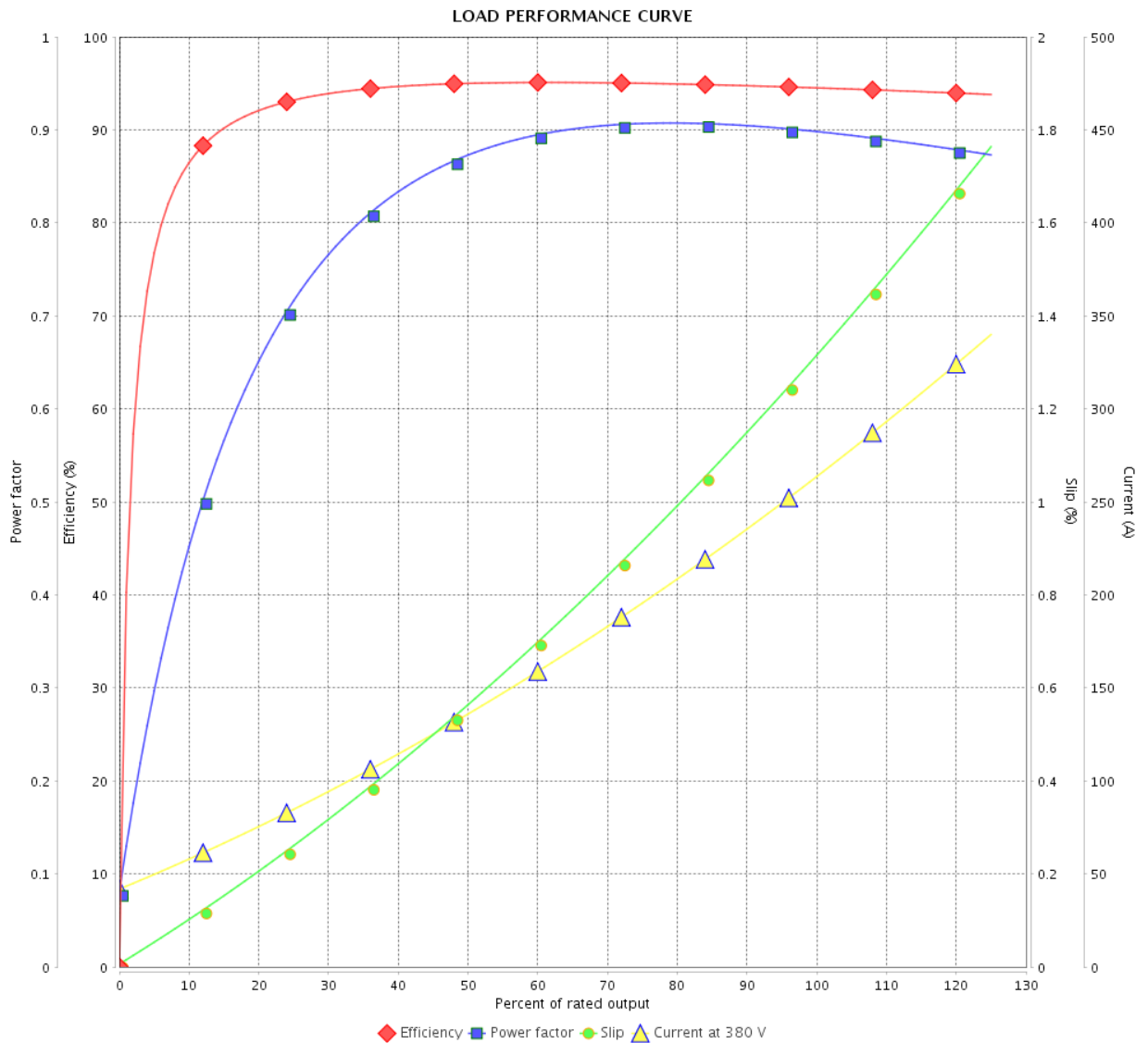

Performance : 380 V 50 Hz 2P IE1

Rated current : 268 A
 LRC : 5.4
 Rated torque : 355 ft.lb
 Locked rotor torque : 160 %
 Breakdown torque : 190 %
 Rated speed : 2960 rpm

Moment of inertia (J) : 44.7 sq.ft.lb
 Duty cycle : Cont.(S1)
 Insulation class : F
 Service factor : 1.00
 Temperature rise : 105 K
 Design : B

Rev.	Changes Summary	Performed	Checked	Date
Performed by				
Checked by				
Date				
			Page	Revision
			13 / 36	

LOAD PERFORMANCE CURVE

Three Phase Induction Motor - Squirrel Cage



Customer : _____

Product line : NEMA Premium Efficiency Three-Phase

Product code : 11431289

Catalog # : 20036ET3G447TS-W22

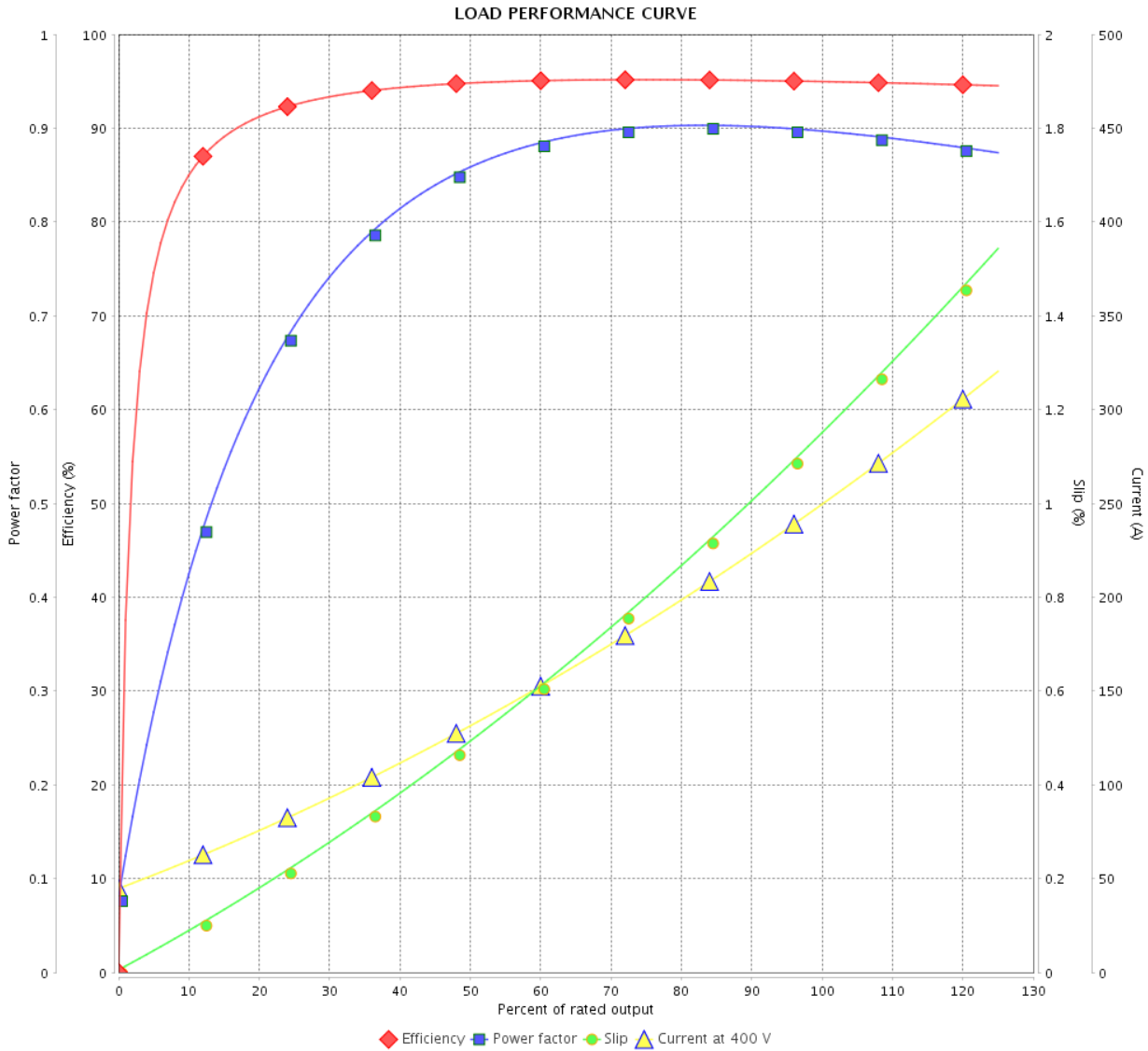

Performance : 400 V 50 Hz 2P IE2

Rated current : 253 A
 LRC : 6.1
 Rated torque : 354 ft.lb
 Locked rotor torque : 180 %
 Breakdown torque : 220 %
 Rated speed : 2965 rpm

Moment of inertia (J) : 44.7 sq.ft.lb
 Duty cycle : Cont.(S1)
 Insulation class : F
 Service factor : 1.00
 Temperature rise : 105 K
 Design : B

Rev.	Changes Summary	Performed	Checked	Date
Performed by			Page	Revision
Checked by				
Date				

LOAD PERFORMANCE CURVE

Three Phase Induction Motor - Squirrel Cage



Customer :

Product line : NEMA Premium Efficiency Three-Phase

Product code : 11431289

Catalog # : 20036ET3G447TS-W22

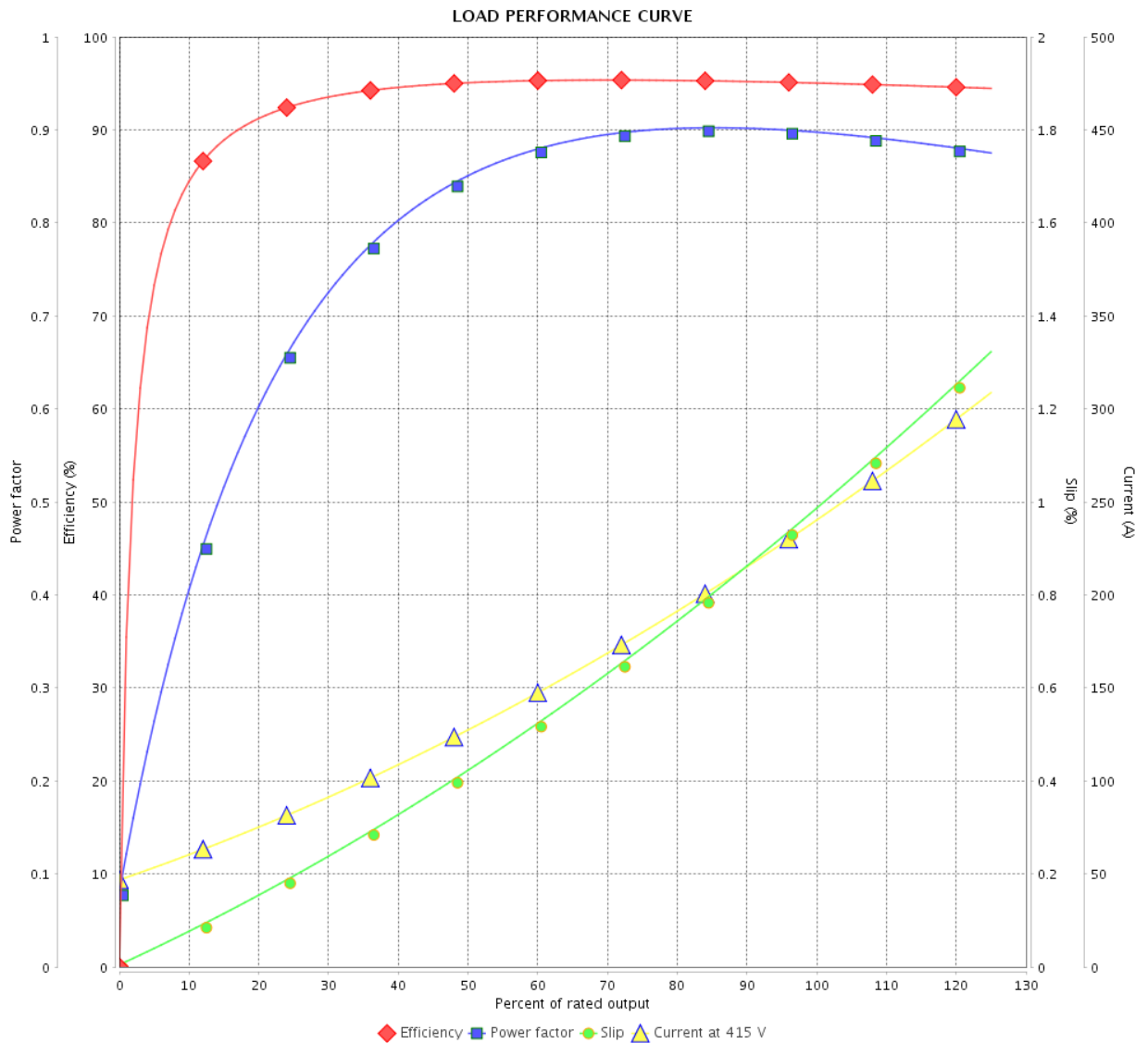

Performance : 415 V 50 Hz 2P IE2

Rated current : 244 A
 LRC : 6.7
 Rated torque : 354 ft.lb
 Locked rotor torque : 200 %
 Breakdown torque : 229 %
 Rated speed : 2970 rpm

Moment of inertia (J) : 44.7 sq.ft.lb
 Duty cycle : Cont.(S1)
 Insulation class : F
 Service factor : 1.00
 Temperature rise : 105 K
 Design : B

Rev.	Changes Summary	Performed	Checked	Date
Performed by				
Checked by				
Date				
		Page	Revision	
		15 / 36		

THERMAL LIMIT CURVE

Three Phase Induction Motor - Squirrel Cage



Customer :

Product line : NEMA Premium Efficiency Three-Phase

Product code : 11431289

Catalog # : 20036ET3G447TS-W22

Performance : 460 V 60 Hz 2P

Rated current	: 219 A	Moment of inertia (J)	: 44.7 sq.ft.lb
LRC	: 6.5	Duty cycle	: Cont.(S1)
Rated torque	: 294 ft.lb	Insulation class	: F
Locked rotor torque	: 210 %	Service factor	: 1.15
Breakdown torque	: 229 %	Temperature rise	: 80 K
Rated speed	: 3570 rpm	Design	: B

Heating constant

Cooling constant

Rev.	Changes Summary	Performed	Checked	Date
Performed by				
Checked by			Page	Revision
Date	14/04/2022		16 / 36	

THERMAL LIMIT CURVE

Three Phase Induction Motor - Squirrel Cage



Customer : _____

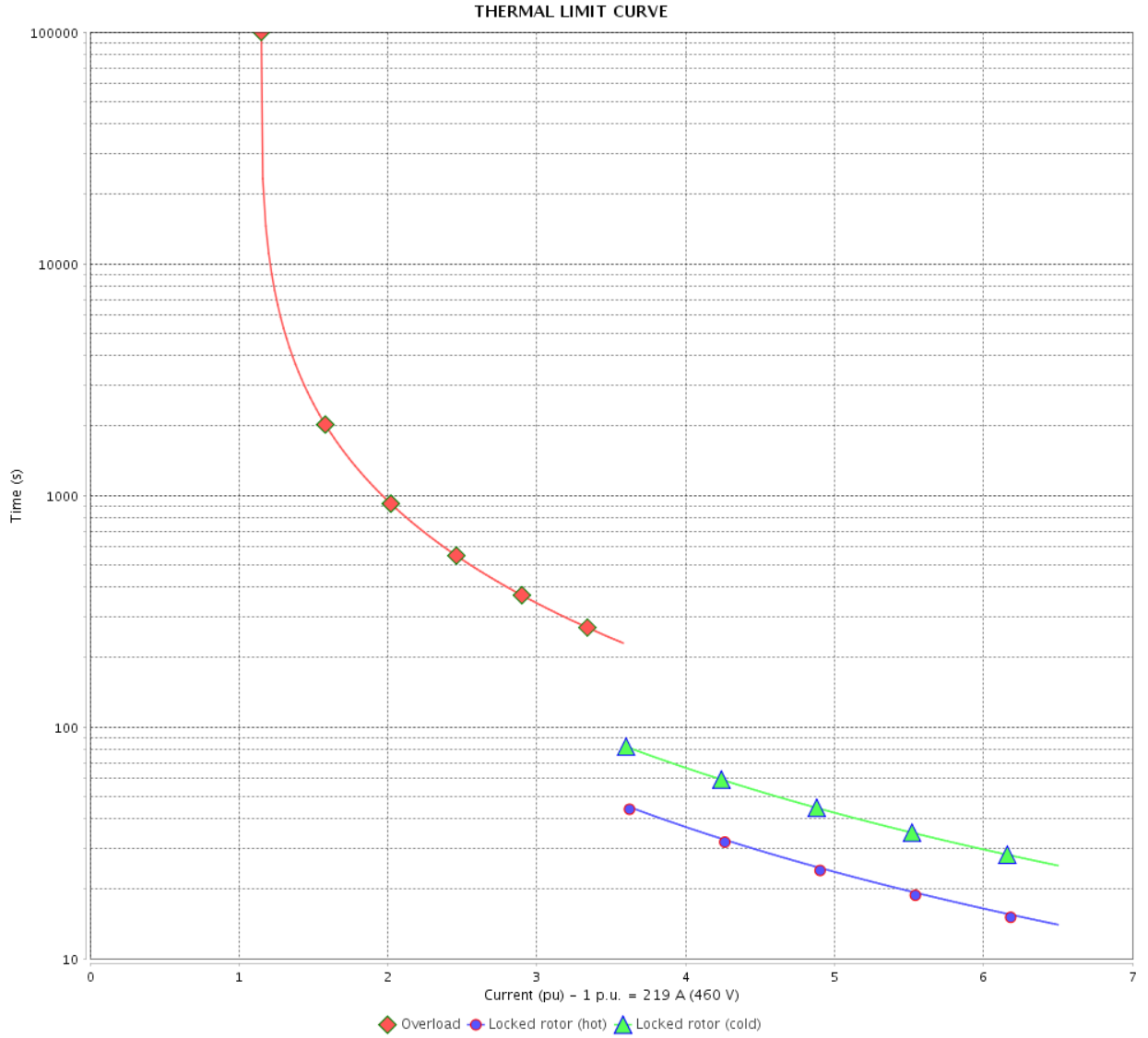

Rev.	Changes Summary	Performed	Checked	Date
Performed by		Page 17 / 36		Revision
Checked by				
Date				

THERMAL LIMIT CURVE

Three Phase Induction Motor - Squirrel Cage



Customer :

Product line : NEMA Premium Efficiency Three-Phase
Product code : 11431289
Catalog # : 20036ET3G447TS-W22

Performance : 380 V 50 Hz 2P IE3

Rated current	: 193 A	Moment of inertia (J)	: 44.7 sq.ft.lb
LRC	: 6.8	Duty cycle	: Cont.(S1)
Rated torque	: 265 ft.lb	Insulation class	: F
Locked rotor torque	: 210 %	Service factor	: 1.15
Breakdown torque	: 260 %	Temperature rise	: 80 K
Rated speed	: 2975 rpm	Design	: B

Heating constant

Cooling constant

Rev.	Changes Summary	Performed	Checked	Date
Performed by				
Checked by			Page	Revision
Date	14/04/2022		18 / 36	

THERMAL LIMIT CURVE

Three Phase Induction Motor - Squirrel Cage



Customer : _____

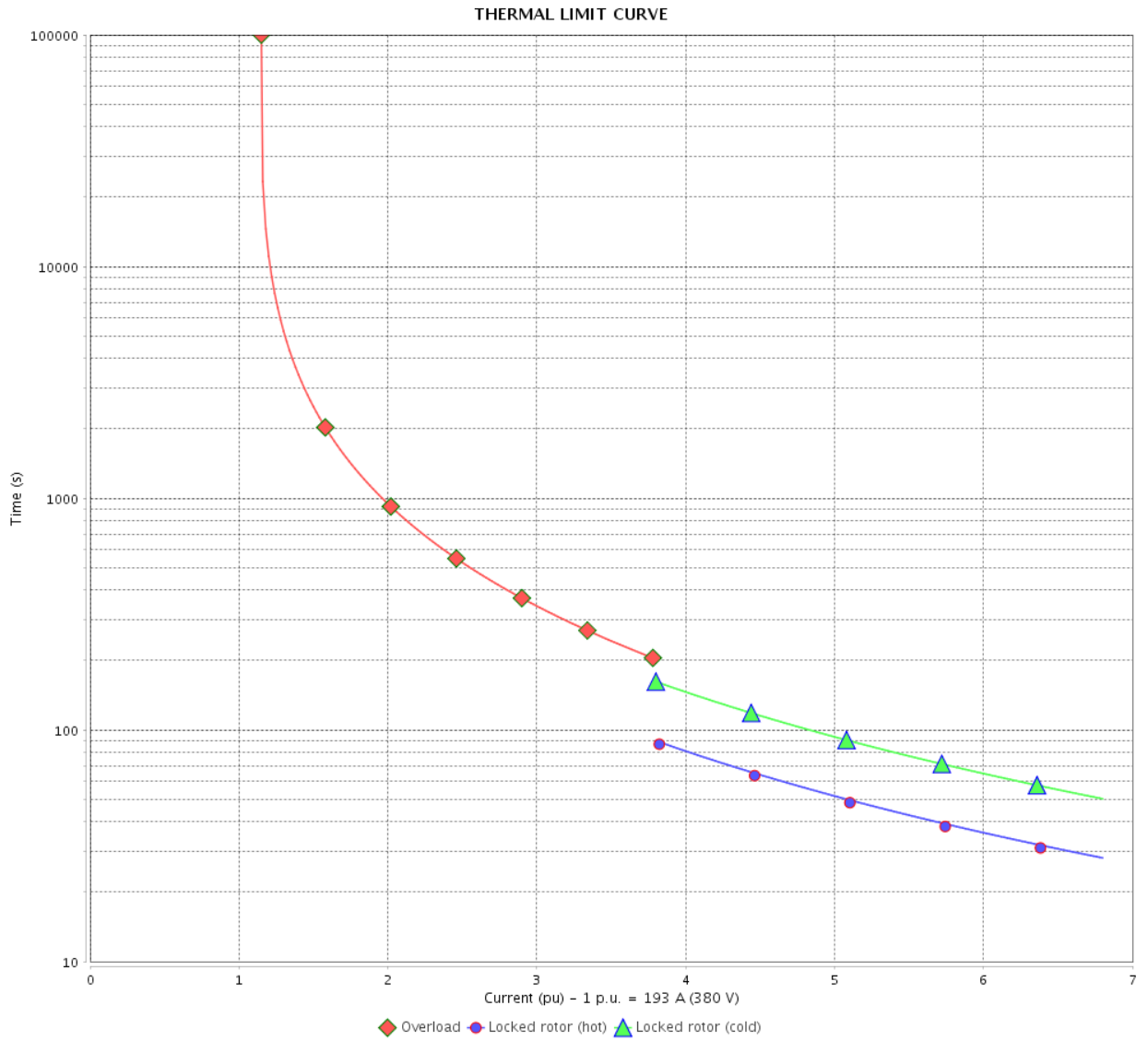

Rev.	Changes Summary	Performed	Checked	Date
Performed by		Page		Revision
Checked by		19 / 36		
Date		14/04/2022		

THERMAL LIMIT CURVE

Three Phase Induction Motor - Squirrel Cage



Customer :

Product line : NEMA Premium Efficiency Three-Phase

Product code : 11431289

Catalog # : 20036ET3G447TS-W22

Performance : 400 V 50 Hz 2P IE3

Rated current	: 183 A	Moment of inertia (J)	: 44.7 sq.ft.lb
LRC	: 7.6	Duty cycle	: Cont.(S1)
Rated torque	: 264 ft.lb	Insulation class	: F
Locked rotor torque	: 220 %	Service factor	: 1.15
Breakdown torque	: 290 %	Temperature rise	: 80 K
Rated speed	: 2980 rpm	Design	: B

Heating constant

Cooling constant

Rev.	Changes Summary	Performed	Checked	Date
Performed by				
Checked by			Page	Revision
Date	14/04/2022		20 / 36	

THERMAL LIMIT CURVE

Three Phase Induction Motor - Squirrel Cage



Customer : _____

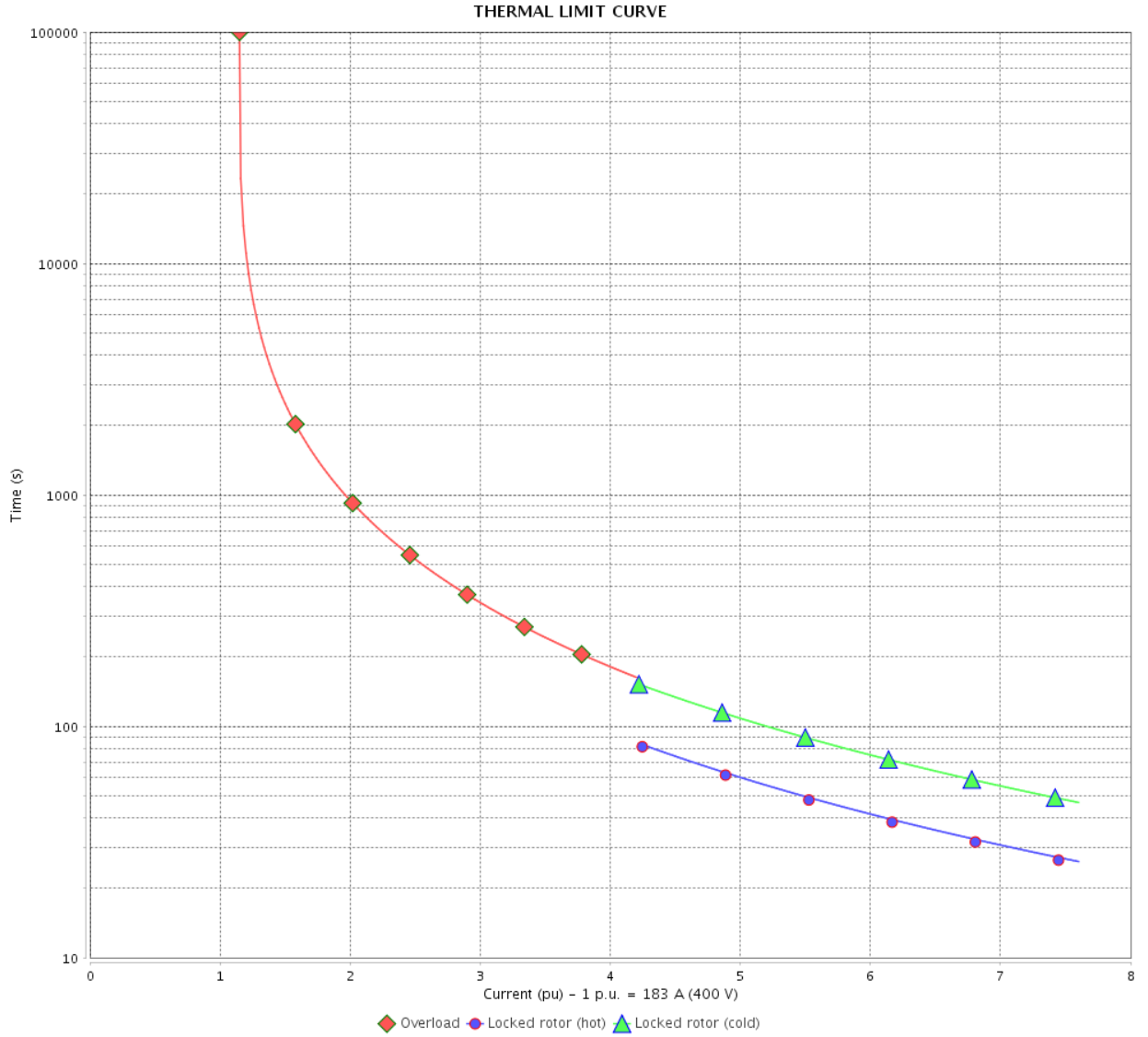

Rev.	Changes Summary	Performed	Checked	Date
Performed by		Page 21 / 36		Revision
Checked by				
Date				

THERMAL LIMIT CURVE



Three Phase Induction Motor - Squirrel Cage

Customer :

Product line : NEMA Premium Efficiency Three-Phase
Product code : 11431289
Catalog # : 20036ET3G447TS-W22

Performance : 415 V 50 Hz 2P IE3

Rated current	: 178 A	Moment of inertia (J)	: 44.7 sq.ft.lb
LRC	: 8.3	Duty cycle	: Cont.(S1)
Rated torque	: 264 ft.lb	Insulation class	: F
Locked rotor torque	: 229 %	Service factor	: 1.15
Breakdown torque	: 320 %	Temperature rise	: 80 K
Rated speed	: 2980 rpm	Design	: B

Heating constant

Cooling constant

Rev.	Changes Summary	Performed	Checked	Date
Performed by				
Checked by			Page	Revision
Date	14/04/2022		22 / 36	

THERMAL LIMIT CURVE

Three Phase Induction Motor - Squirrel Cage



Customer : _____

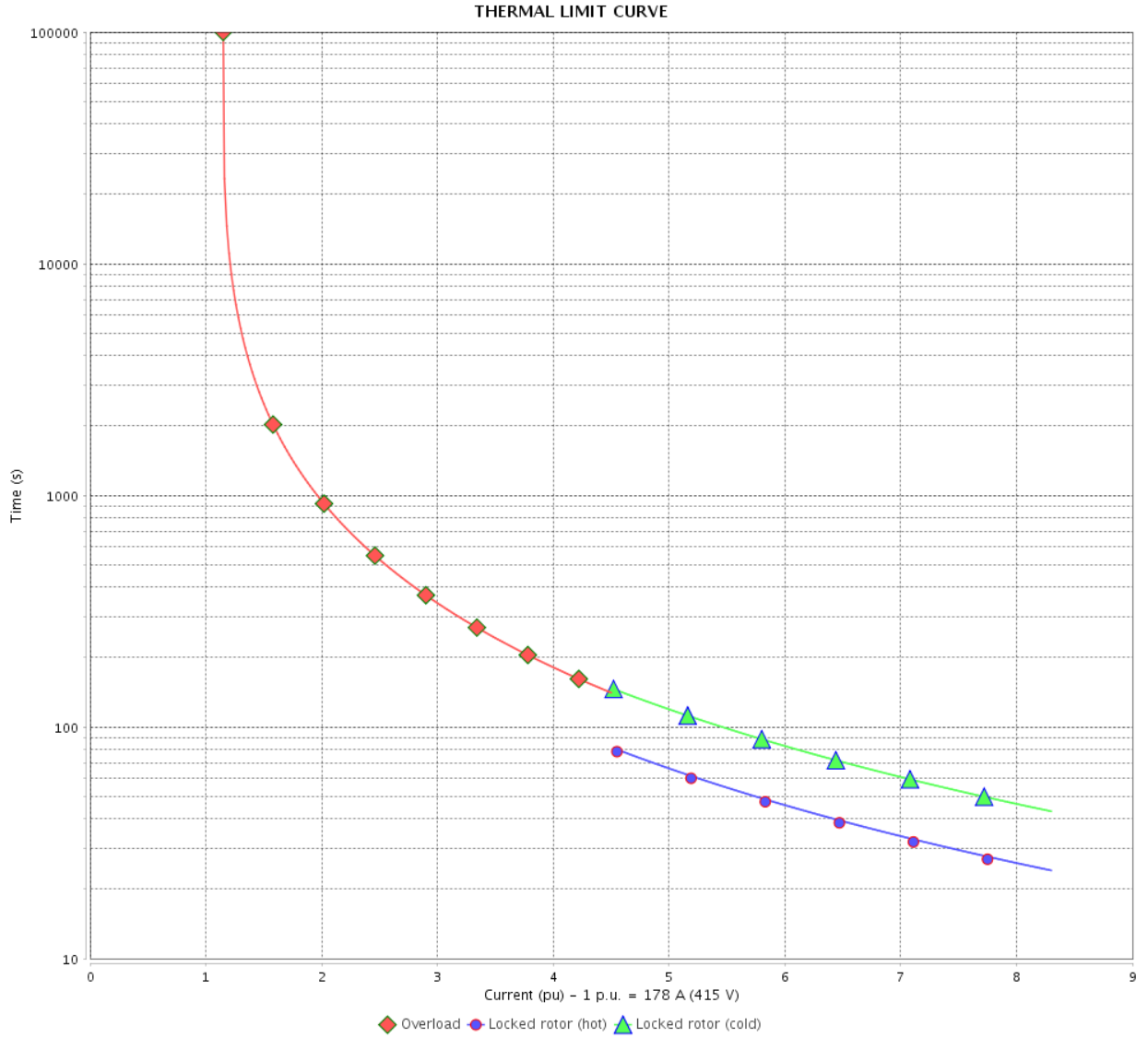

Rev.	Changes Summary	Performed	Checked	Date
Performed by		Page		Revision
Checked by		23 / 36		
Date		14/04/2022		

THERMAL LIMIT CURVE



Three Phase Induction Motor - Squirrel Cage

Customer :

Product line : NEMA Premium Efficiency Three-Phase
Product code : 11431289
Catalog # : 20036ET3G447TS-W22

Performance : 380 V 50 Hz 2P IE1

Rated current	: 268 A	Moment of inertia (J)	: 44.7 sq.ft.lb
LRC	: 5.4	Duty cycle	: Cont.(S1)
Rated torque	: 355 ft.lb	Insulation class	: F
Locked rotor torque	: 160 %	Service factor	: 1.00
Breakdown torque	: 190 %	Temperature rise	: 105 K
Rated speed	: 2960 rpm	Design	: B

Heating constant

Cooling constant

Rev.	Changes Summary	Performed	Checked	Date
Performed by				
Checked by			Page	Revision
Date	14/04/2022		24 / 36	

THERMAL LIMIT CURVE

Three Phase Induction Motor - Squirrel Cage



Customer : _____

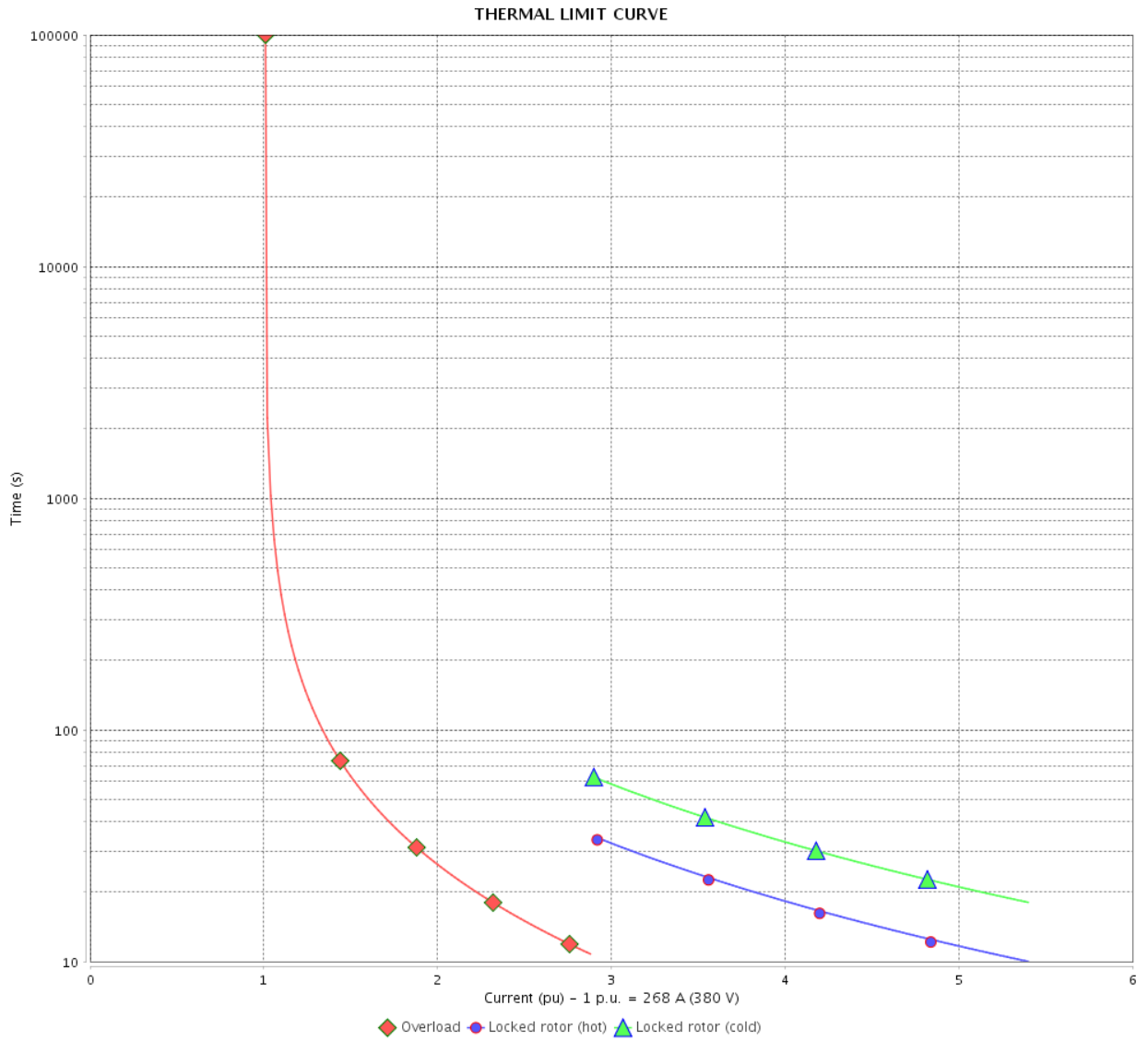

Rev.	Changes Summary	Performed	Checked	Date
Performed by		Page 25 / 36		Revision
Checked by				
Date				

THERMAL LIMIT CURVE

Three Phase Induction Motor - Squirrel Cage



Customer :

Product line : NEMA Premium Efficiency Three-Phase
Product code : 11431289
Catalog # : 20036ET3G447TS-W22

Performance : 400 V 50 Hz 2P IE2

Rated current	: 253 A	Moment of inertia (J)	: 44.7 sq.ft.lb
LRC	: 6.1	Duty cycle	: Cont.(S1)
Rated torque	: 354 ft.lb	Insulation class	: F
Locked rotor torque	: 180 %	Service factor	: 1.00
Breakdown torque	: 220 %	Temperature rise	: 105 K
Rated speed	: 2965 rpm	Design	: B

Heating constant

Cooling constant

Rev.	Changes Summary	Performed	Checked	Date
Performed by				
Checked by			Page	Revision
Date	14/04/2022		26 / 36	

THERMAL LIMIT CURVE

Three Phase Induction Motor - Squirrel Cage



Customer : _____

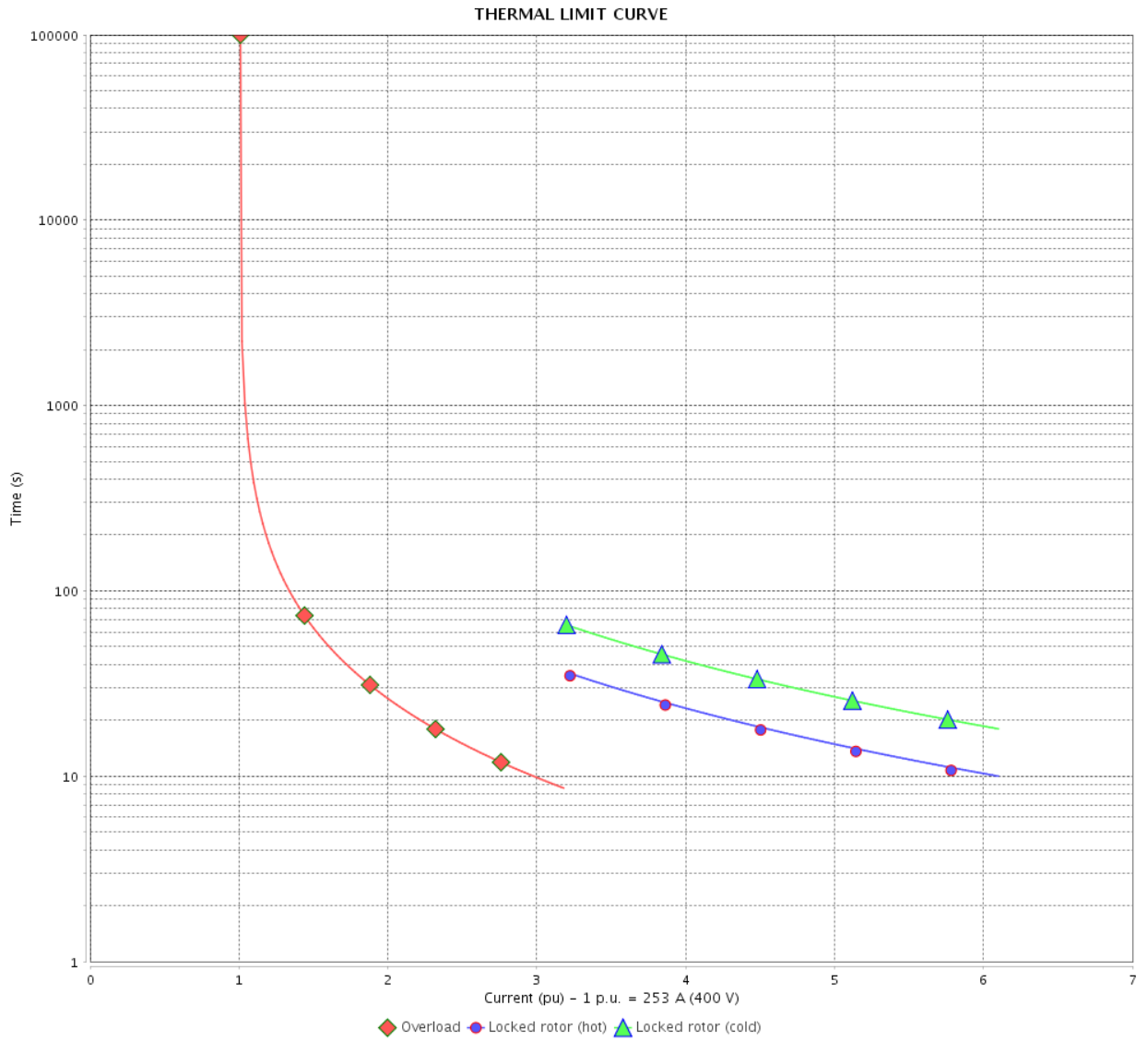

Rev.	Changes Summary	Performed	Checked	Date
Performed by				
Checked by				
Date				
			Page	Revision
			27 / 36	

THERMAL LIMIT CURVE

Three Phase Induction Motor - Squirrel Cage



Customer :

Product line : NEMA Premium Efficiency Three-Phase

Product code : 11431289

Catalog # : 20036ET3G447TS-W22

Performance : 415 V 50 Hz 2P IE2

Rated current	: 244 A	Moment of inertia (J)	: 44.7 sq.ft.lb
LRC	: 6.7	Duty cycle	: Cont.(S1)
Rated torque	: 354 ft.lb	Insulation class	: F
Locked rotor torque	: 200 %	Service factor	: 1.00
Breakdown torque	: 229 %	Temperature rise	: 105 K
Rated speed	: 2970 rpm	Design	: B

Heating constant

Cooling constant

Rev.	Changes Summary	Performed	Checked	Date
Performed by				
Checked by			Page	Revision
Date	14/04/2022		28 / 36	

THERMAL LIMIT CURVE

Three Phase Induction Motor - Squirrel Cage



Customer : _____

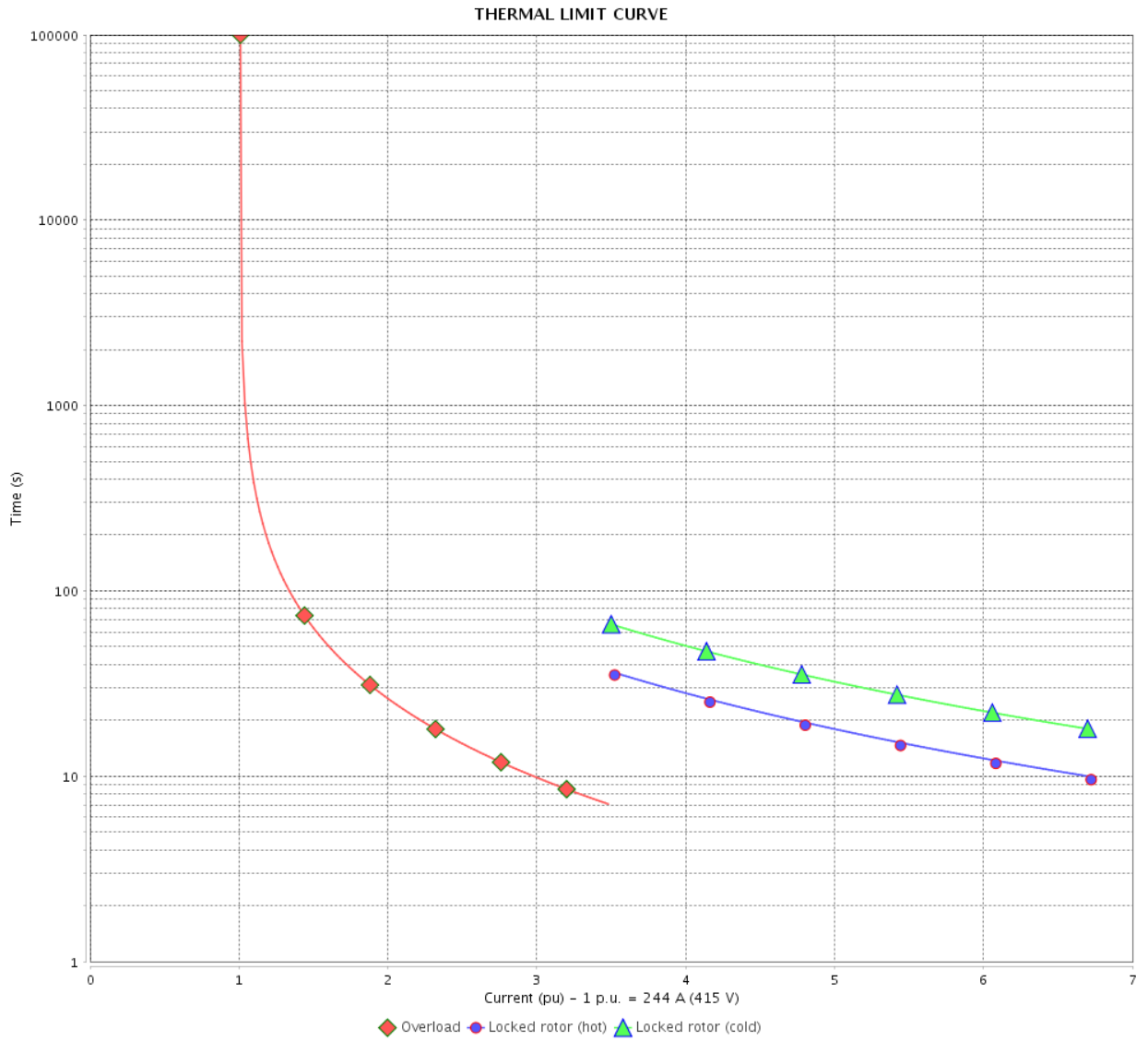

Rev.	Changes Summary	Performed	Checked	Date
Performed by		Page		Revision
Checked by		29 / 36		
Date		14/04/2022		

VFD OPERATION CURVE

Three Phase Induction Motor - Squirrel Cage



Customer : _____

Product line : NEMA Premium Efficiency Three-Phase

Product code : 11431289

Catalog # : 20036ET3G447TS-W22

VFD OPERATION CURVE

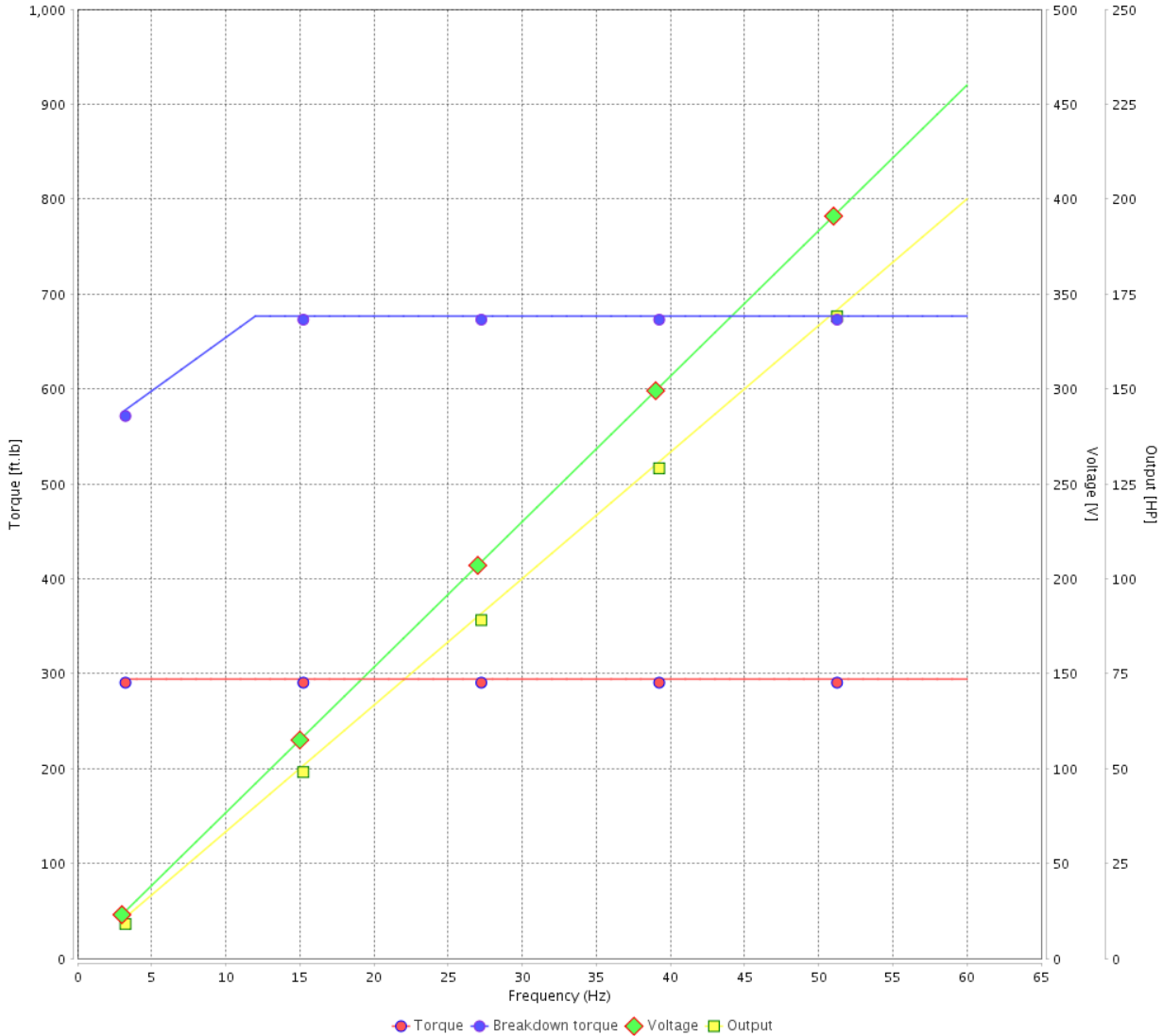

Performance : 460 V 60 Hz 2P

Rated current : 219 A
 LRC : 6.5
 Rated torque : 294 ft.lb
 Locked rotor torque : 210 %
 Breakdown torque : 229 %
 Rated speed : 3570 rpm

Moment of inertia (J) : 44.7 sq.ft.lb
 Duty cycle : Cont.(S1)
 Insulation class : F
 Service factor : 1.15
 Temperature rise : 80 K
 Design : B

Rev.	Changes Summary	Performed	Checked	Date
Performed by			Page 30 / 36	Revision
Checked by				
Date	14/04/2022			

VFD OPERATION CURVE

Three Phase Induction Motor - Squirrel Cage



Customer :

Product line : NEMA Premium Efficiency Three-Phase

Product code : 11431289

Catalog # : 20036ET3G447TS-W22

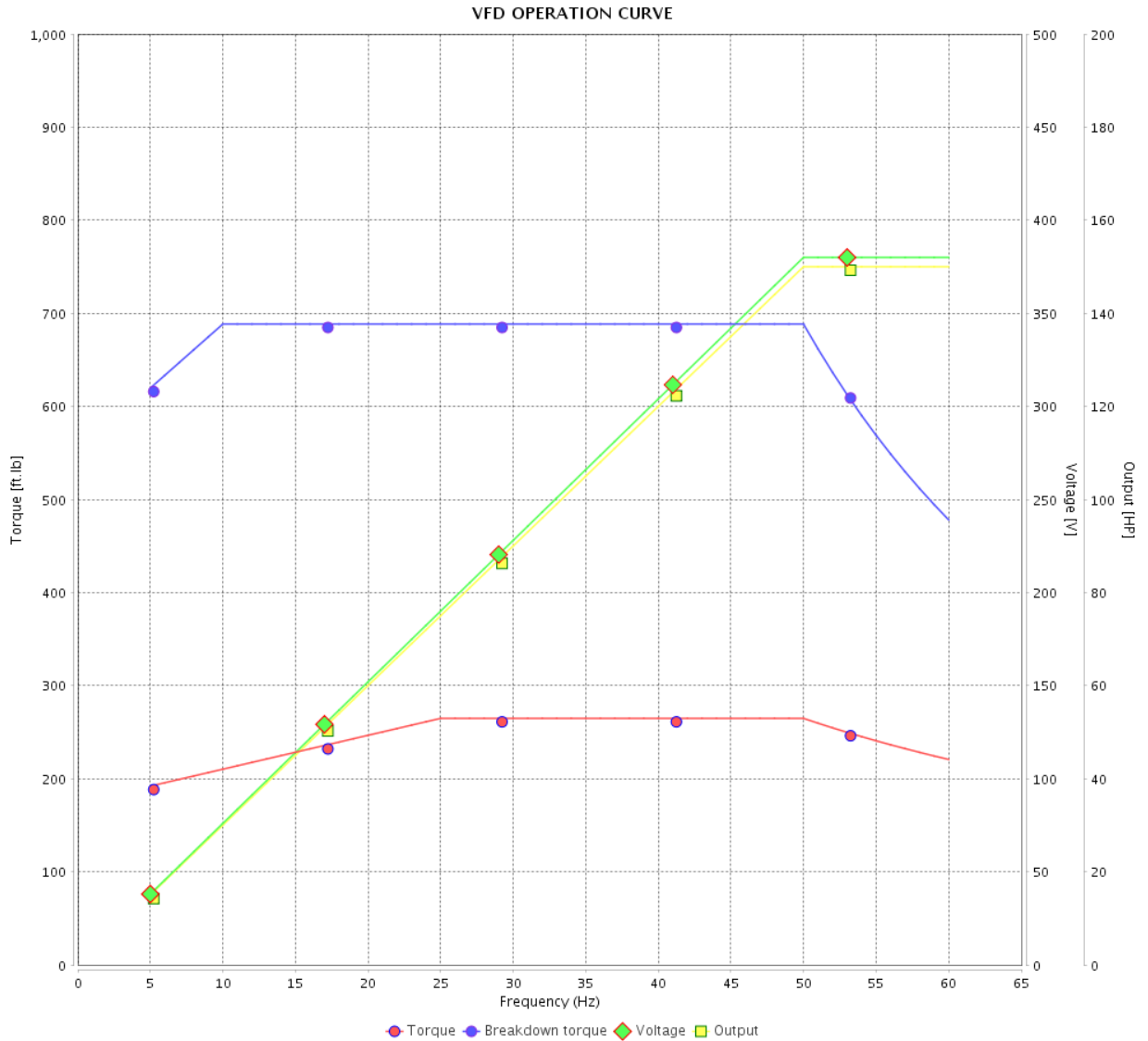

Performance : 380 V 50 Hz 2P IE3

Rated current : 193 A
 LRC : 6.8
 Rated torque : 265 ft.lb
 Locked rotor torque : 210 %
 Breakdown torque : 260 %
 Rated speed : 2975 rpm

Moment of inertia (J) : 44.7 sq.ft.lb
 Duty cycle : Cont.(S1)
 Insulation class : F
 Service factor : 1.15
 Temperature rise : 80 K
 Design : B

Rev.	Changes Summary	Performed	Checked	Date
Performed by			Page 31 / 36	Revision
Checked by				
Date	14/04/2022			

VFD OPERATION CURVE

Three Phase Induction Motor - Squirrel Cage



Customer : _____

Product line : NEMA Premium Efficiency Three-Phase

Product code : 11431289

Catalog # : 20036ET3G447TS-W22

VFD OPERATION CURVE

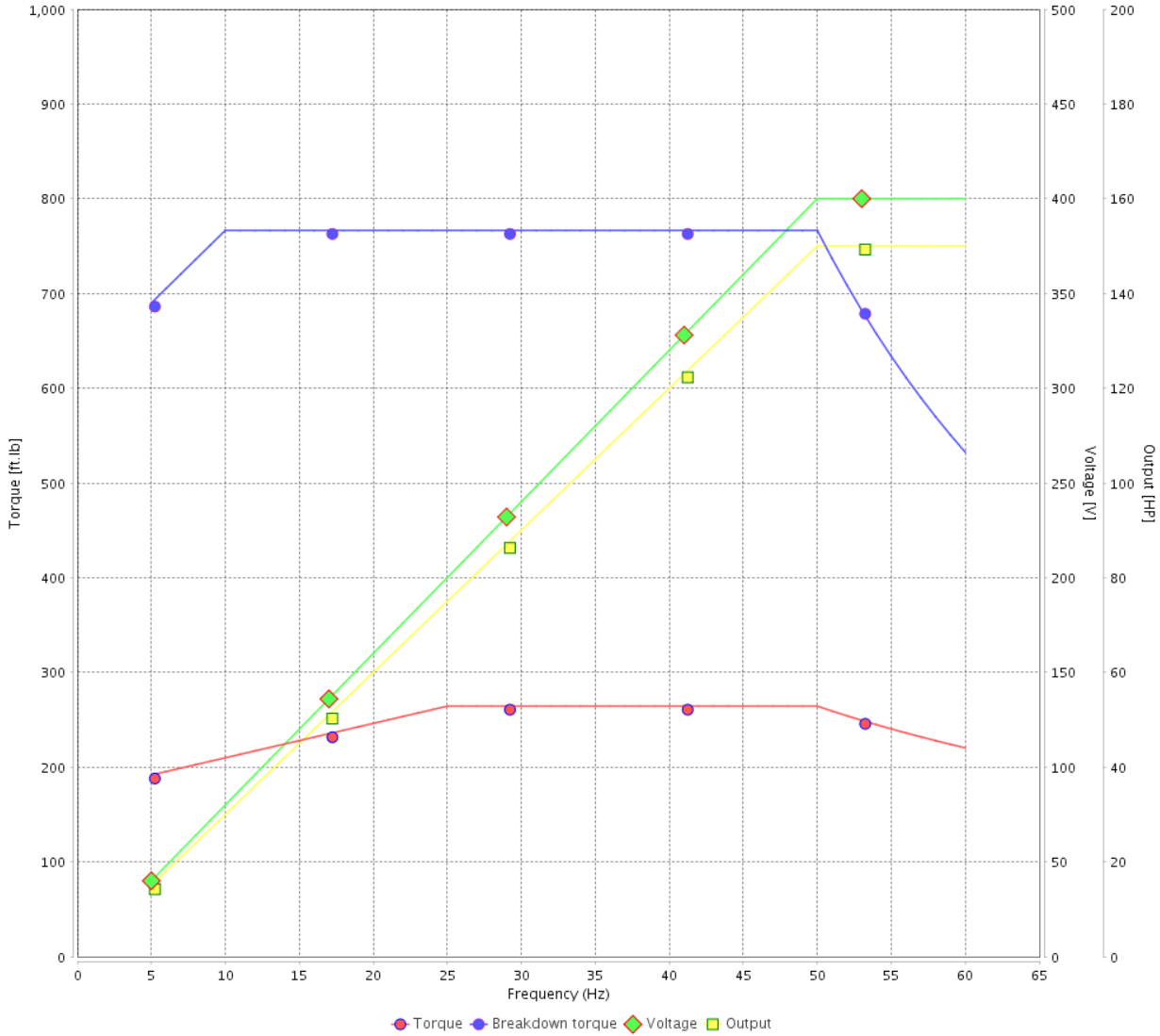

Performance : 400 V 50 Hz 2P IE3

Rated current : 183 A
 LRC : 7.6
 Rated torque : 264 ft.lb
 Locked rotor torque : 220 %
 Breakdown torque : 290 %
 Rated speed : 2980 rpm

Moment of inertia (J) : 44.7 sq.ft.lb
 Duty cycle : Cont.(S1)
 Insulation class : F
 Service factor : 1.15
 Temperature rise : 80 K
 Design : B

Rev.	Changes Summary	Performed	Checked	Date
Performed by			Page 32 / 36	Revision
Checked by				
Date	14/04/2022			

VFD OPERATION CURVE

Three Phase Induction Motor - Squirrel Cage



Customer : _____

Product line : NEMA Premium Efficiency Three-Phase

Product code : 11431289

Catalog # : 20036ET3G447TS-W22

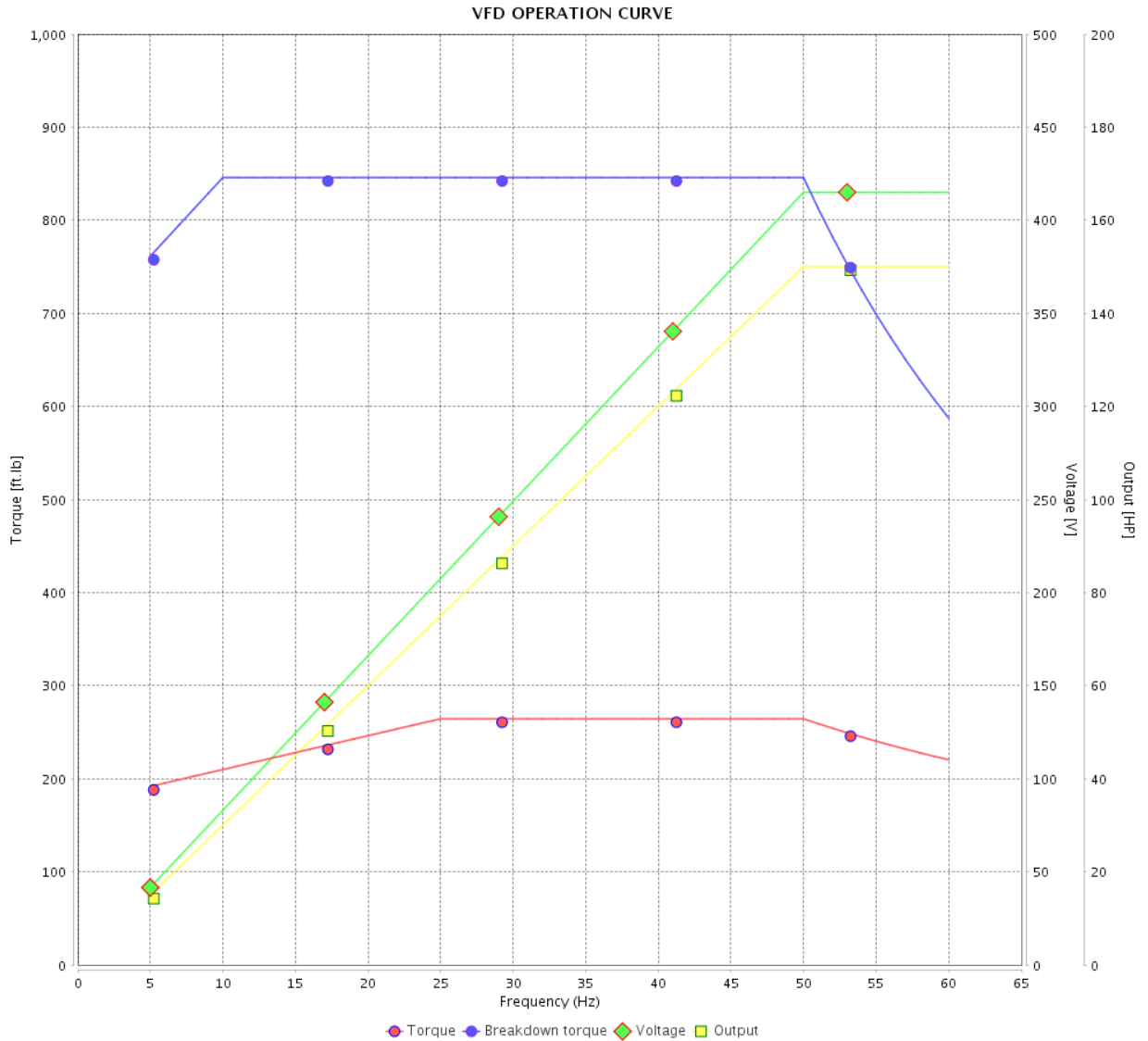

Performance : 415 V 50 Hz 2P IE3

Rated current : 178 A
 LRC : 8.3
 Rated torque : 264 ft.lb
 Locked rotor torque : 229 %
 Breakdown torque : 320 %
 Rated speed : 2980 rpm

Moment of inertia (J) : 44.7 sq.ft.lb
 Duty cycle : Cont.(S1)
 Insulation class : F
 Service factor : 1.15
 Temperature rise : 80 K
 Design : B

Rev.	Changes Summary	Performed	Checked	Date
Performed by		Page		Revision
Checked by		33 / 36		
Date		14/04/2022		

VFD OPERATION CURVE

Three Phase Induction Motor - Squirrel Cage



Customer :

Product line : NEMA Premium Efficiency Three-Phase

Product code : 11431289

Catalog # : 20036ET3G447TS-W22

VFD OPERATION CURVE

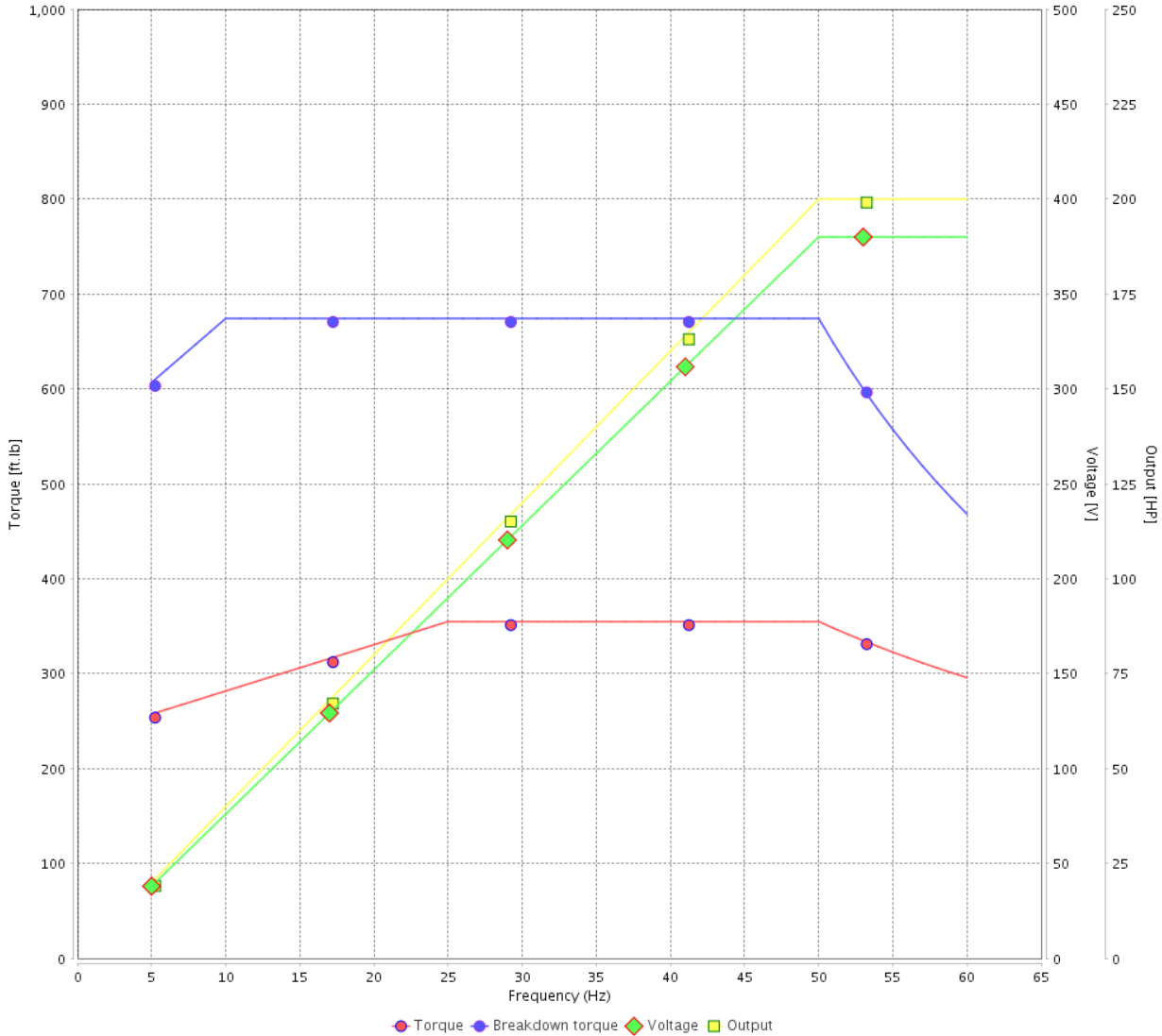

Performance : 380 V 50 Hz 2P IE1

Rated current	: 268 A	Moment of inertia (J)	: 44.7 sq.ft.lb
LRC	: 5.4	Duty cycle	: Cont.(S1)
Rated torque	: 355 ft.lb	Insulation class	: F
Locked rotor torque	: 160 %	Service factor	: 1.00
Breakdown torque	: 190 %	Temperature rise	: 105 K
Rated speed	: 2960 rpm	Design	: B

Rev.	Changes Summary	Performed	Checked	Date
Performed by			Page	Revision
Checked by				
Date				
			34 / 36	

VFD OPERATION CURVE

Three Phase Induction Motor - Squirrel Cage



Customer :

Product line : NEMA Premium Efficiency Three-Phase
 Product code : 11431289
 Catalog # : 20036ET3G447TS-W22

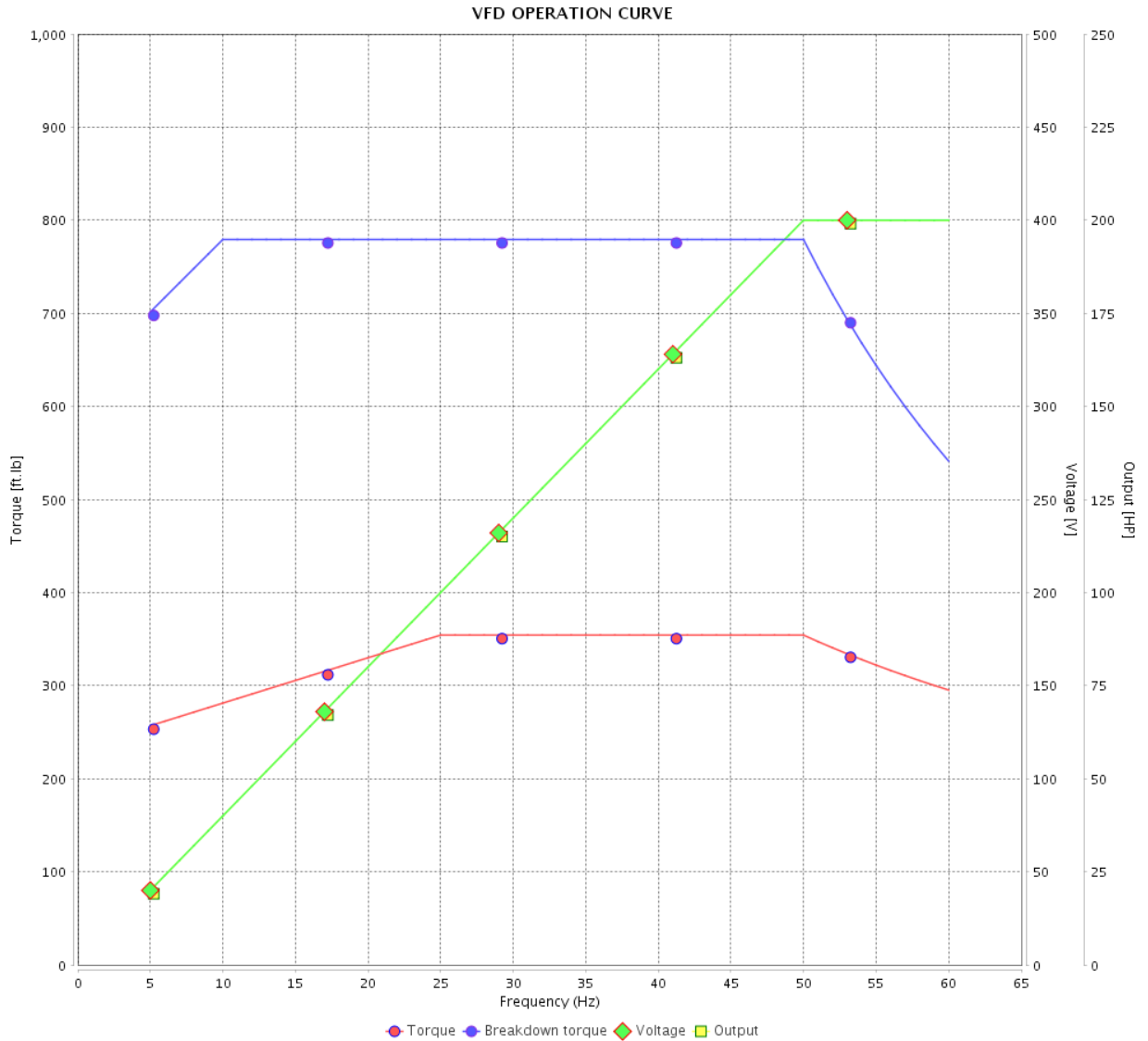

Performance : 400 V 50 Hz 2P IE2

Rated current : 253 A
 LRC : 6.1
 Rated torque : 354 ft.lb
 Locked rotor torque : 180 %
 Breakdown torque : 220 %
 Rated speed : 2965 rpm

Moment of inertia (J) : 44.7 sq.ft.lb
 Duty cycle : Cont.(S1)
 Insulation class : F
 Service factor : 1.00
 Temperature rise : 105 K
 Design : B

Rev.	Changes Summary	Performed	Checked	Date
Performed by			Page	Revision
Checked by				
Date				

VFD OPERATION CURVE

Three Phase Induction Motor - Squirrel Cage



Customer :

Product line : NEMA Premium Efficiency Three-Phase

Product code : 11431289

Catalog # : 20036ET3G447TS-W22

VFD OPERATION CURVE

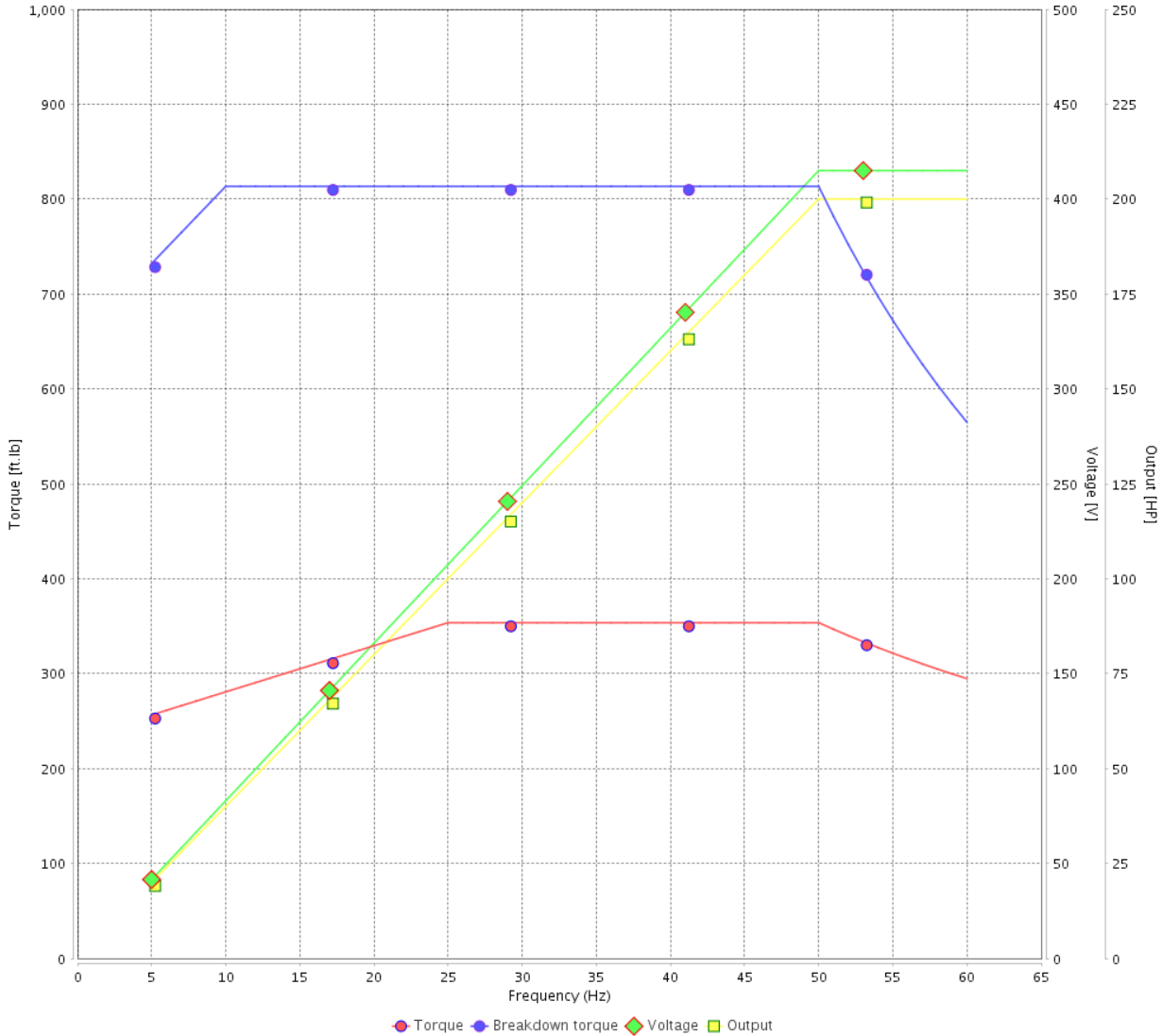

Performance : 415 V 50 Hz 2P IE2

Rated current : 244 A
 LRC : 6.7
 Rated torque : 354 ft.lb
 Locked rotor torque : 200 %
 Breakdown torque : 229 %
 Rated speed : 2970 rpm

Moment of inertia (J) : 44.7 sq.ft.lb
 Duty cycle : Cont.(S1)
 Insulation class : F
 Service factor : 1.00
 Temperature rise : 105 K
 Design : B

Rev.	Changes Summary	Performed	Checked	Date
Performed by			Page	Revision
Checked by				
Date				

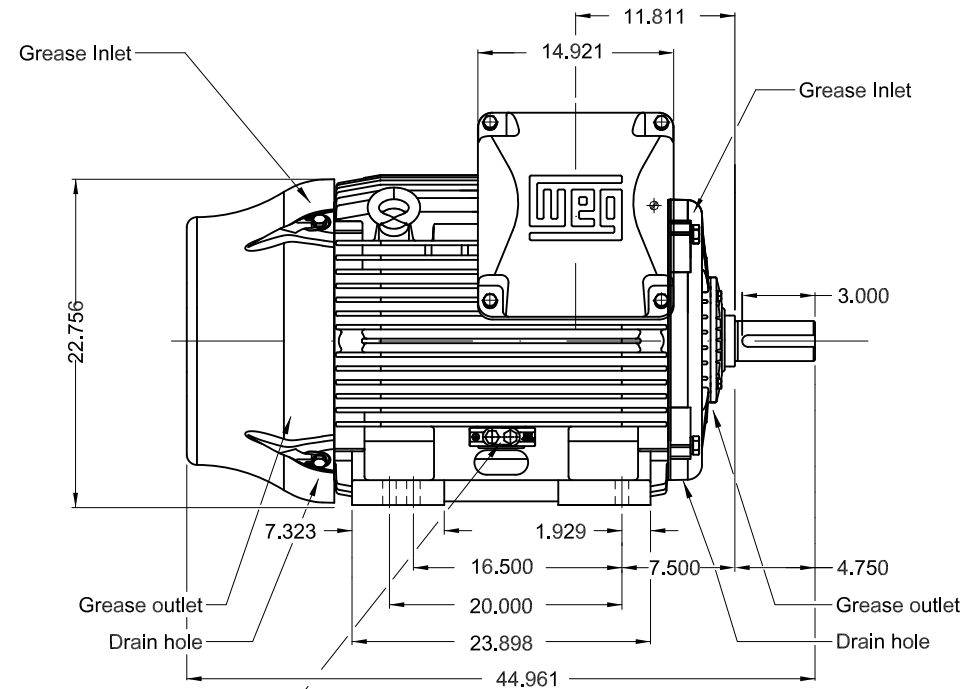
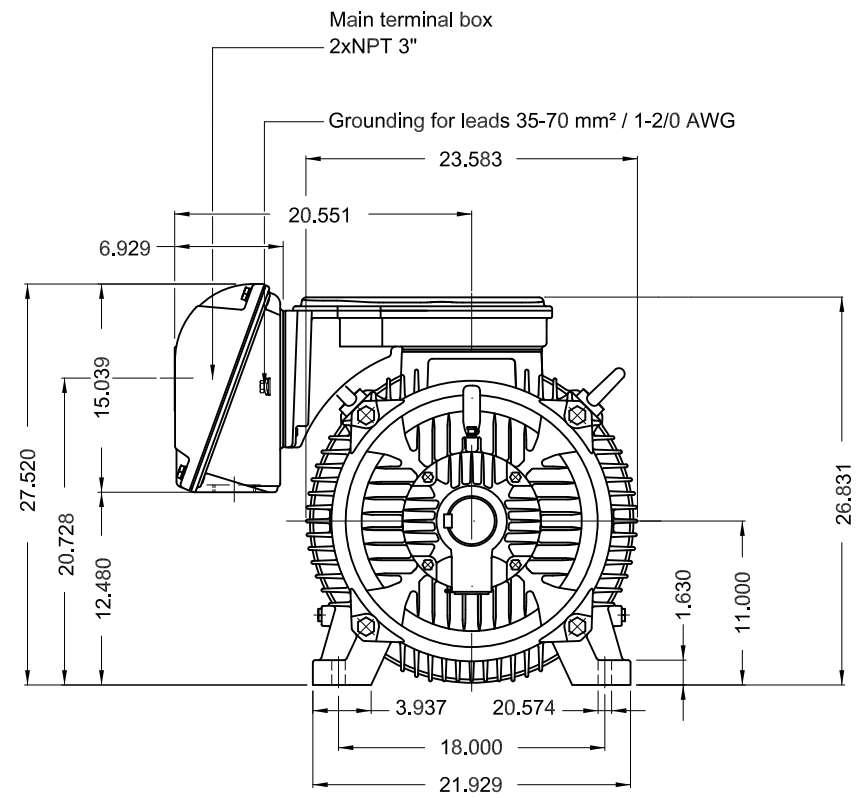

Grounding for leads 25-185 mm² / 3AWG-350MCM

Color RAL 5009
 Painting plan 203A
 Mounting B3R(D)

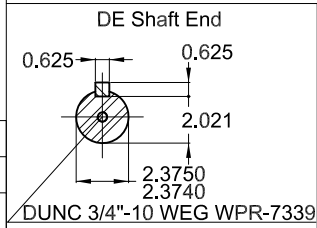

200 HP 02 Poles 60 Hz

A

ECM	LOC	SUMMARY OF MODIFICATIONS	EXECUTED	CHECKED	RELEASED	DATE	VER
EXECUTED	PIRWUSER	THREE PH. MOTOR W22 PREM. EFF.					
CHECKED		FRAME 445/7TS IP55 TEFC					
RELEASED							
REL DT.	WMO	Jaragua do Sul	Product Engineering				

PREVIEW
 WDD



SHEET 1 / 1

Dimensions in inches

XME A3

MADE IN MEXICO
11431289



FOR SAFE AREA
Mod.TE1BFOXON
CC029A



Class I, Div 2, Gr A, B, C and D - T3
Class I, Zone 2, IIC - T3
Class II, Div 2, Gr F and G - T3C
For use on PWM: Gr. A, B, C, D and F,
VT 1000:1, CT 20:1, 1.00SF - T3

MODEL 20036ET3G447TS-W22

Inverter Duty Motor
Severe Duty

PH3	60Hz	Fr. 445/7TS	1000m.a.s.l.	IP55	TEFC	2045lb	
V 460				A 219			
HP 200				kW 150			
SF 1.15				SFA 252			
RPM 3570				PF 0.90			
AMB 40°C				INS cl. F DT80K	NEMA NOM EFF	95.4%	
DUTY CONT.				DES B	Code	G	

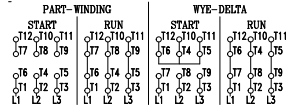

→ 6314-C3 (27g)
 → 6314-C3 (27g)

MOBIL POLYREX EM (4000h)