

DATA SHEET



Three Phase Induction Motor - Squirrel Cage

Customer								
Product line	: NEMA Premium Efficiency Three-Phase	Product code	: 11586547					
		Catalog #	: 25018ET3G447T-W22					
Frame	: 445/7T	Cooling method	: IC411 - TEFC					
Insulation class	: F	Mounting	: F-1					
Duty cycle	: Cont.(S1)	Rotation ¹	: Both (CW and CCW)					
Ambient temperature	: -20°C to +40°C	Starting method	: Direct On Line					
Altitude	: 1000 m.a.s.l.	Approx. weight ²	: 2561 lb					
Protection degree	: IP55	Moment of inertia (J)	: 89.6 sq.ft.lb					
Design	: B							
Output [HP]	250	200	200	200	250	250	250	
Poles	4	4	4	4	4	4	4	
Frequency [Hz]	60	50	50	50	50	50	50	
Rated voltage [V]	460	380	400	415	380	400	415	
Rated current [A]	281	273	263	256	340	322	314	
L. R. Amperes [A]	1827	1665	1788	1894	1734	1835	1915	
LRC [A]	6.5x(Code G)	6.1x(Code F)	6.8x(Code G)	7.4x(Code H)	5.1x(Code E)	5.7x(Code F)	6.1x(Code F)	
No load current [A]	90.0	85.0	90.0	95.0	85.0	90.0	95.0	
Rated speed [RPM]	1780	1480	1485	1485	1475	1480	1480	
Slip [%]	1.11	1.33	1.00	1.00	1.67	1.33	1.33	
Rated torque [ft.lb]	738	710	707	707	890	887	887	
Locked rotor torque [%]	229	200	260	290	180	200	220	
Breakdown torque [%]	240	240	270	300	190	210	229	
Service factor	1.15	1.15	1.15	1.15	1.00	1.00	1.00	
Temperature rise	80 K	80 K	80 K	80 K	105 K	105 K	105 K	
Locked rotor time	27s (cold) 15s (hot)	36s (cold) 20s (hot)	32s (cold) 18s (hot)	28s (cold) 16s (hot)	18s (cold) 10s (hot)	18s (cold) 10s (hot)	18s (cold) 10s (hot)	
Noise level ²	73.0 dB(A)							
Efficiency (%)	25%	95.7	94.8	95.0	95.0	95.6	95.3	95.6
	50%	95.8	95.0	95.1	95.1	95.4	95.4	95.4
	75%	96.2	95.8	95.8	95.8	95.4	95.4	95.8
	100%	96.2	95.8	95.8	95.8	95.0	95.4	95.4
Power Factor	25%	0.50	0.52	0.49	0.46	0.57	0.54	0.51
	50%	0.75	0.77	0.74	0.72	0.80	0.77	0.75
	75%	0.83	0.84	0.83	0.81	0.86	0.84	0.83
	100%	0.86	0.87	0.86	0.85	0.87	0.87	0.86
Bearing type	: Drive end 6319 C3	Non drive end 6316 C3	Foundation loads					
Sealing	: WSeal	WSeal	Max. traction : 4158 lb					
Lubrication interval	: 8000 h	10000 h	Max. compression : 6719 lb					
Lubricant amount	: 45 g	34 g						
Lubricant type	: Mobil Polyrex EM							
Notes								
This revision replaces and cancel the previous one, which must be eliminated. (1) Looking the motor from the shaft end. (2) Measured at 1m and with tolerance of +3dB(A). (3) Approximate weight subject to changes after manufacturing process. (4) At 100% of full load.				These are average values based on tests with sinusoidal power supply, subject to the tolerances stipulated in NEMA MG-1.				
Rev.	Changes Summary			Performed	Checked	Date		
Performed by								
Checked by					Page	Revision		
Date	13/04/2022				1 / 36			

TORQUE AND CURRENT VS SPEED CURVE

Three Phase Induction Motor - Squirrel Cage



Customer :

Product line : NEMA Premium Efficiency Three-Phase

Product code : 11586547

Catalog # : 25018ET3G447T-W22

TORQUE AND CURRENT VS SPEED CURVE

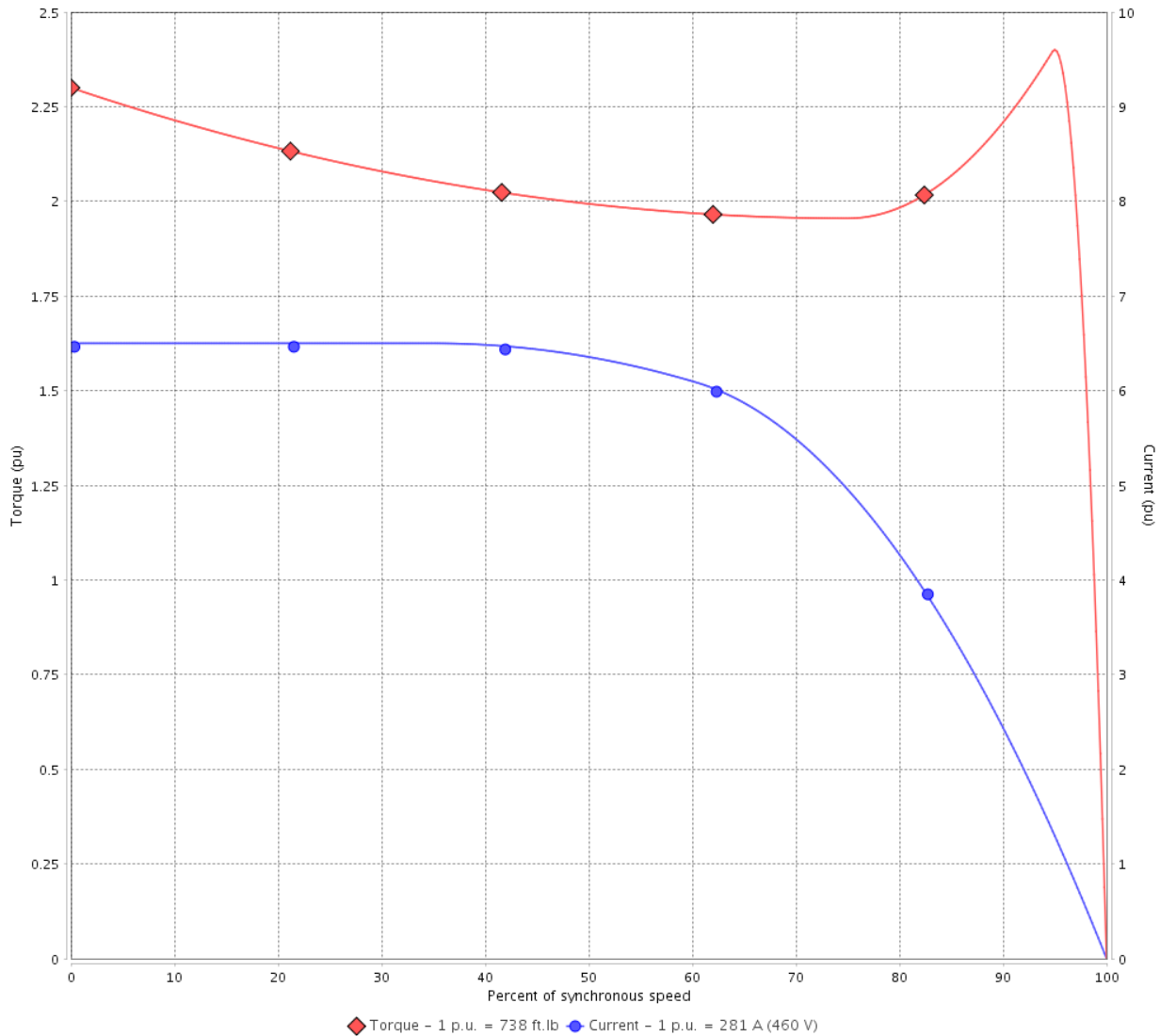

Performance : 460 V 60 Hz 4P

Rated current	: 281 A	Moment of inertia (J)	: 89.6 sq.ft.lb
LRC	: 6.5	Duty cycle	: Cont.(S1)
Rated torque	: 738 ft.lb	Insulation class	: F
Locked rotor torque	: 229 %	Service factor	: 1.15
Breakdown torque	: 240 %	Temperature rise	: 80 K
Rated speed	: 1780 rpm	Design	: B

Locked rotor time : 27s (cold) 15s (hot)

Rev.	Changes Summary	Performed	Checked	Date
Performed by			Page 2 / 36	Revision
Checked by				
Date	13/04/2022			

TORQUE AND CURRENT VS SPEED CURVE



Three Phase Induction Motor - Squirrel Cage

Customer :

Product line : NEMA Premium Efficiency Three-Phase

Product code : 11586547

Catalog # : 25018ET3G447T-W22

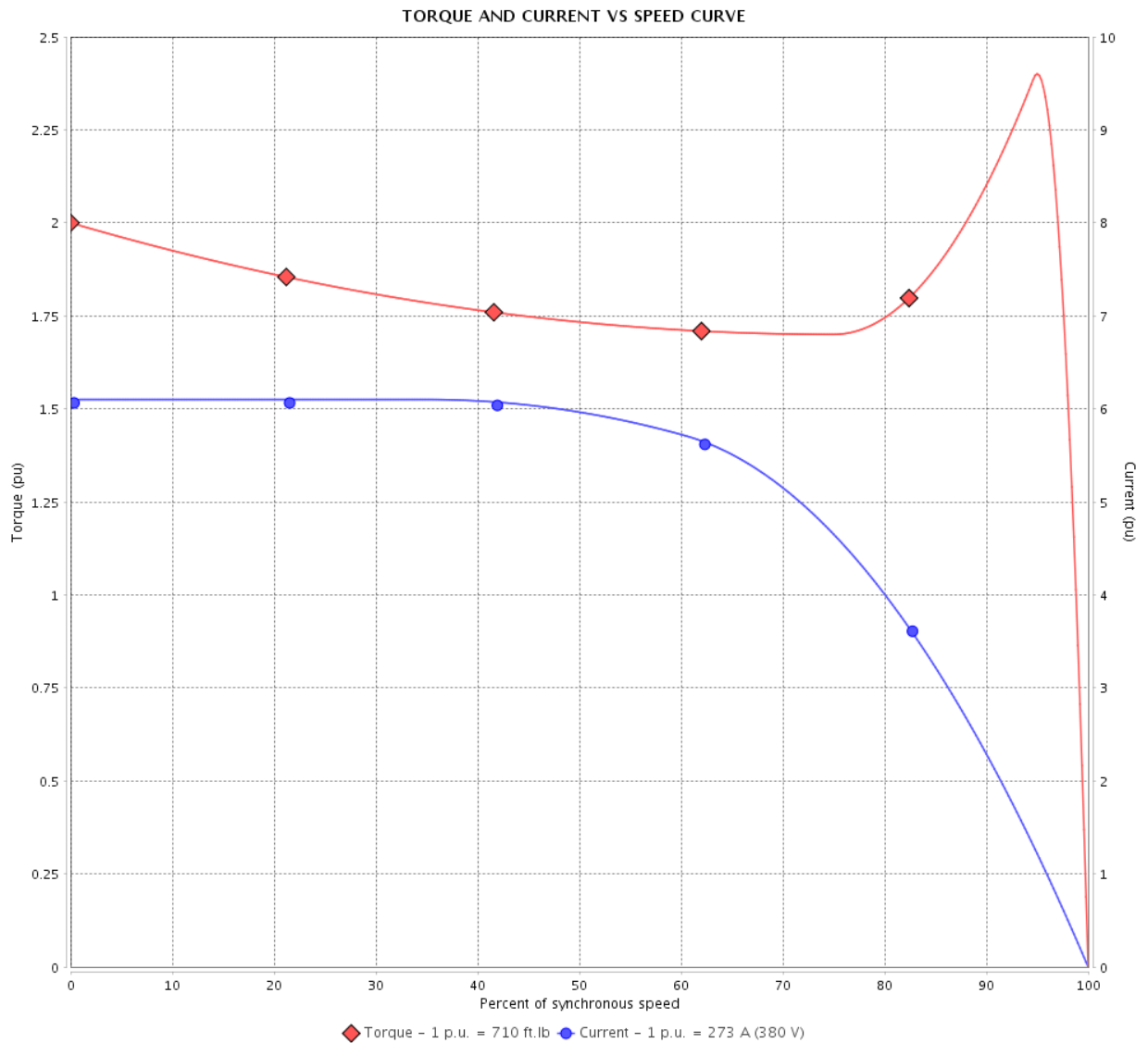

Performance : 380 V 50 Hz 4P IE3

Rated current	: 273 A	Moment of inertia (J)	: 89.6 sq.ft.lb
LRC	: 6.1	Duty cycle	: Cont.(S1)
Rated torque	: 710 ft.lb	Insulation class	: F
Locked rotor torque	: 200 %	Service factor	: 1.15
Breakdown torque	: 240 %	Temperature rise	: 80 K
Rated speed	: 1480 rpm	Design	: B

Locked rotor time : 36s (cold) 20s (hot)

Rev.	Changes Summary	Performed	Checked	Date
Performed by			Page 3 / 36	Revision
Checked by				
Date	13/04/2022			

TORQUE AND CURRENT VS SPEED CURVE

Three Phase Induction Motor - Squirrel Cage



Customer :

Product line : NEMA Premium Efficiency Three-Phase

Product code : 11586547

Catalog # : 25018ET3G447T-W22

TORQUE AND CURRENT VS SPEED CURVE

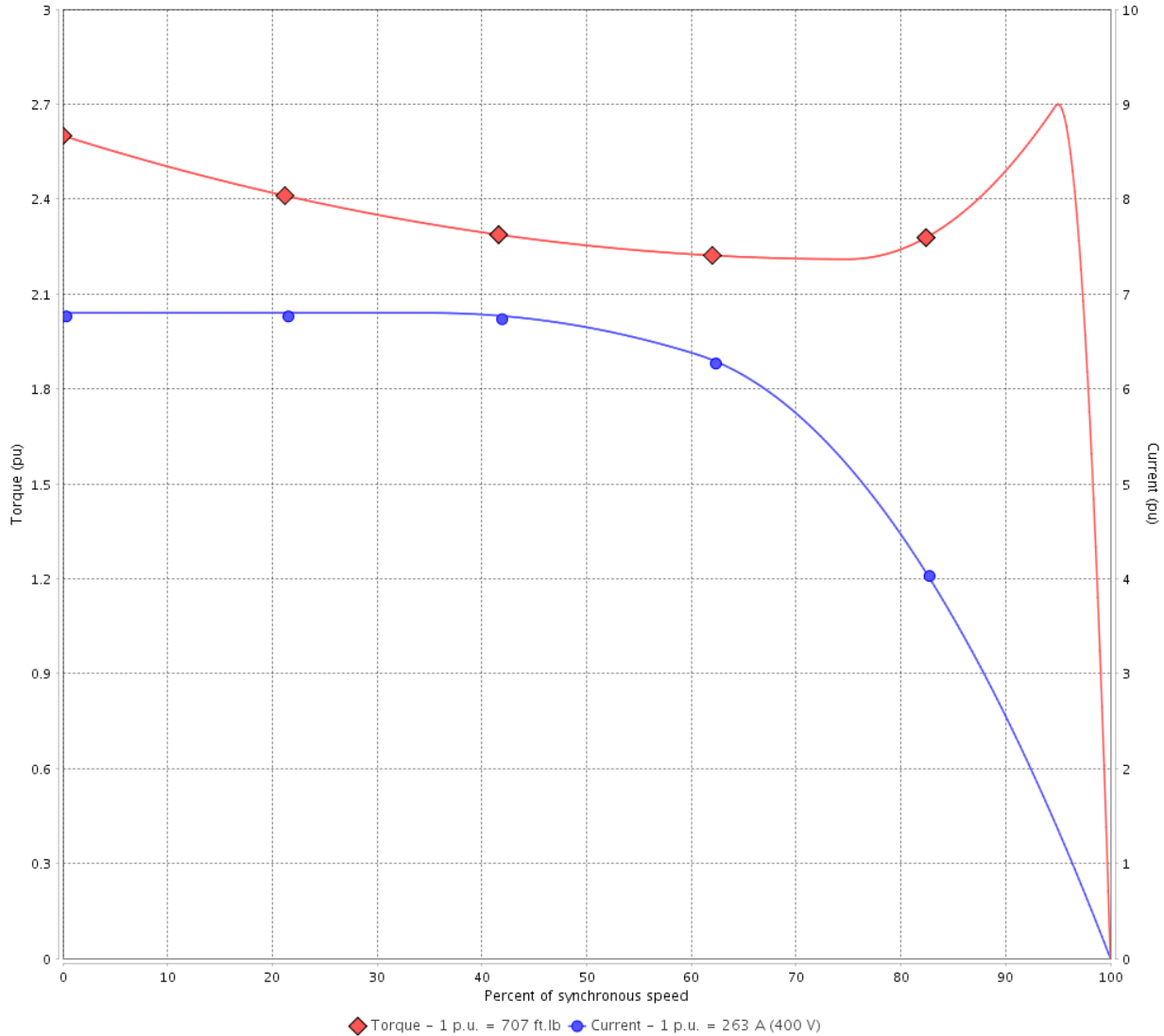

Performance : 400 V 50 Hz 4P IE3

Rated current	: 263 A	Moment of inertia (J)	: 89.6 sq.ft.lb
LRC	: 6.8	Duty cycle	: Cont.(S1)
Rated torque	: 707 ft.lb	Insulation class	: F
Locked rotor torque	: 260 %	Service factor	: 1.15
Breakdown torque	: 270 %	Temperature rise	: 80 K
Rated speed	: 1485 rpm	Design	: B

Locked rotor time : 32s (cold) 18s (hot)

Rev.	Changes Summary	Performed	Checked	Date
Performed by			Page 4 / 36	Revision
Checked by				
Date	13/04/2022			

TORQUE AND CURRENT VS SPEED CURVE



Three Phase Induction Motor - Squirrel Cage

Customer :

Product line : NEMA Premium Efficiency Three-Phase
 Product code : 11586547
 Catalog # : 25018ET3G447T-W22

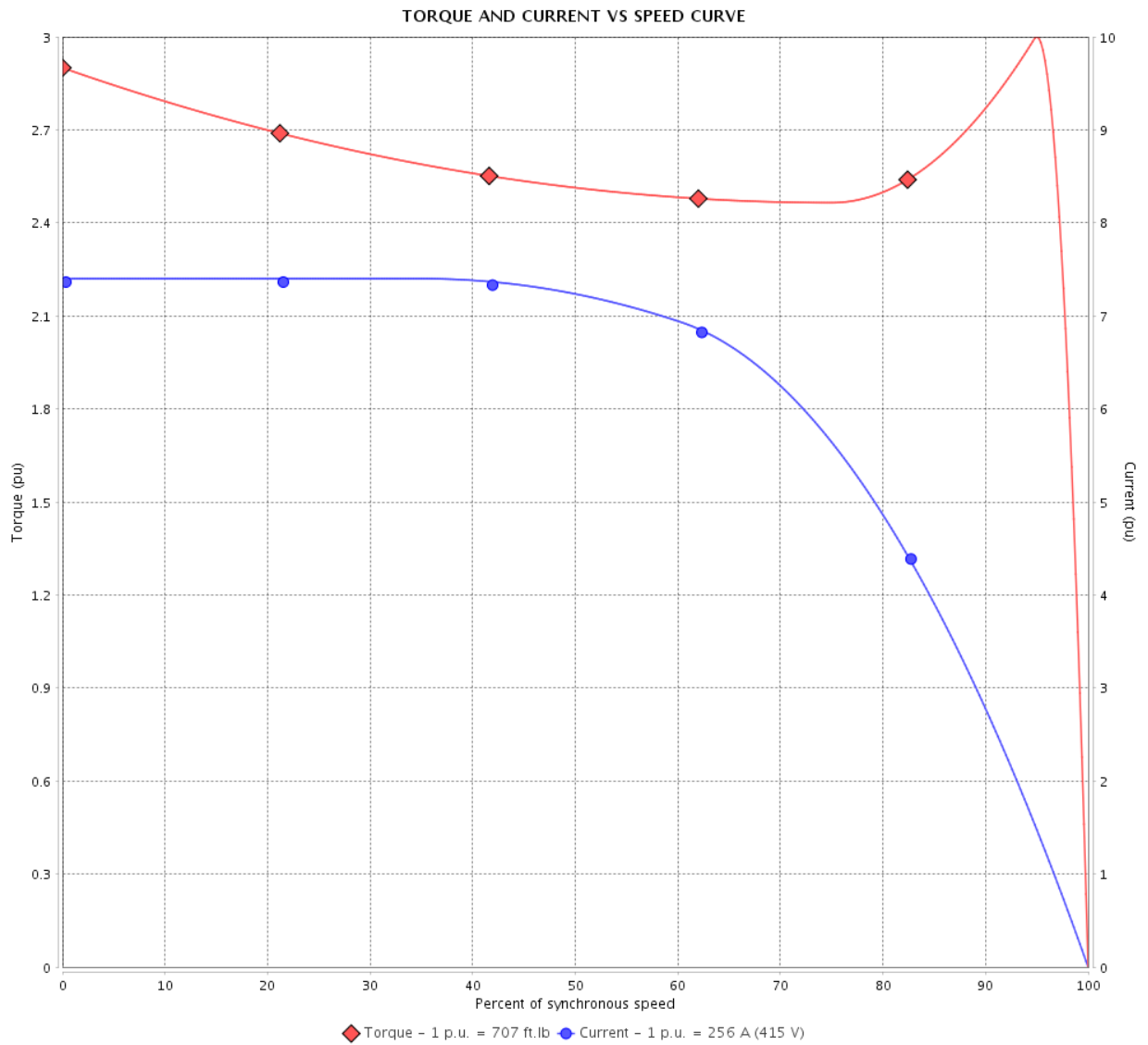

Performance : 415 V 50 Hz 4P IE3

Rated current	: 256 A	Moment of inertia (J)	: 89.6 sq.ft.lb
LRC	: 7.4	Duty cycle	: Cont.(S1)
Rated torque	: 707 ft.lb	Insulation class	: F
Locked rotor torque	: 290 %	Service factor	: 1.15
Breakdown torque	: 300 %	Temperature rise	: 80 K
Rated speed	: 1485 rpm	Design	: B

Locked rotor time : 28s (cold) 16s (hot)

Rev.	Changes Summary	Performed	Checked	Date
Performed by			Page 5 / 36	Revision
Checked by				
Date	13/04/2022			

TORQUE AND CURRENT VS SPEED CURVE

Three Phase Induction Motor - Squirrel Cage



Customer :

Product line : NEMA Premium Efficiency Three-Phase

Product code : 11586547

Catalog # : 25018ET3G447T-W22

TORQUE AND CURRENT VS SPEED CURVE

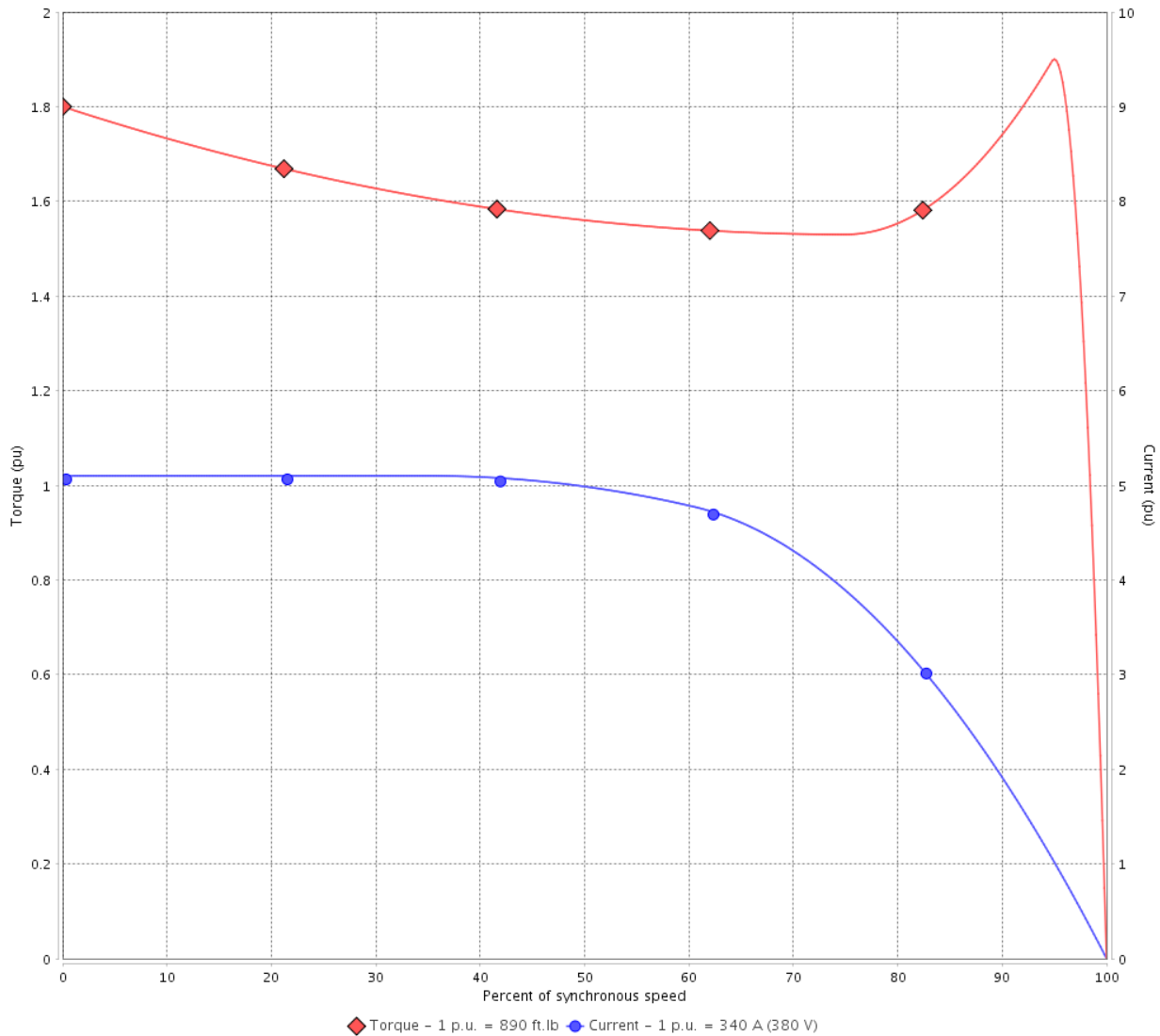

Performance : 380 V 50 Hz 4P IE1

Rated current	: 340 A	Moment of inertia (J)	: 89.6 sq.ft.lb
LRC	: 5.1	Duty cycle	: Cont.(S1)
Rated torque	: 890 ft.lb	Insulation class	: F
Locked rotor torque	: 180 %	Service factor	: 1.00
Breakdown torque	: 190 %	Temperature rise	: 105 K
Rated speed	: 1475 rpm	Design	: B

Locked rotor time : 18s (cold) 10s (hot)

Rev.	Changes Summary	Performed	Checked	Date
Performed by			Page 6 / 36	Revision
Checked by				
Date	13/04/2022			

TORQUE AND CURRENT VS SPEED CURVE



Three Phase Induction Motor - Squirrel Cage

Customer :

Product line : NEMA Premium Efficiency Three-Phase

Product code : 11586547

Catalog # : 25018ET3G447T-W22

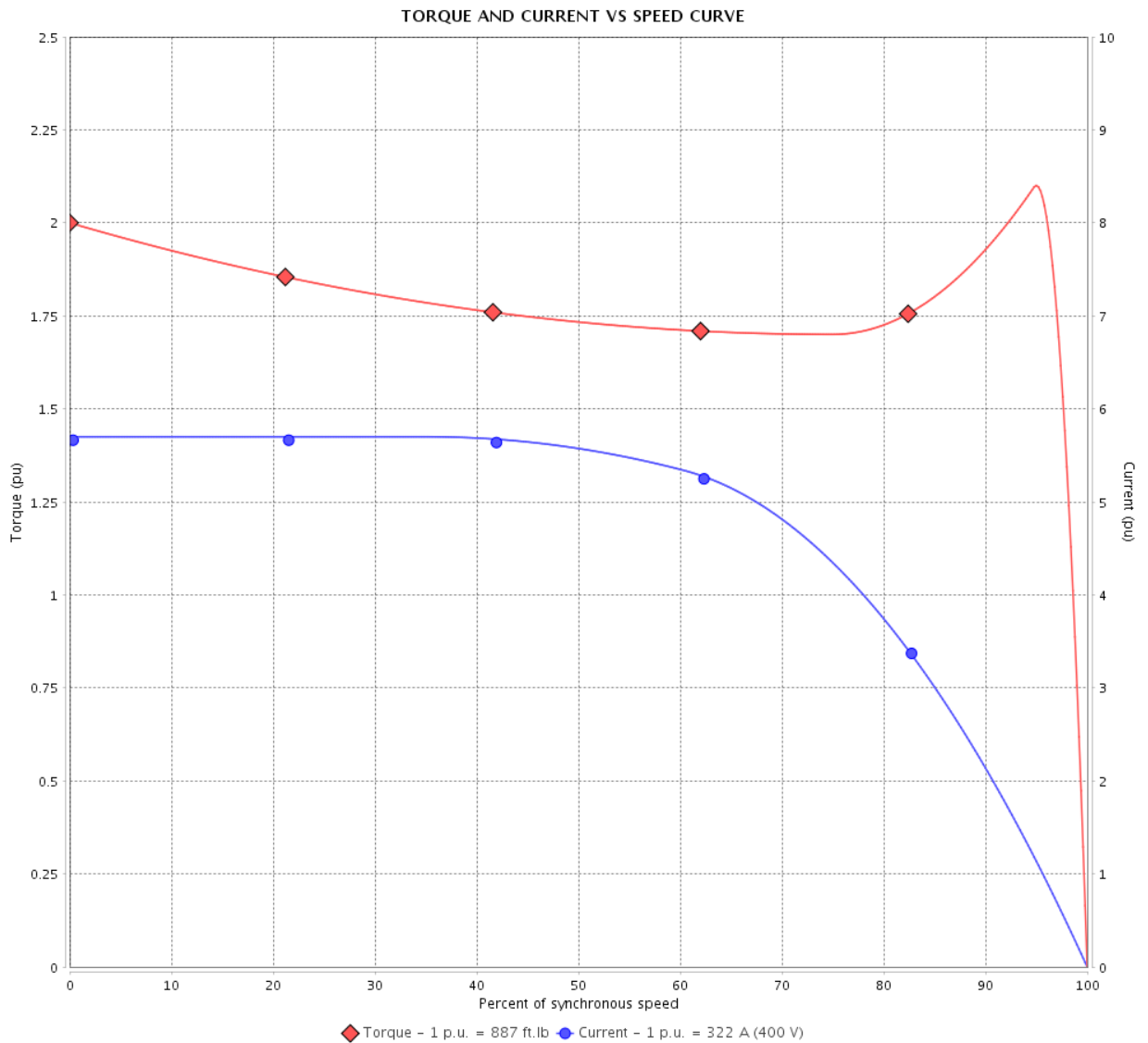

Performance : 400 V 50 Hz 4P IE2

Rated current	: 322 A	Moment of inertia (J)	: 89.6 sq.ft.lb
LRC	: 5.7	Duty cycle	: Cont.(S1)
Rated torque	: 887 ft.lb	Insulation class	: F
Locked rotor torque	: 200 %	Service factor	: 1.00
Breakdown torque	: 210 %	Temperature rise	: 105 K
Rated speed	: 1480 rpm	Design	: B

Locked rotor time : 18s (cold) 10s (hot)

Rev.	Changes Summary	Performed	Checked	Date
Performed by			Page 7 / 36	Revision
Checked by				
Date	13/04/2022			

TORQUE AND CURRENT VS SPEED CURVE

Three Phase Induction Motor - Squirrel Cage



Customer :

Product line : NEMA Premium Efficiency Three-Phase

Product code : 11586547

Catalog # : 25018ET3G447T-W22

TORQUE AND CURRENT VS SPEED CURVE

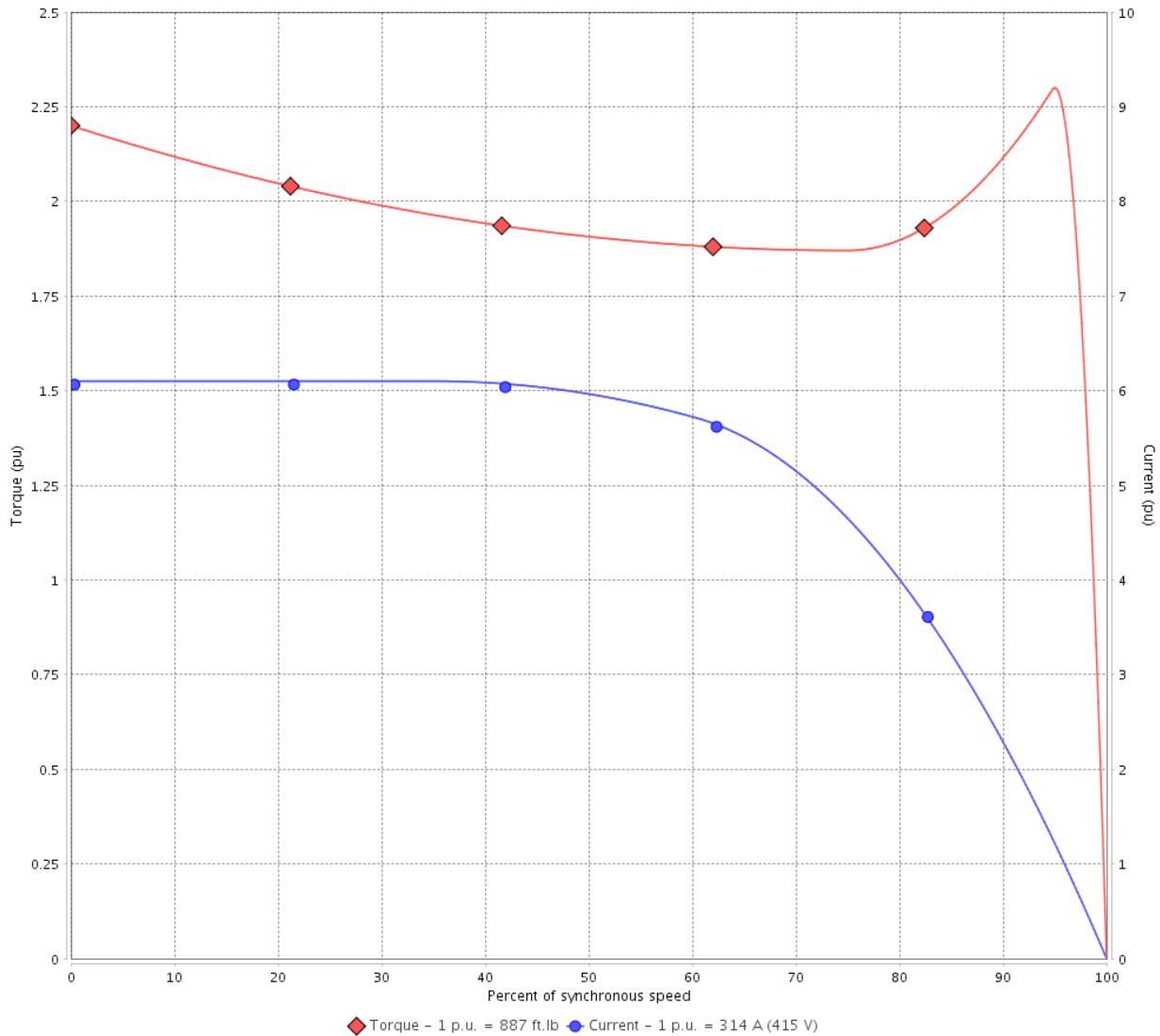

Performance : 415 V 50 Hz 4P IE2

Rated current	: 314 A	Moment of inertia (J)	: 89.6 sq.ft.lb
LRC	: 6.1	Duty cycle	: Cont.(S1)
Rated torque	: 887 ft.lb	Insulation class	: F
Locked rotor torque	: 220 %	Service factor	: 1.00
Breakdown torque	: 229 %	Temperature rise	: 105 K
Rated speed	: 1480 rpm	Design	: B

Locked rotor time : 18s (cold) 10s (hot)

Rev.	Changes Summary	Performed	Checked	Date
Performed by			Page 8 / 36	Revision
Checked by				
Date	13/04/2022			

LOAD PERFORMANCE CURVE

Three Phase Induction Motor - Squirrel Cage



Customer :

Product line : NEMA Premium Efficiency Three-Phase

Product code : 11586547

Catalog # : 25018ET3G447T-W22

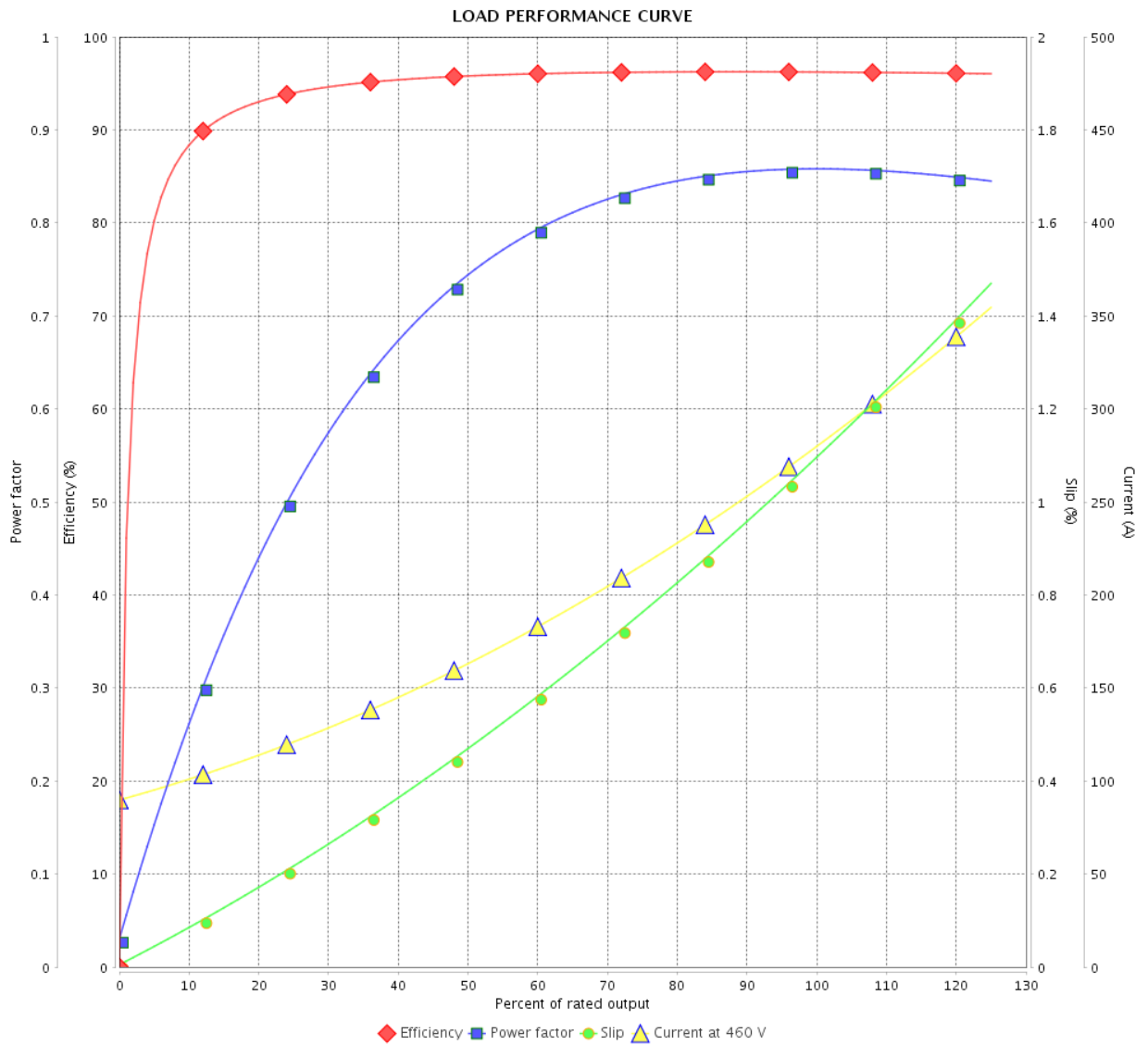

Performance : 460 V 60 Hz 4P

Rated current : 281 A
 LRC : 6.5
 Rated torque : 738 ft.lb
 Locked rotor torque : 229 %
 Breakdown torque : 240 %
 Rated speed : 1780 rpm

Moment of inertia (J) : 89.6 sq.ft.lb
 Duty cycle : Cont.(S1)
 Insulation class : F
 Service factor : 1.15
 Temperature rise : 80 K
 Design : B

Rev.	Changes Summary	Performed	Checked	Date
Performed by			Page	Revision
Checked by				
Date				

LOAD PERFORMANCE CURVE

Three Phase Induction Motor - Squirrel Cage



Customer :

Product line : NEMA Premium Efficiency Three-Phase

Product code : 11586547

Catalog # : 25018ET3G447T-W22

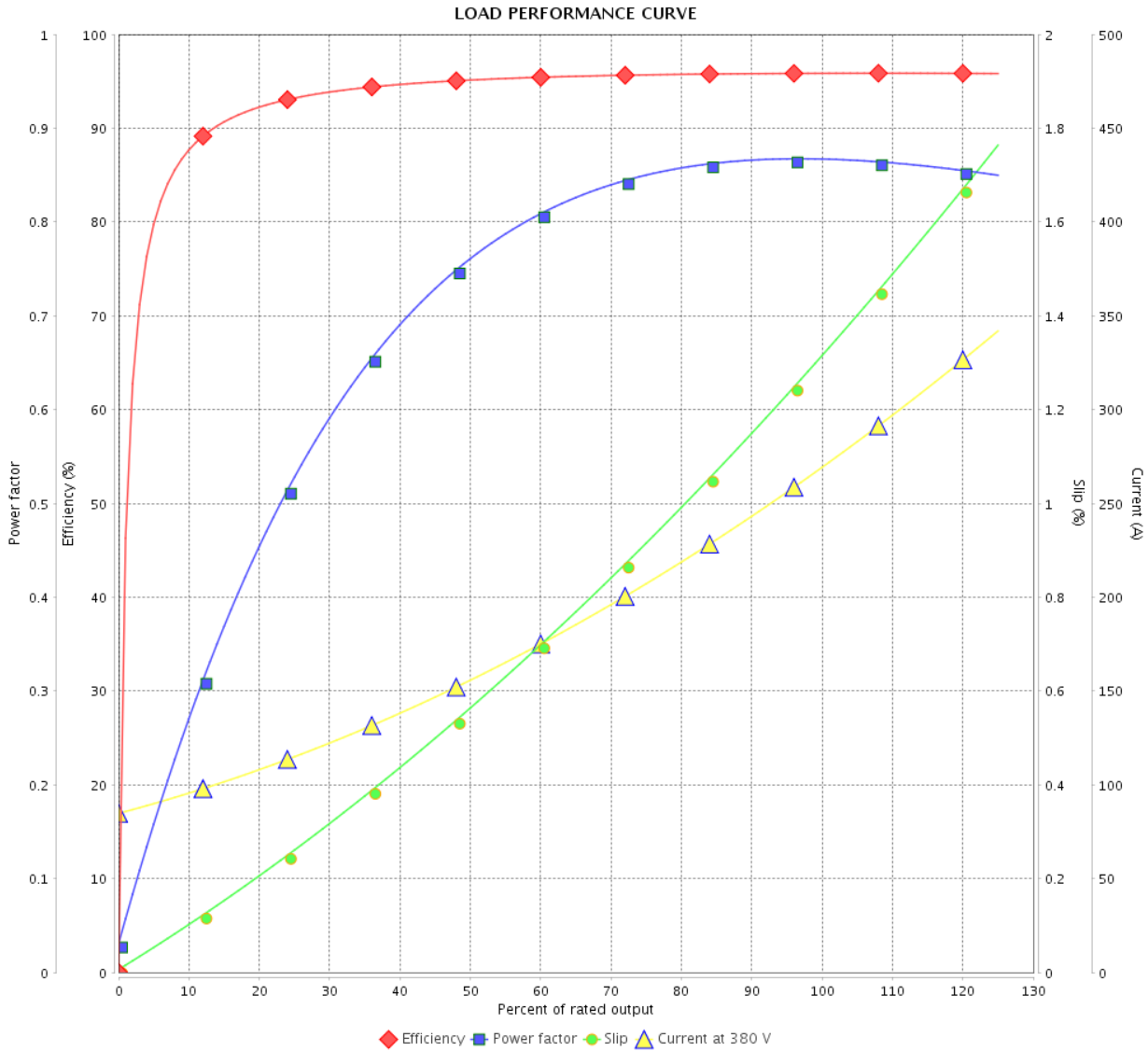

Performance : 380 V 50 Hz 4P IE3

Rated current : 273 A
 LRC : 6.1
 Rated torque : 710 ft.lb
 Locked rotor torque : 200 %
 Breakdown torque : 240 %
 Rated speed : 1480 rpm

Moment of inertia (J) : 89.6 sq.ft.lb
 Duty cycle : Cont.(S1)
 Insulation class : F
 Service factor : 1.15
 Temperature rise : 80 K
 Design : B

Rev.	Changes Summary	Performed	Checked	Date
Performed by			Page 10 / 36	Revision
Checked by				
Date	13/04/2022			

LOAD PERFORMANCE CURVE

Three Phase Induction Motor - Squirrel Cage



Customer :

Product line : NEMA Premium Efficiency Three-Phase

Product code : 11586547

Catalog # : 25018ET3G447T-W22

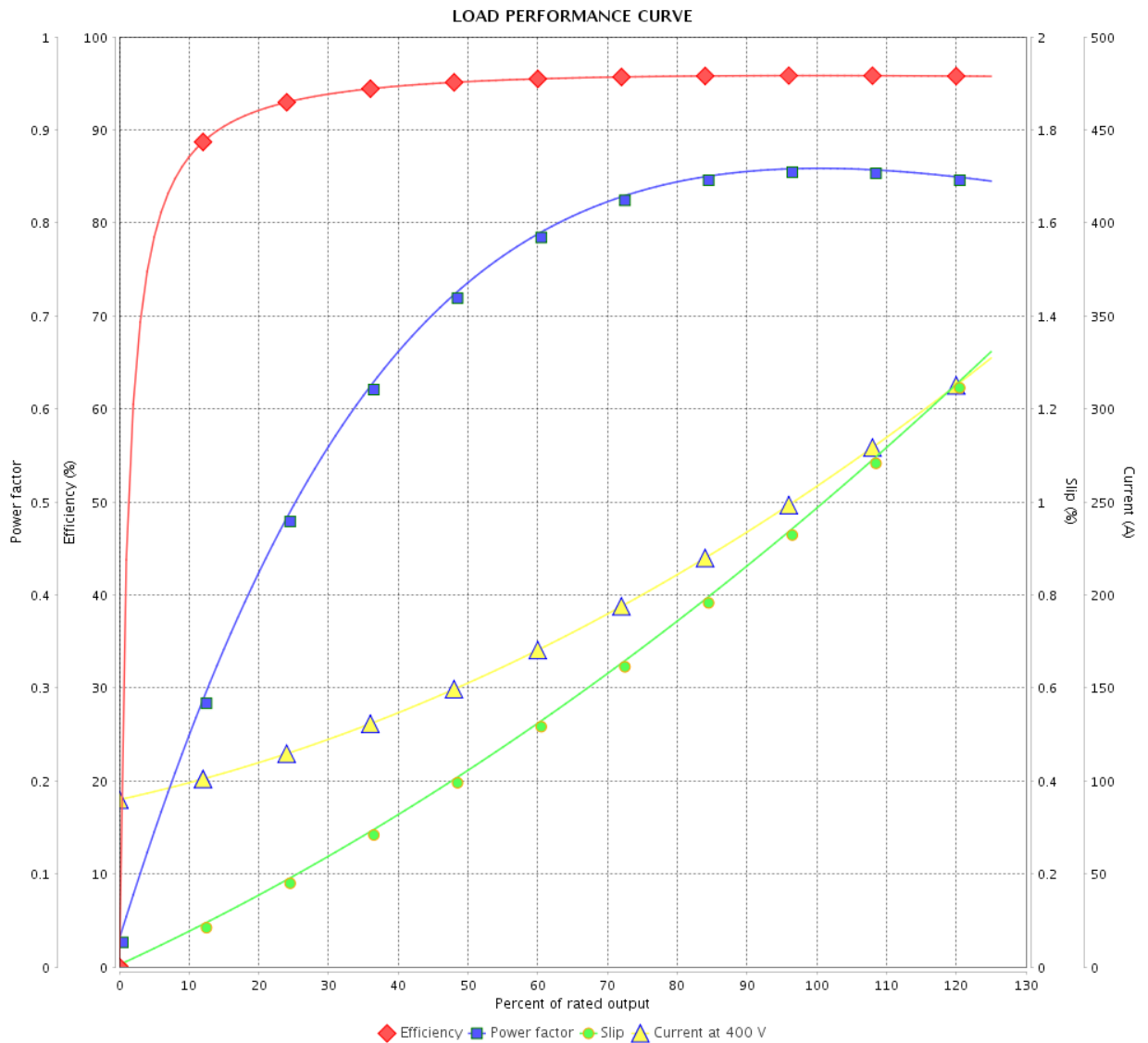

Performance : 400 V 50 Hz 4P IE3

Rated current : 263 A
 LRC : 6.8
 Rated torque : 707 ft.lb
 Locked rotor torque : 260 %
 Breakdown torque : 270 %
 Rated speed : 1485 rpm

Moment of inertia (J) : 89.6 sq.ft.lb
 Duty cycle : Cont.(S1)
 Insulation class : F
 Service factor : 1.15
 Temperature rise : 80 K
 Design : B

Rev.	Changes Summary	Performed	Checked	Date
Performed by			Page	Revision
Checked by			11 / 36	
Date	13/04/2022			

LOAD PERFORMANCE CURVE

Three Phase Induction Motor - Squirrel Cage



Customer : _____

Product line : NEMA Premium Efficiency Three-Phase

Product code : 11586547

Catalog # : 25018ET3G447T-W22

LOAD PERFORMANCE CURVE

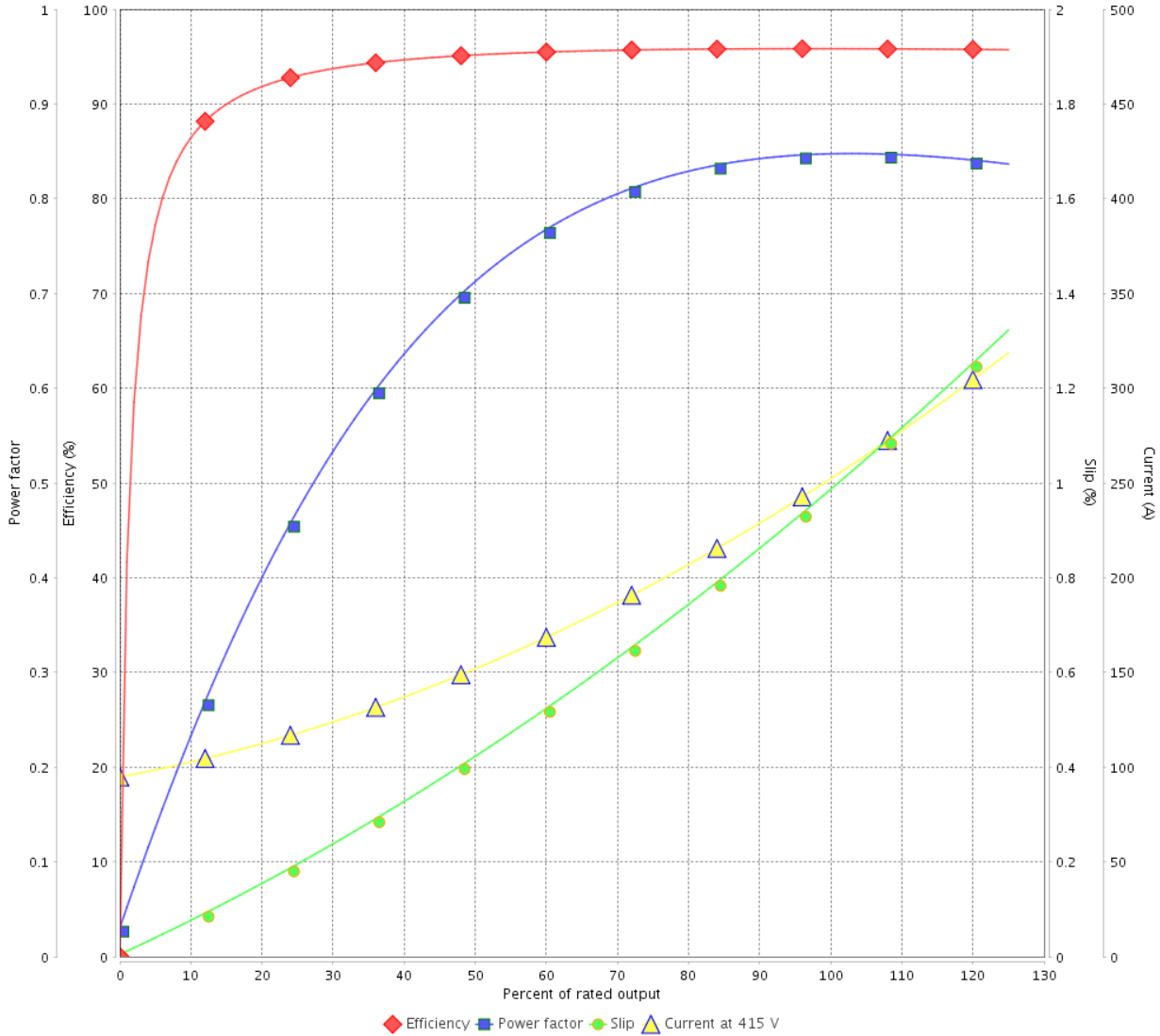

Performance : 415 V 50 Hz 4P IE3

Rated current : 256 A
 LRC : 7.4
 Rated torque : 707 ft.lb
 Locked rotor torque : 290 %
 Breakdown torque : 300 %
 Rated speed : 1485 rpm

Moment of inertia (J) : 89.6 sq.ft.lb
 Duty cycle : Cont.(S1)
 Insulation class : F
 Service factor : 1.15
 Temperature rise : 80 K
 Design : B

Rev.	Changes Summary	Performed	Checked	Date
Performed by			Page 12 / 36	Revision
Checked by				
Date	13/04/2022			

LOAD PERFORMANCE CURVE

Three Phase Induction Motor - Squirrel Cage



Customer :

Product line : NEMA Premium Efficiency Three-Phase

Product code : 11586547

Catalog # : 25018ET3G447T-W22

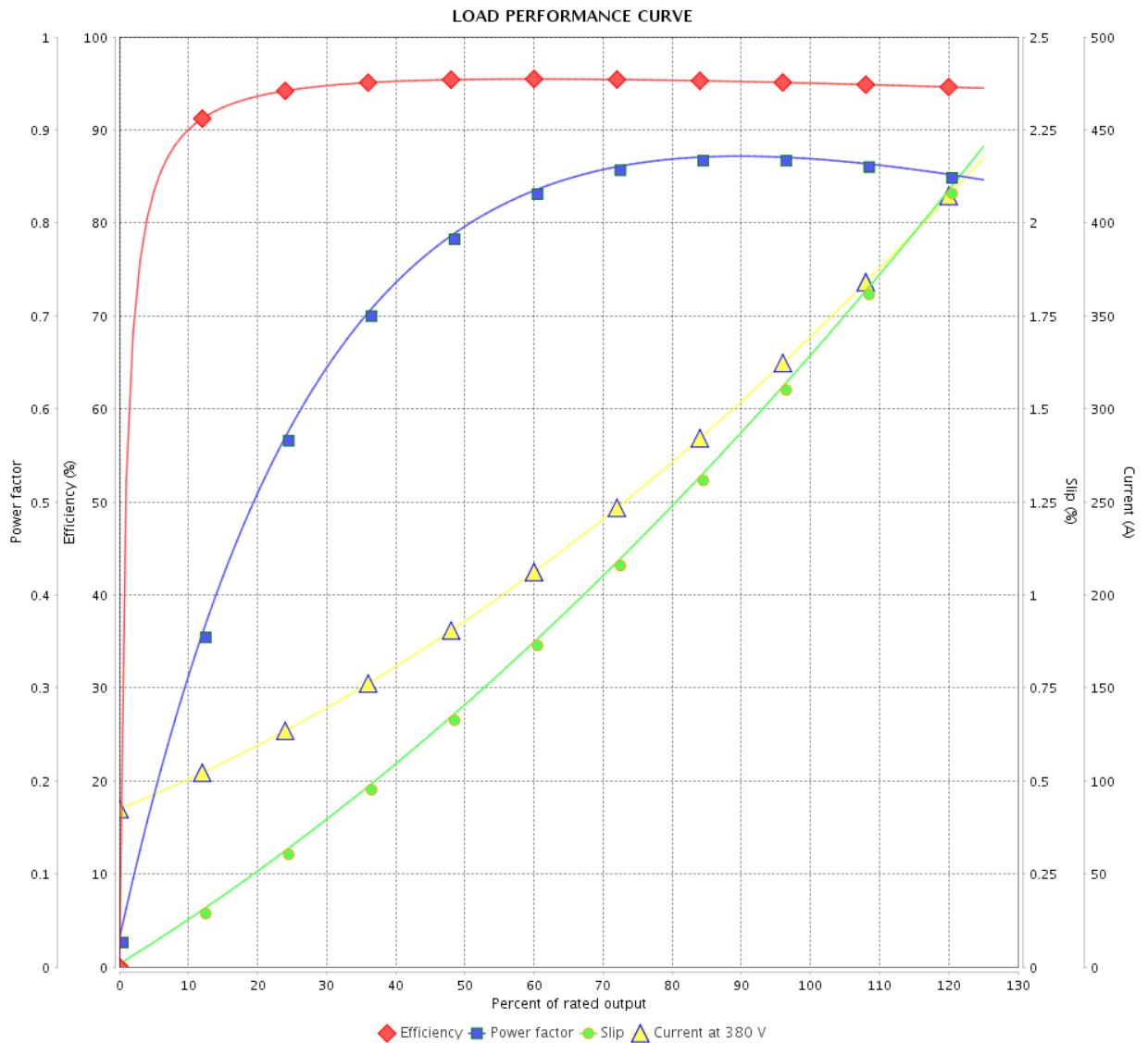

Performance : 380 V 50 Hz 4P IE1

Rated current : 340 A
 LRC : 5.1
 Rated torque : 890 ft.lb
 Locked rotor torque : 180 %
 Breakdown torque : 190 %
 Rated speed : 1475 rpm

Moment of inertia (J) : 89.6 sq.ft.lb
 Duty cycle : Cont.(S1)
 Insulation class : F
 Service factor : 1.00
 Temperature rise : 105 K
 Design : B

Rev.	Changes Summary	Performed	Checked	Date
Performed by				
Checked by				
Date				
		Page	Revision	
		13 / 36		

LOAD PERFORMANCE CURVE

Three Phase Induction Motor - Squirrel Cage



Customer : _____

Product line : NEMA Premium Efficiency Three-Phase

Product code : 11586547

Catalog # : 25018ET3G447T-W22

LOAD PERFORMANCE CURVE

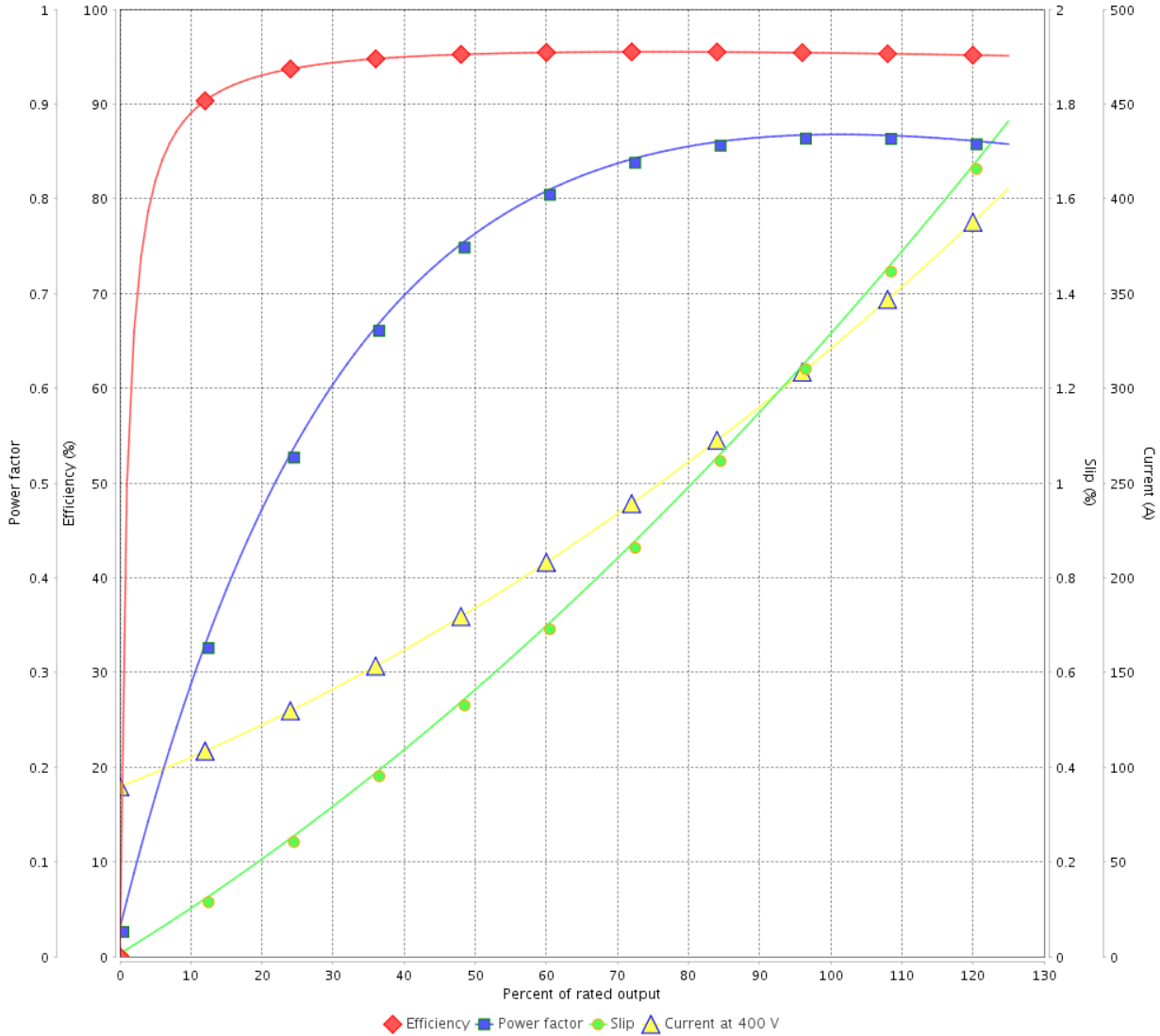

Performance : 400 V 50 Hz 4P IE2

Rated current : 322 A
 LRC : 5.7
 Rated torque : 887 ft.lb
 Locked rotor torque : 200 %
 Breakdown torque : 210 %
 Rated speed : 1480 rpm

Moment of inertia (J) : 89.6 sq.ft.lb
 Duty cycle : Cont.(S1)
 Insulation class : F
 Service factor : 1.00
 Temperature rise : 105 K
 Design : B

Rev.	Changes Summary	Performed	Checked	Date
Performed by			Page 14 / 36	Revision
Checked by				
Date	13/04/2022			

LOAD PERFORMANCE CURVE

Three Phase Induction Motor - Squirrel Cage



Customer : _____

Product line : NEMA Premium Efficiency Three-Phase

Product code : 11586547

Catalog # : 25018ET3G447T-W22

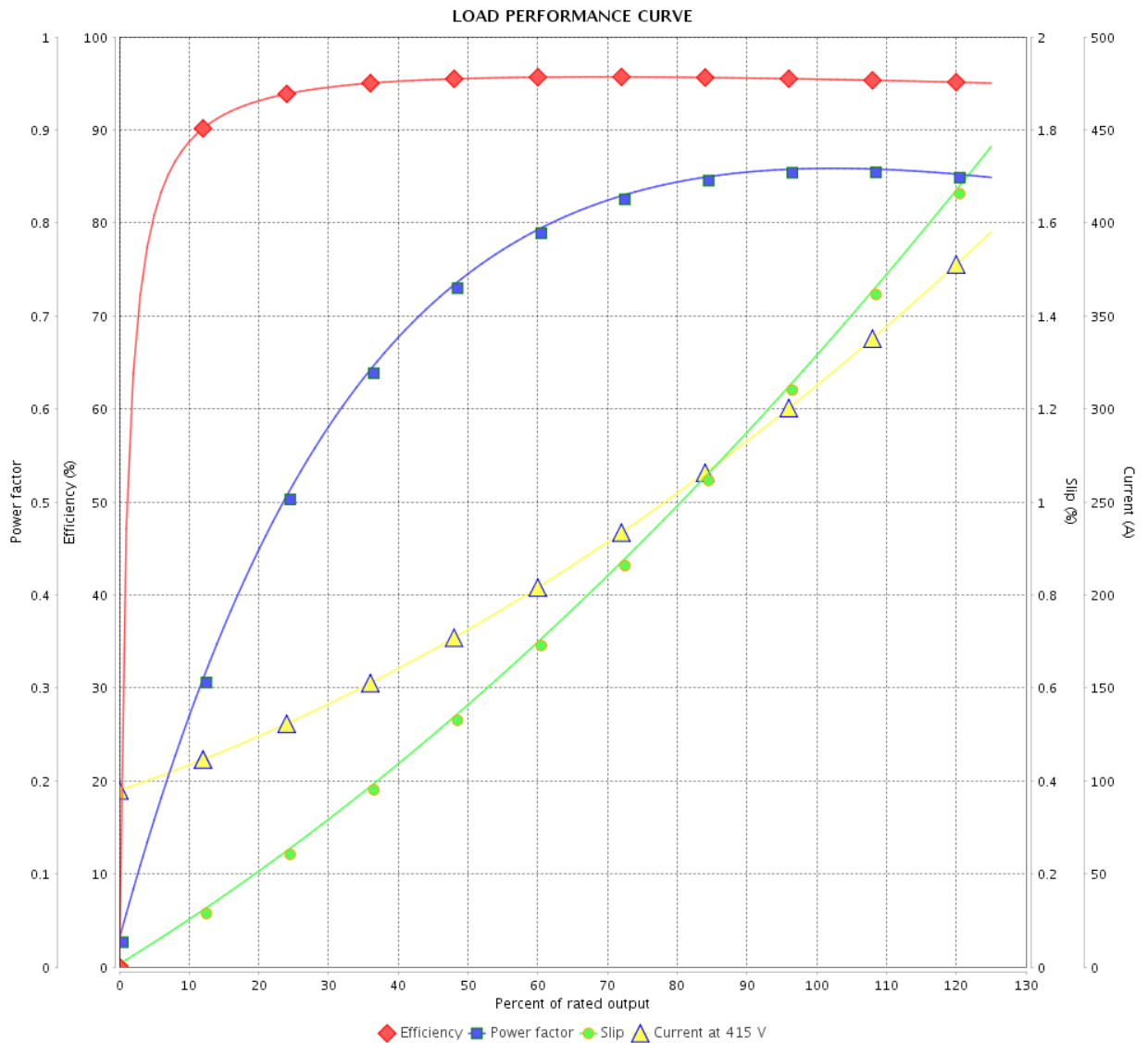

Performance : 415 V 50 Hz 4P IE2

Rated current : 314 A
 LRC : 6.1
 Rated torque : 887 ft.lb
 Locked rotor torque : 220 %
 Breakdown torque : 229 %
 Rated speed : 1480 rpm

Moment of inertia (J) : 89.6 sq.ft.lb
 Duty cycle : Cont.(S1)
 Insulation class : F
 Service factor : 1.00
 Temperature rise : 105 K
 Design : B

Rev.	Changes Summary	Performed	Checked	Date
Performed by		Page		Revision
Checked by		15 / 36		
Date		13/04/2022		

THERMAL LIMIT CURVE



Three Phase Induction Motor - Squirrel Cage

Customer :

Product line : NEMA Premium Efficiency Three-Phase
 Product code : 11586547
 Catalog # : 25018ET3G447T-W22

Performance : 460 V 60 Hz 4P

Rated current : 281 A	Moment of inertia (J) : 89.6 sq.ft.lb
LRC : 6.5	Duty cycle : Cont.(S1)
Rated torque : 738 ft.lb	Insulation class : F
Locked rotor torque : 229 %	Service factor : 1.15
Breakdown torque : 240 %	Temperature rise : 80 K
Rated speed : 1780 rpm	Design : B

Heating constant

Cooling constant

Rev.	Changes Summary	Performed	Checked	Date
Performed by			Page 16 / 36	Revision
Checked by				
Date	13/04/2022			

THERMAL LIMIT CURVE

Three Phase Induction Motor - Squirrel Cage



Customer : _____

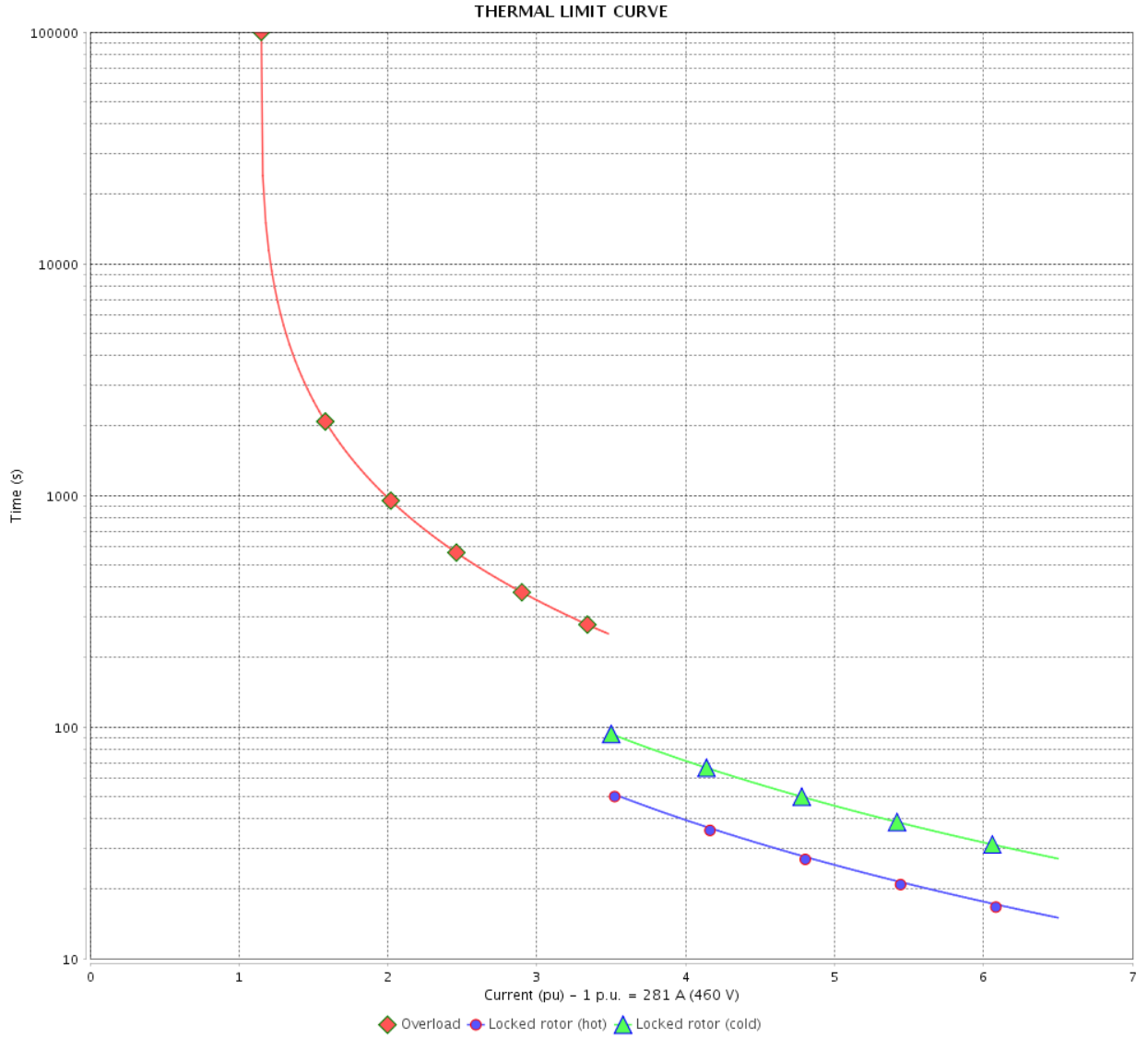

Rev.	Changes Summary	Performed	Checked	Date
Performed by		Page		Revision
Checked by		17 / 36		
Date		13/04/2022		

THERMAL LIMIT CURVE

Three Phase Induction Motor - Squirrel Cage



Customer :

Product line : NEMA Premium Efficiency Three-Phase
Product code : 11586547
Catalog # : 25018ET3G447T-W22

Performance : 380 V 50 Hz 4P IE3

Rated current	: 273 A	Moment of inertia (J)	: 89.6 sq.ft.lb
LRC	: 6.1	Duty cycle	: Cont.(S1)
Rated torque	: 710 ft.lb	Insulation class	: F
Locked rotor torque	: 200 %	Service factor	: 1.15
Breakdown torque	: 240 %	Temperature rise	: 80 K
Rated speed	: 1480 rpm	Design	: B

Heating constant

Cooling constant

Rev.	Changes Summary	Performed	Checked	Date
Performed by				
Checked by			Page	Revision
Date	13/04/2022		18 / 36	

THERMAL LIMIT CURVE

Three Phase Induction Motor - Squirrel Cage



Customer : _____

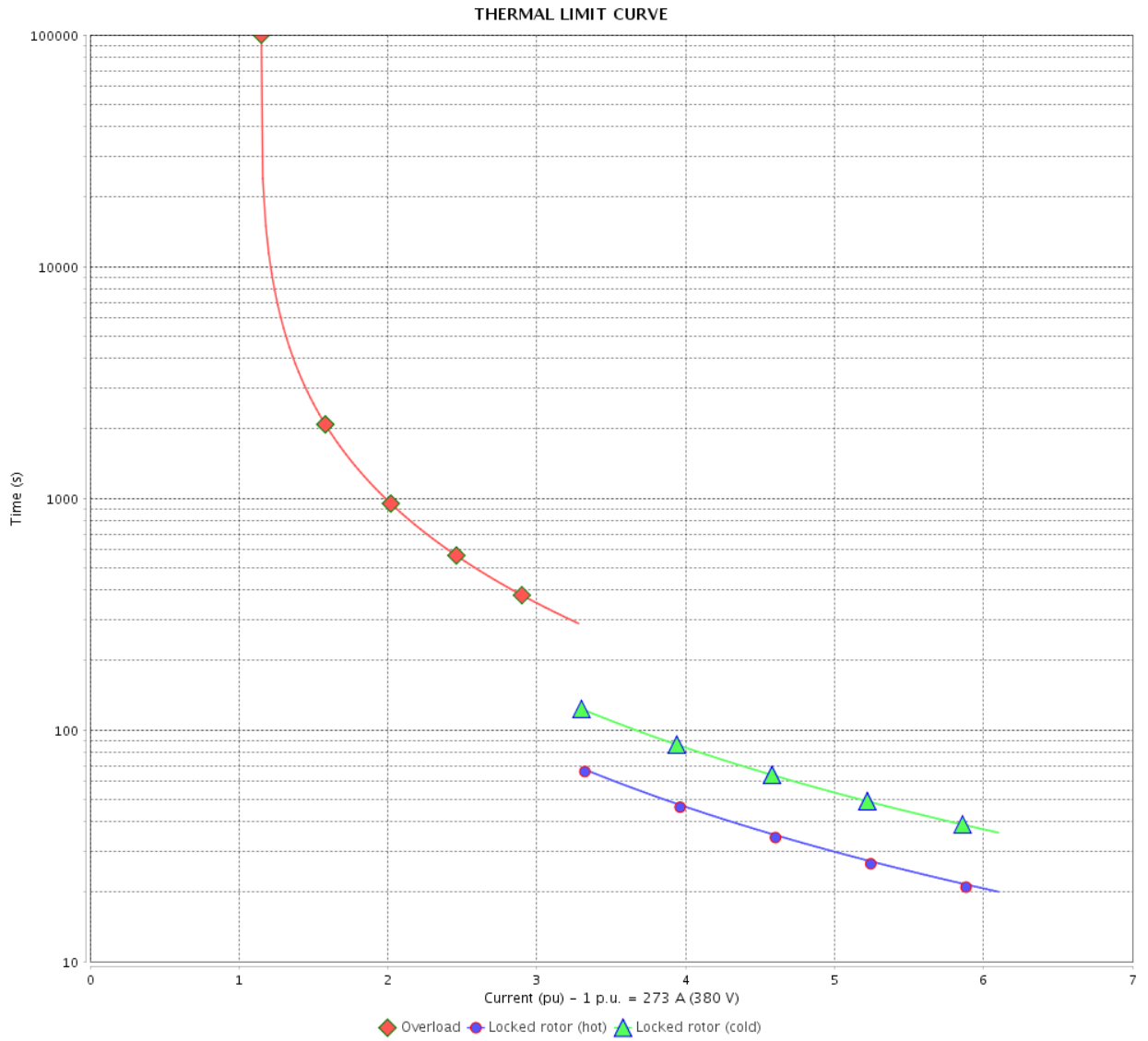

Rev.	Changes Summary	Performed	Checked	Date
Performed by		Page 19 / 36		Revision
Checked by				
Date				

THERMAL LIMIT CURVE

Three Phase Induction Motor - Squirrel Cage



Customer :

Product line : NEMA Premium Efficiency Three-Phase
Product code : 11586547
Catalog # : 25018ET3G447T-W22

Performance : 400 V 50 Hz 4P IE3

Rated current	: 263 A	Moment of inertia (J)	: 89.6 sq.ft.lb
LRC	: 6.8	Duty cycle	: Cont.(S1)
Rated torque	: 707 ft.lb	Insulation class	: F
Locked rotor torque	: 260 %	Service factor	: 1.15
Breakdown torque	: 270 %	Temperature rise	: 80 K
Rated speed	: 1485 rpm	Design	: B

Heating constant

Cooling constant

Rev.	Changes Summary	Performed	Checked	Date
Performed by				
Checked by			Page	Revision
Date	13/04/2022		20 / 36	

THERMAL LIMIT CURVE

Three Phase Induction Motor - Squirrel Cage



Customer : _____

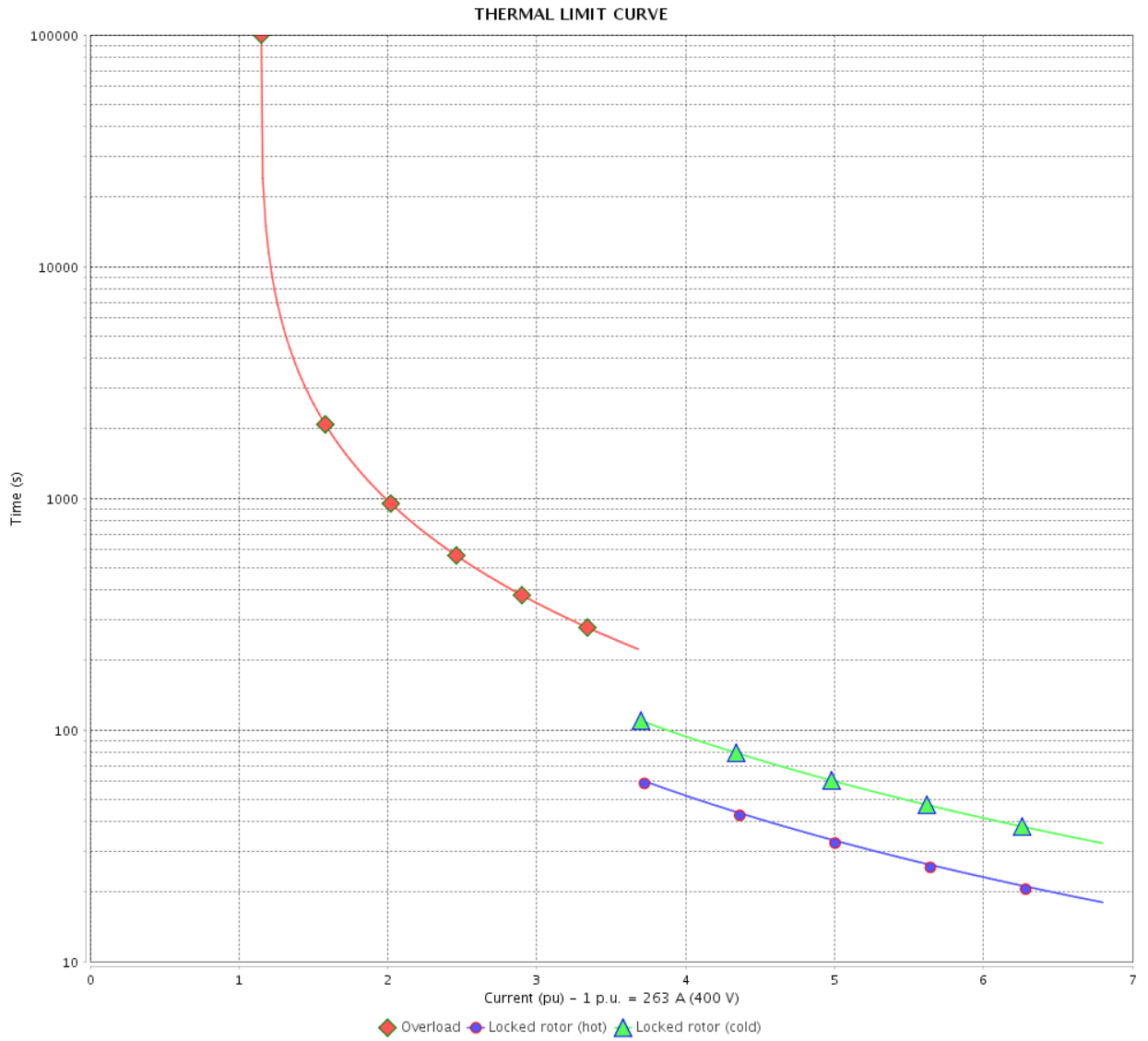

Rev.	Changes Summary	Performed	Checked	Date
Performed by		Page 21 / 36		Revision
Checked by				
Date				

THERMAL LIMIT CURVE

Three Phase Induction Motor - Squirrel Cage



Customer :

Product line : NEMA Premium Efficiency Three-Phase
Product code : 11586547
Catalog # : 25018ET3G447T-W22

Performance : 415 V 50 Hz 4P IE3

Rated current	: 256 A	Moment of inertia (J)	: 89.6 sq.ft.lb
LRC	: 7.4	Duty cycle	: Cont.(S1)
Rated torque	: 707 ft.lb	Insulation class	: F
Locked rotor torque	: 290 %	Service factor	: 1.15
Breakdown torque	: 300 %	Temperature rise	: 80 K
Rated speed	: 1485 rpm	Design	: B

Heating constant

Cooling constant

Rev.	Changes Summary	Performed	Checked	Date
Performed by				
Checked by			Page	Revision
Date	13/04/2022		22 / 36	

THERMAL LIMIT CURVE

Three Phase Induction Motor - Squirrel Cage



Customer : _____

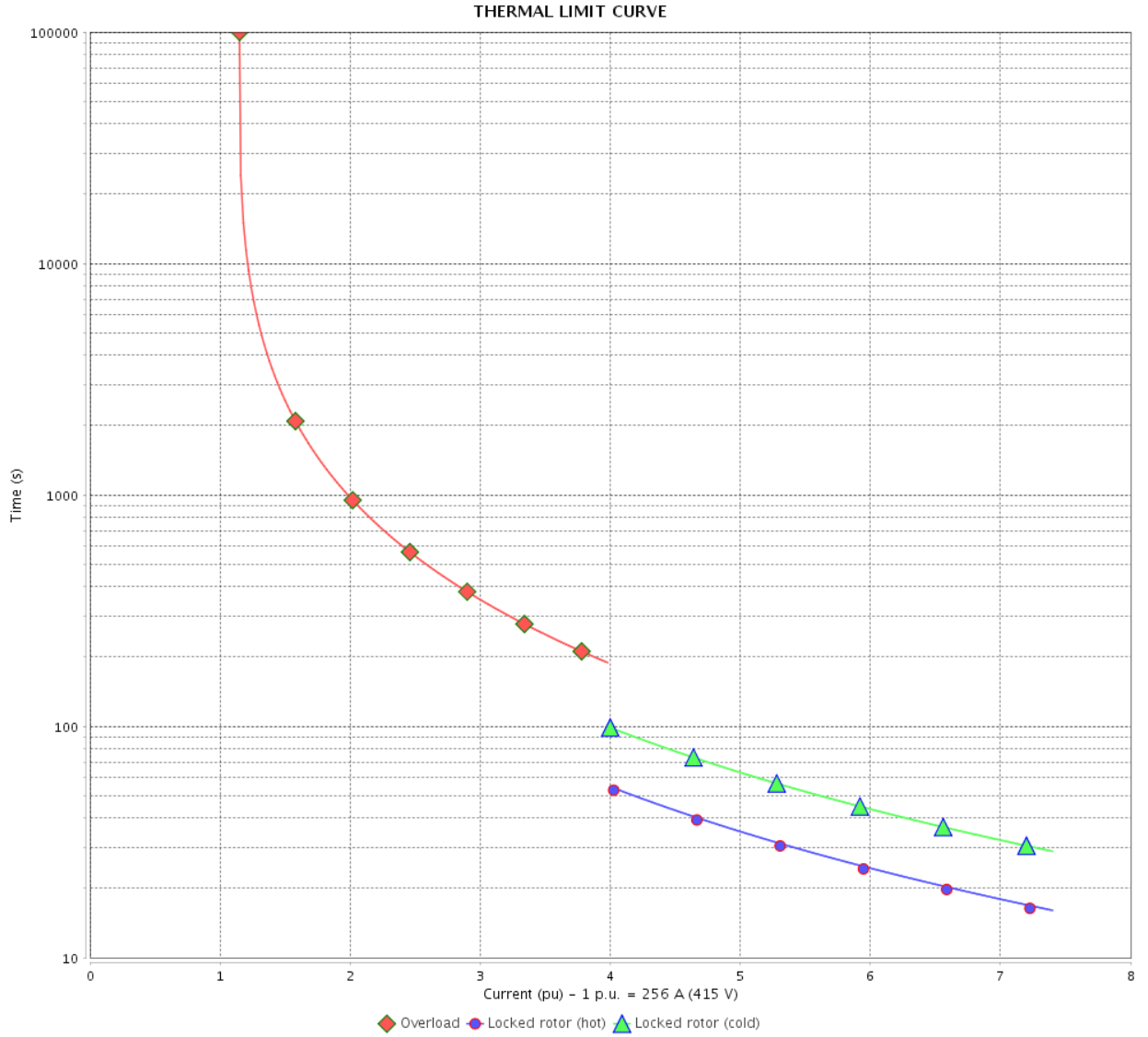

Rev.	Changes Summary	Performed	Checked	Date
Performed by		Page		Revision
Checked by		23 / 36		
Date		13/04/2022		

THERMAL LIMIT CURVE

Three Phase Induction Motor - Squirrel Cage



Customer :

Product line : NEMA Premium Efficiency Three-Phase
Product code : 11586547
Catalog # : 25018ET3G447T-W22

Performance : 380 V 50 Hz 4P IE1

Rated current	: 340 A	Moment of inertia (J)	: 89.6 sq.ft.lb
LRC	: 5.1	Duty cycle	: Cont.(S1)
Rated torque	: 890 ft.lb	Insulation class	: F
Locked rotor torque	: 180 %	Service factor	: 1.00
Breakdown torque	: 190 %	Temperature rise	: 105 K
Rated speed	: 1475 rpm	Design	: B

Heating constant

Cooling constant

Rev.	Changes Summary	Performed	Checked	Date
Performed by				
Checked by			Page	Revision
Date	13/04/2022		24 / 36	

THERMAL LIMIT CURVE

Three Phase Induction Motor - Squirrel Cage



Customer : _____

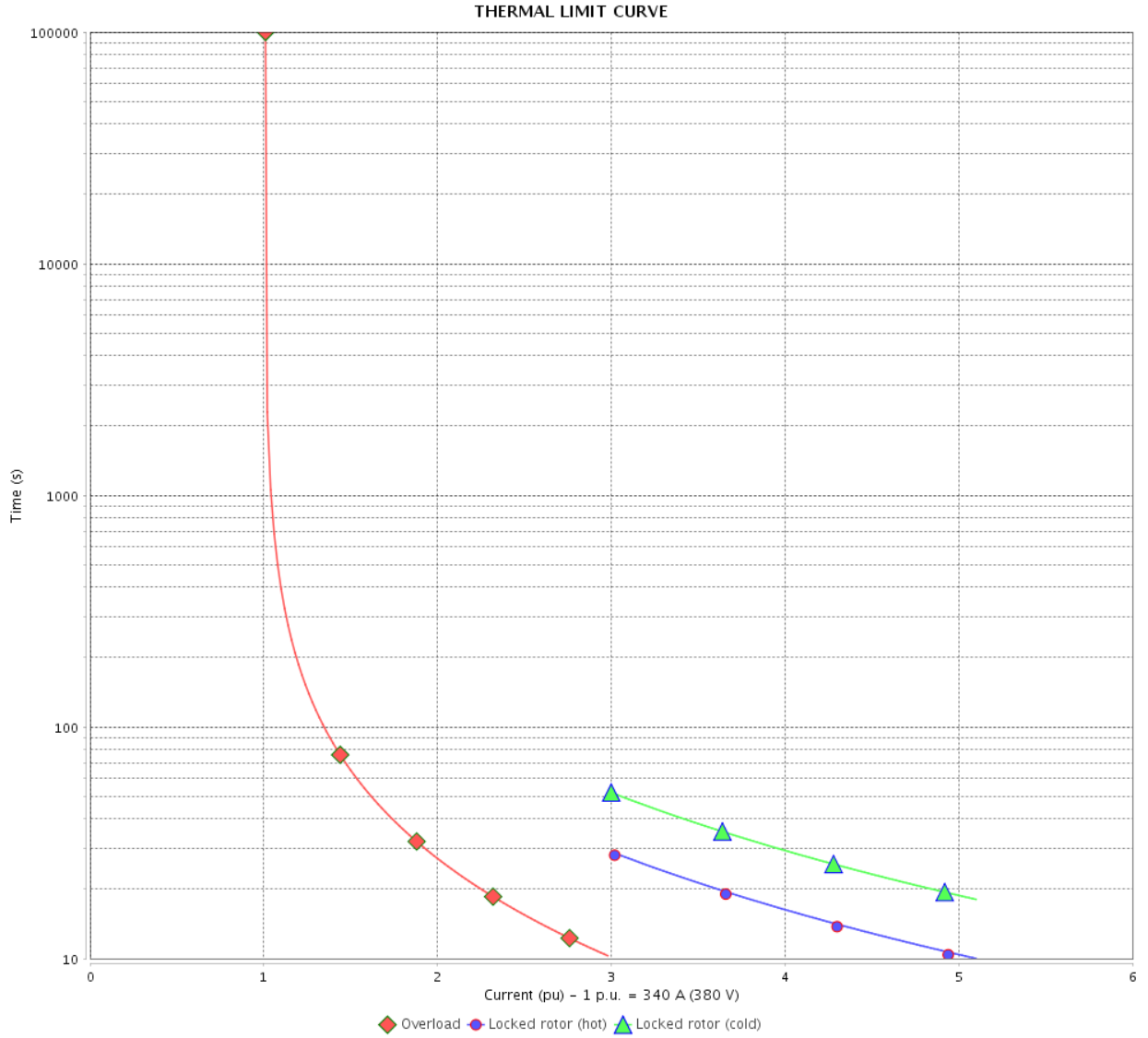

Rev.	Changes Summary	Performed	Checked	Date
Performed by				
Checked by				
Date				
			Page	Revision
			25 / 36	

THERMAL LIMIT CURVE



Three Phase Induction Motor - Squirrel Cage

Customer :

Product line : NEMA Premium Efficiency Three-Phase
Product code : 11586547
Catalog # : 25018ET3G447T-W22

Performance : 400 V 50 Hz 4P IE2

Rated current	: 322 A	Moment of inertia (J)	: 89.6 sq.ft.lb
LRC	: 5.7	Duty cycle	: Cont.(S1)
Rated torque	: 887 ft.lb	Insulation class	: F
Locked rotor torque	: 200 %	Service factor	: 1.00
Breakdown torque	: 210 %	Temperature rise	: 105 K
Rated speed	: 1480 rpm	Design	: B

Heating constant

Cooling constant

Rev.	Changes Summary	Performed	Checked	Date
Performed by				
Checked by			Page	Revision
Date	13/04/2022		26 / 36	

THERMAL LIMIT CURVE

Three Phase Induction Motor - Squirrel Cage



Customer : _____

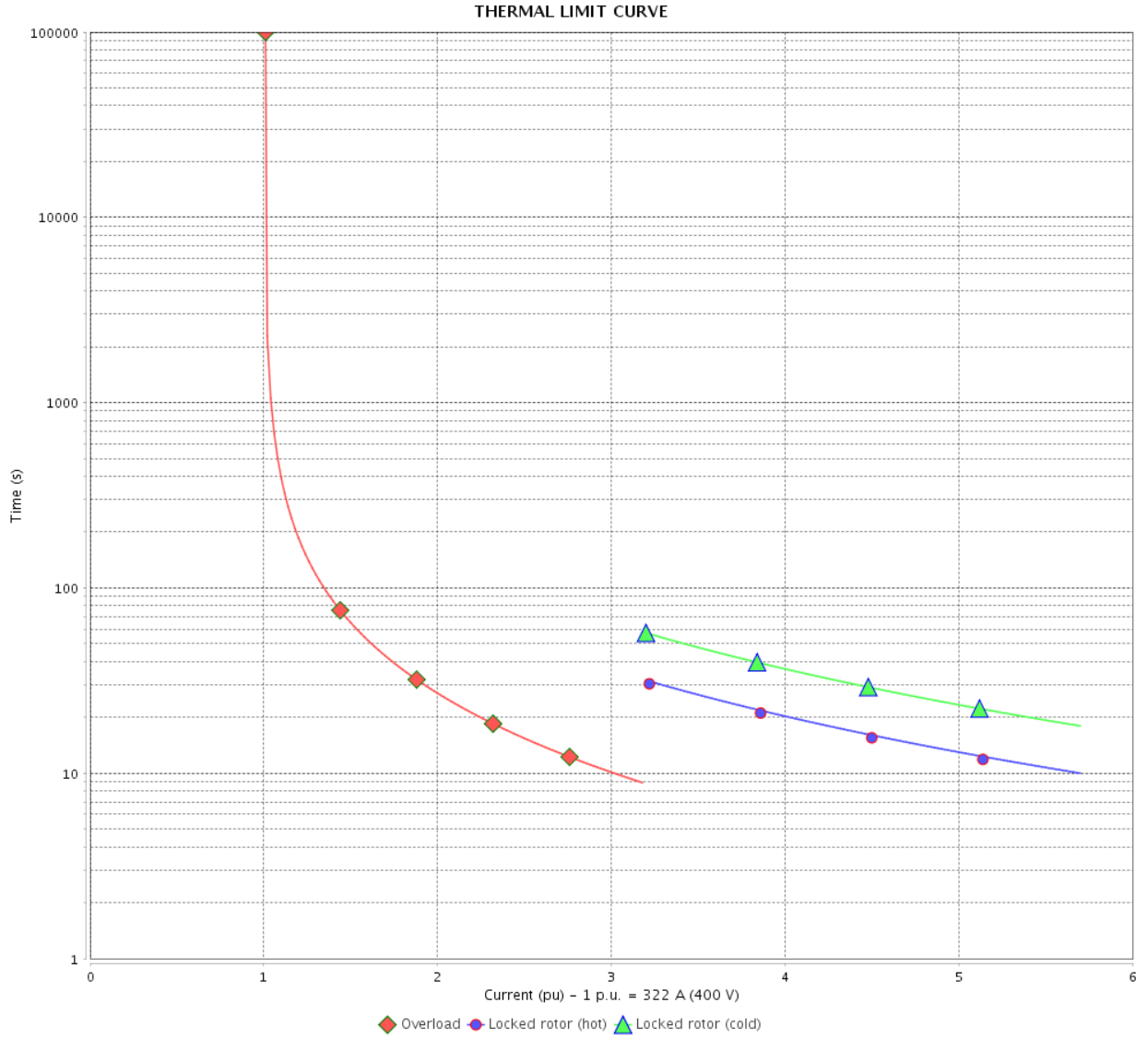

Rev.	Changes Summary	Performed	Checked	Date
Performed by		Page		Revision
Checked by		27 / 36		
Date		13/04/2022		

THERMAL LIMIT CURVE



Three Phase Induction Motor - Squirrel Cage

Customer :

Product line : NEMA Premium Efficiency Three-Phase
 Product code : 11586547
 Catalog # : 25018ET3G447T-W22

Performance : 415 V 50 Hz 4P IE2

Rated current : 314 A	Moment of inertia (J) : 89.6 sq.ft.lb
LRC : 6.1	Duty cycle : Cont.(S1)
Rated torque : 887 ft.lb	Insulation class : F
Locked rotor torque : 220 %	Service factor : 1.00
Breakdown torque : 229 %	Temperature rise : 105 K
Rated speed : 1480 rpm	Design : B

Heating constant

Cooling constant

Rev.	Changes Summary	Performed	Checked	Date
Performed by			Page 28 / 36	Revision
Checked by				
Date	13/04/2022			

THERMAL LIMIT CURVE

Three Phase Induction Motor - Squirrel Cage



Customer : _____

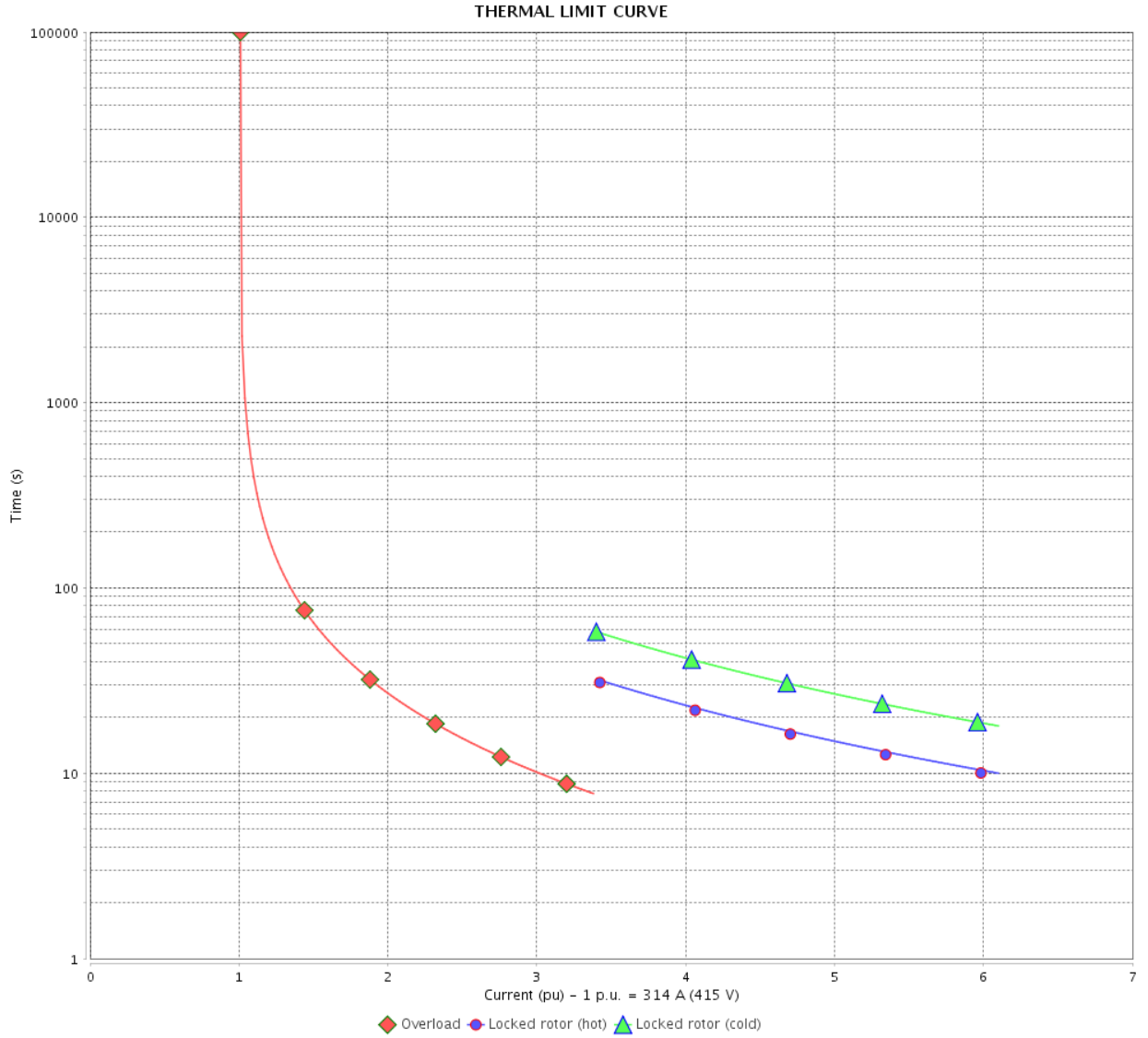

Rev.	Changes Summary	Performed	Checked	Date
Performed by		Page 29 / 36		Revision
Checked by				
Date				

VFD OPERATION CURVE

Three Phase Induction Motor - Squirrel Cage



Customer :

Product line : NEMA Premium Efficiency Three-Phase

Product code : 11586547

Catalog # : 25018ET3G447T-W22

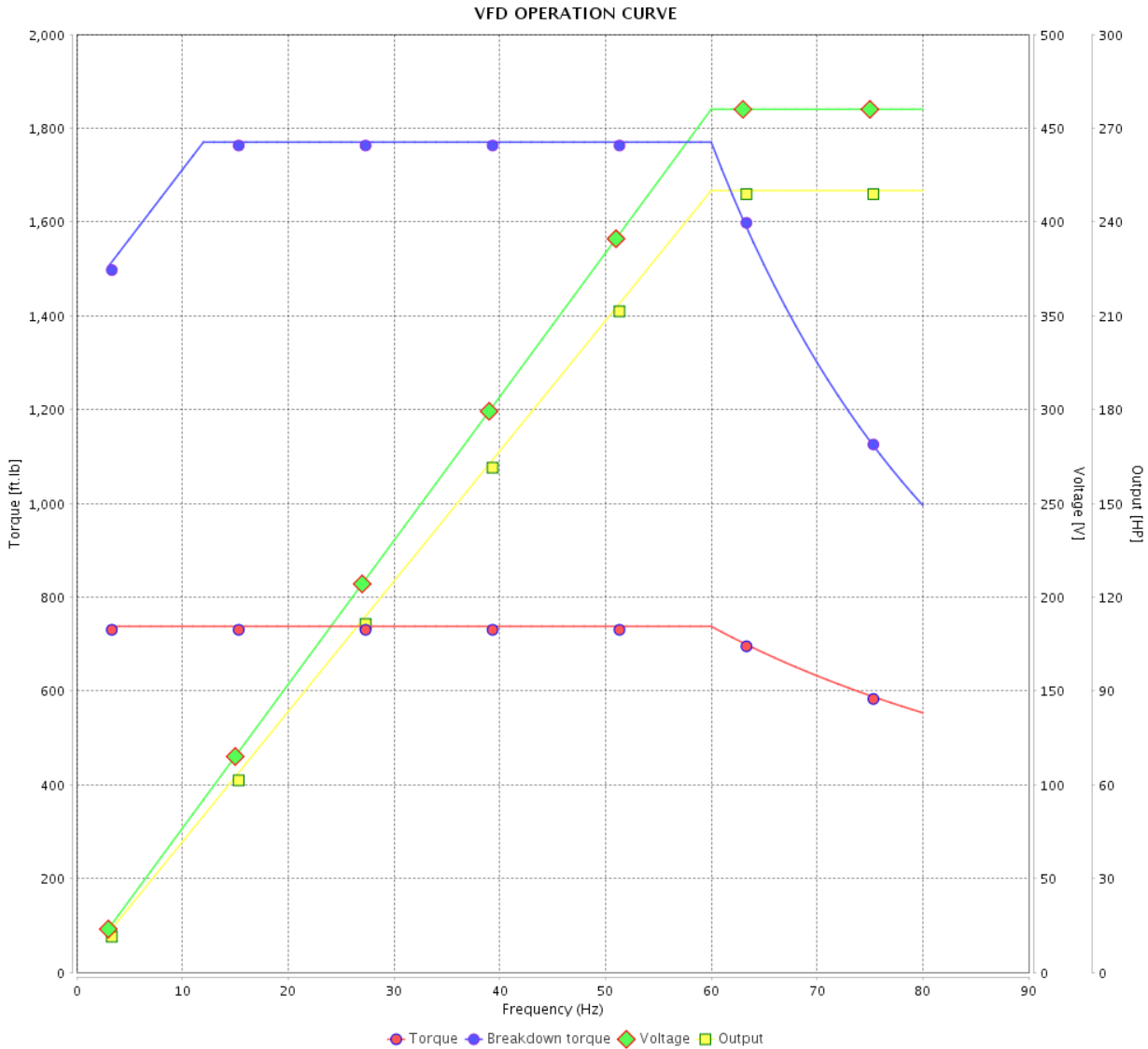

Performance : 460 V 60 Hz 4P

Rated current : 281 A
 LRC : 6.5
 Rated torque : 738 ft.lb
 Locked rotor torque : 229 %
 Breakdown torque : 240 %
 Rated speed : 1780 rpm

Moment of inertia (J) : 89.6 sq.ft.lb
 Duty cycle : Cont.(S1)
 Insulation class : F
 Service factor : 1.15
 Temperature rise : 80 K
 Design : B

Rev.	Changes Summary	Performed	Checked	Date
Performed by			Page 30 / 36	Revision
Checked by				
Date	13/04/2022			

VFD OPERATION CURVE

Three Phase Induction Motor - Squirrel Cage



Customer : _____

Product line : NEMA Premium Efficiency Three-Phase
 Product code : 11586547
 Catalog # : 25018ET3G447T-W22

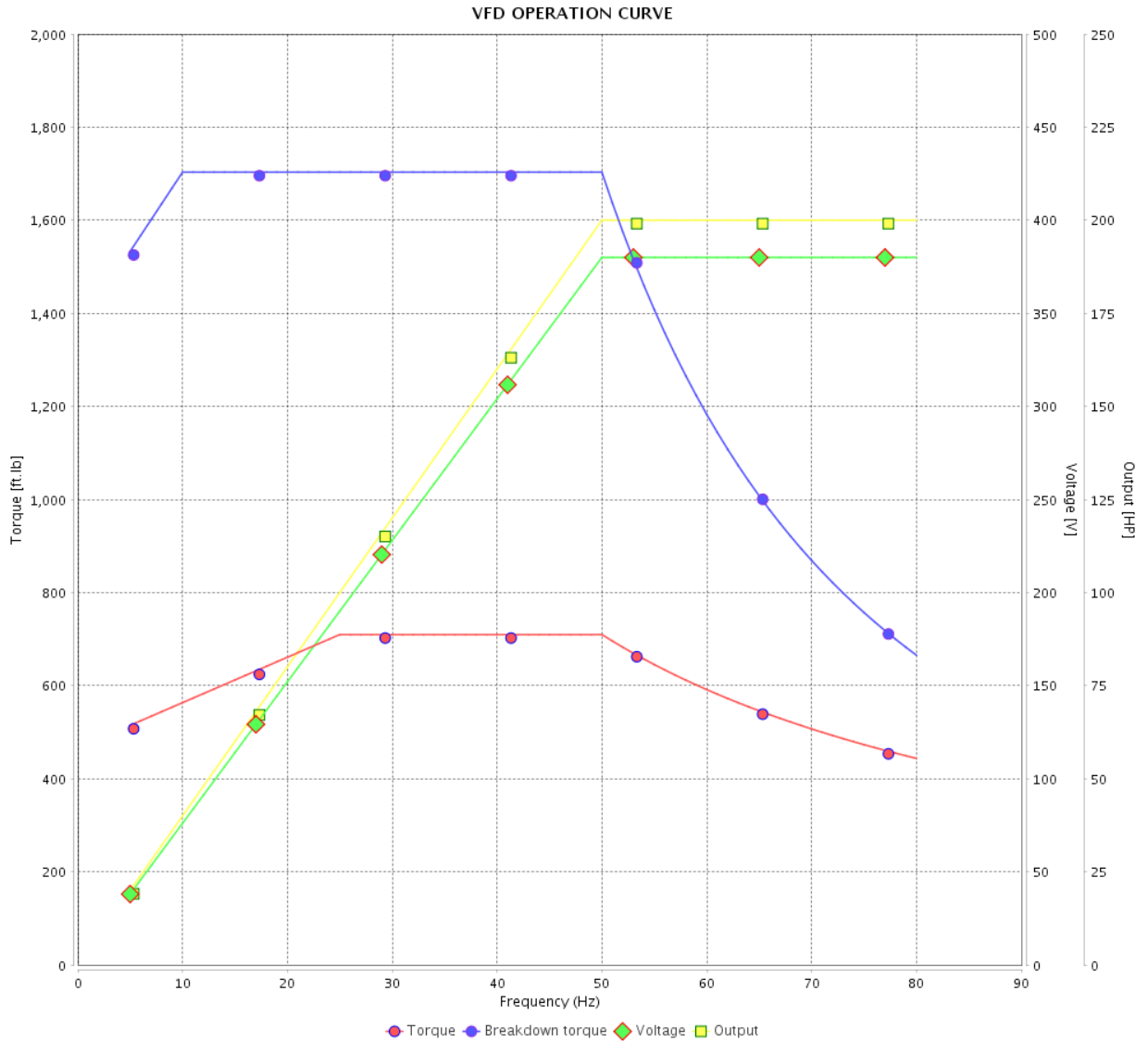

Performance : 380 V 50 Hz 4P IE3

Rated current : 273 A	Moment of inertia (J) : 89.6 sq.ft.lb
LRC : 6.1	Duty cycle : Cont.(S1)
Rated torque : 710 ft.lb	Insulation class : F
Locked rotor torque : 200 %	Service factor : 1.15
Breakdown torque : 240 %	Temperature rise : 80 K
Rated speed : 1480 rpm	Design : B

Rev.	Changes Summary	Performed	Checked	Date
Performed by				Page 31 / 36
Checked by				
Date	13/04/2022			
				Revision

VFD OPERATION CURVE

Three Phase Induction Motor - Squirrel Cage



Customer :

Product line : NEMA Premium Efficiency Three-Phase

Product code : 11586547

Catalog # : 25018ET3G447T-W22

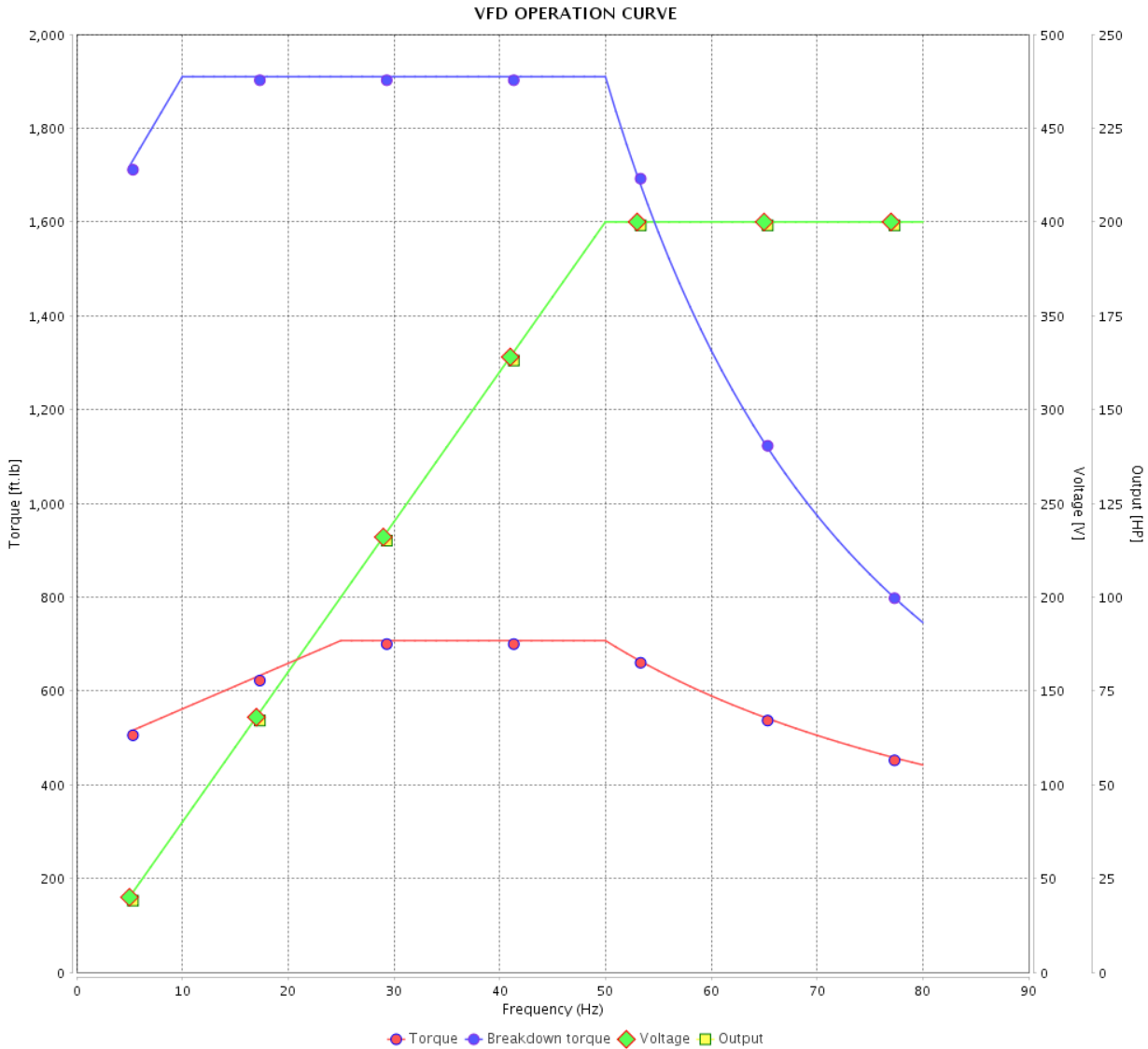

Performance : 400 V 50 Hz 4P IE3

Rated current	: 263 A	Moment of inertia (J)	: 89.6 sq.ft.lb
LRC	: 6.8	Duty cycle	: Cont.(S1)
Rated torque	: 707 ft.lb	Insulation class	: F
Locked rotor torque	: 260 %	Service factor	: 1.15
Breakdown torque	: 270 %	Temperature rise	: 80 K
Rated speed	: 1485 rpm	Design	: B

Rev.	Changes Summary	Performed	Checked	Date
Performed by			Page 32 / 36	Revision
Checked by				
Date	13/04/2022			

VFD OPERATION CURVE

Three Phase Induction Motor - Squirrel Cage



Customer : _____

Product line : NEMA Premium Efficiency Three-Phase
 Product code : 11586547
 Catalog # : 25018ET3G447T-W22

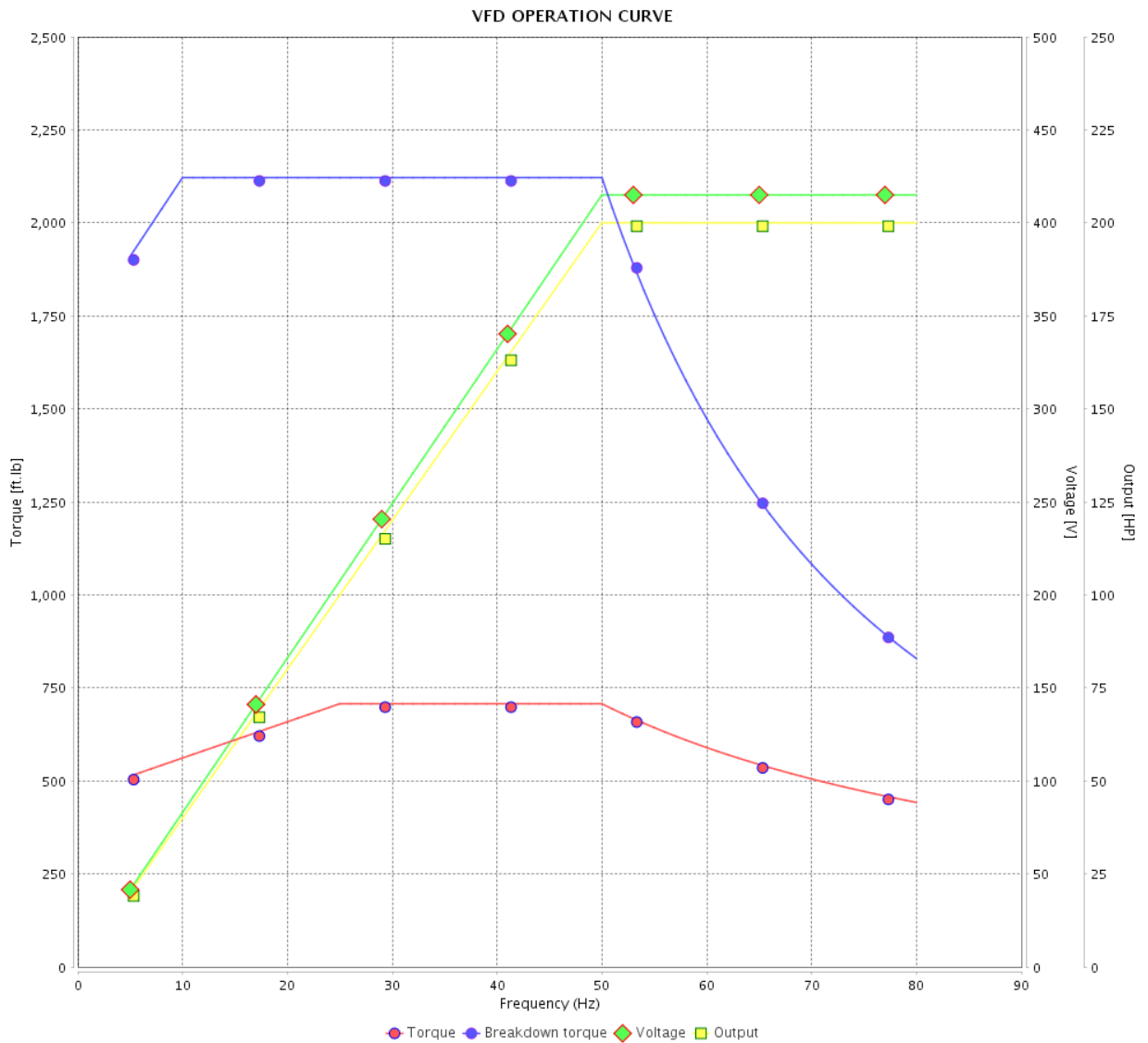

Performance : 415 V 50 Hz 4P IE3

Rated current : 256 A	Moment of inertia (J) : 89.6 sq.ft.lb
LRC : 7.4	Duty cycle : Cont.(S1)
Rated torque : 707 ft.lb	Insulation class : F
Locked rotor torque : 290 %	Service factor : 1.15
Breakdown torque : 300 %	Temperature rise : 80 K
Rated speed : 1485 rpm	Design : B

Rev.	Changes Summary	Performed	Checked	Date
Performed by			Page 33 / 36	Revision
Checked by				
Date	13/04/2022			

VFD OPERATION CURVE

Three Phase Induction Motor - Squirrel Cage



Customer :

Product line : NEMA Premium Efficiency Three-Phase

Product code : 11586547

Catalog # : 25018ET3G447T-W22

VFD OPERATION CURVE

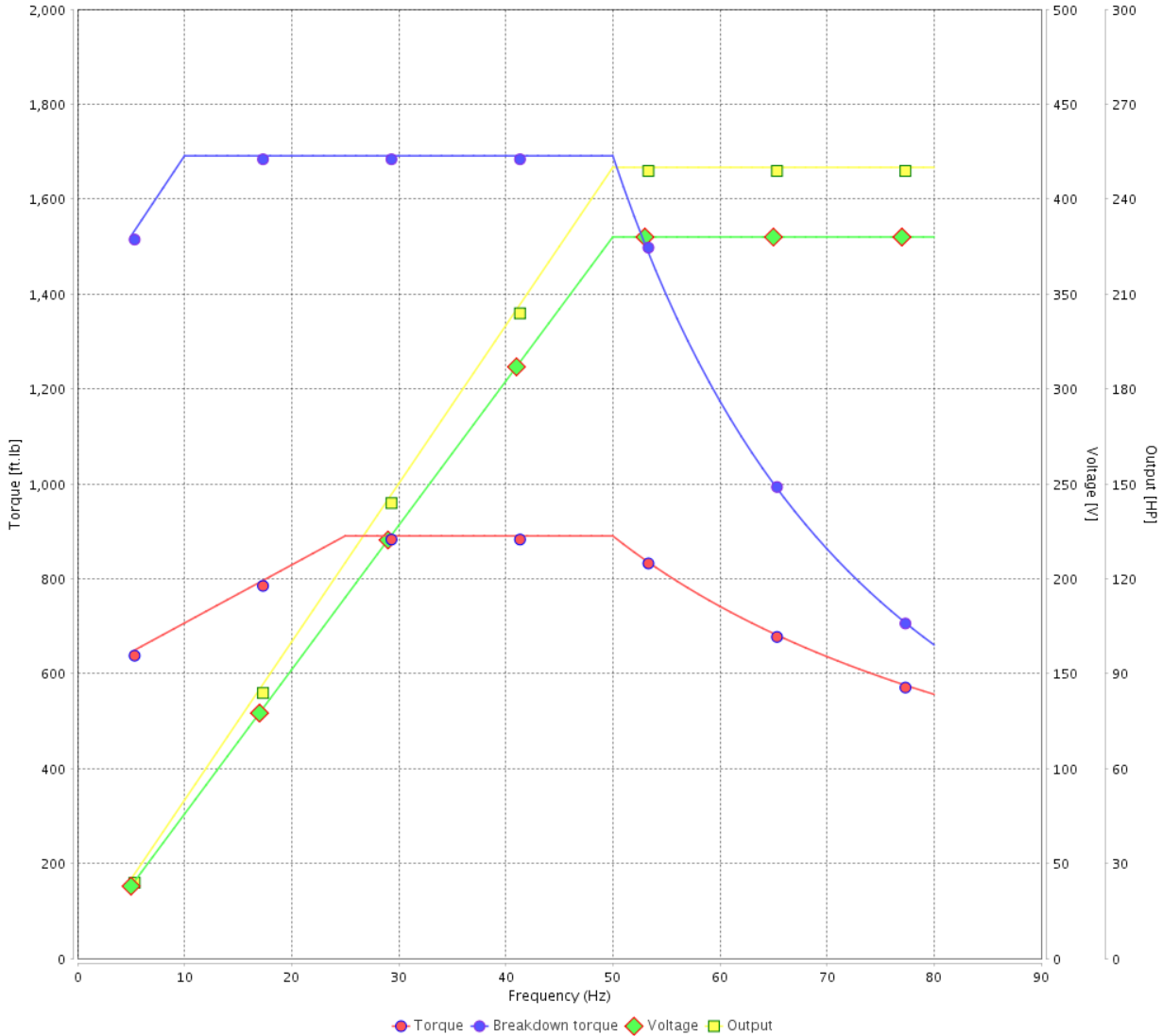

Performance : 380 V 50 Hz 4P IE1

Rated current : 340 A
 LRC : 5.1
 Rated torque : 890 ft.lb
 Locked rotor torque : 180 %
 Breakdown torque : 190 %
 Rated speed : 1475 rpm

Moment of inertia (J) : 89.6 sq.ft.lb
 Duty cycle : Cont.(S1)
 Insulation class : F
 Service factor : 1.00
 Temperature rise : 105 K
 Design : B

Rev.	Changes Summary	Performed	Checked	Date
Performed by			Page 34 / 36	Revision
Checked by				
Date	13/04/2022			

VFD OPERATION CURVE

Three Phase Induction Motor - Squirrel Cage



Customer :

Product line : NEMA Premium Efficiency Three-Phase
 Product code : 11586547
 Catalog # : 25018ET3G447T-W22

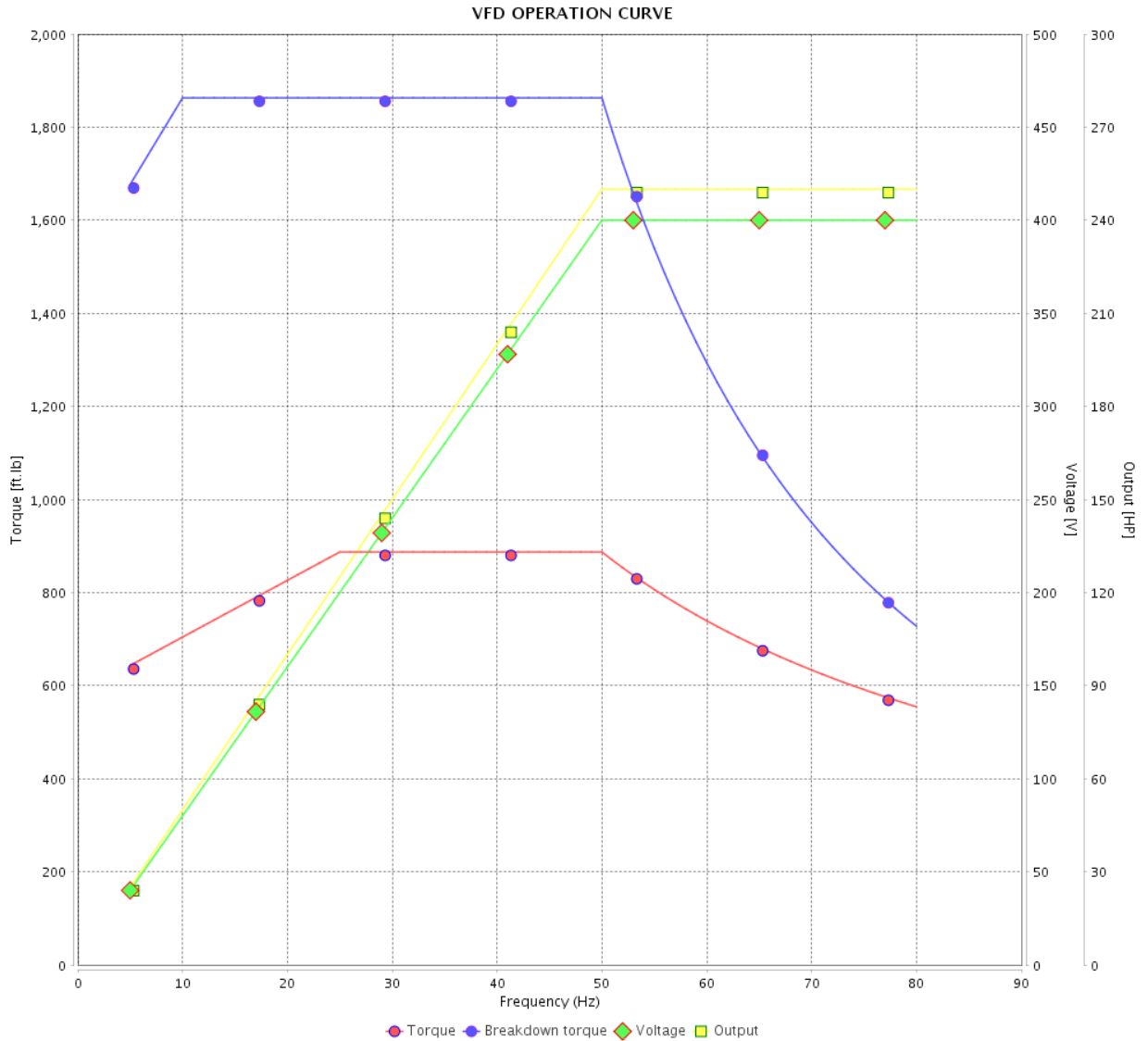

Performance : 400 V 50 Hz 4P IE2

Rated current	: 322 A	Moment of inertia (J)	: 89.6 sq.ft.lb
LRC	: 5.7	Duty cycle	: Cont.(S1)
Rated torque	: 887 ft.lb	Insulation class	: F
Locked rotor torque	: 200 %	Service factor	: 1.00
Breakdown torque	: 210 %	Temperature rise	: 105 K
Rated speed	: 1480 rpm	Design	: B

Rev.	Changes Summary	Performed	Checked	Date
Performed by			Page	Revision
Checked by				
Date	13/04/2022			

VFD OPERATION CURVE

Three Phase Induction Motor - Squirrel Cage



Customer :

Product line : NEMA Premium Efficiency Three-Phase

Product code : 11586547

Catalog # : 25018ET3G447T-W22

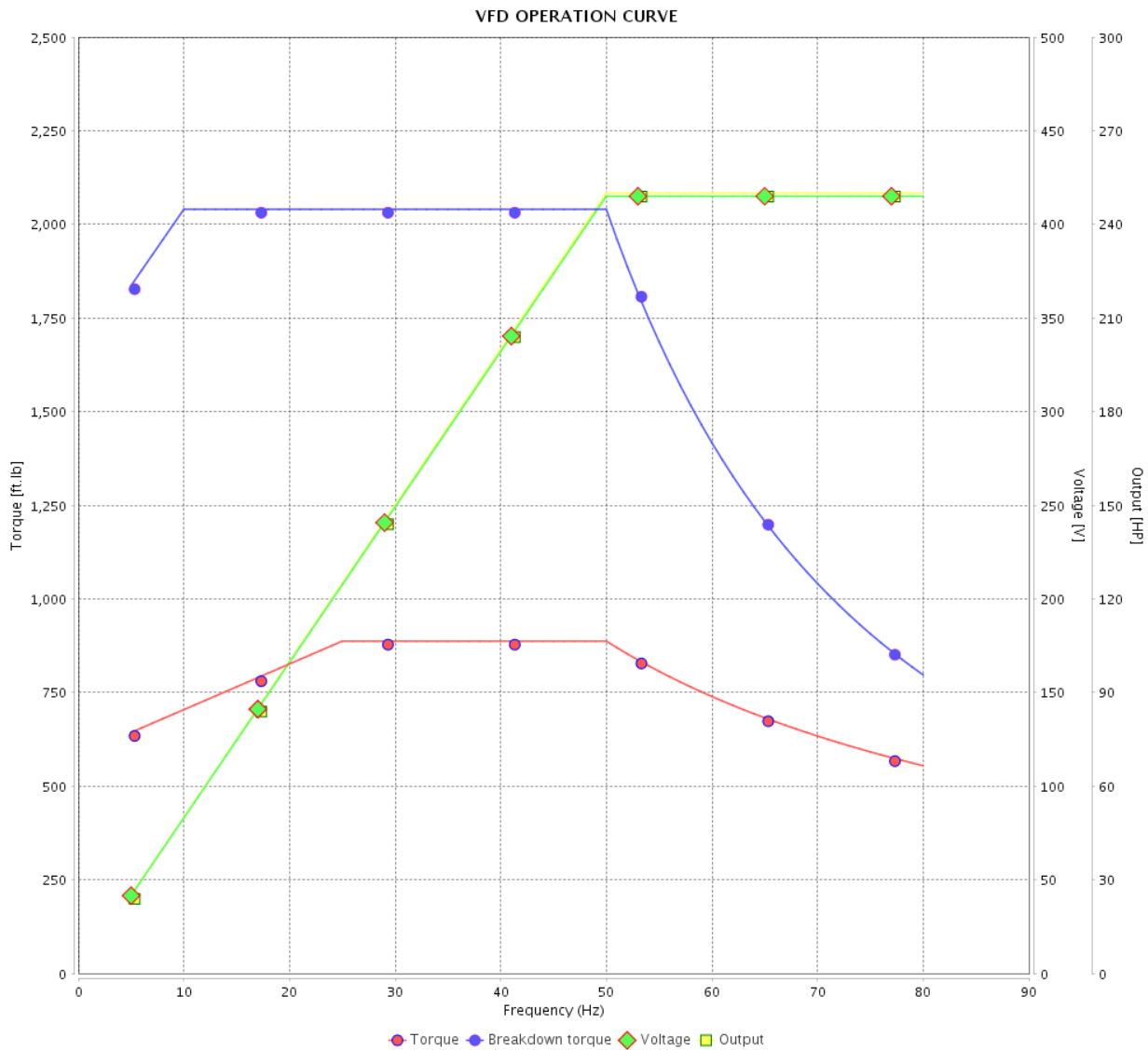

Performance : 415 V 50 Hz 4P IE2

Rated current	: 314 A	Moment of inertia (J)	: 89.6 sq.ft.lb
LRC	: 6.1	Duty cycle	: Cont.(S1)
Rated torque	: 887 ft.lb	Insulation class	: F
Locked rotor torque	: 220 %	Service factor	: 1.00
Breakdown torque	: 229 %	Temperature rise	: 105 K
Rated speed	: 1480 rpm	Design	: B

Rev.	Changes Summary	Performed	Checked	Date
Performed by		Page		Revision
Checked by		36 / 36		
Date	13/04/2022			

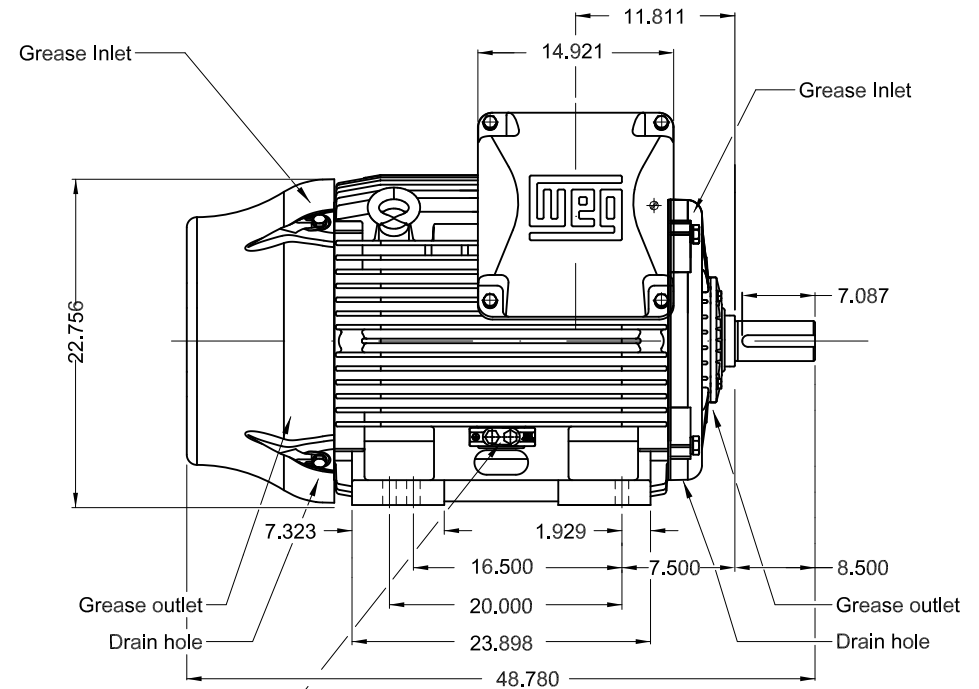
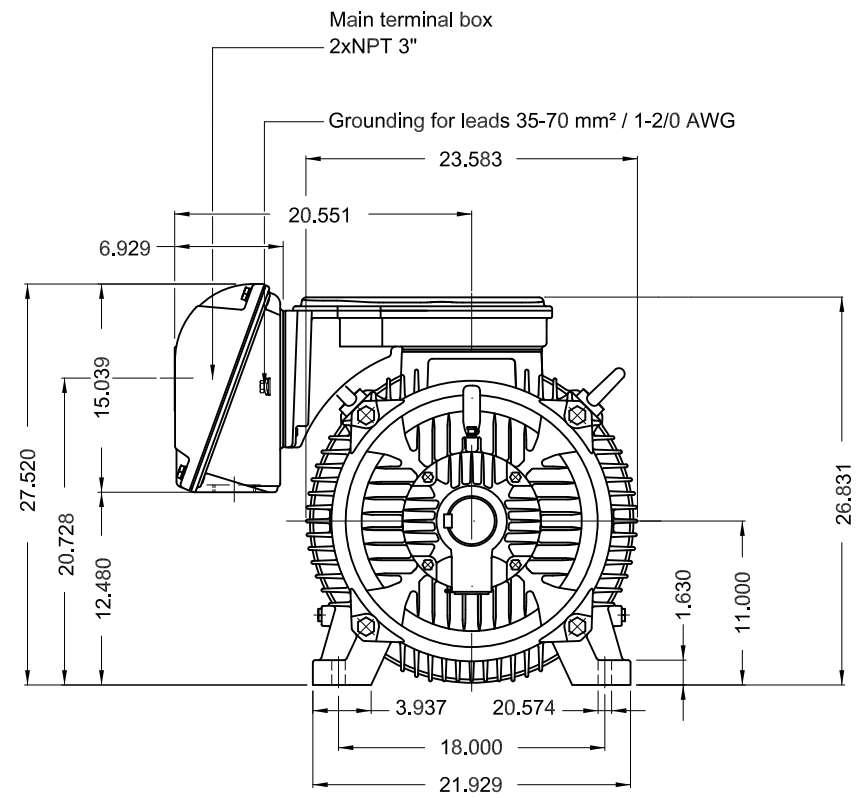

Grounding for leads 25-185 mm² / 3AWG-350MCM

Without vertical jackscrews
 Color RAL 5009
 Painting plan 203A
 Mounting B3R(D)

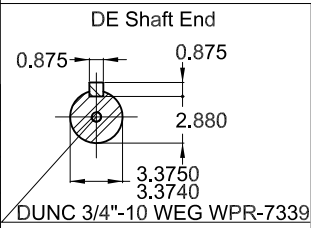

250 HP 04 Poles 60 Hz A

ECM	LOC	SUMMARY OF MODIFICATIONS	EXECUTED	CHECKED	RELEASED	DATE	VER
EXECUTED	PIRWBUSER	THREE PH. MOTOR W22 PREM. EFF.					
CHECKED		FRAME 445/7T IP55 TEFC					
RELEASED							
REL DT.	WMO	Jaragua do Sul	Product Engineering				

PREVIEW
 WDD



SHEET 1 / 1

Dimensions in inches XME A3

MADE IN MEXICO
11586547



FOR SAFE AREA
Mod.TE1BFOXON
CC029A





Class I, Div 2, Gr A, B, C and D - T3
Class I, Zone 2, IIC - T3
Class II, Div 2, Gr F and G - T3C
For use on PWM: Gr. A, B, C, D and F,
VT 1000:1, CT 20:1, 1.00SF - T3

MODEL 25018ET3G447T-W22

Inverter Duty Motor
Severe Duty

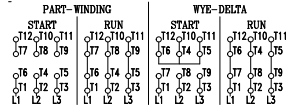
PH3	60Hz	Fr. 445/7T	1000m.a.s.l.	IP55	TEFC	2564lb
V 460				A 281		
HP 250				kW 185		
SF 1.15				SFA 323		
RPM 1780				PF 0.86		
AMB 40°C				INS cl. F DT80K	NEMA NOM EFF 96.2%	
DUTY CONT.				DES B Code G		



 → 6319-C3 (45g)
 → 6316-C3 (34g)

 MOBIL POLYREX EM (8000h)