

DATA SHEET

Three Phase Induction Motor - Squirrel Cage



Customer								
Product line	: NEMA Premium Efficiency Three-Phase	Product code	: 11846215					
		Catalog #	: 25018ET3GRB449T-W22					
Frame	: 447/9T	Cooling method	: IC411 - TEFC					
Insulation class	: F	Mounting	: F-1					
Duty cycle	: Cont.(S1)	Rotation ¹	: Both (CW and CCW)					
Ambient temperature	: -20°C to +40°C	Starting method	: Direct On Line					
Altitude	: 1000 m.a.s.l.	Approx. weight ²	: 2826 lb					
Protection degree	: IP55	Moment of inertia (J)	: 89.6 sq.ft.lb					
Design	: B							
Output [HP]	250	200	200	200	250	250	250	
Poles	4	4	4	4	4	4	4	
Frequency [Hz]	60	50	50	50	50	50	50	
Rated voltage [V]	460	380	400	415	380	400	415	
Rated current [A]	281	273	263	256	342	323	314	
L. R. Amperes [A]	1827	1665	1788	1894	1744	1841	1915	
LRC [A]	6.5x(Code G)	6.1x(Code F)	6.8x(Code G)	7.4x(Code H)	5.1x(Code E)	5.7x(Code F)	6.1x(Code F)	
No load current [A]	85.0	85.0	90.0	95.0	85.0	90.0	95.0	
Rated speed [RPM]	1780	1480	1485	1485	1475	1475	1480	
Slip [%]	1.11	1.33	1.00	1.00	1.67	1.67	1.33	
Rated torque [ft.lb]	738	710	707	707	890	890	887	
Locked rotor torque [%]	229	200	260	290	180	200	220	
Breakdown torque [%]	229	229	260	290	210	210	229	
Service factor	1.15	1.15	1.15	1.15	1.00	1.00	1.00	
Temperature rise	80 K	80 K	80 K	80 K	105 K	105 K	105 K	
Locked rotor time	27s (cold) 15s (hot)	36s (cold) 20s (hot)	32s (cold) 18s (hot)	28s (cold) 16s (hot)	18s (cold) 10s (hot)	18s (cold) 10s (hot)	18s (cold) 10s (hot)	
Noise level ²	75.0 dB(A)	71.0 dB(A)	71.0 dB(A)	71.0 dB(A)	71.0 dB(A)	71.0 dB(A)	71.0 dB(A)	
Efficiency (%)	25%	95.7	94.8	95.0	95.0	93.9	94.8	95.6
	50%	95.8	95.0	95.1	95.1	94.1	94.9	95.4
	75%	96.2	95.8	95.8	95.8	94.5	95.0	95.8
	100%	96.2	95.8	95.8	95.8	94.5	95.0	95.4
Power Factor	25%	0.51	0.52	0.49	0.46	0.58	0.54	0.51
	50%	0.75	0.77	0.74	0.72	0.80	0.77	0.75
	75%	0.83	0.84	0.83	0.81	0.86	0.84	0.83
	100%	0.86	0.87	0.86	0.85	0.87	0.87	0.86
Bearing type	: NU-322 C3	6319 C3	Foundation loads					
Sealing	: WSeal	WSeal	Max. traction	: 4026 lb				
Lubrication interval	: 4000 h	8000 h	Max. compression	: 6852 lb				
Lubricant amount	: 60 g	45 g						
Lubricant type	: Mobil Polyrex EM							
Notes								
This revision replaces and cancel the previous one, which must be eliminated. (1) Looking the motor from the shaft end. (2) Measured at 1m and with tolerance of +3dB(A). (3) Approximate weight subject to changes after manufacturing process. (4) At 100% of full load.				These are average values based on tests with sinusoidal power supply, subject to the tolerances stipulated in NEMA MG-1.				
Rev.	Changes Summary			Performed	Checked	Date		
Performed by								
Checked by					Page	Revision		
Date	13/04/2022				1 / 36			

TORQUE AND CURRENT VS SPEED CURVE

Three Phase Induction Motor - Squirrel Cage



Customer :

Product line : NEMA Premium Efficiency Three-Phase

Product code : 11846215

Catalog # : 25018ET3GRB449T-W22

TORQUE AND CURRENT VS SPEED CURVE

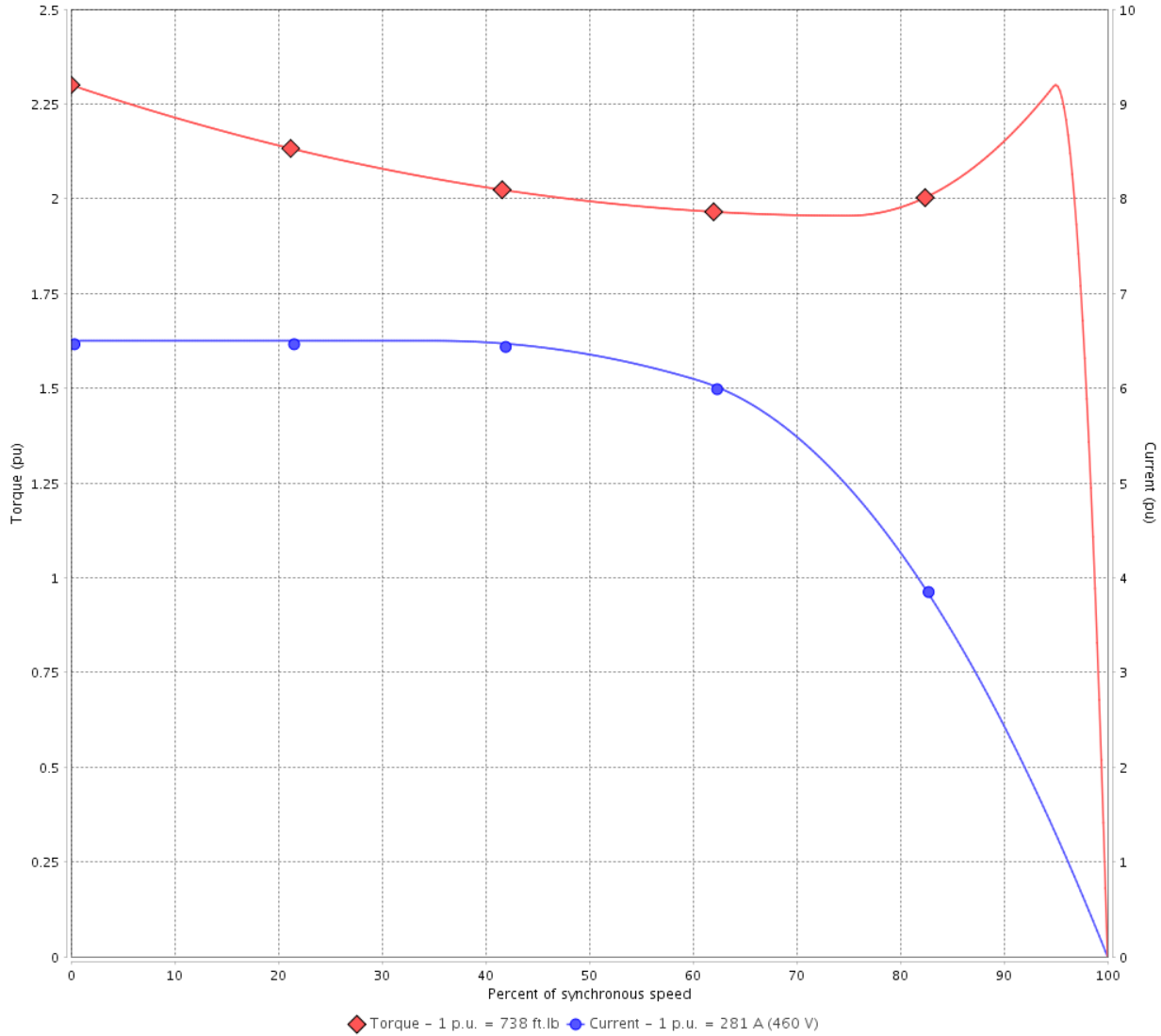

Performance : 460 V 60 Hz 4P

Rated current	: 281 A	Moment of inertia (J)	: 89.6 sq.ft.lb
LRC	: 6.5	Duty cycle	: Cont.(S1)
Rated torque	: 738 ft.lb	Insulation class	: F
Locked rotor torque	: 229 %	Service factor	: 1.15
Breakdown torque	: 229 %	Temperature rise	: 80 K
Rated speed	: 1780 rpm	Design	: B

Locked rotor time : 27s (cold) 15s (hot)

Rev.	Changes Summary	Performed	Checked	Date
Performed by			Page 2 / 36	Revision
Checked by				
Date	13/04/2022			

TORQUE AND CURRENT VS SPEED CURVE



Three Phase Induction Motor - Squirrel Cage

Customer :

Product line : NEMA Premium Efficiency Three-Phase

Product code : 11846215

Catalog # : 25018ET3GRB449T-W22

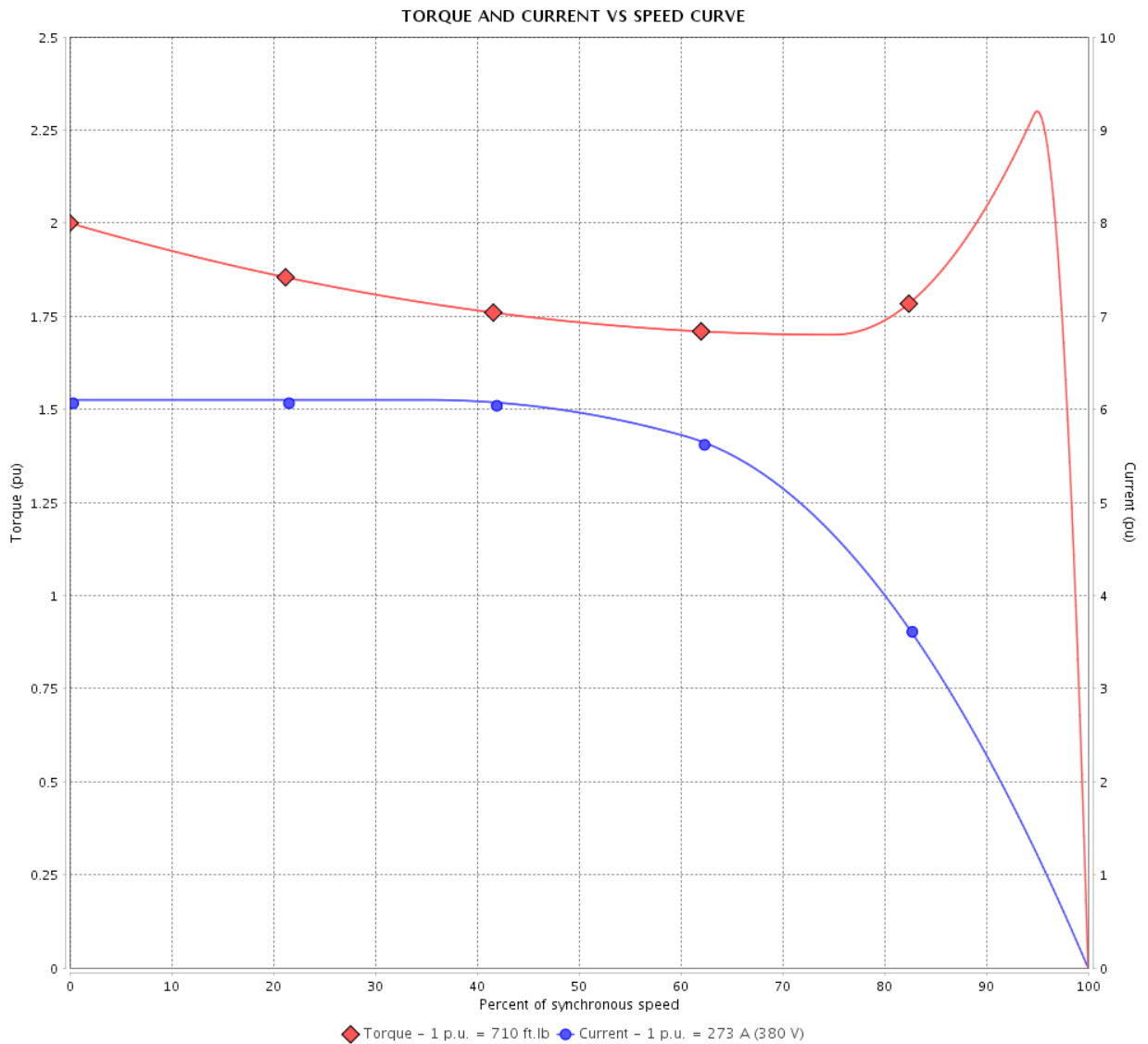

Performance : 380 V 50 Hz 4P IE3

Rated current	: 273 A	Moment of inertia (J)	: 89.6 sq.ft.lb
LRC	: 6.1	Duty cycle	: Cont.(S1)
Rated torque	: 710 ft.lb	Insulation class	: F
Locked rotor torque	: 200 %	Service factor	: 1.15
Breakdown torque	: 229 %	Temperature rise	: 80 K
Rated speed	: 1480 rpm	Design	: B

Locked rotor time : 36s (cold) 20s (hot)

Rev.	Changes Summary	Performed	Checked	Date
Performed by			Page 3 / 36	Revision
Checked by				
Date	13/04/2022			

TORQUE AND CURRENT VS SPEED CURVE

Three Phase Induction Motor - Squirrel Cage



Customer :

Product line : NEMA Premium Efficiency Three-Phase

Product code : 11846215

Catalog # : 25018ET3GRB449T-W22

TORQUE AND CURRENT VS SPEED CURVE

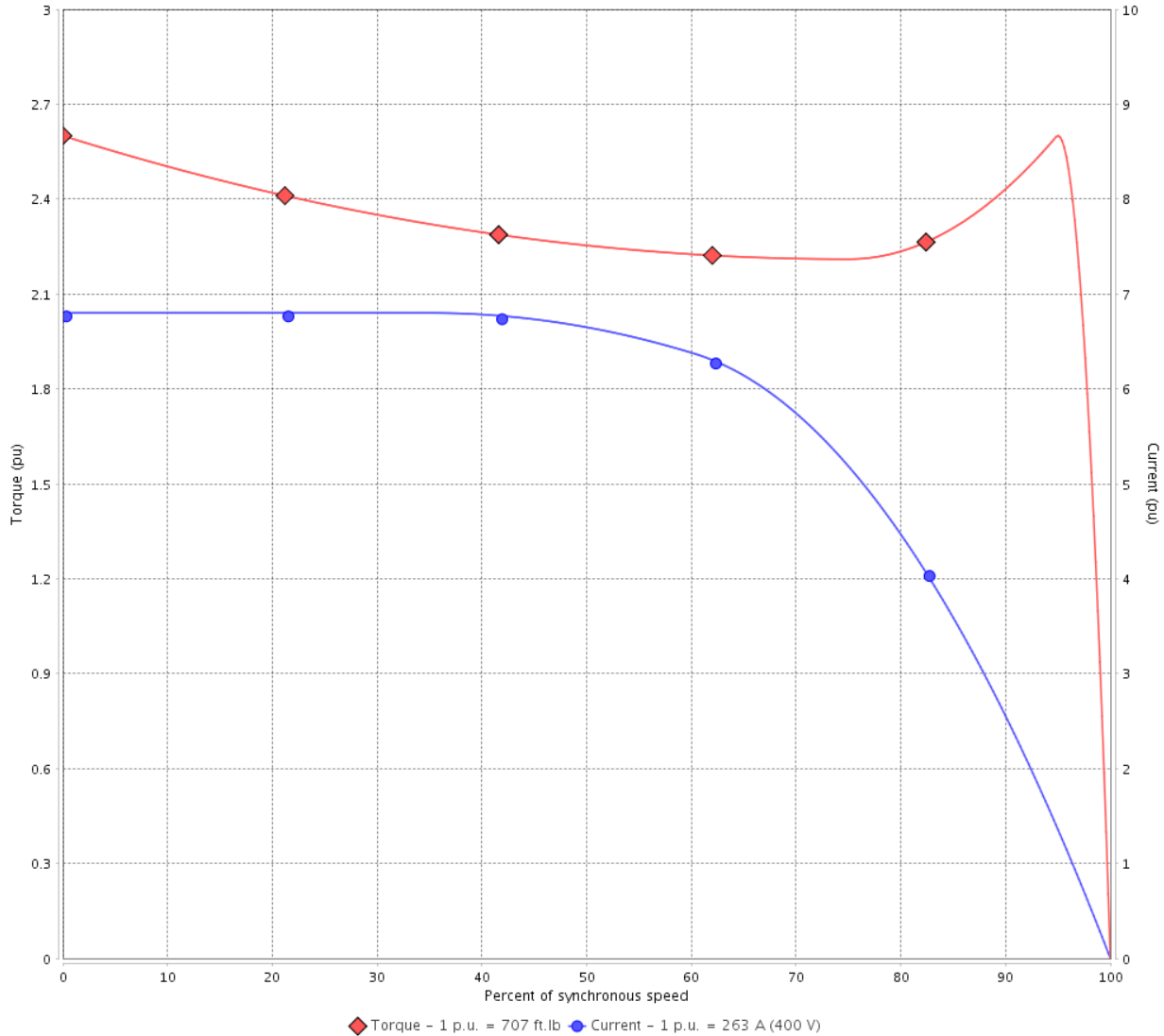

Performance : 400 V 50 Hz 4P IE3

Rated current	: 263 A	Moment of inertia (J)	: 89.6 sq.ft.lb
LRC	: 6.8	Duty cycle	: Cont.(S1)
Rated torque	: 707 ft.lb	Insulation class	: F
Locked rotor torque	: 260 %	Service factor	: 1.15
Breakdown torque	: 260 %	Temperature rise	: 80 K
Rated speed	: 1485 rpm	Design	: B

Locked rotor time : 32s (cold) 18s (hot)

Rev.	Changes Summary	Performed	Checked	Date
Performed by			Page 4 / 36	Revision
Checked by				
Date	13/04/2022			

TORQUE AND CURRENT VS SPEED CURVE



Three Phase Induction Motor - Squirrel Cage

Customer :

Product line : NEMA Premium Efficiency Three-Phase

Product code : 11846215

Catalog # : 25018ET3GRB449T-W22

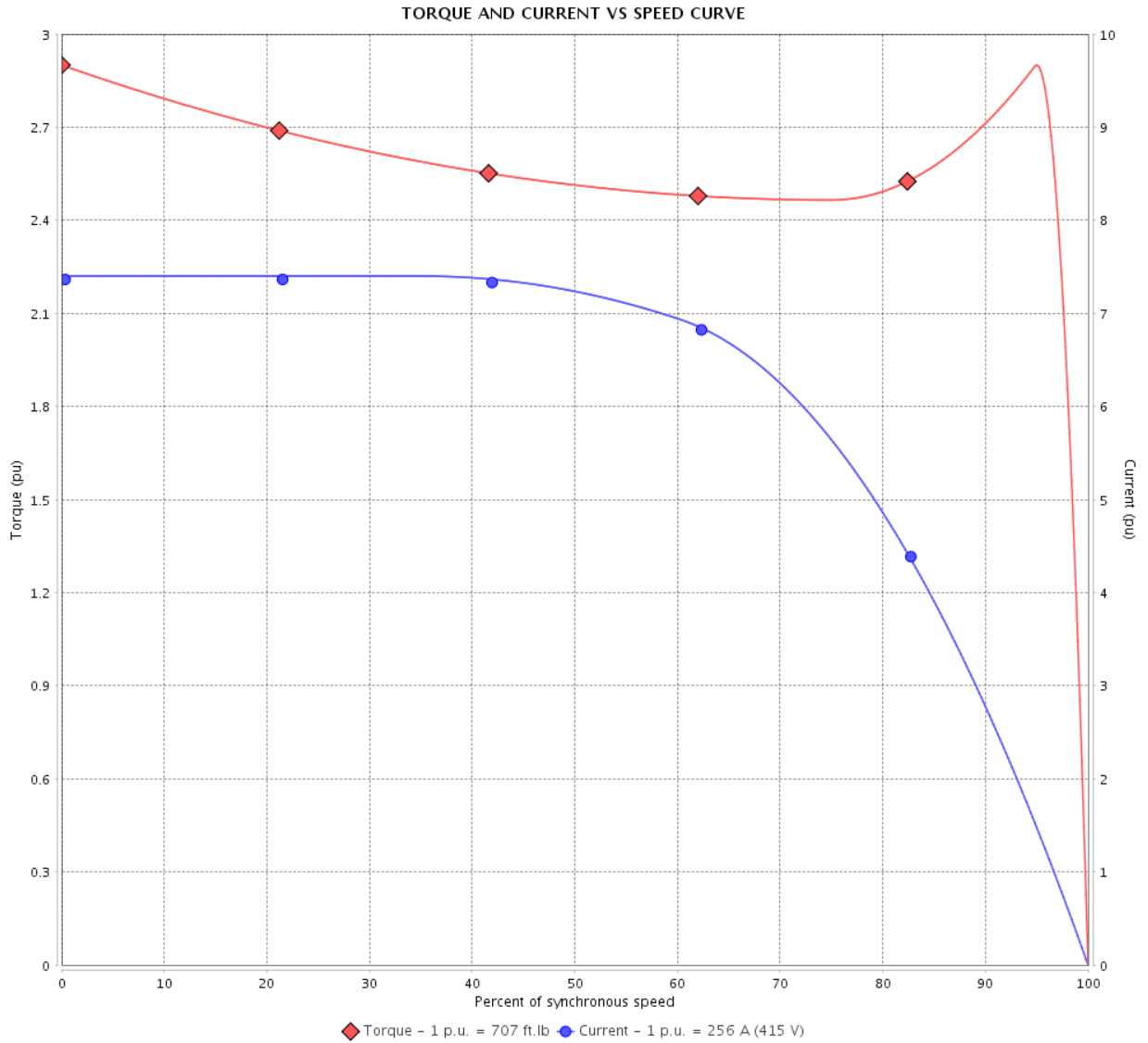

Performance : 415 V 50 Hz 4P IE3

Rated current	: 256 A	Moment of inertia (J)	: 89.6 sq.ft.lb
LRC	: 7.4	Duty cycle	: Cont.(S1)
Rated torque	: 707 ft.lb	Insulation class	: F
Locked rotor torque	: 290 %	Service factor	: 1.15
Breakdown torque	: 290 %	Temperature rise	: 80 K
Rated speed	: 1485 rpm	Design	: B

Locked rotor time : 28s (cold) 16s (hot)

Rev.	Changes Summary	Performed	Checked	Date
Performed by			Page 5 / 36	Revision
Checked by				
Date	13/04/2022			

TORQUE AND CURRENT VS SPEED CURVE

Three Phase Induction Motor - Squirrel Cage



Customer :

Product line : NEMA Premium Efficiency Three-Phase

Product code : 11846215

Catalog # : 25018ET3GRB449T-W22

TORQUE AND CURRENT VS SPEED CURVE

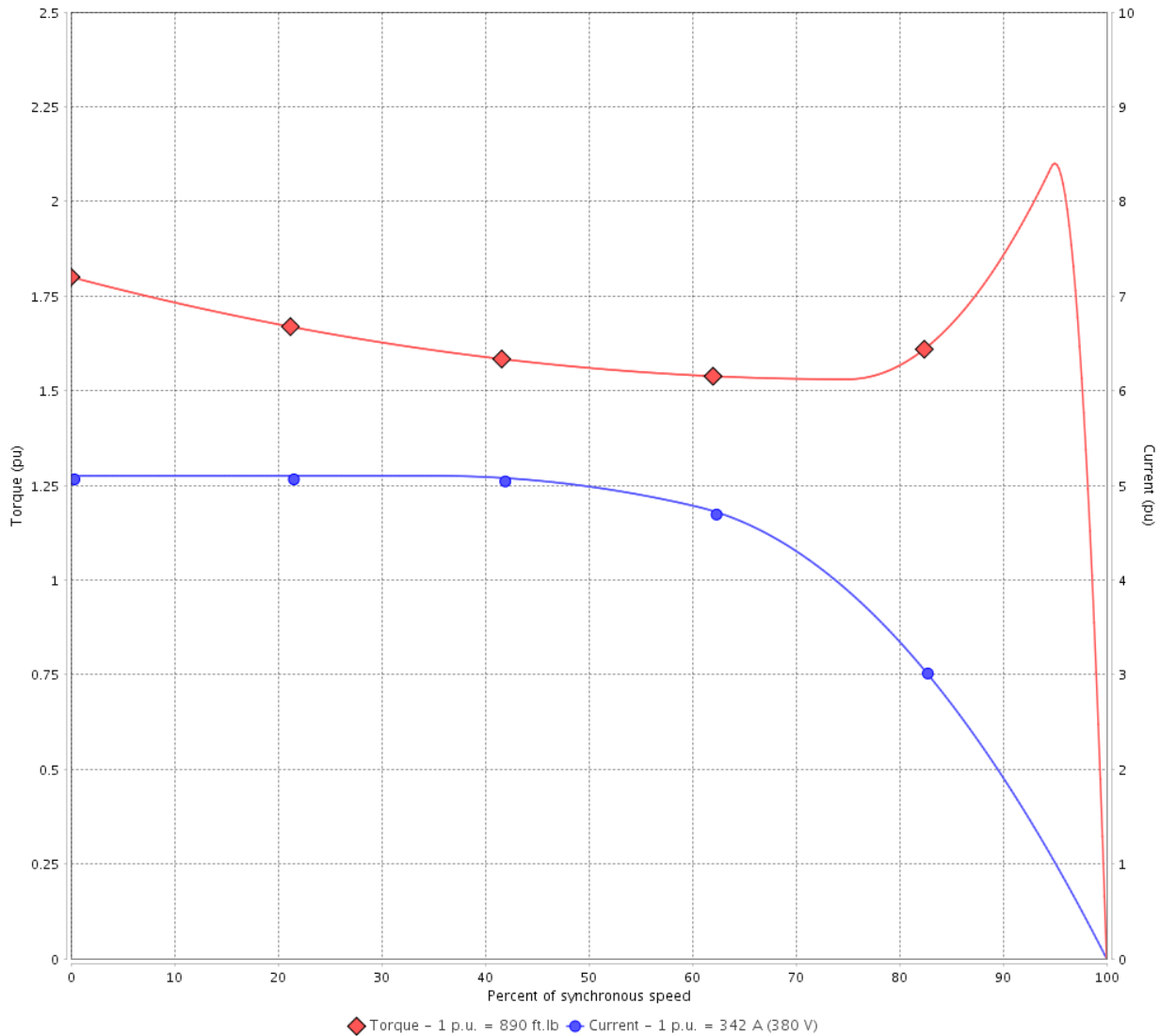

Performance : 380 V 50 Hz 4P IE1

Rated current	: 342 A	Moment of inertia (J)	: 89.6 sq.ft.lb
LRC	: 5.1	Duty cycle	: Cont.(S1)
Rated torque	: 890 ft.lb	Insulation class	: F
Locked rotor torque	: 180 %	Service factor	: 1.00
Breakdown torque	: 210 %	Temperature rise	: 105 K
Rated speed	: 1475 rpm	Design	: B

Locked rotor time : 18s (cold) 10s (hot)

Rev.	Changes Summary	Performed	Checked	Date
Performed by			Page 6 / 36	Revision
Checked by				
Date	13/04/2022			

TORQUE AND CURRENT VS SPEED CURVE



Three Phase Induction Motor - Squirrel Cage

Customer :

Product line : NEMA Premium Efficiency Three-Phase

Product code : 11846215

Catalog # : 25018ET3GRB449T-W22

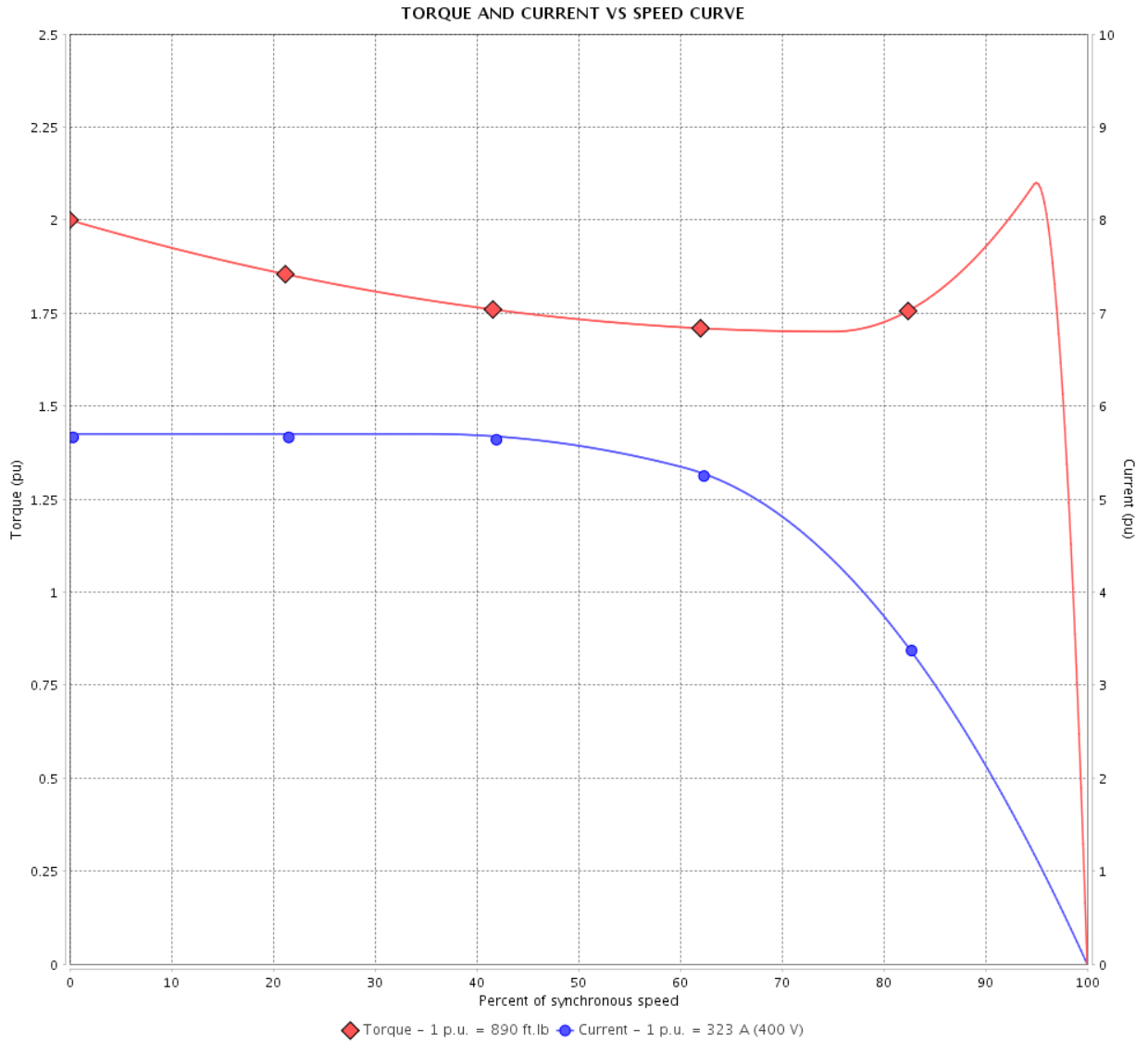

Performance : 400 V 50 Hz 4P IE1

Rated current	: 323 A	Moment of inertia (J)	: 89.6 sq.ft.lb
LRC	: 5.7	Duty cycle	: Cont.(S1)
Rated torque	: 890 ft.lb	Insulation class	: F
Locked rotor torque	: 200 %	Service factor	: 1.00
Breakdown torque	: 210 %	Temperature rise	: 105 K
Rated speed	: 1475 rpm	Design	: B

Locked rotor time : 18s (cold) 10s (hot)

Rev.	Changes Summary	Performed	Checked	Date
Performed by			Page 7 / 36	Revision
Checked by				
Date	13/04/2022			

TORQUE AND CURRENT VS SPEED CURVE

Three Phase Induction Motor - Squirrel Cage



Customer :

Product line : NEMA Premium Efficiency Three-Phase

Product code : 11846215

Catalog # : 25018ET3GRB449T-W22

TORQUE AND CURRENT VS SPEED CURVE

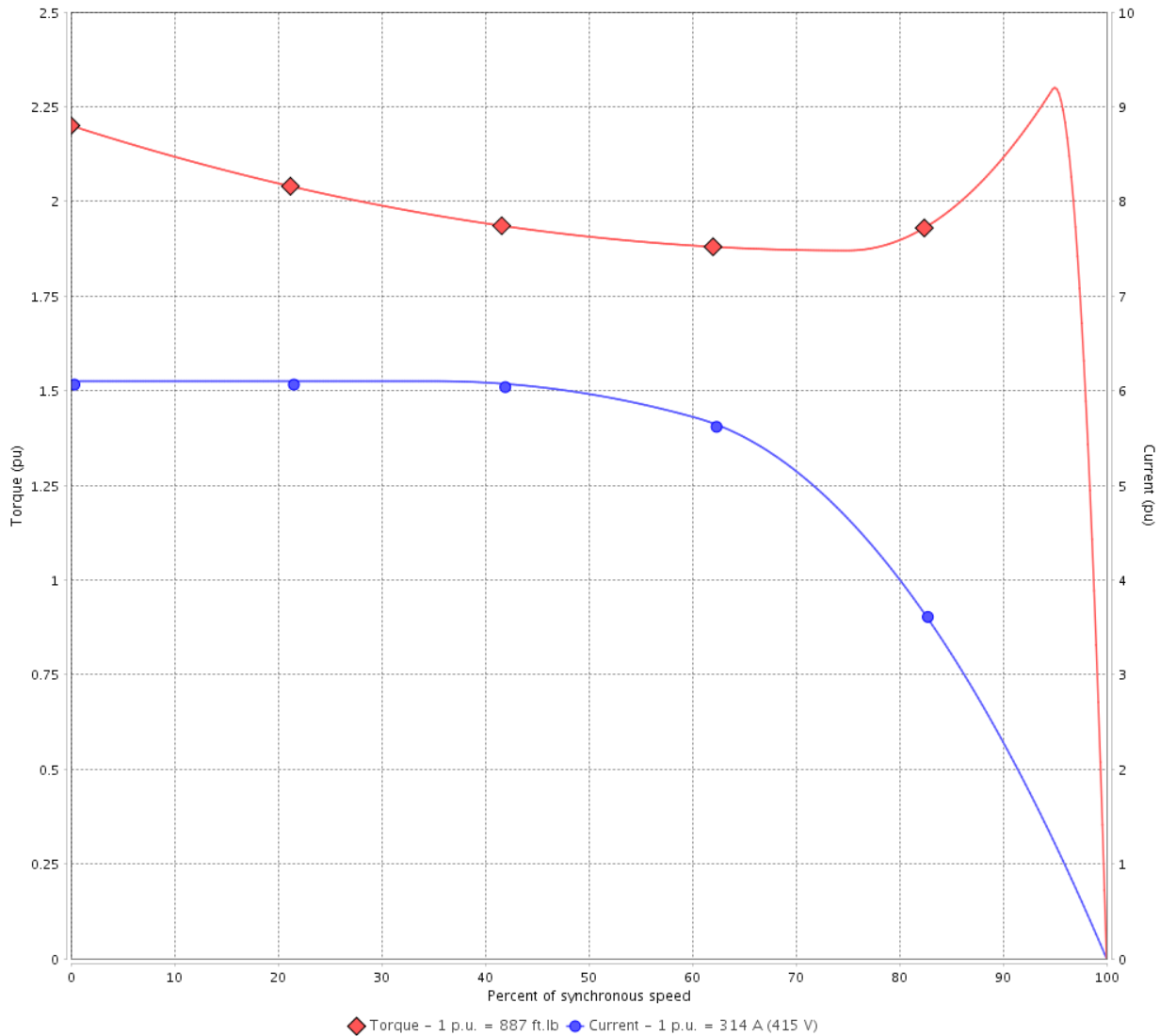

Performance : 415 V 50 Hz 4P IE2

Rated current	: 314 A	Moment of inertia (J)	: 89.6 sq.ft.lb
LRC	: 6.1	Duty cycle	: Cont.(S1)
Rated torque	: 887 ft.lb	Insulation class	: F
Locked rotor torque	: 220 %	Service factor	: 1.00
Breakdown torque	: 229 %	Temperature rise	: 105 K
Rated speed	: 1480 rpm	Design	: B

Locked rotor time : 18s (cold) 10s (hot)

Rev.	Changes Summary	Performed	Checked	Date
Performed by			Page 8 / 36	Revision
Checked by				
Date	13/04/2022			

LOAD PERFORMANCE CURVE

Three Phase Induction Motor - Squirrel Cage



Customer :

Product line : NEMA Premium Efficiency Three-Phase

Product code : 11846215

Catalog # : 25018ET3GRB449T-W22

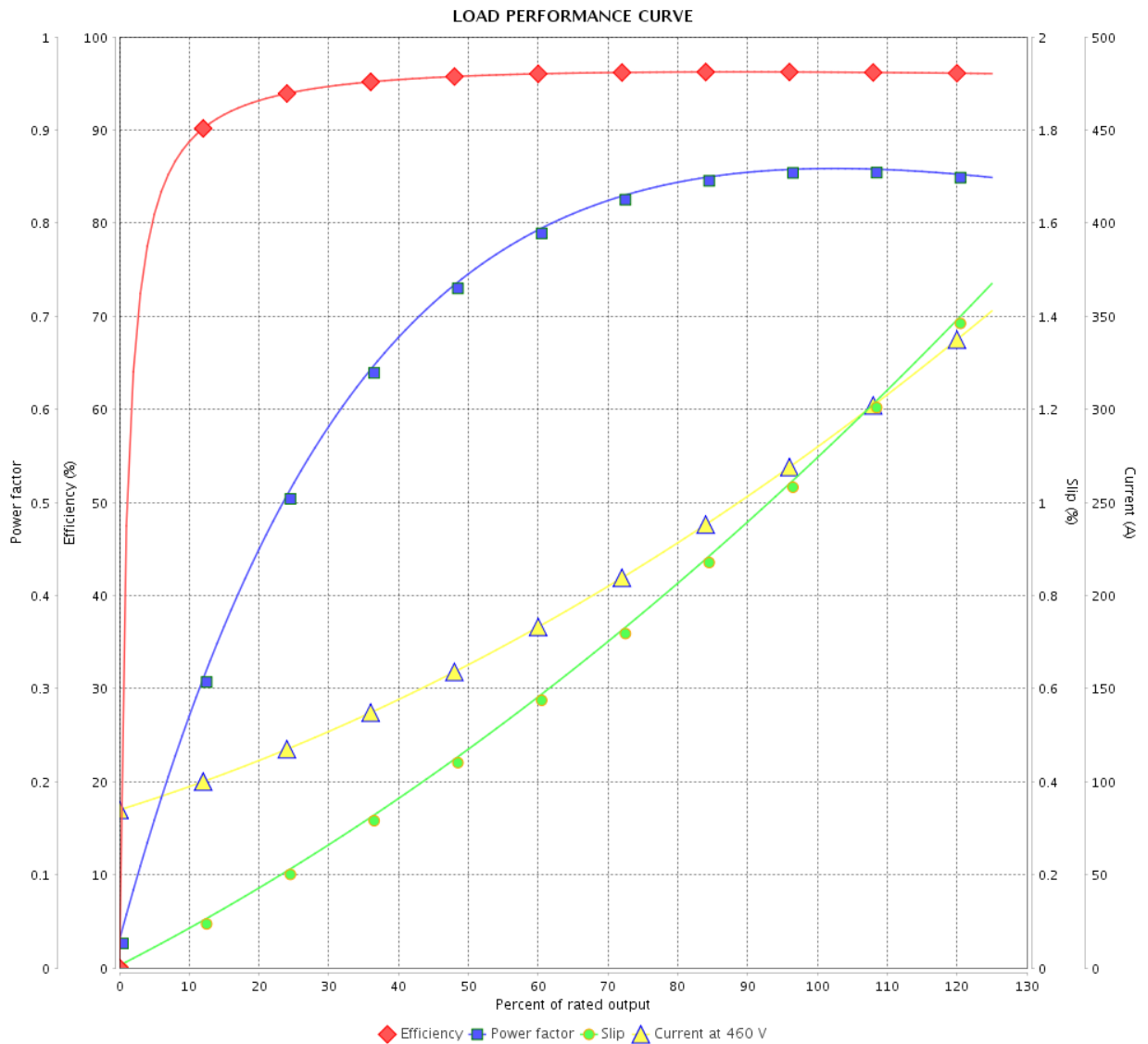

Performance : 460 V 60 Hz 4P

Rated current : 281 A
 LRC : 6.5
 Rated torque : 738 ft.lb
 Locked rotor torque : 229 %
 Breakdown torque : 229 %
 Rated speed : 1780 rpm

Moment of inertia (J) : 89.6 sq.ft.lb
 Duty cycle : Cont.(S1)
 Insulation class : F
 Service factor : 1.15
 Temperature rise : 80 K
 Design : B

Rev.	Changes Summary	Performed	Checked	Date
Performed by			Page	Revision
Checked by				
Date				
			9 / 36	

LOAD PERFORMANCE CURVE

Three Phase Induction Motor - Squirrel Cage



Customer :

Product line : NEMA Premium Efficiency Three-Phase

Product code : 11846215

Catalog # : 25018ET3GRB449T-W22

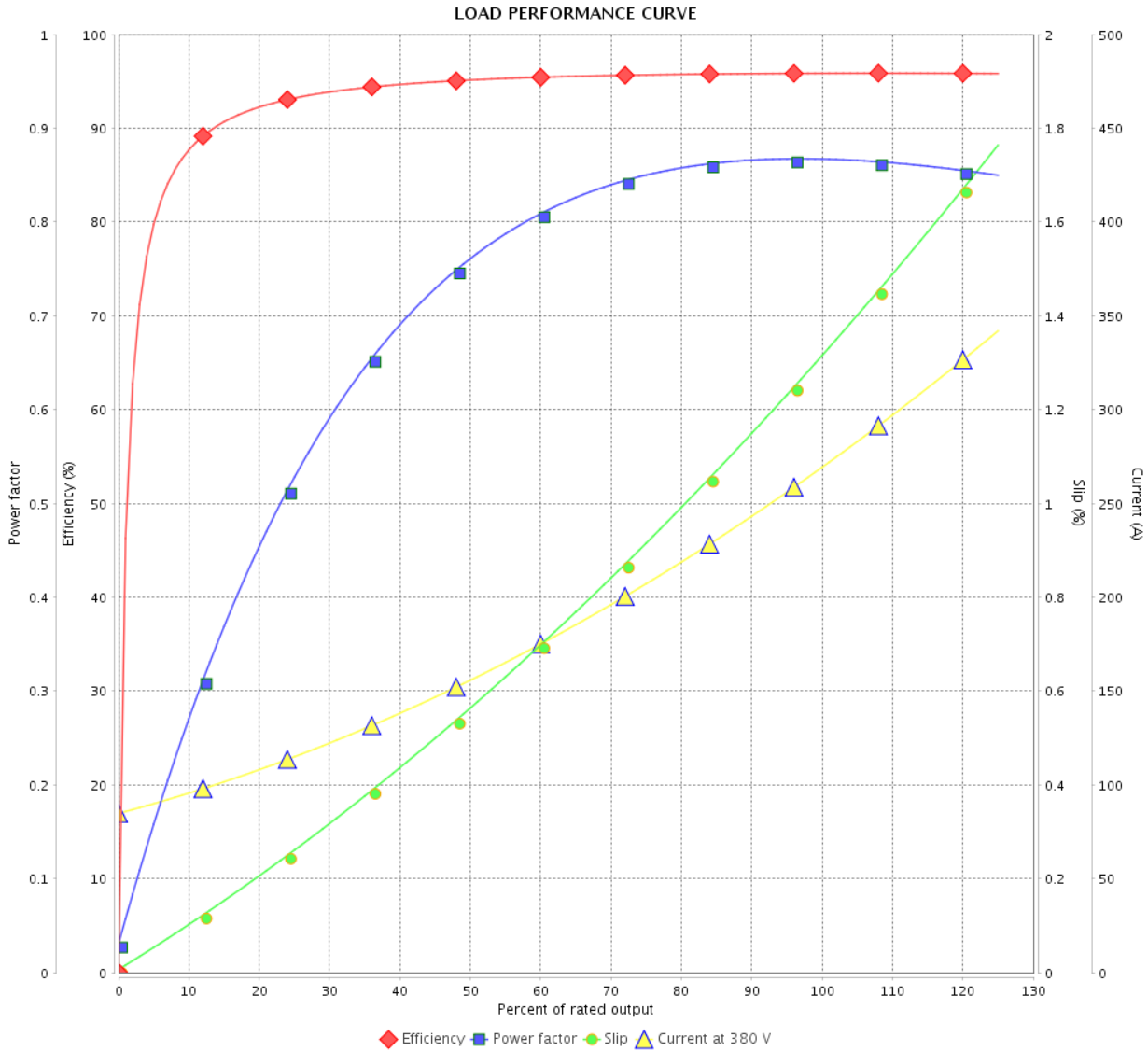

Performance : 380 V 50 Hz 4P IE3

Rated current	: 273 A	Moment of inertia (J)	: 89.6 sq.ft.lb
LRC	: 6.1	Duty cycle	: Cont.(S1)
Rated torque	: 710 ft.lb	Insulation class	: F
Locked rotor torque	: 200 %	Service factor	: 1.15
Breakdown torque	: 229 %	Temperature rise	: 80 K
Rated speed	: 1480 rpm	Design	: B

Rev.	Changes Summary	Performed	Checked	Date
Performed by			Page	Revision
Checked by			10 / 36	
Date	13/04/2022			

LOAD PERFORMANCE CURVE

Three Phase Induction Motor - Squirrel Cage



Customer : _____

Product line : NEMA Premium Efficiency Three-Phase

Product code : 11846215

Catalog # : 25018ET3GRB449T-W22

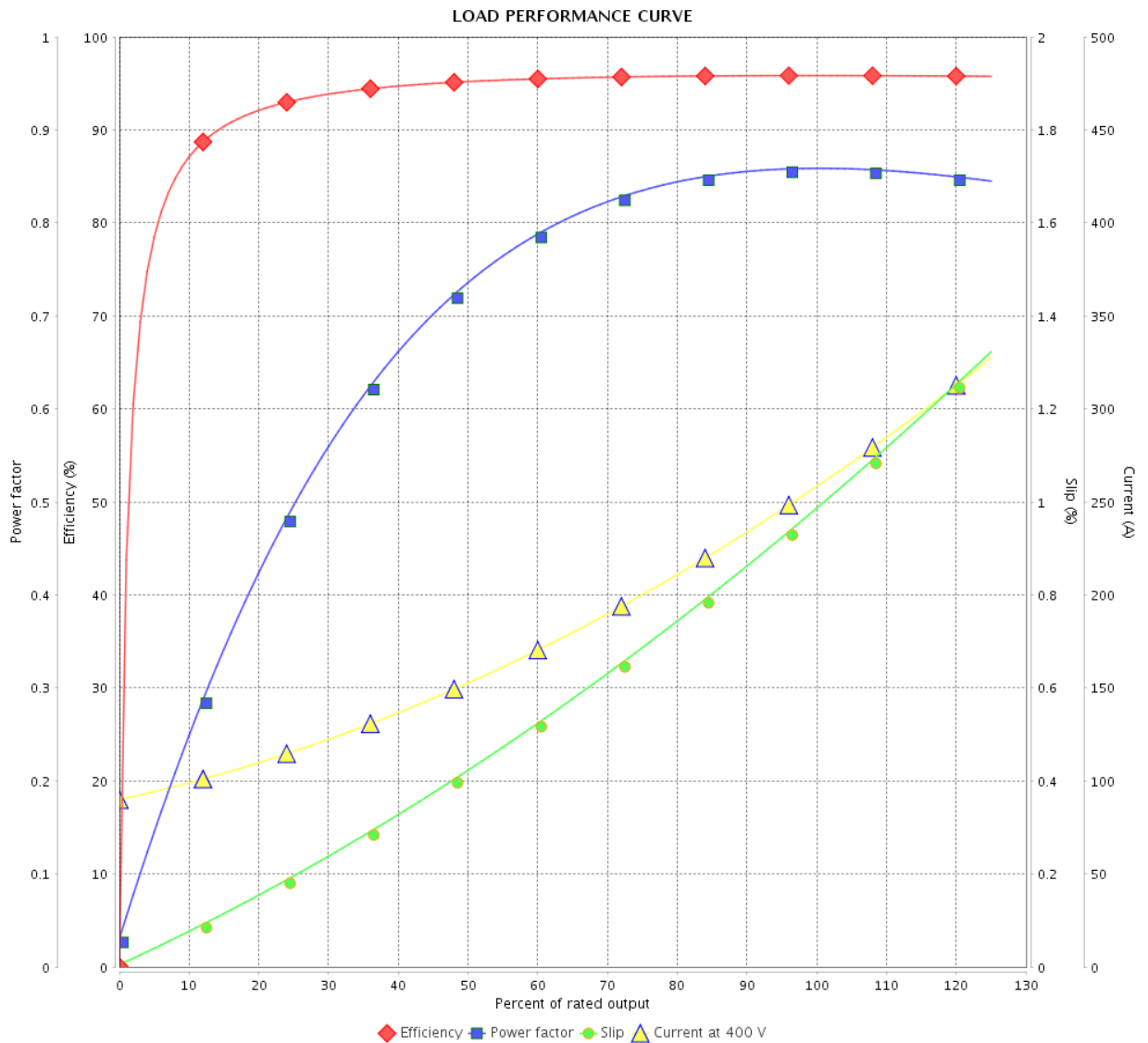

Performance : 400 V 50 Hz 4P IE3

Rated current : 263 A
 LRC : 6.8
 Rated torque : 707 ft.lb
 Locked rotor torque : 260 %
 Breakdown torque : 260 %
 Rated speed : 1485 rpm

Moment of inertia (J) : 89.6 sq.ft.lb
 Duty cycle : Cont.(S1)
 Insulation class : F
 Service factor : 1.15
 Temperature rise : 80 K
 Design : B

Rev.	Changes Summary	Performed	Checked	Date
Performed by		Page		Revision
Checked by		11 / 36		
Date		13/04/2022		

LOAD PERFORMANCE CURVE

Three Phase Induction Motor - Squirrel Cage



Customer :

Product line : NEMA Premium Efficiency Three-Phase

Product code : 11846215

Catalog # : 25018ET3GRB449T-W22

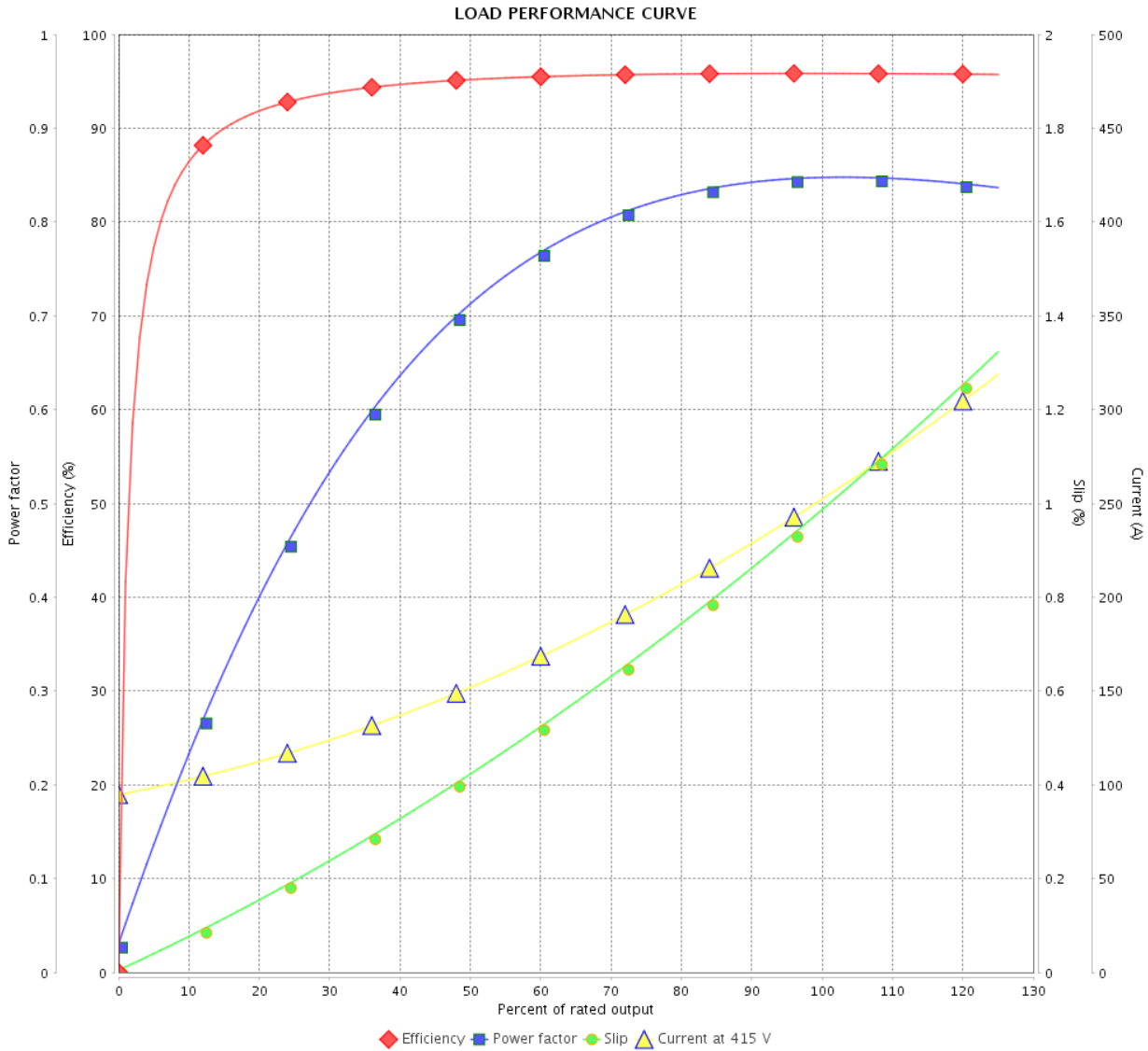

Performance : 415 V 50 Hz 4P IE3

Rated current : 256 A
 LRC : 7.4
 Rated torque : 707 ft.lb
 Locked rotor torque : 290 %
 Breakdown torque : 290 %
 Rated speed : 1485 rpm

Moment of inertia (J) : 89.6 sq.ft.lb
 Duty cycle : Cont.(S1)
 Insulation class : F
 Service factor : 1.15
 Temperature rise : 80 K
 Design : B

Rev.	Changes Summary	Performed	Checked	Date
Performed by			Page 12 / 36	Revision
Checked by				
Date	13/04/2022			

LOAD PERFORMANCE CURVE

Three Phase Induction Motor - Squirrel Cage



Customer :

Product line : NEMA Premium Efficiency Three-Phase

Product code : 11846215

Catalog # : 25018ET3GRB449T-W22

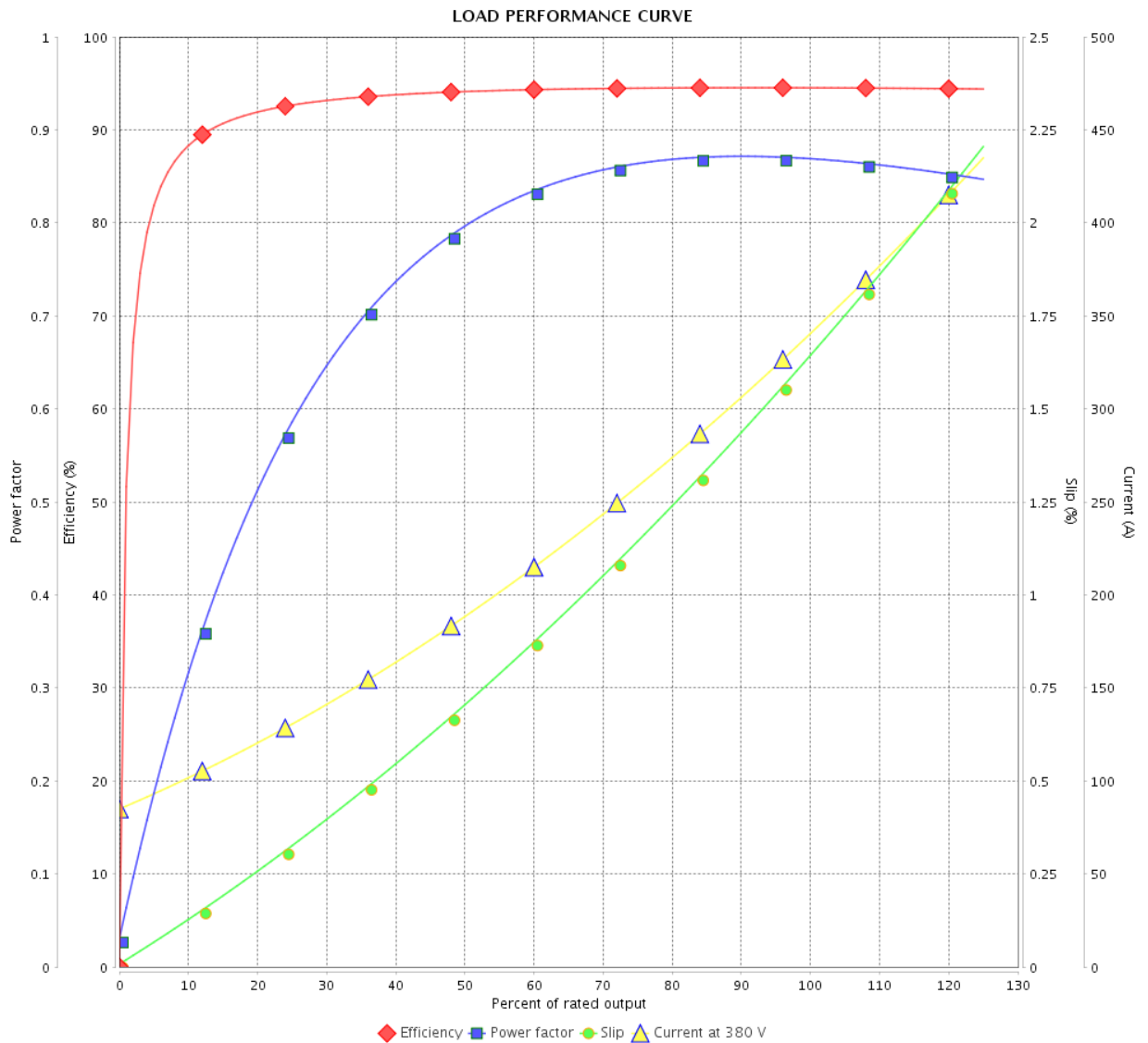

Performance : 380 V 50 Hz 4P IE1

Rated current : 342 A
 LRC : 5.1
 Rated torque : 890 ft.lb
 Locked rotor torque : 180 %
 Breakdown torque : 210 %
 Rated speed : 1475 rpm

Moment of inertia (J) : 89.6 sq.ft.lb
 Duty cycle : Cont.(S1)
 Insulation class : F
 Service factor : 1.00
 Temperature rise : 105 K
 Design : B

Rev.	Changes Summary	Performed	Checked	Date
Performed by		Page		Revision
Checked by		13 / 36		
Date		13 / 04 / 2022		

LOAD PERFORMANCE CURVE

Three Phase Induction Motor - Squirrel Cage



Customer : _____

Product line : NEMA Premium Efficiency Three-Phase

Product code : 11846215

Catalog # : 25018ET3GRB449T-W22

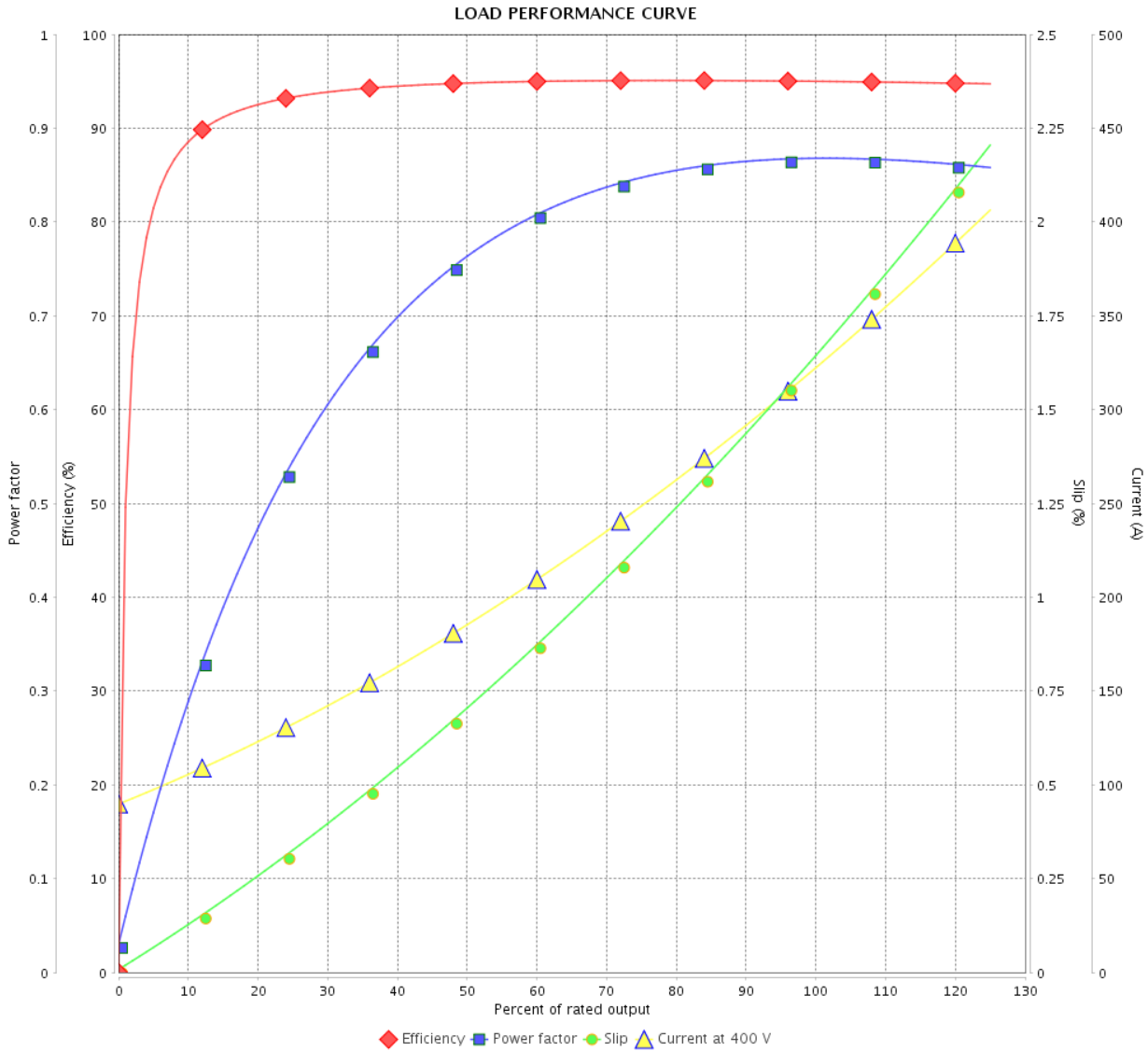

Performance : 400 V 50 Hz 4P IE1

Rated current : 323 A
 LRC : 5.7
 Rated torque : 890 ft.lb
 Locked rotor torque : 200 %
 Breakdown torque : 210 %
 Rated speed : 1475 rpm

Moment of inertia (J) : 89.6 sq.ft.lb
 Duty cycle : Cont.(S1)
 Insulation class : F
 Service factor : 1.00
 Temperature rise : 105 K
 Design : B

Rev.	Changes Summary	Performed	Checked	Date
Performed by		Page		Revision
Checked by		14 / 36		
Date		13/04/2022		

LOAD PERFORMANCE CURVE

Three Phase Induction Motor - Squirrel Cage



Customer :

Product line : NEMA Premium Efficiency Three-Phase

Product code : 11846215

Catalog # : 25018ET3GRB449T-W22

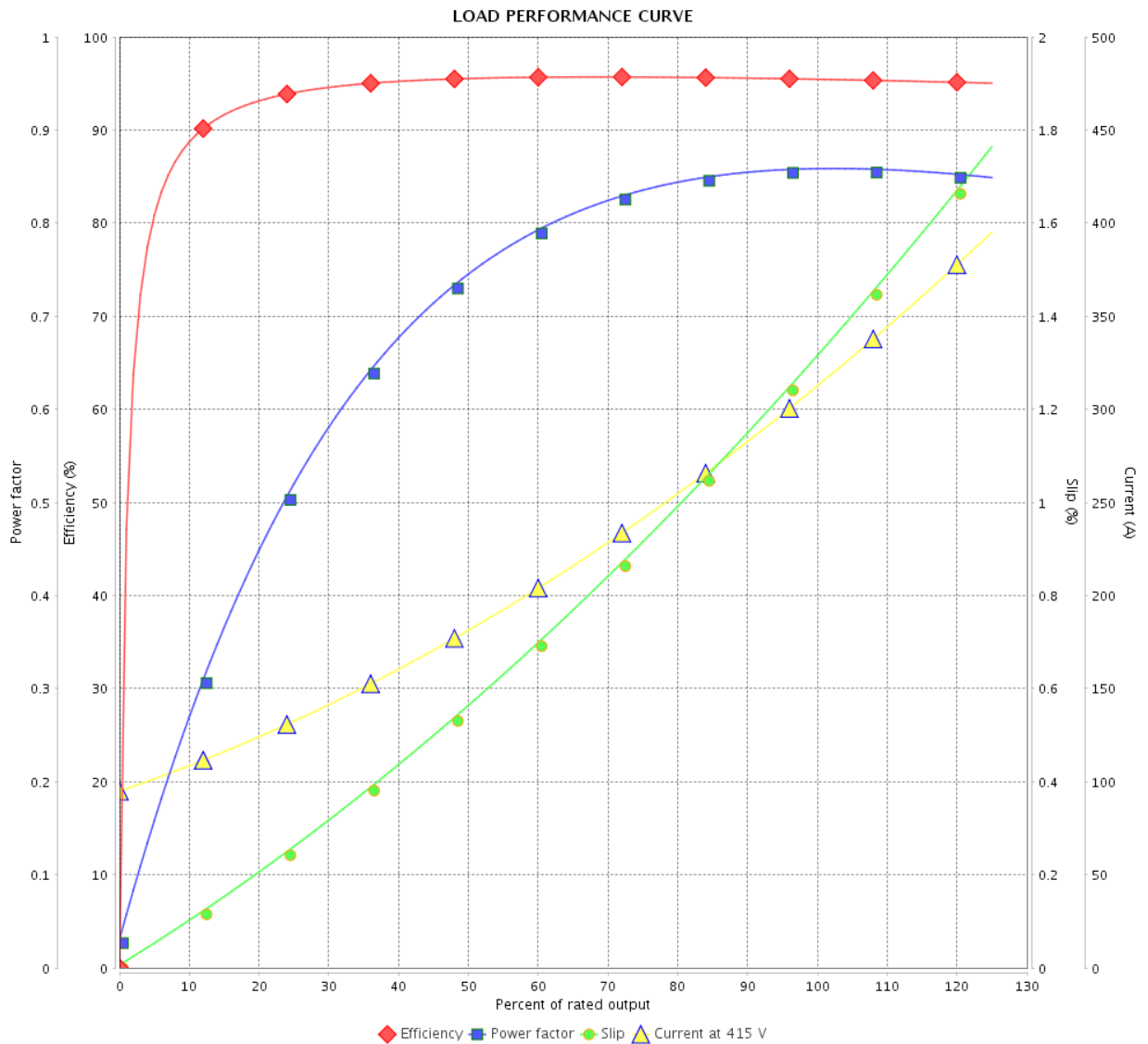

Performance : 415 V 50 Hz 4P IE2

Rated current : 314 A
 LRC : 6.1
 Rated torque : 887 ft.lb
 Locked rotor torque : 220 %
 Breakdown torque : 229 %
 Rated speed : 1480 rpm

Moment of inertia (J) : 89.6 sq.ft.lb
 Duty cycle : Cont.(S1)
 Insulation class : F
 Service factor : 1.00
 Temperature rise : 105 K
 Design : B

Rev.	Changes Summary	Performed	Checked	Date
Performed by		Page		Revision
Checked by		15 / 36		
Date		13/04/2022		

THERMAL LIMIT CURVE

Three Phase Induction Motor - Squirrel Cage



Customer :

Product line : NEMA Premium Efficiency Three-Phase
Product code : 11846215
Catalog # : 25018ET3GRB449T-W22

Performance : 460 V 60 Hz 4P

Rated current	: 281 A	Moment of inertia (J)	: 89.6 sq.ft.lb
LRC	: 6.5	Duty cycle	: Cont.(S1)
Rated torque	: 738 ft.lb	Insulation class	: F
Locked rotor torque	: 229 %	Service factor	: 1.15
Breakdown torque	: 229 %	Temperature rise	: 80 K
Rated speed	: 1780 rpm	Design	: B

Heating constant

Cooling constant

Rev.	Changes Summary	Performed	Checked	Date
Performed by				
Checked by			Page	Revision
Date	13/04/2022		16 / 36	

THERMAL LIMIT CURVE

Three Phase Induction Motor - Squirrel Cage



Customer : _____

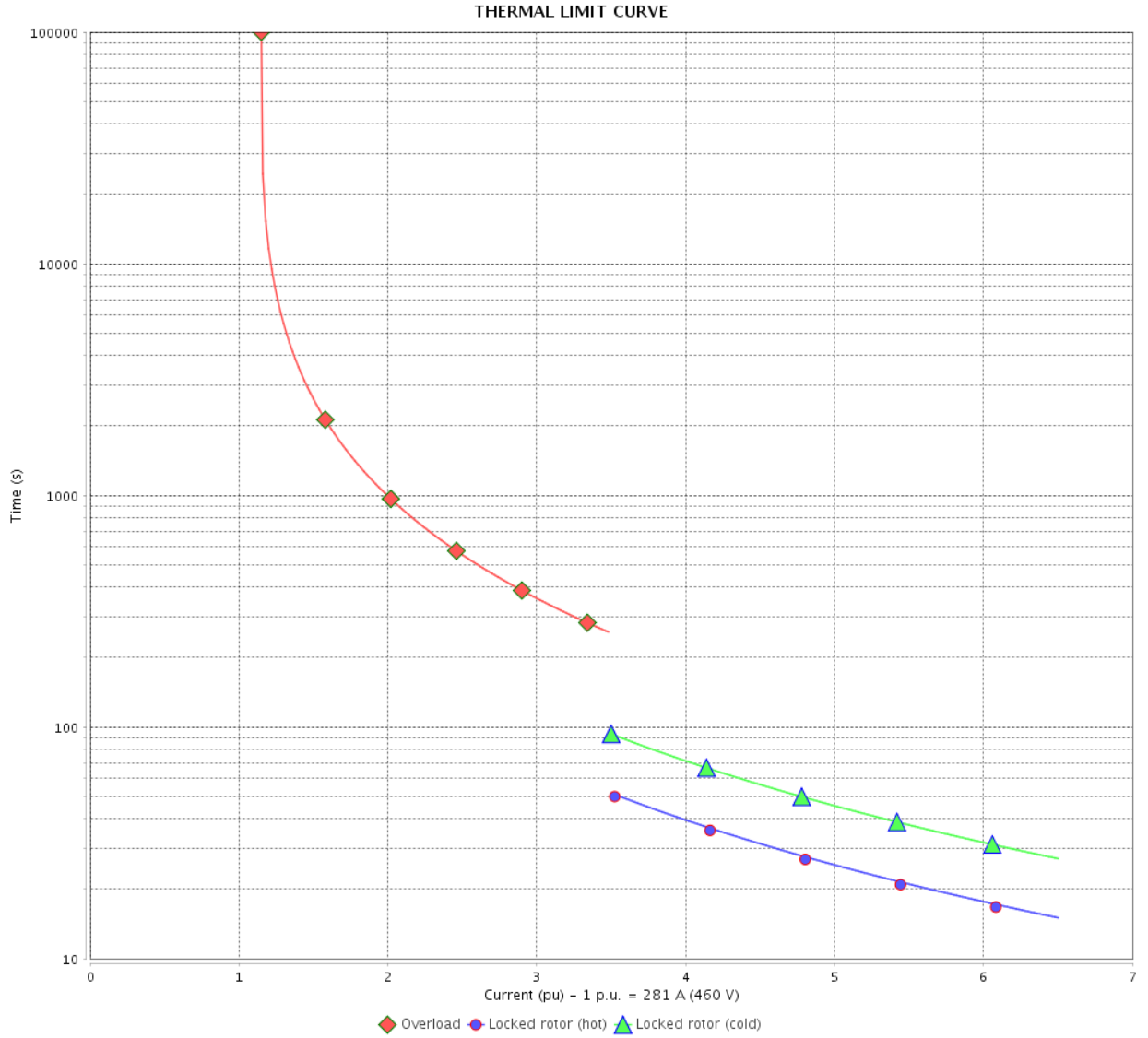

Rev.	Changes Summary	Performed	Checked	Date
Performed by		Page 17 / 36 Revision		
Checked by				
Date				

THERMAL LIMIT CURVE

Three Phase Induction Motor - Squirrel Cage



Customer :

Product line : NEMA Premium Efficiency Three-Phase
Product code : 11846215
Catalog # : 25018ET3GRB449T-W22

Performance : 380 V 50 Hz 4P IE3

Rated current	: 273 A	Moment of inertia (J)	: 89.6 sq.ft.lb
LRC	: 6.1	Duty cycle	: Cont.(S1)
Rated torque	: 710 ft.lb	Insulation class	: F
Locked rotor torque	: 200 %	Service factor	: 1.15
Breakdown torque	: 229 %	Temperature rise	: 80 K
Rated speed	: 1480 rpm	Design	: B

Heating constant

Cooling constant

Rev.	Changes Summary	Performed	Checked	Date
Performed by				
Checked by			Page	Revision
Date	13/04/2022		18 / 36	

THERMAL LIMIT CURVE

Three Phase Induction Motor - Squirrel Cage



Customer : _____

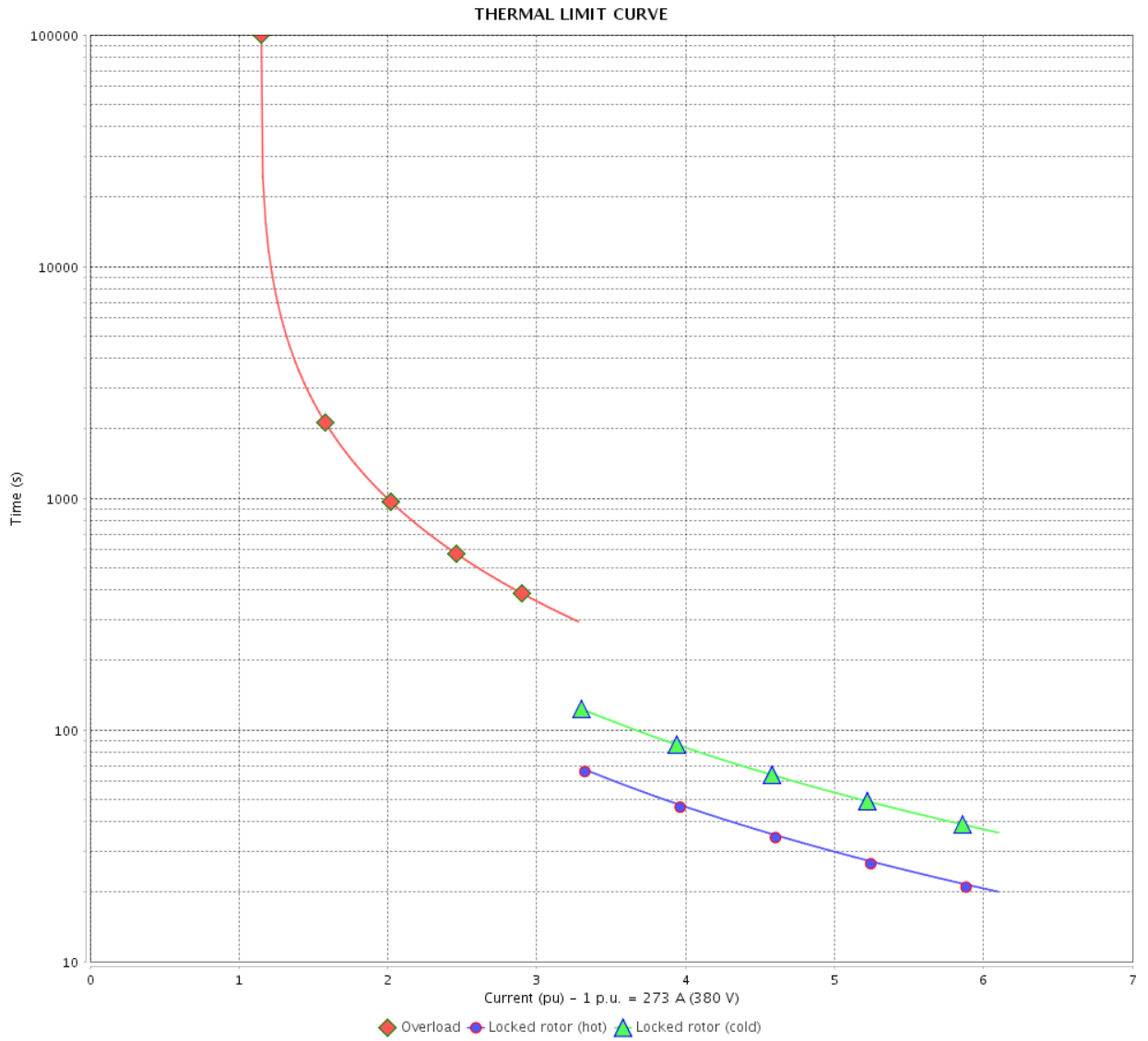

Rev.	Changes Summary	Performed	Checked	Date
Performed by		Page 19 / 36		Revision
Checked by				
Date				

THERMAL LIMIT CURVE

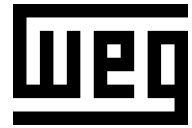

Three Phase Induction Motor - Squirrel Cage

Customer :

Product line : NEMA Premium Efficiency Three-Phase
Product code : 11846215
Catalog # : 25018ET3GRB449T-W22

Performance : 400 V 50 Hz 4P IE3

Rated current	: 263 A	Moment of inertia (J)	: 89.6 sq.ft.lb
LRC	: 6.8	Duty cycle	: Cont.(S1)
Rated torque	: 707 ft.lb	Insulation class	: F
Locked rotor torque	: 260 %	Service factor	: 1.15
Breakdown torque	: 260 %	Temperature rise	: 80 K
Rated speed	: 1485 rpm	Design	: B

Heating constant

Cooling constant

Rev.	Changes Summary	Performed	Checked	Date
Performed by				
Checked by			Page	Revision
Date	13/04/2022		20 / 36	

THERMAL LIMIT CURVE

Three Phase Induction Motor - Squirrel Cage



Customer : _____

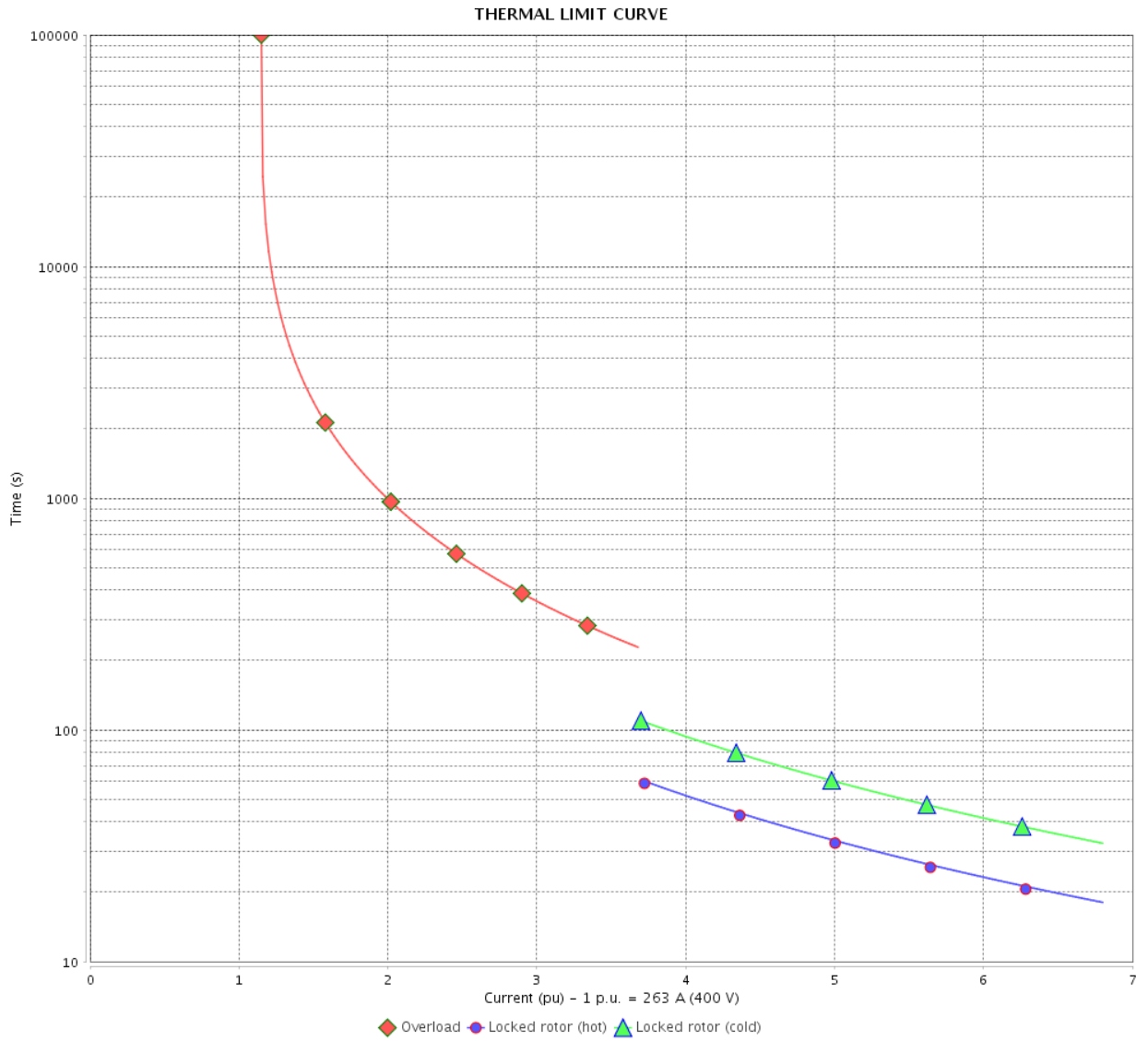

Rev.	Changes Summary	Performed	Checked	Date
Performed by		Page 21 / 36		Revision
Checked by				
Date				

THERMAL LIMIT CURVE

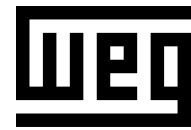

Three Phase Induction Motor - Squirrel Cage

Customer :

Product line : NEMA Premium Efficiency Three-Phase
Product code : 11846215
Catalog # : 25018ET3GRB449T-W22

Performance : 415 V 50 Hz 4P IE3

Rated current	: 256 A	Moment of inertia (J)	: 89.6 sq.ft.lb
LRC	: 7.4	Duty cycle	: Cont.(S1)
Rated torque	: 707 ft.lb	Insulation class	: F
Locked rotor torque	: 290 %	Service factor	: 1.15
Breakdown torque	: 290 %	Temperature rise	: 80 K
Rated speed	: 1485 rpm	Design	: B

Heating constant

Cooling constant

Rev.	Changes Summary	Performed	Checked	Date
Performed by				
Checked by			Page	Revision
Date	13/04/2022		22 / 36	

THERMAL LIMIT CURVE

Three Phase Induction Motor - Squirrel Cage



Customer : _____

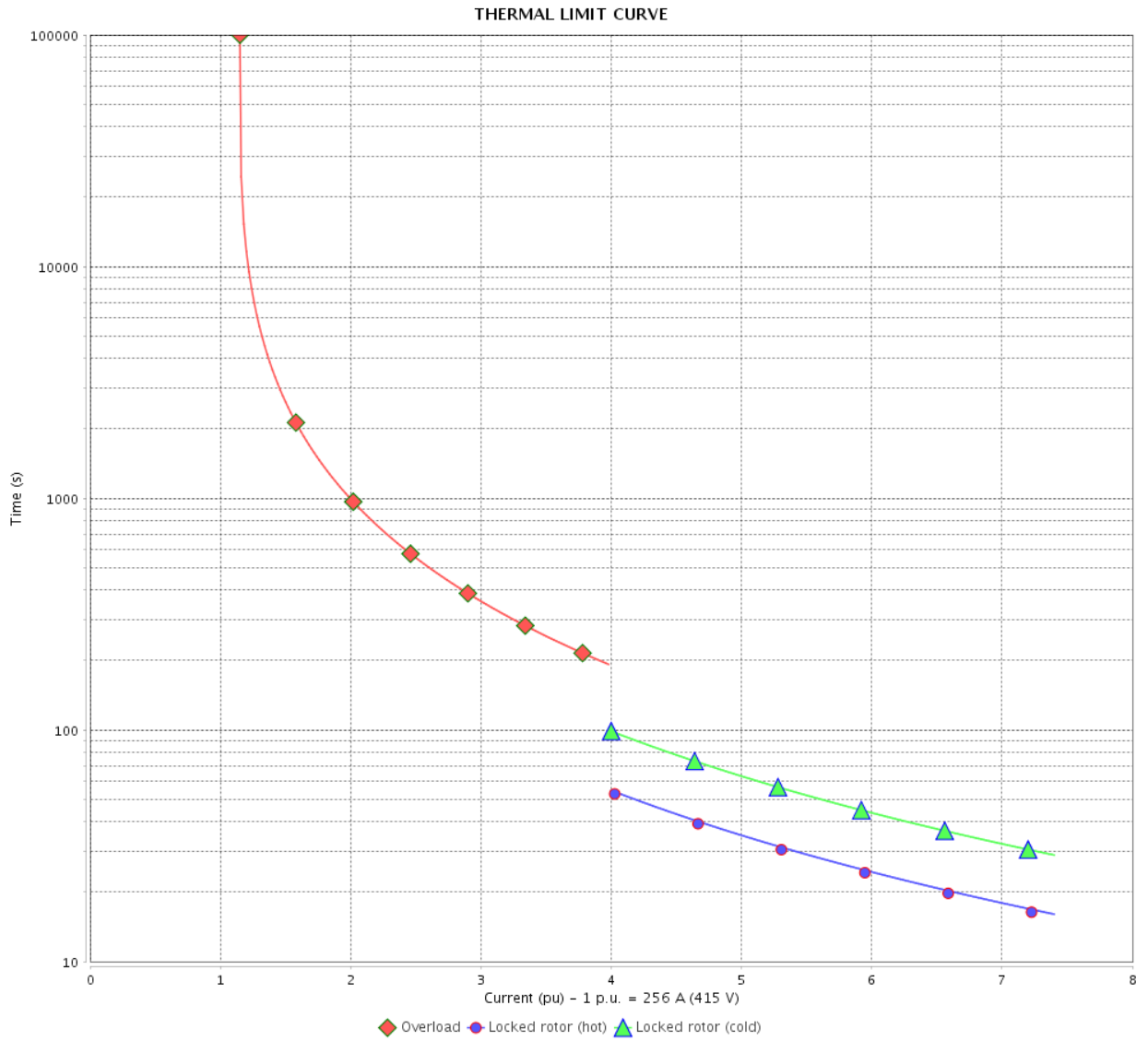

Rev.	Changes Summary	Performed	Checked	Date
Performed by		Page 23 / 36		Revision
Checked by				
Date				

THERMAL LIMIT CURVE

Three Phase Induction Motor - Squirrel Cage



Customer :

Product line : NEMA Premium Efficiency Three-Phase
Product code : 11846215
Catalog # : 25018ET3GRB449T-W22

Performance : 380 V 50 Hz 4P IE1

Rated current	: 342 A	Moment of inertia (J)	: 89.6 sq.ft.lb
LRC	: 5.1	Duty cycle	: Cont.(S1)
Rated torque	: 890 ft.lb	Insulation class	: F
Locked rotor torque	: 180 %	Service factor	: 1.00
Breakdown torque	: 210 %	Temperature rise	: 105 K
Rated speed	: 1475 rpm	Design	: B

Heating constant

Cooling constant

Rev.	Changes Summary	Performed	Checked	Date
Performed by				
Checked by			Page	Revision
Date	13/04/2022		24 / 36	

THERMAL LIMIT CURVE

Three Phase Induction Motor - Squirrel Cage



Customer : _____

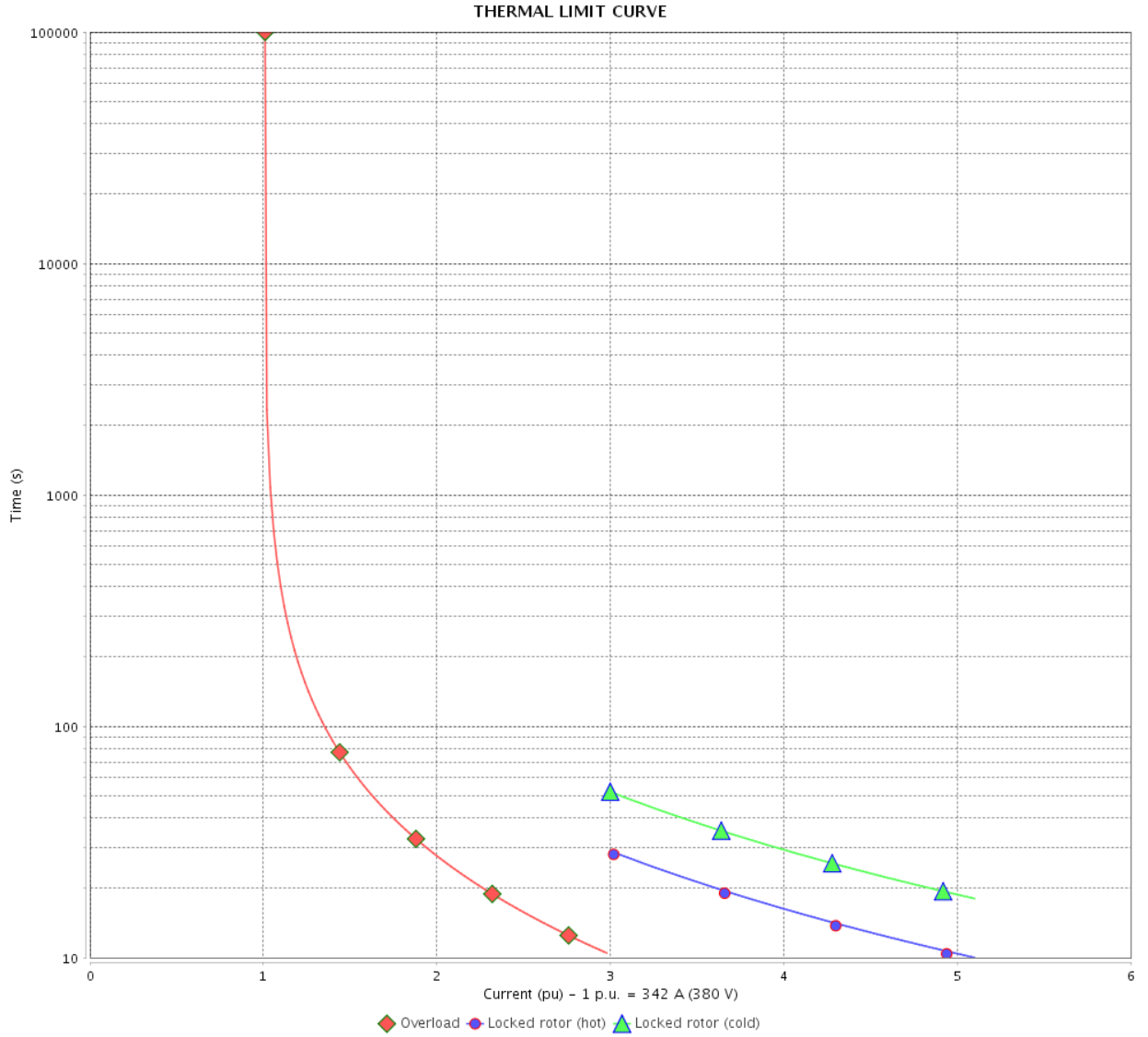

Rev.	Changes Summary	Performed	Checked	Date
Performed by		Page 25 / 36 Revision		
Checked by				
Date				

THERMAL LIMIT CURVE



Three Phase Induction Motor - Squirrel Cage

Customer :

Product line : NEMA Premium Efficiency Three-Phase
Product code : 11846215
Catalog # : 25018ET3GRB449T-W22

Performance : 400 V 50 Hz 4P IE1

Rated current	: 323 A	Moment of inertia (J)	: 89.6 sq.ft.lb
LRC	: 5.7	Duty cycle	: Cont.(S1)
Rated torque	: 890 ft.lb	Insulation class	: F
Locked rotor torque	: 200 %	Service factor	: 1.00
Breakdown torque	: 210 %	Temperature rise	: 105 K
Rated speed	: 1475 rpm	Design	: B

Heating constant

Cooling constant

Rev.	Changes Summary	Performed	Checked	Date
Performed by				
Checked by				
Date	13/04/2022		Page 26 / 36	Revision

THERMAL LIMIT CURVE

Three Phase Induction Motor - Squirrel Cage



Customer : _____

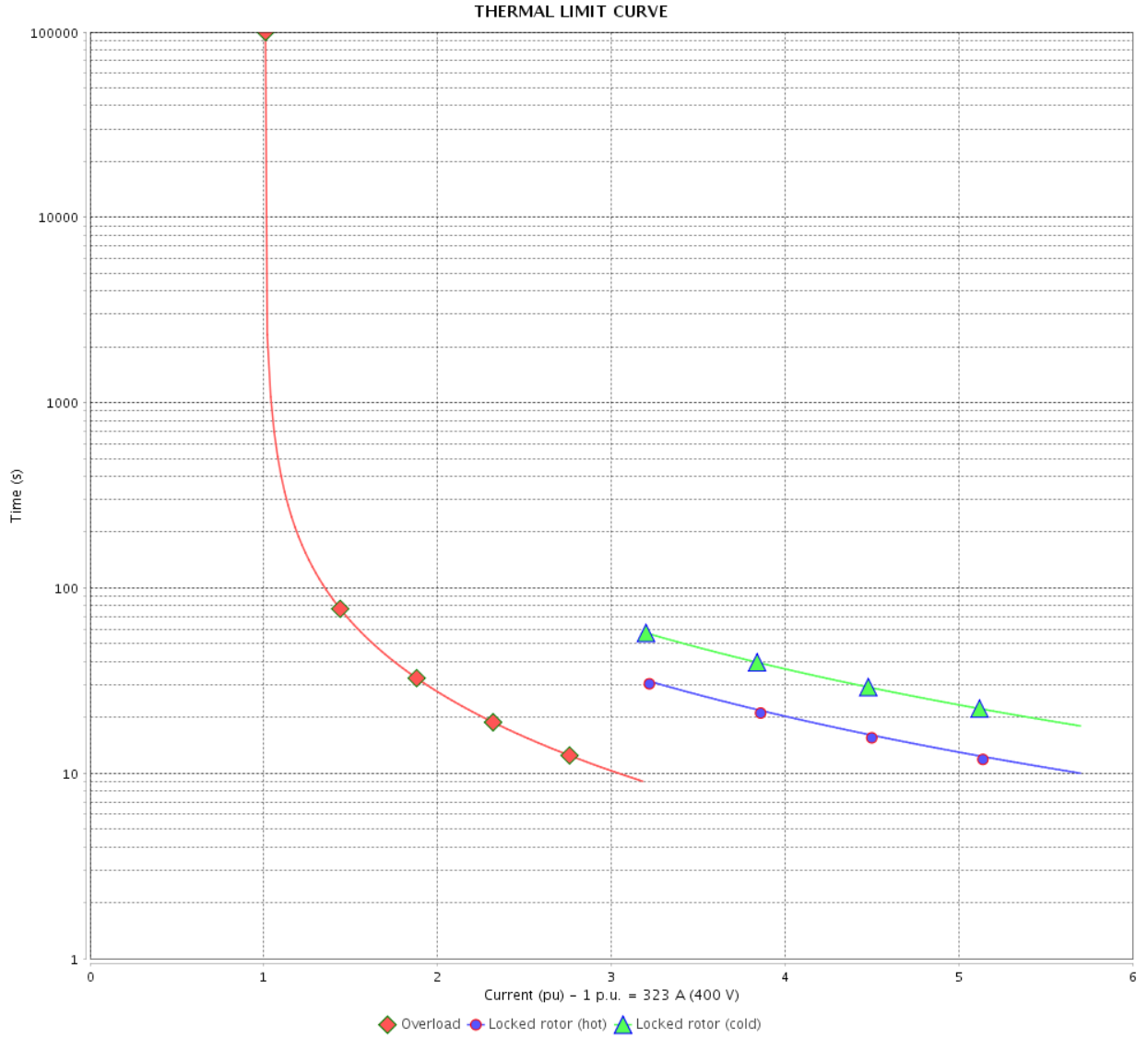

Rev.	Changes Summary	Performed	Checked	Date
Performed by		Page 27 / 36		Revision
Checked by				
Date				

THERMAL LIMIT CURVE



Three Phase Induction Motor - Squirrel Cage

Customer :

Product line : NEMA Premium Efficiency Three-Phase
Product code : 11846215
Catalog # : 25018ET3GRB449T-W22

Performance : 415 V 50 Hz 4P IE2

Rated current	: 314 A	Moment of inertia (J)	: 89.6 sq.ft.lb
LRC	: 6.1	Duty cycle	: Cont.(S1)
Rated torque	: 887 ft.lb	Insulation class	: F
Locked rotor torque	: 220 %	Service factor	: 1.00
Breakdown torque	: 229 %	Temperature rise	: 105 K
Rated speed	: 1480 rpm	Design	: B

Heating constant

Cooling constant

Rev.	Changes Summary	Performed	Checked	Date
Performed by				
Checked by			Page	Revision
Date	13/04/2022		28 / 36	

THERMAL LIMIT CURVE

Three Phase Induction Motor - Squirrel Cage



Customer : _____

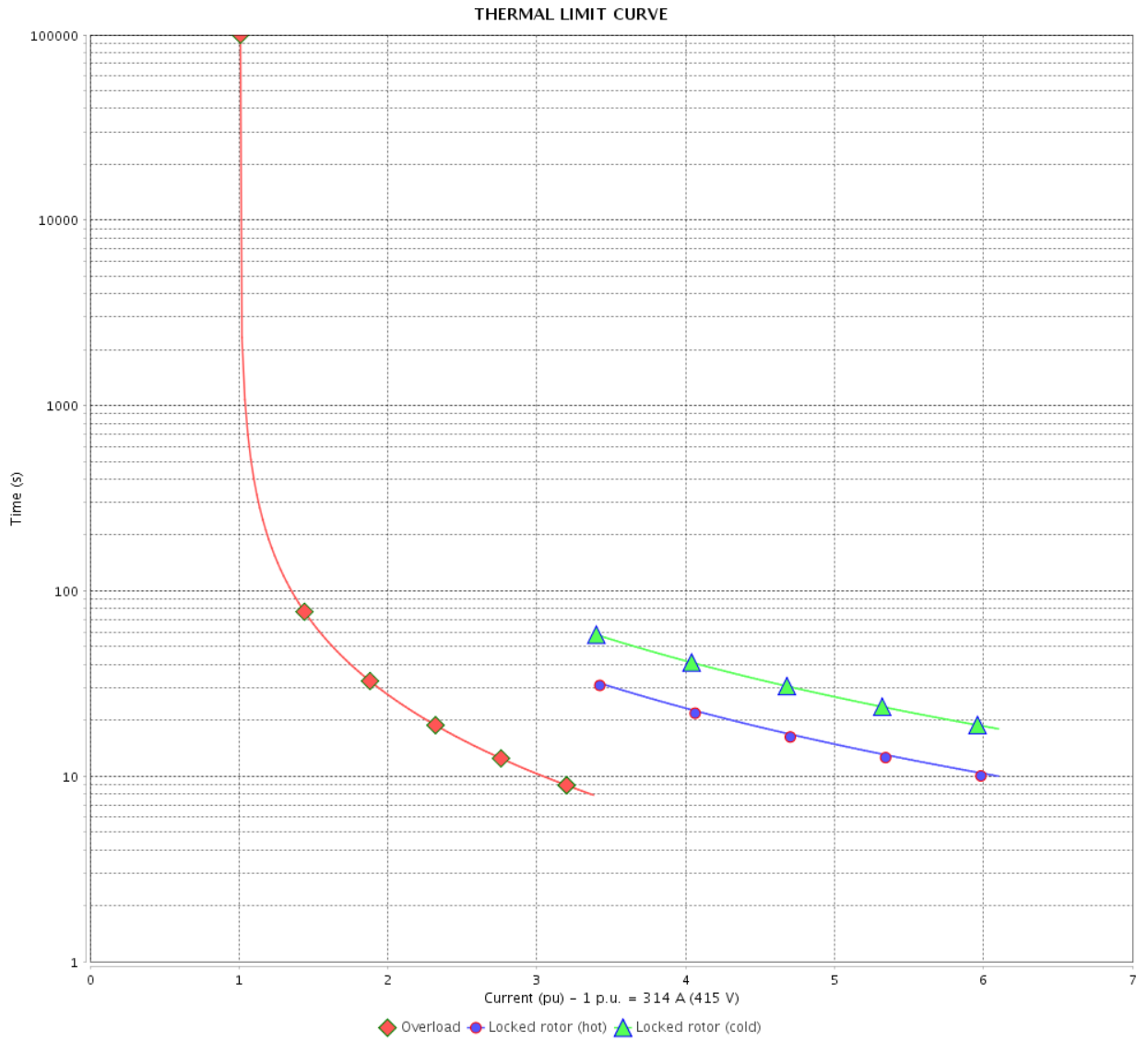

Rev.	Changes Summary	Performed	Checked	Date
Performed by		Page 29 / 36		Revision
Checked by				
Date				

VFD OPERATION CURVE

Three Phase Induction Motor - Squirrel Cage



Customer :

Product line : NEMA Premium Efficiency Three-Phase

Product code : 11846215

Catalog # : 25018ET3GRB449T-W22

VFD OPERATION CURVE

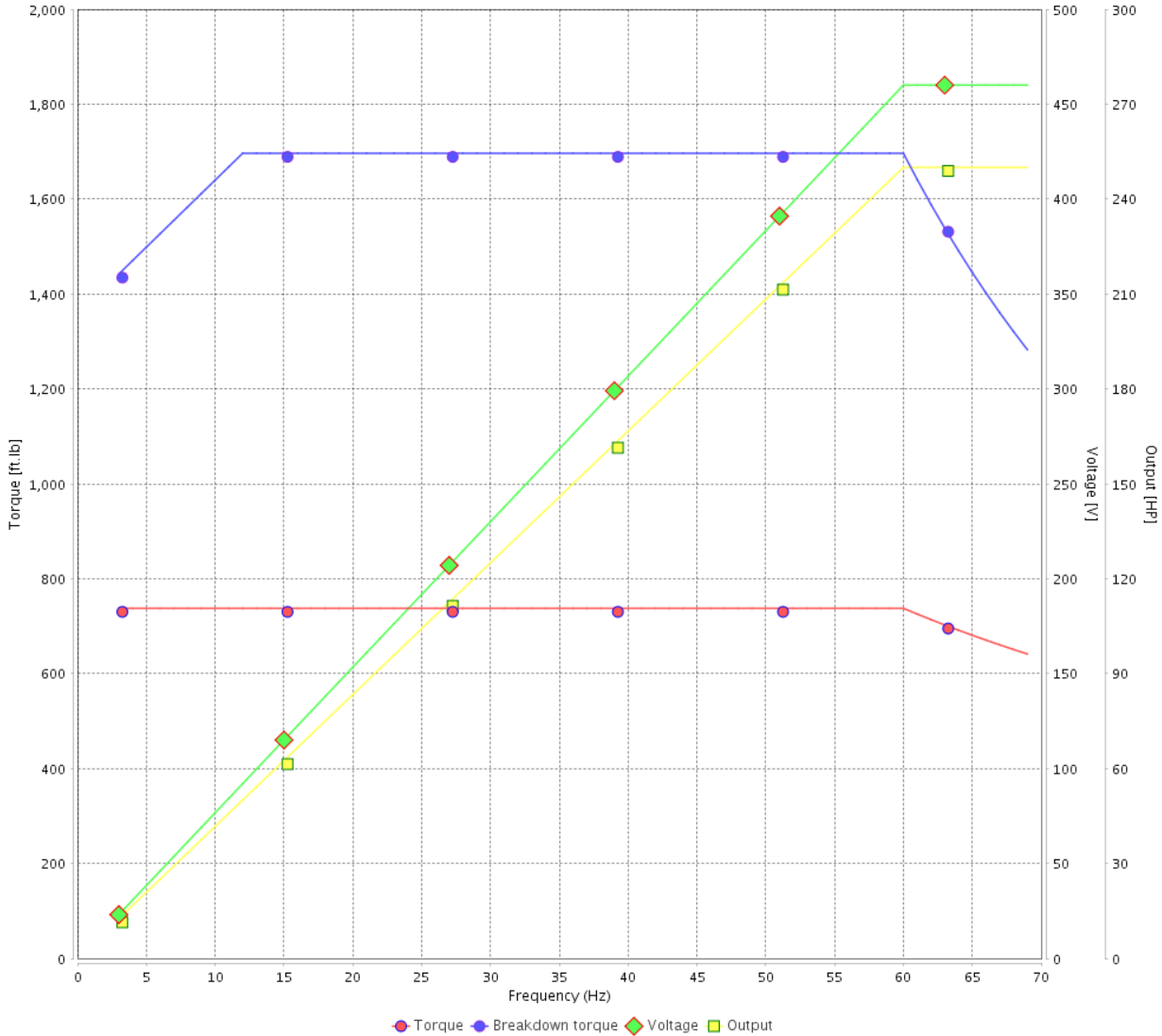

Performance : 460 V 60 Hz 4P

Rated current : 281 A
 LRC : 6.5
 Rated torque : 738 ft.lb
 Locked rotor torque : 229 %
 Breakdown torque : 229 %
 Rated speed : 1780 rpm

Moment of inertia (J) : 89.6 sq.ft.lb
 Duty cycle : Cont.(S1)
 Insulation class : F
 Service factor : 1.15
 Temperature rise : 80 K
 Design : B

Rev.	Changes Summary	Performed	Checked	Date
Performed by			Page 30 / 36	Revision
Checked by				
Date	13/04/2022			

VFD OPERATION CURVE

Three Phase Induction Motor - Squirrel Cage



Customer :

Product line : NEMA Premium Efficiency Three-Phase
 Product code : 11846215
 Catalog # : 25018ET3GRB449T-W22

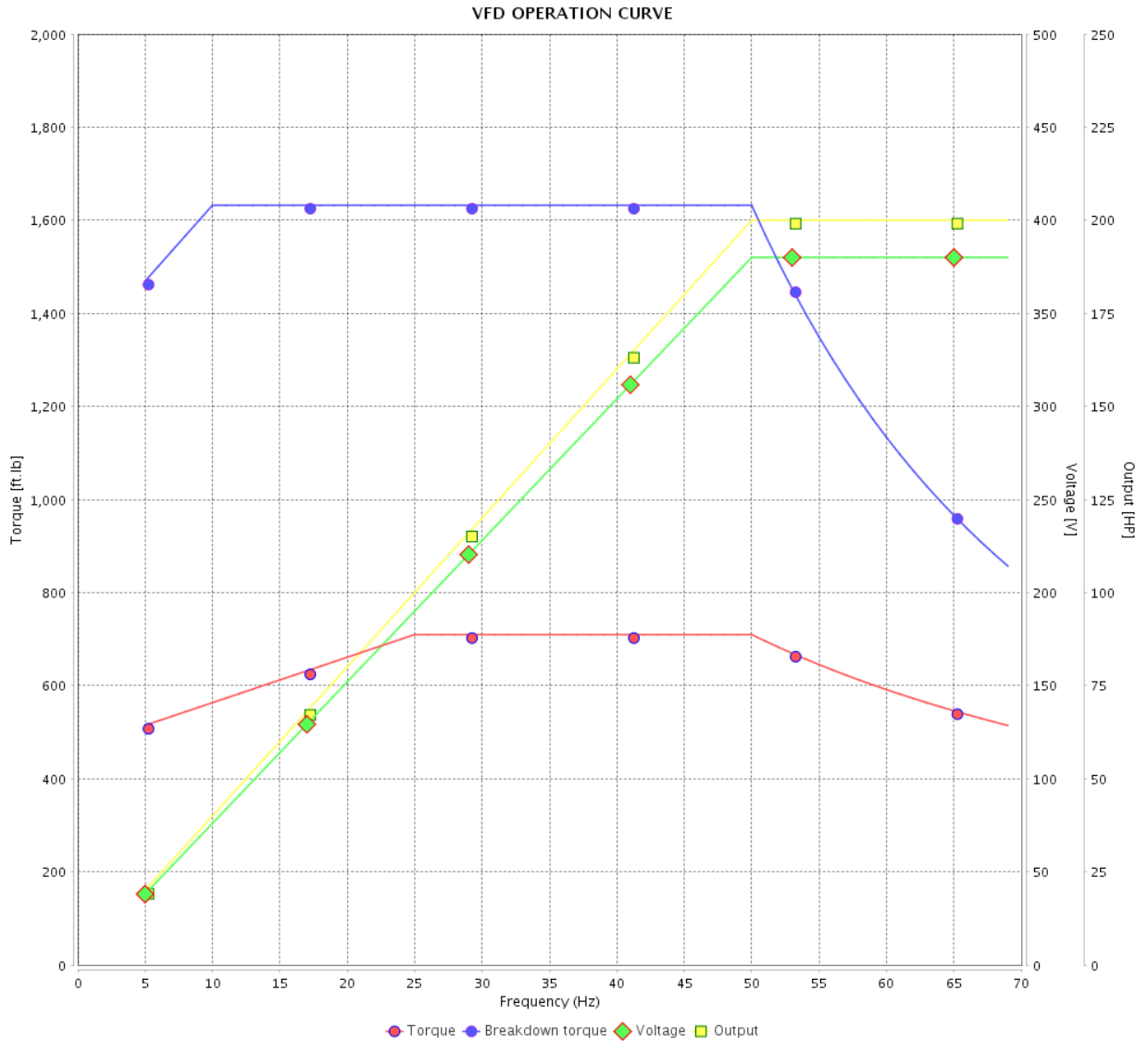

Performance : 380 V 50 Hz 4P IE3

Rated current : 273 A	Moment of inertia (J) : 89.6 sq.ft.lb
LRC : 6.1	Duty cycle : Cont.(S1)
Rated torque : 710 ft.lb	Insulation class : F
Locked rotor torque : 200 %	Service factor : 1.15
Breakdown torque : 229 %	Temperature rise : 80 K
Rated speed : 1480 rpm	Design : B

Rev.	Changes Summary	Performed	Checked	Date
Performed by		Page		Revision
Checked by		31 / 36		
Date		13/04/2022		

VFD OPERATION CURVE

Three Phase Induction Motor - Squirrel Cage



Customer :

Product line : NEMA Premium Efficiency Three-Phase

Product code : 11846215

Catalog # : 25018ET3GRB449T-W22

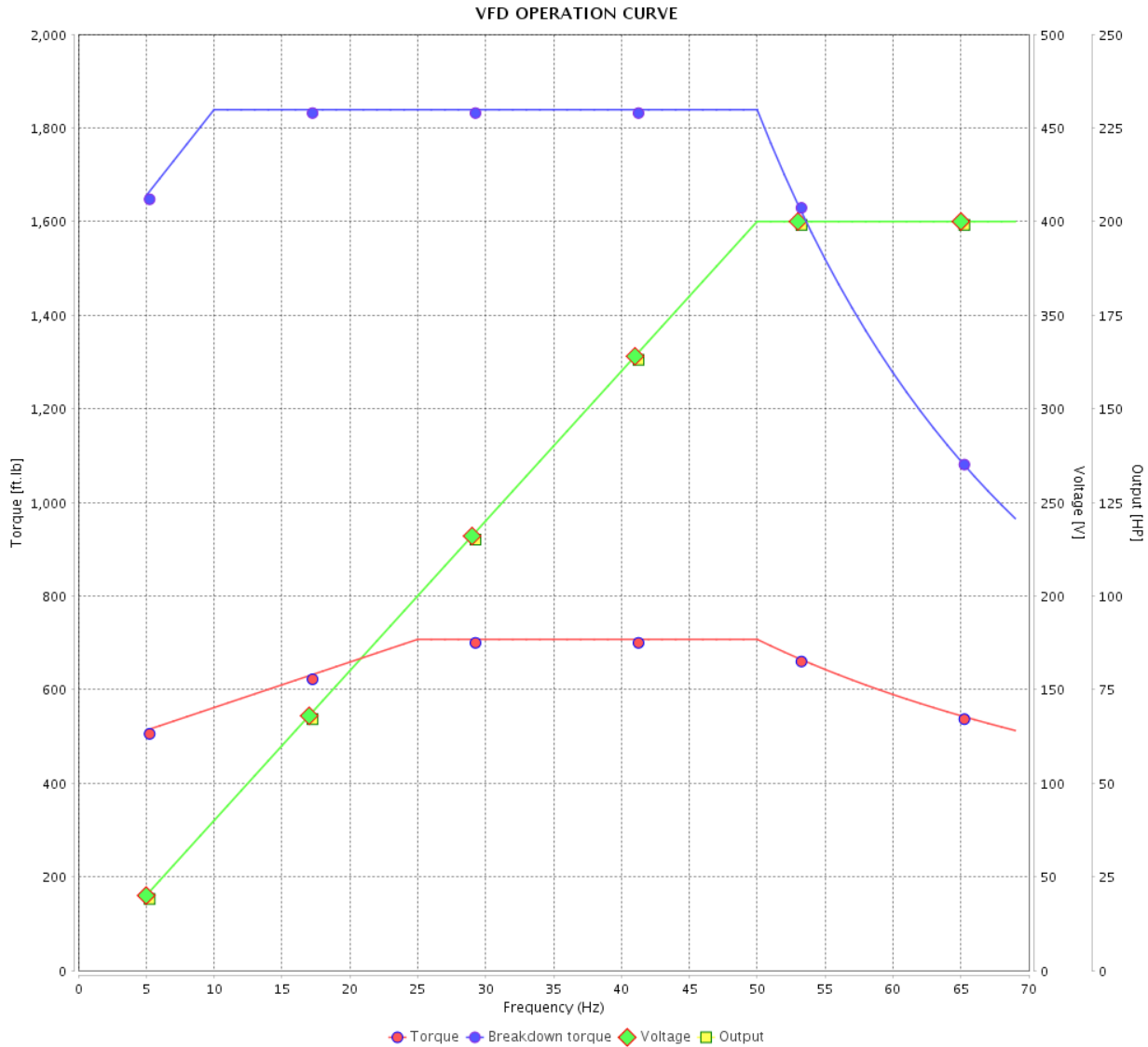

Performance : 400 V 50 Hz 4P IE3

Rated current : 263 A
 LRC : 6.8
 Rated torque : 707 ft.lb
 Locked rotor torque : 260 %
 Breakdown torque : 260 %
 Rated speed : 1485 rpm

Moment of inertia (J) : 89.6 sq.ft.lb
 Duty cycle : Cont.(S1)
 Insulation class : F
 Service factor : 1.15
 Temperature rise : 80 K
 Design : B

Rev.	Changes Summary	Performed	Checked	Date
Performed by			Page 32 / 36	Revision
Checked by				
Date	13/04/2022			

VFD OPERATION CURVE

Three Phase Induction Motor - Squirrel Cage



Customer :

Product line : NEMA Premium Efficiency Three-Phase
 Product code : 11846215
 Catalog # : 25018ET3GRB449T-W22

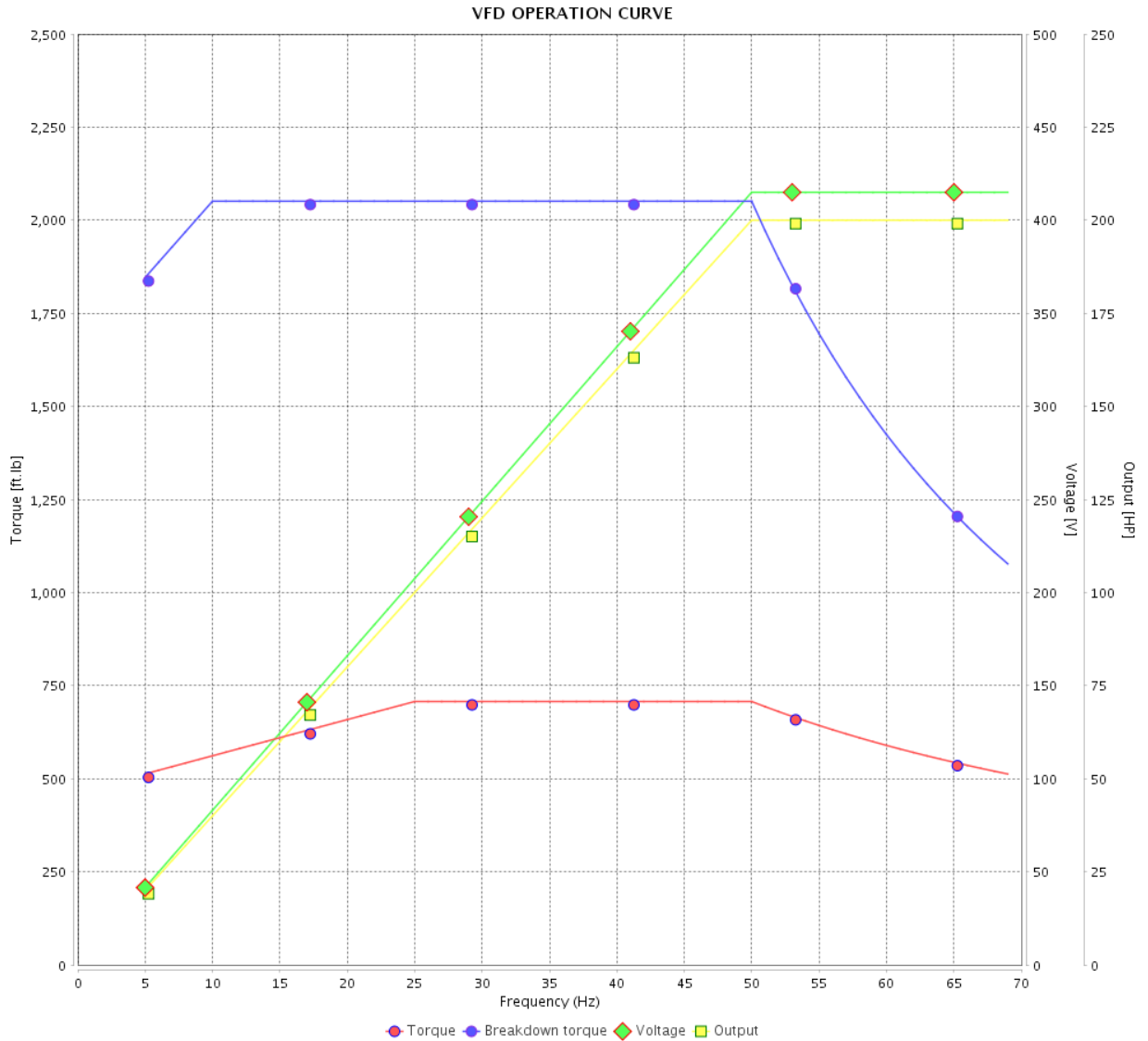

Performance : 415 V 50 Hz 4P IE3

Rated current : 256 A
 LRC : 7.4
 Rated torque : 707 ft.lb
 Locked rotor torque : 290 %
 Breakdown torque : 290 %
 Rated speed : 1485 rpm

Moment of inertia (J) : 89.6 sq.ft.lb
 Duty cycle : Cont.(S1)
 Insulation class : F
 Service factor : 1.15
 Temperature rise : 80 K
 Design : B

Rev.	Changes Summary	Performed	Checked	Date
Performed by		Page		Revision
Checked by		33 / 36		
Date		13/04/2022		

VFD OPERATION CURVE

Three Phase Induction Motor - Squirrel Cage



Customer : _____

Product line : NEMA Premium Efficiency Three-Phase

Product code : 11846215

Catalog # : 25018ET3GRB449T-W22

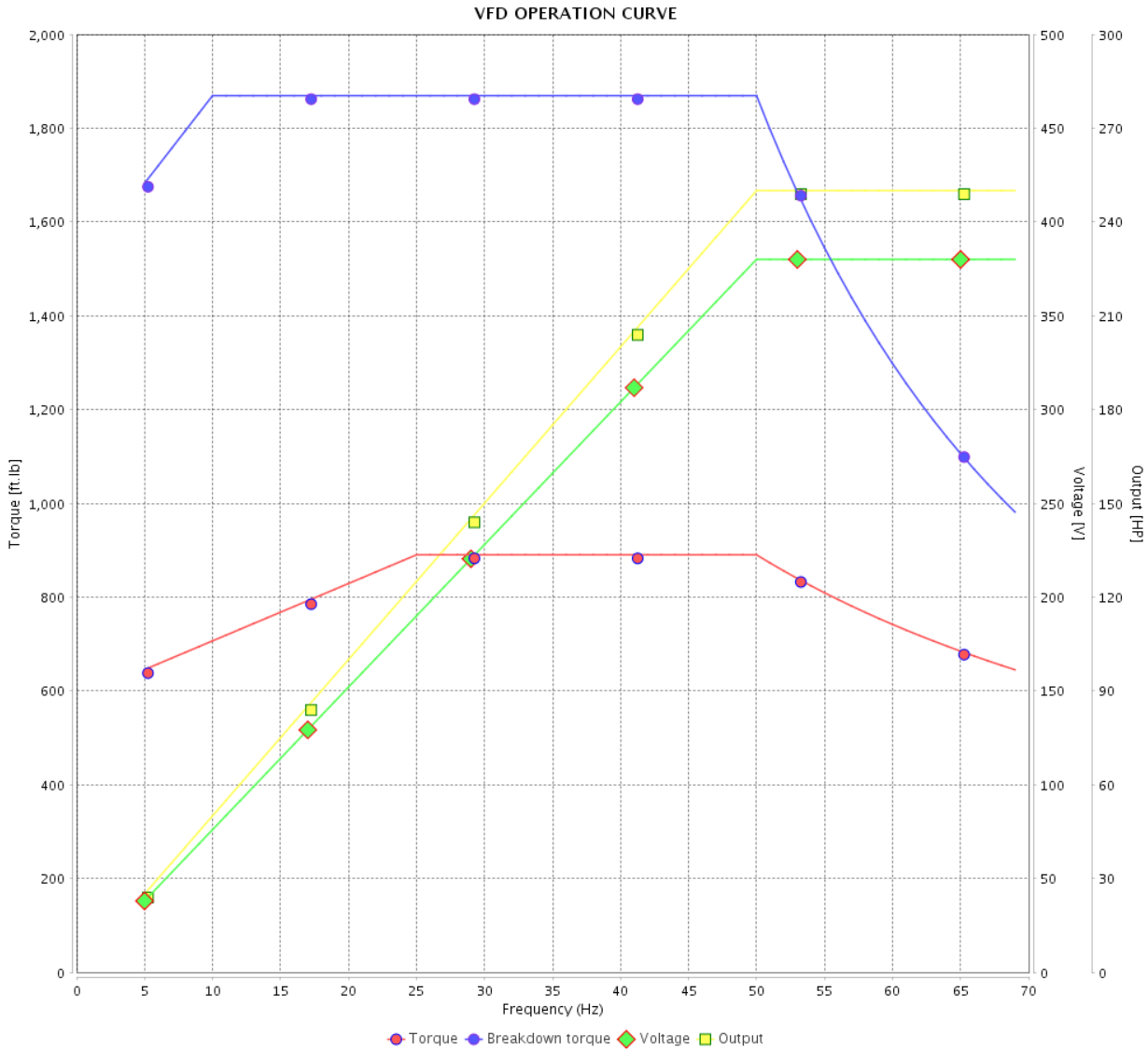

Performance : 380 V 50 Hz 4P IE1

Rated current	: 342 A	Moment of inertia (J)	: 89.6 sq.ft.lb
LRC	: 5.1	Duty cycle	: Cont.(S1)
Rated torque	: 890 ft.lb	Insulation class	: F
Locked rotor torque	: 180 %	Service factor	: 1.00
Breakdown torque	: 210 %	Temperature rise	: 105 K
Rated speed	: 1475 rpm	Design	: B

Rev.	Changes Summary	Performed	Checked	Date
Performed by		Page		Revision
Checked by		34 / 36		
Date	13/04/2022			

VFD OPERATION CURVE

Three Phase Induction Motor - Squirrel Cage



Customer :

Product line : NEMA Premium Efficiency Three-Phase

Product code : 11846215

Catalog # : 25018ET3GRB449T-W22

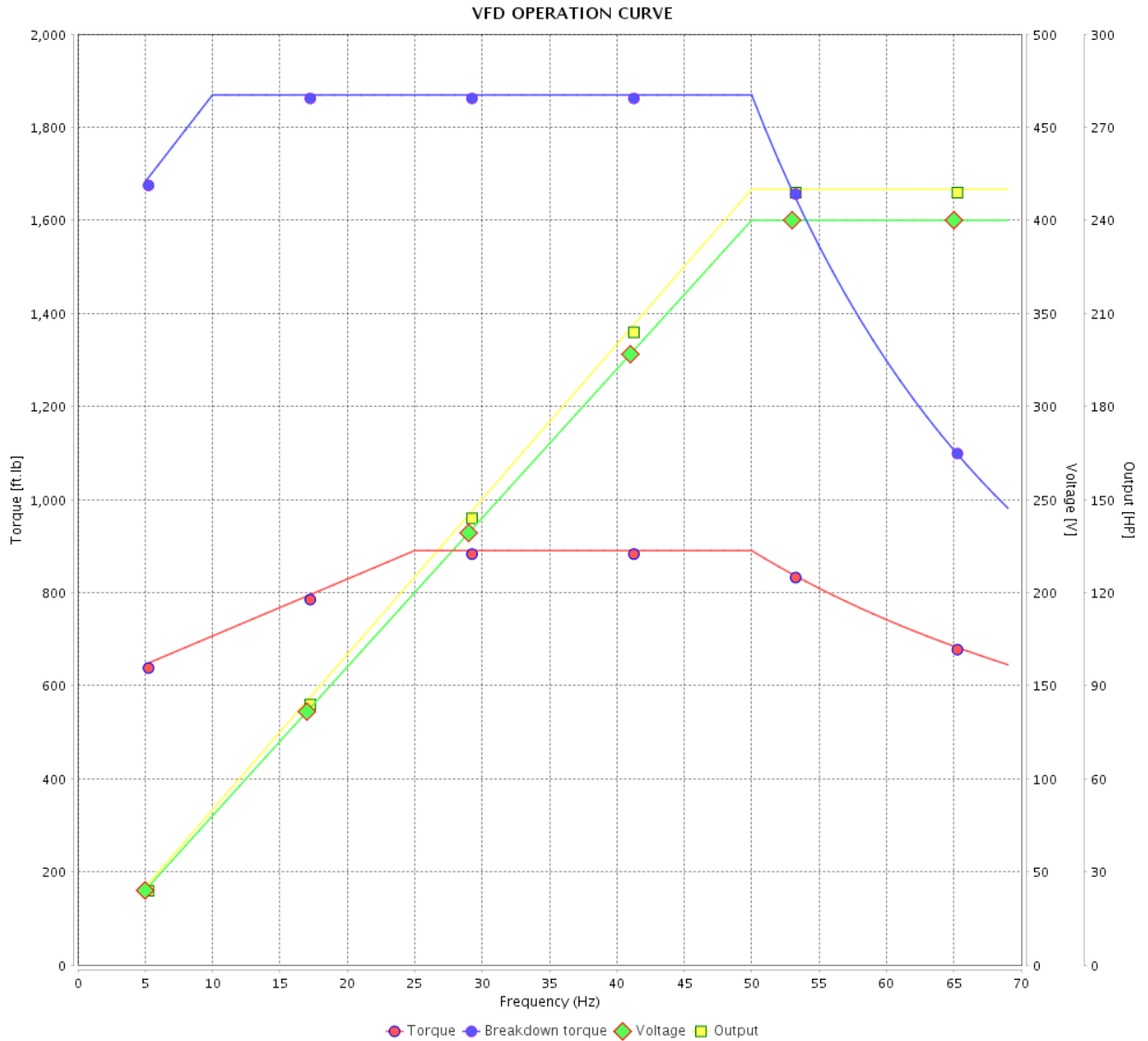

Performance : 400 V 50 Hz 4P IE1

Rated current : 323 A
 LRC : 5.7
 Rated torque : 890 ft.lb
 Locked rotor torque : 200 %
 Breakdown torque : 210 %
 Rated speed : 1475 rpm

Moment of inertia (J) : 89.6 sq.ft.lb
 Duty cycle : Cont.(S1)
 Insulation class : F
 Service factor : 1.00
 Temperature rise : 105 K
 Design : B

Rev.	Changes Summary	Performed	Checked	Date
Performed by			Page	Revision
Checked by				
Date				

VFD OPERATION CURVE

Three Phase Induction Motor - Squirrel Cage



Customer :

Product line : NEMA Premium Efficiency Three-Phase

Product code : 11846215

Catalog # : 25018ET3GRB449T-W22

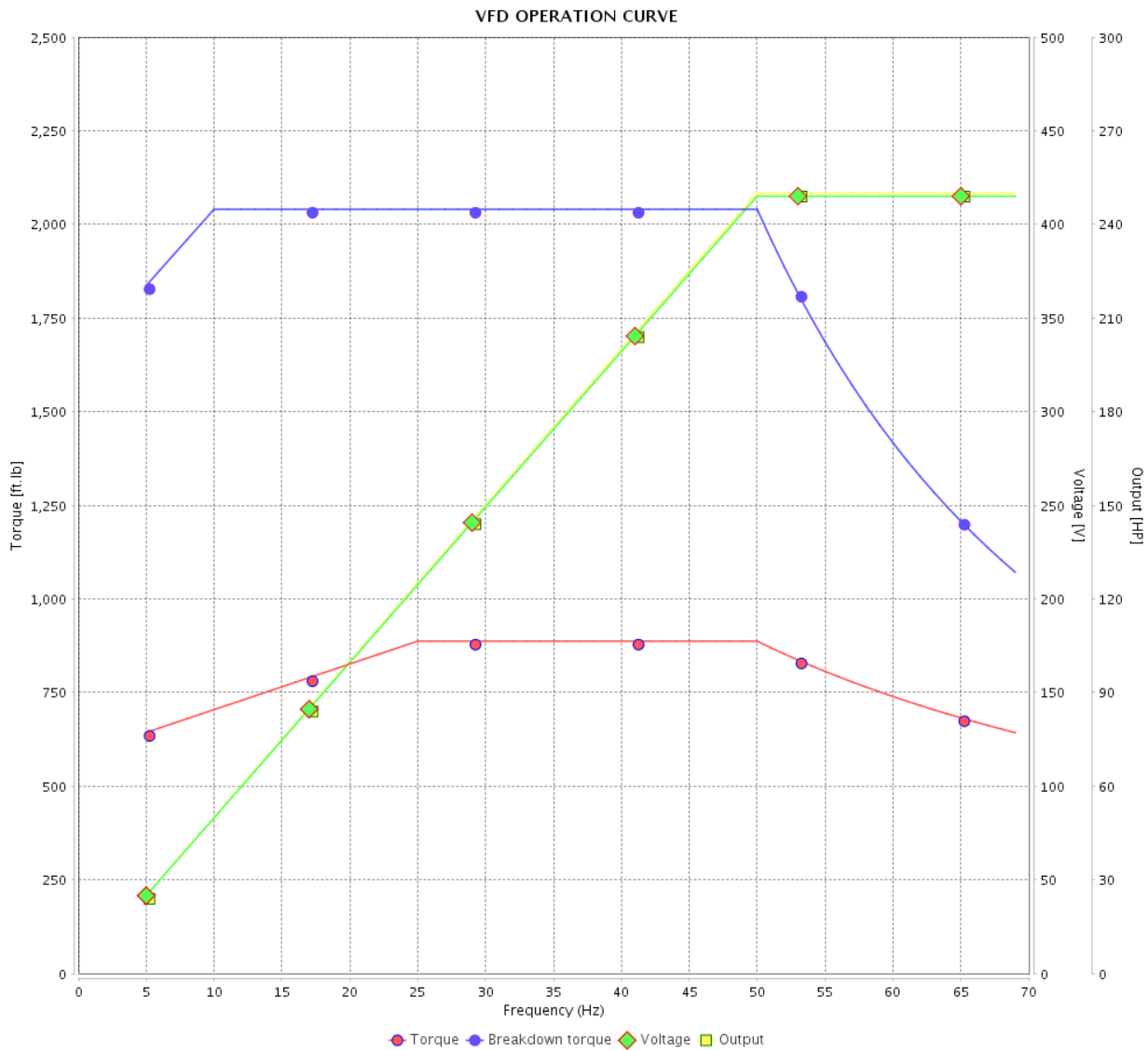

Performance : 415 V 50 Hz 4P IE2

Rated current : 314 A
 LRC : 6.1
 Rated torque : 887 ft.lb
 Locked rotor torque : 220 %
 Breakdown torque : 229 %
 Rated speed : 1480 rpm

Moment of inertia (J) : 89.6 sq.ft.lb
 Duty cycle : Cont.(S1)
 Insulation class : F
 Service factor : 1.00
 Temperature rise : 105 K
 Design : B

Rev.	Changes Summary	Performed	Checked	Date
Performed by			Page	Revision
Checked by				
Date				
			36 / 36	

EIXO/SHAFT	
PADRÃO/STANDARD	X
OPCIONAL/OPTIONAL	
ESPECIAL/SPECIAL	

Dimensões em polegada
Dimensions in inches

CERTIFIED WEG MOTORES
Certified document.
Not subject to changes.

THIS IS AN UPDATED REVISION, THE PREVIOUS ONE MUST BE DISREGARDED.

A
B
C
D
E

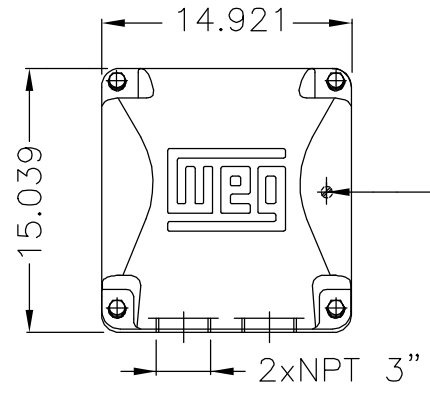
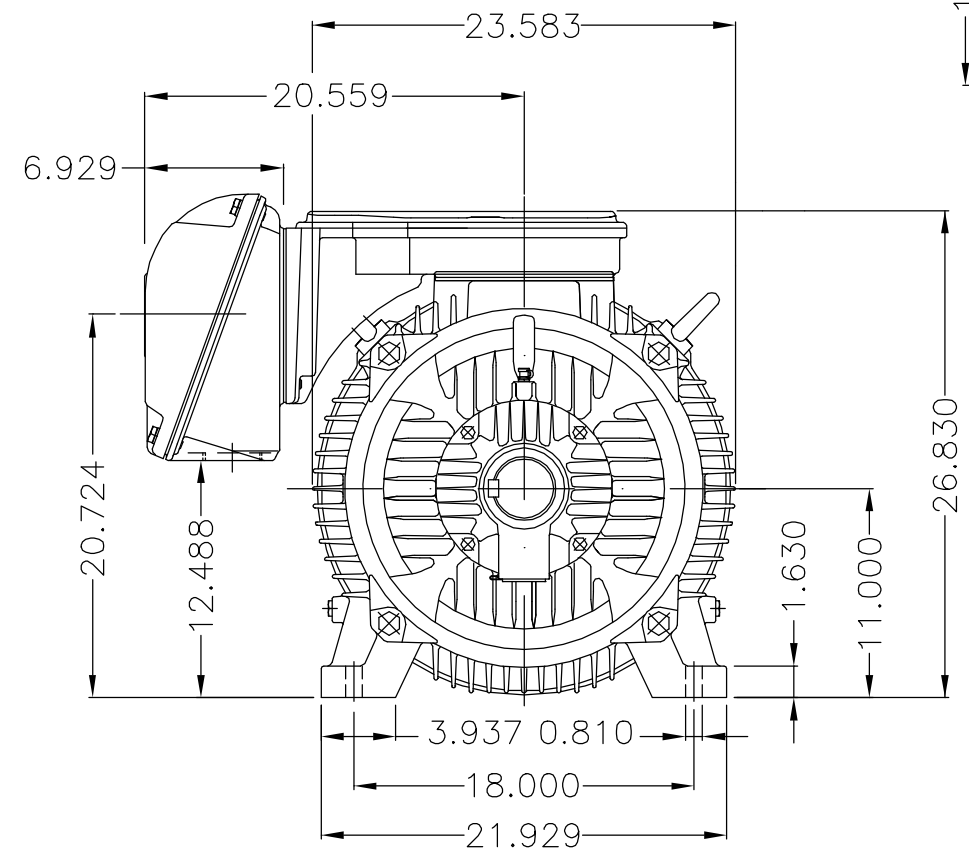

Main terminal box

Grounding for leads 35-70 mm² / 1-2/0 AWG

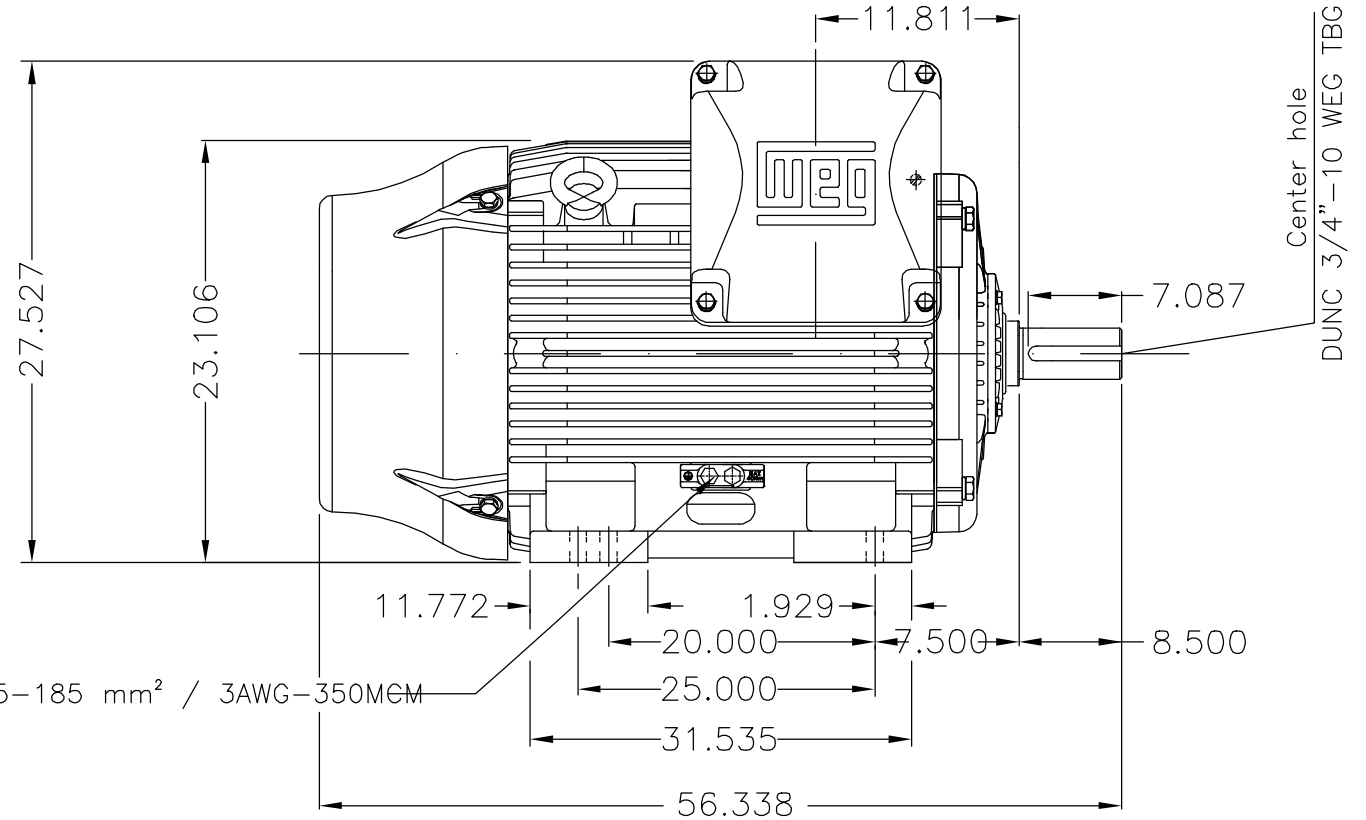

Grounding for leads 25-185 mm² / 3AWG-350MEM

Fixar o conduíte no suporte com abraçadeiras.
Fasten the conduit on support with cables ties.

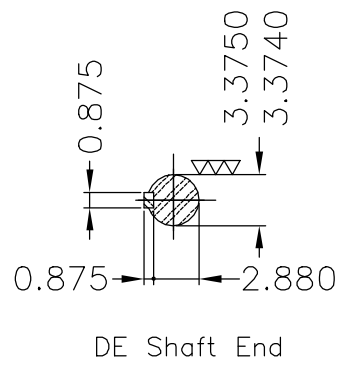
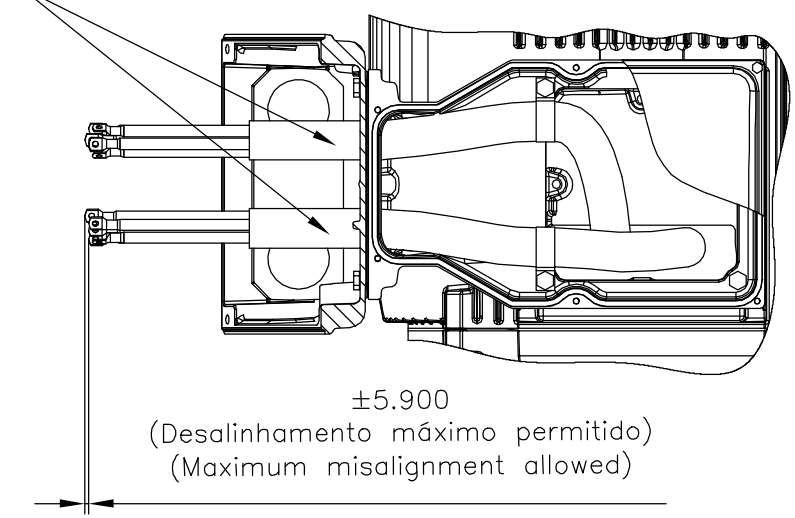

DE Shaft End

Linha do motor: Crusher Duty / Motor purpose: Crusher Duty
Conduíte para cabos no interior do suporte da caixa de ligação Cables conduit inside terminal box support
Rolamento dianteiro de rolos / DE roller bearing
Dispositivo de travamento de eixo / Shaft locking device
Cor RAL 5009 / Color RAL 5009
Plano de pintura 203A / Painting plan 203A
Forma construtiva NEMA F-1 / Mounting NEMA F-1
Forma construtiva B3D / Mounting B3R(D)
WEG ELECTRIC CORPORATION - WEG

500001474636	DOCUMENTO NOVO	DCARDOSO	SAORIN	SAORIN	09.07.2018	00
ECM ECM	LOC LOC	RESUMO MODIFICAÇÃO SUMMARY OF MODIFICATIONS	EXECUTADO EXECUTED	VERIFICADO CHECKED	LIBERADO RELEASED	DATA DATE
EXEC. /EXECUTED	DCARDOSO	THREE PHASE W22 MOTOR - NEMA PREMIUM EFF				
VERIF. /CHECKED	SAORIN	FRAME 447/9T IP55 TEFC				
LIBER. /RELEASED	SAORIN					
DATA LB /REL DT	09.07.2018	WMO Jaraguá do Sul	Product Engineering	FOLHA/SHEET	1 / 1	

200 HP	06 Poles	60Hz	414668751
250 HP	04 Poles	60Hz	414658029



UNCONTROLLED COPY
RELEASED
ZME A3

MADE IN MEXICO
11846215



FOR SAFE AREA
Mod.TE1BFOXON
CC029A





Class I, Div 2, Gr A, B, C and D - T3
Class I, Zone 2, IIC - T3
Class II, Div 2, Gr F and G - T3C
For use on PWM: Gr. A, B, C, D and F,
VT 1000:1, CT 20:1, 1.00SF - T3

MODEL 25018ET3GRB449T-W22

Inverter Duty Motor
Severe Duty

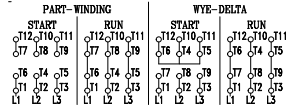
PH3	60Hz	Fr. 447/9T	1000m.a.s.l.	IP55	TEFC	2827lb
V 460				A 281		
HP 250				kW 185		
SF 1.15				SFA 323		
RPM 1780				PF 0.86		
AMB 40°C				INS cl. F DT80K	NEMA NOM EFF 96.2%	
DUTY CONT.				DES B Code G		



-  → NU-322-C3 (60g)
-  → 6319-C3 (45g)

 MOBIL POLYREX EM (4000h)