

# DATA SHEET

## Three Phase Induction Motor - Squirrel Cage



|  |                     |  |  |   |          |
|--|---------------------|--|--|---|----------|
| Customer :   |                     |  |  |   |          |
| Product line   |                     | : W40 NEMA Premium Efficiency<br>Three-Phase | Product code :   | 14285042  |          |
|  |                     |  | Catalog # :  | 25018OT3G445TS-W40  |          |
| Frame  |                     | : 444/5TS                                    | Cooling method : IC01 - ODP  |   |          |
| Insulation class   |                     | : F  | Mounting : F-1   |   |          |
| Duty cycle   |                     | : Cont.(S1)                                  | Rotation <sup>1</sup> : Both (CW and CCW)  |   |          |
| Ambient temperature  |                     | : -20°C to +40°C                             | Starting method : Direct On Line   |   |          |
| Altitude   |                     | : 1000 m.a.s.l.                              | Approx. weight <sup>2</sup> : 1481 lb  |   |          |
| Protection degree  |                     | : IP23                                       | Moment of inertia (J) : 50.9 sq.ft.lb  |   |          |
| Design   |                     | : B  |  |   |          |
| Output [HP]  | 250                 | 200  | 200  | 200   |          |
| Poles  | 4                   | 4  | 4  | 4   |          |
| Frequency [Hz]   | 60                  | 50   | 50   | 50  |          |
| Rated voltage [V]  | 460                 | 380  | 400  | 415   |          |
| Rated current [A]  | 289                 | 283  | 272  | 269   |          |
| L. R. Amperes [A]  | 1850                | 1953   | 1986   | 1991  |          |
| LRC [A]  | 6.4x(Code G)        | 6.9x(Code H)                                 | 7.3x(Code H)   | 7.4x(Code J)  |          |
| No load current [A]  | 106                 | 105  | 115  | 125   |          |
| Rated speed [RPM]  | 1780                | 1480   | 1480   | 1485  |          |
| Slip [%]   | 1.11                | 1.33   | 1.33   | 1.00  |          |
| Rated torque [ft.lb]   | 738                 | 710  | 710  | 707   |          |
| Locked rotor torque [%]  | 210                 | 200  | 229  | 250   |          |
| Breakdown torque [%]   | 240                 | 220  | 240  | 270   |          |
| Service factor   | 1.15                | 1.00   | 1.00   | 1.00  |          |
| Temperature rise   | 80 K                | 80 K   | 80 K   | 80 K  |          |
| Locked rotor time  | 16s (cold) 9s (hot) | 14s (cold) 8s (hot)                          | 14s (cold) 8s (hot)  | 14s (cold) 8s (hot)   |          |
| Noise level <sup>2</sup>   | 78.0 dB(A)          |  |  |   |          |
| Efficiency (%)   | 25%                 | 95.3   | 95.2   | 94.9  |          |
|  | 50%                 | 95.4   | 95.5   | 95.3  |          |
|  | 75%                 | 95.8   | 95.6   | 95.5  |          |
|  | 100%                | 95.8   | 95.8   | 95.8  |          |
| Power Factor   | 25%                 | 0.46   | 0.46   | 0.41  |          |
|  | 50%                 | 0.72   | 0.72   | 0.67  |          |
|  | 75%                 | 0.80   | 0.81   | 0.78  |          |
|  | 100%                | 0.84   | 0.84   | 0.83  |          |
| Bearing type   |                     | <u>Drive end</u> : 6314 C3                   | <u>Non drive end</u> : 6212 Z C3   | Foundation loads<br>Max. traction : 4350 lb<br>Max. compression : 5831 lb |          |
| Sealing  |                     | : Without                                    | : Without  |   |          |
| Lubrication interval   |                     | : 20000 h                                    | : 20000 h  |   |          |
| Lubricant amount   |                     | : 27 g                                       | : 13 g   |   |          |
| Lubricant type   |                     | : Mobil Polyrex EM                           |  |   |          |
| Notes  |                     |  |  |   |          |
| This revision replaces and cancel the previous one, which must be eliminated.<br>(1) Looking the motor from the shaft end.<br>(2) Measured at 1m and with tolerance of +3dB(A).<br>(3) Approximate weight subject to changes after manufacturing process.<br>(4) At 100% of full load. |                     |  | These are average values based on tests with sinusoidal power supply, subject to the tolerances stipulated in NEMA MG-1. |   |          |
| Rev.   | Changes Summary     |  | Performed  | Checked   | Date     |
| Performed by   |                     |  |  |   |          |
| Checked by   |                     |  |  | Page  | Revision |
| Date   | 13/04/2022          |  |  | 1 / 21  |          |

# TORQUE AND CURRENT VS SPEED CURVE

Three Phase Induction Motor - Squirrel Cage



Customer :

Product line : W40 NEMA Premium Efficiency  
Three-Phase

Product code : 14285042

Catalog # : 25018OT3G445TS-W40

TORQUE AND CURRENT VS SPEED CURVE

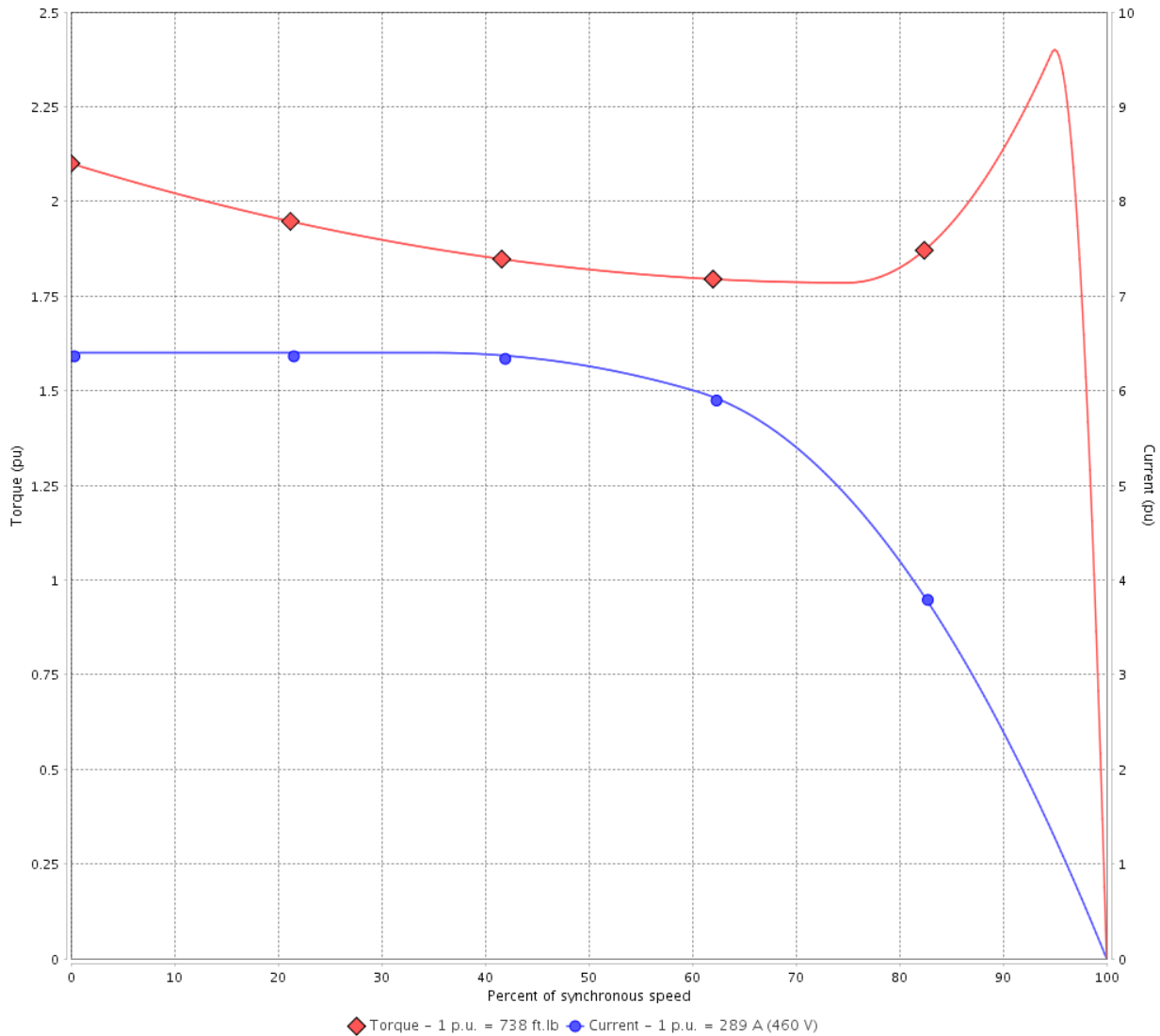

Performance : 460 V 60 Hz 4P

|                     |             |                       |                 |
|---------------------|-------------|-----------------------|-----------------|
| Rated current       | : 289 A     | Moment of inertia (J) | : 50.9 sq.ft.lb |
| LRC                 | : 6.4       | Duty cycle            | : Cont.(S1)     |
| Rated torque        | : 738 ft.lb | Insulation class      | : F             |
| Locked rotor torque | : 210 %     | Service factor        | : 1.15          |
| Breakdown torque    | : 240 %     | Temperature rise      | : 80 K          |
| Rated speed         | : 1780 rpm  | Design                | : B             |

Locked rotor time : 16s (cold) 9s (hot)

| Rev.         | Changes Summary | Performed | Checked        | Date     |
|--------------|-----------------|-----------|----------------|----------|
|              |                 |           |                |          |
| Performed by |                 |           | Page<br>2 / 21 | Revision |
| Checked by   |                 |           |                |          |
| Date         | 13/04/2022      |           |                |          |

# TORQUE AND CURRENT VS SPEED CURVE



## Three Phase Induction Motor - Squirrel Cage

Customer :

Product line : W40 NEMA Premium Efficiency Three-Phase

Product code : 14285042

Catalog # : 25018OT3G445TS-W40

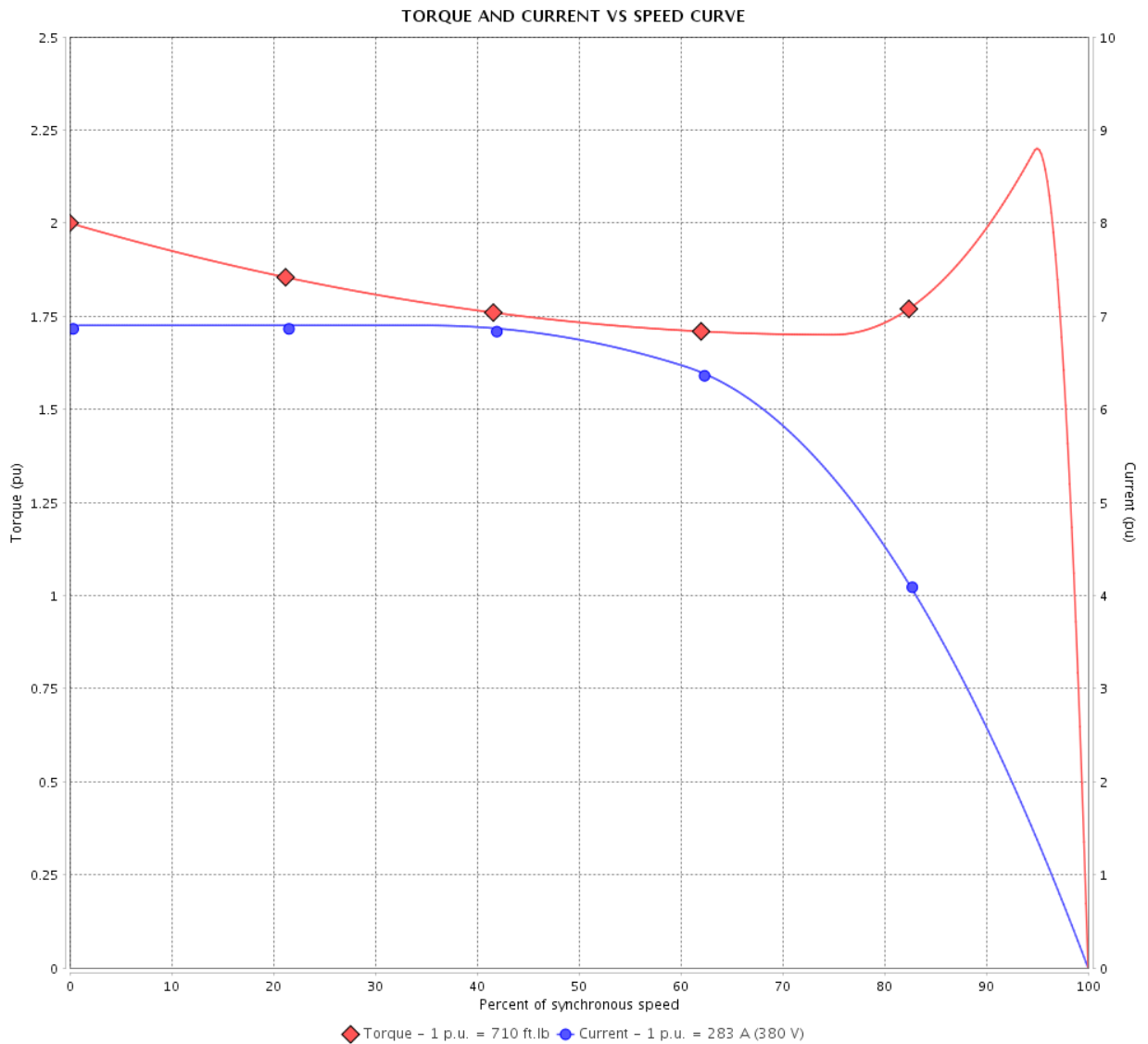

Performance : 380 V 50 Hz 4P IE3

|                     |             |                       |                 |
|---------------------|-------------|-----------------------|-----------------|
| Rated current       | : 283 A     | Moment of inertia (J) | : 50.9 sq.ft.lb |
| LRC                 | : 6.9       | Duty cycle            | : Cont.(S1)     |
| Rated torque        | : 710 ft.lb | Insulation class      | : F             |
| Locked rotor torque | : 200 %     | Service factor        | : 1.00          |
| Breakdown torque    | : 220 %     | Temperature rise      | : 80 K          |
| Rated speed         | : 1480 rpm  | Design                | : B             |

Locked rotor time : 14s (cold) 8s (hot)

| Rev.         | Changes Summary | Performed | Checked        | Date     |
|--------------|-----------------|-----------|----------------|----------|
|              |                 |           |                |          |
| Performed by |                 |           | Page<br>3 / 21 | Revision |
| Checked by   |                 |           |                |          |
| Date         | 13/04/2022      |           |                |          |

# TORQUE AND CURRENT VS SPEED CURVE

## Three Phase Induction Motor - Squirrel Cage



Customer :

Product line : W40 NEMA Premium Efficiency  
Three-Phase

Product code : 14285042

Catalog # : 25018OT3G445TS-W40

TORQUE AND CURRENT VS SPEED CURVE

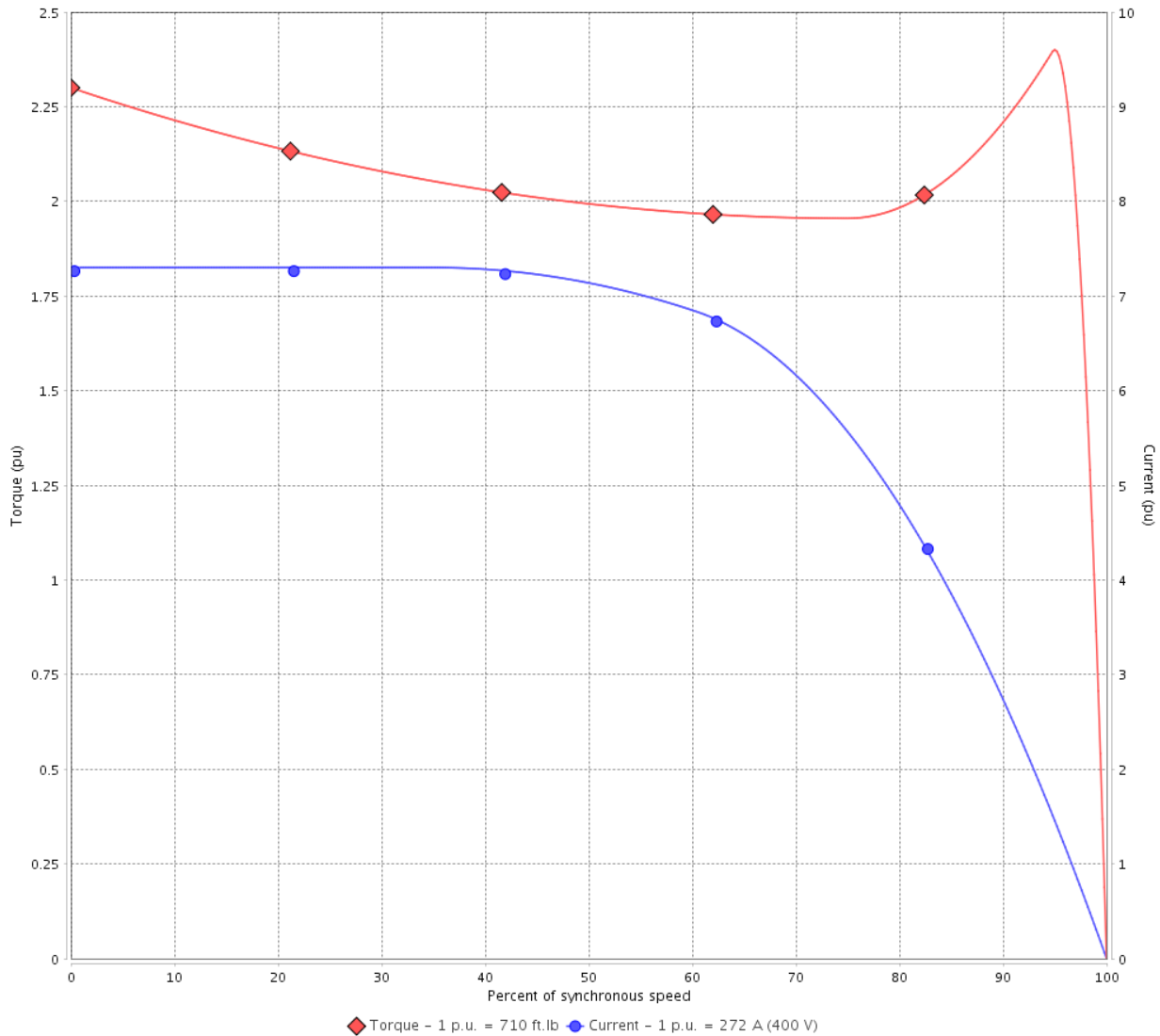

Performance : 400 V 50 Hz 4P IE3

|                     |             |                       |                 |
|---------------------|-------------|-----------------------|-----------------|
| Rated current       | : 272 A     | Moment of inertia (J) | : 50.9 sq.ft.lb |
| LRC                 | : 7.3       | Duty cycle            | : Cont.(S1)     |
| Rated torque        | : 710 ft.lb | Insulation class      | : F             |
| Locked rotor torque | : 229 %     | Service factor        | : 1.00          |
| Breakdown torque    | : 240 %     | Temperature rise      | : 80 K          |
| Rated speed         | : 1480 rpm  | Design                | : B             |

Locked rotor time : 14s (cold) 8s (hot)

| Rev.         | Changes Summary | Performed | Checked        | Date     |
|--------------|-----------------|-----------|----------------|----------|
|              |                 |           |                |          |
| Performed by |                 |           | Page<br>4 / 21 | Revision |
| Checked by   |                 |           |                |          |
| Date         | 13/04/2022      |           |                |          |

# TORQUE AND CURRENT VS SPEED CURVE



## Three Phase Induction Motor - Squirrel Cage

Customer :

Product line : W40 NEMA Premium Efficiency Three-Phase

Product code : 14285042

Catalog # : 25018OT3G445TS-W40

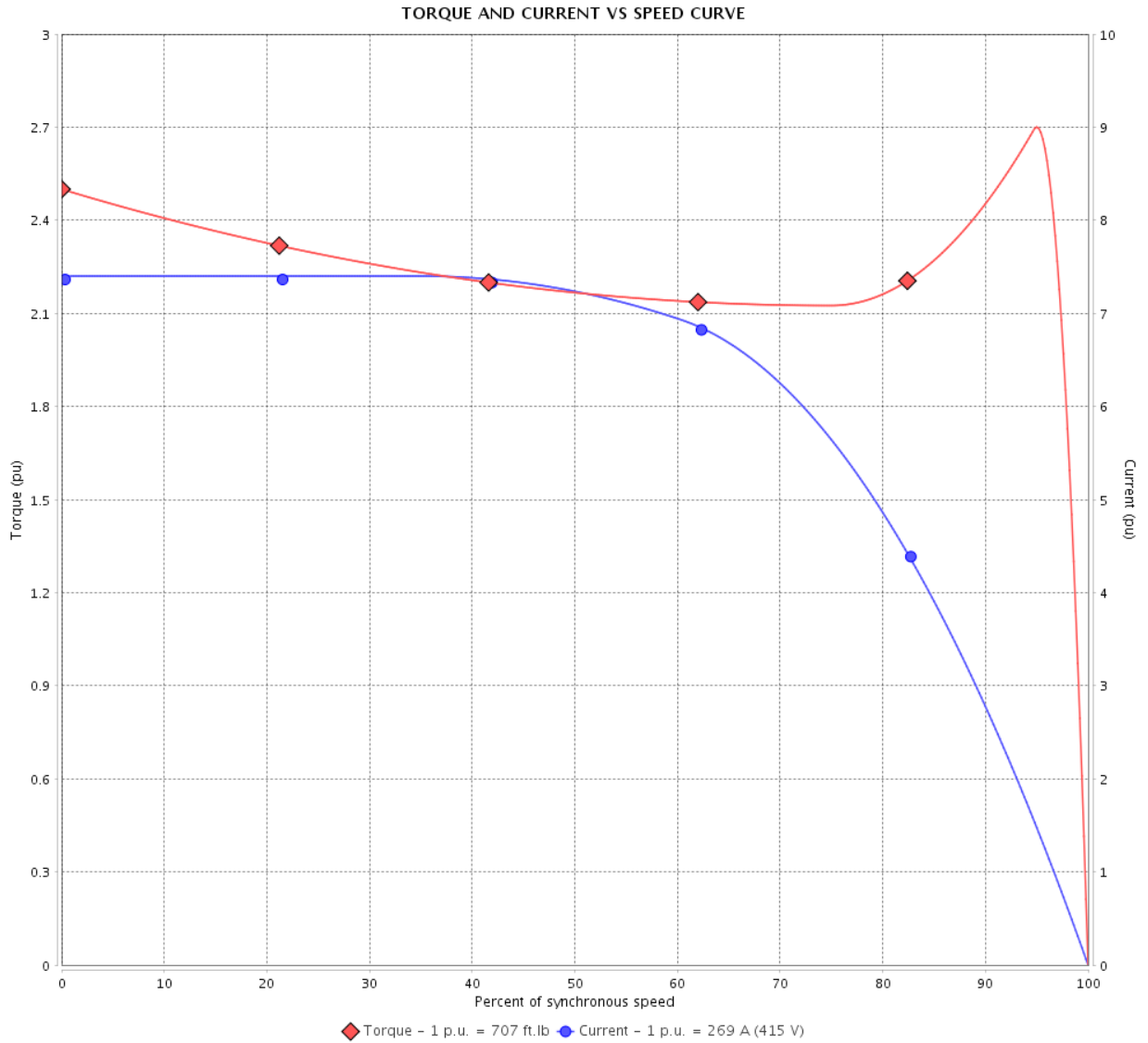

Performance : 415 V 50 Hz 4P IE3

|                     |             |                       |                 |
|---------------------|-------------|-----------------------|-----------------|
| Rated current       | : 269 A     | Moment of inertia (J) | : 50.9 sq.ft.lb |
| LRC                 | : 7.4       | Duty cycle            | : Cont.(S1)     |
| Rated torque        | : 707 ft.lb | Insulation class      | : F             |
| Locked rotor torque | : 250 %     | Service factor        | : 1.00          |
| Breakdown torque    | : 270 %     | Temperature rise      | : 80 K          |
| Rated speed         | : 1485 rpm  | Design                | : B             |

Locked rotor time : 14s (cold) 8s (hot)

| Rev.         | Changes Summary | Performed | Checked        | Date     |
|--------------|-----------------|-----------|----------------|----------|
|              |                 |           |                |          |
| Performed by |                 |           | Page<br>5 / 21 | Revision |
| Checked by   |                 |           |                |          |
| Date         | 13/04/2022      |           |                |          |

# LOAD PERFORMANCE CURVE

Three Phase Induction Motor - Squirrel Cage



Customer :

Product line : W40 NEMA Premium Efficiency  
Three-Phase

Product code : 14285042

Catalog # : 25018OT3G445TS-W40

LOAD PERFORMANCE CURVE

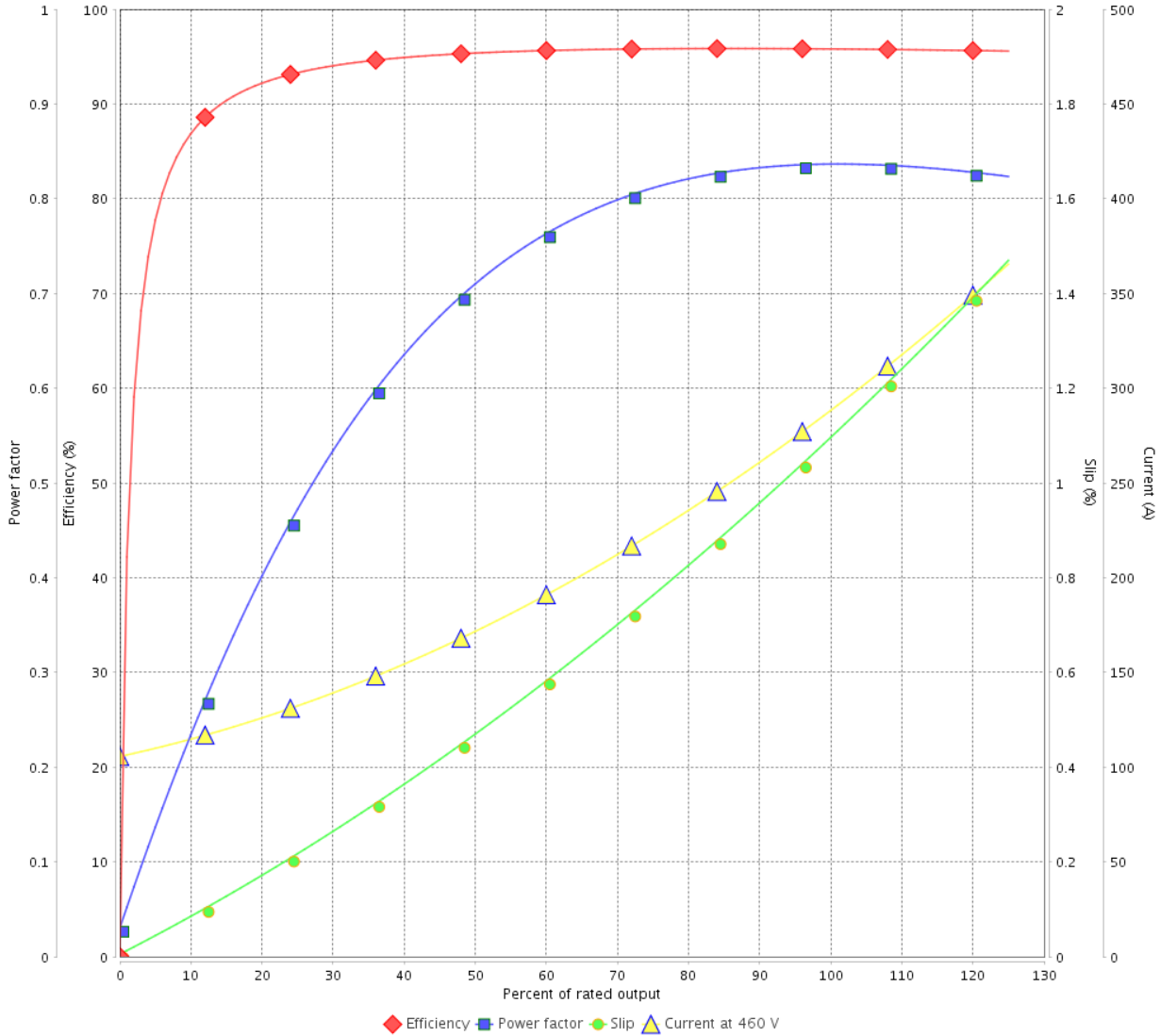

Performance : 460 V 60 Hz 4P

Rated current : 289 A  
LRC : 6.4  
Rated torque : 738 ft.lb  
Locked rotor torque : 210 %  
Breakdown torque : 240 %  
Rated speed : 1780 rpm

Moment of inertia (J) : 50.9 sq.ft.lb  
Duty cycle : Cont.(S1)  
Insulation class : F  
Service factor : 1.15  
Temperature rise : 80 K  
Design : B

| Rev.         | Changes Summary | Performed | Checked | Date     |
|--------------|-----------------|-----------|---------|----------|
|              |                 |           |         |          |
| Performed by |                 |           | Page    | Revision |
| Checked by   |                 |           |         |          |
| Date         |                 |           |         |          |

# LOAD PERFORMANCE CURVE

## Three Phase Induction Motor - Squirrel Cage



Customer :

Product line : W40 NEMA Premium Efficiency Three-Phase

Product code : 14285042

Catalog # : 25018OT3G445TS-W40

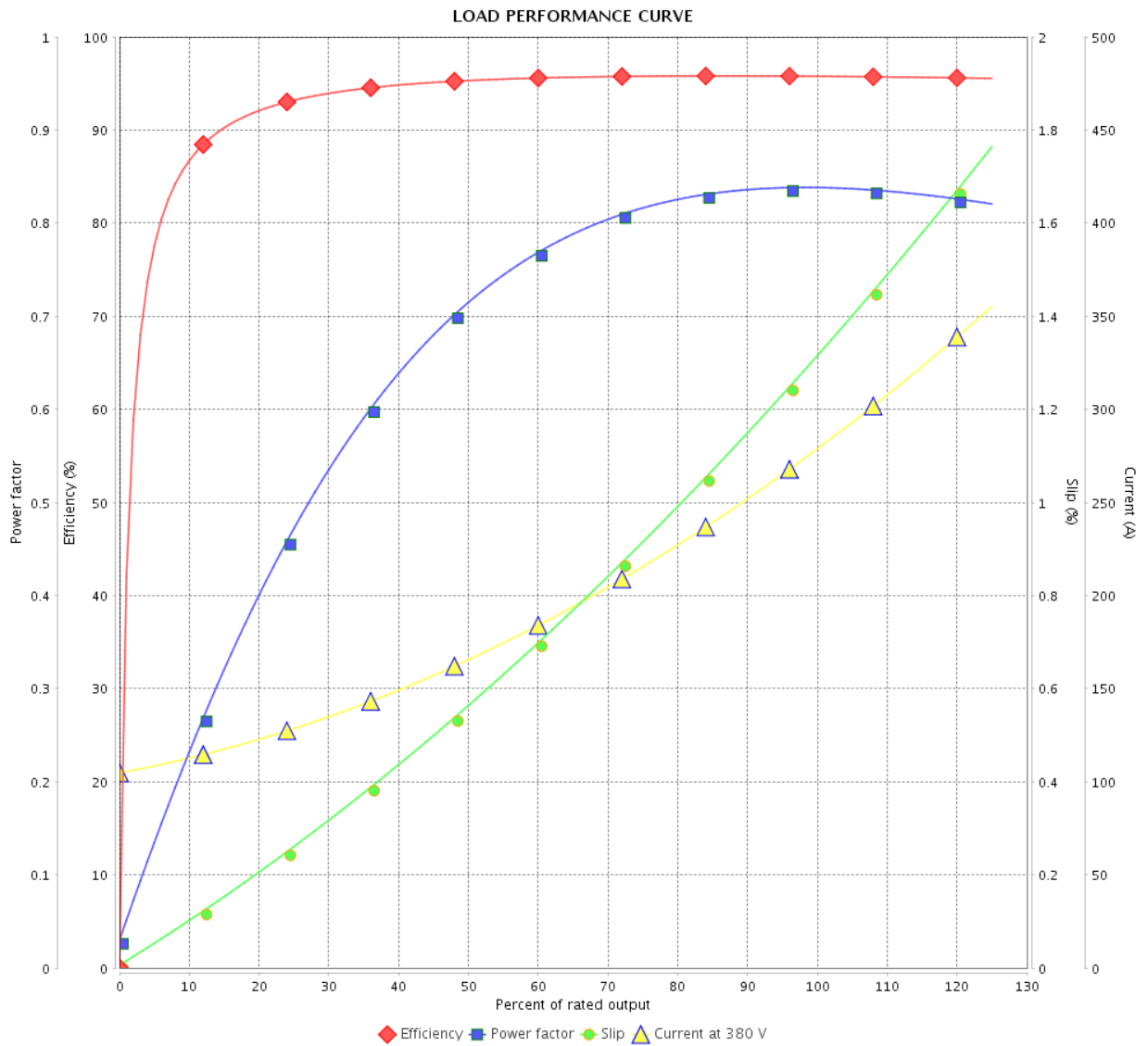

Performance : 380 V 50 Hz 4P IE3

Rated current : 283 A  
 LRC : 6.9  
 Rated torque : 710 ft.lb  
 Locked rotor torque : 200 %  
 Breakdown torque : 220 %  
 Rated speed : 1480 rpm

Moment of inertia (J) : 50.9 sq.ft.lb  
 Duty cycle : Cont.(S1)  
 Insulation class : F  
 Service factor : 1.00  
 Temperature rise : 80 K  
 Design : B

| Rev.         | Changes Summary | Performed | Checked | Date     |
|--------------|-----------------|-----------|---------|----------|
|              |                 |           |         |          |
| Performed by |                 |           |         |          |
| Checked by   |                 |           |         |          |
| Date         |                 |           |         |          |
|              |                 |           | Page    | Revision |
|              |                 |           | 7 / 21  |          |

# LOAD PERFORMANCE CURVE

Three Phase Induction Motor - Squirrel Cage



Customer :

Product line : W40 NEMA Premium Efficiency Three-Phase

Product code : 14285042

Catalog # : 25018OT3G445TS-W40

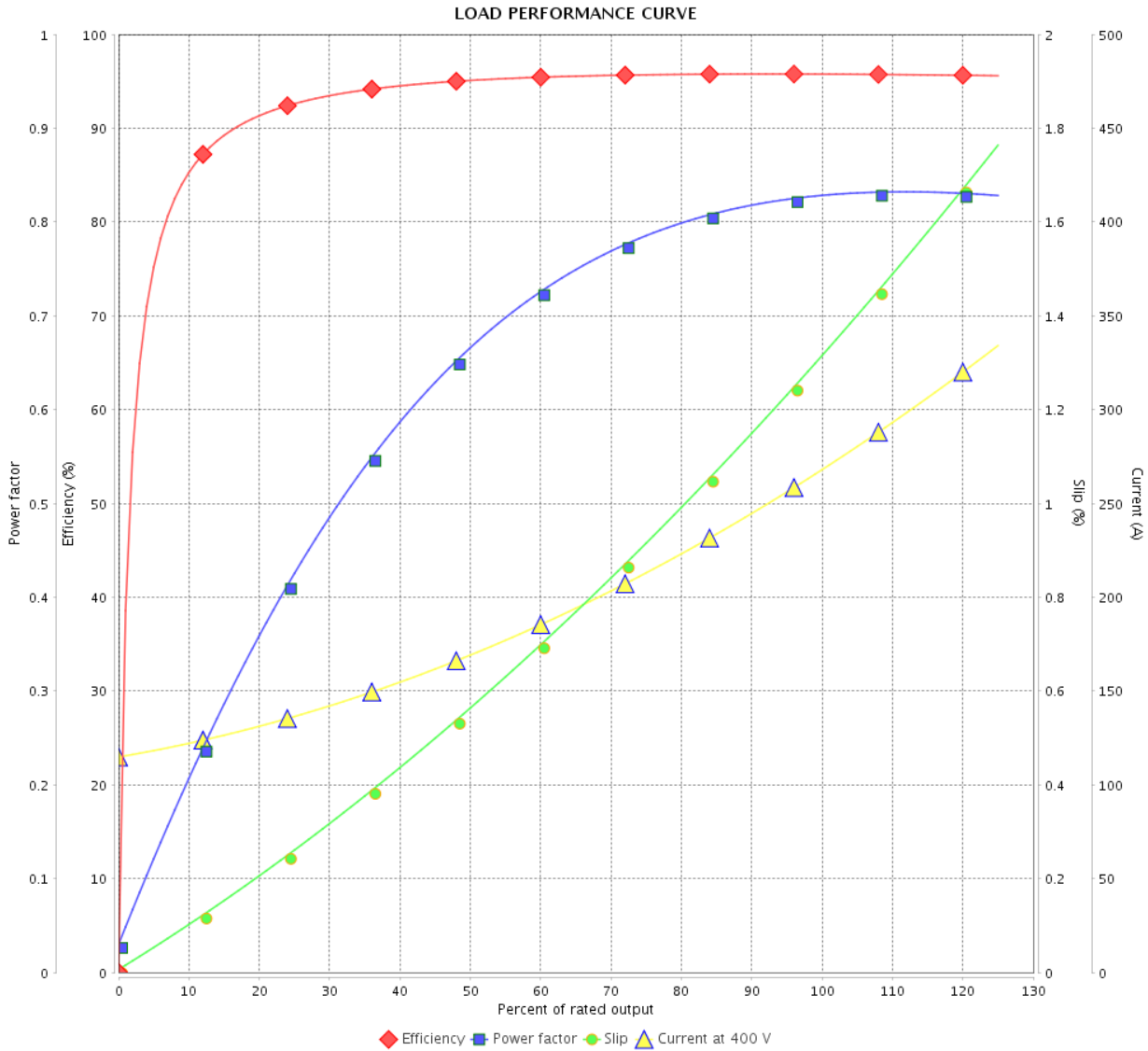

Performance : 400 V 50 Hz 4P IE3

Rated current : 272 A  
 LRC : 7.3  
 Rated torque : 710 ft.lb  
 Locked rotor torque : 229 %  
 Breakdown torque : 240 %  
 Rated speed : 1480 rpm

Moment of inertia (J) : 50.9 sq.ft.lb  
 Duty cycle : Cont.(S1)  
 Insulation class : F  
 Service factor : 1.00  
 Temperature rise : 80 K  
 Design : B

| Rev.         | Changes Summary | Performed | Checked        | Date     |
|--------------|-----------------|-----------|----------------|----------|
|              |                 |           |                |          |
| Performed by |                 |           | Page<br>8 / 21 | Revision |
| Checked by   |                 |           |                |          |
| Date         | 13/04/2022      |           |                |          |



# LOAD PERFORMANCE CURVE

## Three Phase Induction Motor - Squirrel Cage



Customer :

Product line : W40 NEMA Premium Efficiency  
Three-Phase

Product code : 14285042

Catalog # : 25018OT3G445TS-W40

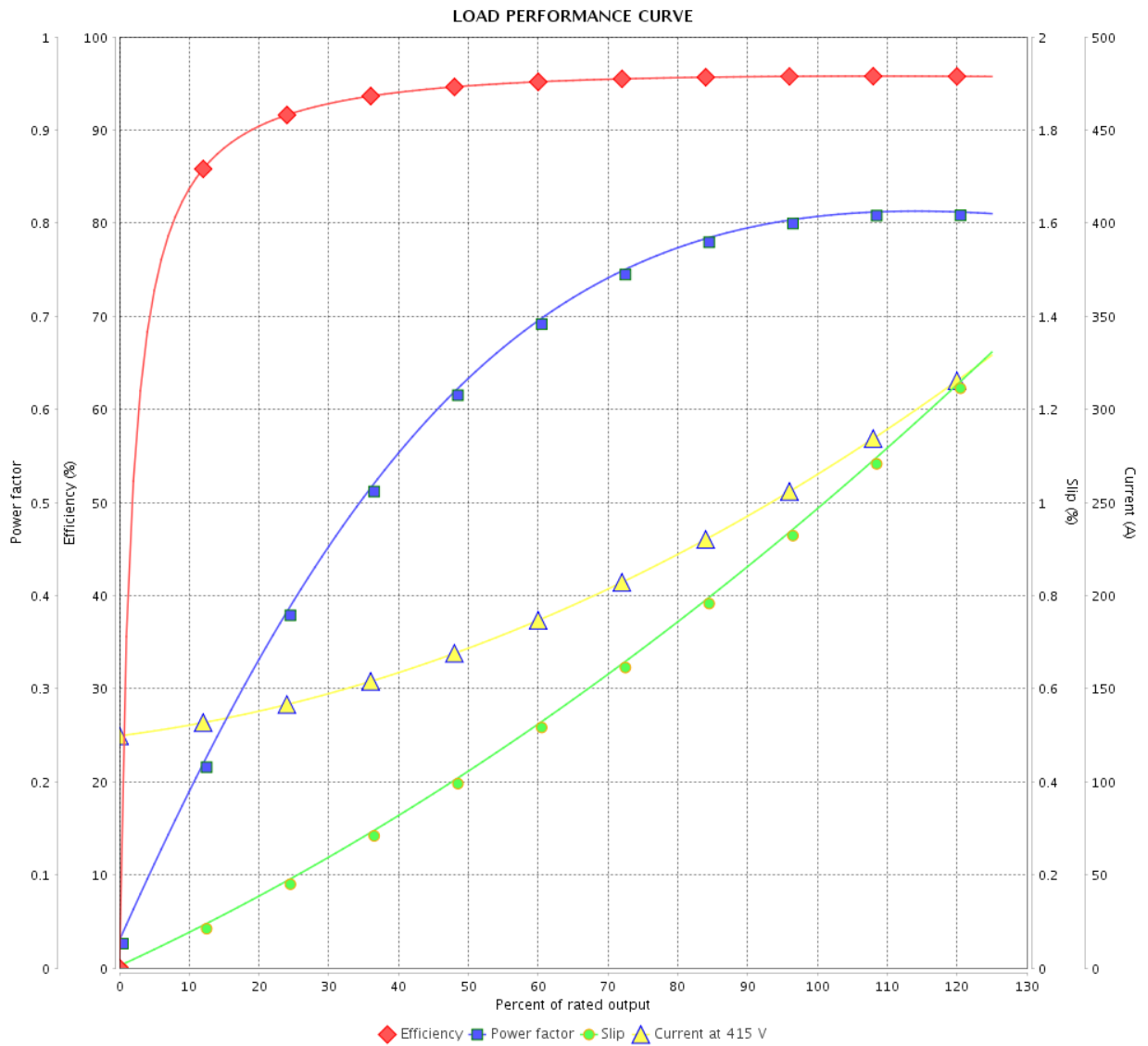

Performance : 415 V 50 Hz 4P IE3

Rated current : 269 A  
 LRC : 7.4  
 Rated torque : 707 ft.lb  
 Locked rotor torque : 250 %  
 Breakdown torque : 270 %  
 Rated speed : 1485 rpm

Moment of inertia (J) : 50.9 sq.ft.lb  
 Duty cycle : Cont.(S1)  
 Insulation class : F  
 Service factor : 1.00  
 Temperature rise : 80 K  
 Design : B

| Rev.         | Changes Summary | Performed | Checked | Date     |
|--------------|-----------------|-----------|---------|----------|
|              |                 |           |         |          |
| Performed by |                 |           | Page    | Revision |
| Checked by   |                 |           |         |          |
| Date         |                 |           |         |          |

# THERMAL LIMIT CURVE



## Three Phase Induction Motor - Squirrel Cage

Customer :

Product line : W40 NEMA Premium Efficiency  
Three-Phase

Product code : 14285042

Catalog # : 25018OT3G445TS-W40

Performance : 460 V 60 Hz 4P

|                     |             |                       |                 |
|---------------------|-------------|-----------------------|-----------------|
| Rated current       | : 289 A     | Moment of inertia (J) | : 50.9 sq.ft.lb |
| LRC                 | : 6.4       | Duty cycle            | : Cont.(S1)     |
| Rated torque        | : 738 ft.lb | Insulation class      | : F             |
| Locked rotor torque | : 210 %     | Service factor        | : 1.15          |
| Breakdown torque    | : 240 %     | Temperature rise      | : 80 K          |
| Rated speed         | : 1780 rpm  | Design                | : B             |

Heating constant

Cooling constant

| Rev.         | Changes Summary | Performed | Checked | Date     |
|--------------|-----------------|-----------|---------|----------|
|              |                 |           |         |          |
| Performed by |                 |           |         |          |
| Checked by   |                 |           | Page    | Revision |
| Date         | 13/04/2022      |           | 10 / 21 |          |

# THERMAL LIMIT CURVE

Three Phase Induction Motor - Squirrel Cage



Customer : \_\_\_\_\_

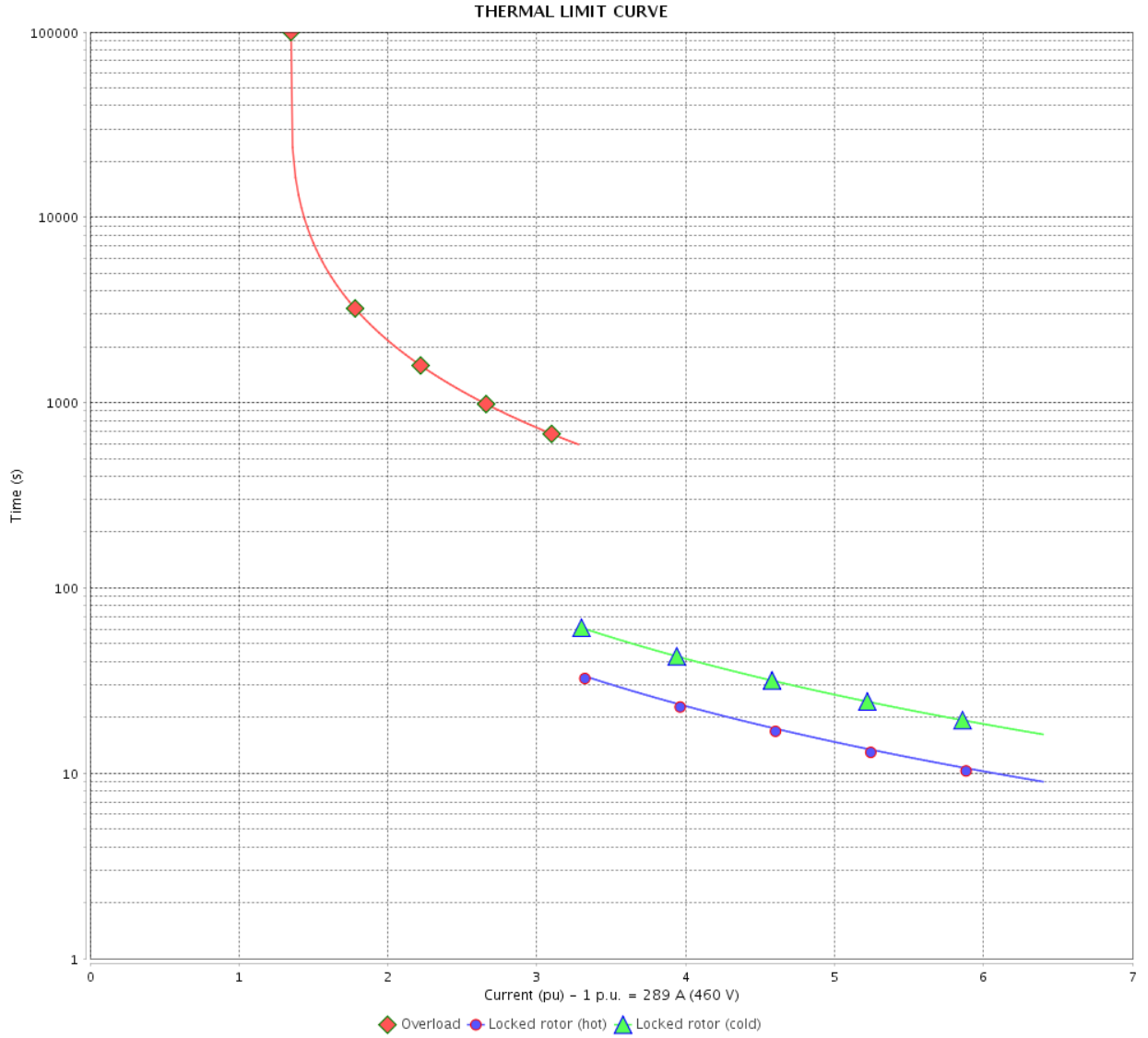

| Rev.         | Changes Summary | Performed | Checked | Date     |
|--------------|-----------------|-----------|---------|----------|
|              |                 |           |         |          |
| Performed by |                 |           |         |          |
| Checked by   |                 |           |         |          |
| Date         |                 |           |         |          |
|              |                 |           | Page    | Revision |
|              |                 |           | 11 / 21 |          |

# THERMAL LIMIT CURVE



## Three Phase Induction Motor - Squirrel Cage

Customer :

Product line : W40 NEMA Premium Efficiency  
Three-Phase

Product code : 14285042

Catalog # : 25018OT3G445TS-W40

Performance : 380 V 50 Hz 4P IE3

|                     |             |                       |                 |
|---------------------|-------------|-----------------------|-----------------|
| Rated current       | : 283 A     | Moment of inertia (J) | : 50.9 sq.ft.lb |
| LRC                 | : 6.9       | Duty cycle            | : Cont.(S1)     |
| Rated torque        | : 710 ft.lb | Insulation class      | : F             |
| Locked rotor torque | : 200 %     | Service factor        | : 1.00          |
| Breakdown torque    | : 220 %     | Temperature rise      | : 80 K          |
| Rated speed         | : 1480 rpm  | Design                | : B             |

Heating constant

Cooling constant

| Rev.         | Changes Summary | Performed | Checked | Date     |
|--------------|-----------------|-----------|---------|----------|
|              |                 |           |         |          |
| Performed by |                 |           |         |          |
| Checked by   |                 |           | Page    | Revision |
| Date         | 13/04/2022      |           | 12 / 21 |          |

# THERMAL LIMIT CURVE

Three Phase Induction Motor - Squirrel Cage



Customer : \_\_\_\_\_

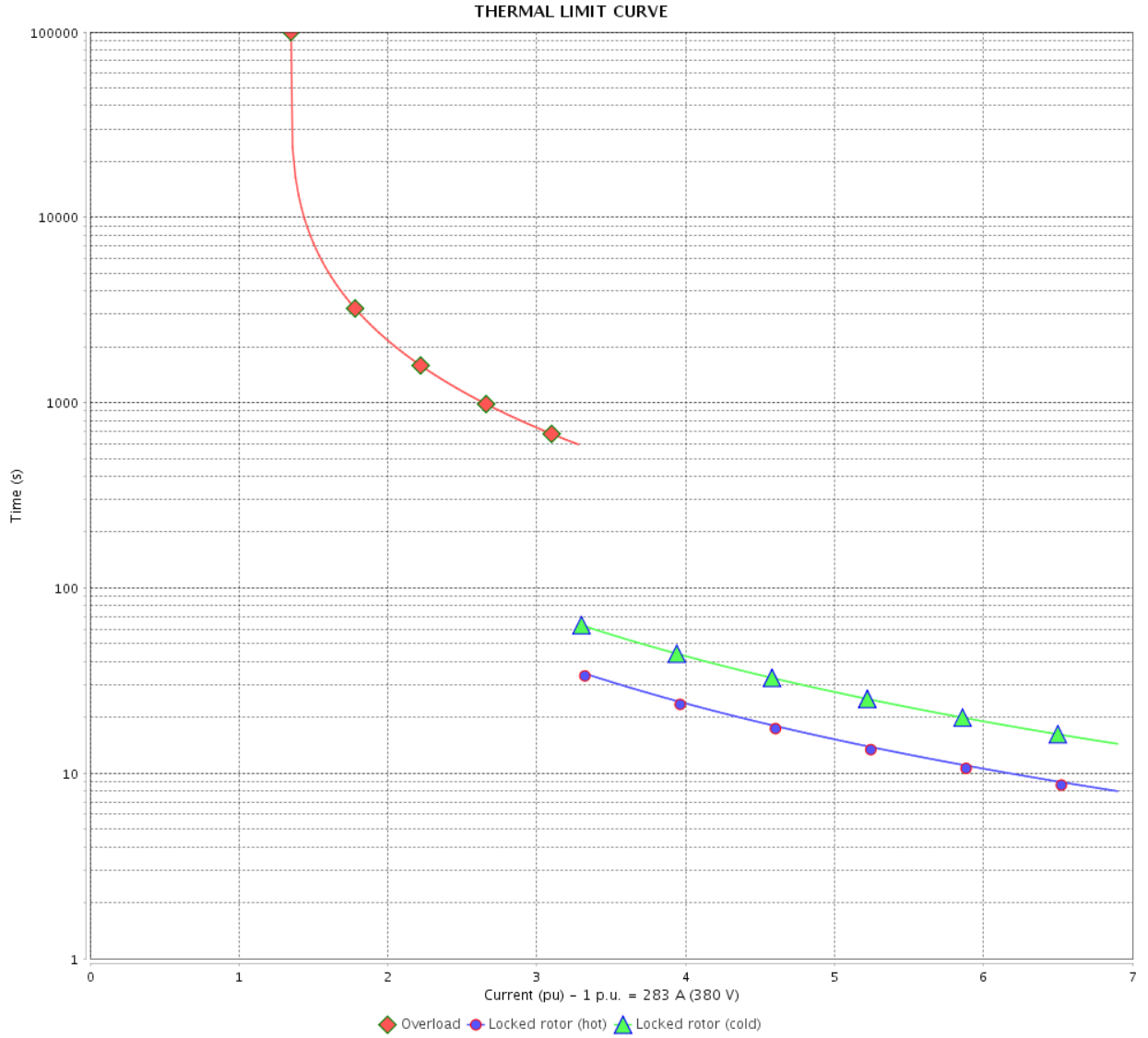

| Rev.         | Changes Summary | Performed  | Checked | Date     |
|--------------|-----------------|------------|---------|----------|
|              |                 |            |         |          |
| Performed by |                 | Page       |         | Revision |
| Checked by   |                 | 13 / 21    |         |          |
| Date         |                 | 13/04/2022 |         |          |

# THERMAL LIMIT CURVE



## Three Phase Induction Motor - Squirrel Cage

Customer :

Product line : W40 NEMA Premium Efficiency  
Three-Phase

Product code : 14285042

Catalog # : 25018OT3G445TS-W40

Performance : 400 V 50 Hz 4P IE3

|                     |             |                       |                 |
|---------------------|-------------|-----------------------|-----------------|
| Rated current       | : 272 A     | Moment of inertia (J) | : 50.9 sq.ft.lb |
| LRC                 | : 7.3       | Duty cycle            | : Cont.(S1)     |
| Rated torque        | : 710 ft.lb | Insulation class      | : F             |
| Locked rotor torque | : 229 %     | Service factor        | : 1.00          |
| Breakdown torque    | : 240 %     | Temperature rise      | : 80 K          |
| Rated speed         | : 1480 rpm  | Design                | : B             |

Heating constant

Cooling constant

| Rev.         | Changes Summary | Performed | Checked | Date     |
|--------------|-----------------|-----------|---------|----------|
|              |                 |           |         |          |
| Performed by |                 |           |         |          |
| Checked by   |                 |           | Page    | Revision |
| Date         | 13/04/2022      |           | 14 / 21 |          |

# THERMAL LIMIT CURVE

Three Phase Induction Motor - Squirrel Cage



Customer : \_\_\_\_\_

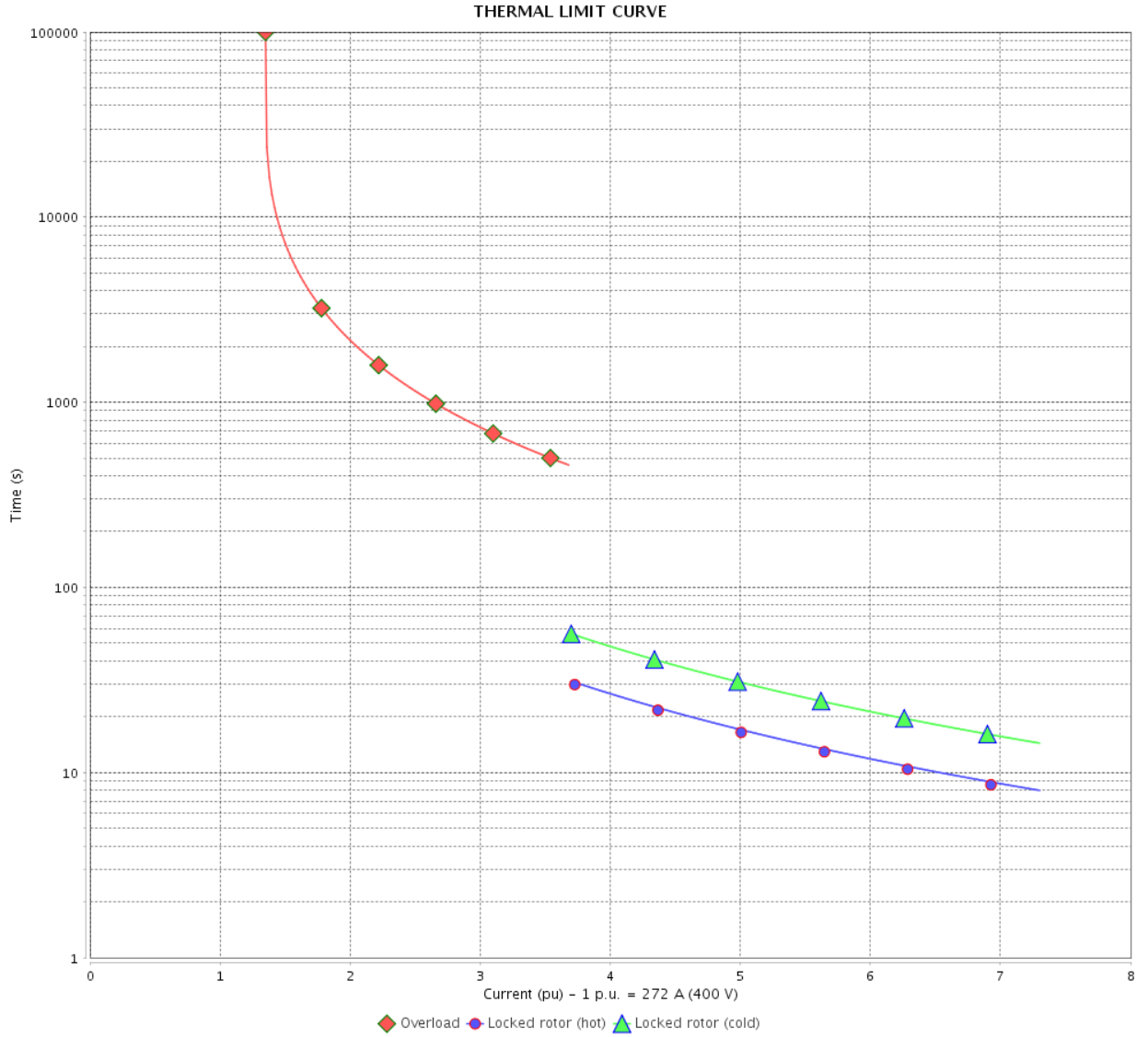

| Rev.         | Changes Summary | Performed  | Checked | Date     |
|--------------|-----------------|------------|---------|----------|
|              |                 |            |         |          |
| Performed by |                 | Page       |         | Revision |
| Checked by   |                 | 15 / 21    |         |          |
| Date         |                 | 13/04/2022 |         |          |

# THERMAL LIMIT CURVE



## Three Phase Induction Motor - Squirrel Cage

Customer :

Product line : W40 NEMA Premium Efficiency  
Three-Phase

Product code : 14285042

Catalog # : 25018OT3G445TS-W40

Performance : 415 V 50 Hz 4P IE3

|                     |             |                       |                 |
|---------------------|-------------|-----------------------|-----------------|
| Rated current       | : 269 A     | Moment of inertia (J) | : 50.9 sq.ft.lb |
| LRC                 | : 7.4       | Duty cycle            | : Cont.(S1)     |
| Rated torque        | : 707 ft.lb | Insulation class      | : F             |
| Locked rotor torque | : 250 %     | Service factor        | : 1.00          |
| Breakdown torque    | : 270 %     | Temperature rise      | : 80 K          |
| Rated speed         | : 1485 rpm  | Design                | : B             |

Heating constant

Cooling constant

| Rev.         | Changes Summary | Performed | Checked | Date     |
|--------------|-----------------|-----------|---------|----------|
| Performed by |                 |           |         |          |
| Checked by   |                 |           | Page    | Revision |
| Date         | 13/04/2022      |           | 16 / 21 |          |



# THERMAL LIMIT CURVE

Three Phase Induction Motor - Squirrel Cage



Customer : \_\_\_\_\_

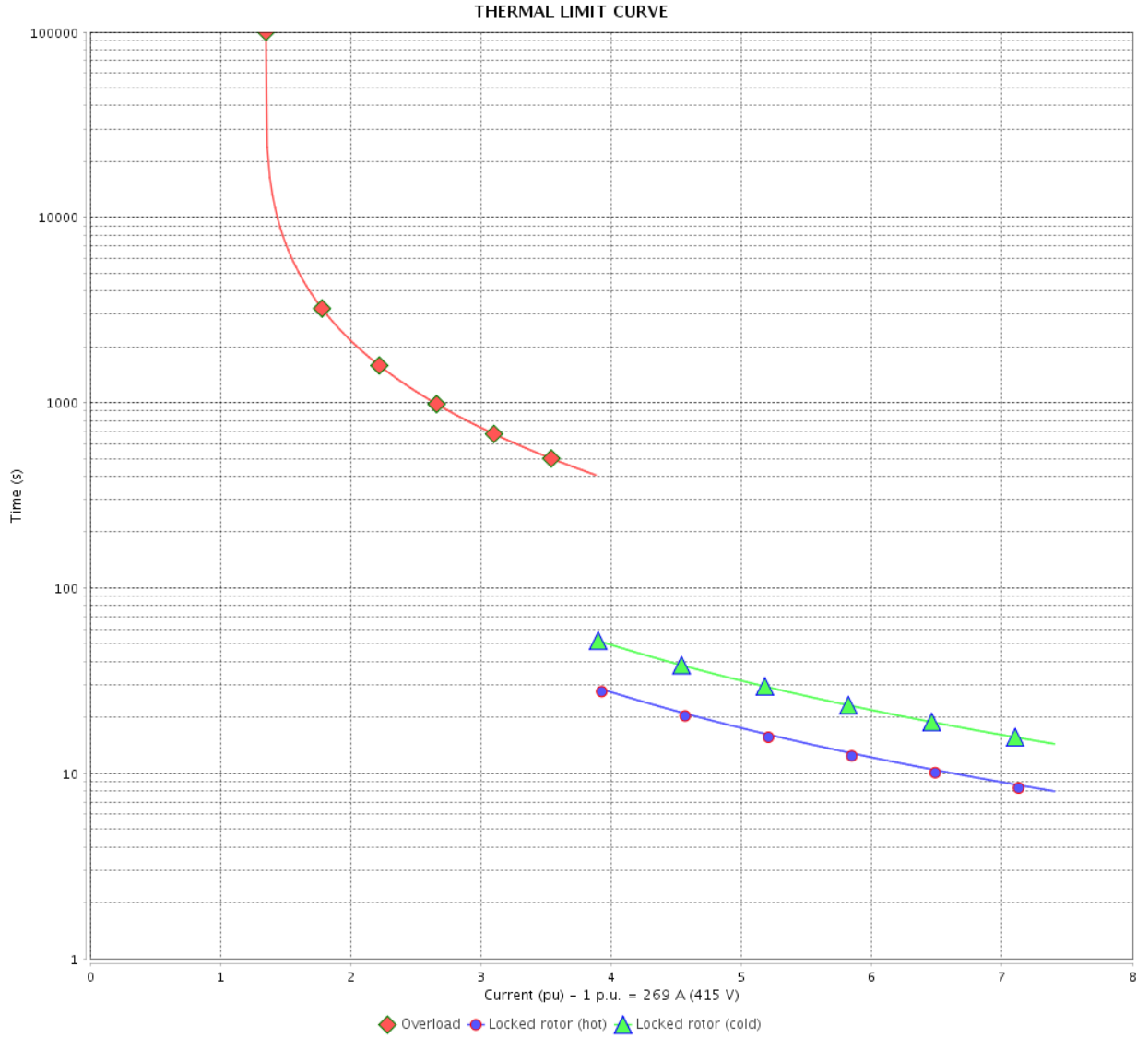

| Rev.         | Changes Summary | Performed       | Checked | Date     |
|--------------|-----------------|-----------------|---------|----------|
|              |                 |                 |         |          |
| Performed by |                 | Page<br>17 / 21 |         | Revision |
| Checked by   |                 |                 |         |          |
| Date         |                 |                 |         |          |

# VFD OPERATION CURVE

Three Phase Induction Motor - Squirrel Cage



Customer :

Product line : W40 NEMA Premium Efficiency Three-Phase

Product code : 14285042

Catalog # : 25018OT3G445TS-W40

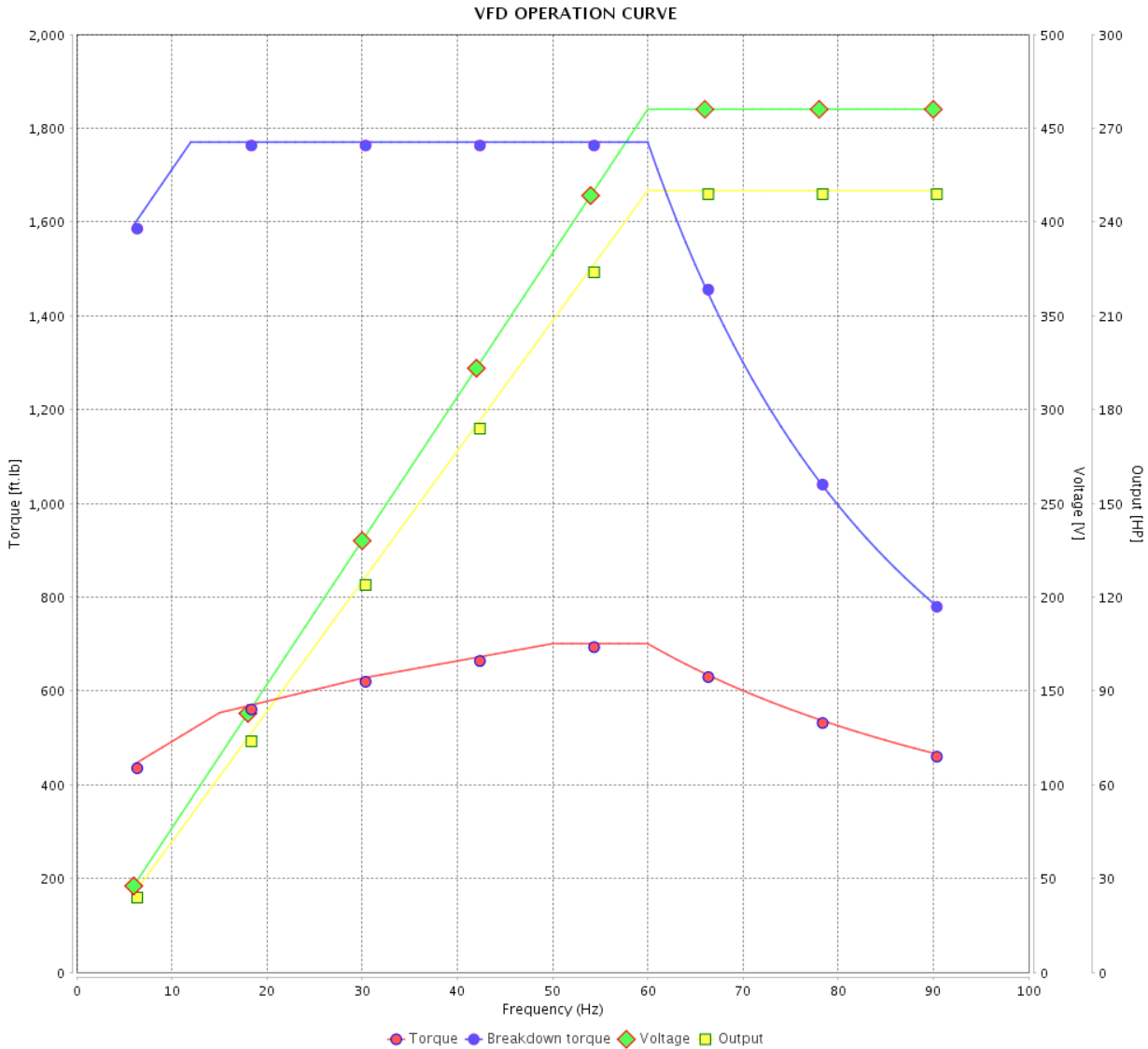

Performance : 460 V 60 Hz 4P

|                     |             |                       |                 |
|---------------------|-------------|-----------------------|-----------------|
| Rated current       | : 289 A     | Moment of inertia (J) | : 50.9 sq.ft.lb |
| LRC                 | : 6.4       | Duty cycle            | : Cont.(S1)     |
| Rated torque        | : 738 ft.lb | Insulation class      | : F             |
| Locked rotor torque | : 210 %     | Service factor        | : 1.15          |
| Breakdown torque    | : 240 %     | Temperature rise      | : 80 K          |
| Rated speed         | : 1780 rpm  | Design                | : B             |

| Rev.         | Changes Summary | Performed | Checked         | Date     |
|--------------|-----------------|-----------|-----------------|----------|
|              |                 |           |                 |          |
| Performed by |                 |           | Page<br>18 / 21 | Revision |
| Checked by   |                 |           |                 |          |
| Date         | 13/04/2022      |           |                 |          |

# VFD OPERATION CURVE

Three Phase Induction Motor - Squirrel Cage



Customer :

Product line : W40 NEMA Premium Efficiency  
Three-Phase

Product code : 14285042

Catalog # : 25018OT3G445TS-W40

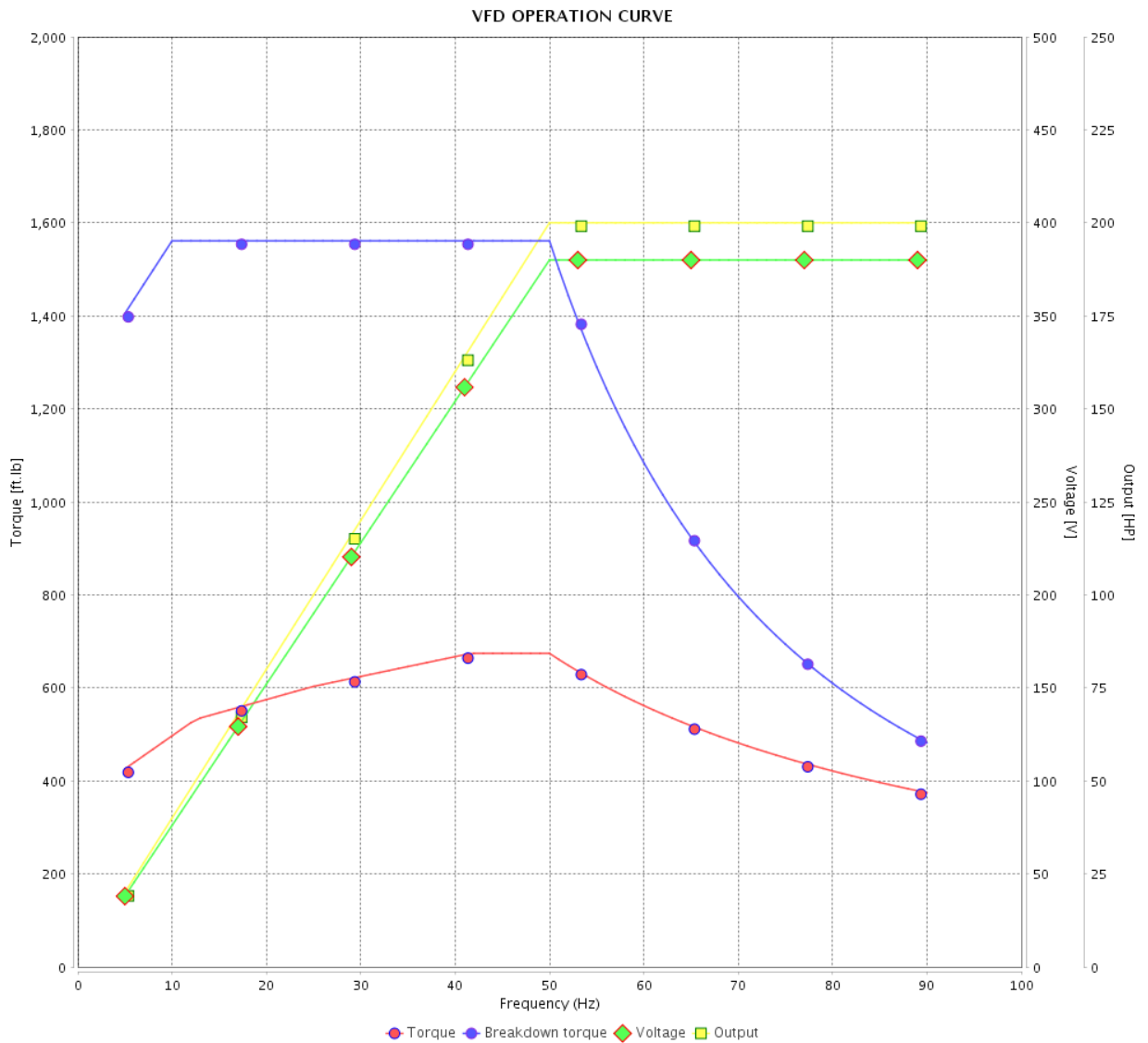

Performance : 380 V 50 Hz 4P IE3

Rated current : 283 A  
LRC : 6.9  
Rated torque : 710 ft.lb  
Locked rotor torque : 200 %  
Breakdown torque : 220 %  
Rated speed : 1480 rpm

Moment of inertia (J) : 50.9 sq.ft.lb  
Duty cycle : Cont.(S1)  
Insulation class : F  
Service factor : 1.00  
Temperature rise : 80 K  
Design : B

| Rev.         | Changes Summary | Performed | Checked | Date            |
|--------------|-----------------|-----------|---------|-----------------|
|              |                 |           |         |                 |
| Performed by |                 |           |         | Page<br>19 / 21 |
| Checked by   |                 |           |         |                 |
| Date         | 13/04/2022      |           |         |                 |

# VFD OPERATION CURVE

Three Phase Induction Motor - Squirrel Cage



Customer :

Product line : W40 NEMA Premium Efficiency  
Three-Phase

Product code : 14285042

Catalog # : 25018OT3G445TS-W40

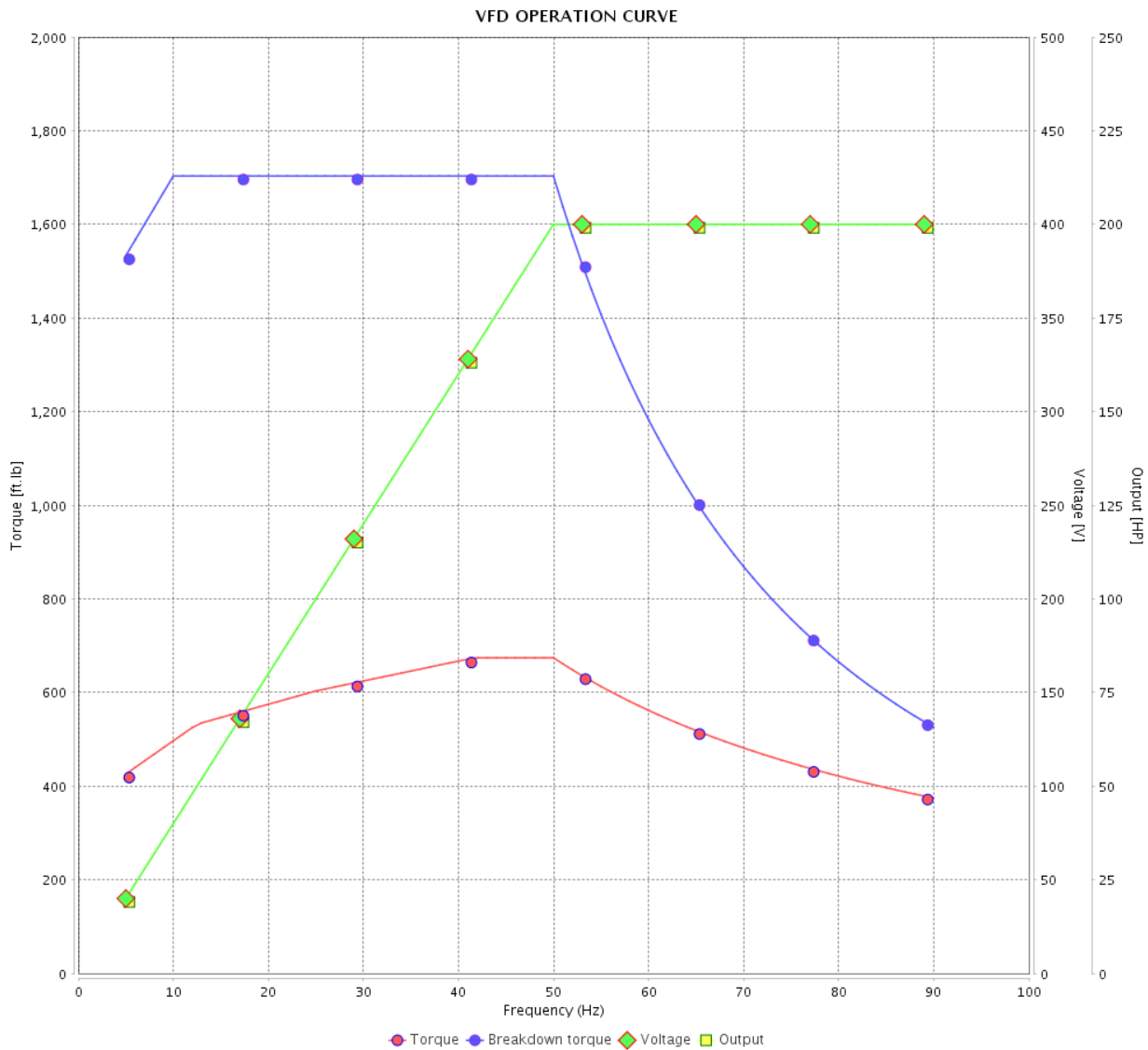

Performance : 400 V 50 Hz 4P IE3

|                     |             |                       |                 |
|---------------------|-------------|-----------------------|-----------------|
| Rated current       | : 272 A     | Moment of inertia (J) | : 50.9 sq.ft.lb |
| LRC                 | : 7.3       | Duty cycle            | : Cont.(S1)     |
| Rated torque        | : 710 ft.lb | Insulation class      | : F             |
| Locked rotor torque | : 229 %     | Service factor        | : 1.00          |
| Breakdown torque    | : 240 %     | Temperature rise      | : 80 K          |
| Rated speed         | : 1480 rpm  | Design                | : B             |

| Rev.         | Changes Summary | Performed | Checked         | Date     |
|--------------|-----------------|-----------|-----------------|----------|
|              |                 |           |                 |          |
| Performed by |                 |           | Page<br>20 / 21 | Revision |
| Checked by   |                 |           |                 |          |
| Date         | 13/04/2022      |           |                 |          |

# VFD OPERATION CURVE

Three Phase Induction Motor - Squirrel Cage



Customer :

Product line : W40 NEMA Premium Efficiency  
Three-Phase

Product code : 14285042

Catalog # : 25018OT3G445TS-W40

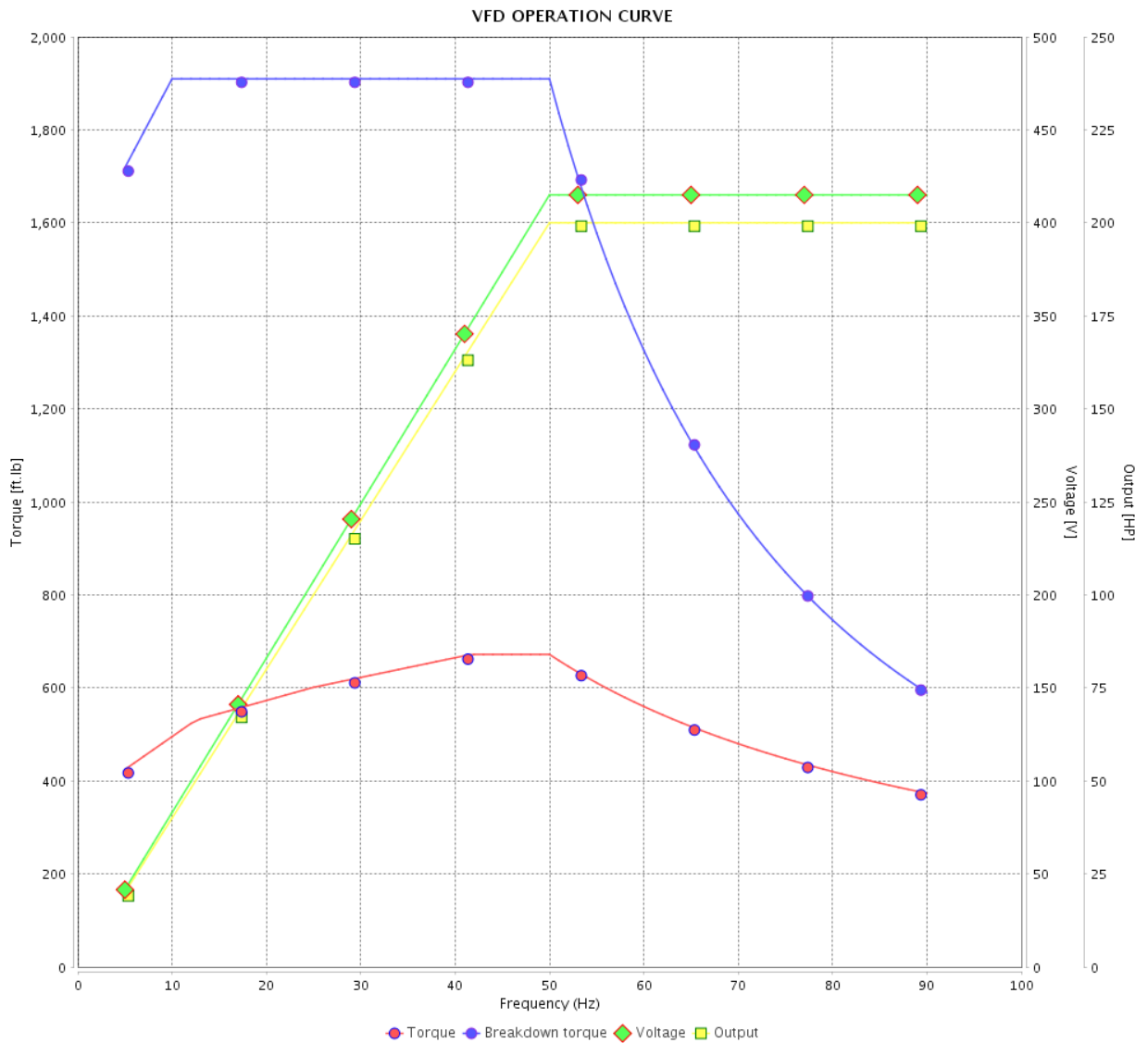

Performance : 415 V 50 Hz 4P IE3

Rated current : 269 A  
LRC : 7.4  
Rated torque : 707 ft.lb  
Locked rotor torque : 250 %  
Breakdown torque : 270 %  
Rated speed : 1485 rpm

Moment of inertia (J) : 50.9 sq.ft.lb  
Duty cycle : Cont.(S1)  
Insulation class : F  
Service factor : 1.00  
Temperature rise : 80 K  
Design : B

| Rev.         | Changes Summary | Performed | Checked | Date     |
|--------------|-----------------|-----------|---------|----------|
|              |                 |           |         |          |
| Performed by |                 |           | Page    | Revision |
| Checked by   |                 |           |         |          |
| Date         |                 |           |         |          |

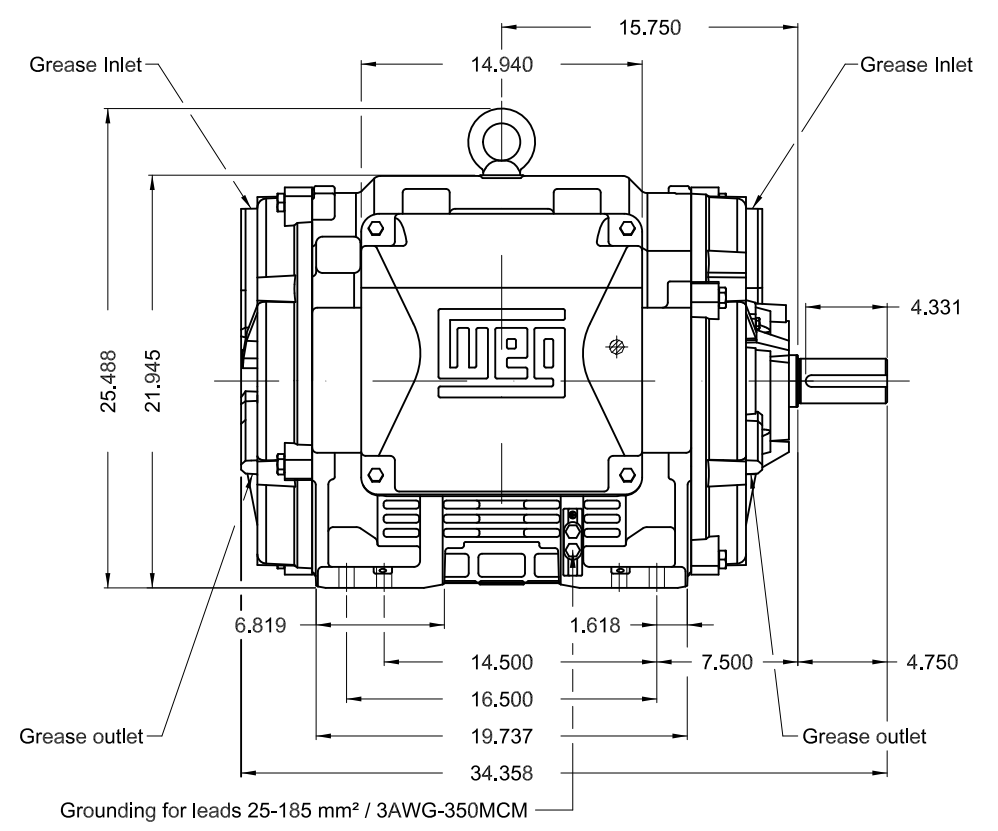
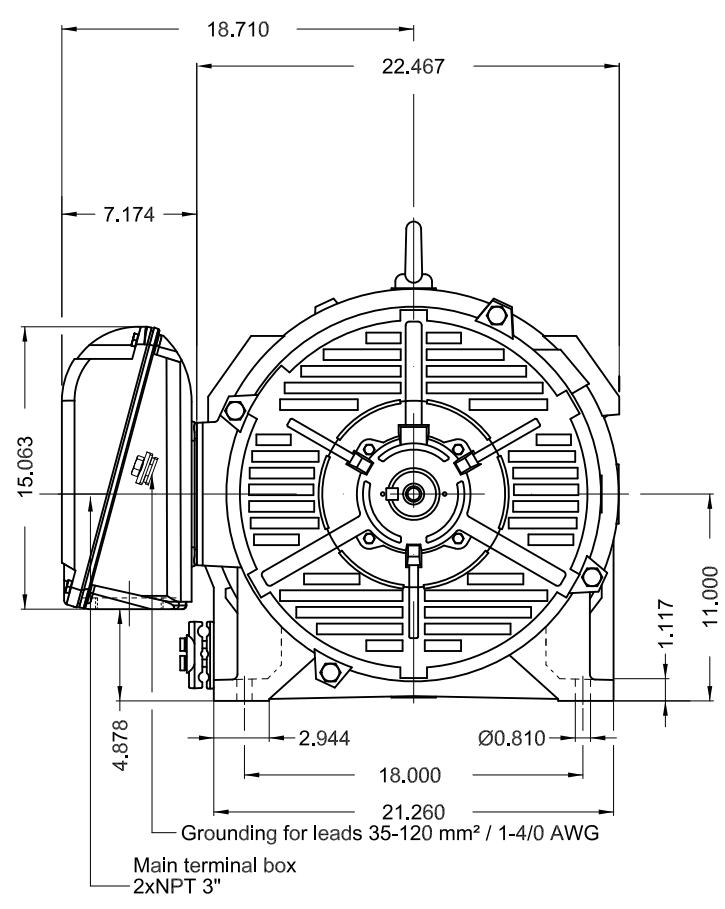

TS shaft end  
 Color RAL 5009  
 Painting plan 203A  
 Mounting NEMA F-1  
 Mounting B3R(D)

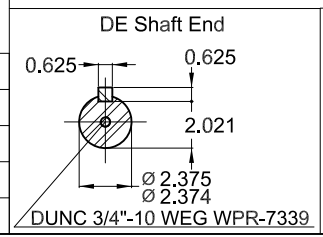

250 HP 04 Poles 60 Hz A

1:10

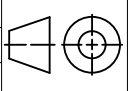
| ECM      | LOC      | SUMMARY OF MODIFICATIONS   | EXECUTED            | CHECKED | RELEASED | DATE | VER |
|----------|----------|--|---------------------|---------|----------|------|-----|
| EXECUTED | PIRWUSER |  THREE PH. MOTOR W40 PREM. EFF.<br>FRAME 444/5TS IP23 ODP |                     |         |          |      |     |
| CHECKED  |          |  |                     |         |          |      |     |
| RELEASED |          |  |                     |         |          |      |     |
| REL DT.  | WMO      | Jaragua do Sul   | Product Engineering | SHEET   | 1 / 1    |      |     |

**PREVIEW**  
 WDD

