

DATA SHEET

Three Phase Induction Motor - Squirrel Cage



Customer								
Product line	: NEMA Premium Efficiency Three-Phase	Product code	: 11432097					
		Catalog #	: 25018ST3QIE449T-W22					
Frame	: 447/9T	Cooling method	: IC411 - TEFC					
Insulation class	: F	Mounting	: F-1					
Duty cycle	: Cont.(S1)	Rotation ¹	: Both (CW and CCW)					
Ambient temperature	: -20°C to +40°C	Starting method	: Direct On Line					
Altitude	: 1000 m.a.s.l.	Approx. weight ²	: 2842 lb					
Protection degree	: IP55	Moment of inertia (J)	: 89.6 sq.ft.lb					
Design	: B							
Output [HP]	250	200	200	200	250	250	250	
Poles	4	4	4	4	4	4	4	
Frequency [Hz]	60	50	50	50	50	50	50	
Rated voltage [V]	460	380	400	415	380	400	415	
Rated current [A]	281	273	263	256	342	323	314	
L. R. Amperes [A]	1827	1665	1788	1894	1744	1841	1915	
LRC [A]	6.5x(Code G)	6.1x(Code F)	6.8x(Code G)	7.4x(Code H)	5.1x(Code E)	5.7x(Code F)	6.1x(Code F)	
No load current [A]	85.0	85.0	90.0	95.0	85.0	90.0	95.0	
Rated speed [RPM]	1780	1480	1485	1485	1475	1475	1480	
Slip [%]	1.11	1.33	1.00	1.00	1.67	1.67	1.33	
Rated torque [ft.lb]	738	710	707	707	890	890	887	
Locked rotor torque [%]	229	200	260	290	180	200	220	
Breakdown torque [%]	229	229	260	290	210	210	229	
Service factor	1.15	1.15	1.15	1.15	1.00	1.00	1.00	
Temperature rise	80 K	80 K	80 K	80 K	105 K	105 K	105 K	
Locked rotor time	27s (cold) 15s (hot)	36s (cold) 20s (hot)	32s (cold) 18s (hot)	28s (cold) 16s (hot)	18s (cold) 10s (hot)	18s (cold) 10s (hot)	18s (cold) 10s (hot)	
Noise level ²	75.0 dB(A)	71.0 dB(A)	71.0 dB(A)	71.0 dB(A)	71.0 dB(A)	71.0 dB(A)	71.0 dB(A)	
Efficiency (%)	25%	95.7	94.8	95.0	95.0	93.9	94.8	95.6
	50%	95.8	95.0	95.1	95.1	94.1	94.9	95.4
	75%	96.2	95.8	95.8	95.8	94.5	95.0	95.8
	100%	96.2	95.8	95.8	95.8	94.5	95.0	95.4
Power Factor	25%	0.51	0.52	0.49	0.46	0.58	0.54	0.51
	50%	0.75	0.77	0.74	0.72	0.80	0.77	0.75
	75%	0.83	0.84	0.83	0.81	0.86	0.84	0.83
	100%	0.86	0.87	0.86	0.85	0.87	0.87	0.86
Bearing type	: Drive end : 6322 C3	Non drive end : 6319 C3	Foundation loads					
Sealing	: Inpro/Seal	Inpro/Seal	Max. traction : 4018 lb					
Lubrication interval	: 6000 h	8000 h	Max. compression : 6860 lb					
Lubricant amount	: 60 g	45 g						
Lubricant type	: Mobil Polyrex EM							
Notes								
This revision replaces and cancel the previous one, which must be eliminated. (1) Looking the motor from the shaft end. (2) Measured at 1m and with tolerance of +3dB(A). (3) Approximate weight subject to changes after manufacturing process. (4) At 100% of full load.				These are average values based on tests with sinusoidal power supply, subject to the tolerances stipulated in NEMA MG-1.				
Rev.	Changes Summary			Performed	Checked	Date		
Performed by								
Checked by					Page	Revision		
Date	13/04/2022				1 / 36			

TORQUE AND CURRENT VS SPEED CURVE

Three Phase Induction Motor - Squirrel Cage



Customer :

Product line : NEMA Premium Efficiency Three-Phase

Product code : 11432097

Catalog # : 25018ST3QIE449T-W22

TORQUE AND CURRENT VS SPEED CURVE

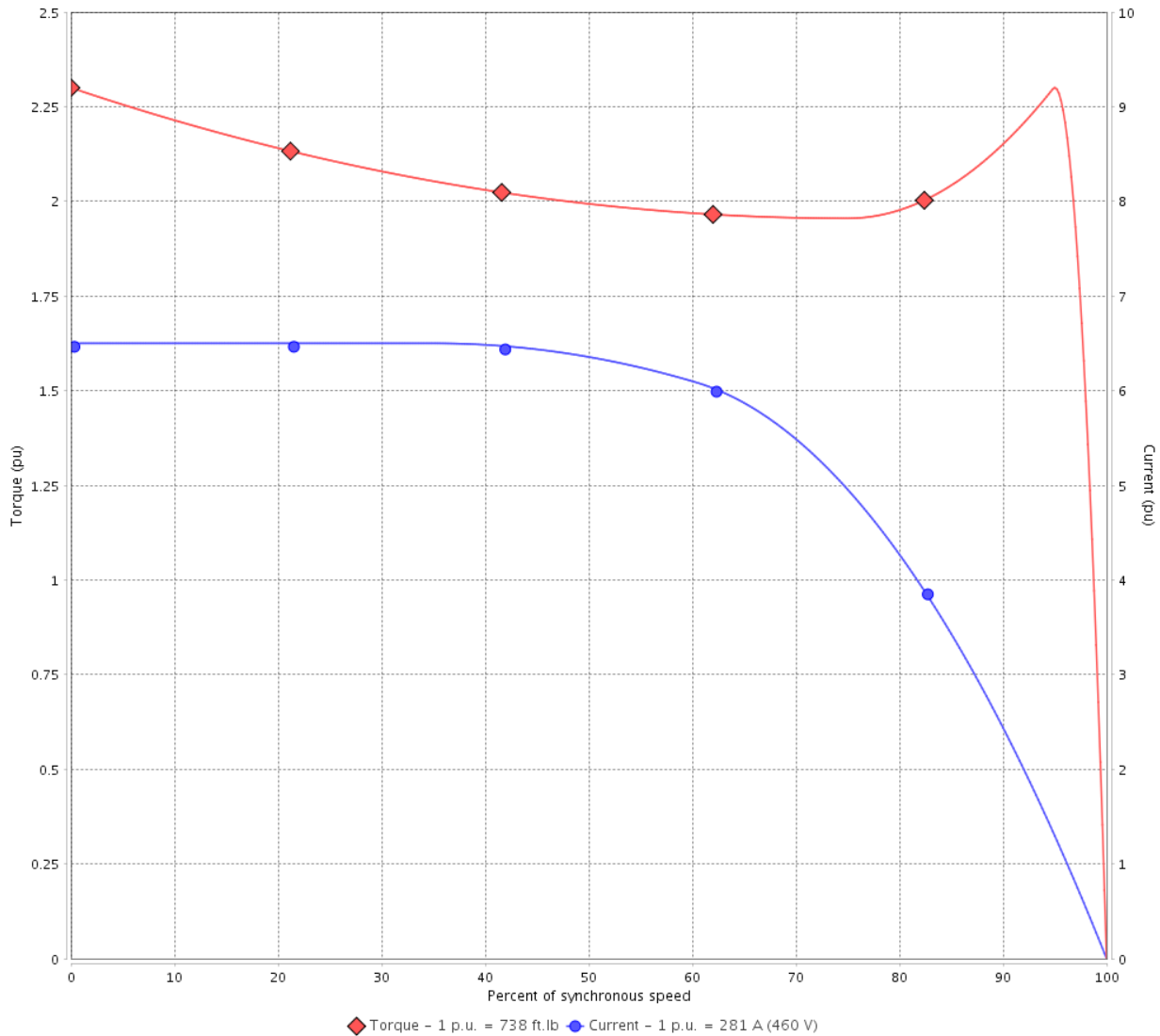

Performance : 460 V 60 Hz 4P

Rated current	: 281 A	Moment of inertia (J)	: 89.6 sq.ft.lb
LRC	: 6.5	Duty cycle	: Cont.(S1)
Rated torque	: 738 ft.lb	Insulation class	: F
Locked rotor torque	: 229 %	Service factor	: 1.15
Breakdown torque	: 229 %	Temperature rise	: 80 K
Rated speed	: 1780 rpm	Design	: B

Locked rotor time : 27s (cold) 15s (hot)

Rev.	Changes Summary	Performed	Checked	Date
Performed by			Page 2 / 36	Revision
Checked by				
Date	13/04/2022			

TORQUE AND CURRENT VS SPEED CURVE



Three Phase Induction Motor - Squirrel Cage

Customer :

Product line : NEMA Premium Efficiency Three-Phase

Product code : 11432097

Catalog # : 25018ST3QIE449T-W22

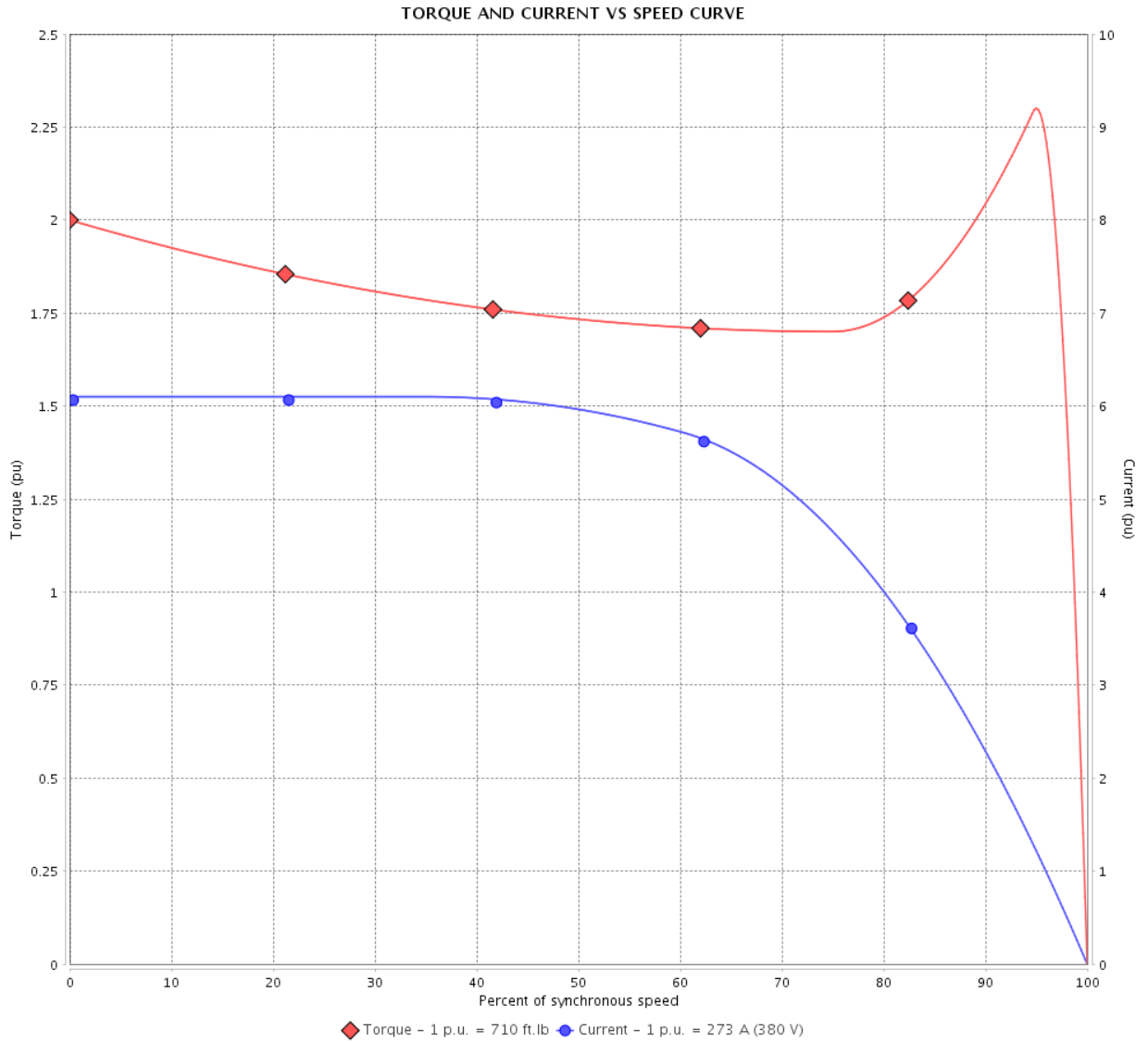

Performance : 380 V 50 Hz 4P IE3

Rated current	: 273 A	Moment of inertia (J)	: 89.6 sq.ft.lb
LRC	: 6.1	Duty cycle	: Cont.(S1)
Rated torque	: 710 ft.lb	Insulation class	: F
Locked rotor torque	: 200 %	Service factor	: 1.15
Breakdown torque	: 229 %	Temperature rise	: 80 K
Rated speed	: 1480 rpm	Design	: B

Locked rotor time : 36s (cold) 20s (hot)

Rev.	Changes Summary	Performed	Checked	Date
Performed by			Page 3 / 36	Revision
Checked by				
Date	13/04/2022			

TORQUE AND CURRENT VS SPEED CURVE

Three Phase Induction Motor - Squirrel Cage



Customer :

Product line : NEMA Premium Efficiency Three-Phase

Product code : 11432097

Catalog # : 25018ST3QIE449T-W22

TORQUE AND CURRENT VS SPEED CURVE

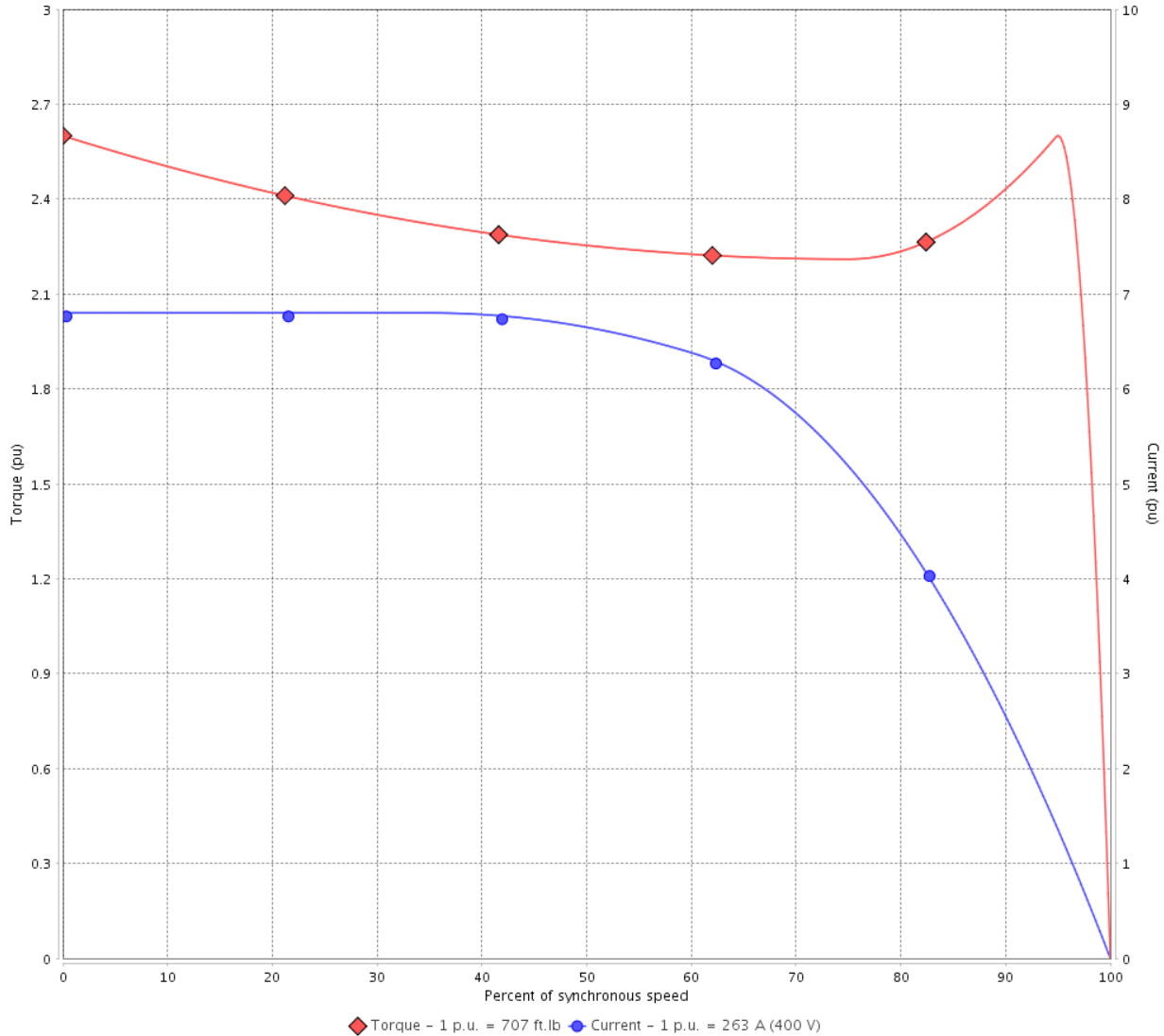

Performance : 400 V 50 Hz 4P IE3

Rated current	: 263 A	Moment of inertia (J)	: 89.6 sq.ft.lb
LRC	: 6.8	Duty cycle	: Cont.(S1)
Rated torque	: 707 ft.lb	Insulation class	: F
Locked rotor torque	: 260 %	Service factor	: 1.15
Breakdown torque	: 260 %	Temperature rise	: 80 K
Rated speed	: 1485 rpm	Design	: B

Locked rotor time : 32s (cold) 18s (hot)

Rev.	Changes Summary	Performed	Checked	Date
Performed by			Page 4 / 36	Revision
Checked by				
Date	13/04/2022			

TORQUE AND CURRENT VS SPEED CURVE



Three Phase Induction Motor - Squirrel Cage

Customer :

Product line : NEMA Premium Efficiency Three-Phase

Product code : 11432097

Catalog # : 25018ST3QIE449T-W22

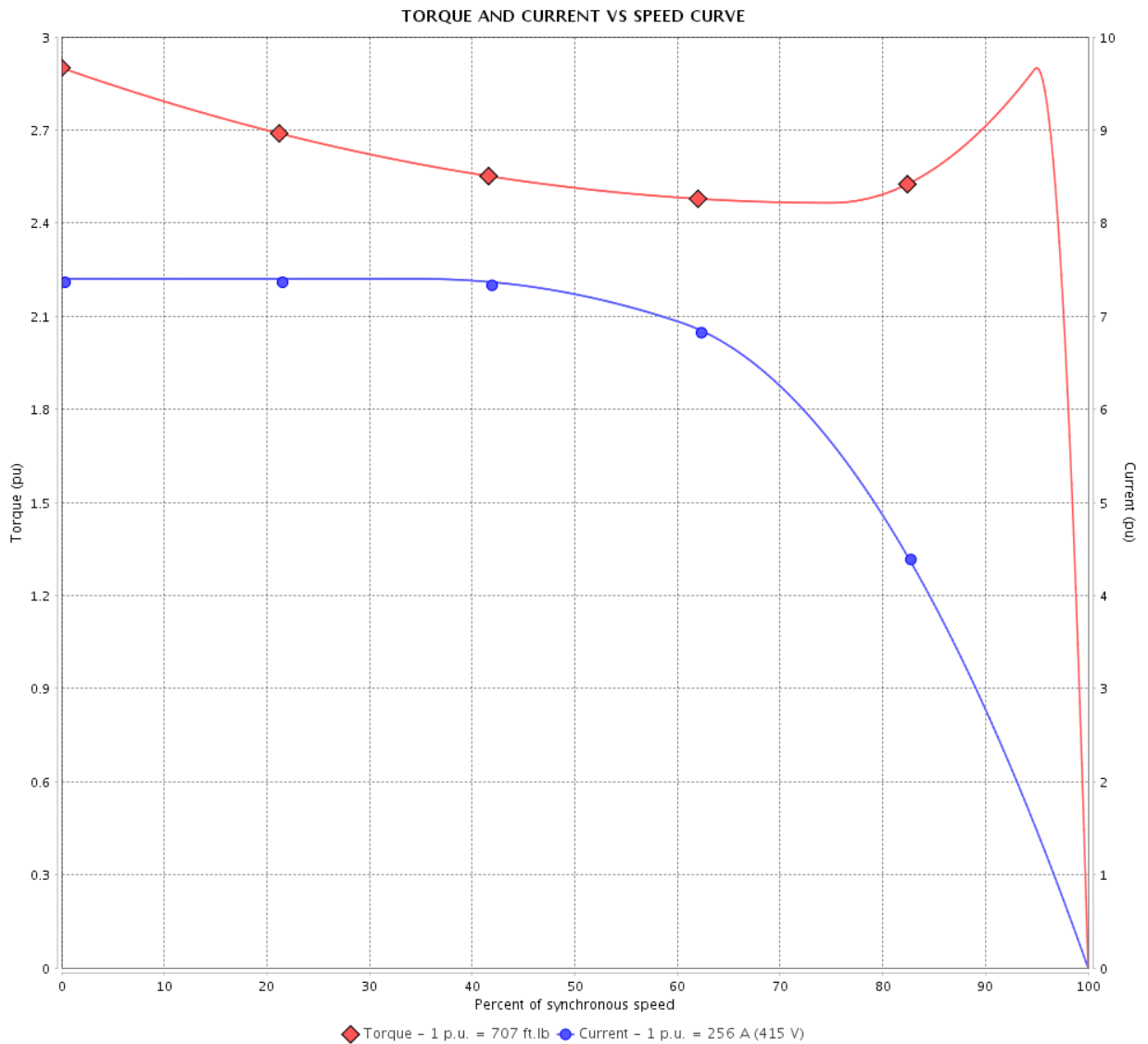

Performance : 415 V 50 Hz 4P IE3

Rated current	: 256 A	Moment of inertia (J)	: 89.6 sq.ft.lb
LRC	: 7.4	Duty cycle	: Cont.(S1)
Rated torque	: 707 ft.lb	Insulation class	: F
Locked rotor torque	: 290 %	Service factor	: 1.15
Breakdown torque	: 290 %	Temperature rise	: 80 K
Rated speed	: 1485 rpm	Design	: B

Locked rotor time : 28s (cold) 16s (hot)

Rev.	Changes Summary	Performed	Checked	Date
Performed by			Page 5 / 36	Revision
Checked by				
Date	13/04/2022			

TORQUE AND CURRENT VS SPEED CURVE

Three Phase Induction Motor - Squirrel Cage



Customer :

Product line : NEMA Premium Efficiency Three-Phase

Product code : 11432097

Catalog # : 25018ST3QIE449T-W22

TORQUE AND CURRENT VS SPEED CURVE

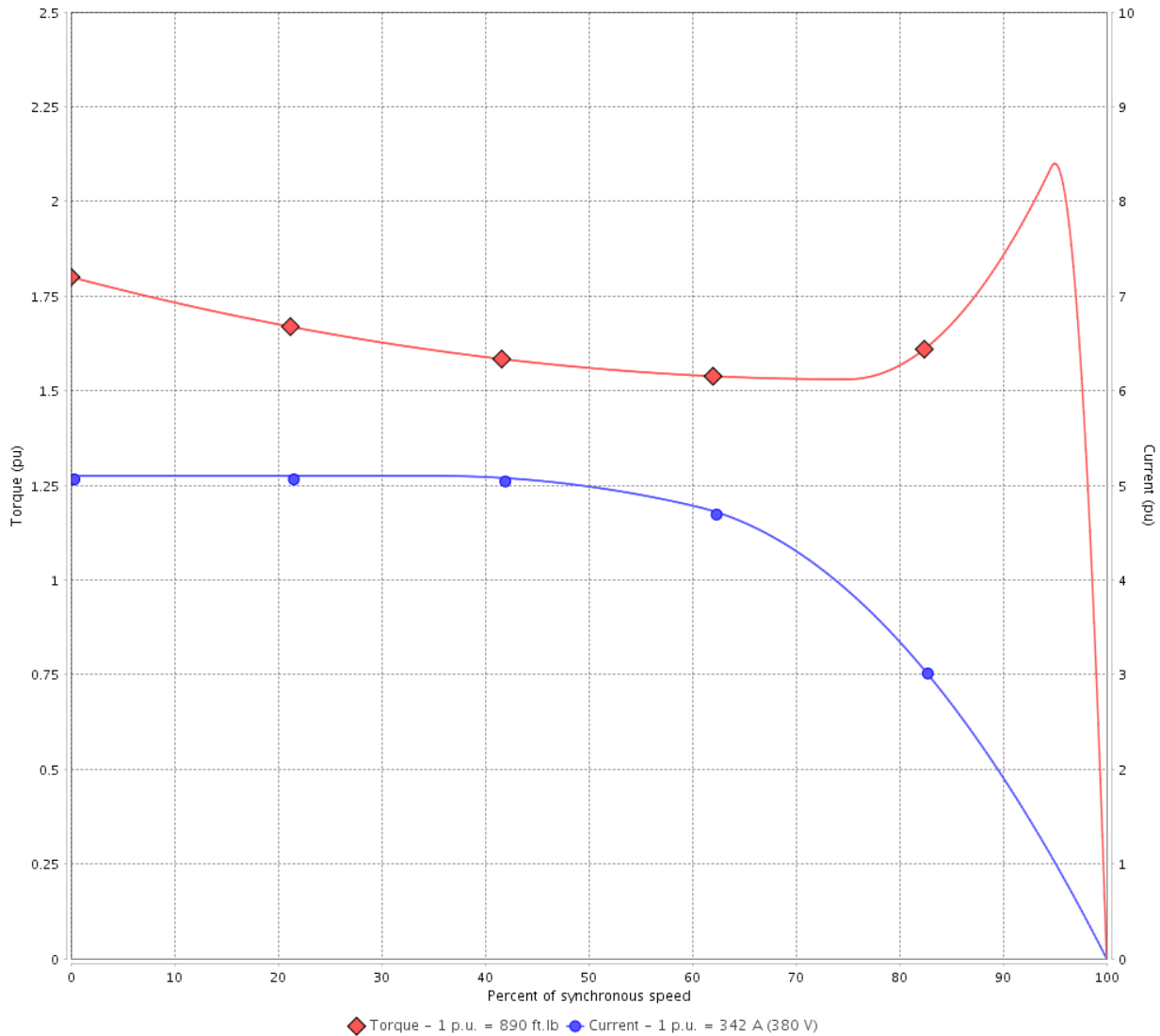

Performance : 380 V 50 Hz 4P IE1

Rated current	: 342 A	Moment of inertia (J)	: 89.6 sq.ft.lb
LRC	: 5.1	Duty cycle	: Cont.(S1)
Rated torque	: 890 ft.lb	Insulation class	: F
Locked rotor torque	: 180 %	Service factor	: 1.00
Breakdown torque	: 210 %	Temperature rise	: 105 K
Rated speed	: 1475 rpm	Design	: B

Locked rotor time : 18s (cold) 10s (hot)

Rev.	Changes Summary	Performed	Checked	Date
Performed by			Page 6 / 36	Revision
Checked by				
Date	13/04/2022			

TORQUE AND CURRENT VS SPEED CURVE



Three Phase Induction Motor - Squirrel Cage

Customer :

Product line : NEMA Premium Efficiency Three-Phase

Product code : 11432097

Catalog # : 25018ST3QIE449T-W22

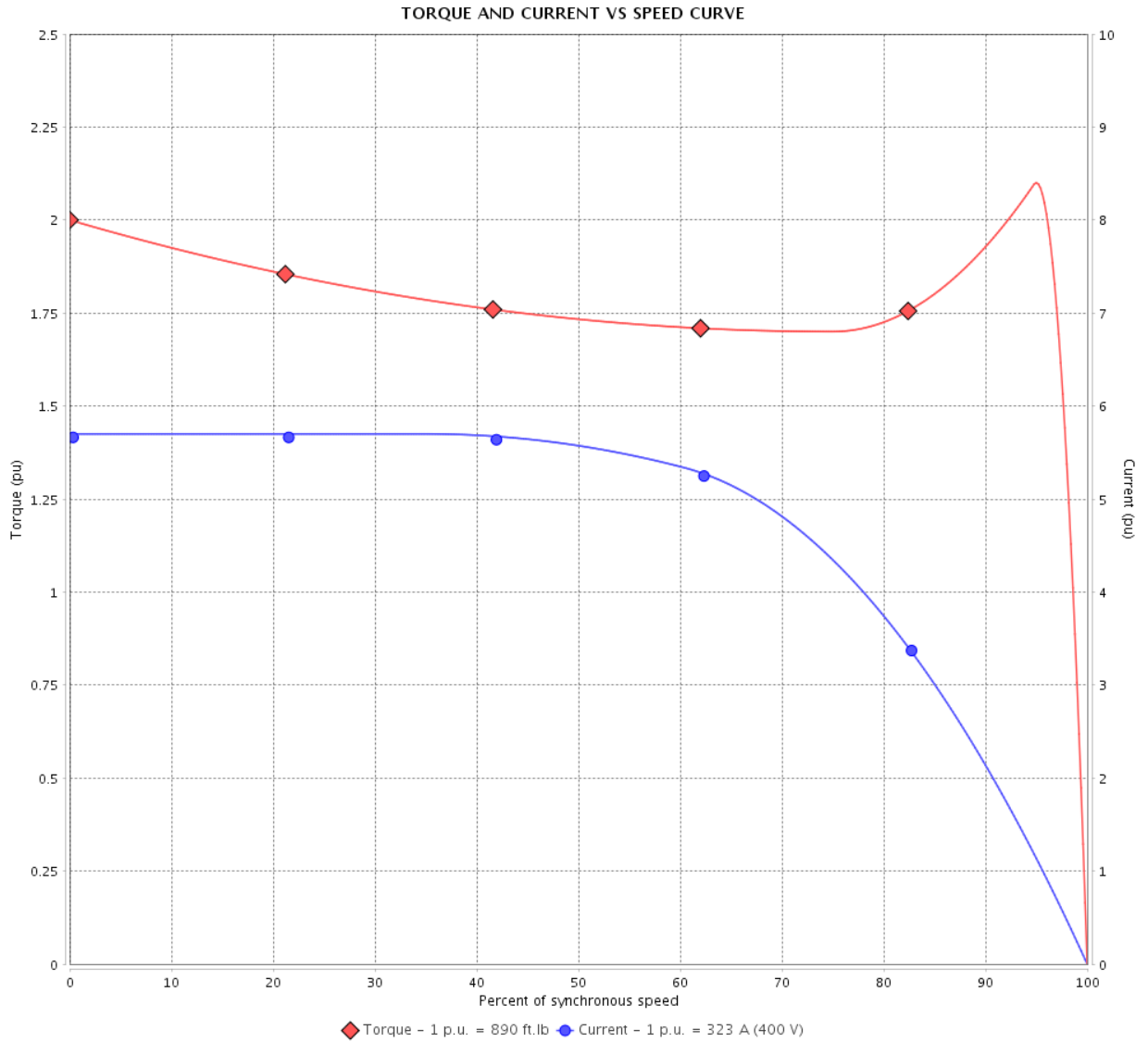

Performance : 400 V 50 Hz 4P IE1

Rated current	: 323 A	Moment of inertia (J)	: 89.6 sq.ft.lb
LRC	: 5.7	Duty cycle	: Cont.(S1)
Rated torque	: 890 ft.lb	Insulation class	: F
Locked rotor torque	: 200 %	Service factor	: 1.00
Breakdown torque	: 210 %	Temperature rise	: 105 K
Rated speed	: 1475 rpm	Design	: B

Locked rotor time : 18s (cold) 10s (hot)

Rev.	Changes Summary	Performed	Checked	Date
Performed by			Page	Revision
Checked by				
Date	13/04/2022			
			7 / 36	

TORQUE AND CURRENT VS SPEED CURVE

Three Phase Induction Motor - Squirrel Cage



Customer :

Product line : NEMA Premium Efficiency Three-Phase

Product code : 11432097

Catalog # : 25018ST3QIE449T-W22

TORQUE AND CURRENT VS SPEED CURVE

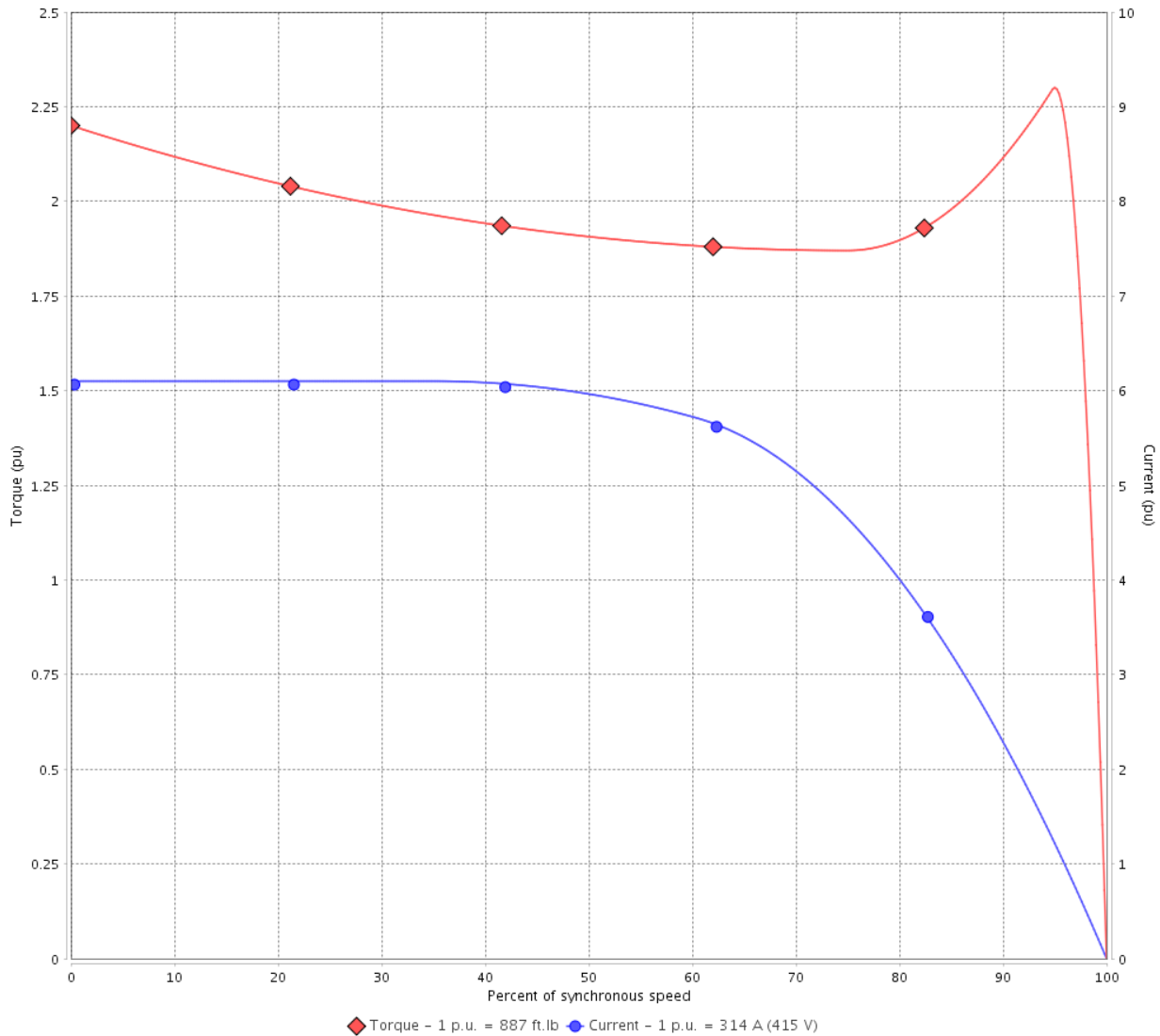

Performance : 415 V 50 Hz 4P IE2

Rated current	: 314 A	Moment of inertia (J)	: 89.6 sq.ft.lb
LRC	: 6.1	Duty cycle	: Cont.(S1)
Rated torque	: 887 ft.lb	Insulation class	: F
Locked rotor torque	: 220 %	Service factor	: 1.00
Breakdown torque	: 229 %	Temperature rise	: 105 K
Rated speed	: 1480 rpm	Design	: B

Locked rotor time : 18s (cold) 10s (hot)

Rev.	Changes Summary	Performed	Checked	Date
Performed by			Page 8 / 36	Revision
Checked by				
Date	13/04/2022			

LOAD PERFORMANCE CURVE

Three Phase Induction Motor - Squirrel Cage



Customer :

Product line : NEMA Premium Efficiency Three-Phase

Product code : 11432097

Catalog # : 25018ST3QIE449T-W22

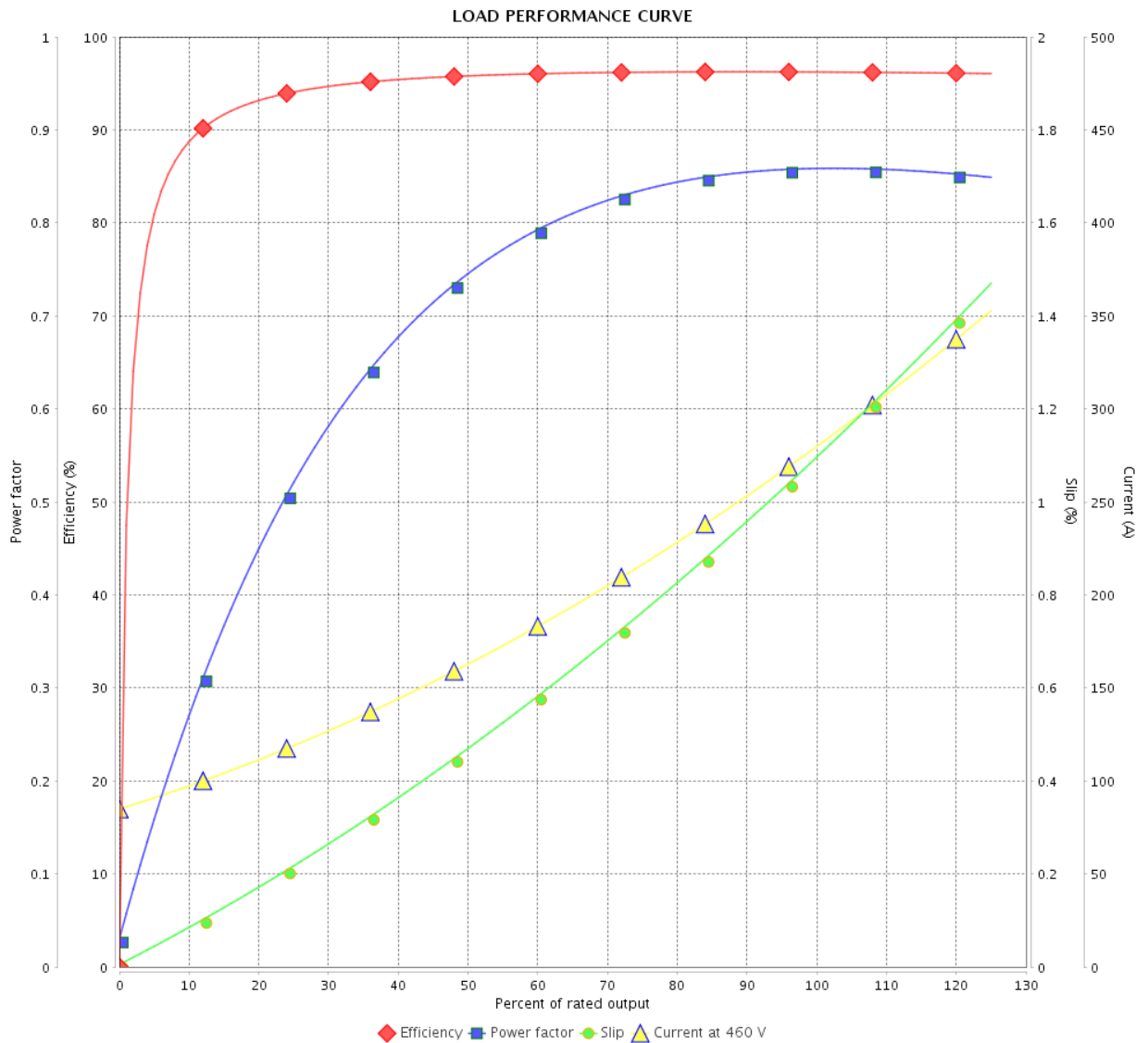

Performance : 460 V 60 Hz 4P

Rated current : 281 A
 LRC : 6.5
 Rated torque : 738 ft.lb
 Locked rotor torque : 229 %
 Breakdown torque : 229 %
 Rated speed : 1780 rpm

Moment of inertia (J) : 89.6 sq.ft.lb
 Duty cycle : Cont.(S1)
 Insulation class : F
 Service factor : 1.15
 Temperature rise : 80 K
 Design : B

Rev.	Changes Summary	Performed	Checked	Date
Performed by			Page	Revision
Checked by				
Date				

LOAD PERFORMANCE CURVE

Three Phase Induction Motor - Squirrel Cage



Customer :

Product line : NEMA Premium Efficiency Three-Phase

Product code : 11432097

Catalog # : 25018ST3QIE449T-W22

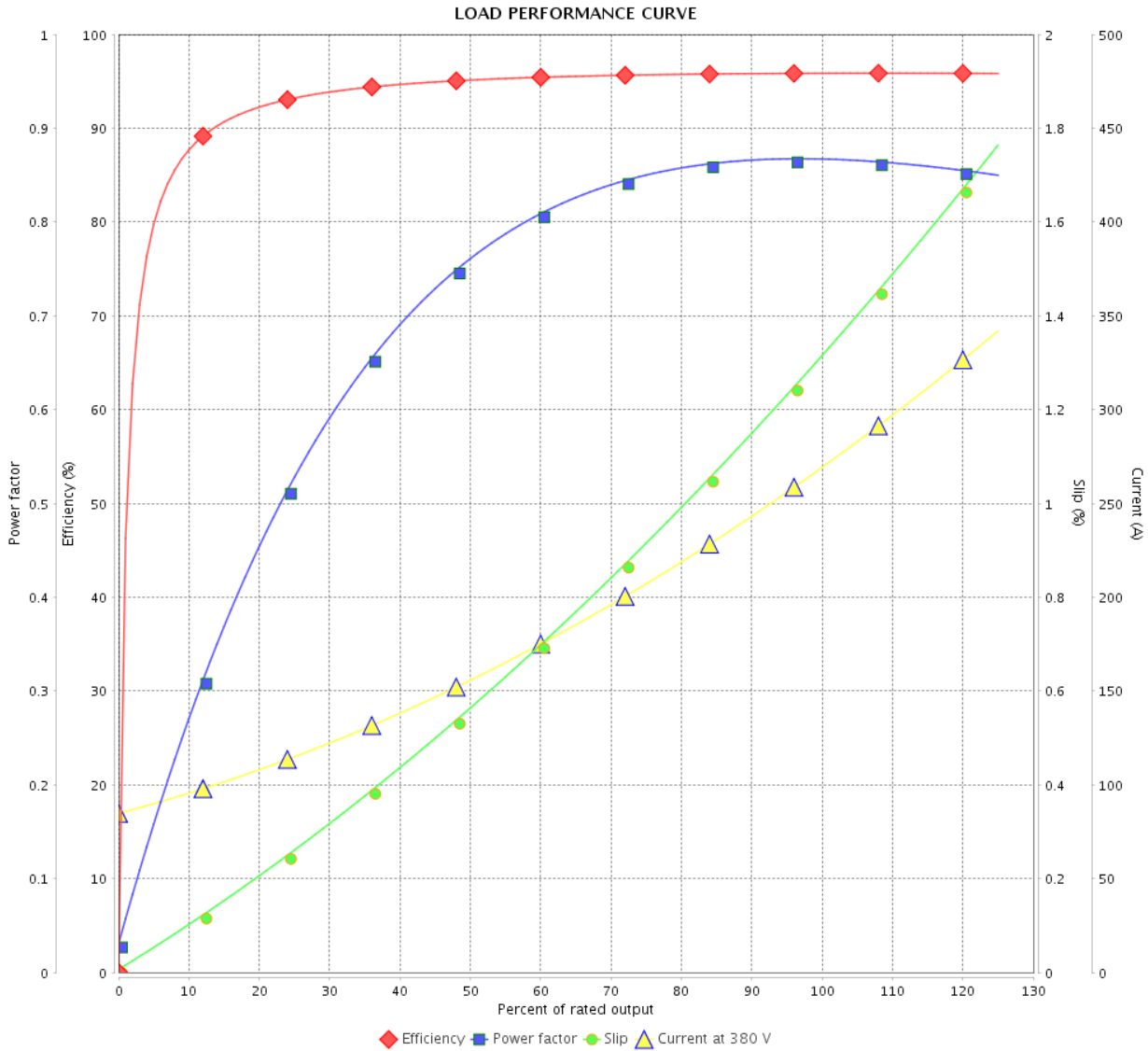

Performance : 380 V 50 Hz 4P IE3

Rated current : 273 A
 LRC : 6.1
 Rated torque : 710 ft.lb
 Locked rotor torque : 200 %
 Breakdown torque : 229 %
 Rated speed : 1480 rpm

Moment of inertia (J) : 89.6 sq.ft.lb
 Duty cycle : Cont.(S1)
 Insulation class : F
 Service factor : 1.15
 Temperature rise : 80 K
 Design : B

Rev.	Changes Summary	Performed	Checked	Date
Performed by		Page		Revision
Checked by		10 / 36		
Date	13/04/2022			

LOAD PERFORMANCE CURVE

Three Phase Induction Motor - Squirrel Cage



Customer :

Product line : NEMA Premium Efficiency Three-Phase

Product code : 11432097

Catalog # : 25018ST3QIE449T-W22

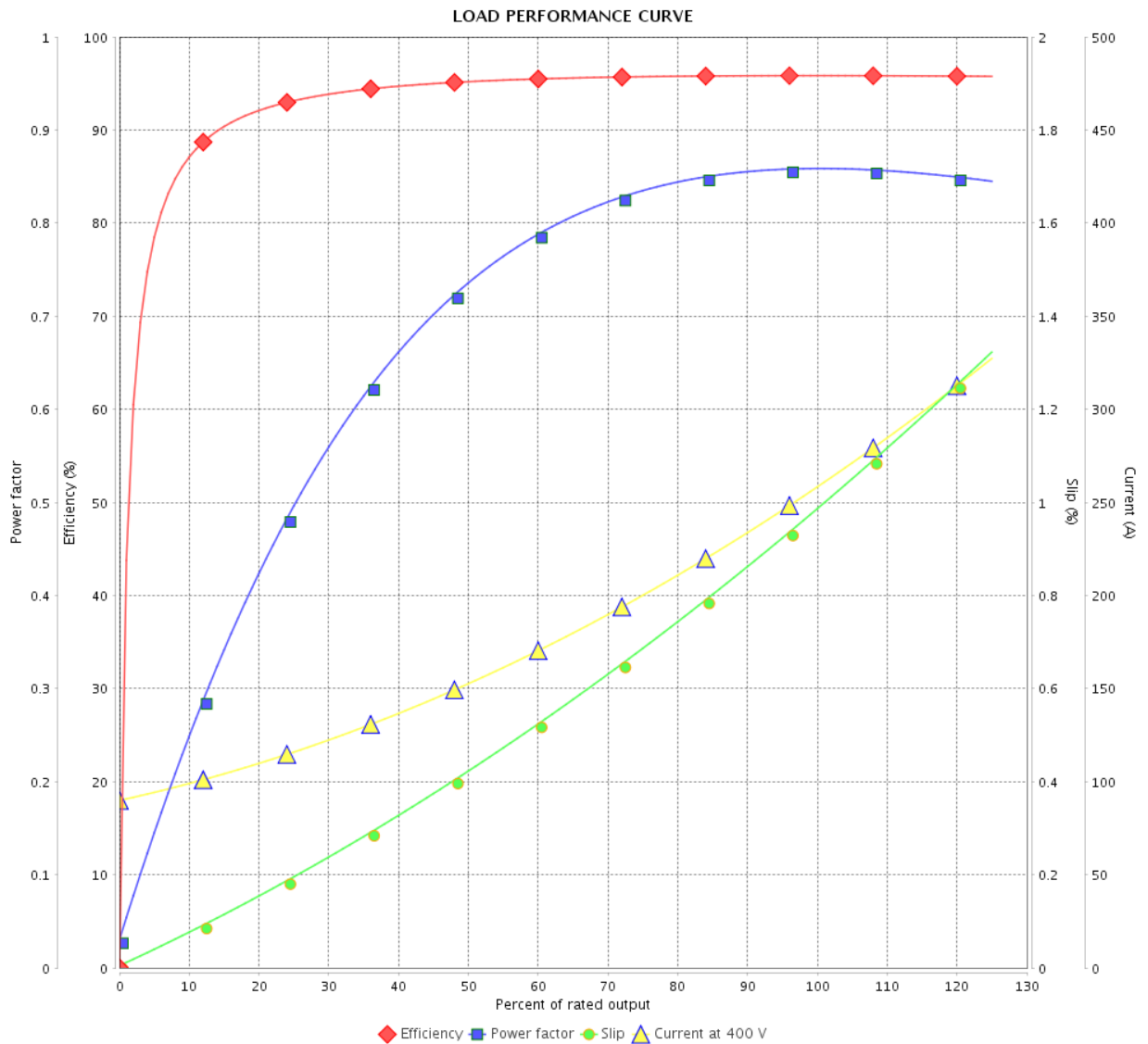

Performance : 400 V 50 Hz 4P IE3

Rated current : 263 A
 LRC : 6.8
 Rated torque : 707 ft.lb
 Locked rotor torque : 260 %
 Breakdown torque : 260 %
 Rated speed : 1485 rpm

Moment of inertia (J) : 89.6 sq.ft.lb
 Duty cycle : Cont.(S1)
 Insulation class : F
 Service factor : 1.15
 Temperature rise : 80 K
 Design : B

Rev.	Changes Summary	Performed	Checked	Date
Performed by		Page		Revision
Checked by		11 / 36		
Date		13/04/2022		

LOAD PERFORMANCE CURVE

Three Phase Induction Motor - Squirrel Cage



Customer : _____

Product line : NEMA Premium Efficiency Three-Phase

Product code : 11432097

Catalog # : 25018ST3QIE449T-W22

LOAD PERFORMANCE CURVE

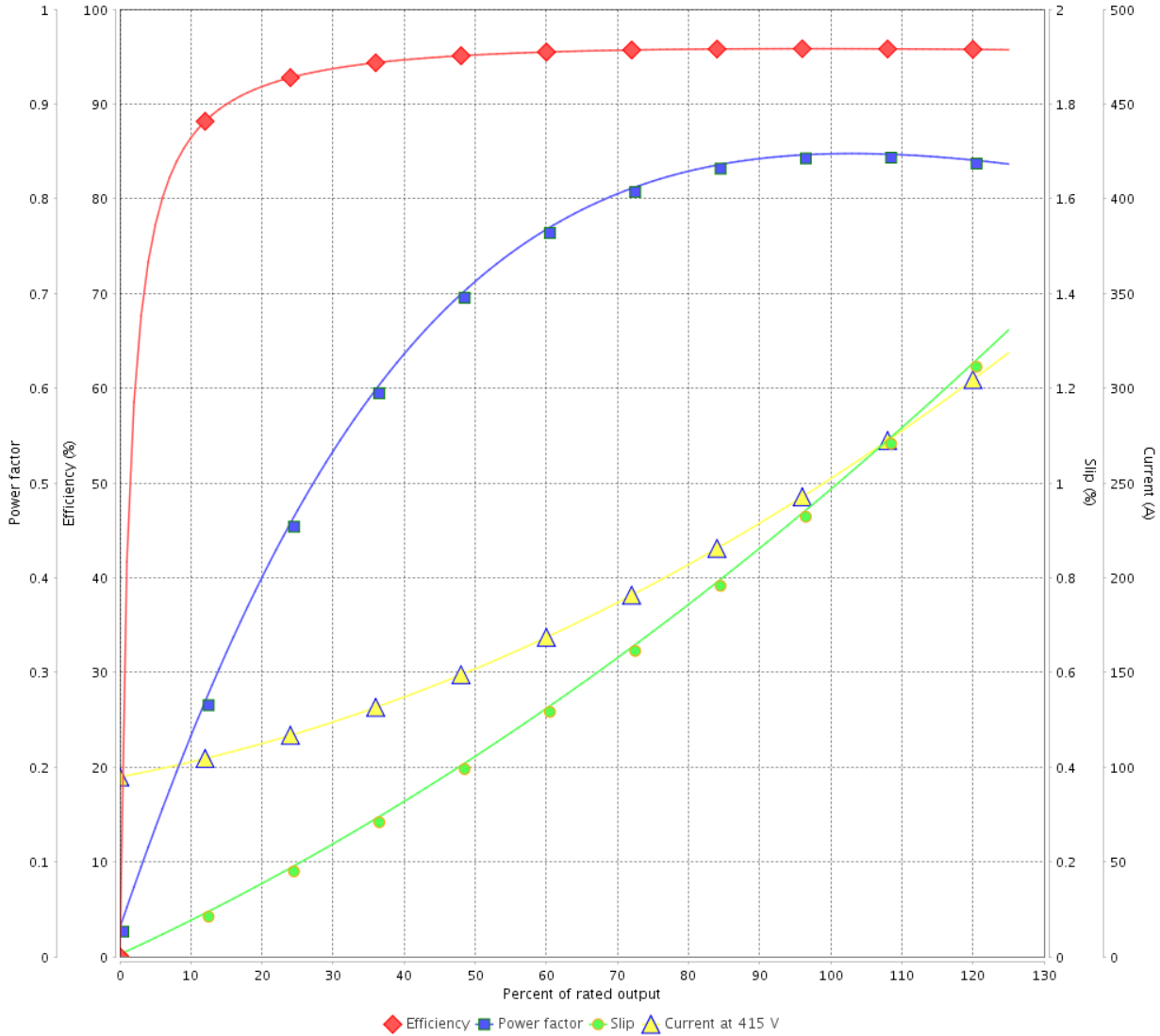

Performance : 415 V 50 Hz 4P IE3

Rated current : 256 A
 LRC : 7.4
 Rated torque : 707 ft.lb
 Locked rotor torque : 290 %
 Breakdown torque : 290 %
 Rated speed : 1485 rpm

Moment of inertia (J) : 89.6 sq.ft.lb
 Duty cycle : Cont.(S1)
 Insulation class : F
 Service factor : 1.15
 Temperature rise : 80 K
 Design : B

Rev.	Changes Summary	Performed	Checked	Date
Performed by			Page 12 / 36	Revision
Checked by				
Date	13/04/2022			

LOAD PERFORMANCE CURVE

Three Phase Induction Motor - Squirrel Cage



Customer :

Product line : NEMA Premium Efficiency Three-Phase

Product code : 11432097

Catalog # : 25018ST3QIE449T-W22

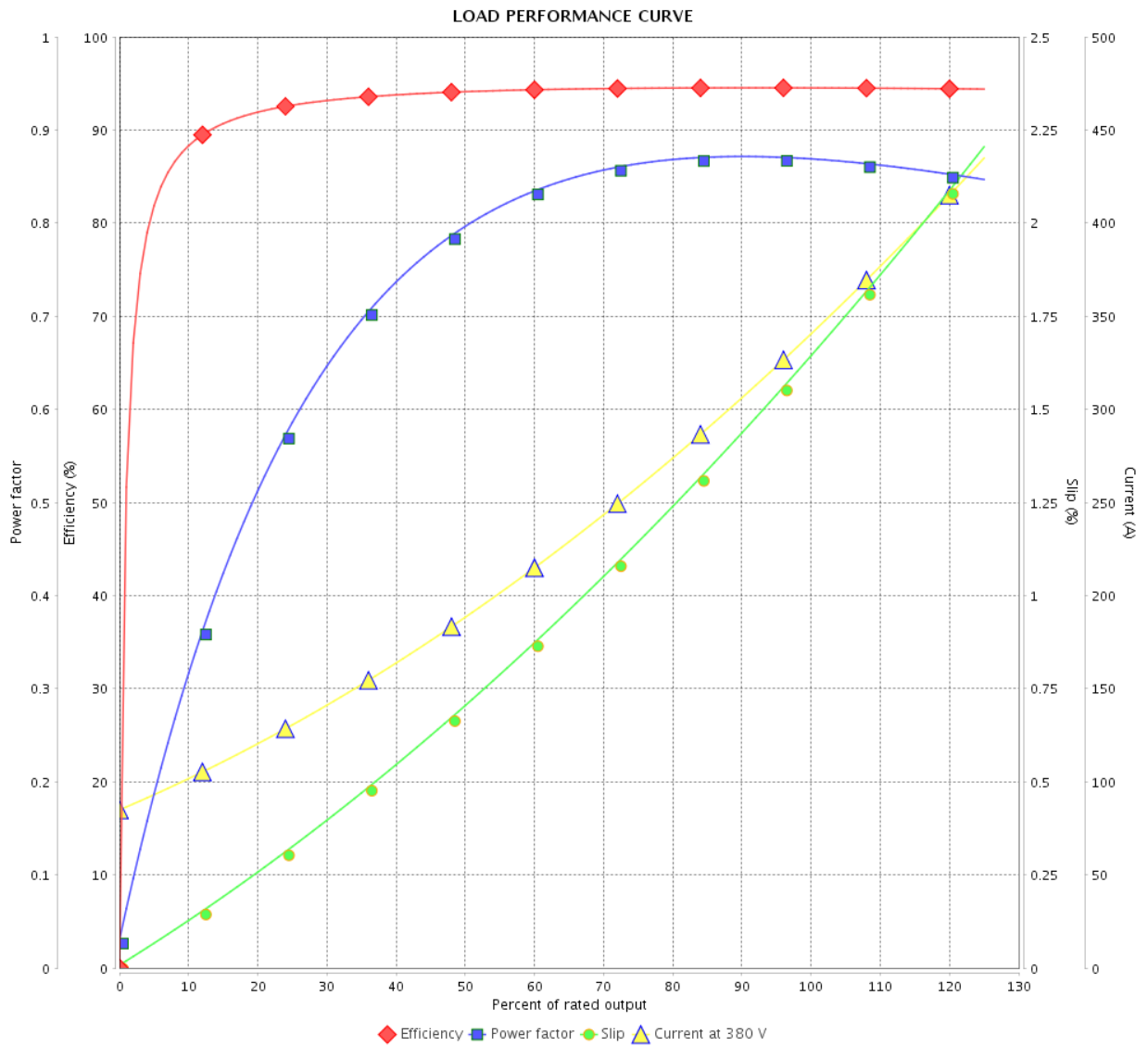

Performance : 380 V 50 Hz 4P IE1

Rated current : 342 A
 LRC : 5.1
 Rated torque : 890 ft.lb
 Locked rotor torque : 180 %
 Breakdown torque : 210 %
 Rated speed : 1475 rpm

Moment of inertia (J) : 89.6 sq.ft.lb
 Duty cycle : Cont.(S1)
 Insulation class : F
 Service factor : 1.00
 Temperature rise : 105 K
 Design : B

Rev.	Changes Summary	Performed	Checked	Date
Performed by		Page		Revision
Checked by		13 / 36		
Date		13/04/2022		

LOAD PERFORMANCE CURVE

Three Phase Induction Motor - Squirrel Cage



Customer :

Product line : NEMA Premium Efficiency Three-Phase

Product code : 11432097

Catalog # : 25018ST3QIE449T-W22

LOAD PERFORMANCE CURVE

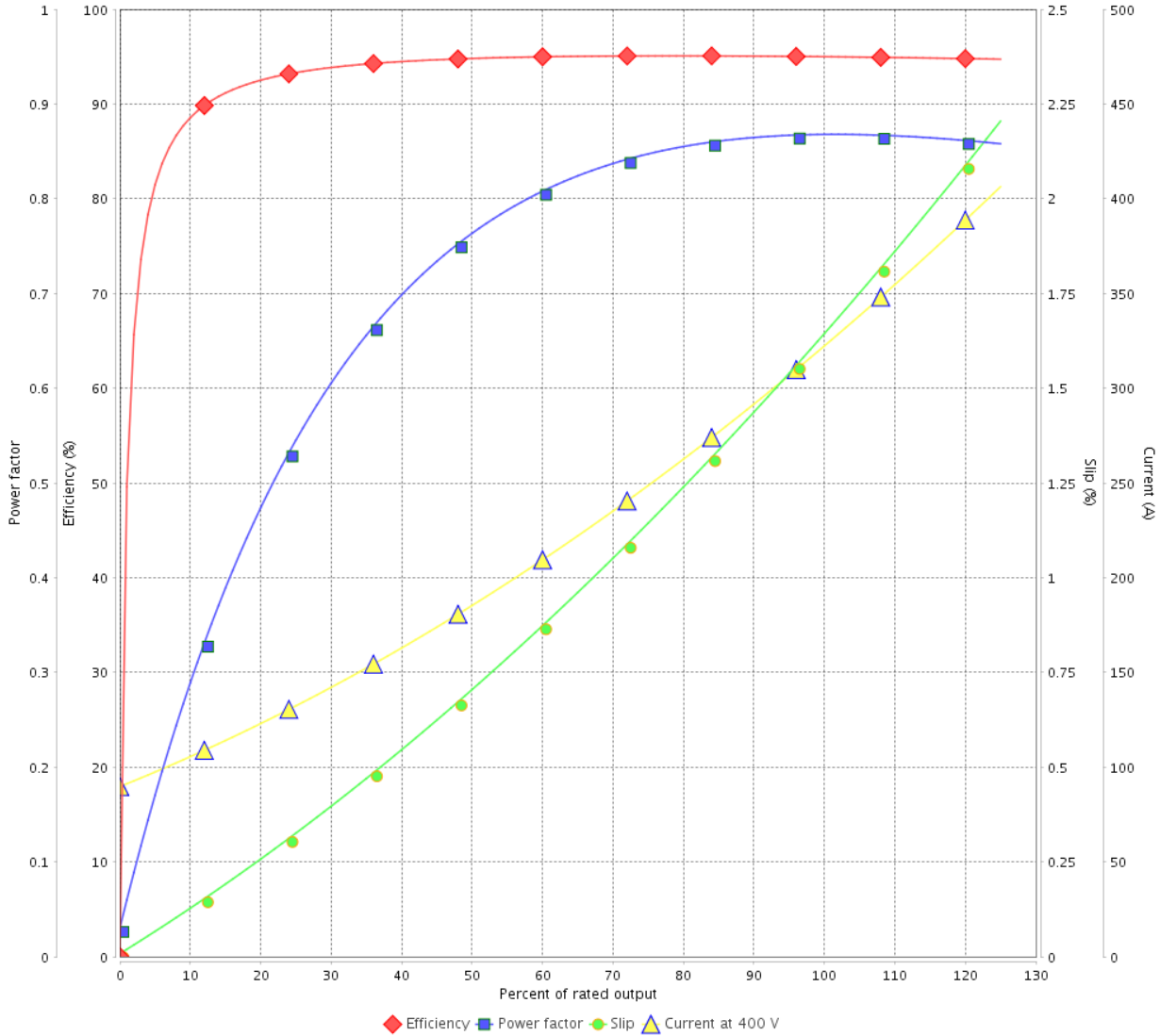

Performance : 400 V 50 Hz 4P IE1

Rated current : 323 A
 LRC : 5.7
 Rated torque : 890 ft.lb
 Locked rotor torque : 200 %
 Breakdown torque : 210 %
 Rated speed : 1475 rpm

Moment of inertia (J) : 89.6 sq.ft.lb
 Duty cycle : Cont.(S1)
 Insulation class : F
 Service factor : 1.00
 Temperature rise : 105 K
 Design : B

Rev.	Changes Summary	Performed	Checked	Date
Performed by		Page		Revision
Checked by		14 / 36		
Date		13/04/2022		

LOAD PERFORMANCE CURVE

Three Phase Induction Motor - Squirrel Cage



Customer : _____

Product line : NEMA Premium Efficiency Three-Phase

Product code : 11432097

Catalog # : 25018ST3QIE449T-W22

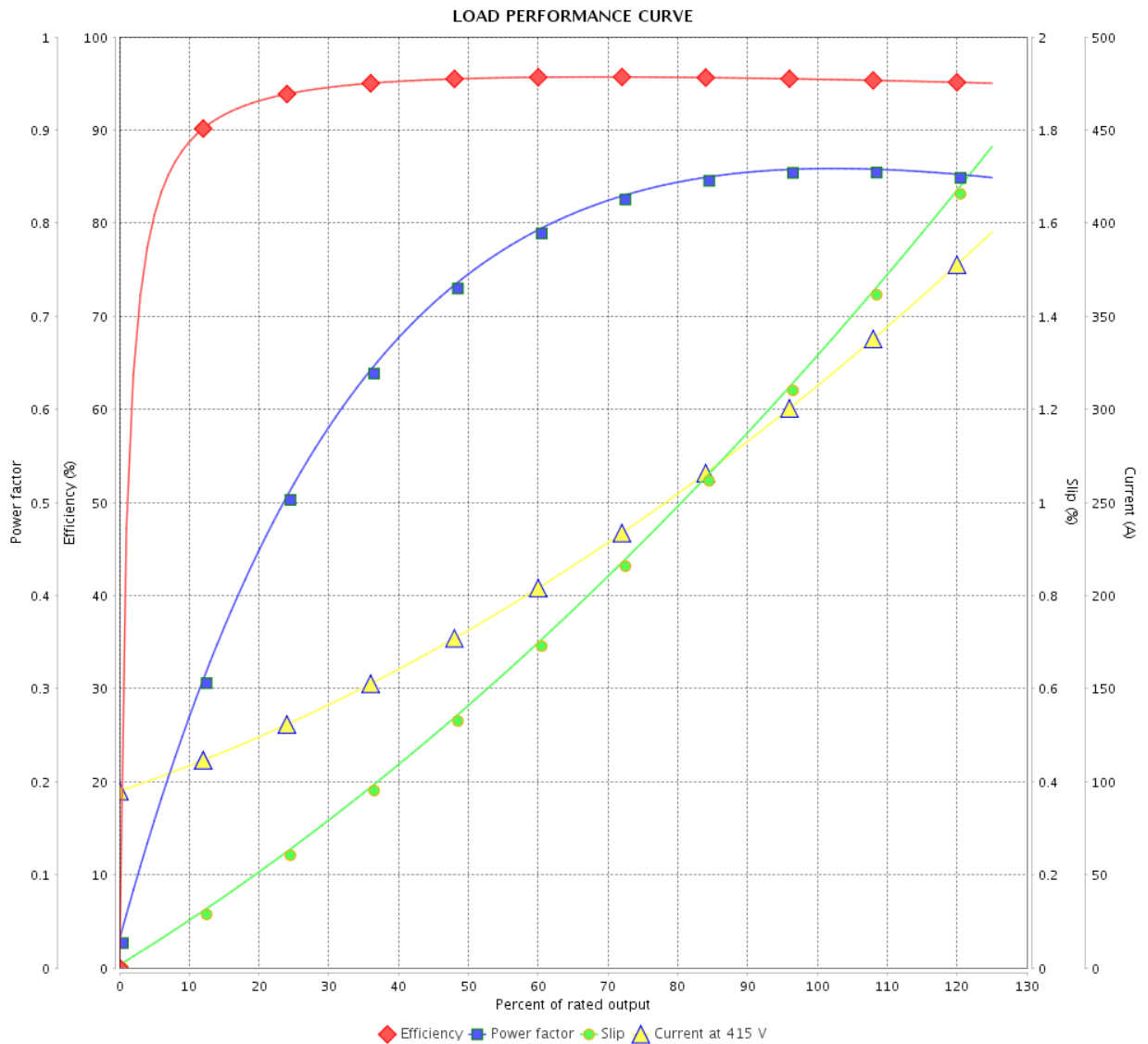

Performance : 415 V 50 Hz 4P IE2

Rated current : 314 A
 LRC : 6.1
 Rated torque : 887 ft.lb
 Locked rotor torque : 220 %
 Breakdown torque : 229 %
 Rated speed : 1480 rpm

Moment of inertia (J) : 89.6 sq.ft.lb
 Duty cycle : Cont.(S1)
 Insulation class : F
 Service factor : 1.00
 Temperature rise : 105 K
 Design : B

Rev.	Changes Summary	Performed	Checked	Date
Performed by			Page	Revision
Checked by				
Date				

THERMAL LIMIT CURVE



Three Phase Induction Motor - Squirrel Cage

Customer :

Product line : NEMA Premium Efficiency Three-Phase
 Product code : 11432097
 Catalog # : 25018ST3QIE449T-W22

Performance : 460 V 60 Hz 4P

Rated current : 281 A	Moment of inertia (J) : 89.6 sq.ft.lb
LRC : 6.5	Duty cycle : Cont.(S1)
Rated torque : 738 ft.lb	Insulation class : F
Locked rotor torque : 229 %	Service factor : 1.15
Breakdown torque : 229 %	Temperature rise : 80 K
Rated speed : 1780 rpm	Design : B

Heating constant

Cooling constant

Rev.	Changes Summary	Performed	Checked	Date
Performed by			Page 16 / 36	Revision
Checked by				
Date	13/04/2022			

THERMAL LIMIT CURVE

Three Phase Induction Motor - Squirrel Cage



Customer : _____

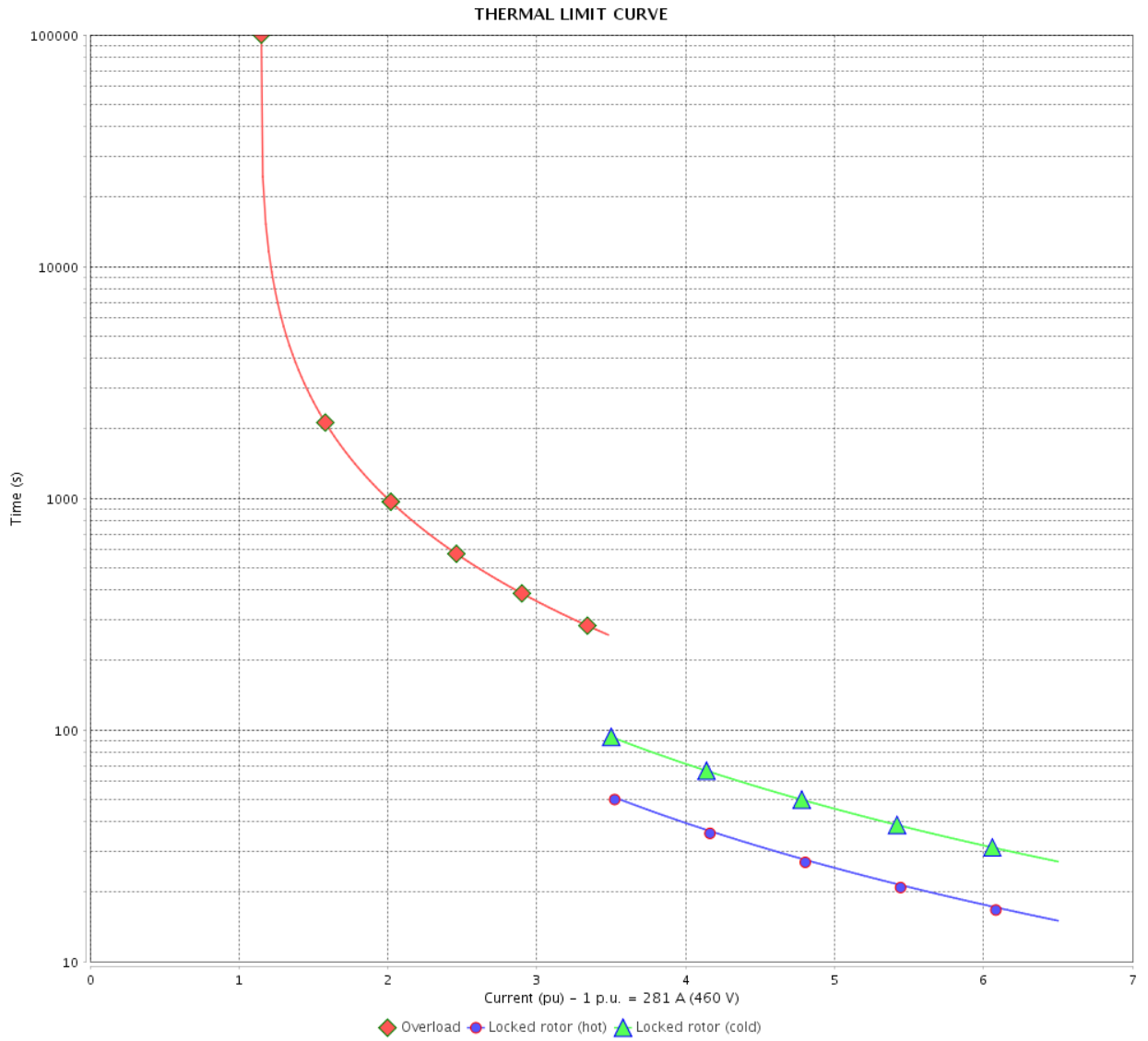

Rev.	Changes Summary	Performed	Checked	Date
Performed by		Page 17 / 36		Revision
Checked by				
Date				

THERMAL LIMIT CURVE

Three Phase Induction Motor - Squirrel Cage



Customer :

Product line : NEMA Premium Efficiency Three-Phase

Product code : 11432097

Catalog # : 25018ST3QIE449T-W22

Performance : 380 V 50 Hz 4P IE3

Rated current	: 273 A	Moment of inertia (J)	: 89.6 sq.ft.lb
LRC	: 6.1	Duty cycle	: Cont.(S1)
Rated torque	: 710 ft.lb	Insulation class	: F
Locked rotor torque	: 200 %	Service factor	: 1.15
Breakdown torque	: 229 %	Temperature rise	: 80 K
Rated speed	: 1480 rpm	Design	: B

Heating constant

Cooling constant

Rev.	Changes Summary	Performed	Checked	Date
Performed by				
Checked by			Page	Revision
Date	13/04/2022		18 / 36	

THERMAL LIMIT CURVE

Three Phase Induction Motor - Squirrel Cage



Customer : _____

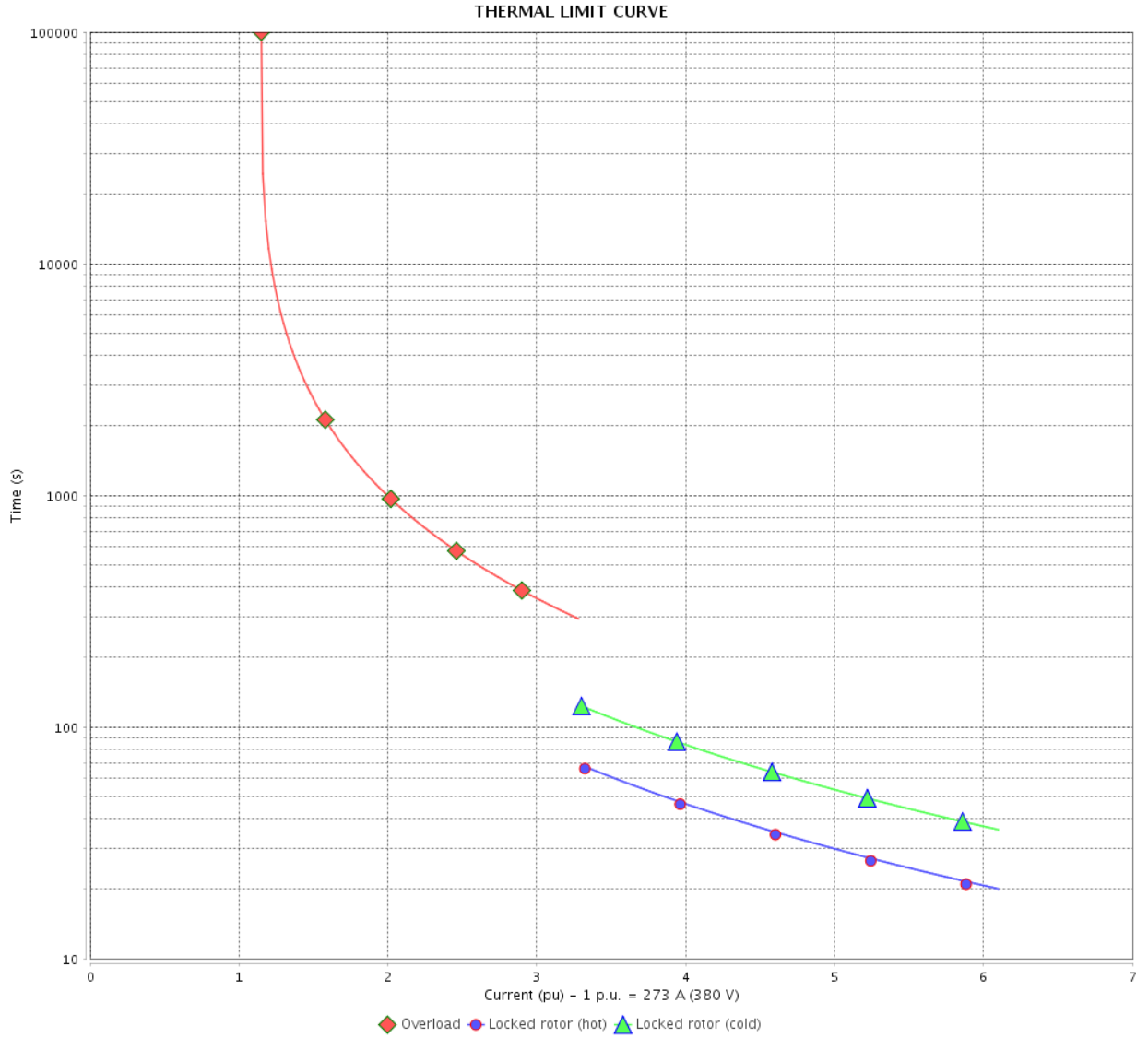

Rev.	Changes Summary	Performed	Checked	Date
Performed by		Page 19 / 36		Revision
Checked by				
Date				

THERMAL LIMIT CURVE

Three Phase Induction Motor - Squirrel Cage



Customer :

Product line : NEMA Premium Efficiency Three-Phase

Product code : 11432097

Catalog # : 25018ST3QIE449T-W22

Performance : 400 V 50 Hz 4P IE3

Rated current	: 263 A	Moment of inertia (J)	: 89.6 sq.ft.lb
LRC	: 6.8	Duty cycle	: Cont.(S1)
Rated torque	: 707 ft.lb	Insulation class	: F
Locked rotor torque	: 260 %	Service factor	: 1.15
Breakdown torque	: 260 %	Temperature rise	: 80 K
Rated speed	: 1485 rpm	Design	: B

Heating constant

Cooling constant

Rev.	Changes Summary	Performed	Checked	Date
Performed by				
Checked by			Page	Revision
Date	13/04/2022		20 / 36	

THERMAL LIMIT CURVE

Three Phase Induction Motor - Squirrel Cage



Customer : _____

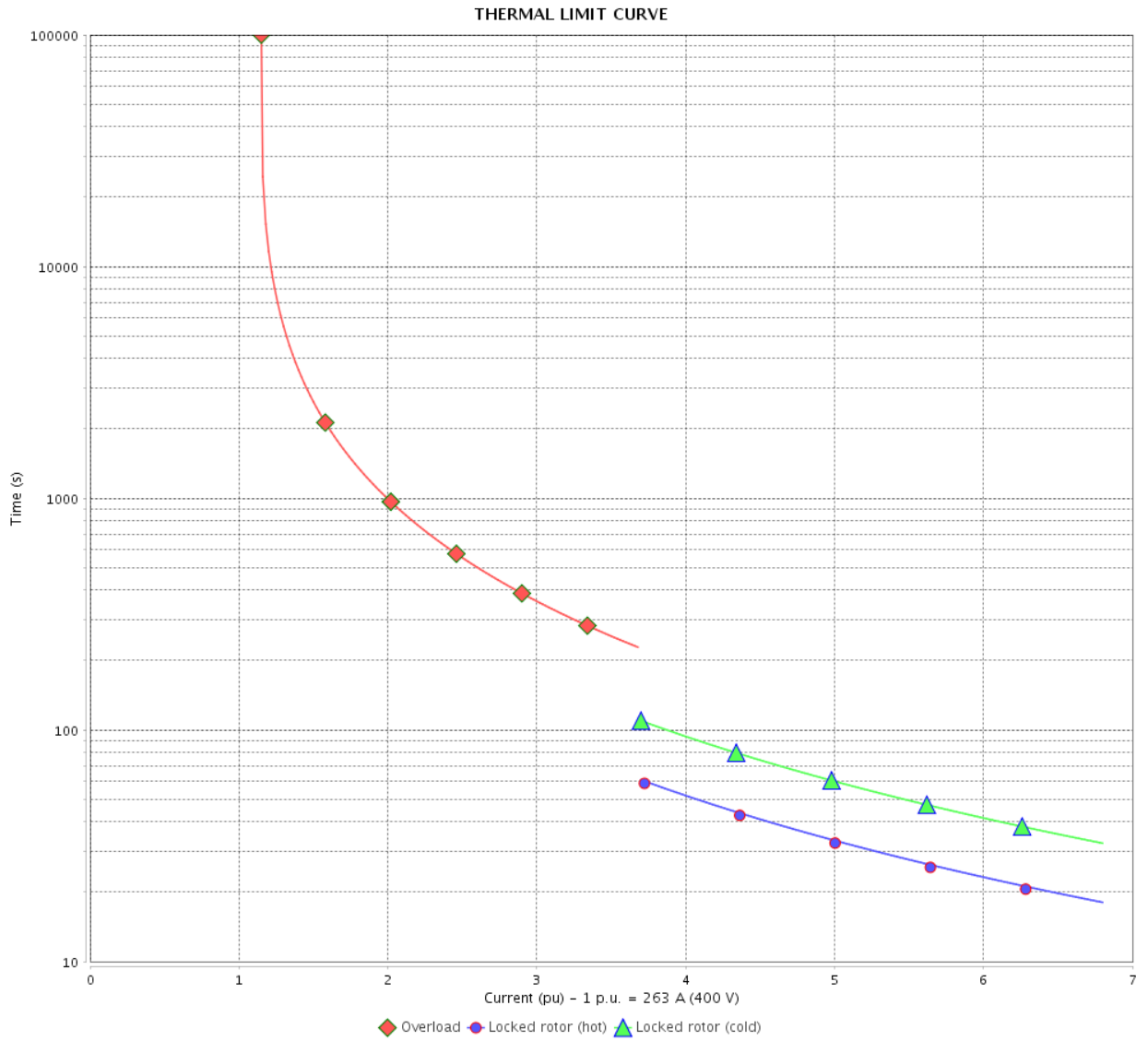

Rev.	Changes Summary	Performed	Checked	Date
Performed by		Page 21 / 36		Revision
Checked by				
Date				

THERMAL LIMIT CURVE

Three Phase Induction Motor - Squirrel Cage



Customer :

Product line : NEMA Premium Efficiency Three-Phase
Product code : 11432097
Catalog # : 25018ST3QIE449T-W22

Performance : 415 V 50 Hz 4P IE3

Rated current	: 256 A	Moment of inertia (J)	: 89.6 sq.ft.lb
LRC	: 7.4	Duty cycle	: Cont.(S1)
Rated torque	: 707 ft.lb	Insulation class	: F
Locked rotor torque	: 290 %	Service factor	: 1.15
Breakdown torque	: 290 %	Temperature rise	: 80 K
Rated speed	: 1485 rpm	Design	: B

Heating constant

Cooling constant

Rev.	Changes Summary	Performed	Checked	Date
Performed by				
Checked by			Page	Revision
Date	13/04/2022		22 / 36	

THERMAL LIMIT CURVE

Three Phase Induction Motor - Squirrel Cage



Customer : _____

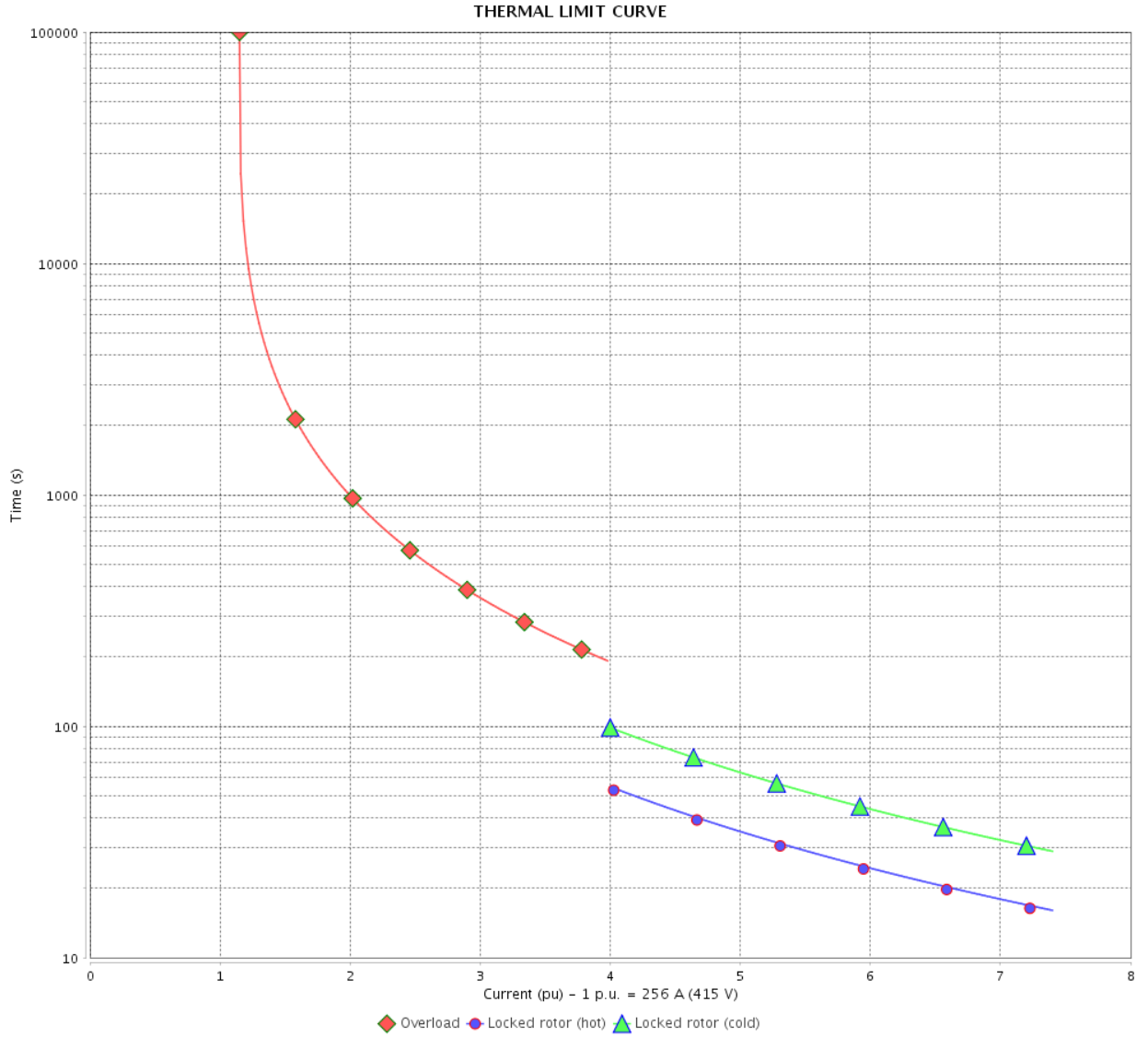

Rev.	Changes Summary	Performed	Checked	Date
Performed by		Page 23 / 36		Revision
Checked by				
Date				

THERMAL LIMIT CURVE

Three Phase Induction Motor - Squirrel Cage



Customer :

Product line : NEMA Premium Efficiency Three-Phase
Product code : 11432097
Catalog # : 25018ST3QIE449T-W22

Performance : 380 V 50 Hz 4P IE1

Rated current	: 342 A	Moment of inertia (J)	: 89.6 sq.ft.lb
LRC	: 5.1	Duty cycle	: Cont.(S1)
Rated torque	: 890 ft.lb	Insulation class	: F
Locked rotor torque	: 180 %	Service factor	: 1.00
Breakdown torque	: 210 %	Temperature rise	: 105 K
Rated speed	: 1475 rpm	Design	: B

Heating constant

Cooling constant

Rev.	Changes Summary	Performed	Checked	Date
Performed by				
Checked by			Page	Revision
Date	13/04/2022		24 / 36	

THERMAL LIMIT CURVE

Three Phase Induction Motor - Squirrel Cage



Customer : _____

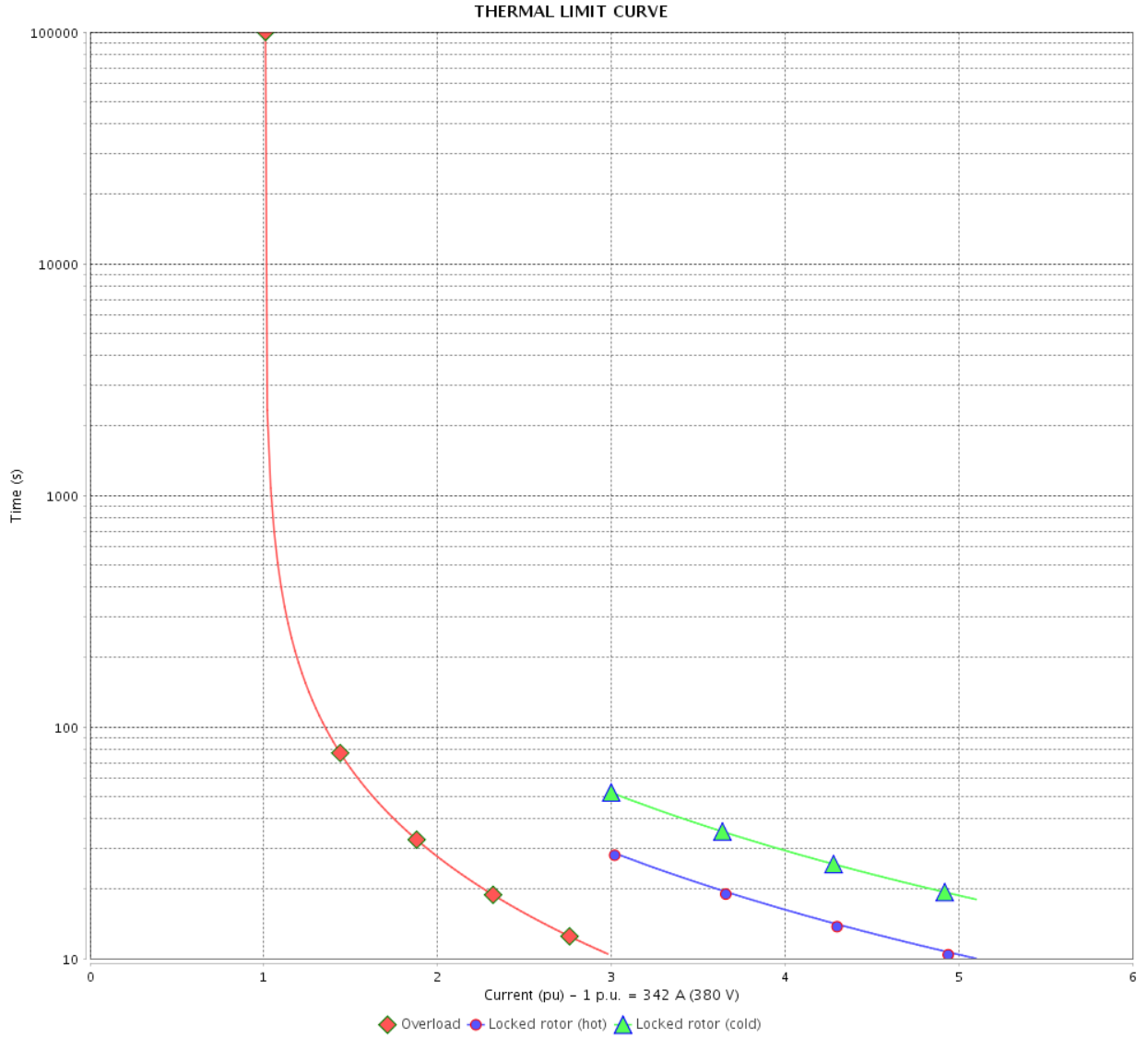

Rev.	Changes Summary	Performed	Checked	Date
Performed by		Page 25 / 36 Revision		
Checked by				
Date				

THERMAL LIMIT CURVE

Three Phase Induction Motor - Squirrel Cage



Customer :

Product line : NEMA Premium Efficiency Three-Phase

Product code : 11432097

Catalog # : 25018ST3QIE449T-W22

Performance : 400 V 50 Hz 4P IE1

Rated current	: 323 A	Moment of inertia (J)	: 89.6 sq.ft.lb
LRC	: 5.7	Duty cycle	: Cont.(S1)
Rated torque	: 890 ft.lb	Insulation class	: F
Locked rotor torque	: 200 %	Service factor	: 1.00
Breakdown torque	: 210 %	Temperature rise	: 105 K
Rated speed	: 1475 rpm	Design	: B

Heating constant

Cooling constant

Rev.	Changes Summary	Performed	Checked	Date
Performed by				
Checked by			Page	Revision
Date	13/04/2022		26 / 36	

THERMAL LIMIT CURVE

Three Phase Induction Motor - Squirrel Cage



Customer : _____

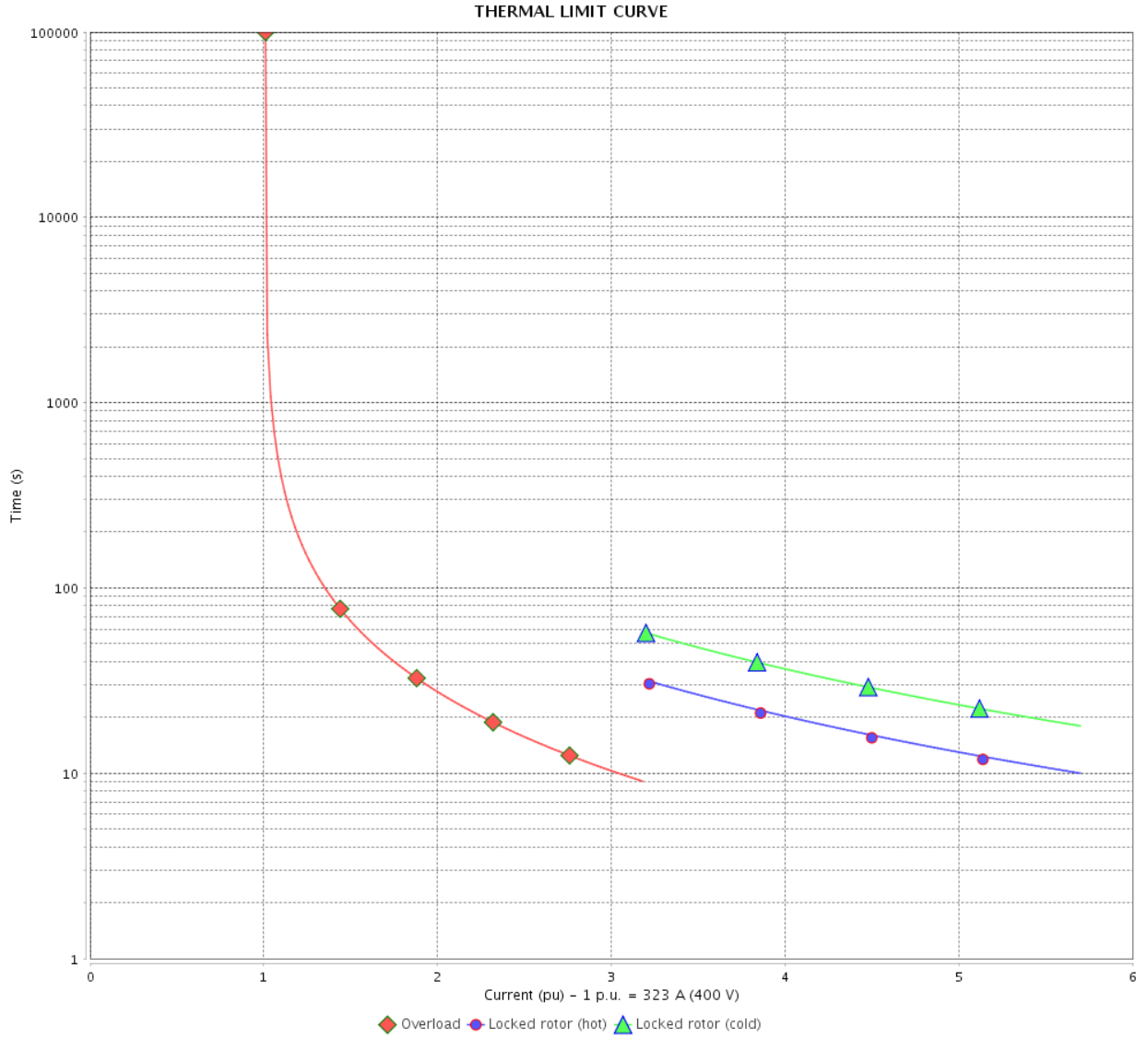

Rev.	Changes Summary	Performed	Checked	Date
Performed by		Page 27 / 36		Revision
Checked by				
Date				

THERMAL LIMIT CURVE

Three Phase Induction Motor - Squirrel Cage



Customer :

Product line : NEMA Premium Efficiency Three-Phase

Product code : 11432097

Catalog # : 25018ST3QIE449T-W22

Performance : 415 V 50 Hz 4P IE2

Rated current	: 314 A	Moment of inertia (J)	: 89.6 sq.ft.lb
LRC	: 6.1	Duty cycle	: Cont.(S1)
Rated torque	: 887 ft.lb	Insulation class	: F
Locked rotor torque	: 220 %	Service factor	: 1.00
Breakdown torque	: 229 %	Temperature rise	: 105 K
Rated speed	: 1480 rpm	Design	: B

Heating constant

Cooling constant

Rev.	Changes Summary	Performed	Checked	Date
Performed by				
Checked by			Page	Revision
Date	13/04/2022		28 / 36	

THERMAL LIMIT CURVE

Three Phase Induction Motor - Squirrel Cage



Customer : _____

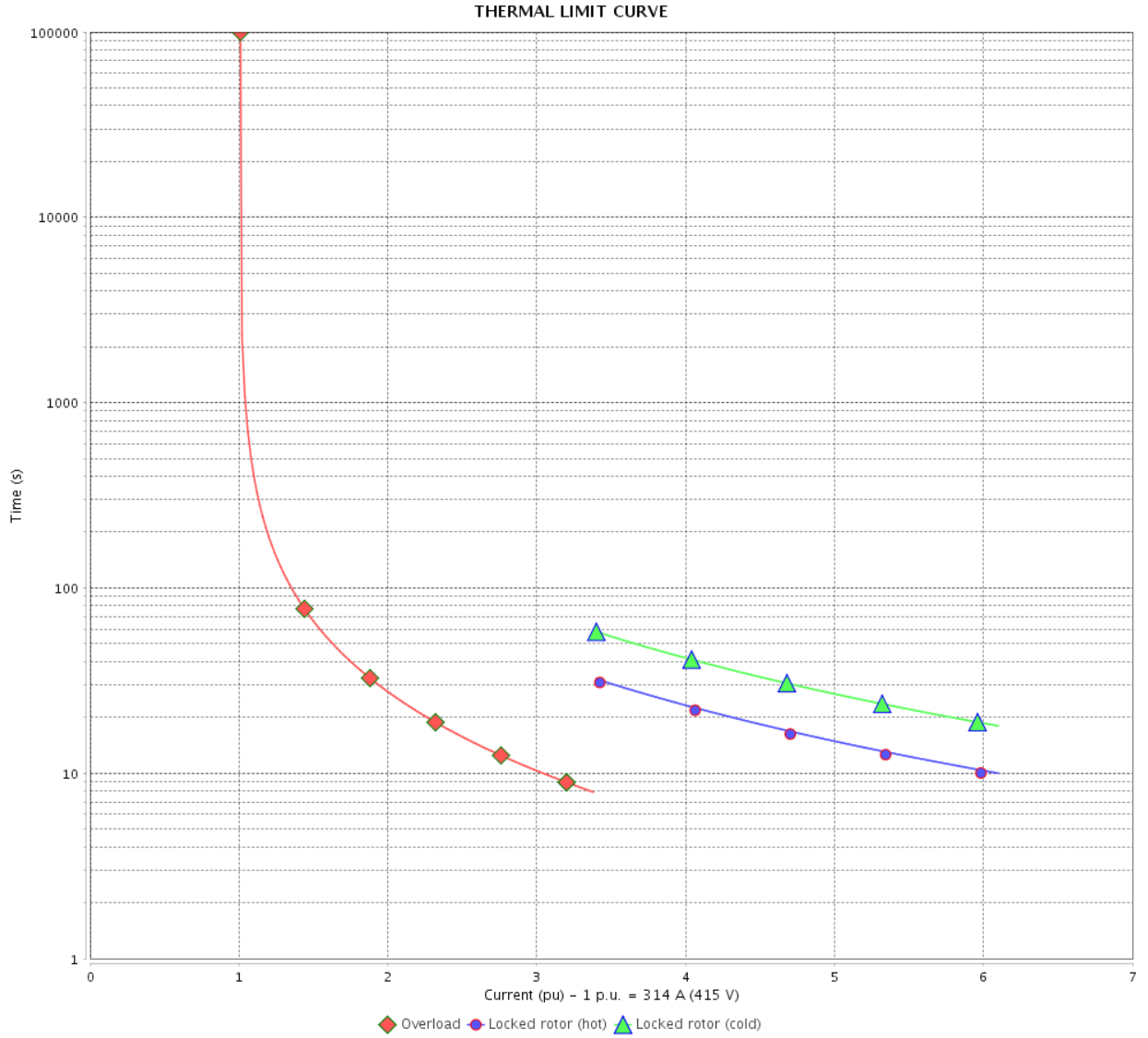

Rev.	Changes Summary	Performed	Checked	Date
Performed by		Page 29 / 36		Revision
Checked by				
Date				

VFD OPERATION CURVE

Three Phase Induction Motor - Squirrel Cage



Customer :

Product line : NEMA Premium Efficiency Three-Phase

Product code : 11432097

Catalog # : 25018ST3QIE449T-W22

VFD OPERATION CURVE

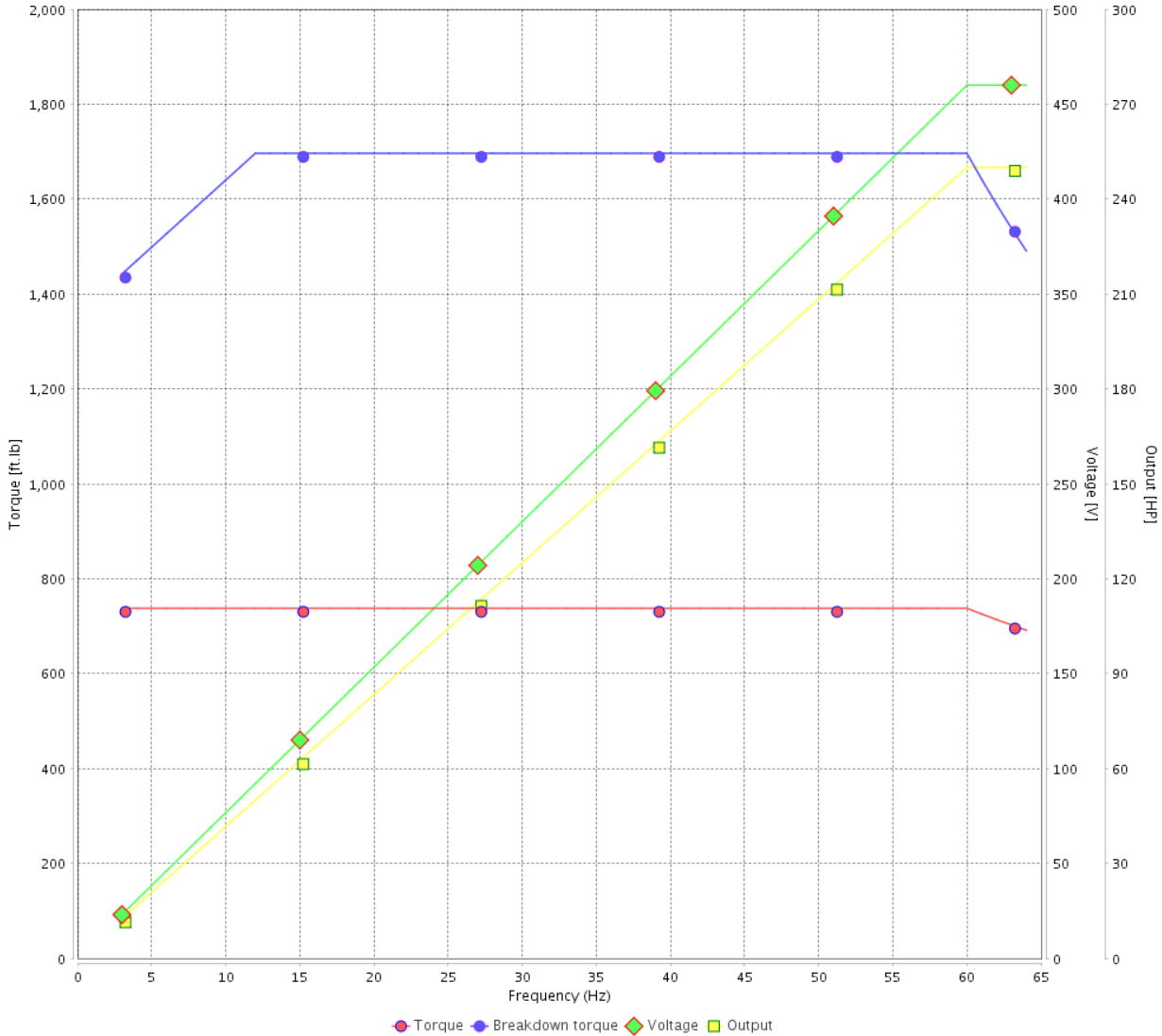

Performance : 460 V 60 Hz 4P

Rated current : 281 A
 LRC : 6.5
 Rated torque : 738 ft.lb
 Locked rotor torque : 229 %
 Breakdown torque : 229 %
 Rated speed : 1780 rpm

Moment of inertia (J) : 89.6 sq.ft.lb
 Duty cycle : Cont.(S1)
 Insulation class : F
 Service factor : 1.15
 Temperature rise : 80 K
 Design : B

Rev.	Changes Summary	Performed	Checked	Date
Performed by			Page	Revision
Checked by				
Date				
		Page 30 / 36		

VFD OPERATION CURVE

Three Phase Induction Motor - Squirrel Cage



Customer : _____

Product line : NEMA Premium Efficiency Three-Phase

Product code : 11432097

Catalog # : 25018ST3QIE449T-W22

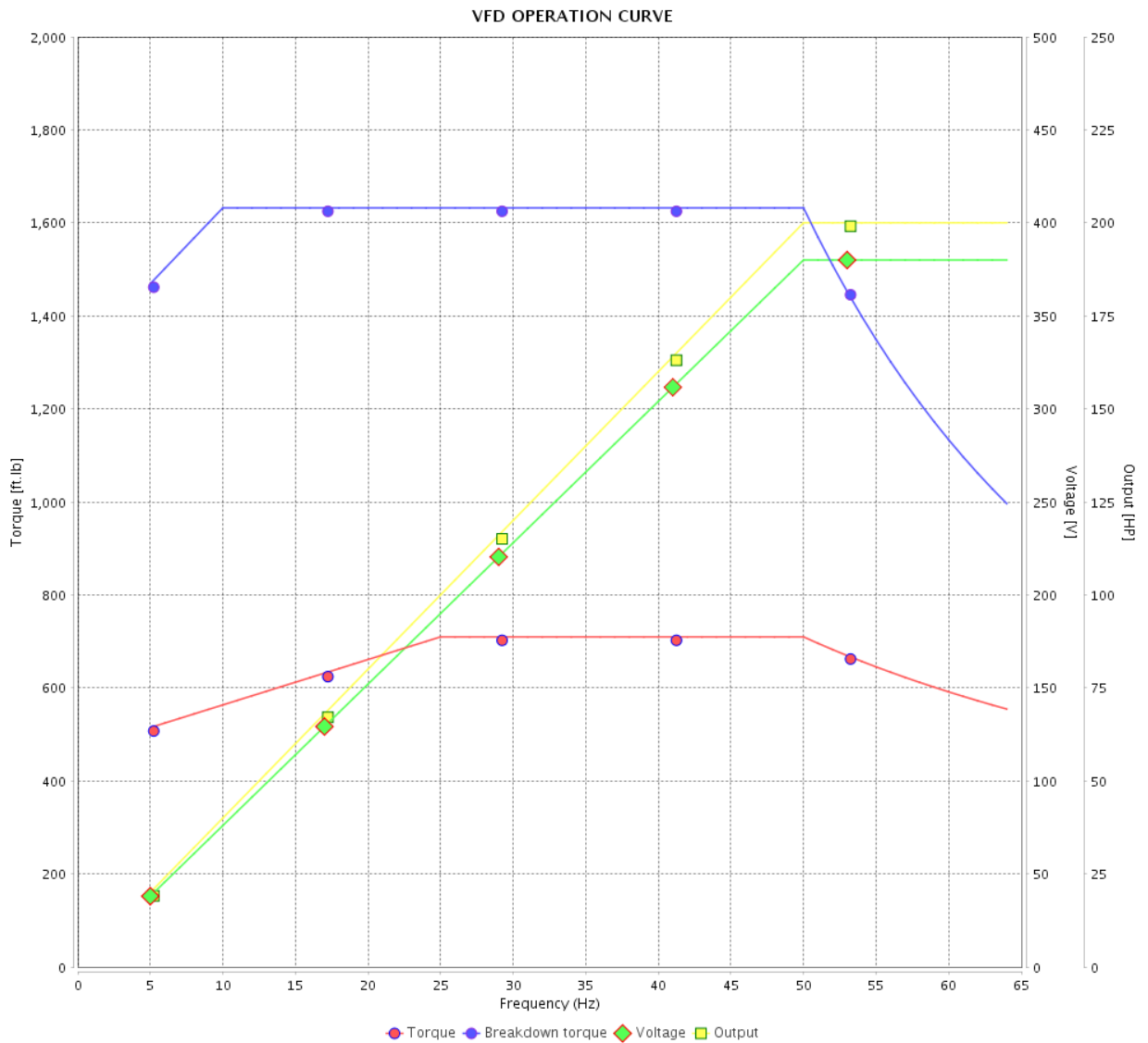

Performance : 380 V 50 Hz 4P IE3

Rated current : 273 A
 LRC : 6.1
 Rated torque : 710 ft.lb
 Locked rotor torque : 200 %
 Breakdown torque : 229 %
 Rated speed : 1480 rpm

Moment of inertia (J) : 89.6 sq.ft.lb
 Duty cycle : Cont.(S1)
 Insulation class : F
 Service factor : 1.15
 Temperature rise : 80 K
 Design : B

Rev.	Changes Summary	Performed	Checked	Date
Performed by			Page 31 / 36	Revision
Checked by				
Date	13/04/2022			

VFD OPERATION CURVE

Three Phase Induction Motor - Squirrel Cage



Customer : _____

Product line : NEMA Premium Efficiency Three-Phase

Product code : 11432097

Catalog # : 25018ST3QIE449T-W22

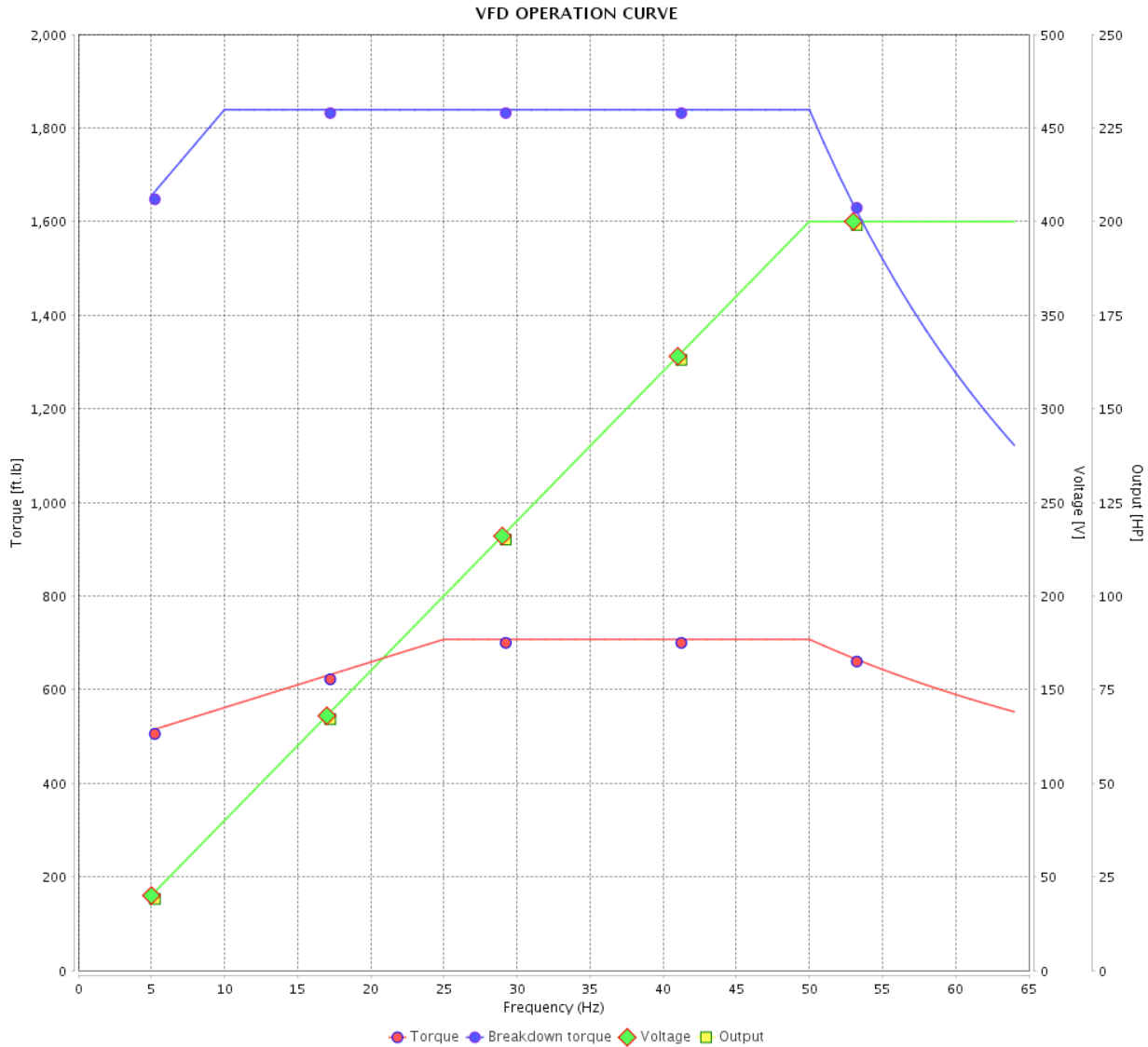

Performance : 400 V 50 Hz 4P IE3

Rated current	: 263 A	Moment of inertia (J)	: 89.6 sq.ft.lb
LRC	: 6.8	Duty cycle	: Cont.(S1)
Rated torque	: 707 ft.lb	Insulation class	: F
Locked rotor torque	: 260 %	Service factor	: 1.15
Breakdown torque	: 260 %	Temperature rise	: 80 K
Rated speed	: 1485 rpm	Design	: B

Rev.	Changes Summary	Performed	Checked	Date
Performed by			Page 32 / 36	Revision
Checked by				
Date	13/04/2022			

VFD OPERATION CURVE

Three Phase Induction Motor - Squirrel Cage



Customer :

Product line : NEMA Premium Efficiency Three-Phase
 Product code : 11432097
 Catalog # : 25018ST3QIE449T-W22

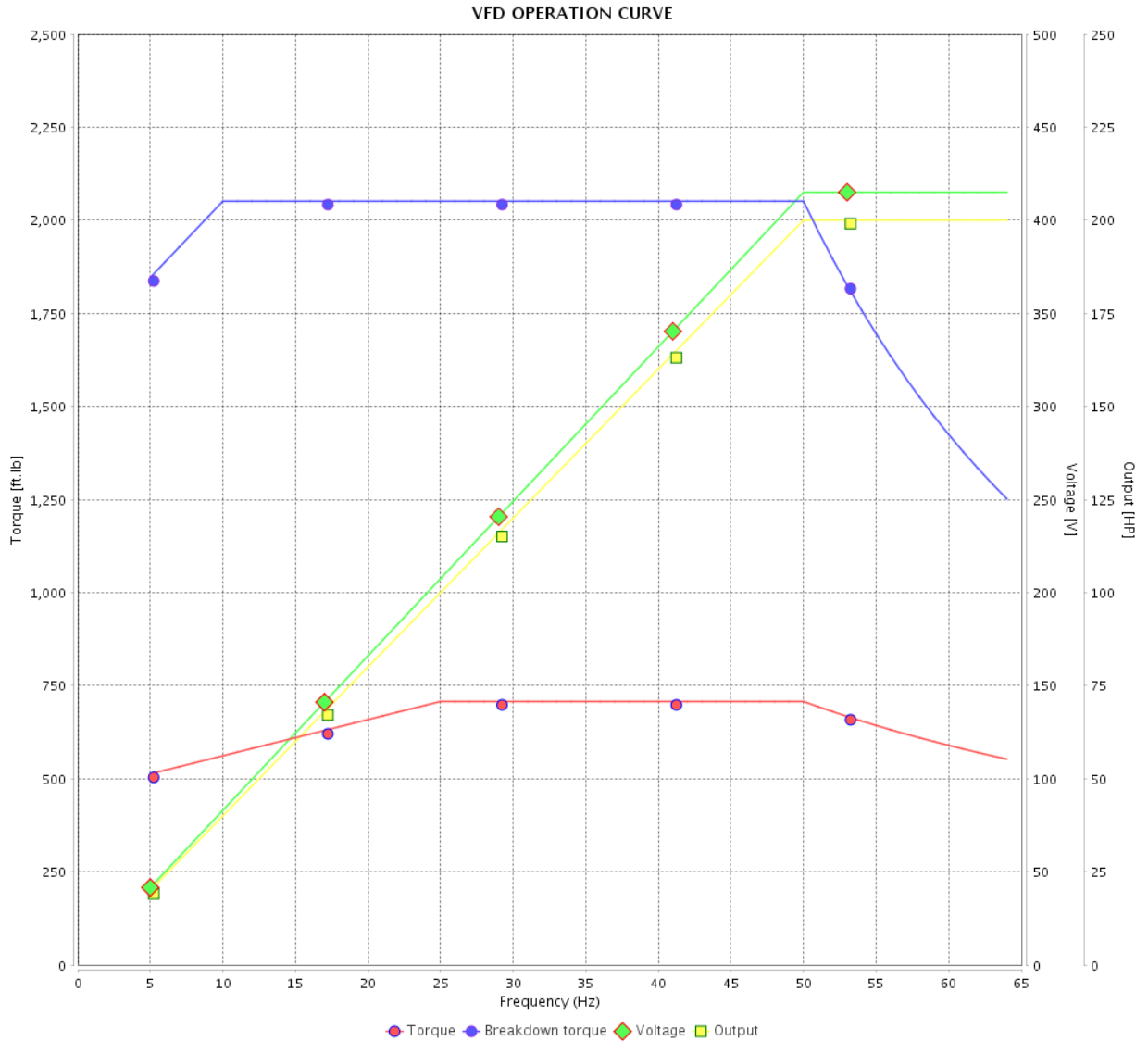

Performance : 415 V 50 Hz 4P IE3

Rated current : 256 A	Moment of inertia (J) : 89.6 sq.ft.lb
LRC : 7.4	Duty cycle : Cont.(S1)
Rated torque : 707 ft.lb	Insulation class : F
Locked rotor torque : 290 %	Service factor : 1.15
Breakdown torque : 290 %	Temperature rise : 80 K
Rated speed : 1485 rpm	Design : B

Rev.	Changes Summary	Performed	Checked	Date
Performed by			Page	Revision
Checked by				
Date				

VFD OPERATION CURVE

Three Phase Induction Motor - Squirrel Cage



Customer :

Product line : NEMA Premium Efficiency Three-Phase

Product code : 11432097

Catalog # : 25018ST3QIE449T-W22

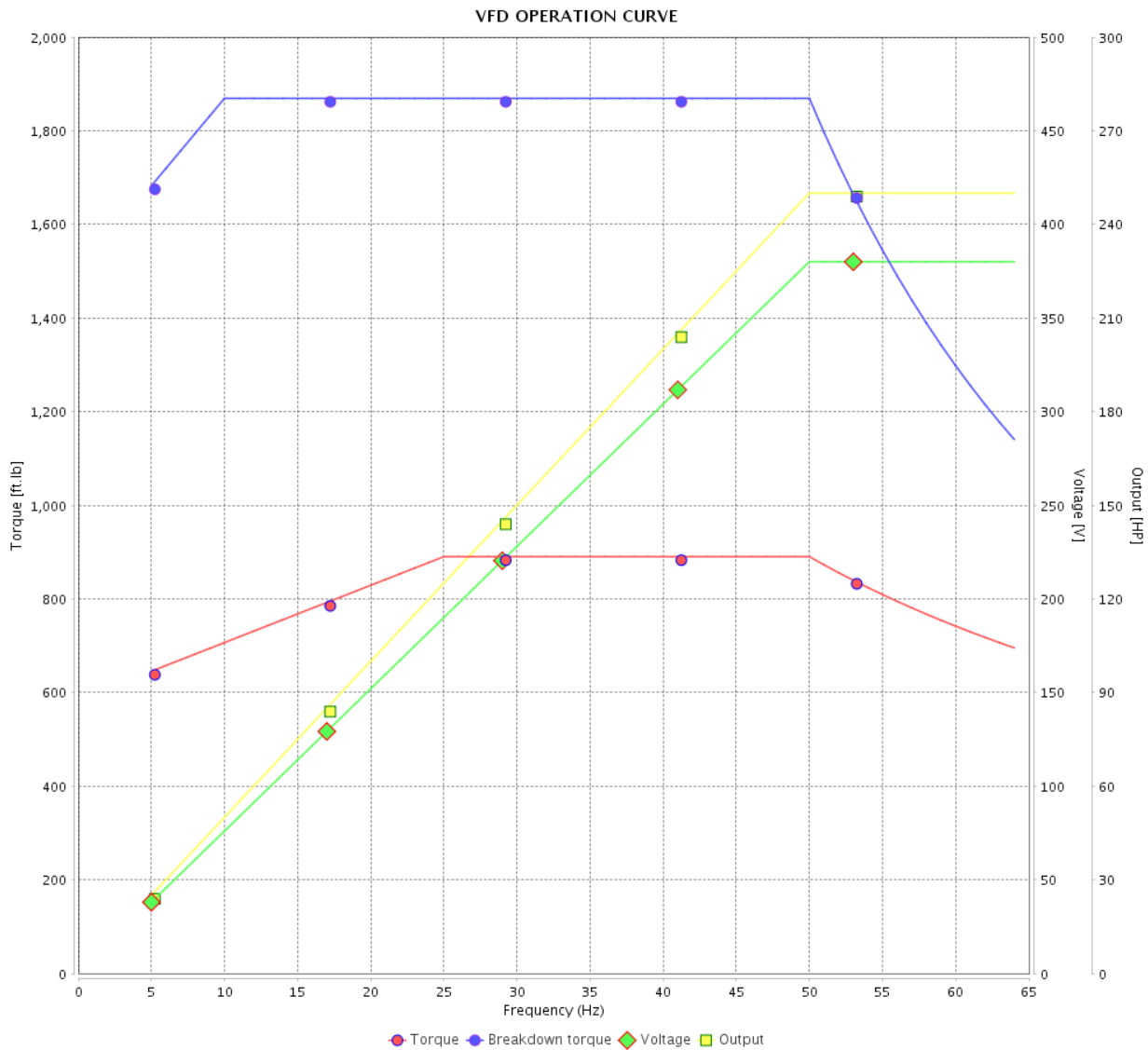

Performance : 380 V 50 Hz 4P IE1

Rated current	: 342 A	Moment of inertia (J)	: 89.6 sq.ft.lb
LRC	: 5.1	Duty cycle	: Cont.(S1)
Rated torque	: 890 ft.lb	Insulation class	: F
Locked rotor torque	: 180 %	Service factor	: 1.00
Breakdown torque	: 210 %	Temperature rise	: 105 K
Rated speed	: 1475 rpm	Design	: B

Rev.	Changes Summary	Performed	Checked	Date
Performed by			Page 34 / 36	Revision
Checked by				
Date	13/04/2022			

VFD OPERATION CURVE

Three Phase Induction Motor - Squirrel Cage



Customer :

Product line : NEMA Premium Efficiency Three-Phase

Product code : 11432097

Catalog # : 25018ST3QIE449T-W22

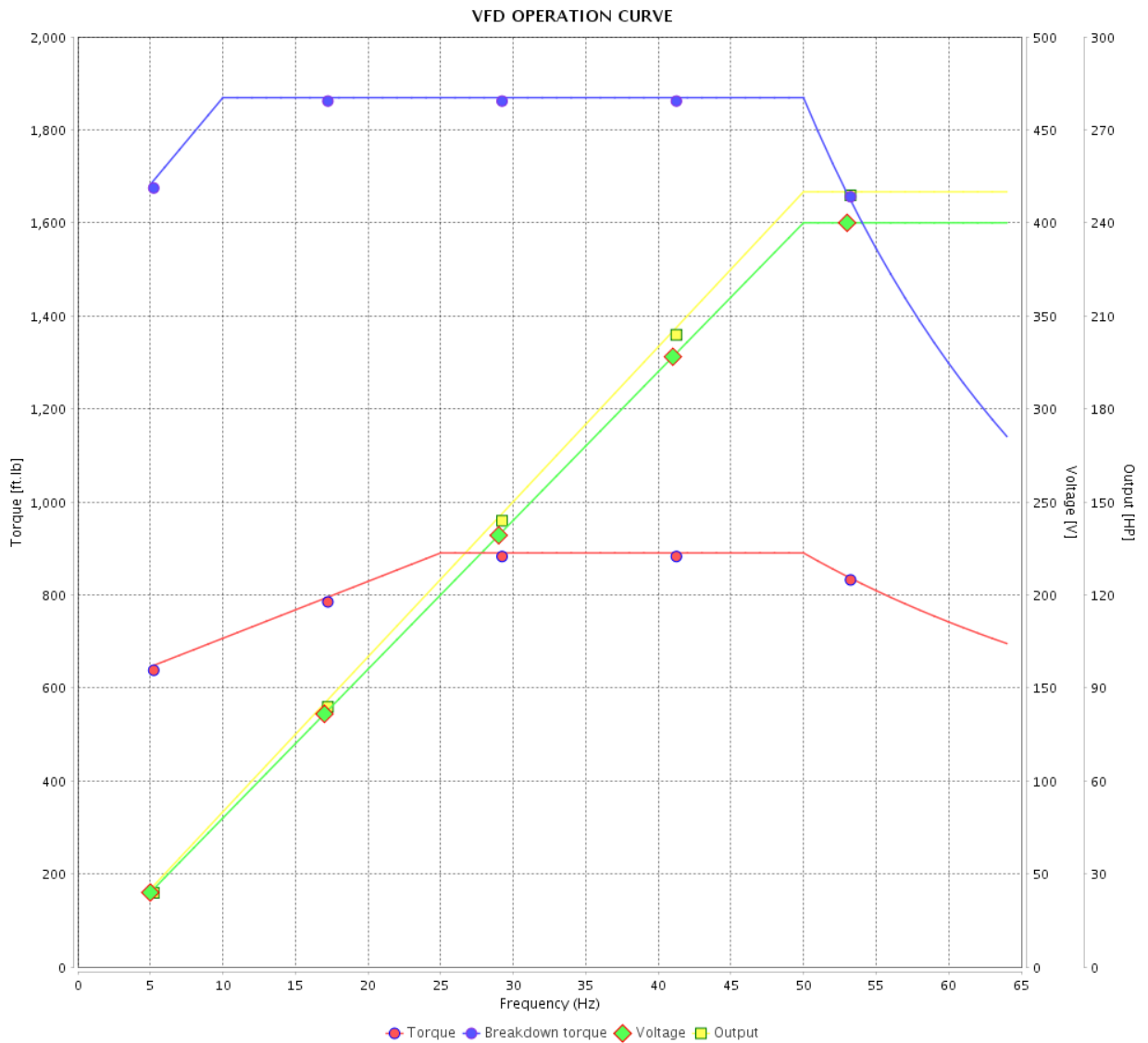

Performance : 400 V 50 Hz 4P IE1

Rated current : 323 A
 LRC : 5.7
 Rated torque : 890 ft.lb
 Locked rotor torque : 200 %
 Breakdown torque : 210 %
 Rated speed : 1475 rpm

Moment of inertia (J) : 89.6 sq.ft.lb
 Duty cycle : Cont.(S1)
 Insulation class : F
 Service factor : 1.00
 Temperature rise : 105 K
 Design : B

Rev.	Changes Summary	Performed	Checked	Date
Performed by			Page 35 / 36	Revision
Checked by				
Date	13/04/2022			

VFD OPERATION CURVE

Three Phase Induction Motor - Squirrel Cage



Customer : _____

Product line : NEMA Premium Efficiency Three-Phase

Product code : 11432097

Catalog # : 25018ST3QIE449T-W22

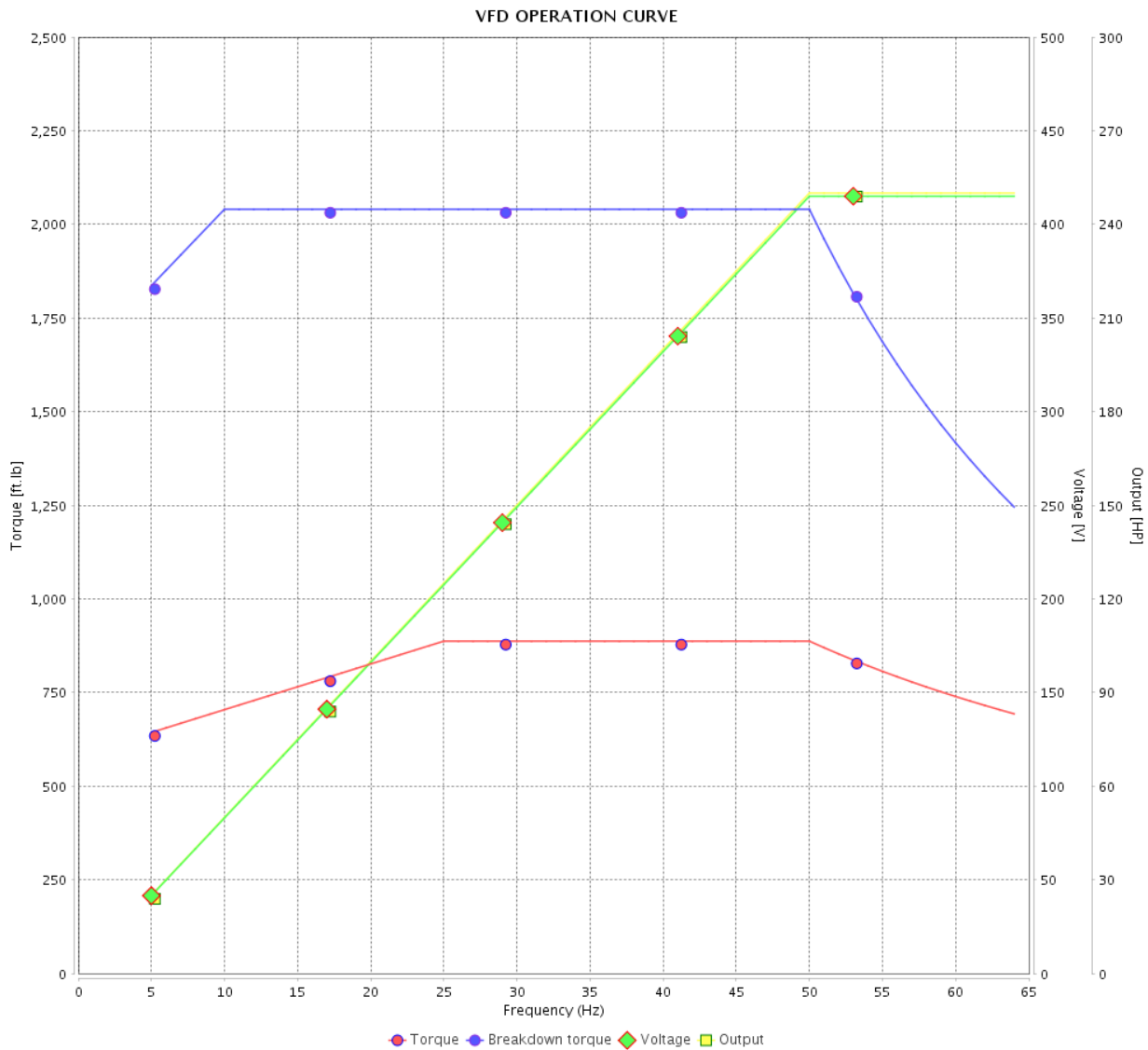

Performance : 415 V 50 Hz 4P IE2

Rated current	: 314 A	Moment of inertia (J)	: 89.6 sq.ft.lb
LRC	: 6.1	Duty cycle	: Cont.(S1)
Rated torque	: 887 ft.lb	Insulation class	: F
Locked rotor torque	: 220 %	Service factor	: 1.00
Breakdown torque	: 229 %	Temperature rise	: 105 K
Rated speed	: 1480 rpm	Design	: B

Rev.	Changes Summary	Performed	Checked	Date
Performed by			Page	Revision
Checked by				
Date				

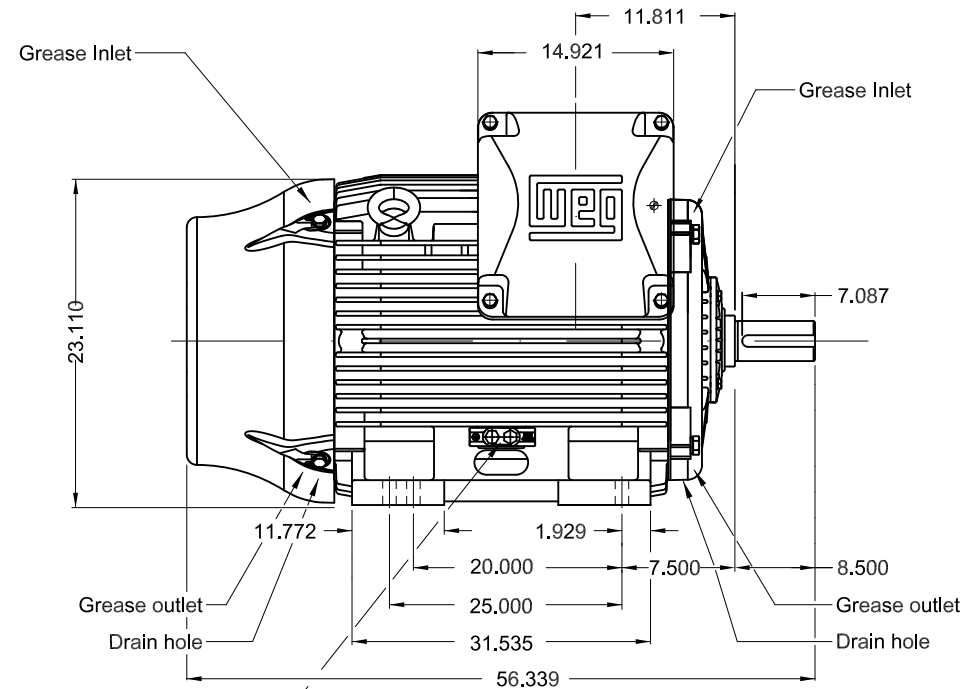
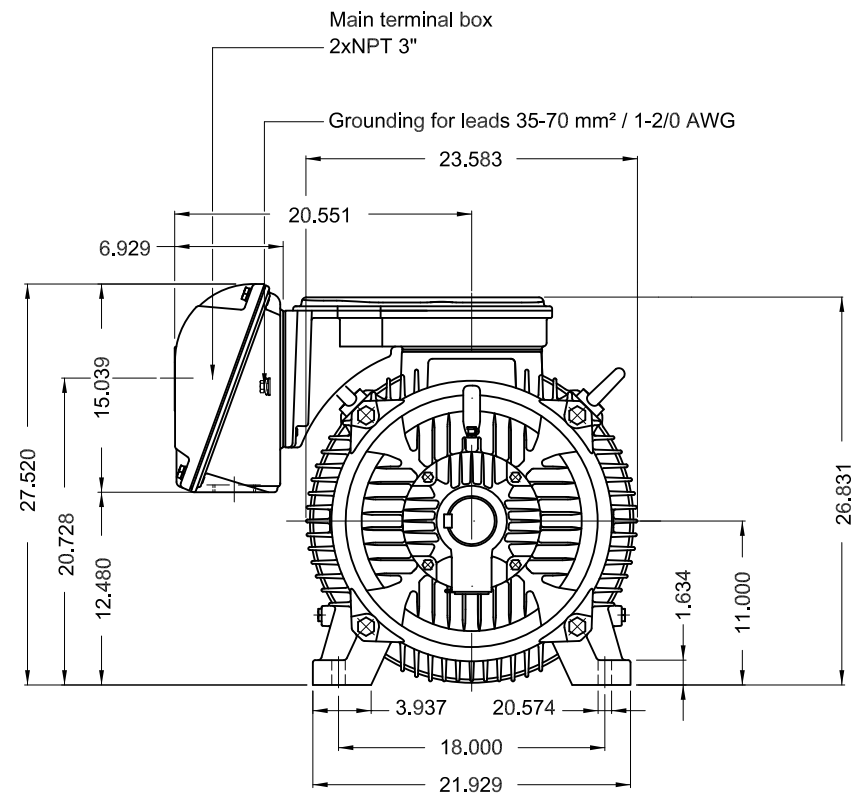

Grounding for leads 25-185 mm² / 3AWG-350MCM

250 HP 04 Poles 60 Hz

A

Without vertical jackscrews
 Color RAL 5009
 Painting plan 202E
 Mounting B3R(D)

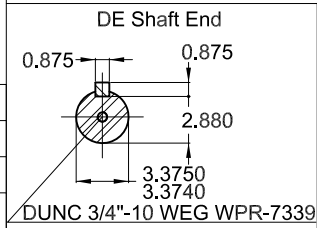

ECM	LOC	SUMMARY OF MODIFICATIONS	EXECUTED	CHECKED	RELEASED	DATE	VER
EXECUTED	PIRWUSER	THREE PH. MOTOR IEEE 841 W22 PREM. EFF.					
CHECKED		FRAME 447/9T IP55 TEFC					
RELEASED							
REL DT.	WMO	Jaragua do Sul	Product Engineering	SHEET	1 / 1		

PREVIEW
 WDD





NEMA
Premium
W22



FOR SAFE AREA
Mod.TE1BFOXON
CC029A



Class I, Div 2, Gr A, B, C and D - T3
Class I, Zone 2, IIC - T3
Class II, Div 2, Gr F and G - T3C
For use on PWM: Gr. A, B, C, D and F,
VT 1000:1, CT 20:1, 1.00SF - T3

MODEL 25018ST3QIE449T-W22



Inverter Duty Motor
Severe Duty

MADE IN BRAZIL
11432097

PH3 60Hz Fr. 447/9T 1000m.a.s.l. IP55 TEFC 2841lb

V 460

A 281

HP 250

kW 185

SF 1.15

SFA 323

RPM 1780

PF 0.86

AMB 40°C

INS cl. F DT80K

NEMA NOM EFF 96.2%

DUTY CONT.

DES B Code G

GUARANT. EFF 95.4%

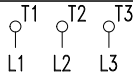

460V



→ 6322-C3 (60g) 110BC03X30

→ 6319-C3 (45g) 95BC03X30



MOBIL POLYREX EM (6000h)

