

DATA SHEET

Three Phase Induction Motor - Squirrel Cage



Customer								
Product line	: NEMA Premium Efficiency Three-Phase	Product code	: 11432185					
		Catalog #	: 25036ST3QIE449TS-W22					
Frame	: 447/9TS	Cooling method	: IC411 - TEFC					
Insulation class	: F	Mounting	: F-1					
Duty cycle	: Cont.(S1)	Rotation ¹	: Both (CW and CCW)					
Ambient temperature	: -20°C to +40°C	Starting method	: Direct On Line					
Altitude	: 1000 m.a.s.l.	Approx. weight ²	: 2543 lb					
Protection degree	: IP55	Moment of inertia (J)	: 50.3 sq.ft.lb					
Design	: B							
Output [HP]	250	200	200	200	250	250	250	
Poles	2	2	2	2	2	2	2	
Frequency [Hz]	60	50	50	50	50	50	50	
Rated voltage [V]	460	380	400	415	380	400	415	
Rated current [A]	269	265	252	245	330	312	300	
L. R. Amperes [A]	1802	1511	1638	1740	1749	1810	1920	
LRC [A]	6.7x(Code G)	5.7x(Code E)	6.5x(Code G)	7.1x(Code G)	5.3x(Code E)	5.8x(Code F)	6.4x(Code F)	
No load current [A]	62.0	60.0	65.0	70.0	61.0	65.0	70.0	
Rated speed [RPM]	3573	2973	2977	2979	2962	2967	2970	
Slip [%]	0.75	0.90	0.77	0.70	1.27	1.10	1.00	
Rated torque [ft.lb]	367	353	353	353	443	442	442	
Locked rotor torque [%]	200	190	210	220	150	160	180	
Breakdown torque [%]	240	240	270	300	190	220	229	
Service factor	1.15	1.15	1.15	1.15	1.00	1.00	1.00	
Temperature rise	80 K	105 K	80 K	80 K	105 K	105 K	105 K	
Locked rotor time	32s (cold) 18s (hot)	48s (cold) 27s (hot)	45s (cold) 25s (hot)	41s (cold) 23s (hot)	21s (cold) 12s (hot)	21s (cold) 12s (hot)	21s (cold) 12s (hot)	
Noise level ²	81.0 dB(A)							
Efficiency (%)	25%	95.3	94.9	95.0	95.0	95.8	95.7	95.6
	50%	95.4	95.0	95.1	95.1	95.4	95.4	95.4
	75%	95.8	95.6	95.6	95.6	95.0	95.4	95.8
	100%	95.8	95.6	95.6	95.6	94.5	95.0	95.4
Power Factor	25%	0.62	0.62	0.58	0.55	0.67	0.64	0.61
	50%	0.84	0.84	0.82	0.80	0.87	0.85	0.84
	75%	0.89	0.89	0.88	0.87	0.90	0.89	0.89
	100%	0.90	0.90	0.90	0.89	0.90	0.90	0.90
Bearing type	: 6314 C3	6314 C3	Foundation loads					
Sealing	: Inpro/Seal	Inpro/Seal	Max. traction	: 1438 lb				
Lubrication interval	: 4000 h	4000 h	Max. compression	: 3981 lb				
Lubricant amount	: 27 g	27 g						
Lubricant type	: Mobil Polyrex EM							
Notes								
This revision replaces and cancel the previous one, which must be eliminated. (1) Looking the motor from the shaft end. (2) Measured at 1m and with tolerance of +3dB(A). (3) Approximate weight subject to changes after manufacturing process. (4) At 100% of full load.				These are average values based on tests with sinusoidal power supply, subject to the tolerances stipulated in NEMA MG-1.				
Rev.	Changes Summary			Performed	Checked	Date		
Performed by								
Checked by					Page	Revision		
Date	13/04/2022				1 / 36			

TORQUE AND CURRENT VS SPEED CURVE

Three Phase Induction Motor - Squirrel Cage



Customer :

Product line : NEMA Premium Efficiency Three-Phase

Product code : 11432185

Catalog # : 25036ST3QIE449TS-W22

TORQUE AND CURRENT VS SPEED CURVE

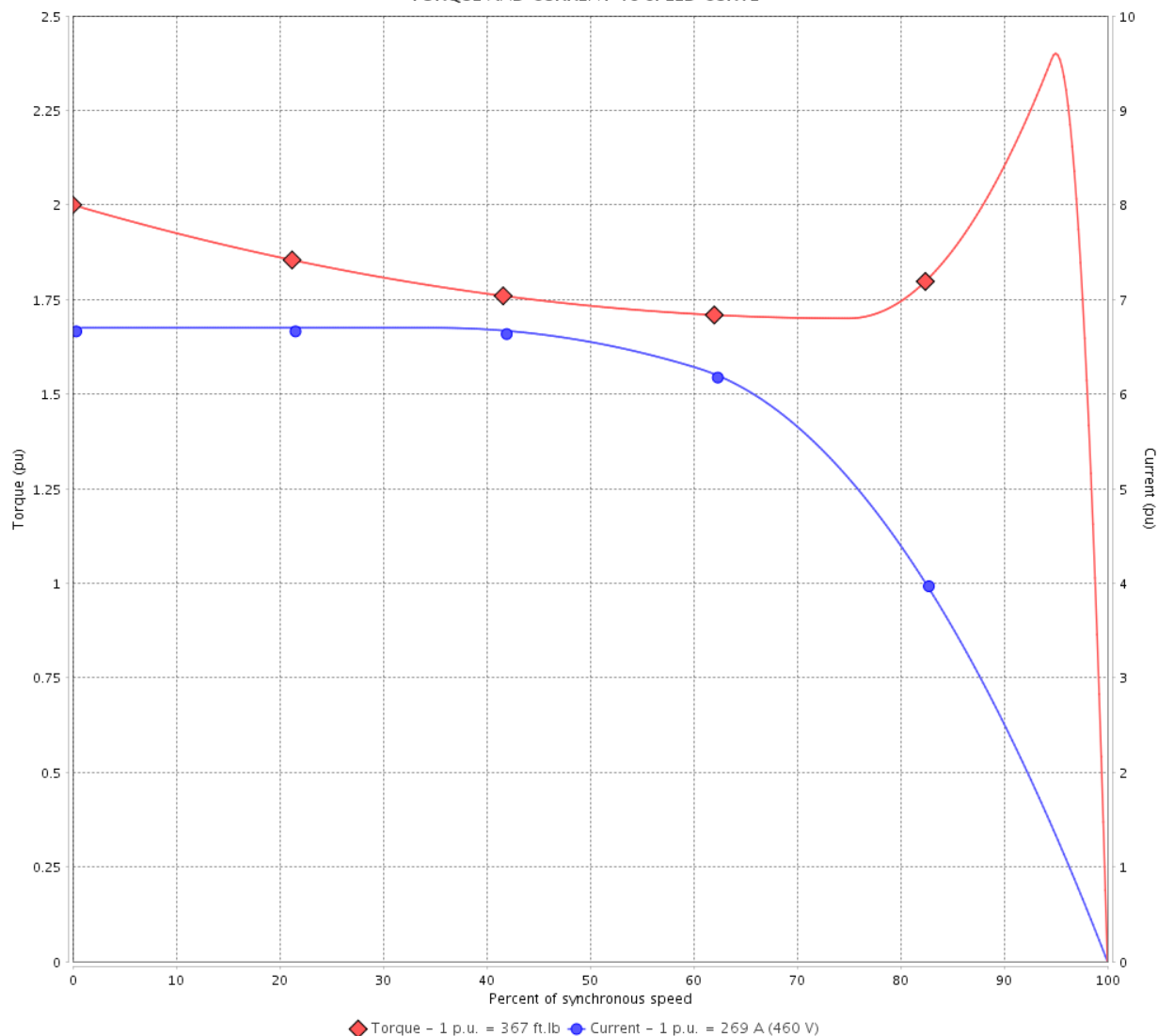

Performance : 460 V 60 Hz 2P

Rated current	: 269 A	Moment of inertia (J)	: 50.3 sq.ft.lb
LRC	: 6.7	Duty cycle	: Cont.(S1)
Rated torque	: 367 ft.lb	Insulation class	: F
Locked rotor torque	: 200 %	Service factor	: 1.15
Breakdown torque	: 240 %	Temperature rise	: 80 K
Rated speed	: 3573 rpm	Design	: B

Locked rotor time : 32s (cold) 18s (hot)

Rev.	Changes Summary	Performed	Checked	Date
Performed by			Page 2 / 36	Revision
Checked by				
Date	13/04/2022			

TORQUE AND CURRENT VS SPEED CURVE



Three Phase Induction Motor - Squirrel Cage

Customer :

Product line : NEMA Premium Efficiency Three-Phase

Product code : 11432185

Catalog # : 25036ST3QIE449TS-W22

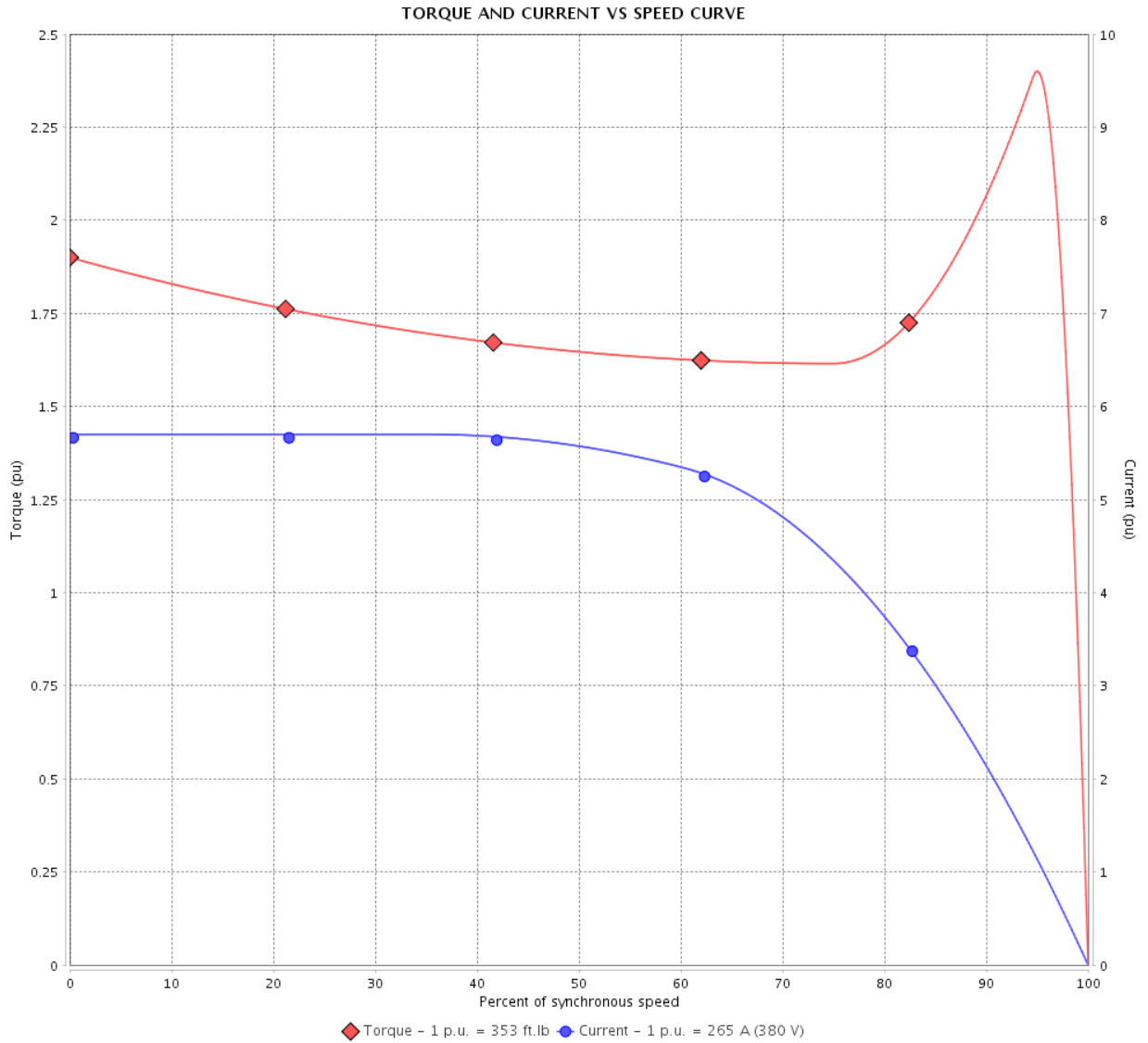

Performance : 380 V 50 Hz 2P IE3

Rated current	: 265 A	Moment of inertia (J)	: 50.3 sq.ft.lb
LRC	: 5.7	Duty cycle	: Cont.(S1)
Rated torque	: 353 ft.lb	Insulation class	: F
Locked rotor torque	: 190 %	Service factor	: 1.15
Breakdown torque	: 240 %	Temperature rise	: 105 K
Rated speed	: 2973 rpm	Design	: B

Locked rotor time : 48s (cold) 27s (hot)

Rev.	Changes Summary	Performed	Checked	Date
Performed by			Page 3 / 36	Revision
Checked by				
Date	13/04/2022			

TORQUE AND CURRENT VS SPEED CURVE

Three Phase Induction Motor - Squirrel Cage



Customer :

Product line : NEMA Premium Efficiency Three-Phase

Product code : 11432185

Catalog # : 25036ST3QIE449TS-W22

TORQUE AND CURRENT VS SPEED CURVE

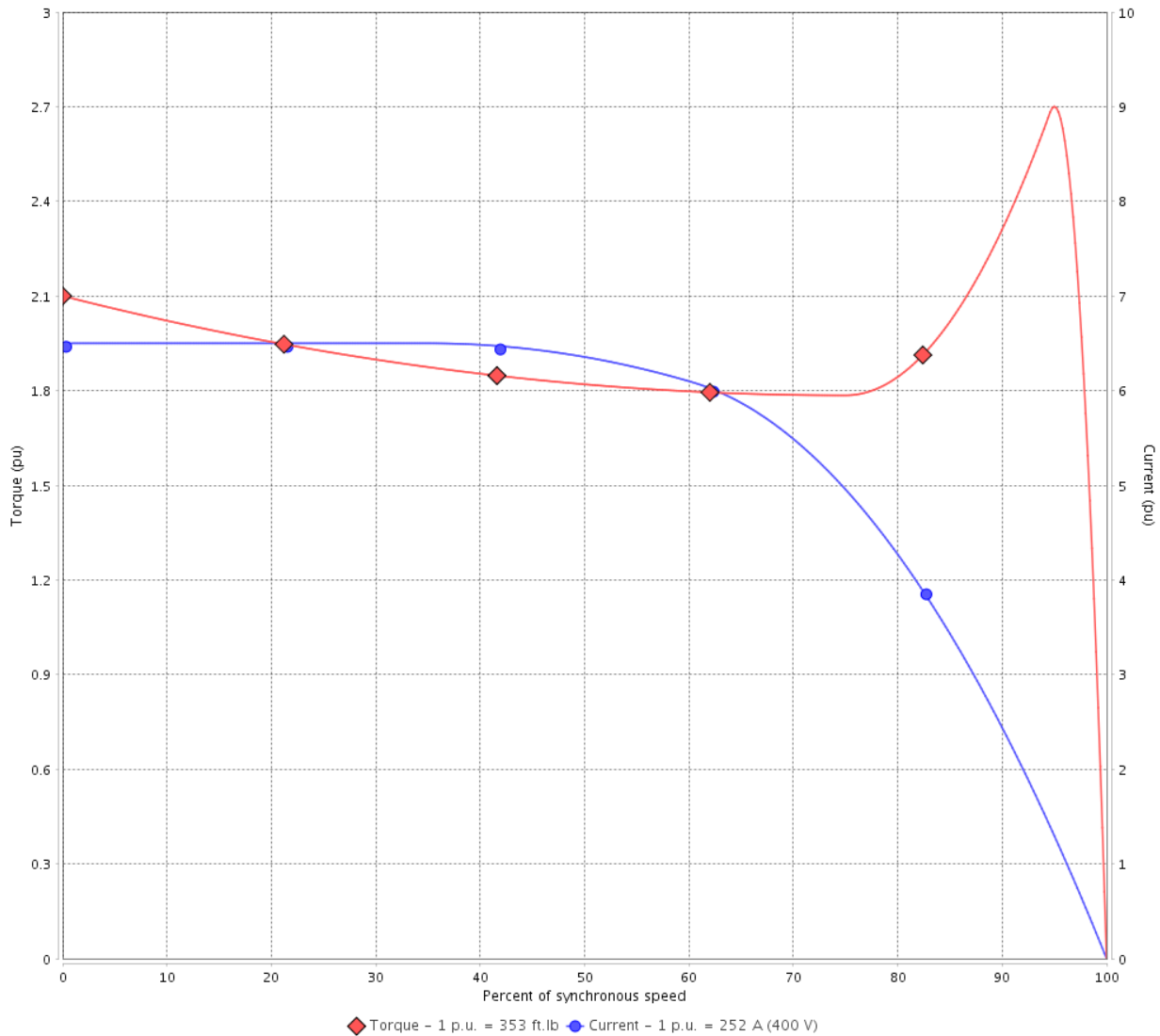

Performance : 400 V 50 Hz 2P IE3

Rated current	: 252 A	Moment of inertia (J)	: 50.3 sq.ft.lb
LRC	: 6.5	Duty cycle	: Cont.(S1)
Rated torque	: 353 ft.lb	Insulation class	: F
Locked rotor torque	: 210 %	Service factor	: 1.15
Breakdown torque	: 270 %	Temperature rise	: 80 K
Rated speed	: 2977 rpm	Design	: B

Locked rotor time : 45s (cold) 25s (hot)

Rev.	Changes Summary	Performed	Checked	Date
Performed by			Page 4 / 36	Revision
Checked by				
Date	13/04/2022			

TORQUE AND CURRENT VS SPEED CURVE



Three Phase Induction Motor - Squirrel Cage

Customer :

Product line : NEMA Premium Efficiency Three-Phase

Product code : 11432185

Catalog # : 25036ST3QIE449TS-W22

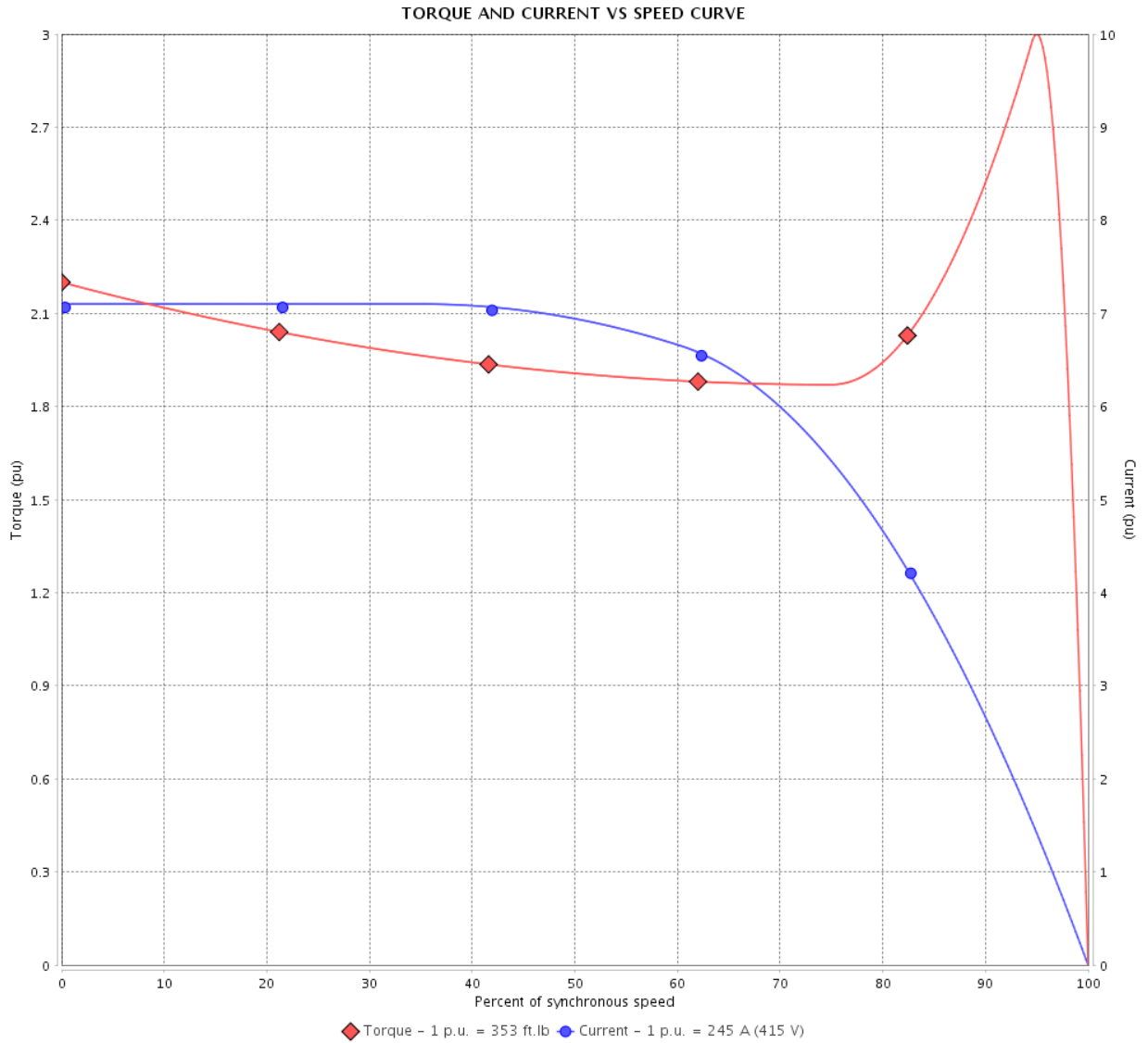

Performance : 415 V 50 Hz 2P IE3

Rated current	: 245 A	Moment of inertia (J)	: 50.3 sq.ft.lb
LRC	: 7.1	Duty cycle	: Cont.(S1)
Rated torque	: 353 ft.lb	Insulation class	: F
Locked rotor torque	: 220 %	Service factor	: 1.15
Breakdown torque	: 300 %	Temperature rise	: 80 K
Rated speed	: 2979 rpm	Design	: B

Locked rotor time : 41s (cold) 23s (hot)

Rev.	Changes Summary	Performed	Checked	Date
Performed by			Page 5 / 36	Revision
Checked by				
Date	13/04/2022			

TORQUE AND CURRENT VS SPEED CURVE

Three Phase Induction Motor - Squirrel Cage



Customer :

Product line : NEMA Premium Efficiency Three-Phase

Product code : 11432185

Catalog # : 25036ST3QIE449TS-W22

TORQUE AND CURRENT VS SPEED CURVE

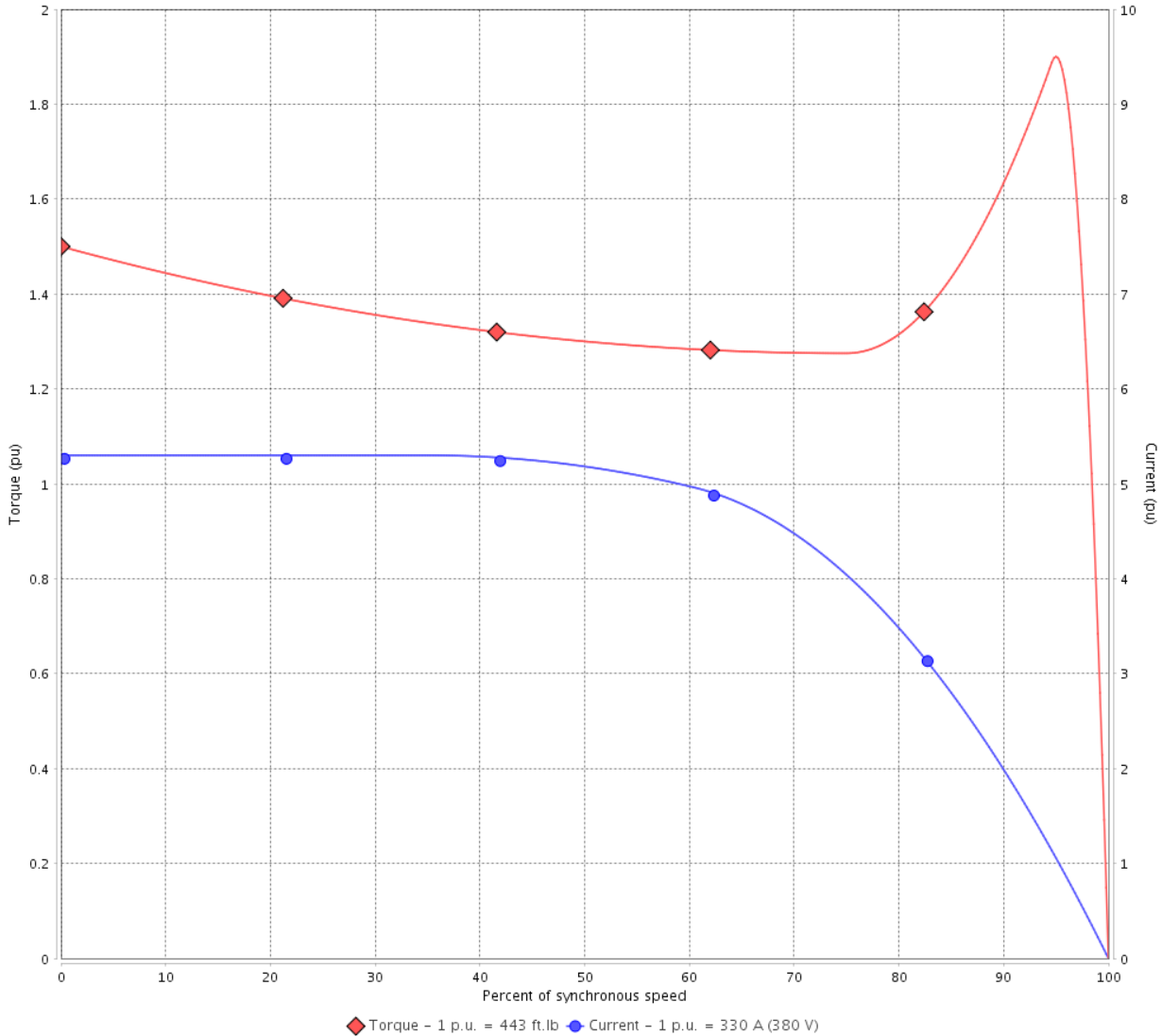

Performance : 380 V 50 Hz 2P IE1

Rated current	: 330 A	Moment of inertia (J)	: 50.3 sq.ft.lb
LRC	: 5.3	Duty cycle	: Cont.(S1)
Rated torque	: 443 ft.lb	Insulation class	: F
Locked rotor torque	: 150 %	Service factor	: 1.00
Breakdown torque	: 190 %	Temperature rise	: 105 K
Rated speed	: 2962 rpm	Design	: B

Locked rotor time : 21s (cold) 12s (hot)

Rev.	Changes Summary	Performed	Checked	Date
Performed by			Page 6 / 36	Revision
Checked by				
Date	13/04/2022			

TORQUE AND CURRENT VS SPEED CURVE



Three Phase Induction Motor - Squirrel Cage

Customer :

Product line : NEMA Premium Efficiency Three-Phase

Product code : 11432185

Catalog # : 25036ST3QIE449TS-W22

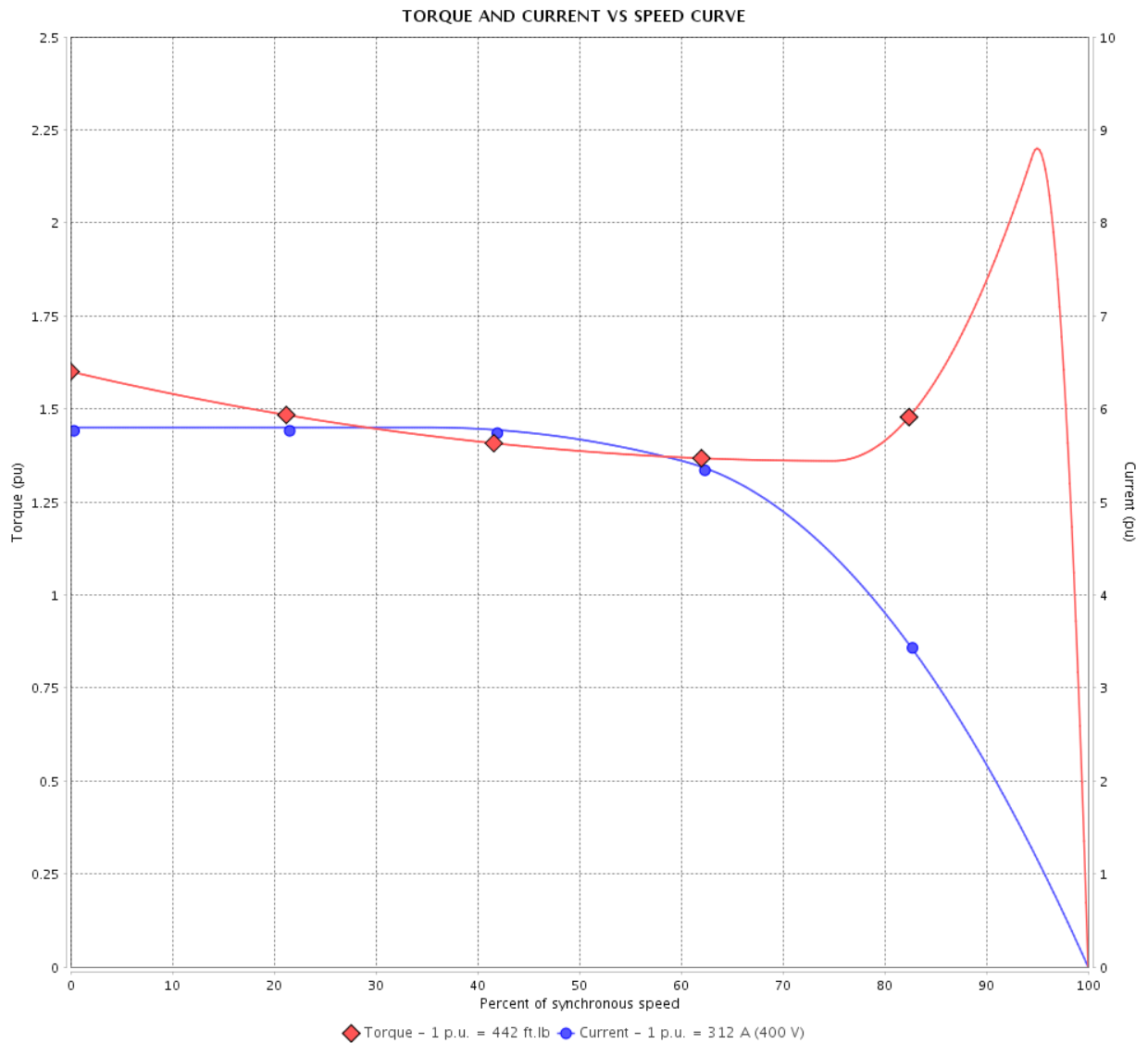

Performance : 400 V 50 Hz 2P IE2

Rated current	: 312 A	Moment of inertia (J)	: 50.3 sq.ft.lb
LRC	: 5.8	Duty cycle	: Cont.(S1)
Rated torque	: 442 ft.lb	Insulation class	: F
Locked rotor torque	: 160 %	Service factor	: 1.00
Breakdown torque	: 220 %	Temperature rise	: 105 K
Rated speed	: 2967 rpm	Design	: B

Locked rotor time : 21s (cold) 12s (hot)

Rev.	Changes Summary	Performed	Checked	Date
Performed by			Page 7 / 36	Revision
Checked by				
Date	13/04/2022			

TORQUE AND CURRENT VS SPEED CURVE

Three Phase Induction Motor - Squirrel Cage

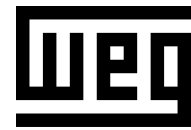

Customer :

Product line : NEMA Premium Efficiency Three-Phase

Product code : 11432185

Catalog # : 25036ST3QIE449TS-W22

TORQUE AND CURRENT VS SPEED CURVE

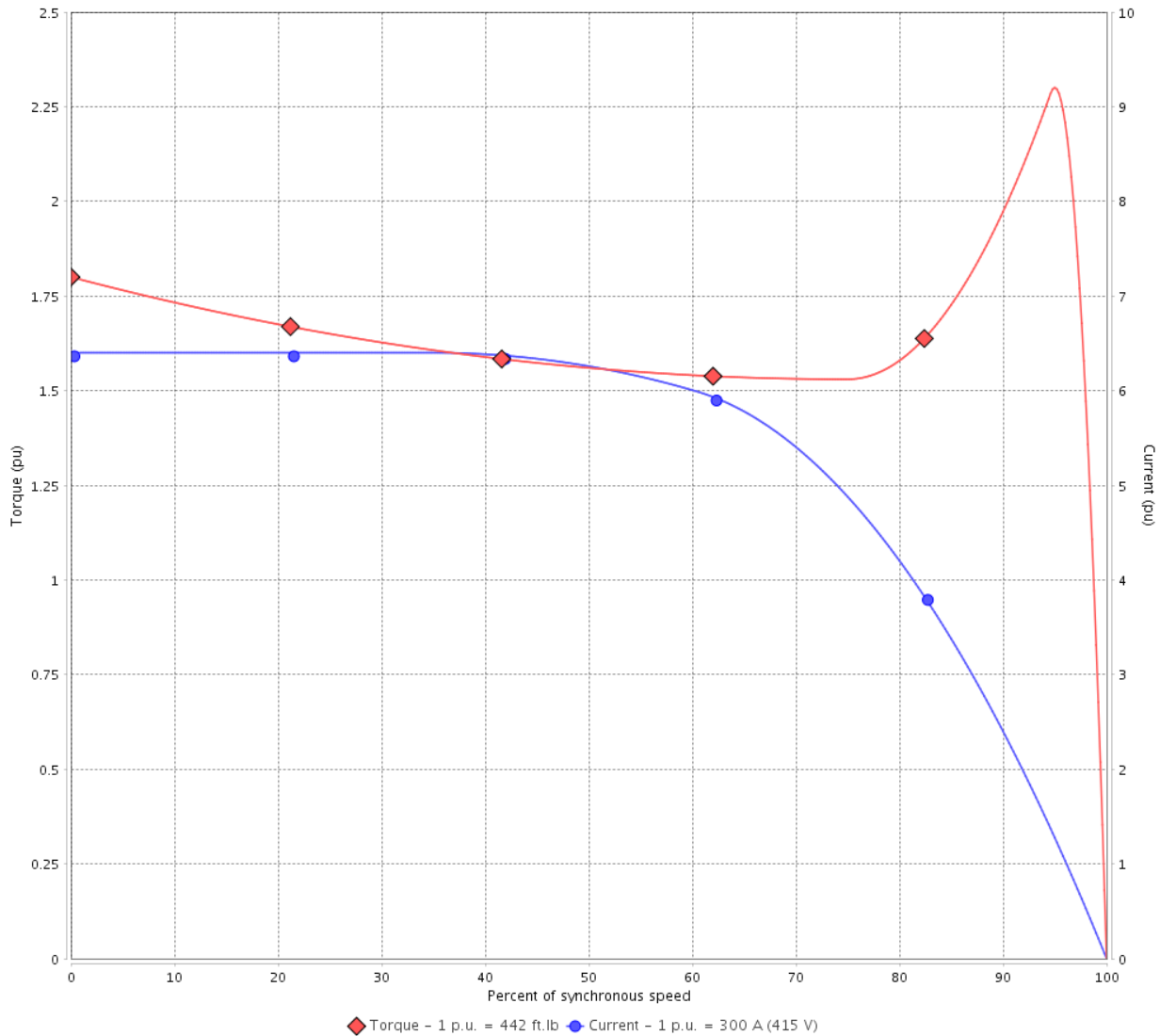

Performance : 415 V 50 Hz 2P IE2

Rated current	: 300 A	Moment of inertia (J)	: 50.3 sq.ft.lb
LRC	: 6.4	Duty cycle	: Cont.(S1)
Rated torque	: 442 ft.lb	Insulation class	: F
Locked rotor torque	: 180 %	Service factor	: 1.00
Breakdown torque	: 229 %	Temperature rise	: 105 K
Rated speed	: 2970 rpm	Design	: B

Locked rotor time : 21s (cold) 12s (hot)

Rev.	Changes Summary	Performed	Checked	Date
Performed by			Page 8 / 36	Revision
Checked by				
Date	13/04/2022			

LOAD PERFORMANCE CURVE

Three Phase Induction Motor - Squirrel Cage



Customer : _____

Product line : NEMA Premium Efficiency Three-Phase

Product code : 11432185

Catalog # : 25036ST3QIE449TS-W22

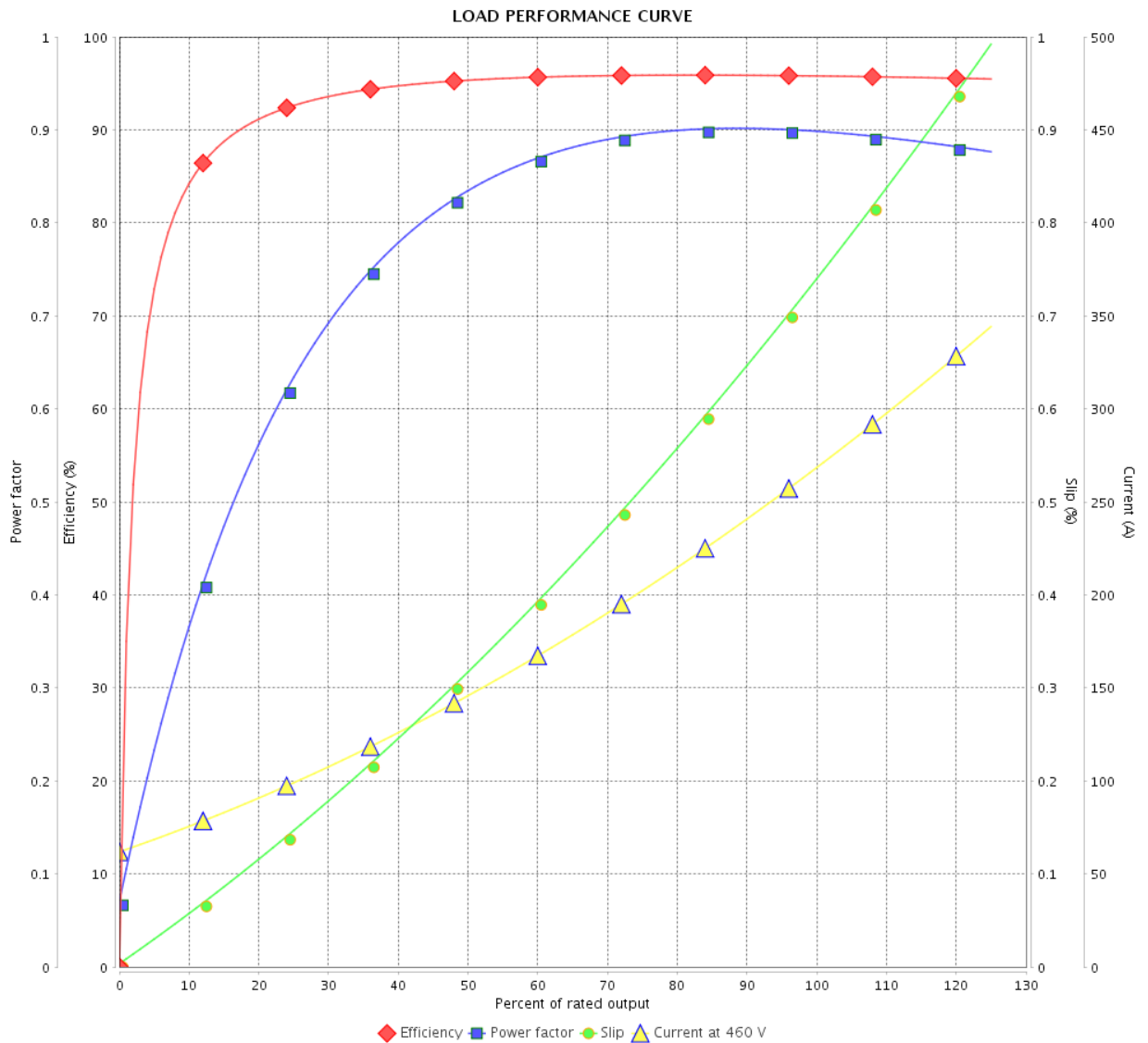

Performance : 460 V 60 Hz 2P

Rated current : 269 A
 LRC : 6.7
 Rated torque : 367 ft.lb
 Locked rotor torque : 200 %
 Breakdown torque : 240 %
 Rated speed : 3573 rpm

Moment of inertia (J) : 50.3 sq.ft.lb
 Duty cycle : Cont.(S1)
 Insulation class : F
 Service factor : 1.15
 Temperature rise : 80 K
 Design : B

Rev.	Changes Summary	Performed	Checked	Date
Performed by		Page		Revision
Checked by		9 / 36		
Date		13/04/2022		

LOAD PERFORMANCE CURVE

Three Phase Induction Motor - Squirrel Cage



Customer : _____

Product line : NEMA Premium Efficiency Three-Phase

Product code : 11432185

Catalog # : 25036ST3QIE449TS-W22

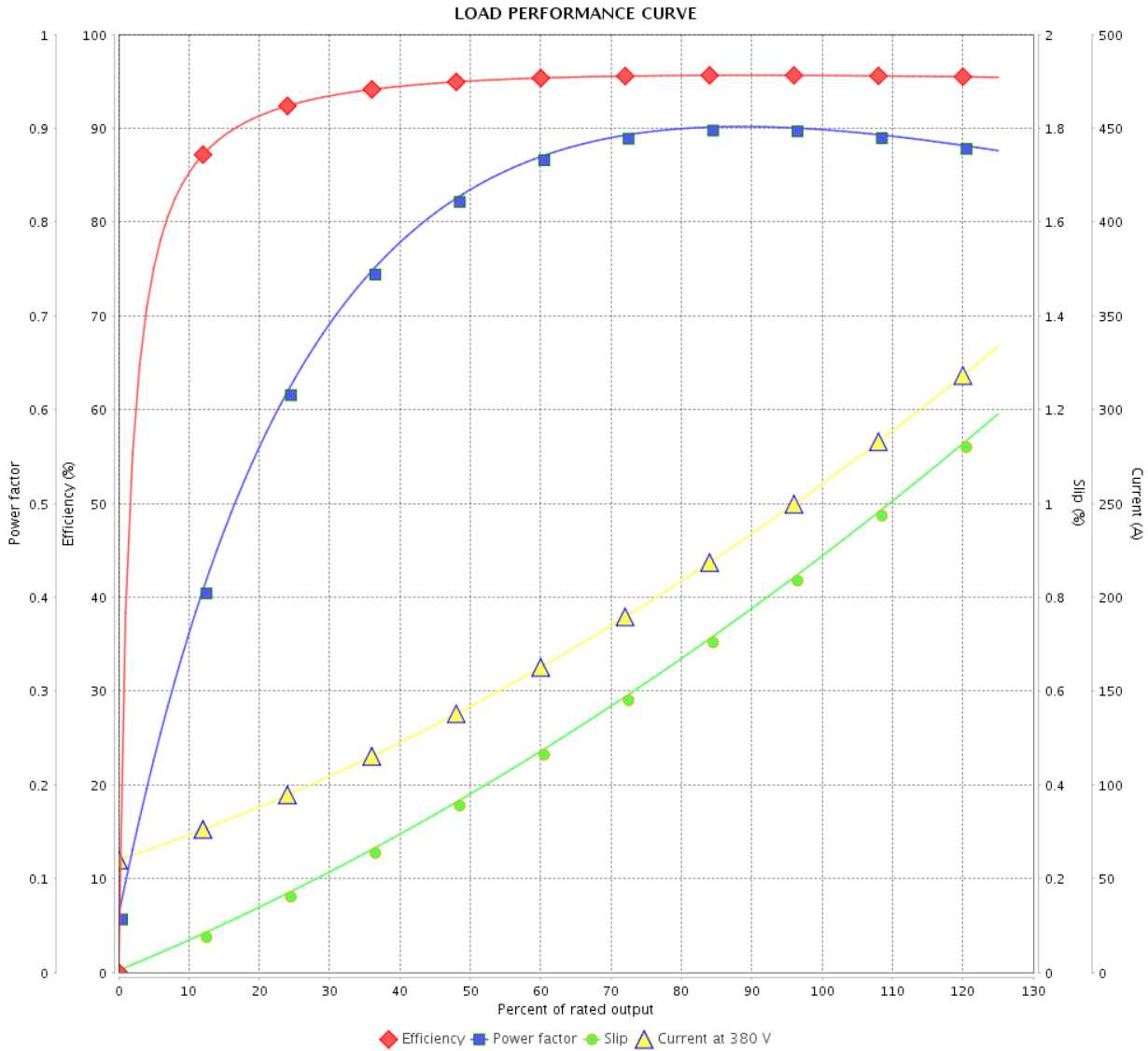

Performance : 380 V 50 Hz 2P IE3

Rated current : 265 A
 LRC : 5.7
 Rated torque : 353 ft.lb
 Locked rotor torque : 190 %
 Breakdown torque : 240 %
 Rated speed : 2973 rpm

Moment of inertia (J) : 50.3 sq.ft.lb
 Duty cycle : Cont.(S1)
 Insulation class : F
 Service factor : 1.15
 Temperature rise : 105 K
 Design : B

Rev.	Changes Summary	Performed	Checked	Date
Performed by				
Checked by				
Date				
		Page	Revision	
		10 / 36		

LOAD PERFORMANCE CURVE

Three Phase Induction Motor - Squirrel Cage



Customer : _____

Product line : NEMA Premium Efficiency Three-Phase

Product code : 11432185

Catalog # : 25036ST3QIE449TS-W22

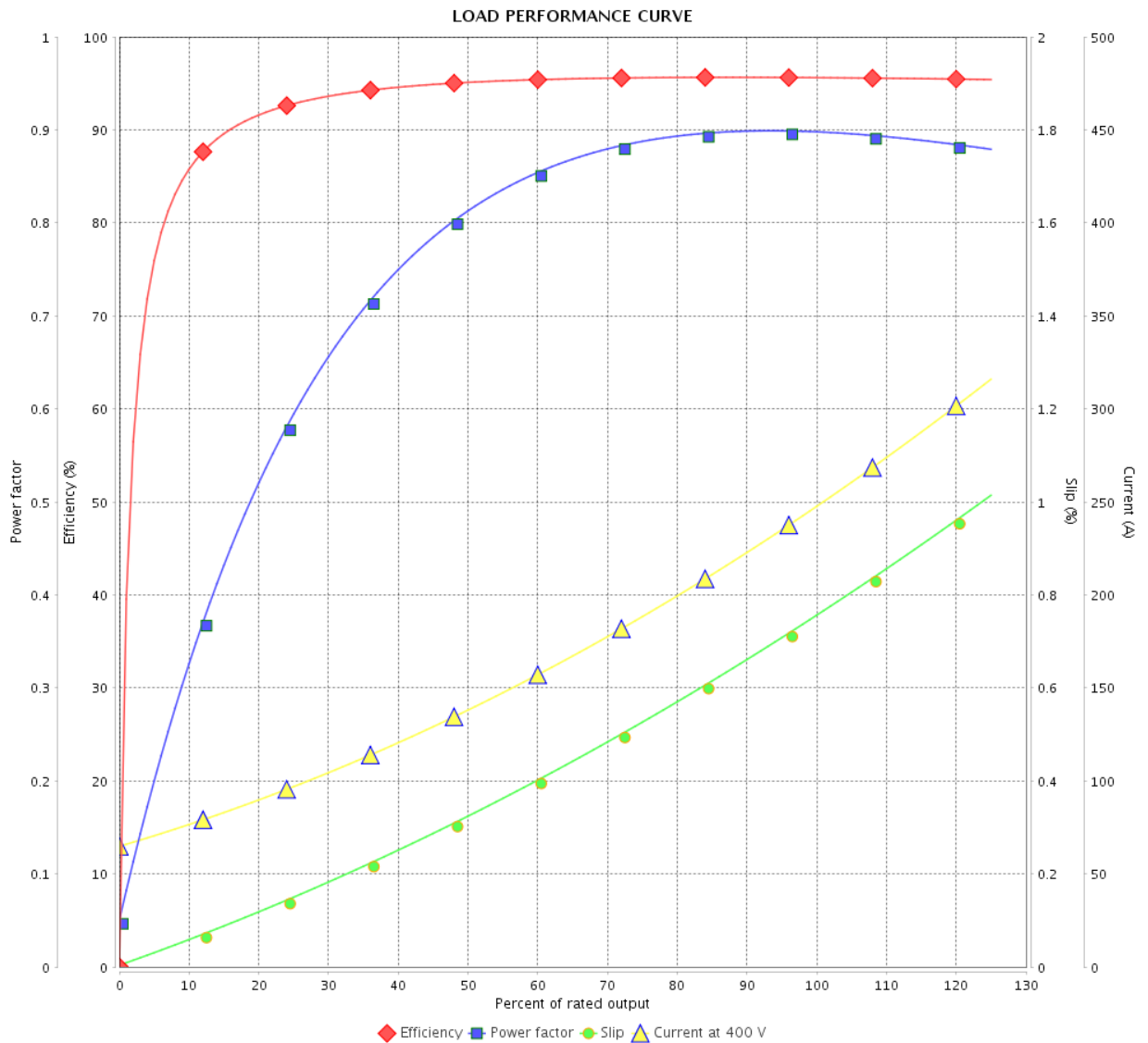

Performance : 400 V 50 Hz 2P IE3

Rated current : 252 A
 LRC : 6.5
 Rated torque : 353 ft.lb
 Locked rotor torque : 210 %
 Breakdown torque : 270 %
 Rated speed : 2977 rpm

Moment of inertia (J) : 50.3 sq.ft.lb
 Duty cycle : Cont.(S1)
 Insulation class : F
 Service factor : 1.15
 Temperature rise : 80 K
 Design : B

Rev.	Changes Summary	Performed	Checked	Date
Performed by			Page	Revision
Checked by				
Date				
			11 / 36	

LOAD PERFORMANCE CURVE

Three Phase Induction Motor - Squirrel Cage



Customer :

Product line : NEMA Premium Efficiency Three-Phase

Product code : 11432185

Catalog # : 25036ST3QIE449TS-W22

LOAD PERFORMANCE CURVE

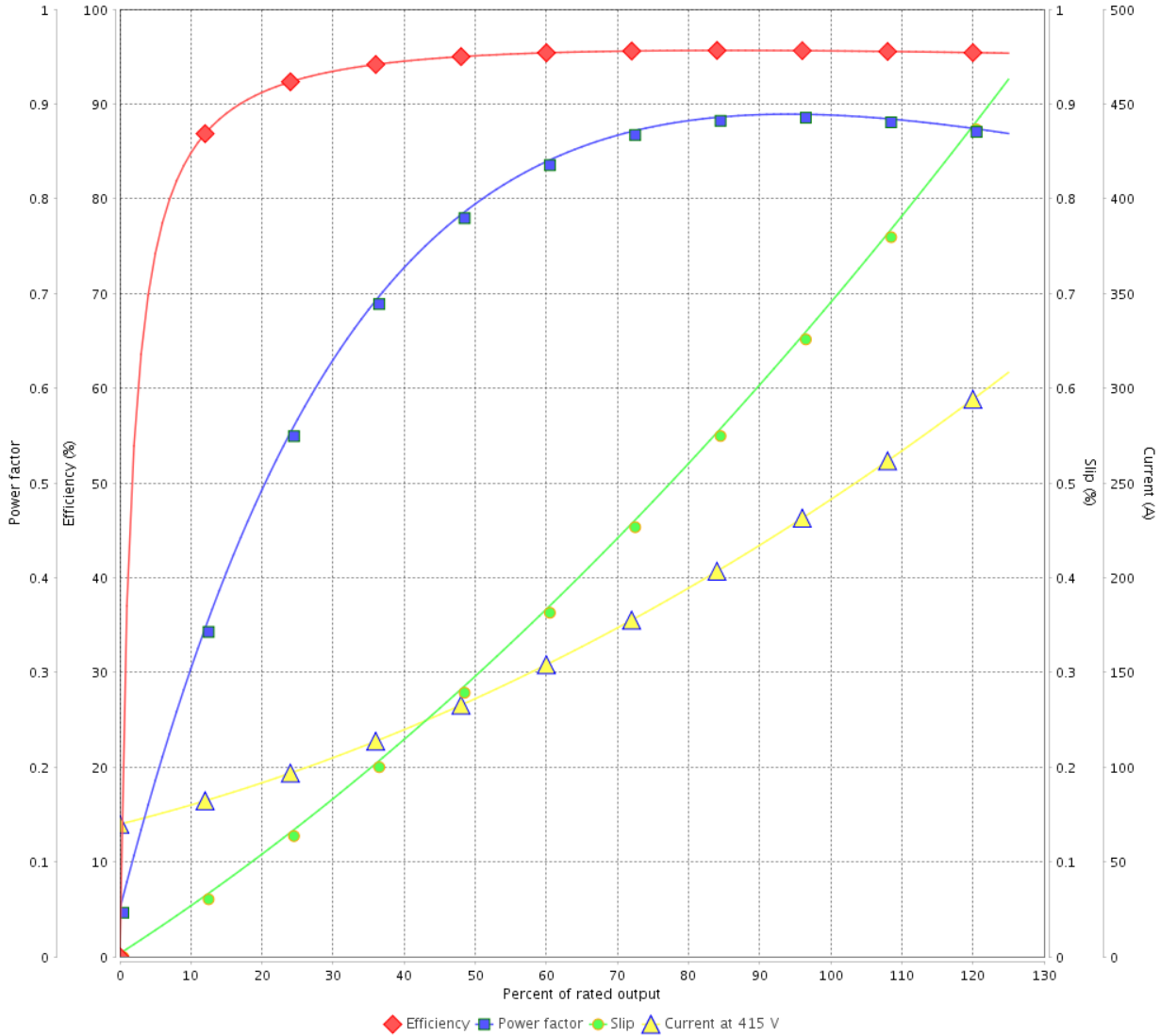

Performance : 415 V 50 Hz 2P IE3

Rated current : 245 A
 LRC : 7.1
 Rated torque : 353 ft.lb
 Locked rotor torque : 220 %
 Breakdown torque : 300 %
 Rated speed : 2979 rpm

Moment of inertia (J) : 50.3 sq.ft.lb
 Duty cycle : Cont.(S1)
 Insulation class : F
 Service factor : 1.15
 Temperature rise : 80 K
 Design : B

Rev.	Changes Summary	Performed	Checked	Date
Performed by			Page 12 / 36	Revision
Checked by				
Date	13/04/2022			

LOAD PERFORMANCE CURVE

Three Phase Induction Motor - Squirrel Cage



Customer :

Product line : NEMA Premium Efficiency Three-Phase

Product code : 11432185

Catalog # : 25036ST3QIE449TS-W22

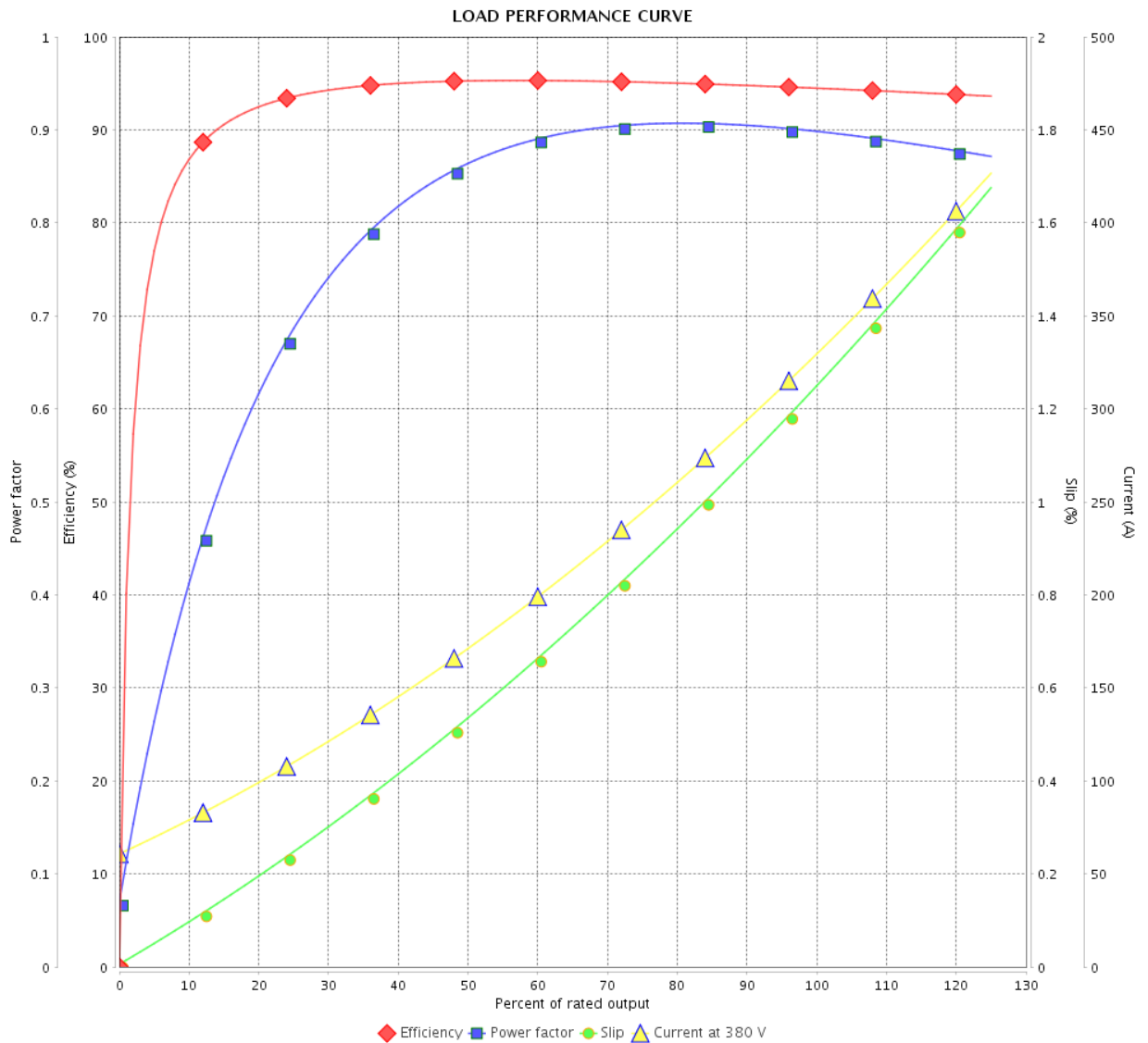

Performance : 380 V 50 Hz 2P IE1

Rated current : 330 A
 LRC : 5.3
 Rated torque : 443 ft.lb
 Locked rotor torque : 150 %
 Breakdown torque : 190 %
 Rated speed : 2962 rpm

Moment of inertia (J) : 50.3 sq.ft.lb
 Duty cycle : Cont.(S1)
 Insulation class : F
 Service factor : 1.00
 Temperature rise : 105 K
 Design : B

Rev.	Changes Summary	Performed	Checked	Date
Performed by				
Checked by				
Date				
		Page	Revision	
		13 / 36		

LOAD PERFORMANCE CURVE

Three Phase Induction Motor - Squirrel Cage



Customer :

Product line : NEMA Premium Efficiency Three-Phase

Product code : 11432185

Catalog # : 25036ST3QIE449TS-W22

LOAD PERFORMANCE CURVE

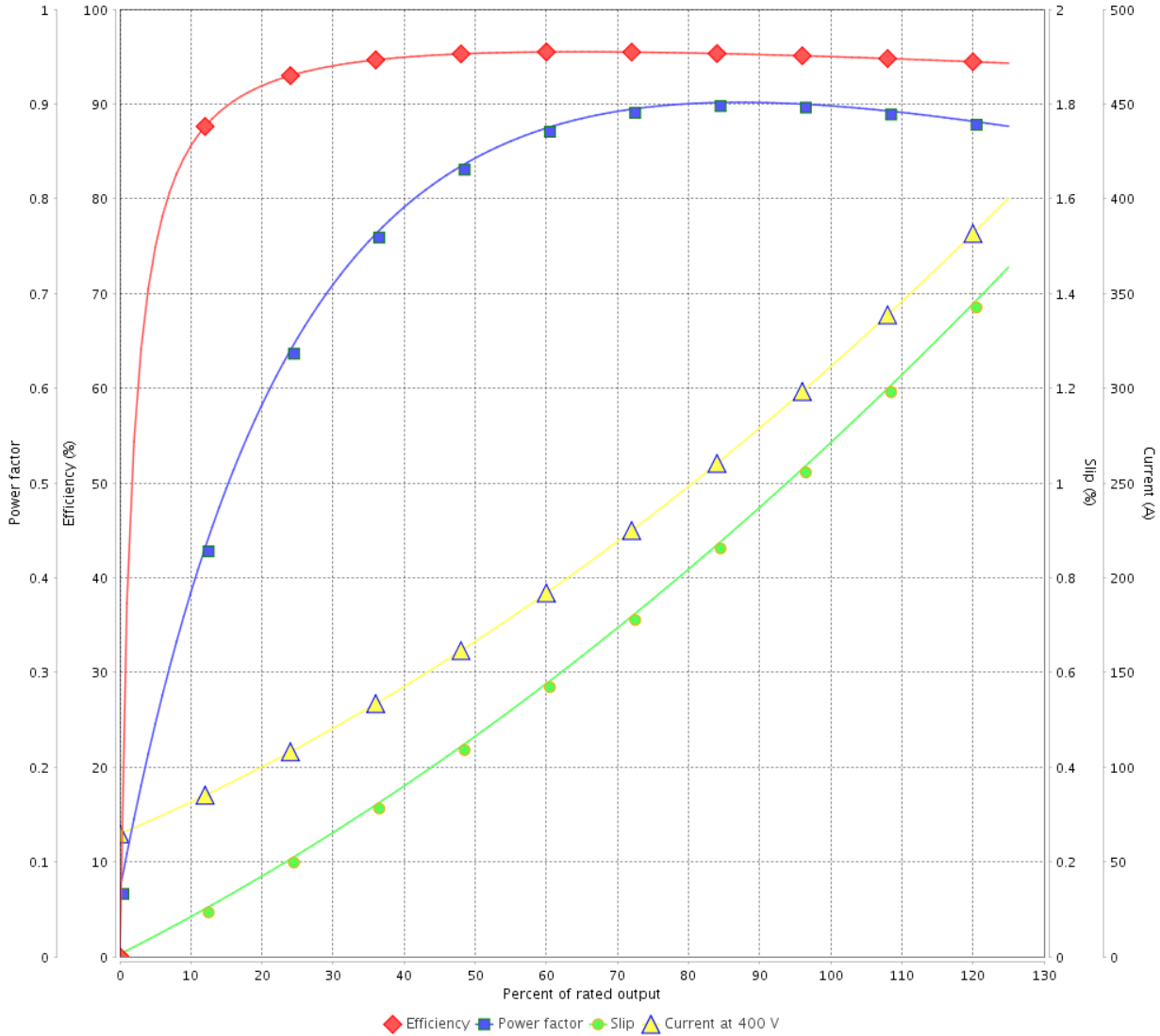

Performance : 400 V 50 Hz 2P IE2

Rated current : 312 A
 LRC : 5.8
 Rated torque : 442 ft.lb
 Locked rotor torque : 160 %
 Breakdown torque : 220 %
 Rated speed : 2967 rpm

Moment of inertia (J) : 50.3 sq.ft.lb
 Duty cycle : Cont.(S1)
 Insulation class : F
 Service factor : 1.00
 Temperature rise : 105 K
 Design : B

Rev.	Changes Summary	Performed	Checked	Date
Performed by			Page	Revision
Checked by				
Date				

LOAD PERFORMANCE CURVE

Three Phase Induction Motor - Squirrel Cage



Customer :

Product line : NEMA Premium Efficiency Three-Phase

Product code : 11432185

Catalog # : 25036ST3QIE449TS-W22

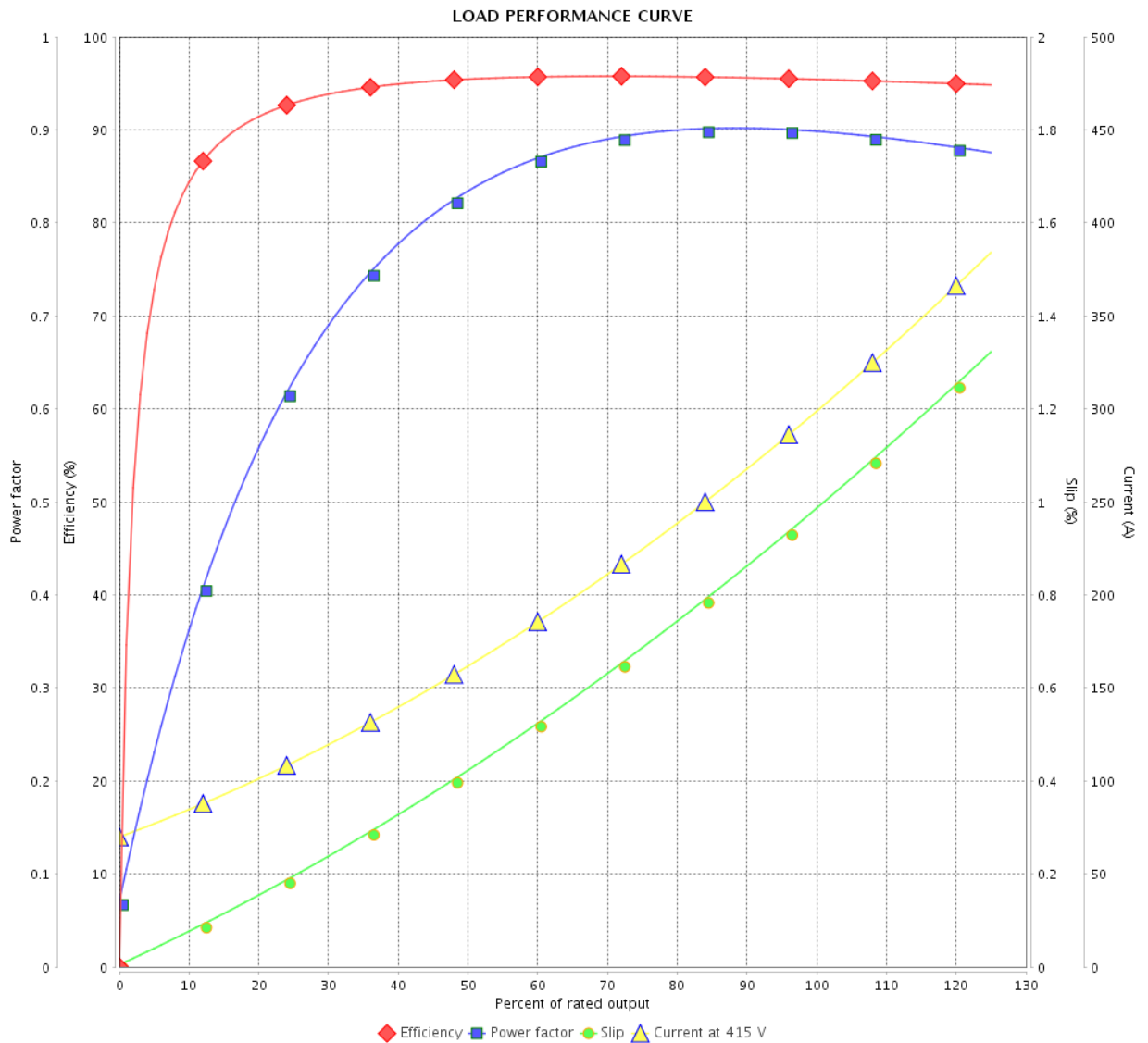

Performance : 415 V 50 Hz 2P IE2

Rated current : 300 A
 LRC : 6.4
 Rated torque : 442 ft.lb
 Locked rotor torque : 180 %
 Breakdown torque : 229 %
 Rated speed : 2970 rpm

Moment of inertia (J) : 50.3 sq.ft.lb
 Duty cycle : Cont.(S1)
 Insulation class : F
 Service factor : 1.00
 Temperature rise : 105 K
 Design : B

Rev.	Changes Summary	Performed	Checked	Date
Performed by		Page		Revision
Checked by		15 / 36		
Date		13/04/2022		

THERMAL LIMIT CURVE



Three Phase Induction Motor - Squirrel Cage

Customer :

Product line : NEMA Premium Efficiency Three-Phase
Product code : 11432185
Catalog # : 25036ST3QIE449TS-W22

Performance : 460 V 60 Hz 2P

Rated current : 269 A	Moment of inertia (J) : 50.3 sq.ft.lb
LRC : 6.7	Duty cycle : Cont.(S1)
Rated torque : 367 ft.lb	Insulation class : F
Locked rotor torque : 200 %	Service factor : 1.15
Breakdown torque : 240 %	Temperature rise : 80 K
Rated speed : 3573 rpm	Design : B

Heating constant

Cooling constant

Rev.	Changes Summary	Performed	Checked	Date
Performed by			Page	Revision
Checked by				
Date				
			16 / 36	

THERMAL LIMIT CURVE

Three Phase Induction Motor - Squirrel Cage



Customer : _____

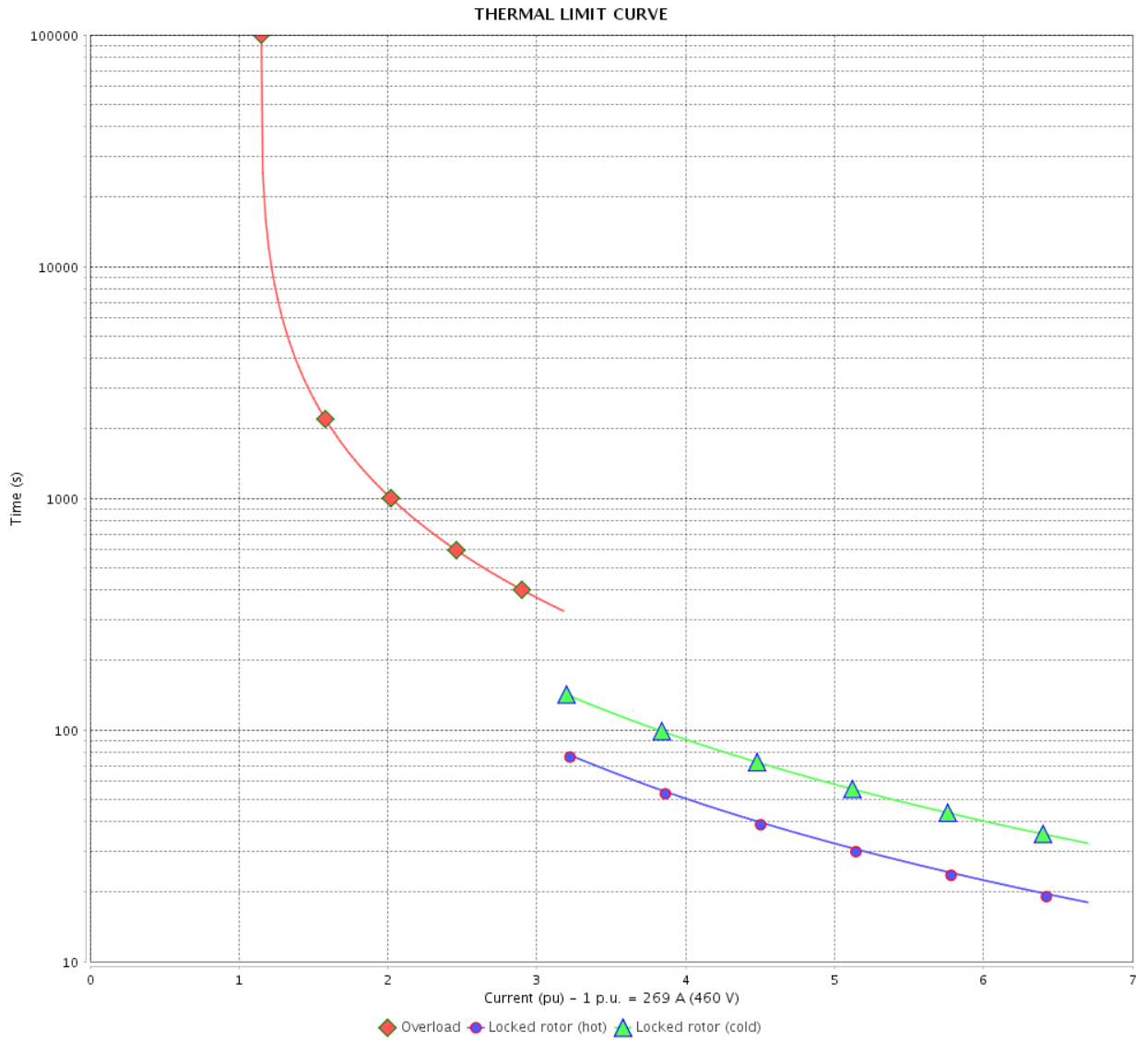

Rev.	Changes Summary	Performed	Checked	Date
Performed by		Page		Revision
Checked by		17 / 36		
Date		13/04/2022		

THERMAL LIMIT CURVE



Three Phase Induction Motor - Squirrel Cage

Customer :

Product line : NEMA Premium Efficiency Three-Phase
Product code : 11432185
Catalog # : 25036ST3QIE449TS-W22

Performance : 380 V 50 Hz 2P IE3

Rated current	: 265 A	Moment of inertia (J)	: 50.3 sq.ft.lb
LRC	: 5.7	Duty cycle	: Cont.(S1)
Rated torque	: 353 ft.lb	Insulation class	: F
Locked rotor torque	: 190 %	Service factor	: 1.15
Breakdown torque	: 240 %	Temperature rise	: 105 K
Rated speed	: 2973 rpm	Design	: B

Heating constant

Cooling constant

Rev.	Changes Summary	Performed	Checked	Date
Performed by				
Checked by			Page	Revision
Date	13/04/2022		18 / 36	

THERMAL LIMIT CURVE

Three Phase Induction Motor - Squirrel Cage



Customer : _____

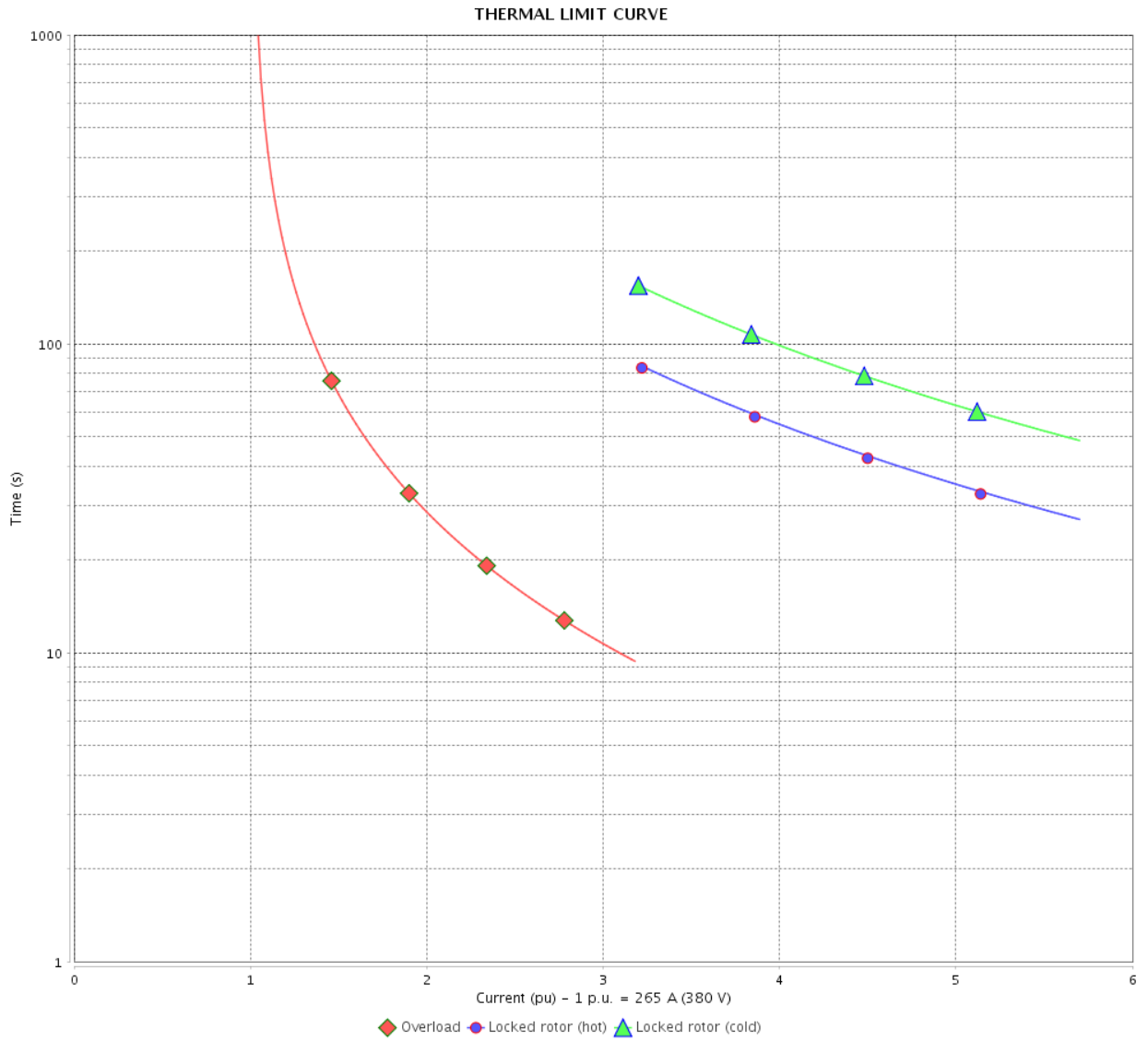

Rev.	Changes Summary	Performed	Checked	Date
Performed by		Page		Revision
Checked by		19 / 36		
Date	13/04/2022			

THERMAL LIMIT CURVE



Three Phase Induction Motor - Squirrel Cage

Customer :

Product line : NEMA Premium Efficiency Three-Phase
 Product code : 11432185
 Catalog # : 25036ST3QIE449TS-W22

Performance : 400 V 50 Hz 2P IE3

Rated current : 252 A	Moment of inertia (J) : 50.3 sq.ft.lb
LRC : 6.5	Duty cycle : Cont.(S1)
Rated torque : 353 ft.lb	Insulation class : F
Locked rotor torque : 210 %	Service factor : 1.15
Breakdown torque : 270 %	Temperature rise : 80 K
Rated speed : 2977 rpm	Design : B

Heating constant

Cooling constant

Rev.	Changes Summary	Performed	Checked	Date
Performed by			Page 20 / 36	Revision
Checked by				
Date	13/04/2022			

THERMAL LIMIT CURVE

Three Phase Induction Motor - Squirrel Cage



Customer : _____

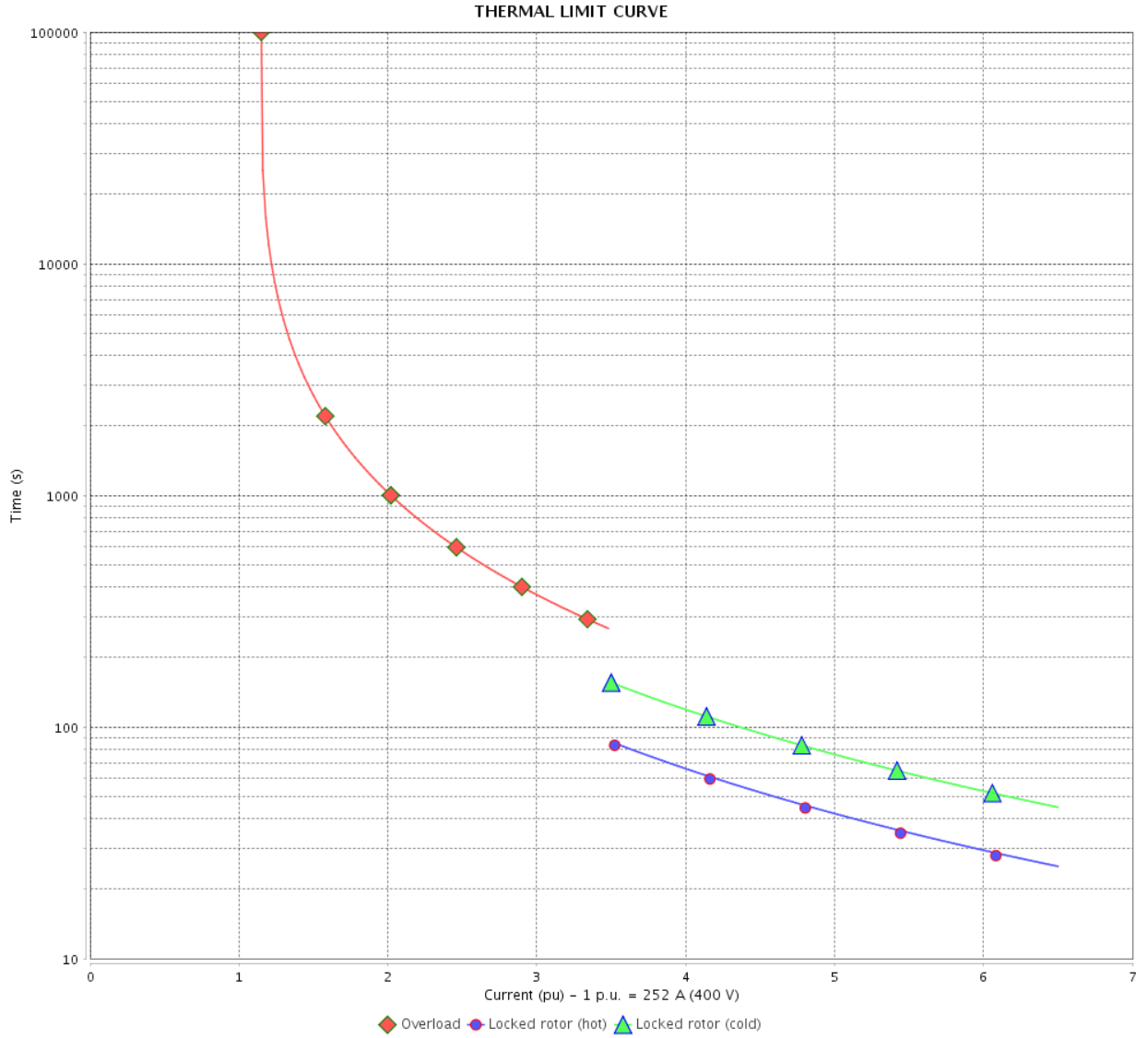

Rev.	Changes Summary	Performed	Checked	Date
Performed by		Page 21 / 36		Revision
Checked by				
Date				

THERMAL LIMIT CURVE



Three Phase Induction Motor - Squirrel Cage

Customer :

Product line : NEMA Premium Efficiency Three-Phase
Product code : 11432185
Catalog # : 25036ST3QIE449TS-W22

Performance : 415 V 50 Hz 2P IE3

Rated current	: 245 A	Moment of inertia (J)	: 50.3 sq.ft.lb
LRC	: 7.1	Duty cycle	: Cont.(S1)
Rated torque	: 353 ft.lb	Insulation class	: F
Locked rotor torque	: 220 %	Service factor	: 1.15
Breakdown torque	: 300 %	Temperature rise	: 80 K
Rated speed	: 2979 rpm	Design	: B

Heating constant

Cooling constant

Rev.	Changes Summary	Performed	Checked	Date
Performed by				
Checked by			Page	Revision
Date	13/04/2022		22 / 36	

THERMAL LIMIT CURVE

Three Phase Induction Motor - Squirrel Cage



Customer : _____

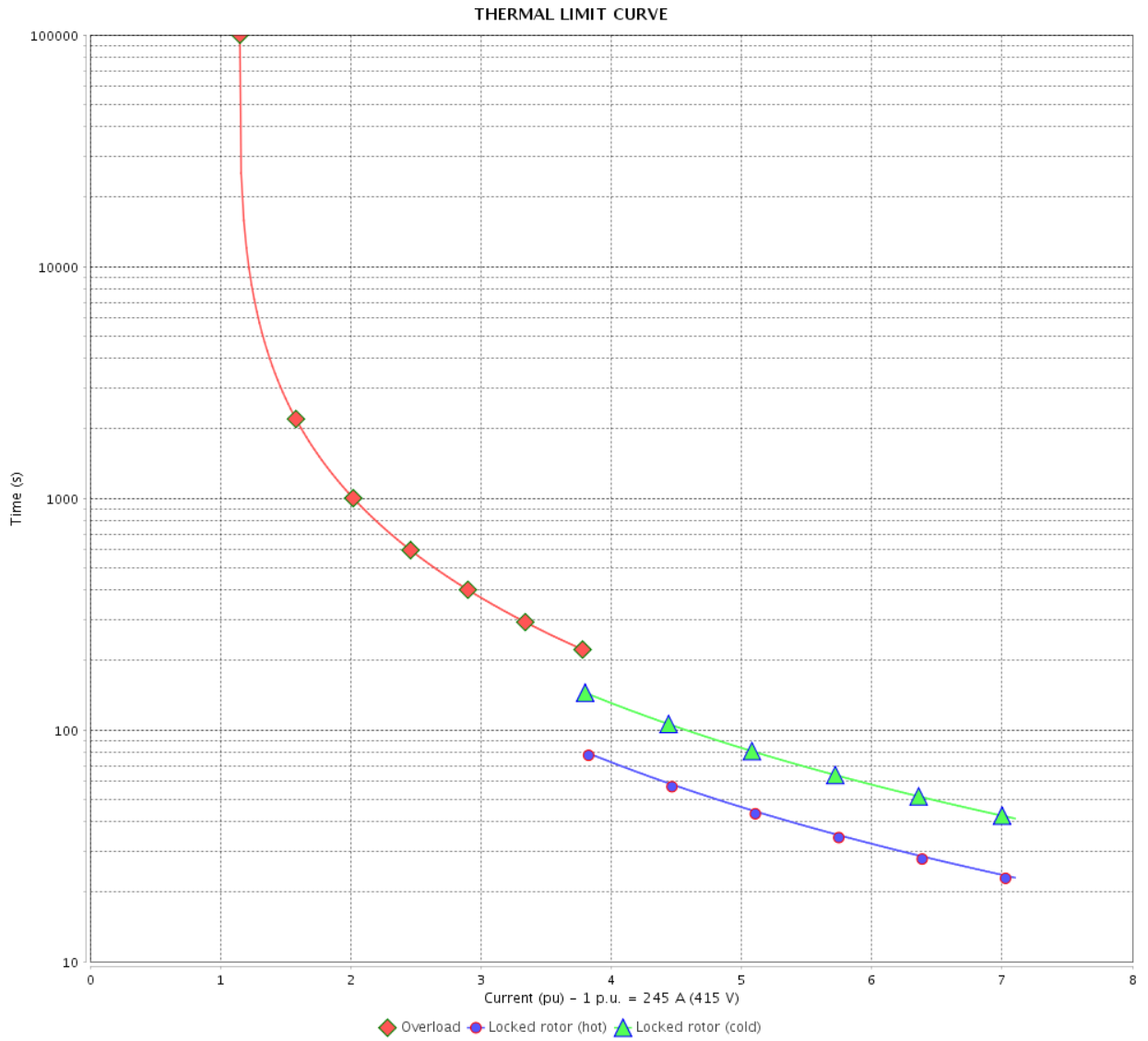

Rev.	Changes Summary	Performed	Checked	Date
Performed by		Page 23 / 36		Revision
Checked by				
Date				

THERMAL LIMIT CURVE



Three Phase Induction Motor - Squirrel Cage

Customer :

Product line : NEMA Premium Efficiency Three-Phase
Product code : 11432185
Catalog # : 25036ST3QIE449TS-W22

Performance : 380 V 50 Hz 2P IE1

Rated current	: 330 A	Moment of inertia (J)	: 50.3 sq.ft.lb
LRC	: 5.3	Duty cycle	: Cont.(S1)
Rated torque	: 443 ft.lb	Insulation class	: F
Locked rotor torque	: 150 %	Service factor	: 1.00
Breakdown torque	: 190 %	Temperature rise	: 105 K
Rated speed	: 2962 rpm	Design	: B

Heating constant

Cooling constant

Rev.	Changes Summary	Performed	Checked	Date
Performed by				
Checked by			Page	Revision
Date	13/04/2022		24 / 36	

THERMAL LIMIT CURVE

Three Phase Induction Motor - Squirrel Cage



Customer : _____

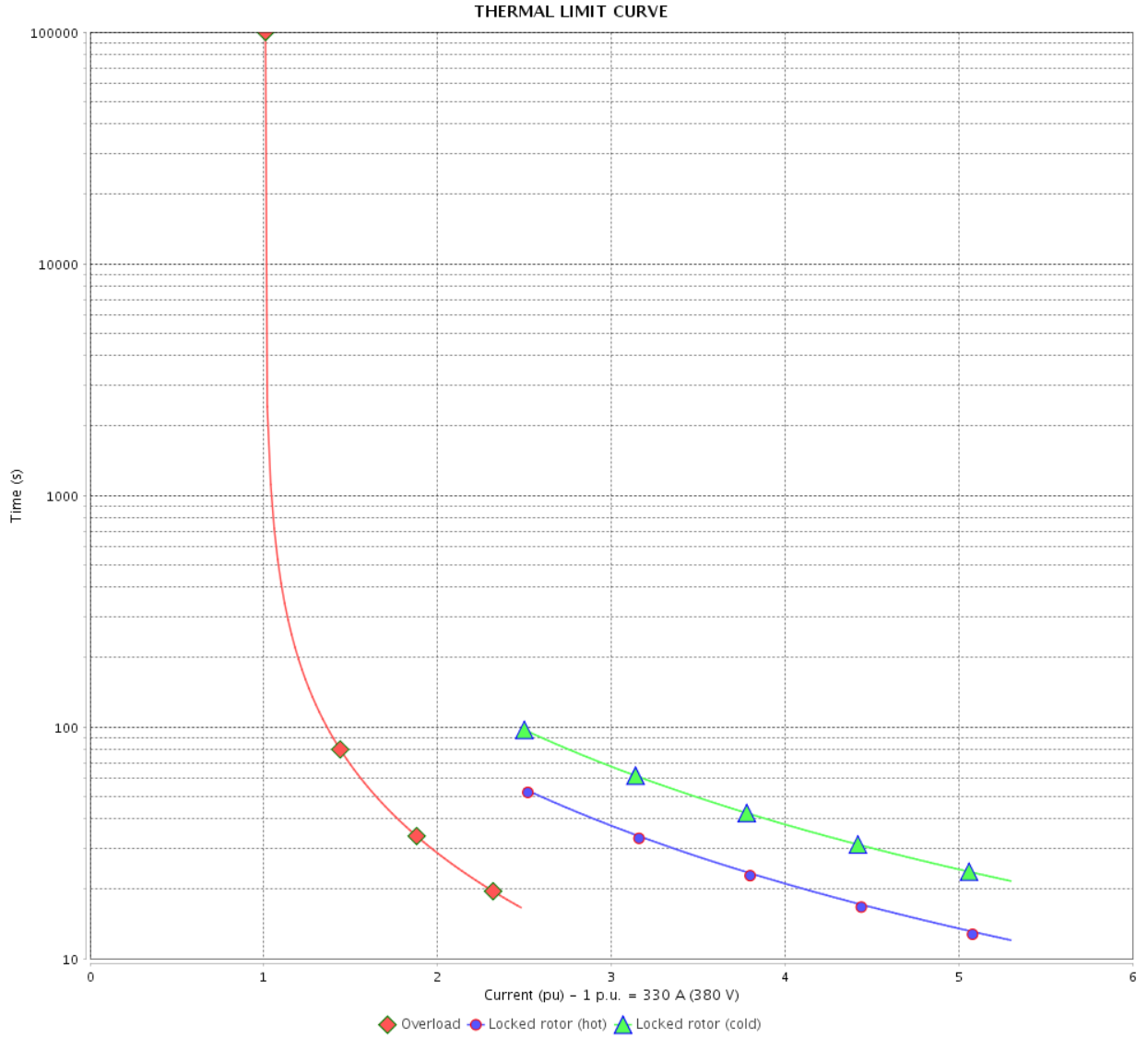

Rev.	Changes Summary	Performed	Checked	Date
Performed by		Page 25 / 36		Revision
Checked by				
Date				

THERMAL LIMIT CURVE

Three Phase Induction Motor - Squirrel Cage



Customer :

Product line : NEMA Premium Efficiency Three-Phase
Product code : 11432185
Catalog # : 25036ST3QIE449TS-W22

Performance : 400 V 50 Hz 2P IE2

Rated current	: 312 A	Moment of inertia (J)	: 50.3 sq.ft.lb
LRC	: 5.8	Duty cycle	: Cont.(S1)
Rated torque	: 442 ft.lb	Insulation class	: F
Locked rotor torque	: 160 %	Service factor	: 1.00
Breakdown torque	: 220 %	Temperature rise	: 105 K
Rated speed	: 2967 rpm	Design	: B

Heating constant

Cooling constant

Rev.	Changes Summary	Performed	Checked	Date
Performed by				
Checked by			Page	Revision
Date	13/04/2022		26 / 36	

THERMAL LIMIT CURVE

Three Phase Induction Motor - Squirrel Cage



Customer : _____

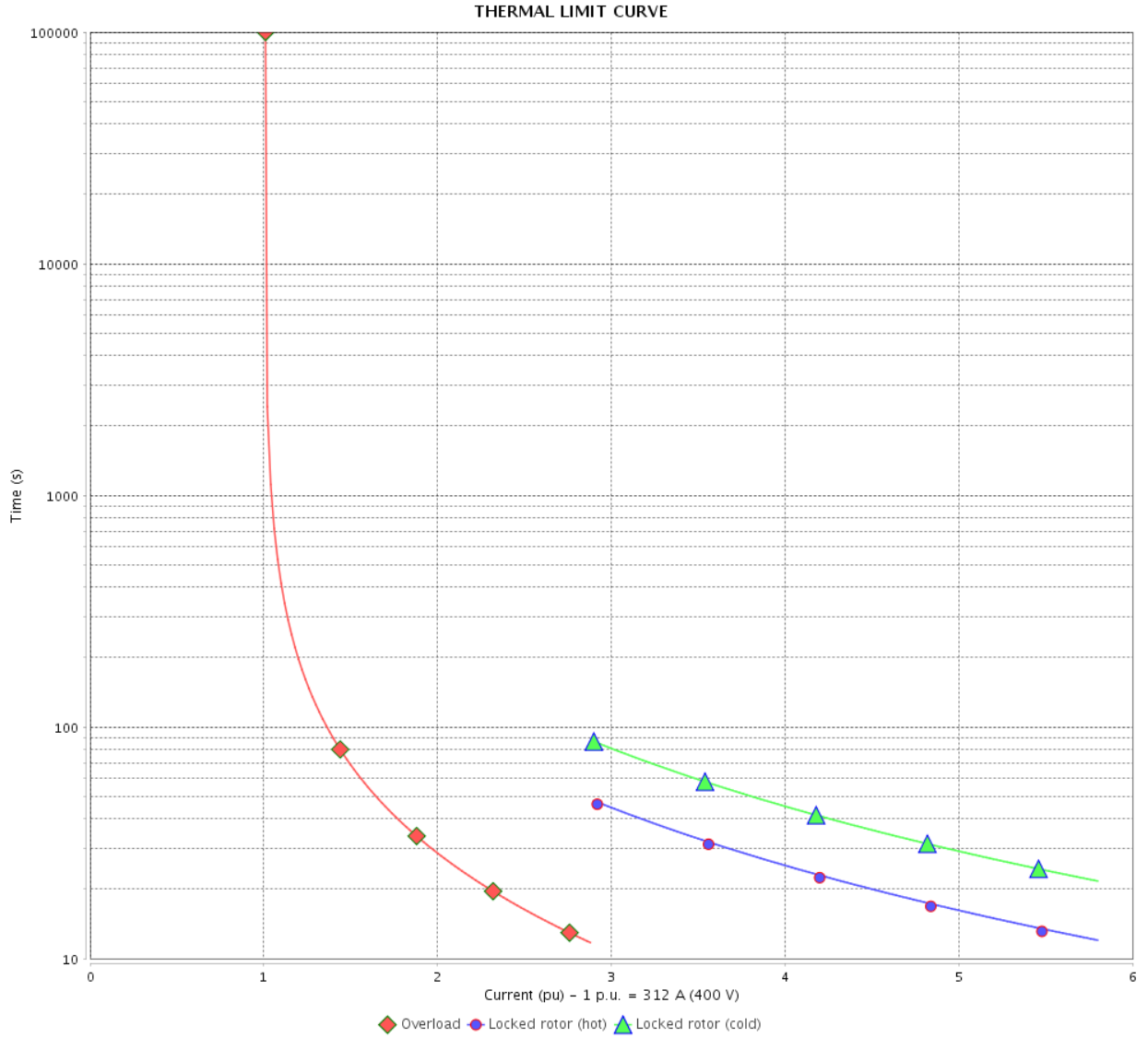

Rev.	Changes Summary	Performed	Checked	Date
Performed by				
Checked by				
Date				
			Page	Revision
			27 / 36	

THERMAL LIMIT CURVE

Three Phase Induction Motor - Squirrel Cage



Customer :

Product line : NEMA Premium Efficiency Three-Phase
Product code : 11432185
Catalog # : 25036ST3QIE449TS-W22

Performance : 415 V 50 Hz 2P IE2

Rated current	: 300 A	Moment of inertia (J)	: 50.3 sq.ft.lb
LRC	: 6.4	Duty cycle	: Cont.(S1)
Rated torque	: 442 ft.lb	Insulation class	: F
Locked rotor torque	: 180 %	Service factor	: 1.00
Breakdown torque	: 229 %	Temperature rise	: 105 K
Rated speed	: 2970 rpm	Design	: B

Heating constant

Cooling constant

Rev.	Changes Summary	Performed	Checked	Date
Performed by				
Checked by				
Date	13/04/2022		Page 28 / 36	Revision

THERMAL LIMIT CURVE

Three Phase Induction Motor - Squirrel Cage



Customer : _____

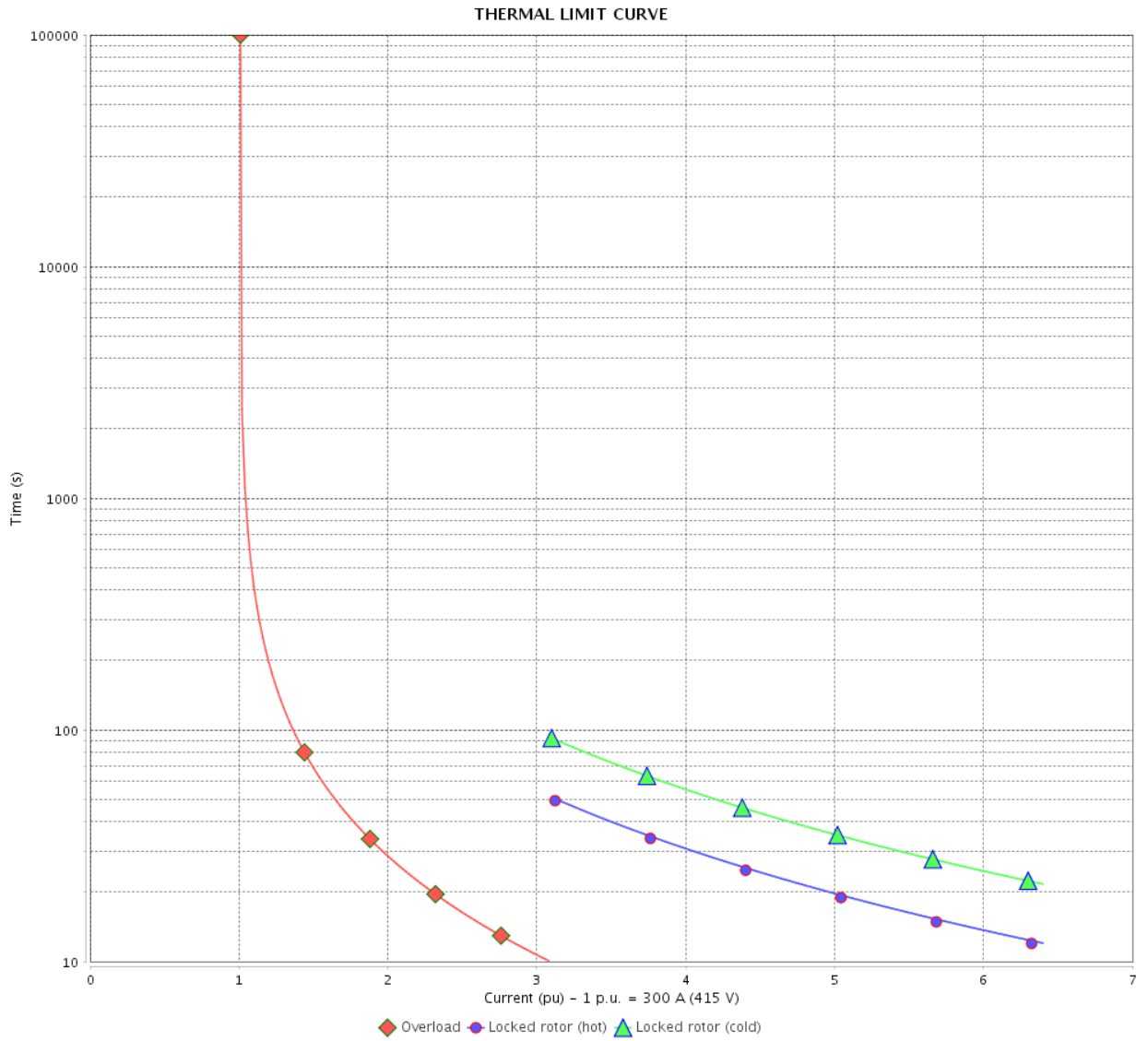

Rev.	Changes Summary	Performed	Checked	Date
Performed by		Page		Revision
Checked by		29 / 36		
Date		13/04/2022		

VFD OPERATION CURVE

Three Phase Induction Motor - Squirrel Cage



Customer :

Product line : NEMA Premium Efficiency Three-Phase

Product code : 11432185

Catalog # : 25036ST3QIE449TS-W22

VFD OPERATION CURVE

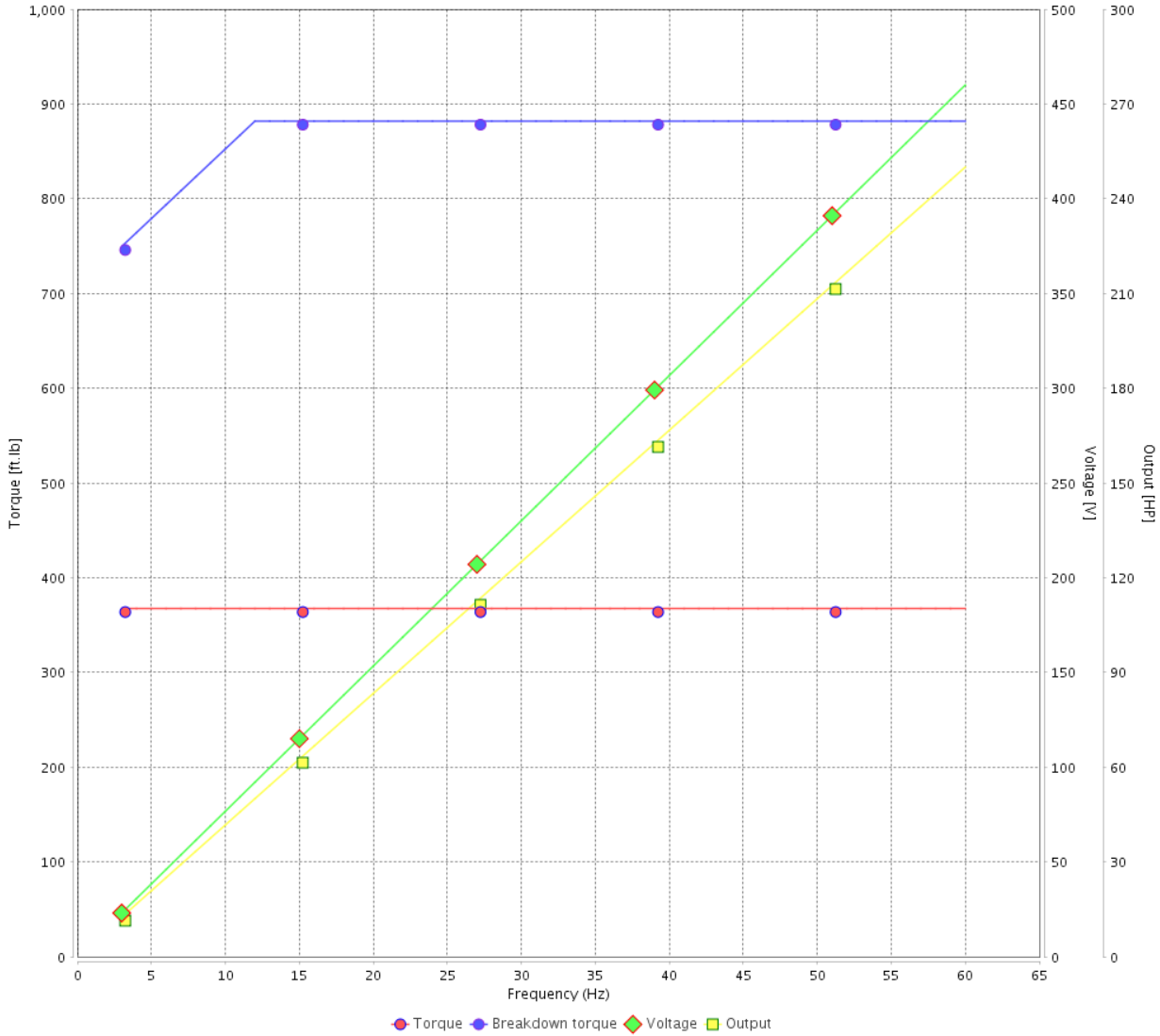

Performance : 460 V 60 Hz 2P

Rated current : 269 A
 LRC : 6.7
 Rated torque : 367 ft.lb
 Locked rotor torque : 200 %
 Breakdown torque : 240 %
 Rated speed : 3573 rpm

Moment of inertia (J) : 50.3 sq.ft.lb
 Duty cycle : Cont.(S1)
 Insulation class : F
 Service factor : 1.15
 Temperature rise : 80 K
 Design : B

Rev.	Changes Summary	Performed	Checked	Date
Performed by			Page	Revision
Checked by				
Date				

VFD OPERATION CURVE

Three Phase Induction Motor - Squirrel Cage



Customer : _____

Product line : NEMA Premium Efficiency Three-Phase

Product code : 11432185

Catalog # : 25036ST3QIE449TS-W22

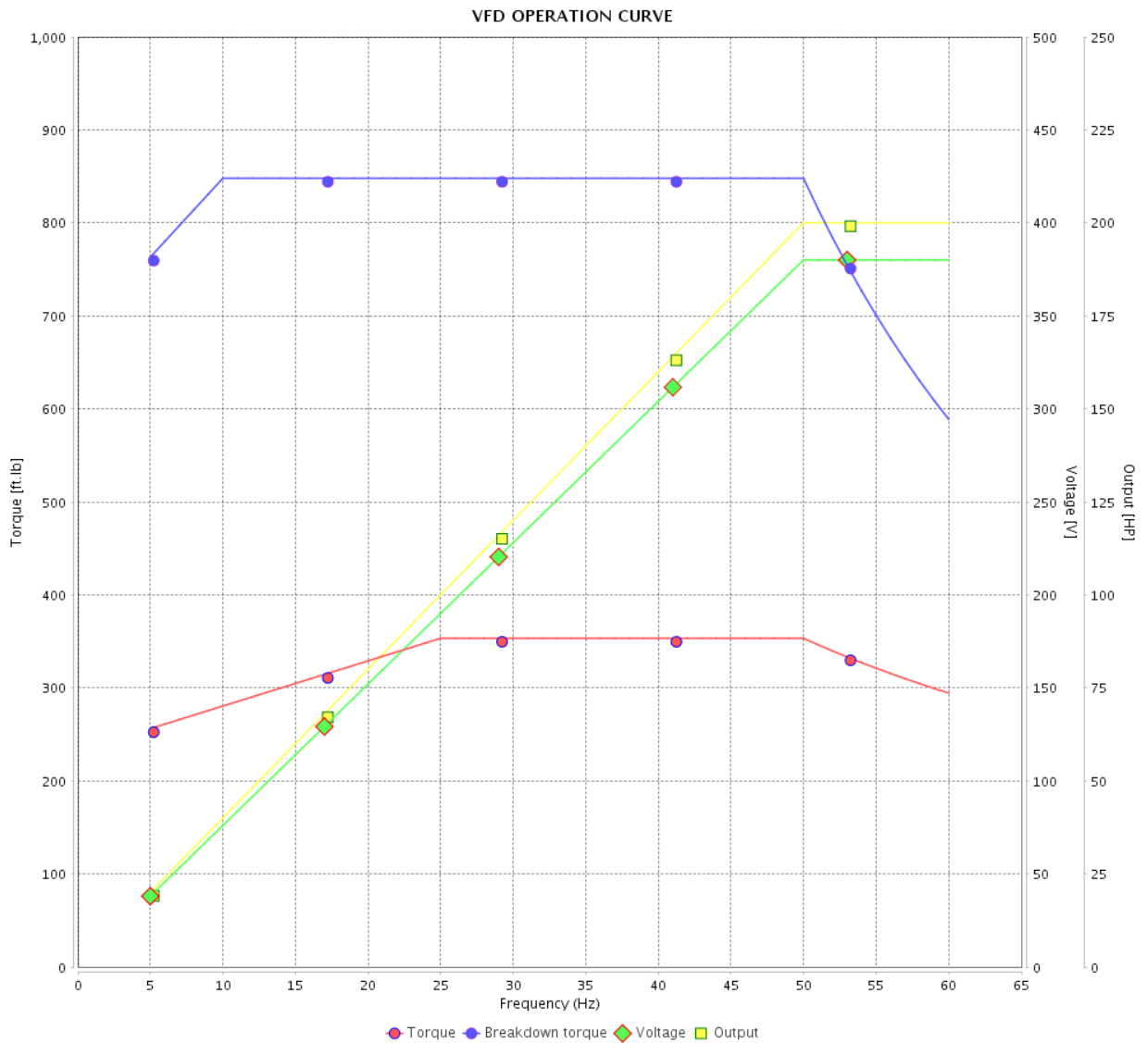

Performance : 380 V 50 Hz 2P IE3

Rated current : 265 A
 LRC : 5.7
 Rated torque : 353 ft.lb
 Locked rotor torque : 190 %
 Breakdown torque : 240 %
 Rated speed : 2973 rpm

Moment of inertia (J) : 50.3 sq.ft.lb
 Duty cycle : Cont.(S1)
 Insulation class : F
 Service factor : 1.15
 Temperature rise : 105 K
 Design : B

Rev.	Changes Summary	Performed	Checked	Date
Performed by			Page 31 / 36	Revision
Checked by				
Date	13/04/2022			

VFD OPERATION CURVE

Three Phase Induction Motor - Squirrel Cage

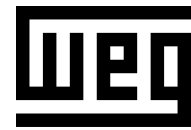

Customer : _____

Product line : NEMA Premium Efficiency Three-Phase

Product code : 11432185

Catalog # : 25036ST3QIE449TS-W22

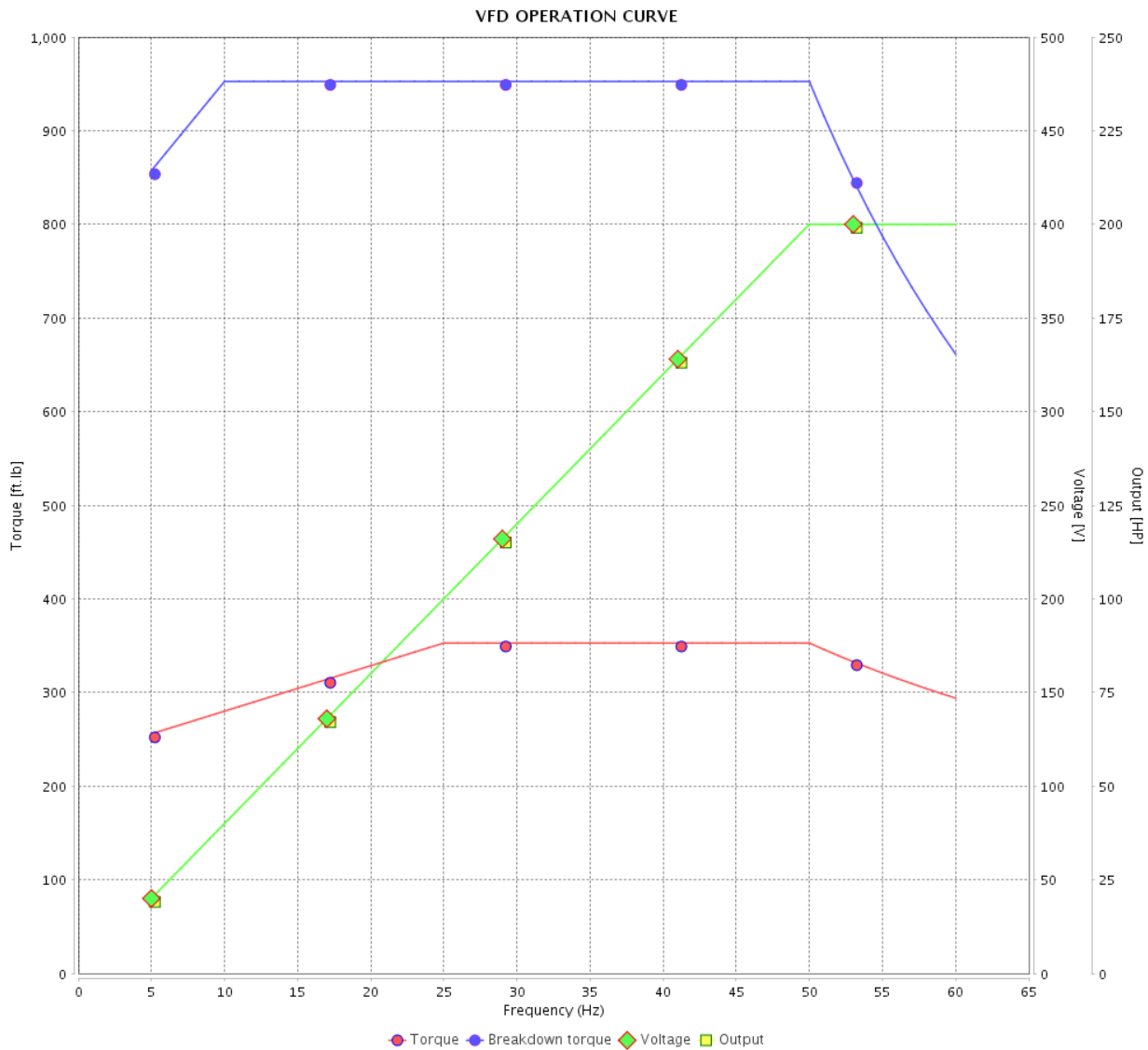

Performance : 400 V 50 Hz 2P IE3

Rated current	: 252 A	Moment of inertia (J)	: 50.3 sq.ft.lb
LRC	: 6.5	Duty cycle	: Cont.(S1)
Rated torque	: 353 ft.lb	Insulation class	: F
Locked rotor torque	: 210 %	Service factor	: 1.15
Breakdown torque	: 270 %	Temperature rise	: 80 K
Rated speed	: 2977 rpm	Design	: B

Rev.	Changes Summary	Performed	Checked	Date
Performed by			Page 32 / 36	Revision
Checked by				
Date	13/04/2022			

VFD OPERATION CURVE

Three Phase Induction Motor - Squirrel Cage



Customer :

Product line : NEMA Premium Efficiency Three-Phase

Product code : 11432185

Catalog # : 25036ST3QIE449TS-W22

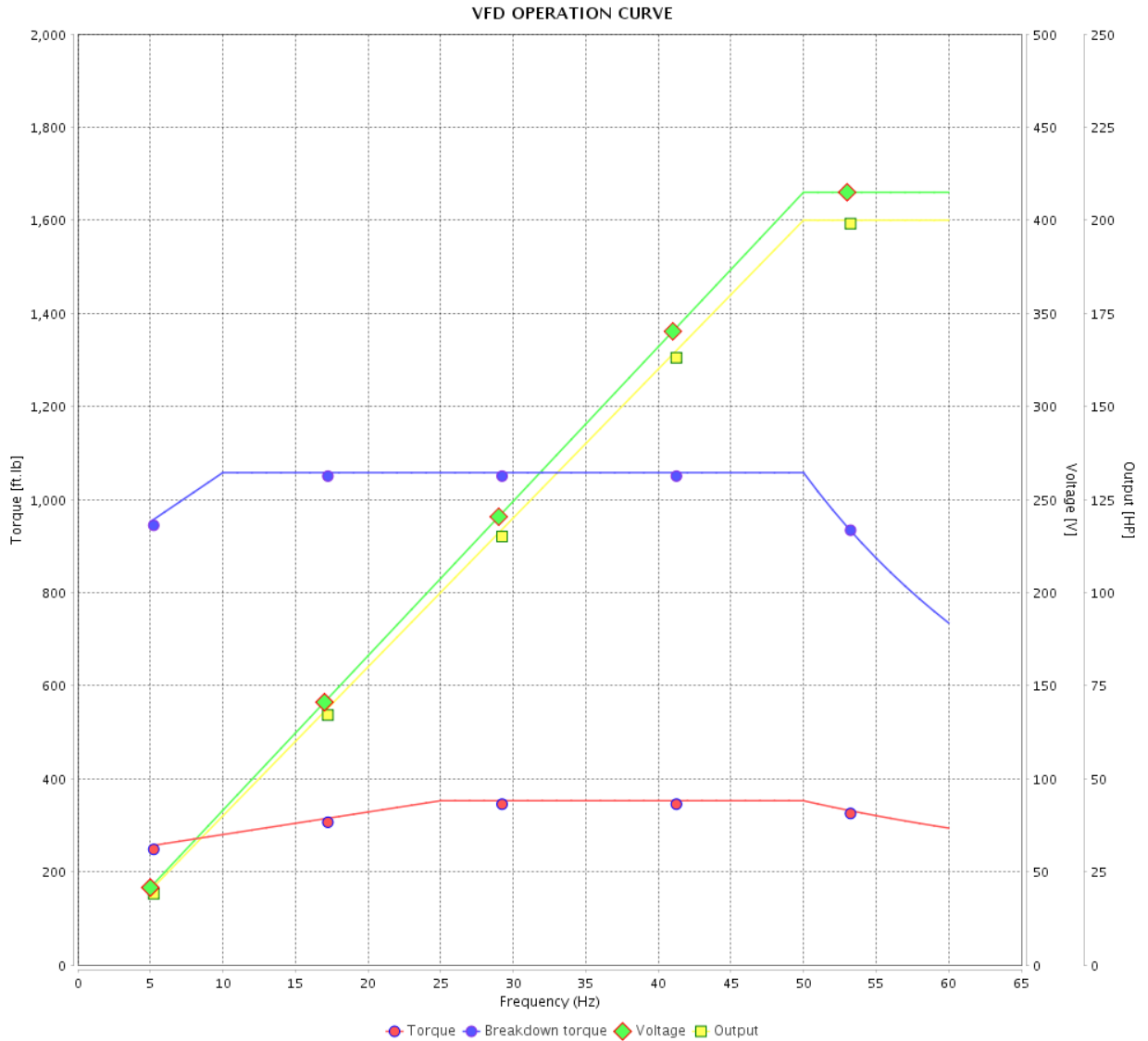

Performance : 415 V 50 Hz 2P IE3

Rated current : 245 A
 LRC : 7.1
 Rated torque : 353 ft.lb
 Locked rotor torque : 220 %
 Breakdown torque : 300 %
 Rated speed : 2979 rpm

Moment of inertia (J) : 50.3 sq.ft.lb
 Duty cycle : Cont.(S1)
 Insulation class : F
 Service factor : 1.15
 Temperature rise : 80 K
 Design : B

Rev.	Changes Summary	Performed	Checked	Date
Performed by			Page	Revision
Checked by				
Date				

VFD OPERATION CURVE

Three Phase Induction Motor - Squirrel Cage



Customer : _____

Product line : NEMA Premium Efficiency Three-Phase

Product code : 11432185

Catalog # : 25036ST3QIE449TS-W22

VFD OPERATION CURVE

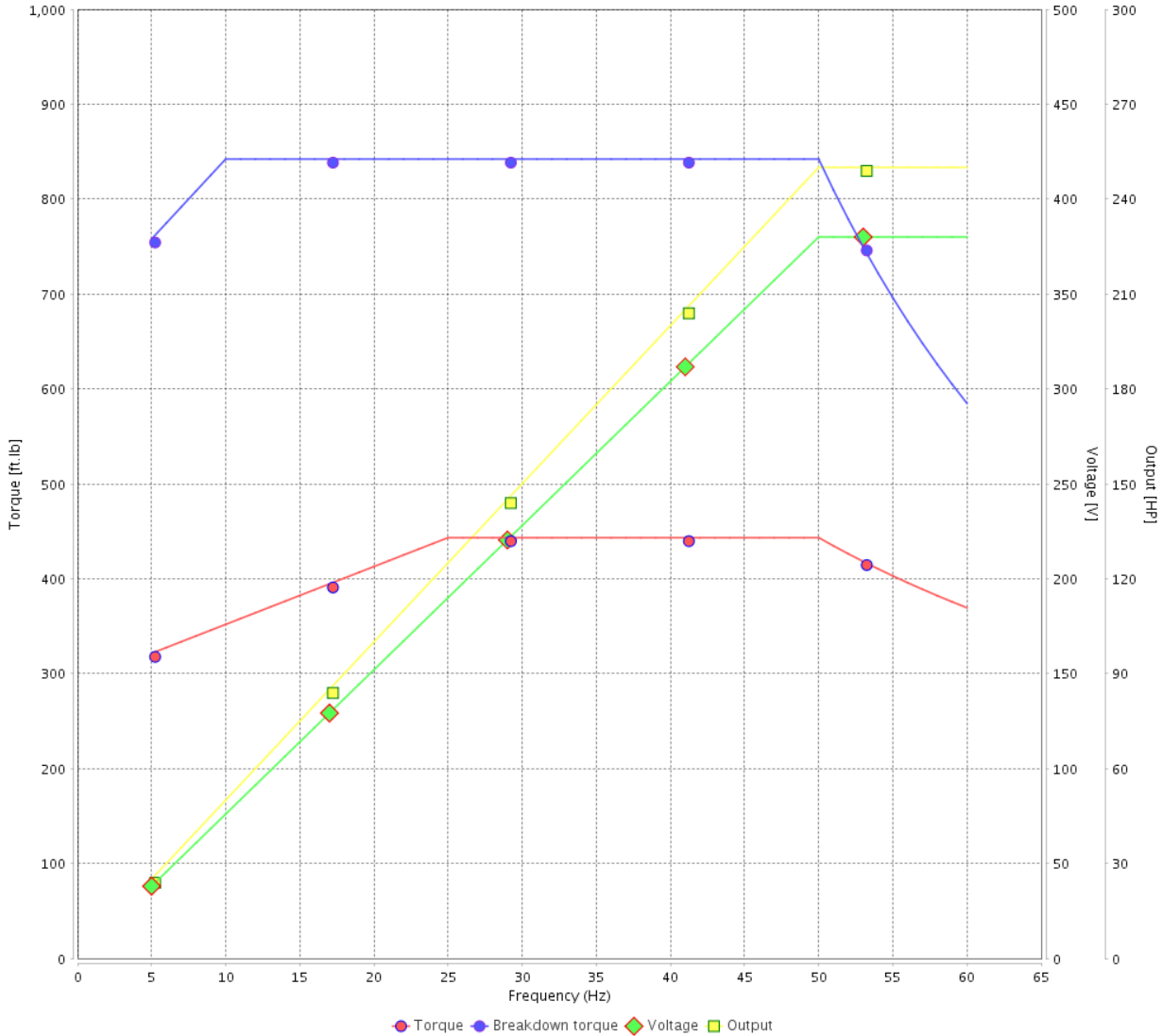

Performance : 380 V 50 Hz 2P IE1

Rated current	: 330 A	Moment of inertia (J)	: 50.3 sq.ft.lb
LRC	: 5.3	Duty cycle	: Cont.(S1)
Rated torque	: 443 ft.lb	Insulation class	: F
Locked rotor torque	: 150 %	Service factor	: 1.00
Breakdown torque	: 190 %	Temperature rise	: 105 K
Rated speed	: 2962 rpm	Design	: B

Rev.	Changes Summary	Performed	Checked	Date
Performed by			Page 34 / 36	Revision
Checked by				
Date	13/04/2022			

VFD OPERATION CURVE

Three Phase Induction Motor - Squirrel Cage



Customer : _____

Product line : NEMA Premium Efficiency Three-Phase

Product code : 11432185

Catalog # : 25036ST3QIE449TS-W22

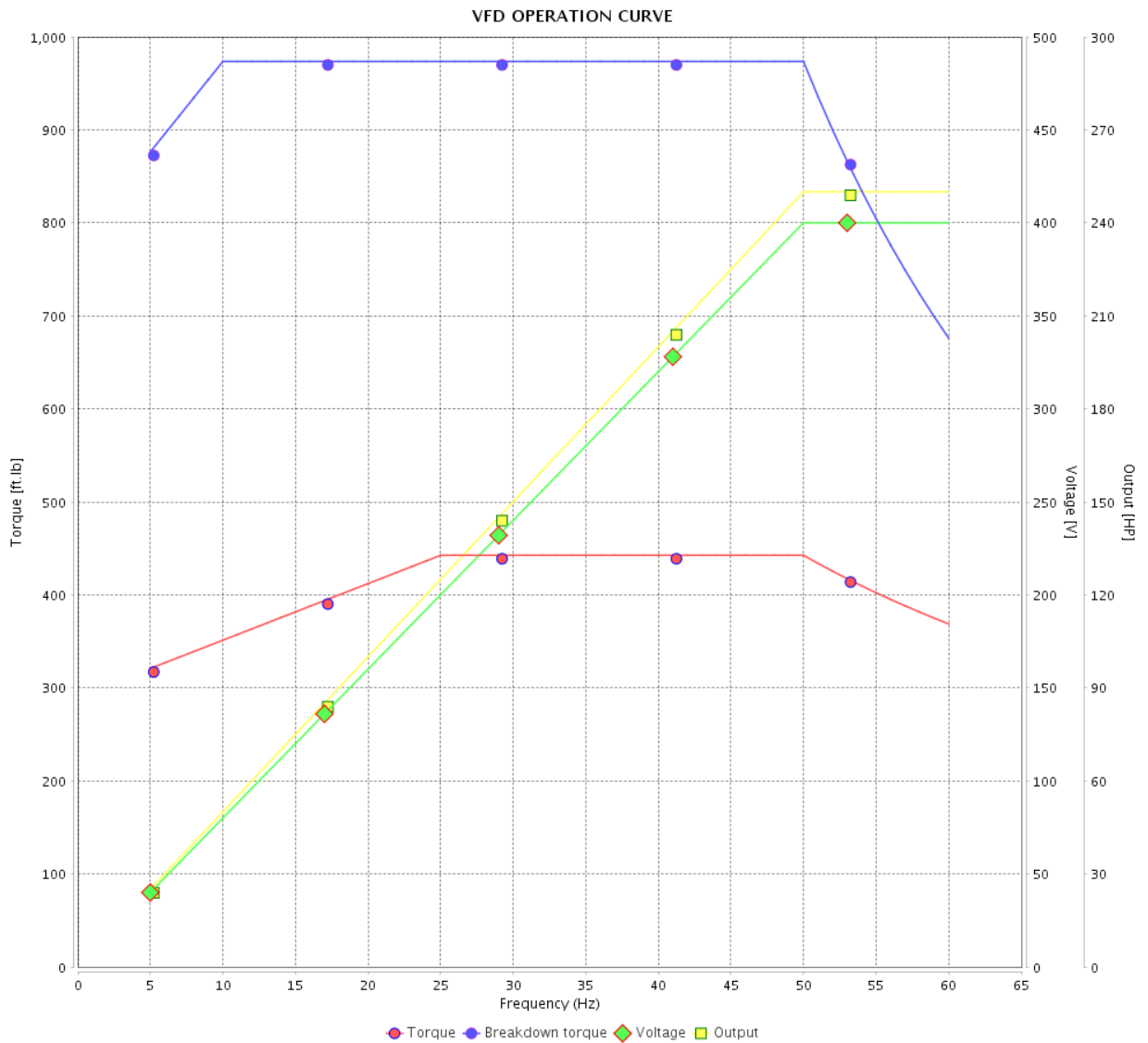

Performance : 400 V 50 Hz 2P IE2

Rated current : 312 A
 LRC : 5.8
 Rated torque : 442 ft.lb
 Locked rotor torque : 160 %
 Breakdown torque : 220 %
 Rated speed : 2967 rpm

Moment of inertia (J) : 50.3 sq.ft.lb
 Duty cycle : Cont.(S1)
 Insulation class : F
 Service factor : 1.00
 Temperature rise : 105 K
 Design : B

Rev.	Changes Summary	Performed	Checked	Date
Performed by			Page 35 / 36	Revision
Checked by				
Date	13/04/2022			

VFD OPERATION CURVE

Three Phase Induction Motor - Squirrel Cage



Customer :

Product line : NEMA Premium Efficiency Three-Phase

Product code : 11432185

Catalog # : 25036ST3QIE449TS-W22

VFD OPERATION CURVE

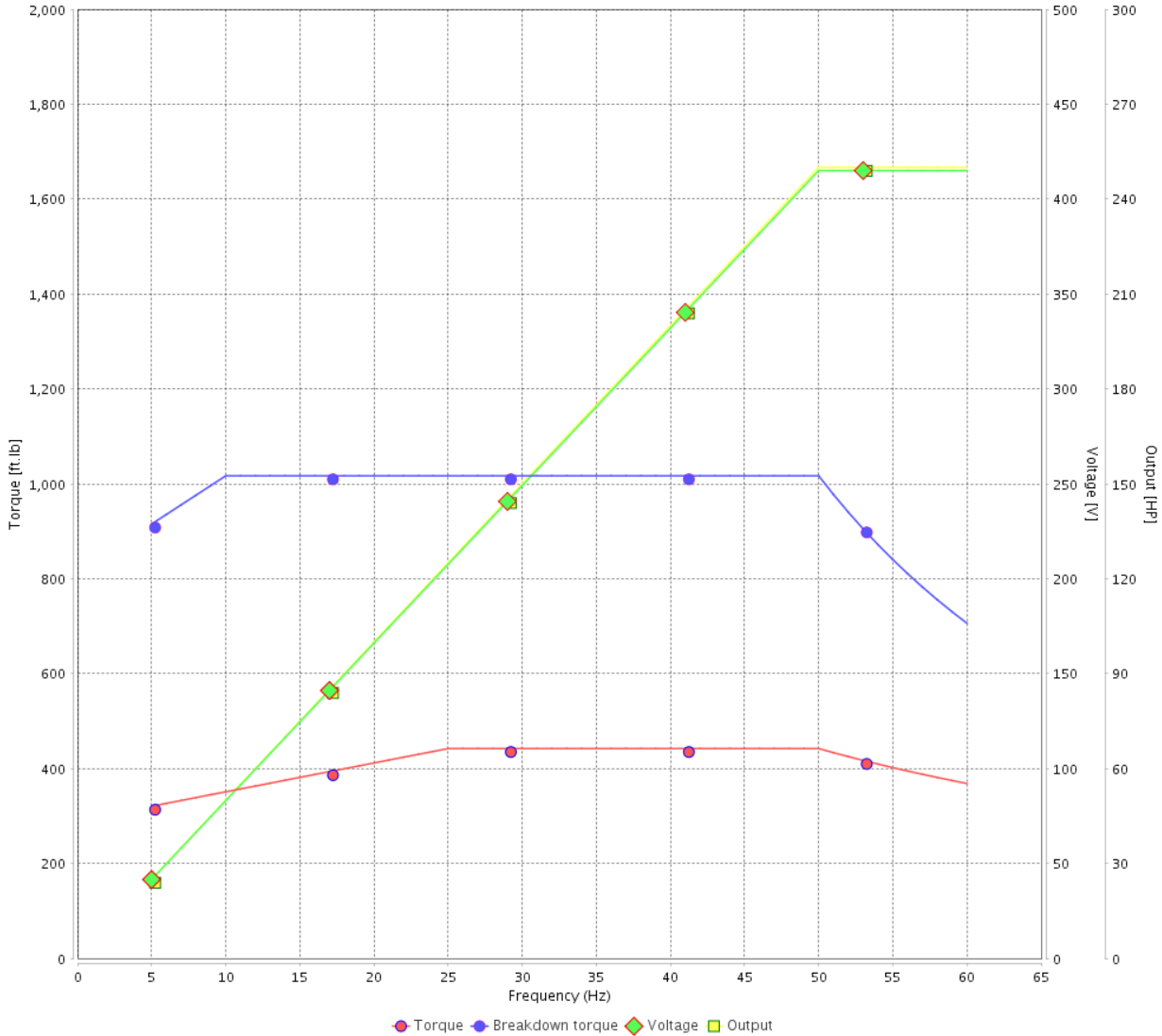

Performance : 415 V 50 Hz 2P IE2

Rated current : 300 A
 LRC : 6.4
 Rated torque : 442 ft.lb
 Locked rotor torque : 180 %
 Breakdown torque : 229 %
 Rated speed : 2970 rpm

Moment of inertia (J) : 50.3 sq.ft.lb
 Duty cycle : Cont.(S1)
 Insulation class : F
 Service factor : 1.00
 Temperature rise : 105 K
 Design : B

Rev.	Changes Summary	Performed	Checked	Date
Performed by			Page	Revision
Checked by				
Date				

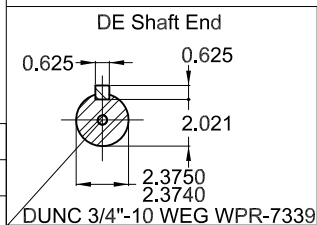
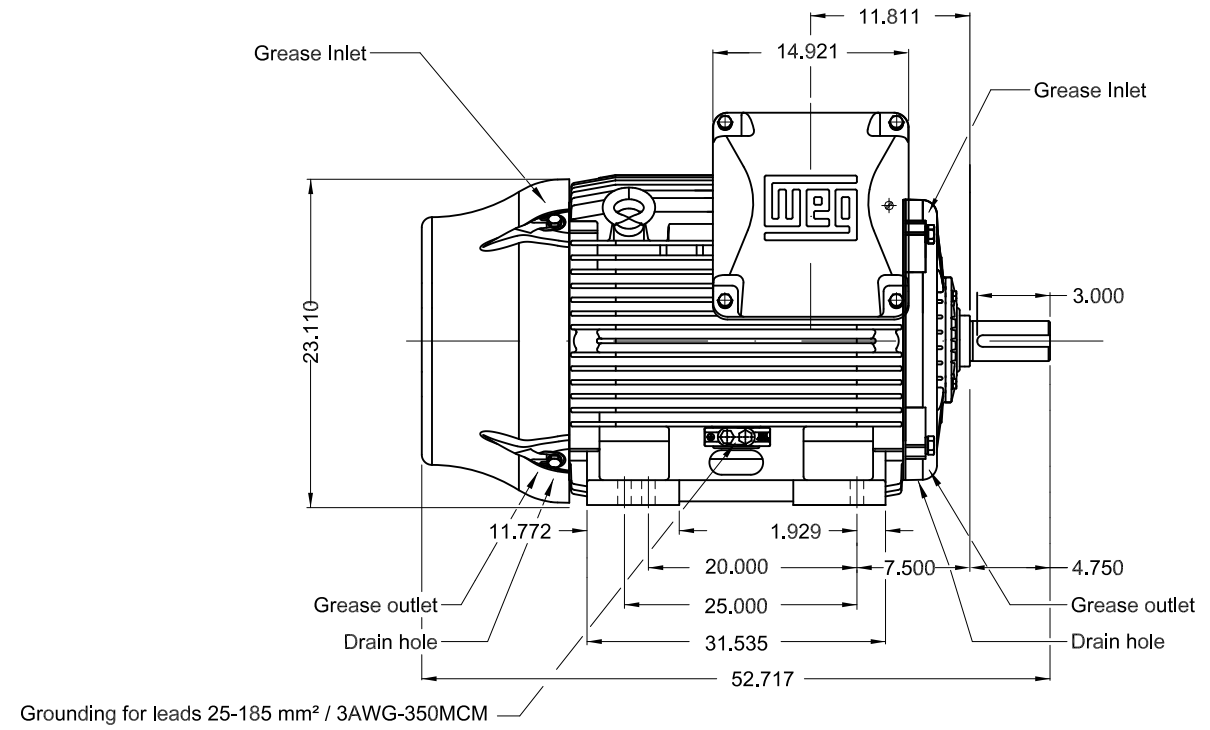
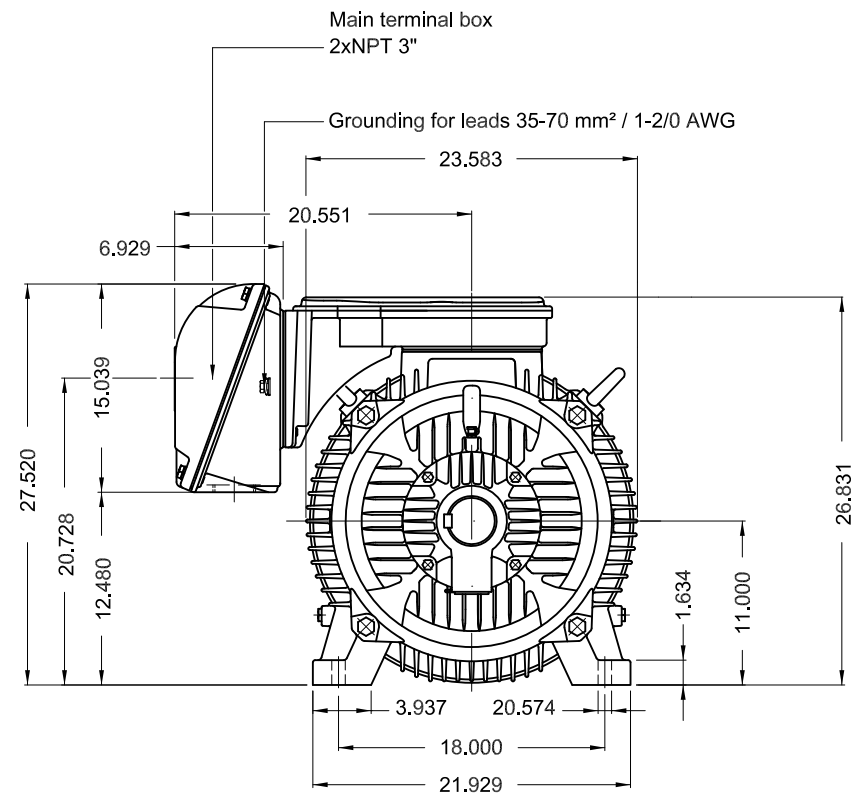

Color RAL 5009
 Painting plan 202E
 Mounting B3R(D)

250 HP 02 Poles 60 Hz

ECM	LOC	SUMMARY OF MODIFICATIONS	EXECUTED	CHECKED	RELEASED	DATE	VER
EXECUTED	PIRWBUSER	THREE PH. MOTOR IEEE 841 W22 PREM. EFF.					
CHECKED		FRAME 447/9TS IP55 TEFC					
RELEASED							
REL DT.	WMO	Jaragua do Sul	Product Engineering				

PREVIEW
 WDD



SHEET 1 / 1

Dimensions in inches

XME A3



NEMA
Premium
W22



FOR SAFE AREA
Mod.TE1BFOXON
CC029A



Class I, Div 2, Gr A, B, C and D - T3
Class I, Zone 2, IIC - T3
Class II, Div 2, Gr F and G - T3C
For use on PWM: Gr. A, B, C, D and F,
VT 1000:1, CT 20:1, 1.00SF - T3

MODEL 25036ST3QIE449TS-W22



Inverter Duty Motor
Severe Duty

MADE IN BRAZIL
11432185

PH3 60Hz Fr. 447/9TS 1000m.a.s.l. IP55 TEFC 2542lb

V 460

A 269

HP 250

kW 185

SF 1.15

SFA 309

RPM 3573

PF 0.90

AMB 40°C

INS cl. F DT80K

NEMA NOM EFF 95.8%

DUTY CONT.

DES B Code G

GUARANT. EFF 95.0%

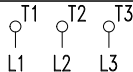

460V



→ 6314-C3 (27g) 70BC03X30

→ 6314-C3 (27g) 70BC03X30



MOBIL POLYREX EM (4000h)

