

DATA SHEET

Three Phase Induction Motor - Squirrel Cage



Customer :				
Product line		: NEMA Premium Efficiency Three-Phase	Product code :	13472772
			Catalog # :	30018ET3G449TC-W22
Frame	: 447/9TC	Cooling method	: IC411 - TEFC	
Insulation class	: F	Mounting	: F-1	
Duty cycle	: Cont.(S1)	Rotation ¹	: Both (CW and CCW)	
Ambient temperature	: -20°C to +40°C	Starting method	: Direct On Line	
Altitude	: 1000 m.a.s.l.	Approx. weight ²	: 2865 lb	
Protection degree	: IP55	Moment of inertia (J)	: 89.6 sq.ft.lb	
Design	: B			
Output [HP]	300	250	250	250
Poles	4	4	4	4
Frequency [Hz]	60	50	50	50
Rated voltage [V]	460	380	400	415
Rated current [A]	330	337	320	311
L. R. Amperes [A]	2145	2056	2144	2239
LRC [A]	6.5x(Code G)	6.1x(Code F)	6.7x(Code G)	7.2x(Code H)
No load current [A]	105	104	111	116
Rated speed [RPM]	1780	1480	1480	1485
Slip [%]	1.11	1.33	1.33	1.00
Rated torque [ft.lb]	885	887	887	884
Locked rotor torque [%]	250	210	240	260
Breakdown torque [%]	250	220	250	270
Service factor	1.15	1.00	1.00	1.00
Temperature rise	80 K	105 K	105 K	105 K
Locked rotor time	28s (cold) 16s (hot)	18s (cold) 10s (hot)	18s (cold) 10s (hot)	18s (cold) 10s (hot)
Noise level ²	75.0 dB(A)	71.0 dB(A)	71.0 dB(A)	71.0 dB(A)
Efficiency (%)	25%			
	50%	95.8	95.8	95.8
	75%	96.2	95.8	96.2
	100%	96.2	96.0	96.0
Power Factor	25%			
	50%	0.77	0.78	0.75
	75%	0.84	0.84	0.83
	100%	0.87	0.87	0.87
Bearing type	: <u>Drive end</u> 6322 C3 <u>Non drive end</u> 6319 C3	Foundation loads		
Sealing	: WSeal WSeal	Max. traction	: 4931 lb	
Lubrication interval	: 6000 h 8000 h	Max. compression	: 7796 lb	
Lubricant amount	: 60 g 45 g			
Lubricant type	: Mobil Polyrex EM			
Notes				
This revision replaces and cancel the previous one, which must be eliminated. (1) Looking the motor from the shaft end. (2) Measured at 1m and with tolerance of +3dB(A). (3) Approximate weight subject to changes after manufacturing process. (4) At 100% of full load.		These are average values based on tests with sinusoidal power supply, subject to the tolerances stipulated in NEMA MG-1.		
Rev.	Changes Summary		Performed	Checked
				Date
Performed by				
Checked by			Page	Revision
Date	12/04/2022		1 / 21	

TORQUE AND CURRENT VS SPEED CURVE

Three Phase Induction Motor - Squirrel Cage



Customer :

Product line : NEMA Premium Efficiency Three-Phase

Product code : 13472772

Catalog # : 30018ET3G449TC-W22

TORQUE AND CURRENT VS SPEED CURVE

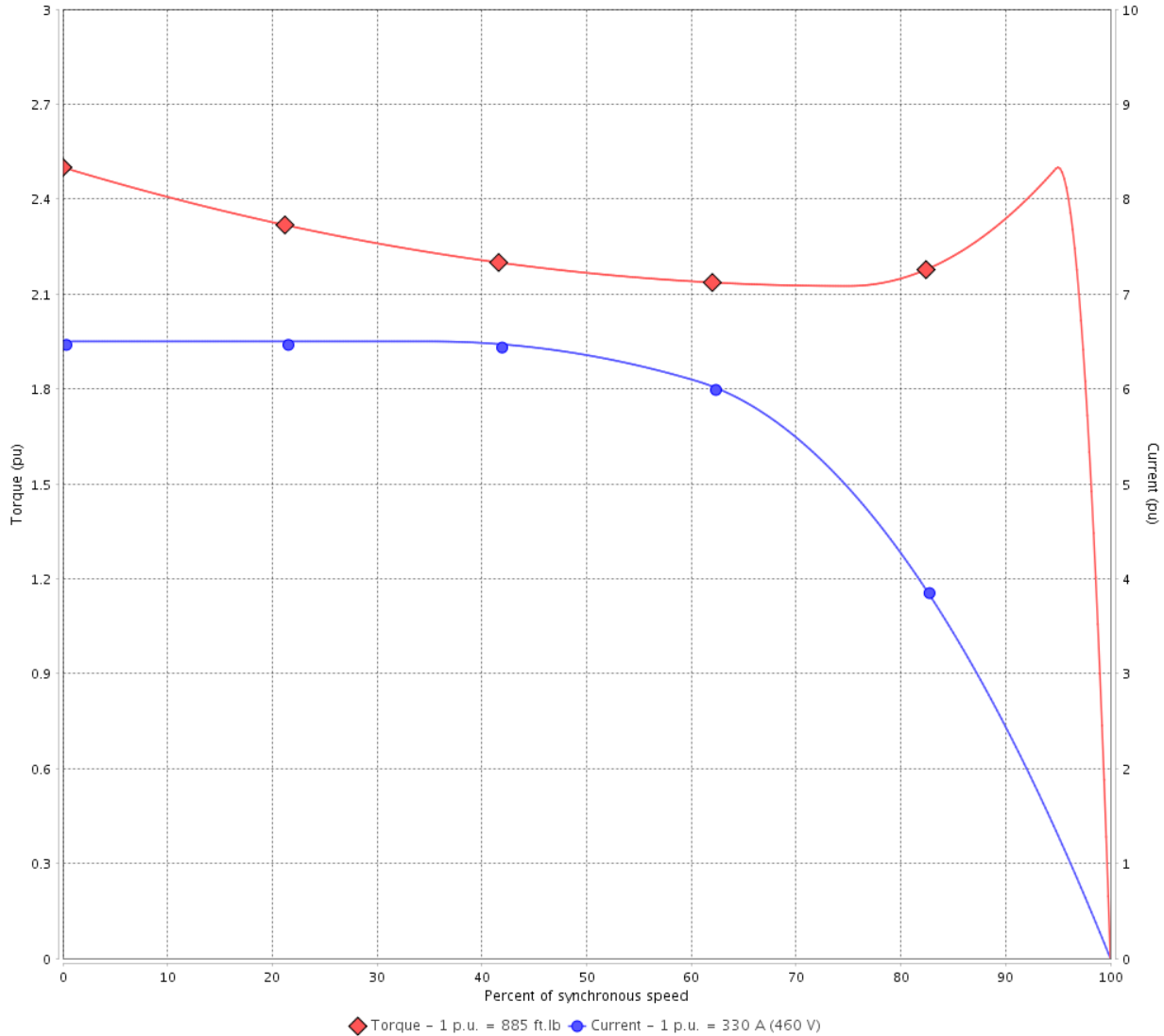

Performance : 460 V 60 Hz 4P

Rated current	: 330 A	Moment of inertia (J)	: 89.6 sq.ft.lb
LRC	: 6.5	Duty cycle	: Cont.(S1)
Rated torque	: 885 ft.lb	Insulation class	: F
Locked rotor torque	: 250 %	Service factor	: 1.15
Breakdown torque	: 250 %	Temperature rise	: 80 K
Rated speed	: 1780 rpm	Design	: B

Locked rotor time : 28s (cold) 16s (hot)

Rev.	Changes Summary	Performed	Checked	Date
Performed by			Page 2 / 21	Revision
Checked by				
Date	12/04/2022			

TORQUE AND CURRENT VS SPEED CURVE



Three Phase Induction Motor - Squirrel Cage

Customer :

Product line : NEMA Premium Efficiency Three-Phase

Product code : 13472772

Catalog # : 30018ET3G449TC-W22

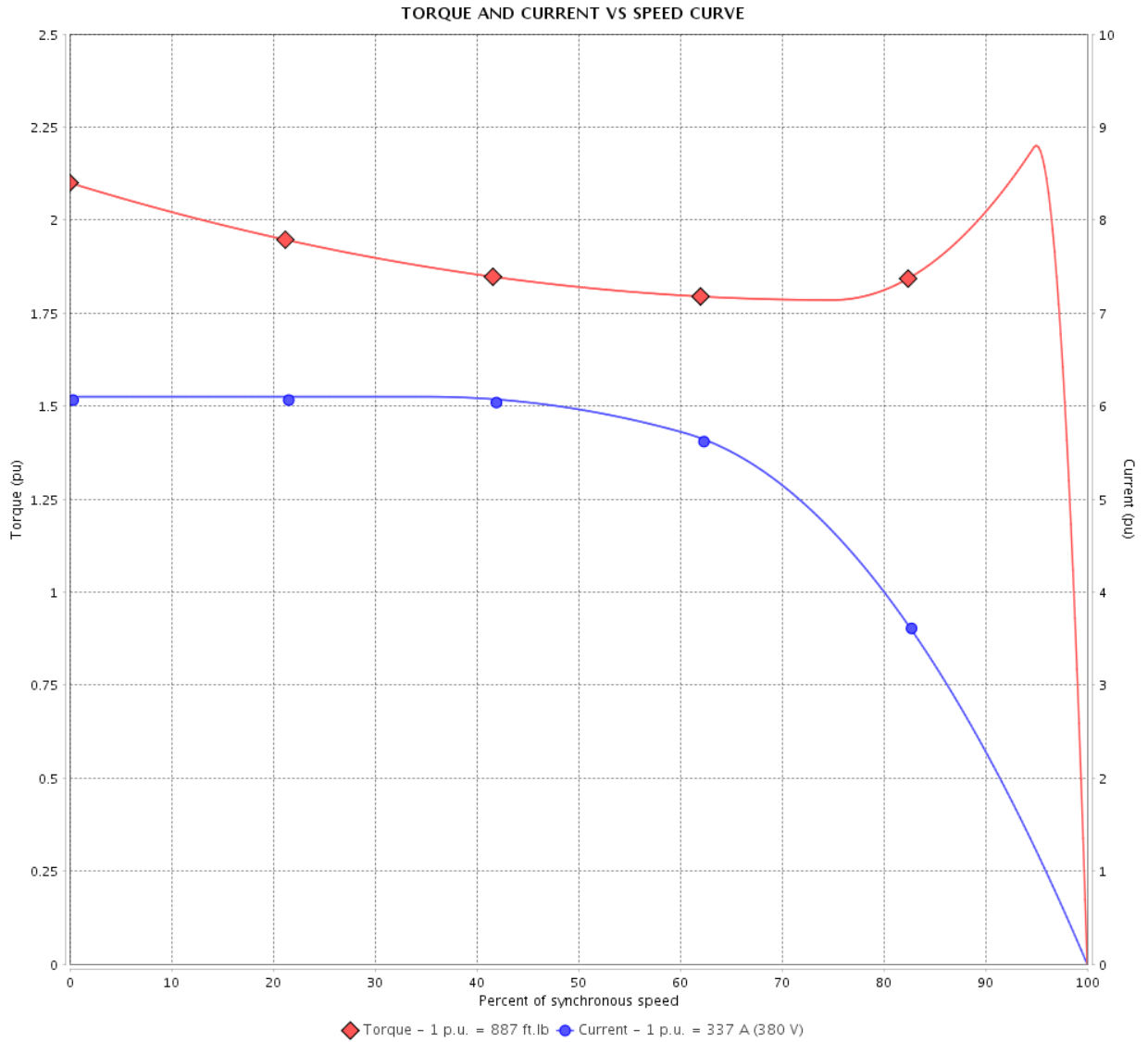

Performance : 380 V 50 Hz 4P IE3

Rated current	: 337 A	Moment of inertia (J)	: 89.6 sq.ft.lb
LRC	: 6.1	Duty cycle	: Cont.(S1)
Rated torque	: 887 ft.lb	Insulation class	: F
Locked rotor torque	: 210 %	Service factor	: 1.00
Breakdown torque	: 220 %	Temperature rise	: 105 K
Rated speed	: 1480 rpm	Design	: B

Locked rotor time : 18s (cold) 10s (hot)

Rev.	Changes Summary	Performed	Checked	Date
Performed by			Page 3 / 21	Revision
Checked by				
Date	12/04/2022			

TORQUE AND CURRENT VS SPEED CURVE

Three Phase Induction Motor - Squirrel Cage



Customer :

Product line : NEMA Premium Efficiency Three-Phase

Product code : 13472772

Catalog # : 30018ET3G449TC-W22

TORQUE AND CURRENT VS SPEED CURVE

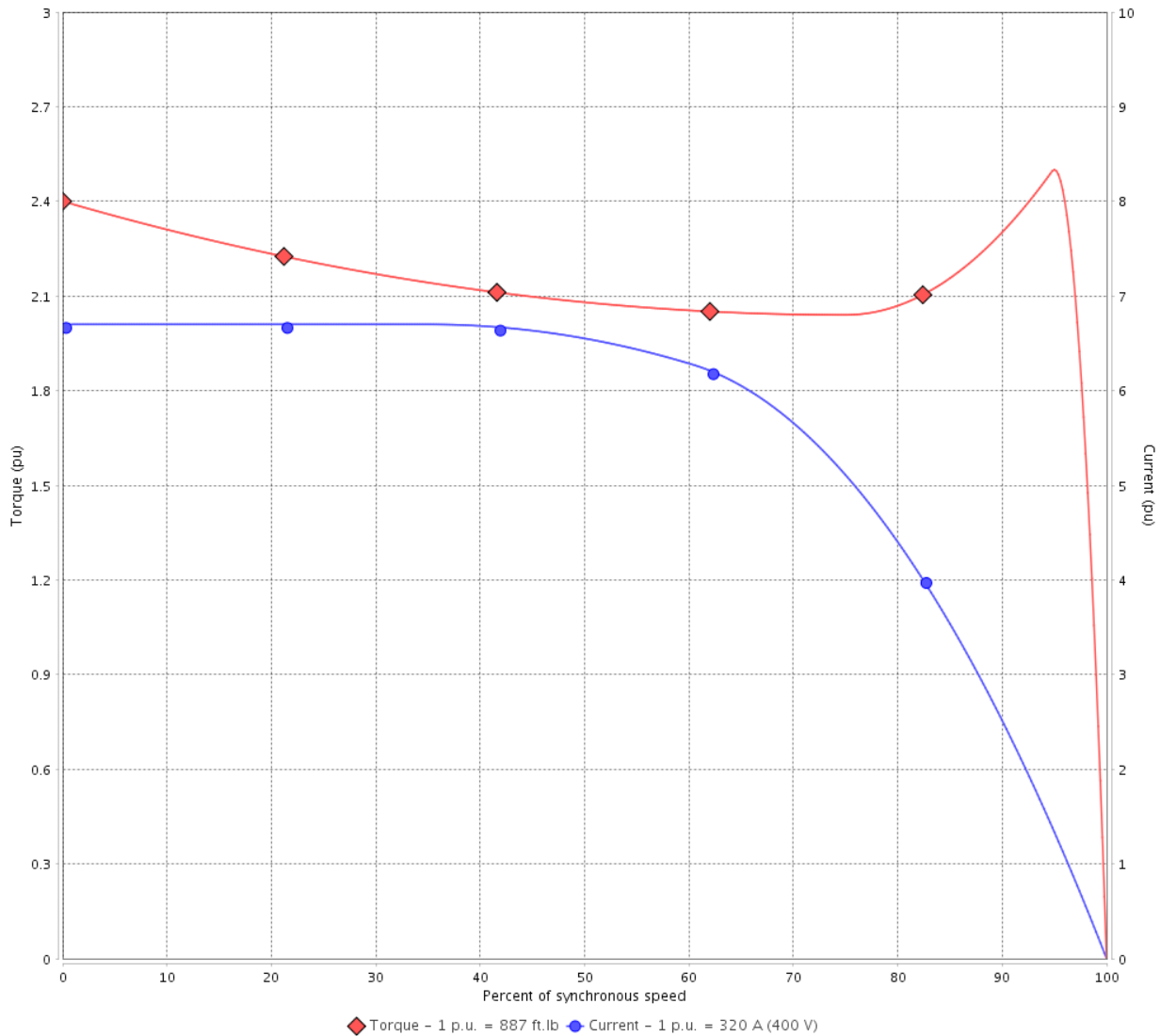

Performance : 400 V 50 Hz 4P IE3

Rated current	: 320 A	Moment of inertia (J)	: 89.6 sq.ft.lb
LRC	: 6.7	Duty cycle	: Cont.(S1)
Rated torque	: 887 ft.lb	Insulation class	: F
Locked rotor torque	: 240 %	Service factor	: 1.00
Breakdown torque	: 250 %	Temperature rise	: 105 K
Rated speed	: 1480 rpm	Design	: B

Locked rotor time : 18s (cold) 10s (hot)

Rev.	Changes Summary	Performed	Checked	Date
Performed by			Page 4 / 21	Revision
Checked by				
Date	12/04/2022			

TORQUE AND CURRENT VS SPEED CURVE



Three Phase Induction Motor - Squirrel Cage

Customer :

Product line : NEMA Premium Efficiency Three-Phase

Product code : 13472772

Catalog # : 30018ET3G449TC-W22

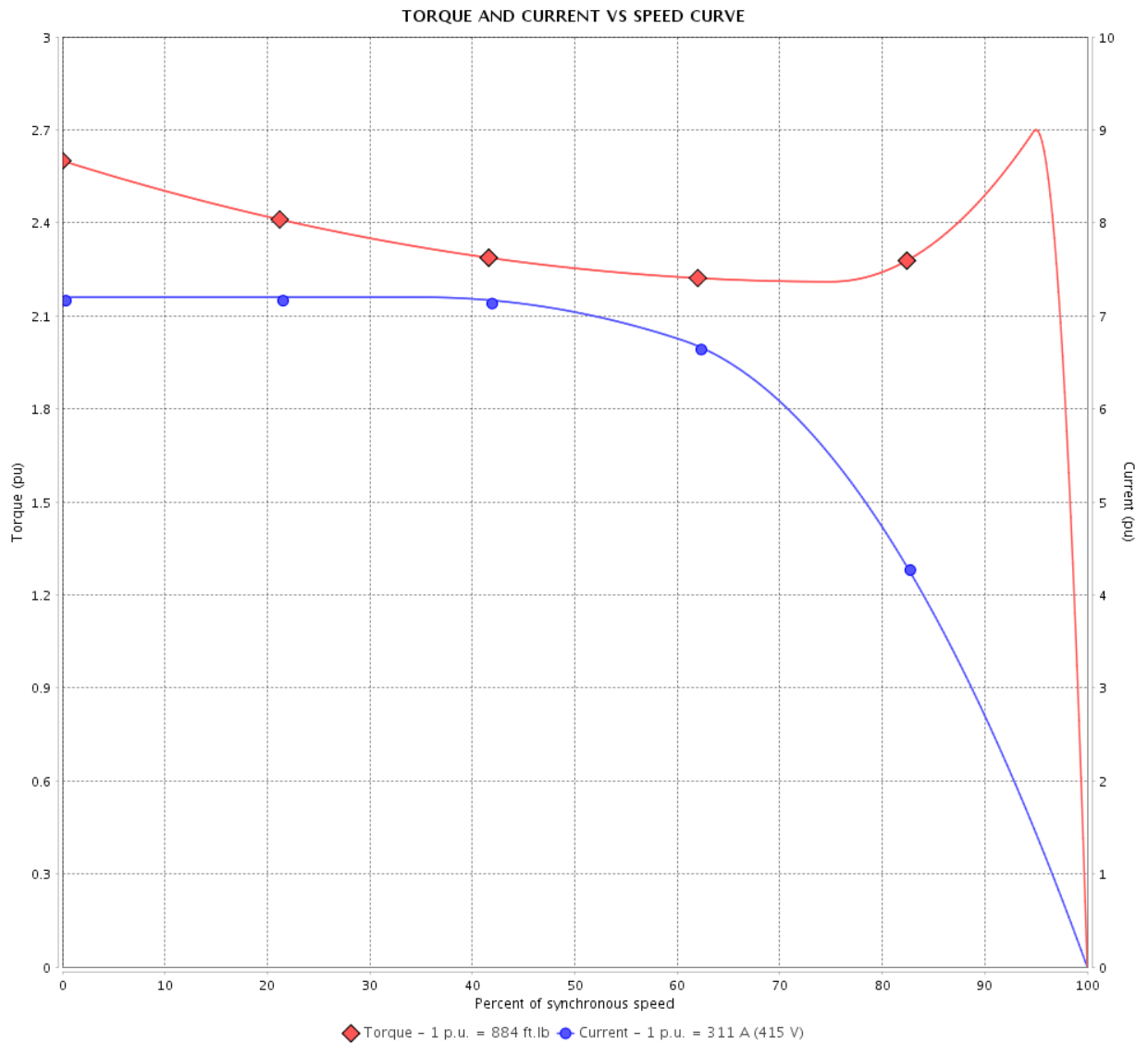

Performance : 415 V 50 Hz 4P IE3

Rated current	: 311 A	Moment of inertia (J)	: 89.6 sq.ft.lb
LRC	: 7.2	Duty cycle	: Cont.(S1)
Rated torque	: 884 ft.lb	Insulation class	: F
Locked rotor torque	: 260 %	Service factor	: 1.00
Breakdown torque	: 270 %	Temperature rise	: 105 K
Rated speed	: 1485 rpm	Design	: B

Locked rotor time : 18s (cold) 10s (hot)

Rev.	Changes Summary	Performed	Checked	Date
Performed by			Page 5 / 21	Revision
Checked by				
Date	12/04/2022			

LOAD PERFORMANCE CURVE

Three Phase Induction Motor - Squirrel Cage



Customer : _____

Product line : NEMA Premium Efficiency Three-Phase

Product code : 13472772

Catalog # : 30018ET3G449TC-W22

LOAD PERFORMANCE CURVE

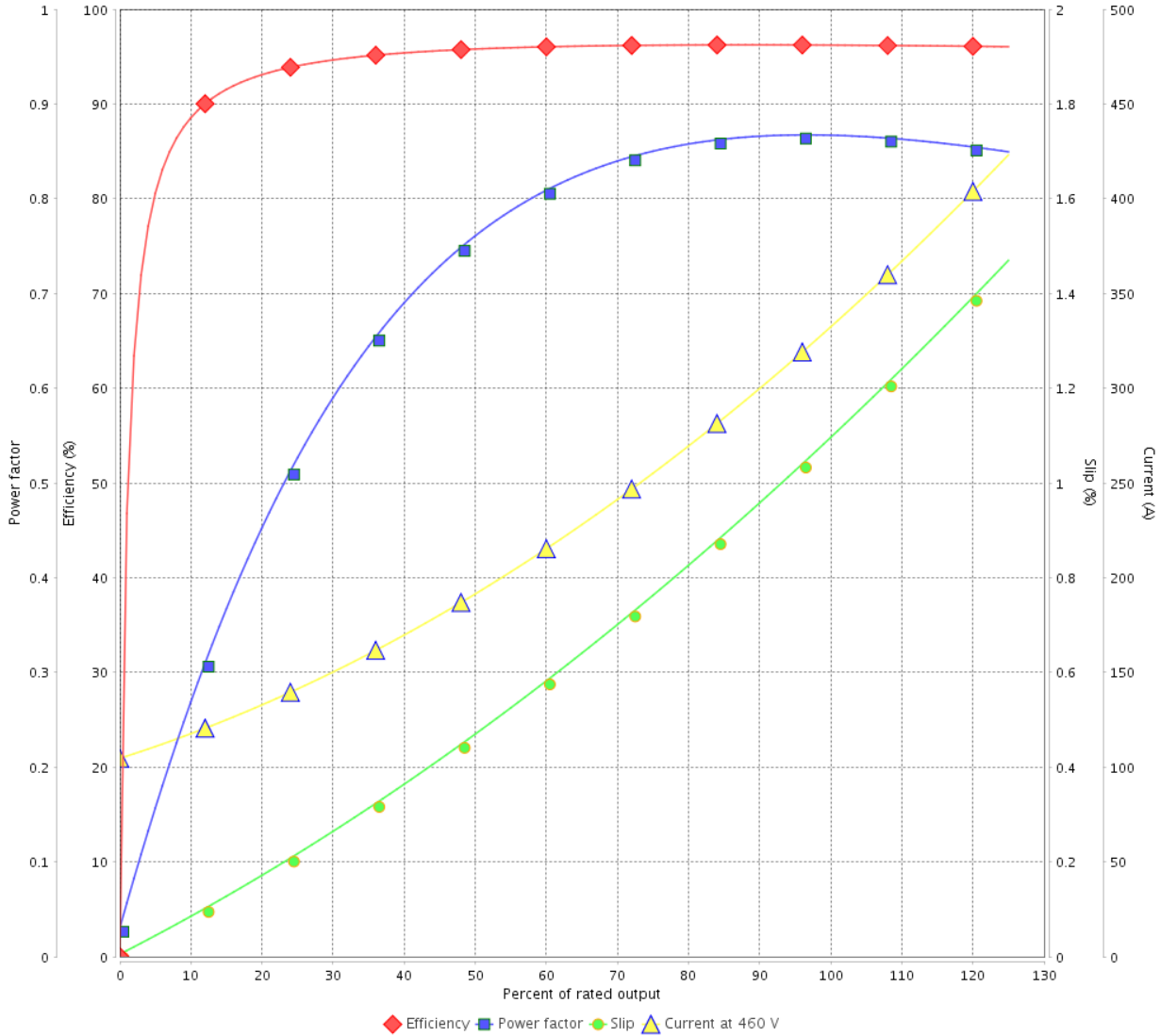

Performance : 460 V 60 Hz 4P

Rated current : 330 A
 LRC : 6.5
 Rated torque : 885 ft.lb
 Locked rotor torque : 250 %
 Breakdown torque : 250 %
 Rated speed : 1780 rpm

Moment of inertia (J) : 89.6 sq.ft.lb
 Duty cycle : Cont.(S1)
 Insulation class : F
 Service factor : 1.15
 Temperature rise : 80 K
 Design : B

Rev.	Changes Summary	Performed	Checked	Date
Performed by			Page 6 / 21	Revision
Checked by				
Date	12/04/2022			

LOAD PERFORMANCE CURVE

Three Phase Induction Motor - Squirrel Cage



Customer : _____

Product line : NEMA Premium Efficiency Three-Phase

Product code : 13472772

Catalog # : 30018ET3G449TC-W22

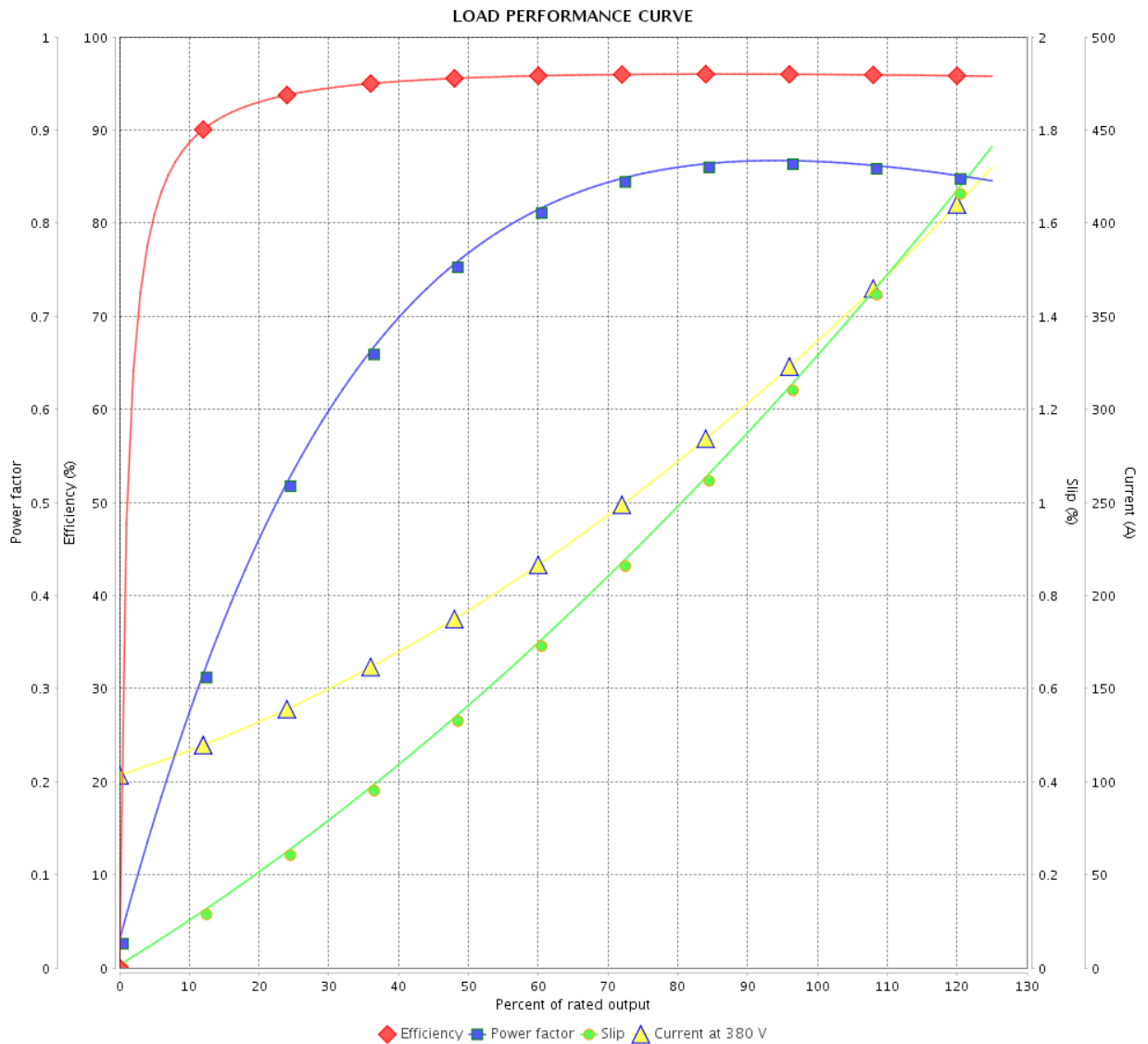

Performance : 380 V 50 Hz 4P IE3

Rated current : 337 A
 LRC : 6.1
 Rated torque : 887 ft.lb
 Locked rotor torque : 210 %
 Breakdown torque : 220 %
 Rated speed : 1480 rpm

Moment of inertia (J) : 89.6 sq.ft.lb
 Duty cycle : Cont.(S1)
 Insulation class : F
 Service factor : 1.00
 Temperature rise : 105 K
 Design : B

Rev.	Changes Summary	Performed	Checked	Date
Performed by		Page		Revision
Checked by		7 / 21		
Date		12/04/2022		

LOAD PERFORMANCE CURVE

Three Phase Induction Motor - Squirrel Cage



Customer : _____

Product line : NEMA Premium Efficiency Three-Phase

Product code : 13472772

Catalog # : 30018ET3G449TC-W22

LOAD PERFORMANCE CURVE

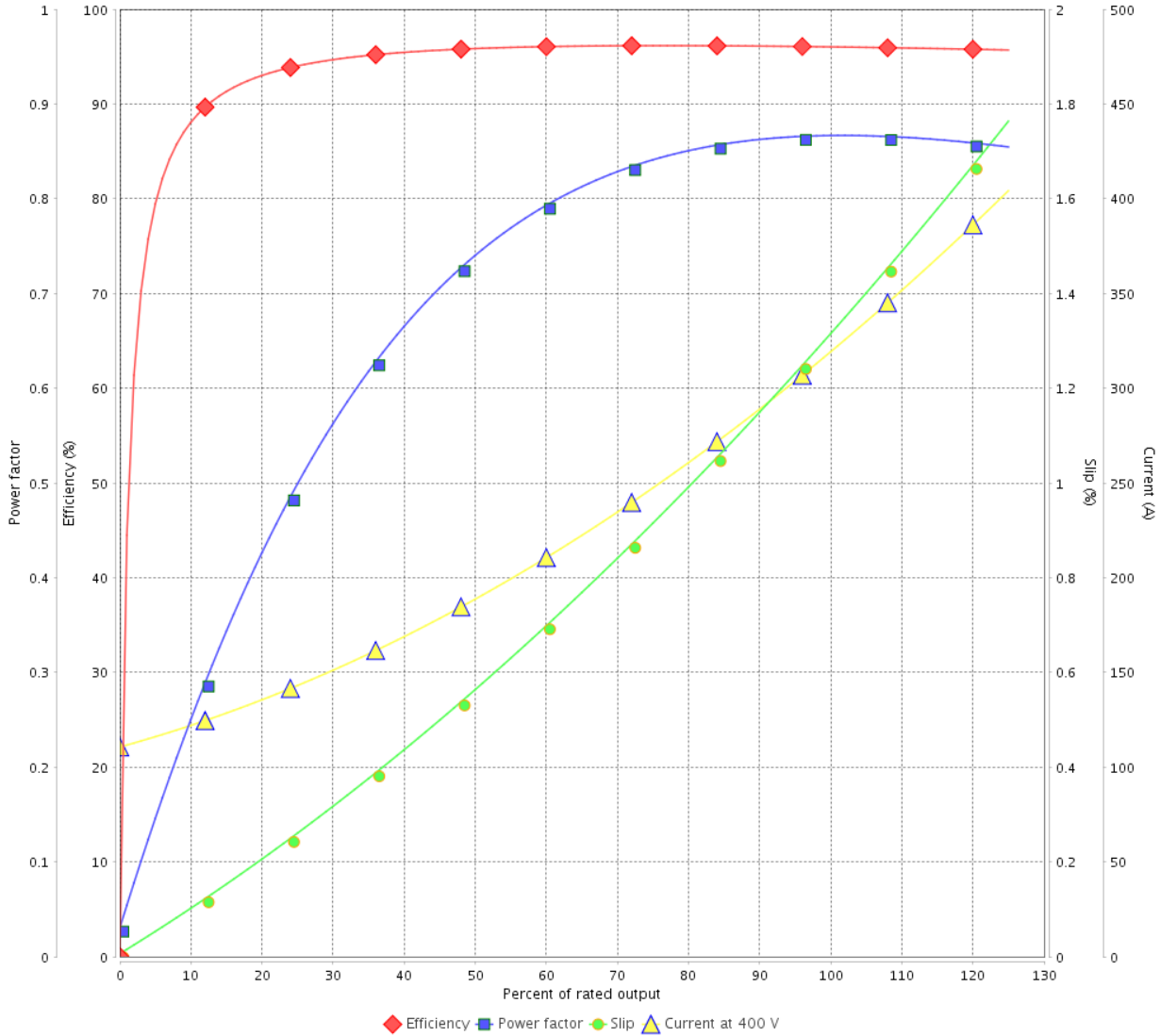

Performance : 400 V 50 Hz 4P IE3

Rated current : 320 A
 LRC : 6.7
 Rated torque : 887 ft.lb
 Locked rotor torque : 240 %
 Breakdown torque : 250 %
 Rated speed : 1480 rpm

Moment of inertia (J) : 89.6 sq.ft.lb
 Duty cycle : Cont.(S1)
 Insulation class : F
 Service factor : 1.00
 Temperature rise : 105 K
 Design : B

Rev.	Changes Summary	Performed	Checked	Date
Performed by			Page 8 / 21	Revision
Checked by				
Date	12/04/2022			

LOAD PERFORMANCE CURVE

Three Phase Induction Motor - Squirrel Cage



Customer :

Product line : NEMA Premium Efficiency Three-Phase

Product code : 13472772

Catalog # : 30018ET3G449TC-W22

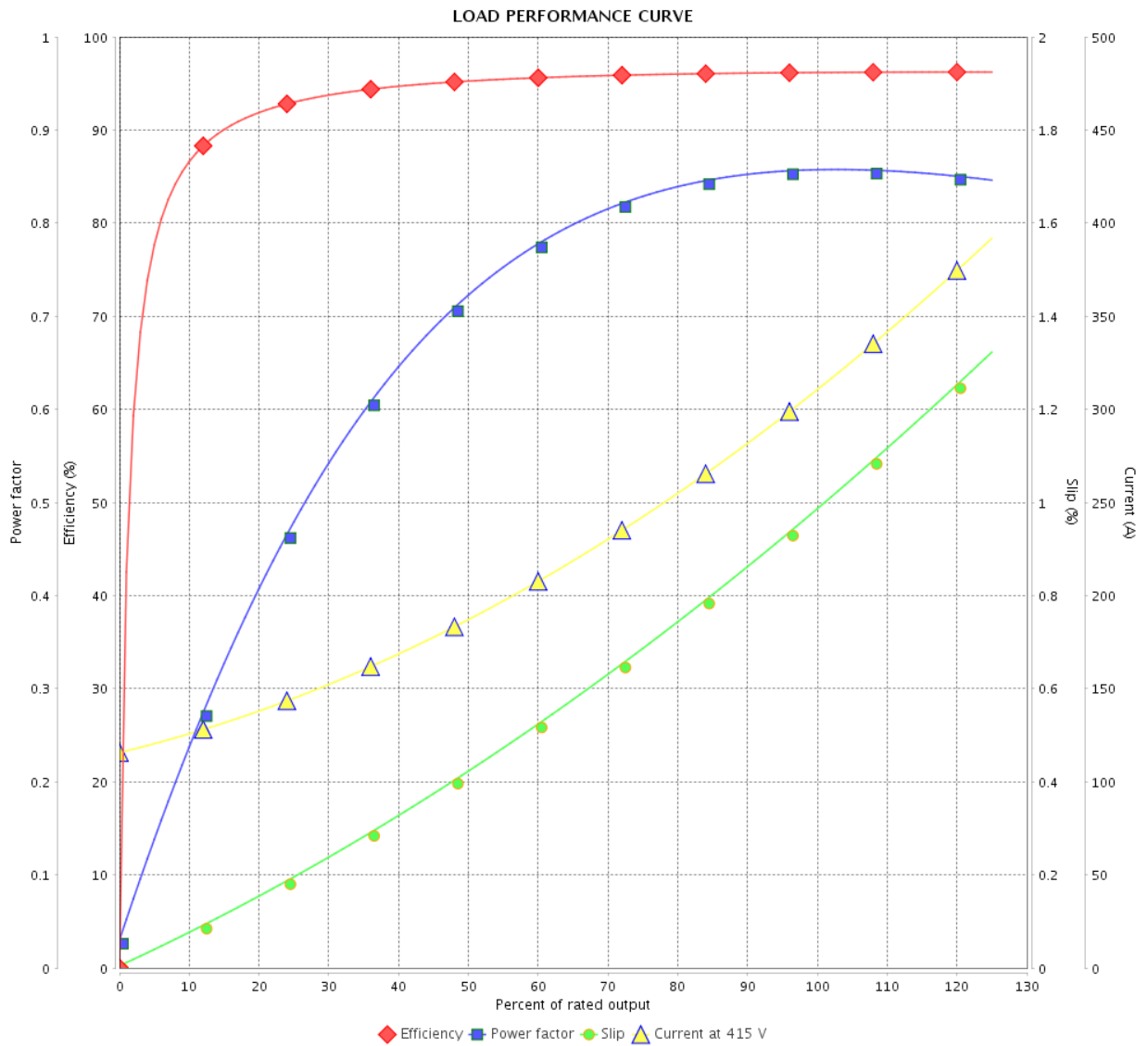

Performance : 415 V 50 Hz 4P IE3

Rated current : 311 A
 LRC : 7.2
 Rated torque : 884 ft.lb
 Locked rotor torque : 260 %
 Breakdown torque : 270 %
 Rated speed : 1485 rpm

Moment of inertia (J) : 89.6 sq.ft.lb
 Duty cycle : Cont.(S1)
 Insulation class : F
 Service factor : 1.00
 Temperature rise : 105 K
 Design : B

Rev.	Changes Summary	Performed	Checked	Date
Performed by			Page	Revision
Checked by			9 / 21	
Date	12/04/2022			

THERMAL LIMIT CURVE



Three Phase Induction Motor - Squirrel Cage

Customer :

Product line : NEMA Premium Efficiency Three-Phase

Product code : 13472772

Catalog # : 30018ET3G449TC-W22

Performance : 460 V 60 Hz 4P

Rated current	: 330 A	Moment of inertia (J)	: 89.6 sq.ft.lb
LRC	: 6.5	Duty cycle	: Cont.(S1)
Rated torque	: 885 ft.lb	Insulation class	: F
Locked rotor torque	: 250 %	Service factor	: 1.15
Breakdown torque	: 250 %	Temperature rise	: 80 K
Rated speed	: 1780 rpm	Design	: B

Heating constant

Cooling constant

Rev.	Changes Summary	Performed	Checked	Date
Performed by				
Checked by			Page	Revision
Date	12/04/2022		10 / 21	

THERMAL LIMIT CURVE

Three Phase Induction Motor - Squirrel Cage



Customer : _____

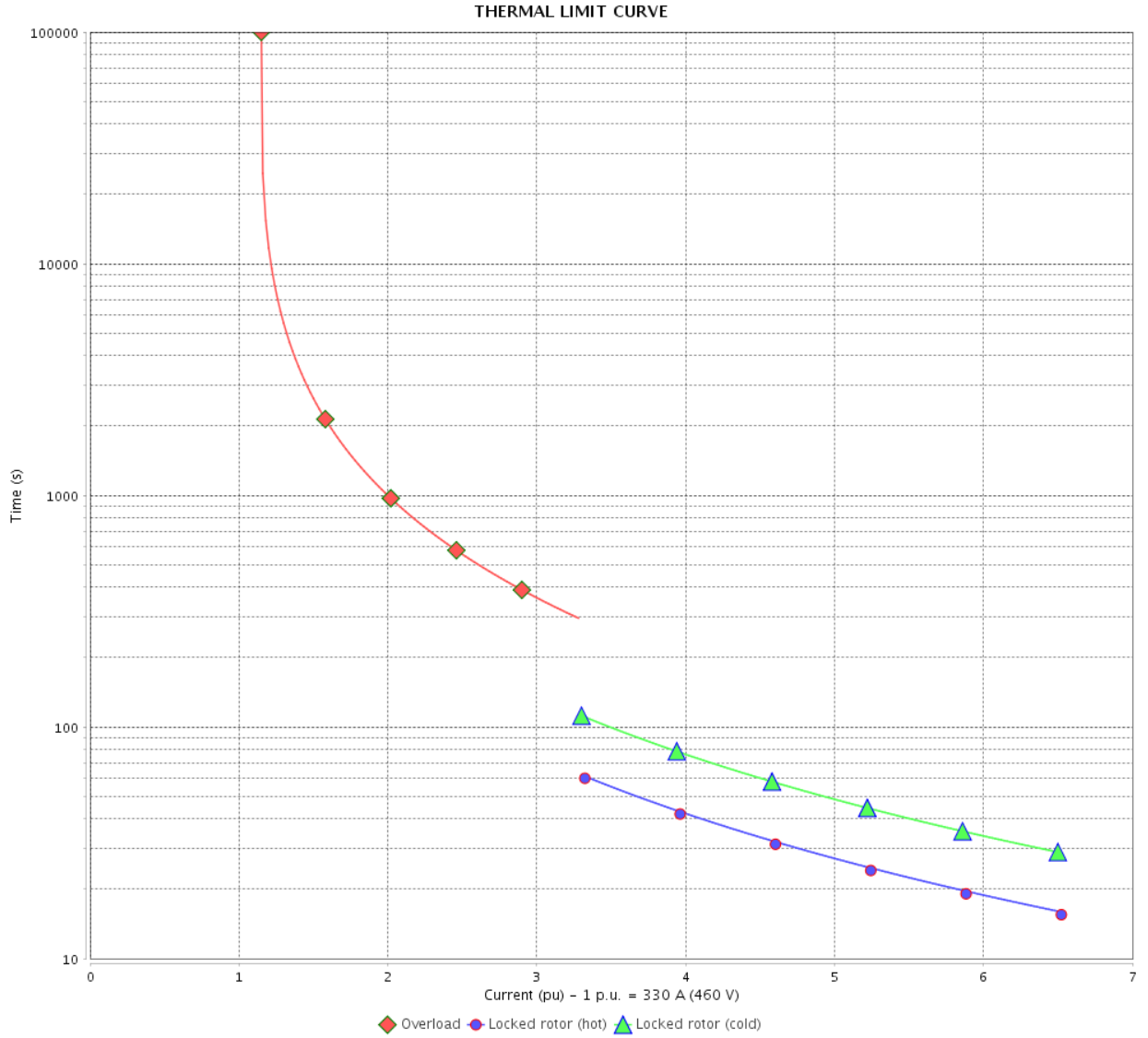

Rev.	Changes Summary	Performed	Checked	Date
Performed by		Page		Revision
Checked by		11 / 21		
Date		12/04/2022		

THERMAL LIMIT CURVE

Three Phase Induction Motor - Squirrel Cage



Customer :

Product line : NEMA Premium Efficiency Three-Phase
Product code : 13472772
Catalog # : 30018ET3G449TC-W22

Performance : 380 V 50 Hz 4P IE3

Rated current	: 337 A	Moment of inertia (J)	: 89.6 sq.ft.lb
LRC	: 6.1	Duty cycle	: Cont.(S1)
Rated torque	: 887 ft.lb	Insulation class	: F
Locked rotor torque	: 210 %	Service factor	: 1.00
Breakdown torque	: 220 %	Temperature rise	: 105 K
Rated speed	: 1480 rpm	Design	: B

Heating constant

Cooling constant

Rev.	Changes Summary	Performed	Checked	Date
Performed by				
Checked by			Page	Revision
Date	12/04/2022		12 / 21	

THERMAL LIMIT CURVE

Three Phase Induction Motor - Squirrel Cage



Customer : _____

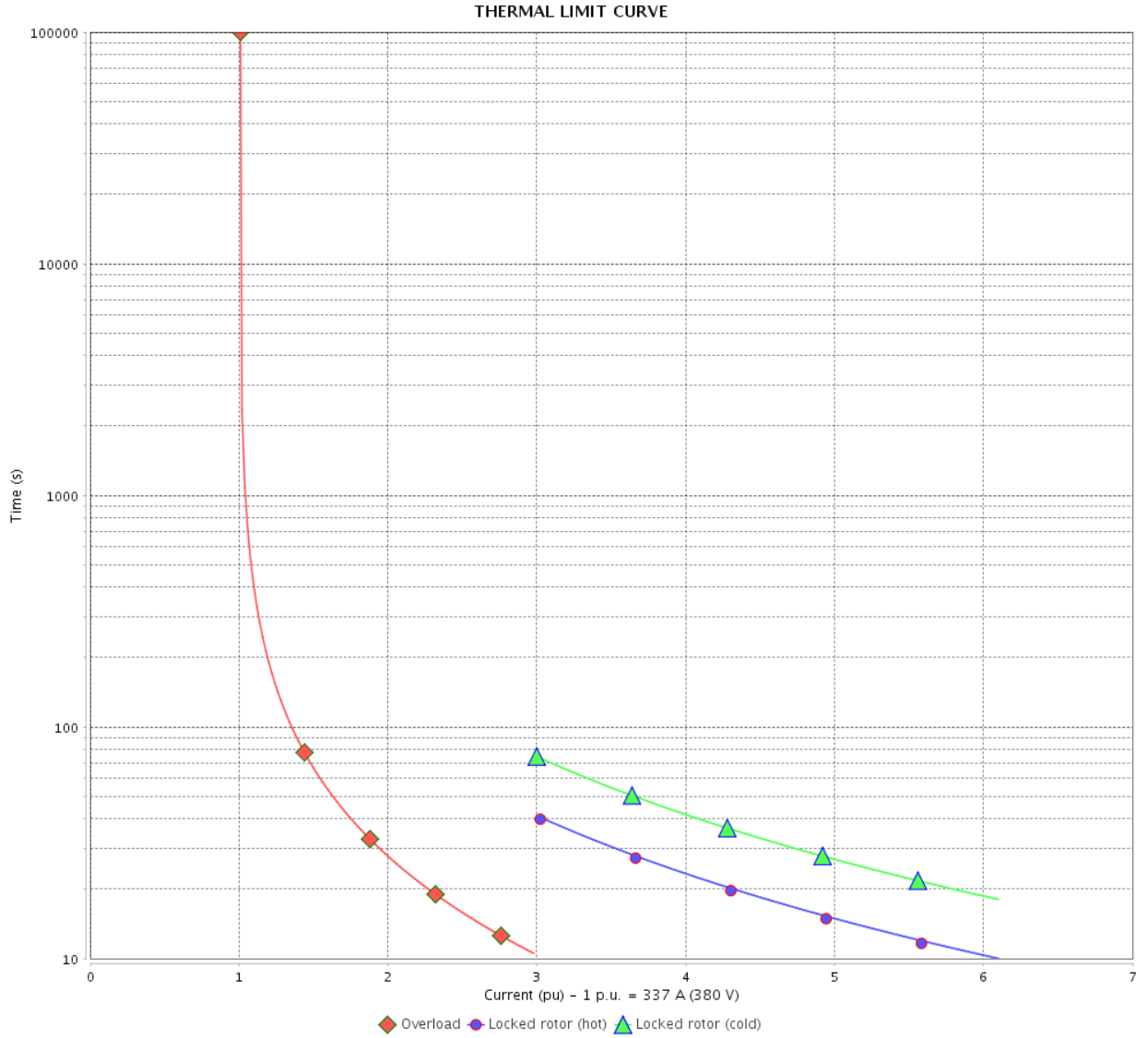

Rev.	Changes Summary	Performed	Checked	Date
Performed by		Page 13 / 21		Revision
Checked by				
Date				

THERMAL LIMIT CURVE



Three Phase Induction Motor - Squirrel Cage

Customer :

Product line : NEMA Premium Efficiency Three-Phase
Product code : 13472772
Catalog # : 30018ET3G449TC-W22

Performance : 400 V 50 Hz 4P IE3

Rated current	: 320 A	Moment of inertia (J)	: 89.6 sq.ft.lb
LRC	: 6.7	Duty cycle	: Cont.(S1)
Rated torque	: 887 ft.lb	Insulation class	: F
Locked rotor torque	: 240 %	Service factor	: 1.00
Breakdown torque	: 250 %	Temperature rise	: 105 K
Rated speed	: 1480 rpm	Design	: B

Heating constant

Cooling constant

Rev.	Changes Summary	Performed	Checked	Date
Performed by				
Checked by			Page	Revision
Date	12/04/2022		14 / 21	

THERMAL LIMIT CURVE

Three Phase Induction Motor - Squirrel Cage



Customer : _____

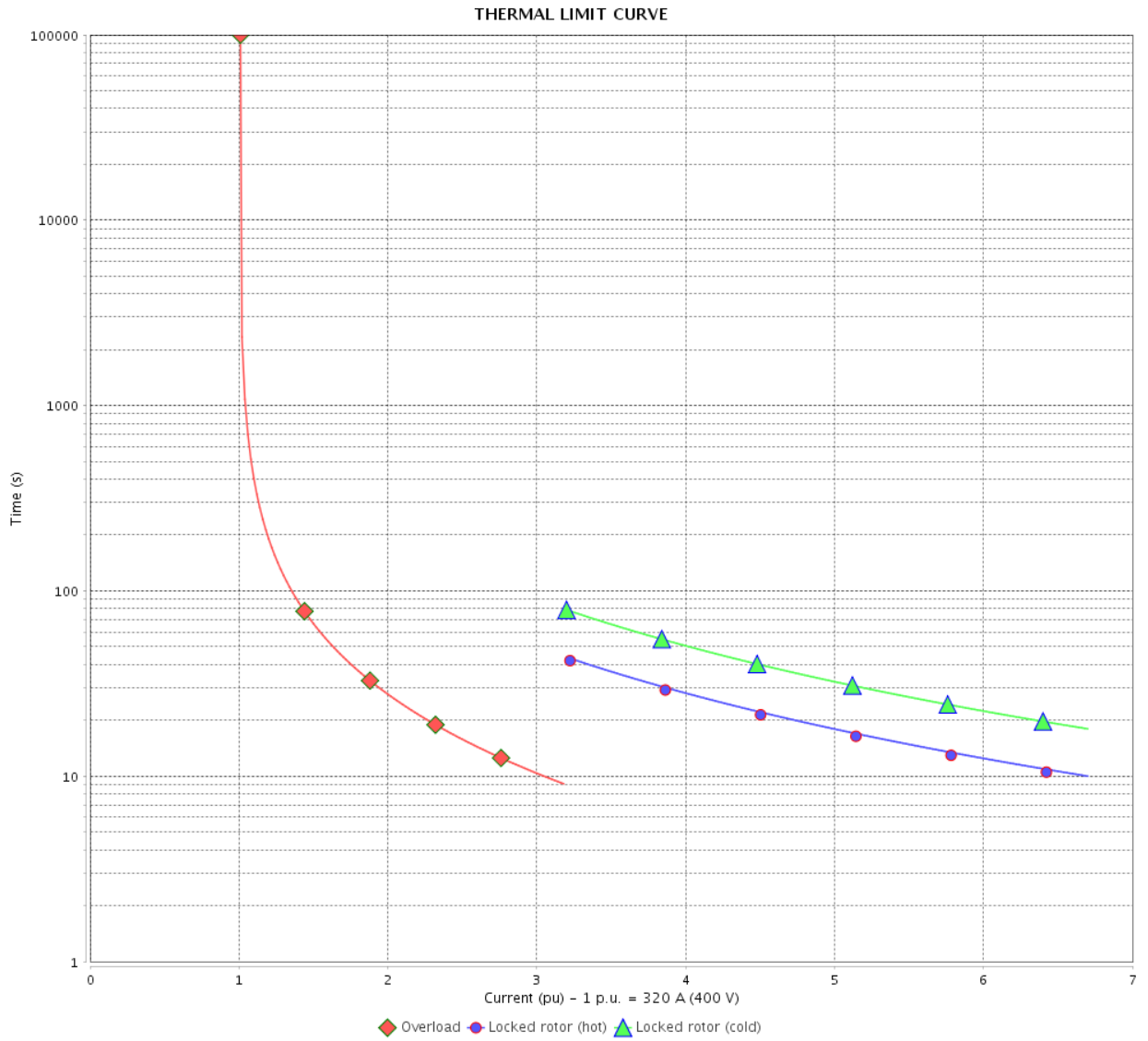

Rev.	Changes Summary	Performed	Checked	Date
Performed by				
Checked by				
Date				
			Page	Revision
			15 / 21	

THERMAL LIMIT CURVE



Three Phase Induction Motor - Squirrel Cage

Customer :

Product line : NEMA Premium Efficiency Three-Phase
Product code : 13472772
Catalog # : 30018ET3G449TC-W22

Performance : 415 V 50 Hz 4P IE3

Rated current	: 311 A	Moment of inertia (J)	: 89.6 sq.ft.lb
LRC	: 7.2	Duty cycle	: Cont.(S1)
Rated torque	: 884 ft.lb	Insulation class	: F
Locked rotor torque	: 260 %	Service factor	: 1.00
Breakdown torque	: 270 %	Temperature rise	: 105 K
Rated speed	: 1485 rpm	Design	: B

Heating constant

Cooling constant

Rev.	Changes Summary	Performed	Checked	Date
Performed by				
Checked by			Page	Revision
Date	12/04/2022		16 / 21	

THERMAL LIMIT CURVE

Three Phase Induction Motor - Squirrel Cage



Customer : _____

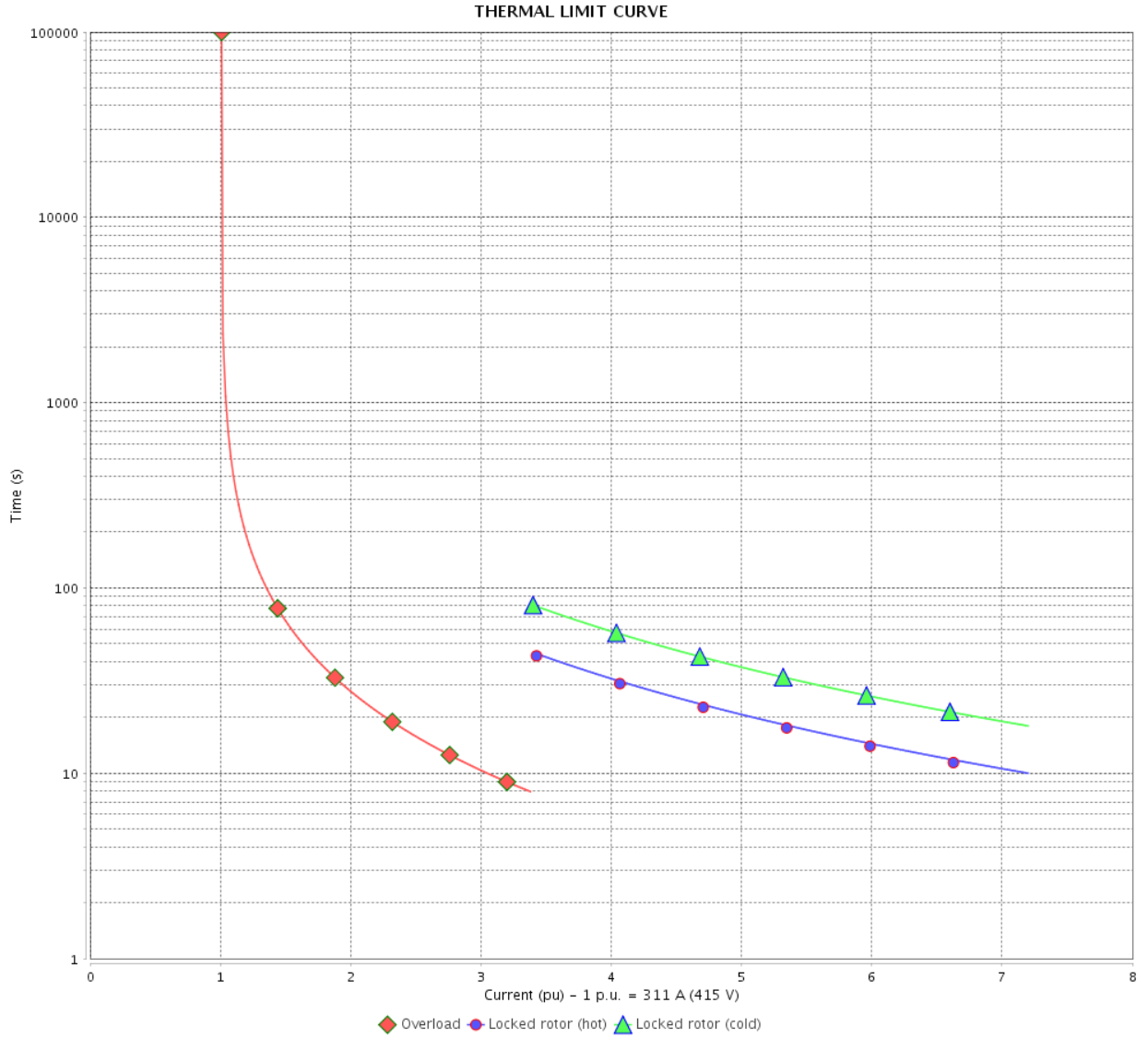

Rev.	Changes Summary	Performed	Checked	Date
Performed by		Page 17 / 21		Revision
Checked by				
Date				

VFD OPERATION CURVE

Three Phase Induction Motor - Squirrel Cage



Customer :

Product line : NEMA Premium Efficiency Three-Phase

Product code : 13472772

Catalog # : 30018ET3G449TC-W22

VFD OPERATION CURVE

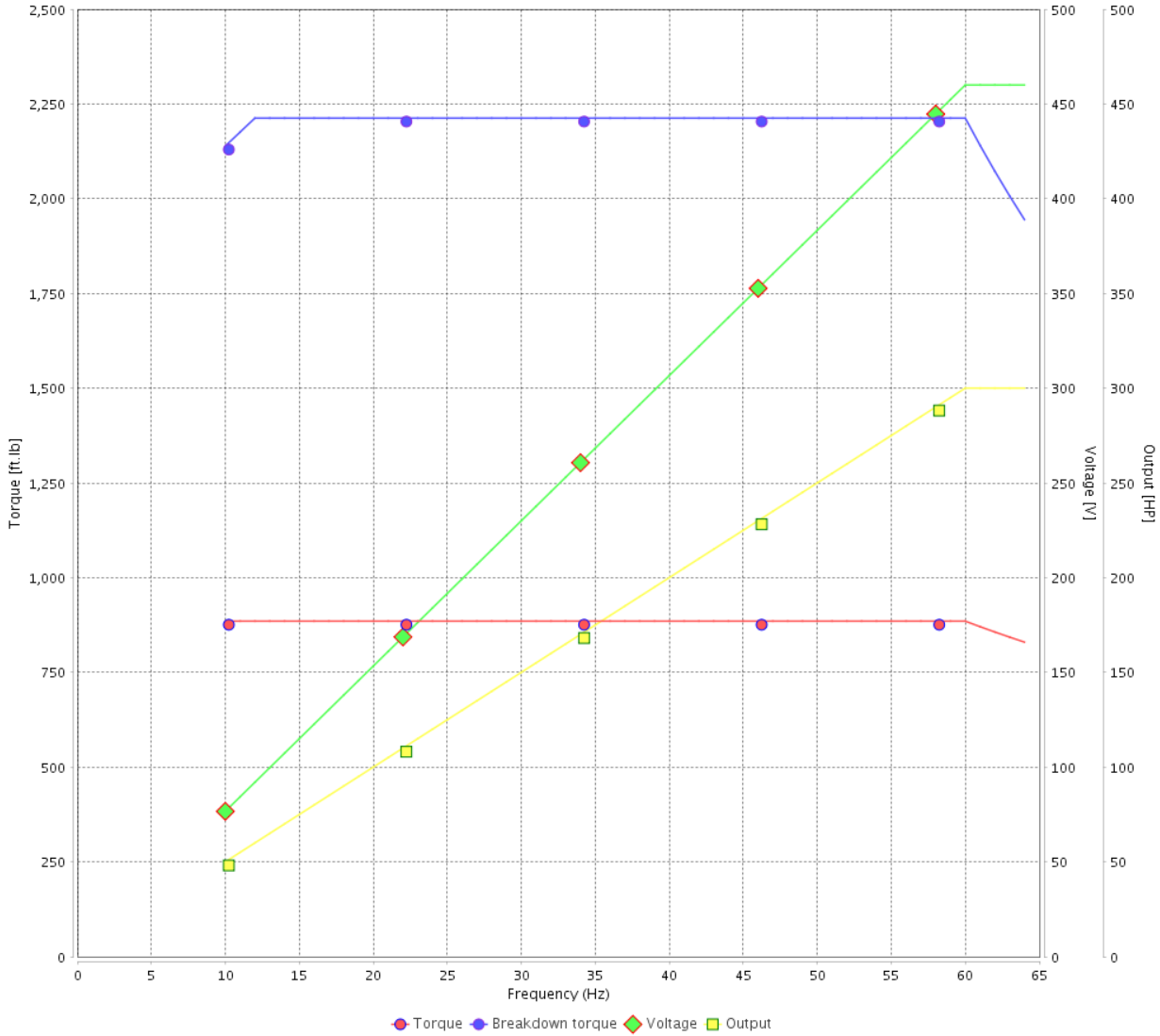

Performance : 460 V 60 Hz 4P

Rated current : 330 A
 LRC : 6.5
 Rated torque : 885 ft.lb
 Locked rotor torque : 250 %
 Breakdown torque : 250 %
 Rated speed : 1780 rpm

Moment of inertia (J) : 89.6 sq.ft.lb
 Duty cycle : Cont.(S1)
 Insulation class : F
 Service factor : 1.15
 Temperature rise : 80 K
 Design : B

Rev.	Changes Summary	Performed	Checked	Date
Performed by			Page 18 / 21	Revision
Checked by				
Date	12/04/2022			

VFD OPERATION CURVE

Three Phase Induction Motor - Squirrel Cage



Customer :

Product line : NEMA Premium Efficiency Three-Phase

Product code : 13472772

Catalog # : 30018ET3G449TC-W22

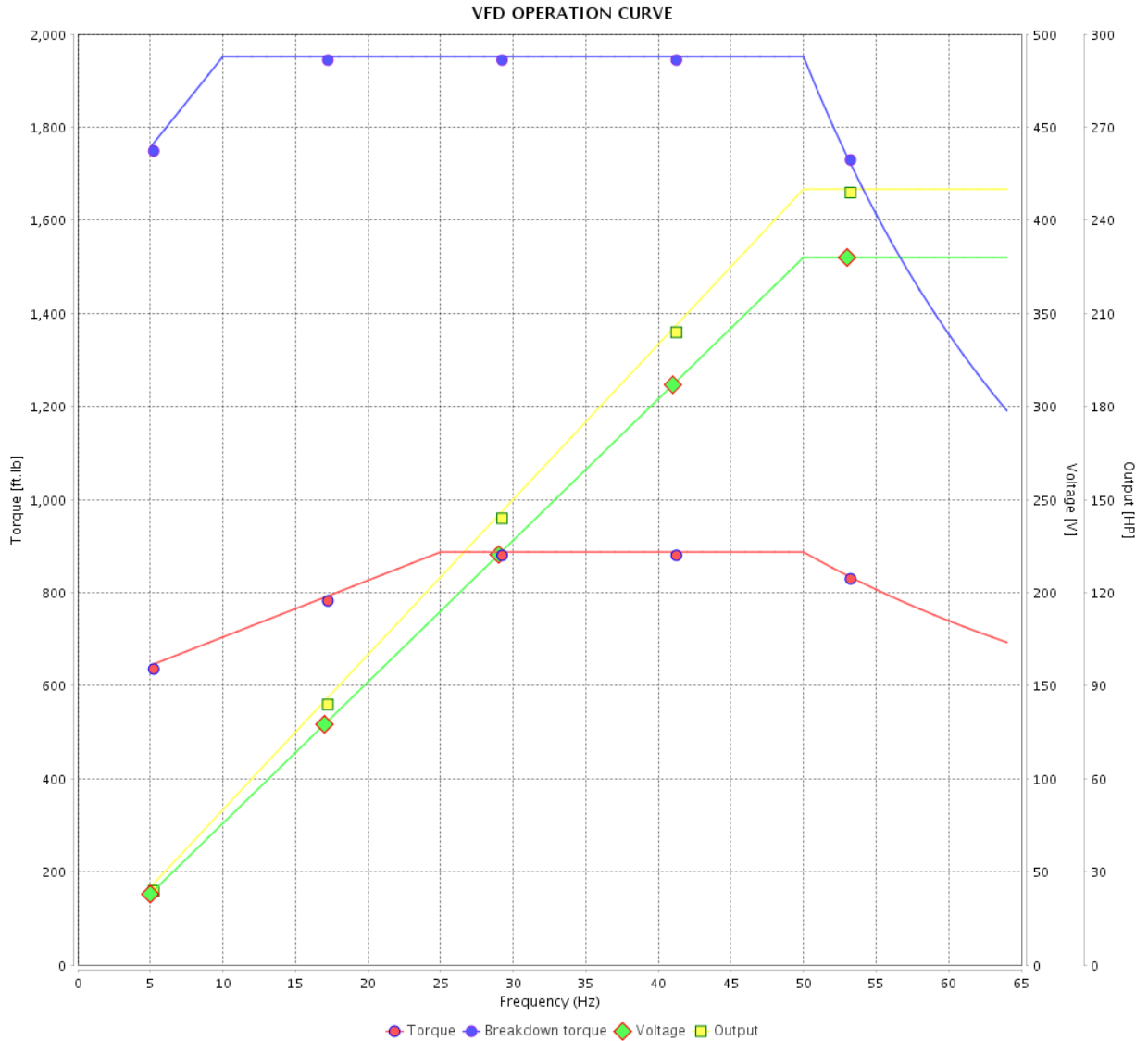

Performance : 380 V 50 Hz 4P IE3

Rated current : 337 A
 LRC : 6.1
 Rated torque : 887 ft.lb
 Locked rotor torque : 210 %
 Breakdown torque : 220 %
 Rated speed : 1480 rpm

Moment of inertia (J) : 89.6 sq.ft.lb
 Duty cycle : Cont.(S1)
 Insulation class : F
 Service factor : 1.00
 Temperature rise : 105 K
 Design : B

Rev.	Changes Summary	Performed	Checked	Date
Performed by			Page	Revision
Checked by				
Date				

VFD OPERATION CURVE

Three Phase Induction Motor - Squirrel Cage



Customer :

Product line : NEMA Premium Efficiency Three-Phase

Product code : 13472772

Catalog # : 30018ET3G449TC-W22

VFD OPERATION CURVE

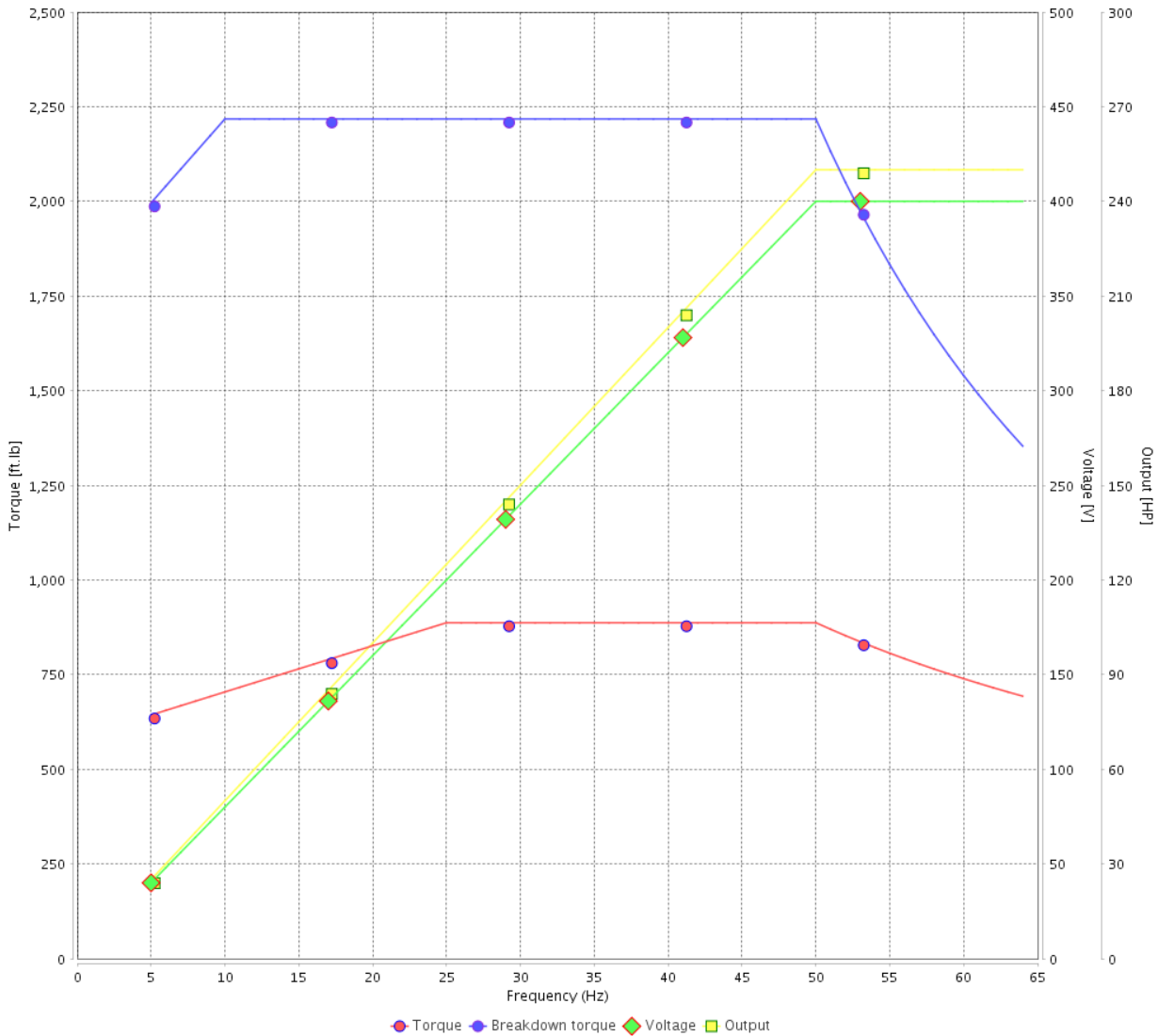

Performance : 400 V 50 Hz 4P IE3

Rated current	: 320 A	Moment of inertia (J)	: 89.6 sq.ft.lb
LRC	: 6.7	Duty cycle	: Cont.(S1)
Rated torque	: 887 ft.lb	Insulation class	: F
Locked rotor torque	: 240 %	Service factor	: 1.00
Breakdown torque	: 250 %	Temperature rise	: 105 K
Rated speed	: 1480 rpm	Design	: B

Rev.	Changes Summary	Performed	Checked	Date
Performed by			Page	Revision
Checked by			20 / 21	
Date	12/04/2022			

VFD OPERATION CURVE

Three Phase Induction Motor - Squirrel Cage



Customer : _____

Product line : NEMA Premium Efficiency Three-Phase

Product code : 13472772

Catalog # : 30018ET3G449TC-W22

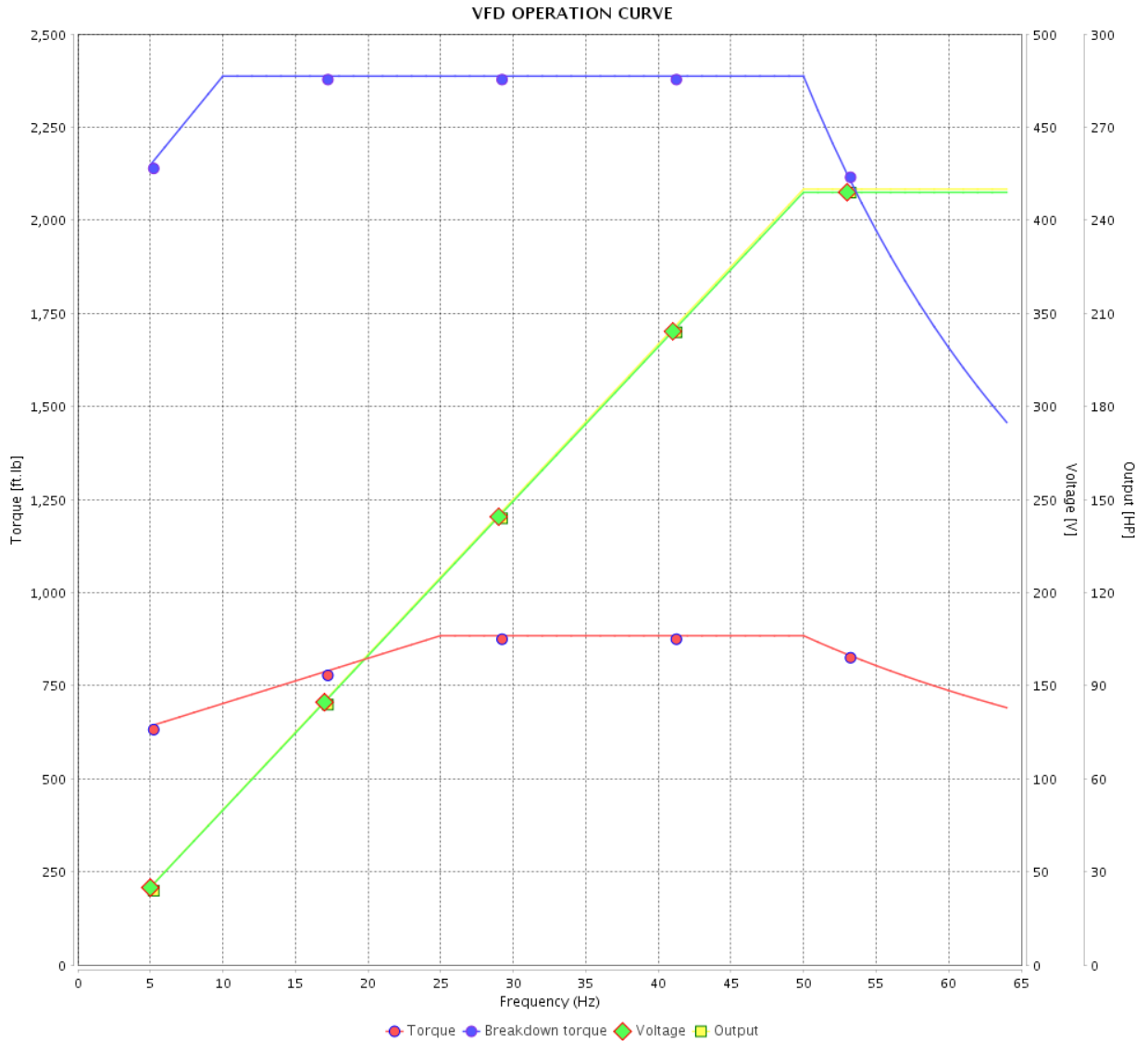

Performance : 415 V 50 Hz 4P IE3

Rated current : 311 A
 LRC : 7.2
 Rated torque : 884 ft.lb
 Locked rotor torque : 260 %
 Breakdown torque : 270 %
 Rated speed : 1485 rpm

Moment of inertia (J) : 89.6 sq.ft.lb
 Duty cycle : Cont.(S1)
 Insulation class : F
 Service factor : 1.00
 Temperature rise : 105 K
 Design : B

Rev.	Changes Summary	Performed	Checked	Date
Performed by			Page 21 / 21	Revision
Checked by				
Date	12/04/2022			

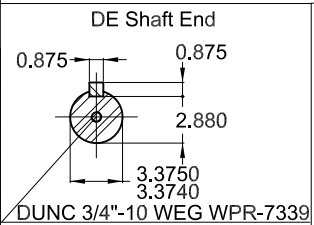
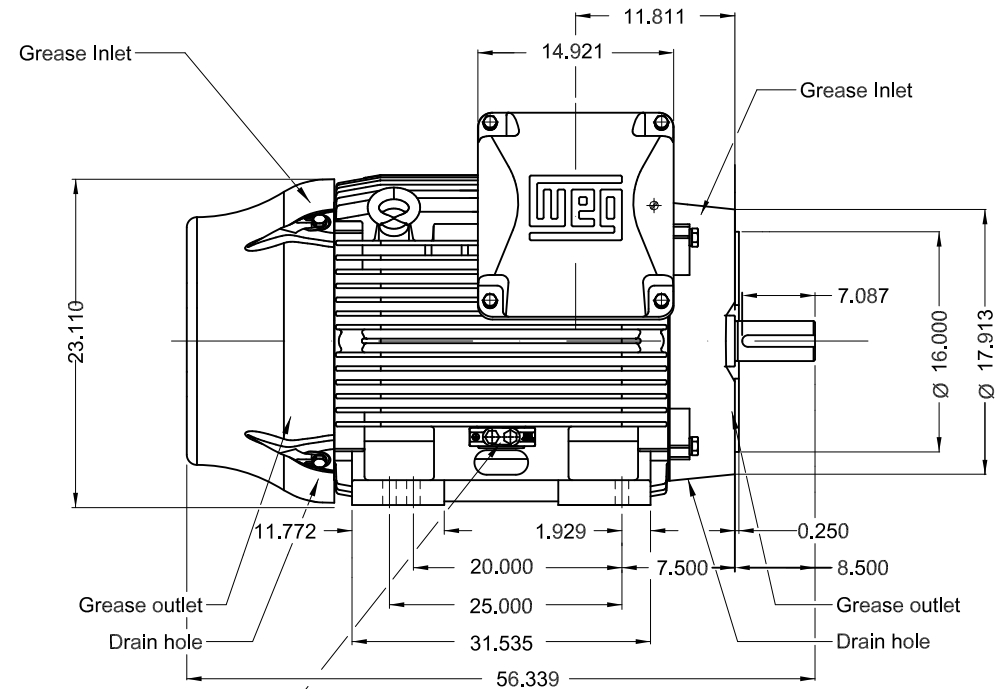
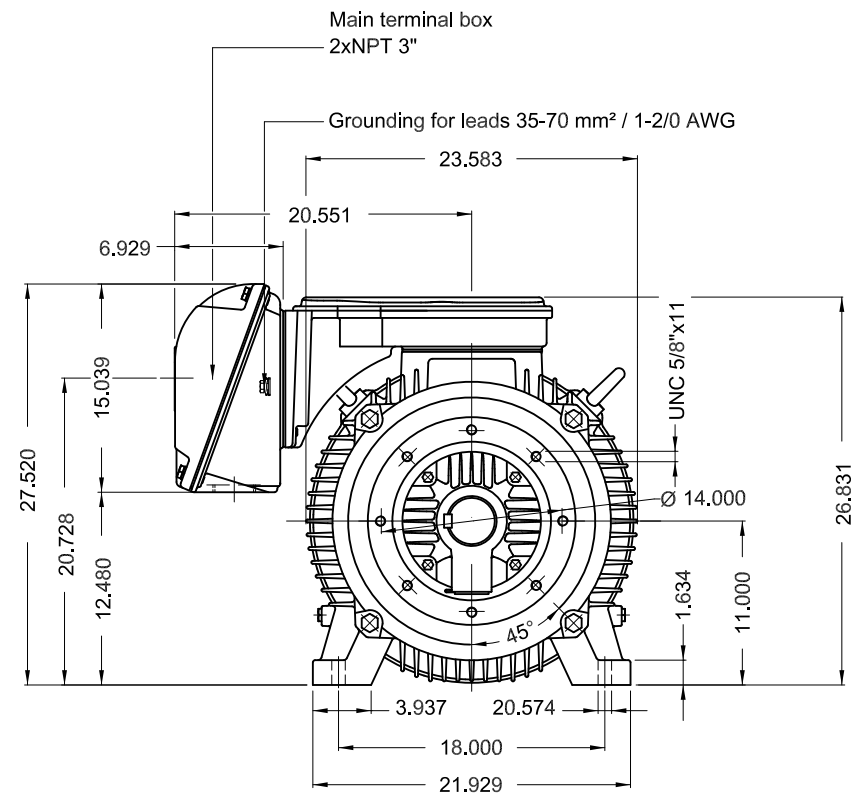

Without vertical jackscrews
Color RAL 5009
Painting plan 203A
Mounting NEMA F-1
Mounting B34R(D)

300 HP 04 Poles 60 Hz A

ECM	LOC	SUMMARY OF MODIFICATIONS	EXECUTED	CHECKED	RELEASED	DATE	VER
EXECUTED	PIRWBUSER	THREE PH. MOTOR W22 PREM. EFF.					
CHECKED		FRAME 447/9TC IP55 TEFC					
RELEASED							
REL DT.	WMO	Jaragua do Sul	Product Engineering	SHEET	1 / 1		

PREVIEW
WDD



MADE IN MEXICO
13472772



FOR SAFE AREA
Mod.TE1BFOXON
CC029A





Class I, Div 2, Gr A, B, C and D - T3
Class I, Zone 2, IIC - T3
Class II, Div 2, Gr F and G - T3C
For use on PWM: Gr. A, B, C, D and F,
VT 1000:1, CT 6:1, 1.00SF - T3

MODEL 30018ET3G449TC-W22

Inverter Duty Motor
Severe Duty

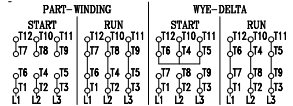
PH3	60Hz	Fr. 447/9TC	1000m.a.s.l.	IP55	TEFC	2869lb
V 460				A 330		
HP 300				kW 220		
SF 1.15				SFA 379		
RPM 1780				PF 0.87		
AMB 40°C				INS cl. F DT80K	NEMA NOM EFF 96.2%	
DUTY CONT.				DES B Code G		



-  → 6322-C3 (60g)
-  → 6319-C3 (45g)

 MOBIL POLYREX EM (6000h)