

DATA SHEET

Three Phase Induction Motor - Squirrel Cage



Customer :				
Product line	: Premium Efficiency Three-Phase	Product code :	12809013	
		Catalog # :	.3318OT3E56-S	
Frame	: 56	Cooling method	: IC01 - ODP	
Insulation class	: F	Mounting	: F-1	
Duty cycle	: Cont.(S1)	Rotation ¹	: Both (CW and CCW)	
Ambient temperature	: -20°C to +40°C	Starting method	: Direct On Line	
Altitude	: 1000 m.a.s.l.	Approx. weight ²	: 17.3 lb	
		Moment of inertia (J)	: 0.0453 sq.ft.lb	
Output [HP]	0.33	0.33	0.33	
Poles	4	4	4	
Frequency [Hz]	60	50	50	
Rated voltage [V]	208-230/460	190/380	220/415	
Rated current [A]	1.48-1.34/0.668	1.44/0.718	1.37/0.727	
L. R. Amperes [A]	9.16-8.28/4.14	7.32/3.66	7.27/3.85	
LRC [A]	6.2x(Code L)	5.1x(Code J)	5.3x(Code K)	
No load current [A]	0.948-1.10/0.550	1.04/0.522	1.10/0.581	
Rated speed [RPM]	1765	1450	1455	
Slip [%]	1.94	3.33	3.00	
Rated torque [ft.lb]	0.982	1.20	1.19	
Locked rotor torque [%]	229	160	180	
Breakdown torque [%]	330	250	280	
Service factor		1.35	1.35	
Temperature rise	80 K	80 K	80 K	
Locked rotor time	64s (cold) 36s (hot)	77s (cold) 43s (hot)	68s (cold) 38s (hot)	
Noise level ²	52.0 dB(A)	49.0 dB(A)	49.0 dB(A)	
Efficiency (%)	25%	59.2	60.3	
	50%	62.0	62.7	
	75%	70.0	69.3	
	100%	73.4	71.9	
Power Factor	25%	0.24	0.25	
	50%	0.44	0.47	
	75%	0.55	0.59	
	100%	0.64	0.69	
Bearing type	: <u>Drive end</u> 6203 ZZ <u>Non drive end</u> 6202 ZZ	Foundation loads		
Sealing	: Without Without Bearing Seal Bearing Seal	Max. traction	: 24 lb	
Lubrication interval	: - -	Max. compression	: 41 lb	
Lubricant amount	: - -			
Lubricant type	: Mobil Polyrex EM			
Notes USABLE @208V SF 1.00				
This revision replaces and cancel the previous one, which must be eliminated. (1) Looking the motor from the shaft end. (2) Measured at 1m and with tolerance of +3dB(A). (3) Approximate weight subject to changes after manufacturing process. (4) At 100% of full load.		These are average values based on tests with sinusoidal power supply, subject to the tolerances stipulated in NEMA MG-1.		
Rev.	Changes Summary	Performed	Checked	Date
Performed by				
Checked by			Page	Revision
Date	11/04/2022		1 / 13	

TORQUE AND CURRENT VS SPEED CURVE

Three Phase Induction Motor - Squirrel Cage



Customer :

Product line : Premium Efficiency Three-Phase

Product code :

12809013

Catalog # :

.3318OT3E56-S

TORQUE AND CURRENT VS SPEED CURVE

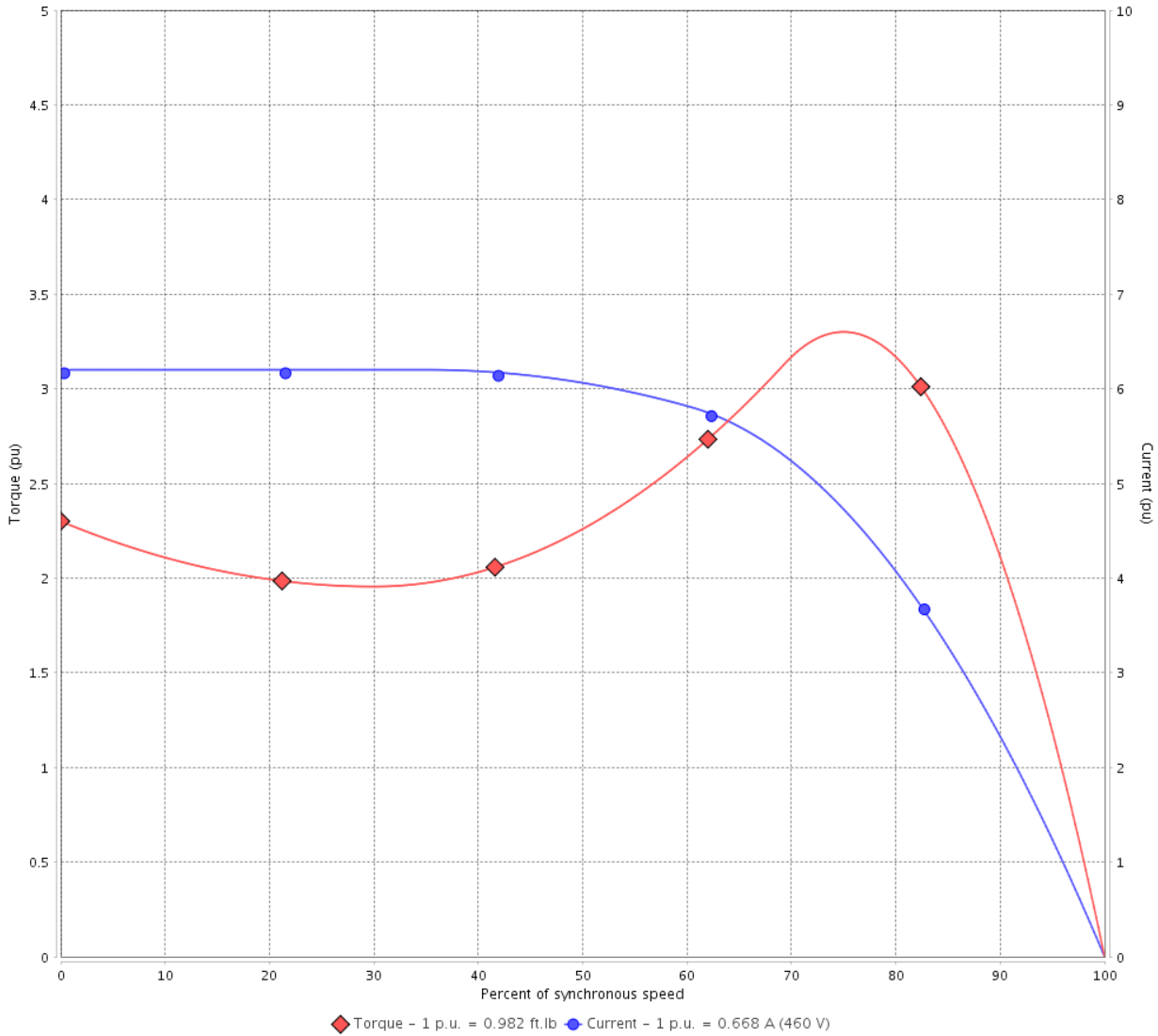

Performance : 208-230/460 V 60 Hz 4P

Rated current	: 1.48-1.34/0.668 A	Moment of inertia (J)	: 0.0453 sq.ft.lb
LRC	: 6.2	Duty cycle	: Cont.(S1)
Rated torque	: 0.982 ft.lb	Insulation class	: F
Locked rotor torque	: 229 %	Service factor	:
Breakdown torque	: 330 %	Temperature rise	: 80 K
Rated speed	: 1765 rpm		

Locked rotor time : 64s (cold) 36s (hot)

Rev.	Changes Summary	Performed	Checked	Date
Performed by			Page 2 / 13	Revision
Checked by				
Date	11/04/2022			

TORQUE AND CURRENT VS SPEED CURVE



Three Phase Induction Motor - Squirrel Cage

Customer :

Product line : Premium Efficiency Three-Phase

Product code :

12809013

Catalog # :

.3318OT3E56-S

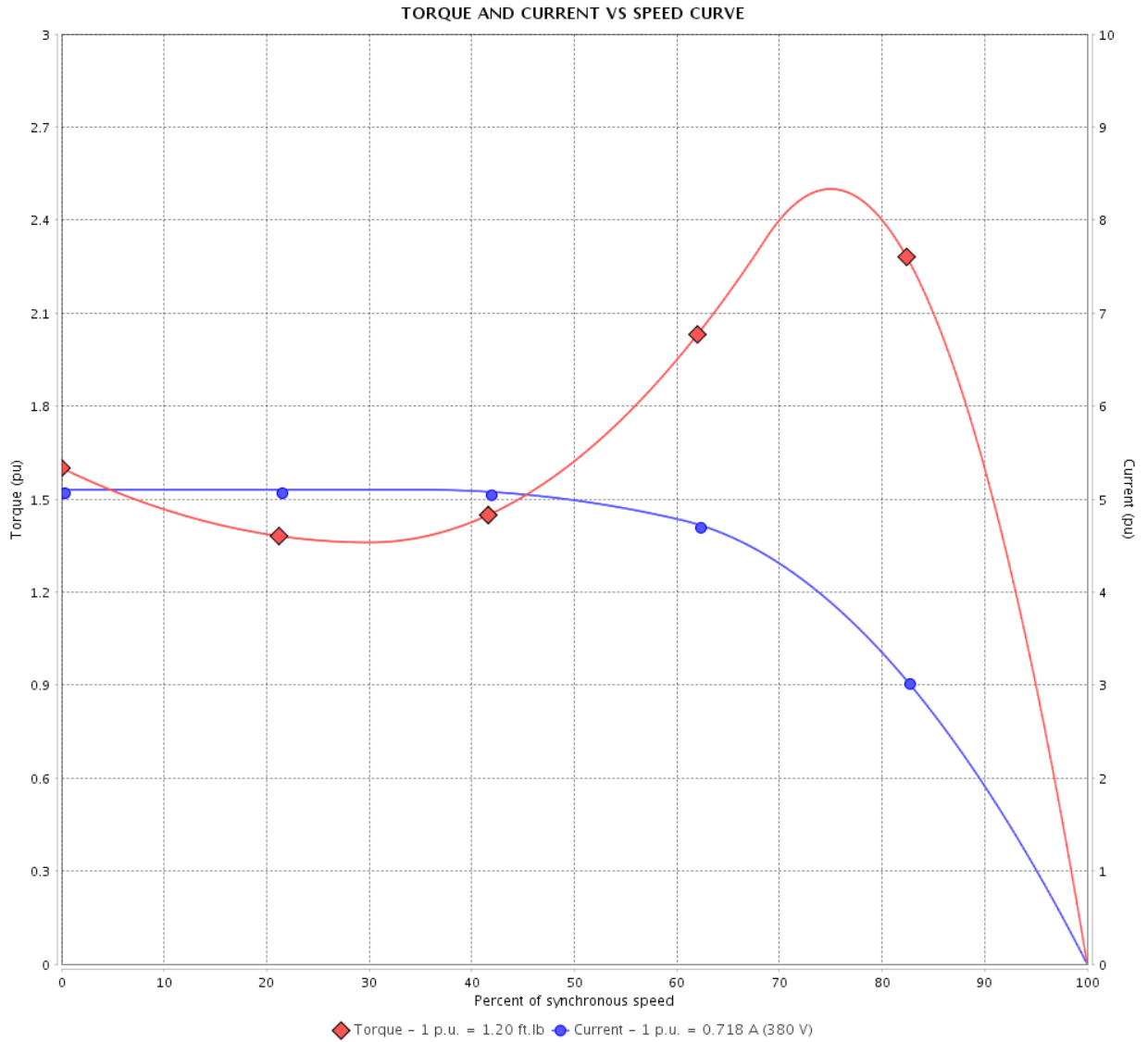

Performance : 190/380 V 50 Hz 4P

Rated current : 1.44/0.718 A
 LRC : 5.1
 Rated torque : 1.20 ft.lb
 Locked rotor torque : 160 %
 Breakdown torque : 250 %
 Rated speed : 1450 rpm

Moment of inertia (J) : 0.0453 sq.ft.lb
 Duty cycle : Cont.(S1)
 Insulation class : F
 Service factor : 1.35
 Temperature rise : 80 K

Locked rotor time : 77s (cold) 43s (hot)

Rev.	Changes Summary	Performed	Checked	Date
Performed by			Page 3 / 13	Revision
Checked by				
Date	11/04/2022			

TORQUE AND CURRENT VS SPEED CURVE

Three Phase Induction Motor - Squirrel Cage



Customer :

Product line : Premium Efficiency Three-Phase

Product code :

12809013

Catalog # :

.3318OT3E56-S

TORQUE AND CURRENT VS SPEED CURVE

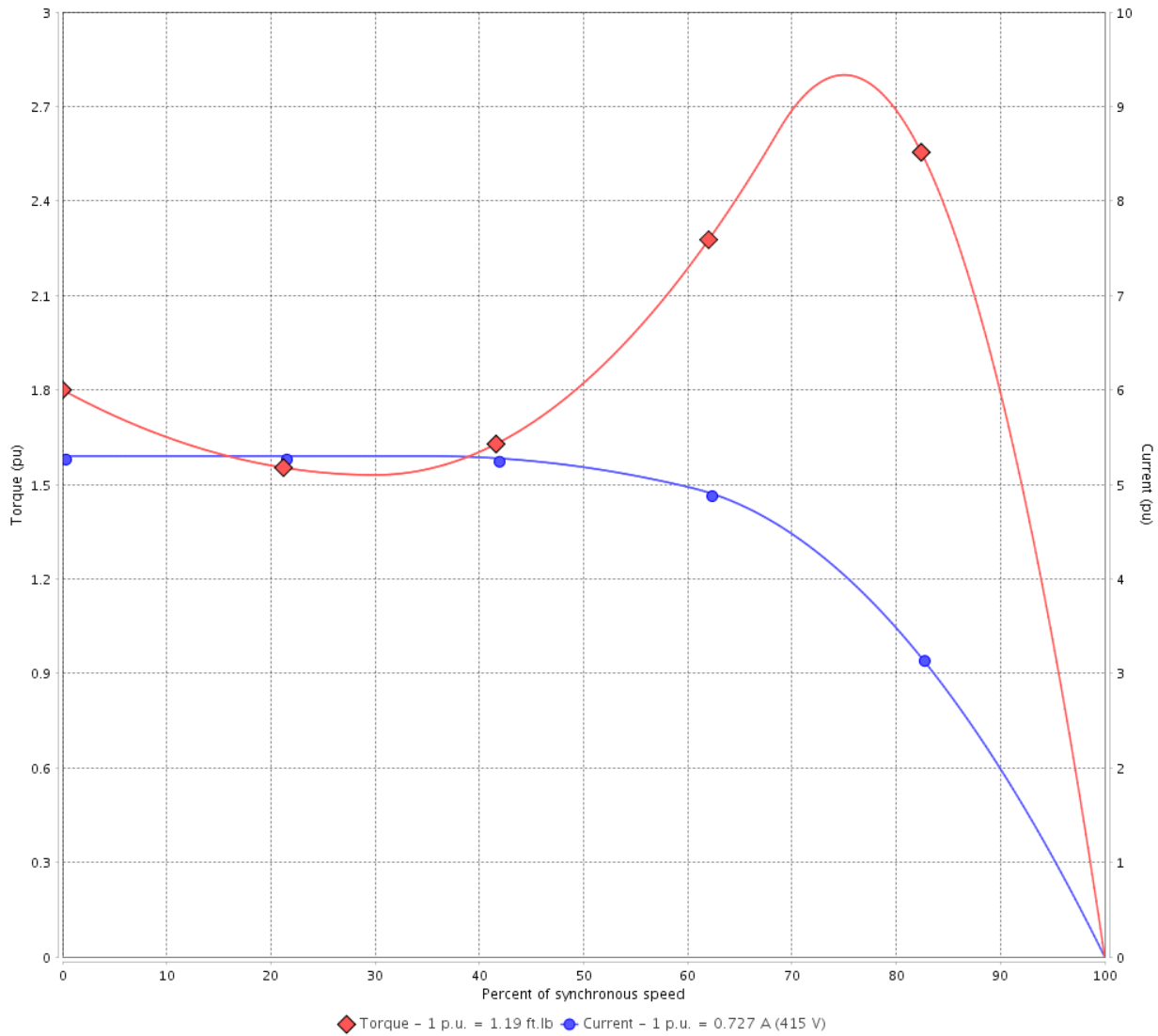

Performance : 220/415 V 50 Hz 4P

Rated current : 1.37/0.727 A
 LRC : 5.3
 Rated torque : 1.19 ft.lb
 Locked rotor torque : 180 %
 Breakdown torque : 280 %
 Rated speed : 1455 rpm

Moment of inertia (J) : 0.0453 sq.ft.lb
 Duty cycle : Cont.(S1)
 Insulation class : F
 Service factor : 1.35
 Temperature rise : 80 K

Locked rotor time : 68s (cold) 38s (hot)

Rev.	Changes Summary	Performed	Checked	Date
Performed by			Page 4 / 13	Revision
Checked by				
Date	11/04/2022			

LOAD PERFORMANCE CURVE

Three Phase Induction Motor - Squirrel Cage



Customer :

Product line : Premium Efficiency Three-Phase

Product code :

12809013

Catalog # :

.3318OT3E56-S

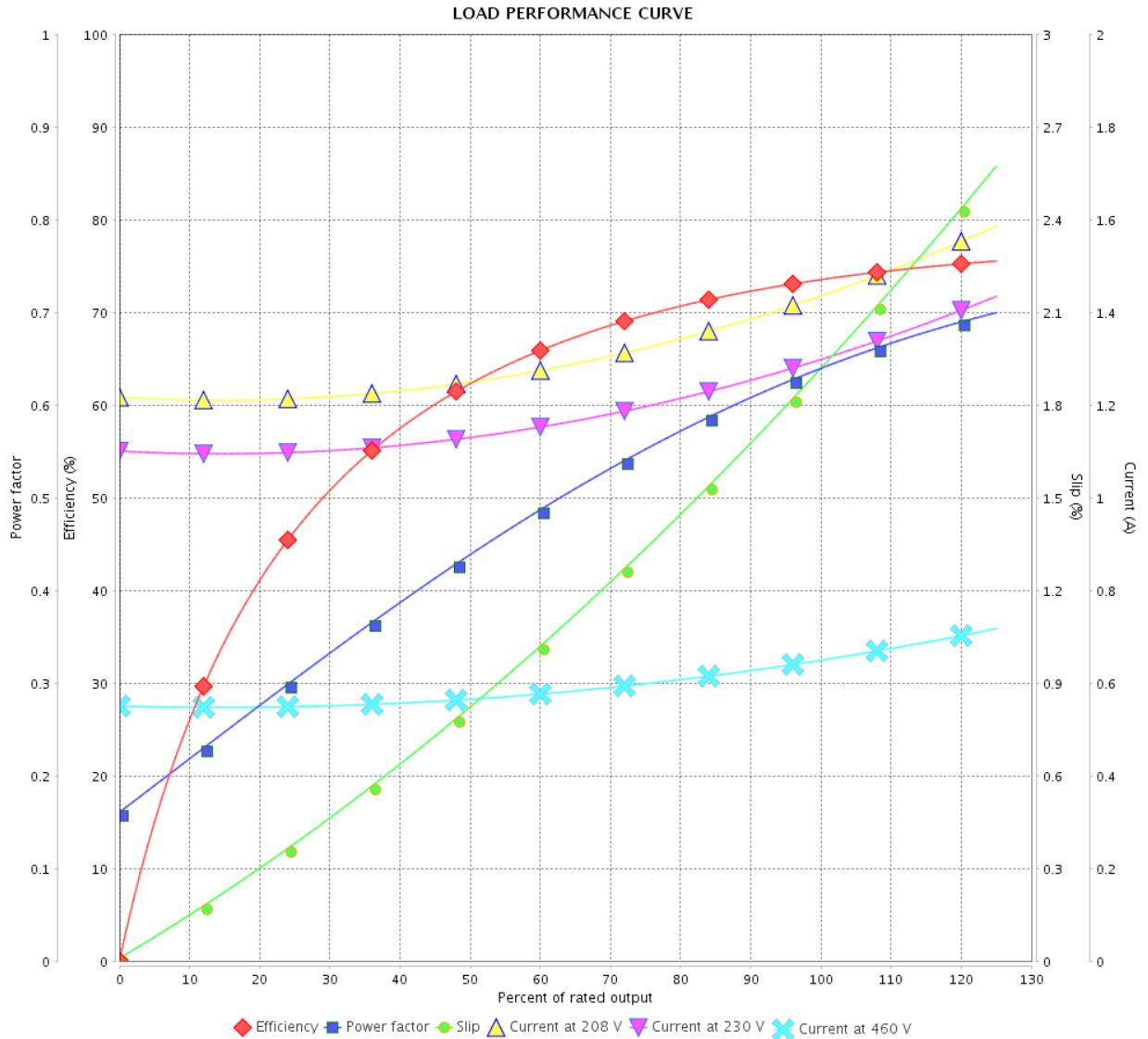

Performance : 208-230/460 V 60 Hz 4P

Rated current : 1.48-1.34/0.668 A
 LRC : 6.2
 Rated torque : 0.982 ft.lb
 Locked rotor torque : 229 %
 Breakdown torque : 330 %
 Rated speed : 1765 rpm

Moment of inertia (J) : 0.0453 sq.ft.lb
 Duty cycle : Cont.(S1)
 Insulation class : F
 Service factor :
 Temperature rise : 80 K

Rev.	Changes Summary	Performed	Checked	Date
Performed by			Page	Revision
Checked by				
Date				

LOAD PERFORMANCE CURVE

Three Phase Induction Motor - Squirrel Cage



Customer :

Product line : Premium Efficiency Three-Phase

Product code :

12809013

Catalog # :

.3318OT3E56-S

LOAD PERFORMANCE CURVE

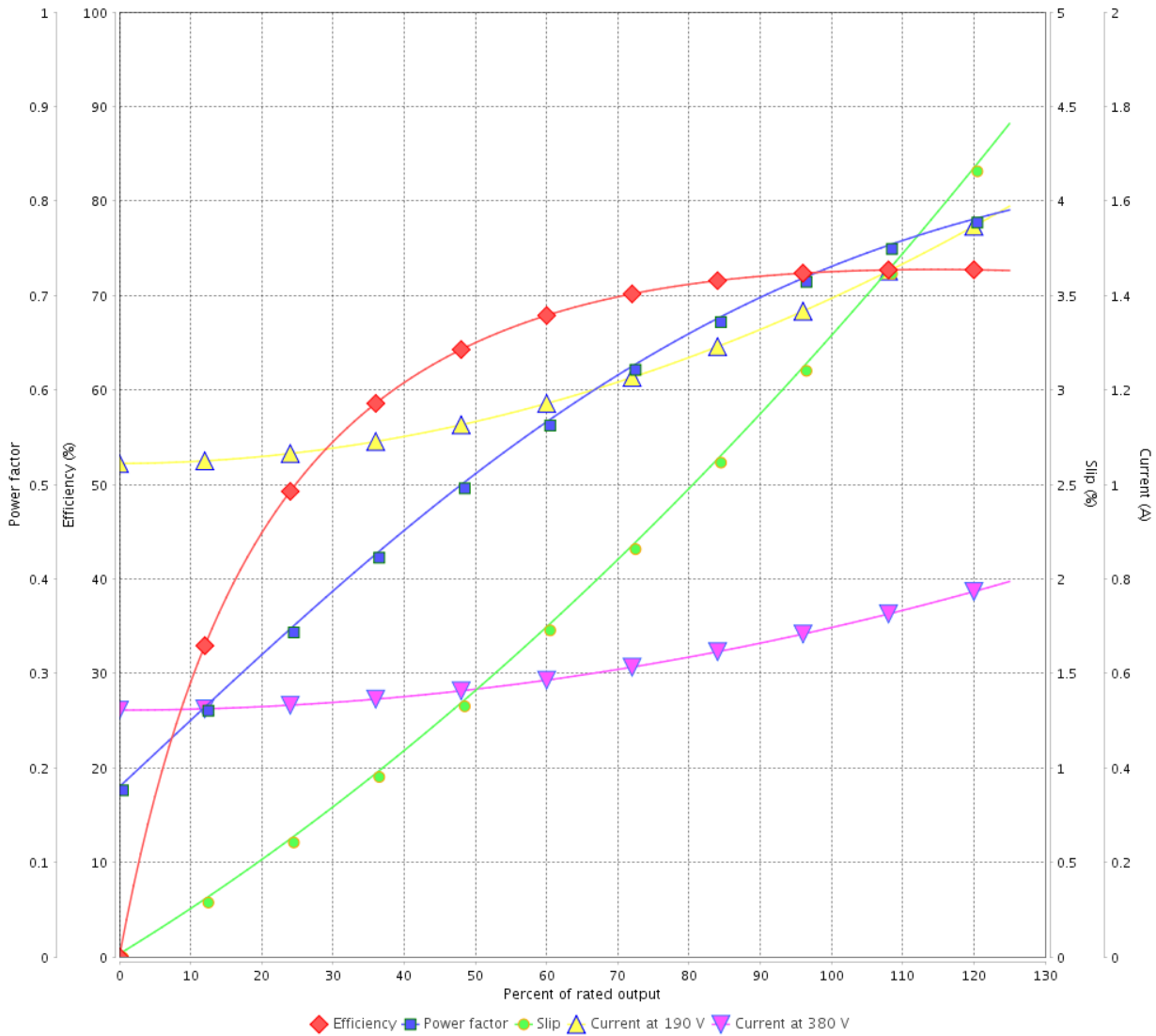

Performance : 190/380 V 50 Hz 4P

Rated current : 1.44/0.718 A
 LRC : 5.1
 Rated torque : 1.20 ft.lb
 Locked rotor torque : 160 %
 Breakdown torque : 250 %
 Rated speed : 1450 rpm

Moment of inertia (J) : 0.0453 sq.ft.lb
 Duty cycle : Cont.(S1)
 Insulation class : F
 Service factor : 1.35
 Temperature rise : 80 K

Rev.	Changes Summary	Performed	Checked	Date
Performed by			Page 6 / 13	Revision
Checked by				
Date	11/04/2022			

LOAD PERFORMANCE CURVE

Three Phase Induction Motor - Squirrel Cage



Customer :

Product line : Premium Efficiency Three-Phase

Product code :

12809013

Catalog # :

.3318OT3E56-S

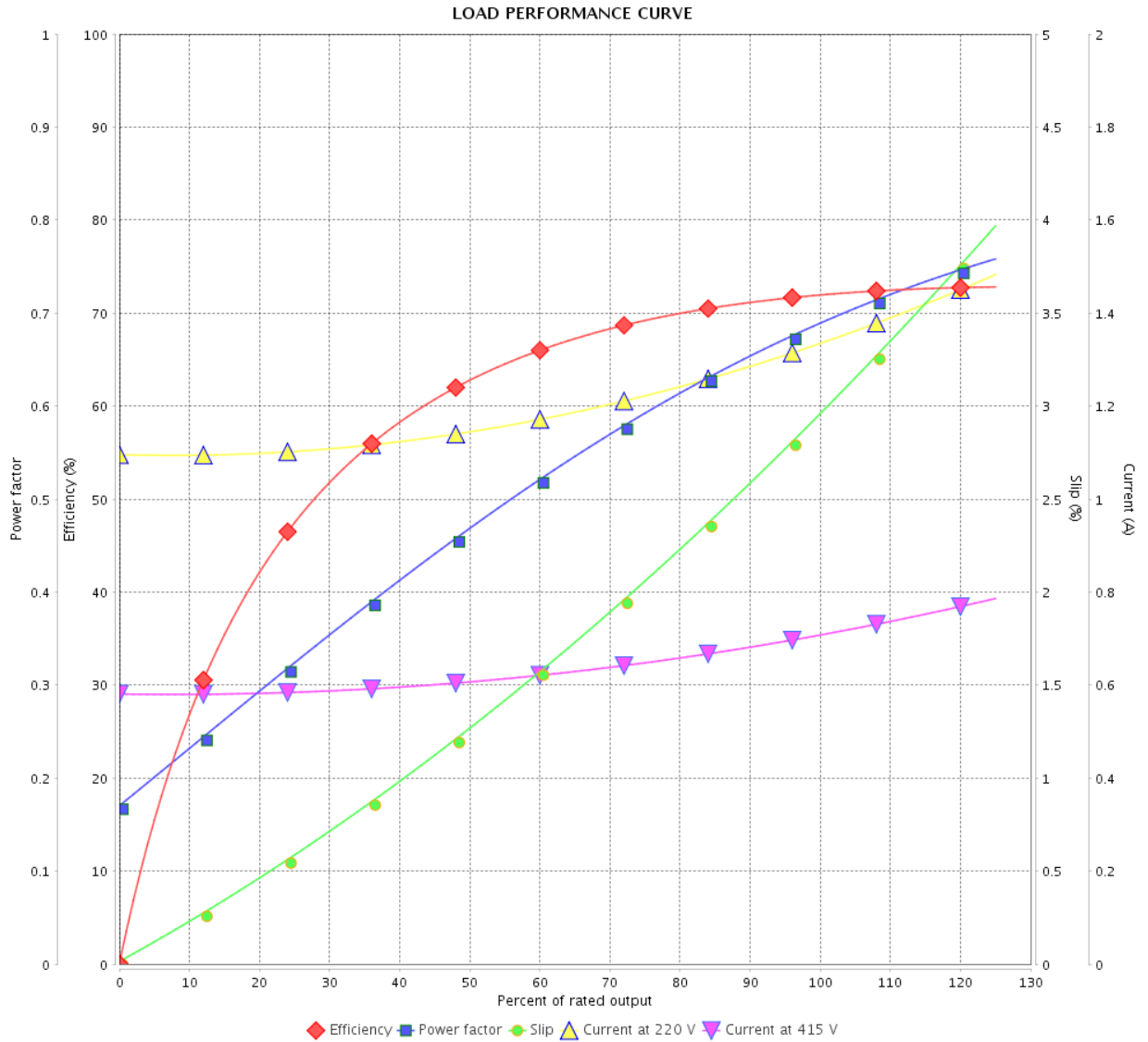

Performance : 220/415 V 50 Hz 4P

Rated current : 1.37/0.727 A
 LRC : 5.3
 Rated torque : 1.19 ft.lb
 Locked rotor torque : 180 %
 Breakdown torque : 280 %
 Rated speed : 1455 rpm

Moment of inertia (J) : 0.0453 sq.ft.lb
 Duty cycle : Cont.(S1)
 Insulation class : F
 Service factor : 1.35
 Temperature rise : 80 K

Rev.	Changes Summary	Performed	Checked	Date
Performed by		Page		Revision
Checked by		7 / 13		
Date		11/04/2022		

THERMAL LIMIT CURVE

Three Phase Induction Motor - Squirrel Cage



Customer :

Product line : Premium Efficiency Three-Phase

Product code :

12809013

Catalog # :

.3318OT3E56-S

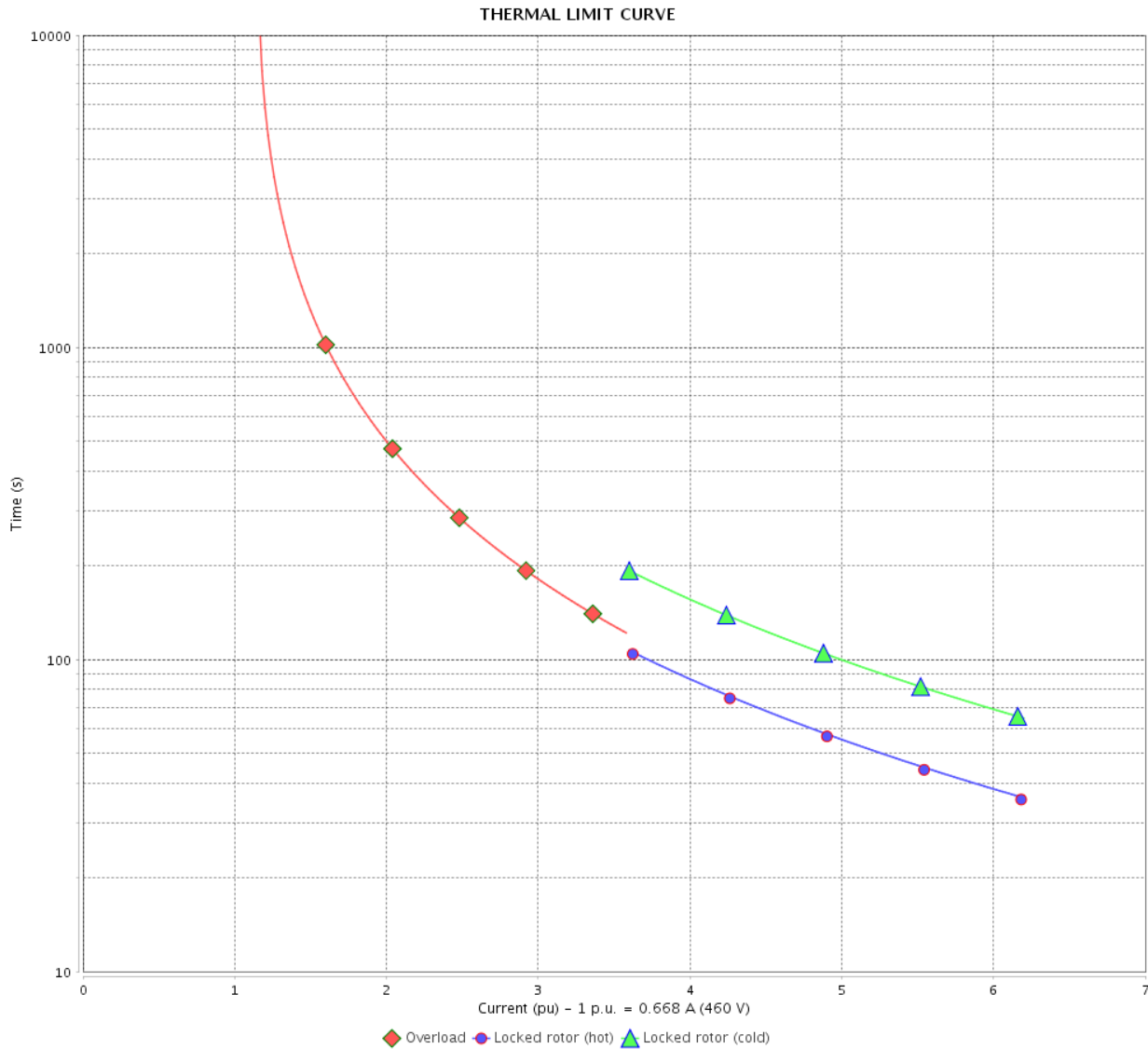

Performance : 208-230/460 V 60 Hz 4P

Rated current : 1.48-1.34/0.668 A
 LRC : 6.2
 Rated torque : 0.982 ft.lb
 Locked rotor torque : 229 %
 Breakdown torque : 330 %
 Rated speed : 1765 rpm

Moment of inertia (J) : 0.0453 sq.ft.lb
 Duty cycle : Cont.(S1)
 Insulation class : F
 Service factor :
 Temperature rise : 80 K

Heating constant

Cooling constant

Rev.	Changes Summary	Performed	Checked	Date
Performed by			Page	Revision
Checked by				
Date				
			8 / 13	

THERMAL LIMIT CURVE

Three Phase Induction Motor - Squirrel Cage



Customer : _____

Product line : Premium Efficiency Three-Phase

Product code : 12809013
Catalog # : .3318OT3E56-S

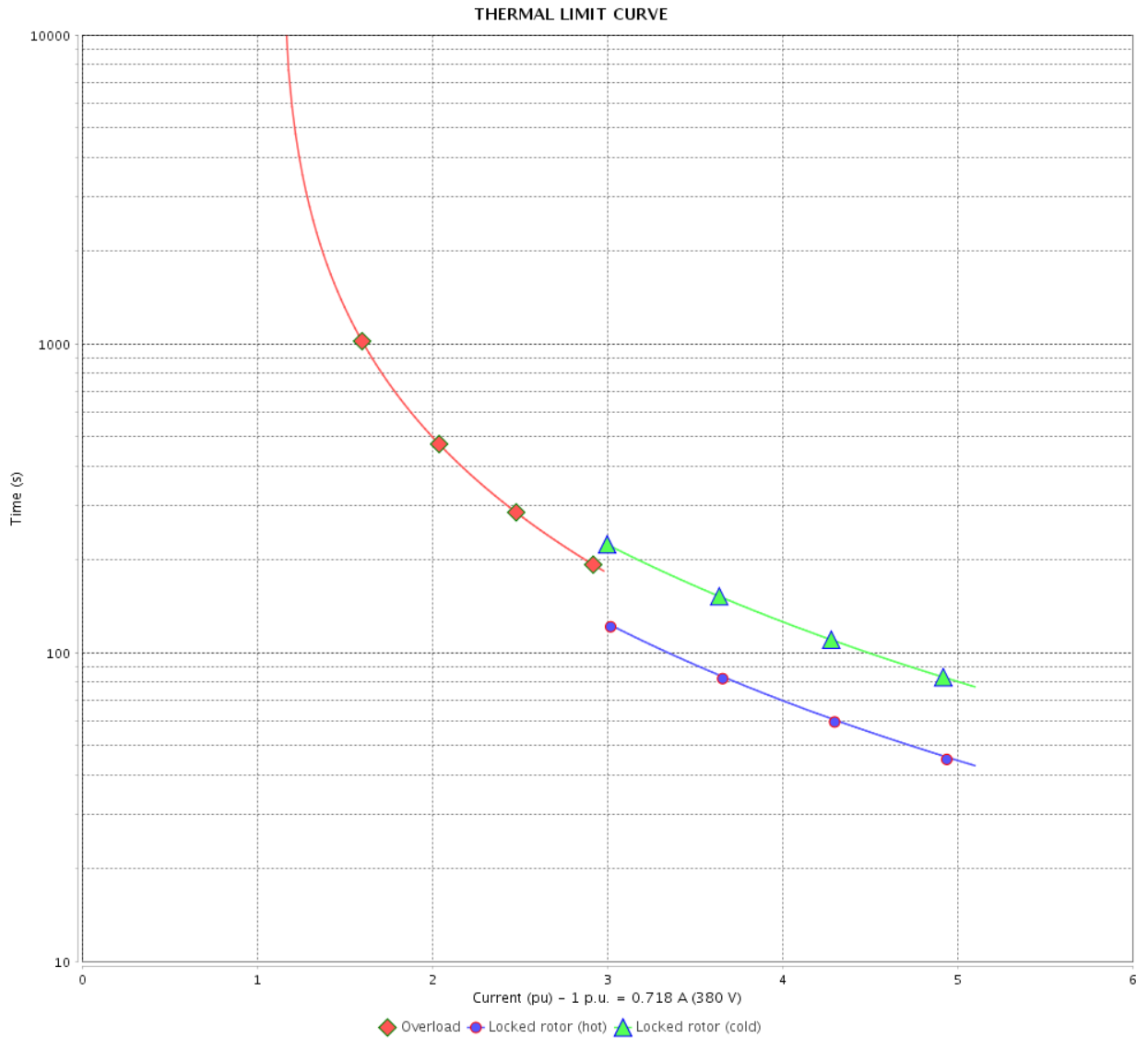

Performance : 190/380 V 50 Hz 4P

Rated current : 1.44/0.718 A
LRC : 5.1
Rated torque : 1.20 ft.lb
Locked rotor torque : 160 %
Breakdown torque : 250 %
Rated speed : 1450 rpm

Moment of inertia (J) : 0.0453 sq.ft.lb
Duty cycle : Cont.(S1)
Insulation class : F
Service factor : 1.35
Temperature rise : 80 K

Heating constant

Cooling constant

Rev.	Changes Summary	Performed	Checked	Date
Performed by			Page	Revision
Checked by				
Date				

THERMAL LIMIT CURVE

Three Phase Induction Motor - Squirrel Cage



Customer : _____

Product line : Premium Efficiency Three-Phase

Product code :

12809013

Catalog # :

.3318OT3E56-S

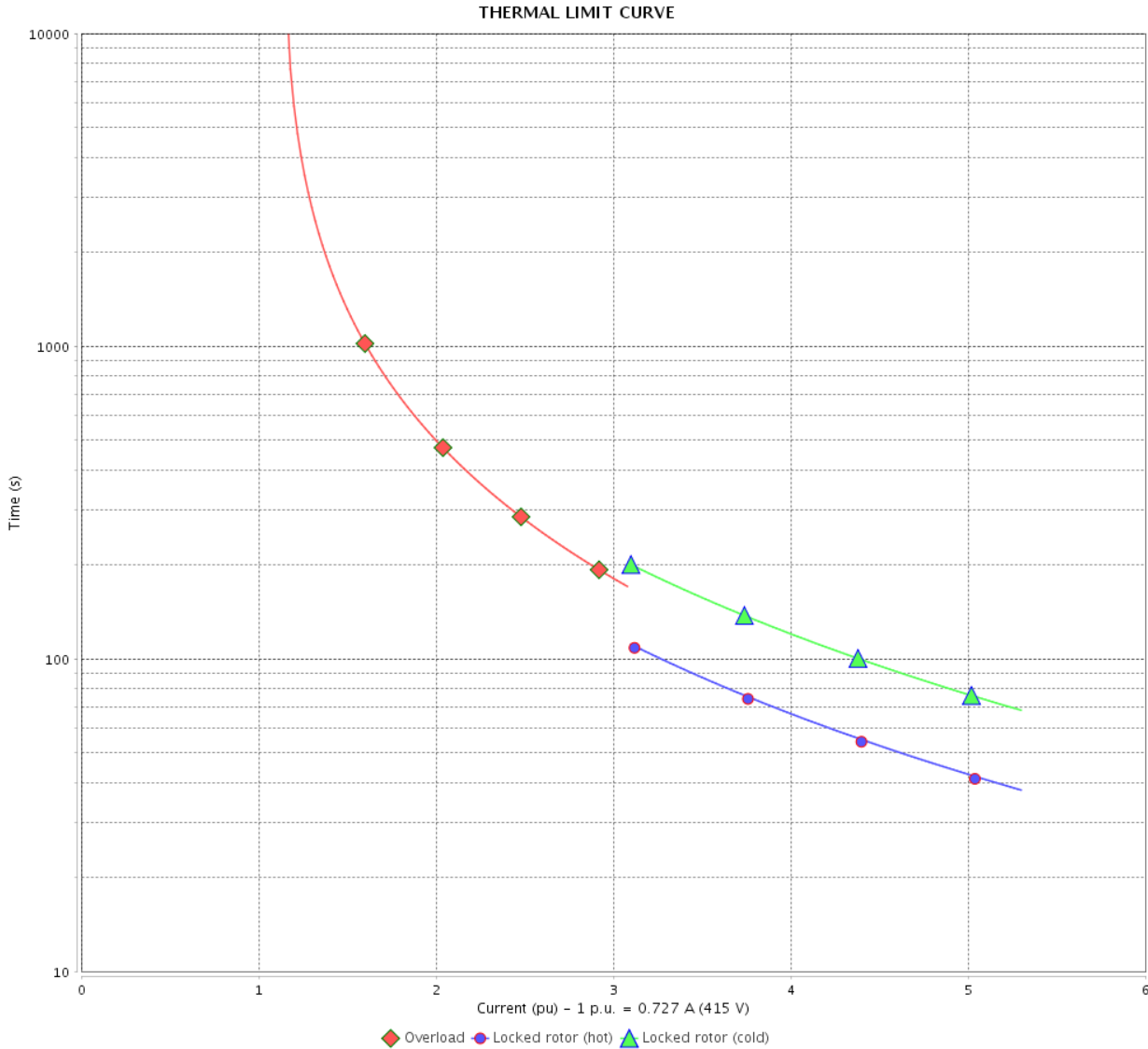

Performance : 220/415 V 50 Hz 4P

Rated current : 1.37/0.727 A
 LRC : 5.3
 Rated torque : 1.19 ft.lb
 Locked rotor torque : 180 %
 Breakdown torque : 280 %
 Rated speed : 1455 rpm

Moment of inertia (J) : 0.0453 sq.ft.lb
 Duty cycle : Cont.(S1)
 Insulation class : F
 Service factor : 1.35
 Temperature rise : 80 K

Heating constant

Cooling constant

Rev.	Changes Summary	Performed	Checked	Date
Performed by	11/04/2022	Page		Revision
Checked by		10 / 13		
Date				

VFD OPERATION CURVE

Three Phase Induction Motor - Squirrel Cage



Customer : _____

Product line : Premium Efficiency Three-Phase Product code : 12809013
 Catalog # : .3318OT3E56-S

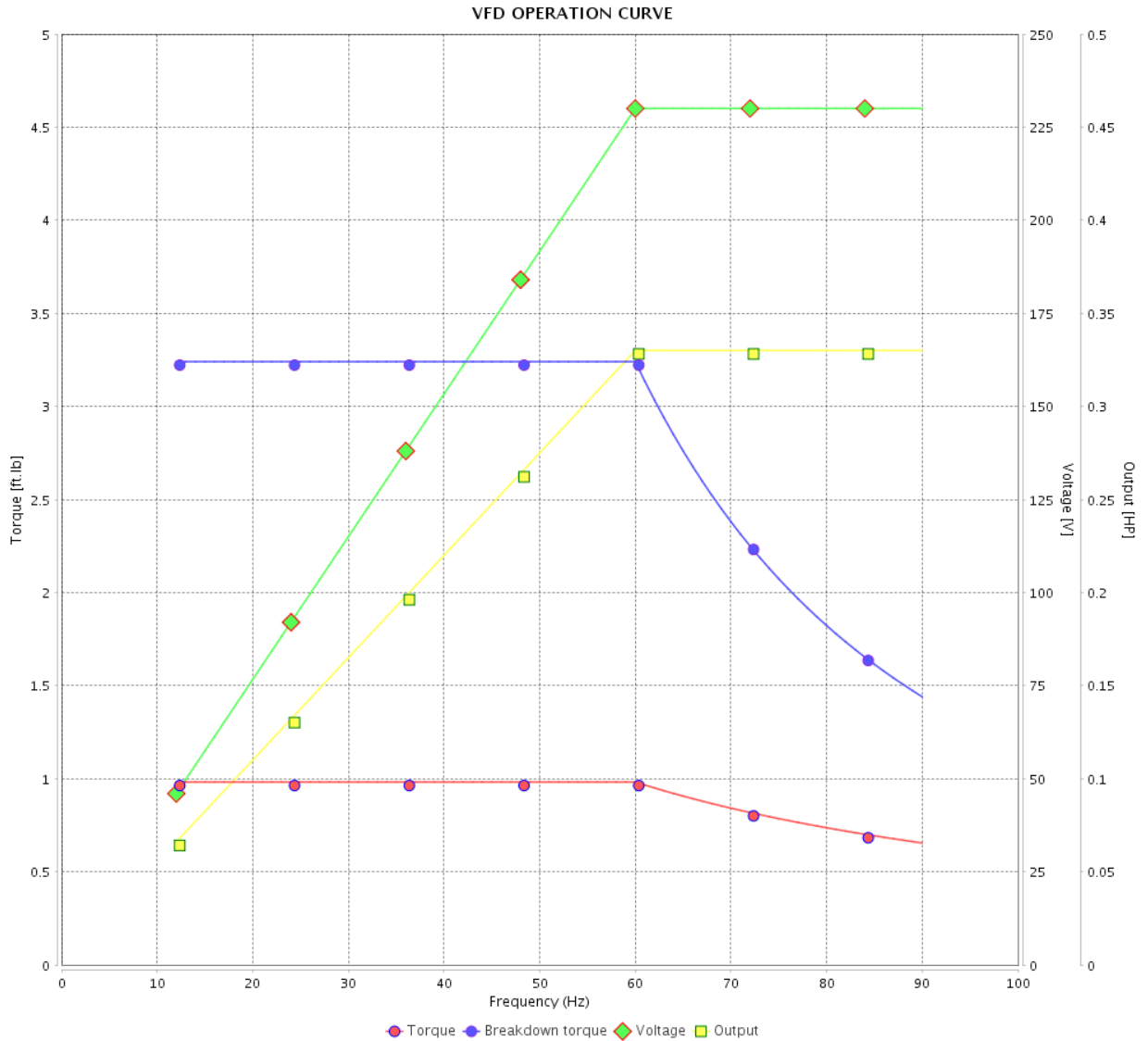

Performance : 208-230/460 V 60 Hz 4P

Rated current : 1.48-1.34/0.668 A
 LRC : 6.2
 Rated torque : 0.982 ft.lb
 Locked rotor torque : 229 %
 Breakdown torque : 330 %
 Rated speed : 1765 rpm

Moment of inertia (J) : 0.0453 sq.ft.lb
 Duty cycle : Cont.(S1)
 Insulation class : F
 Service factor :
 Temperature rise : 80 K

Rev.	Changes Summary	Performed	Checked	Date
Performed by			Page 11 / 13	Revision
Checked by				
Date	11/04/2022			

VFD OPERATION CURVE

Three Phase Induction Motor - Squirrel Cage



Customer :

Product line : Premium Efficiency Three-Phase

Product code :

12809013

Catalog # :

.3318OT3E56-S

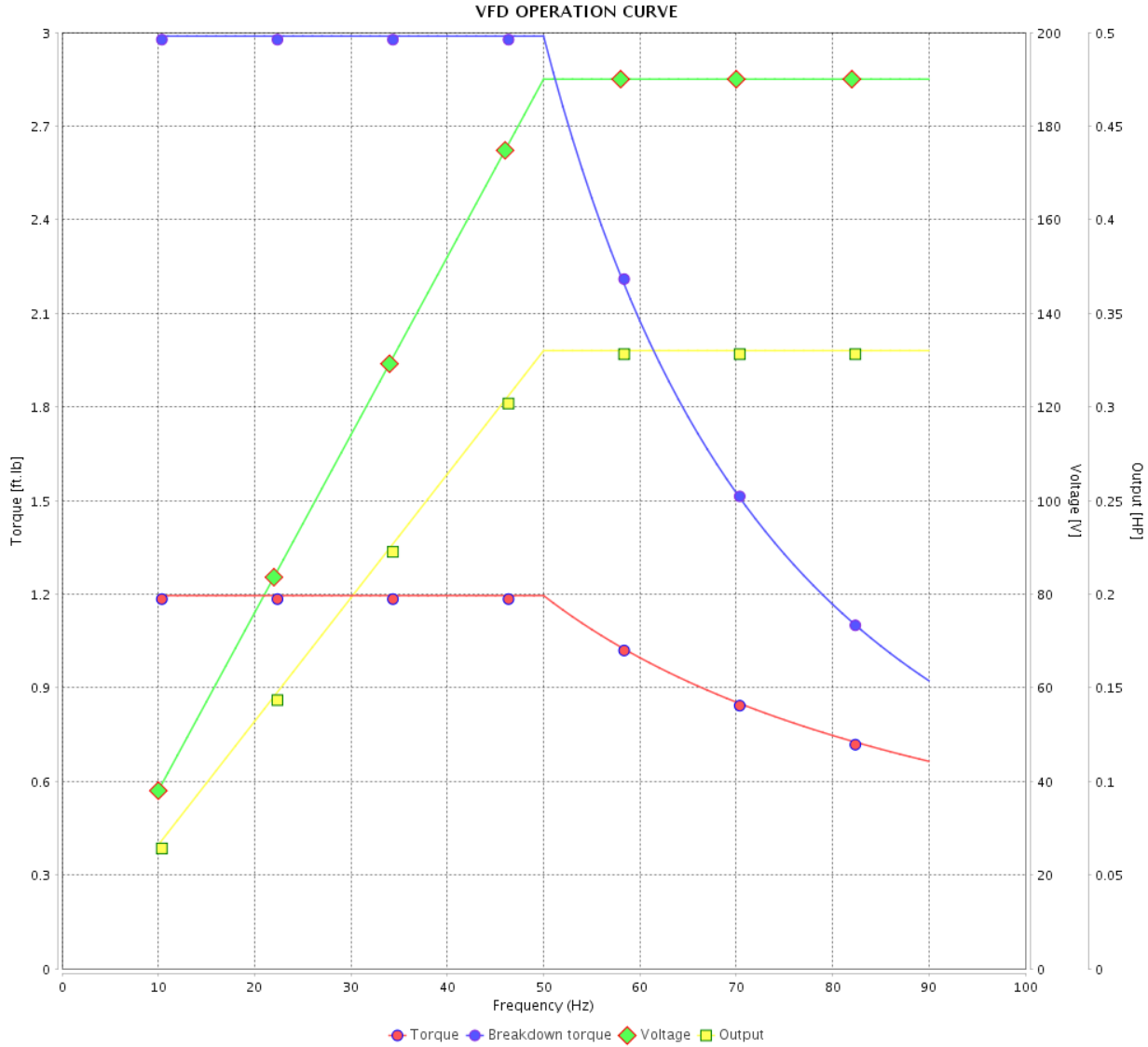

Performance : 190/380 V 50 Hz 4P

Rated current : 1.44/0.718 A
 LRC : 5.1
 Rated torque : 1.20 ft.lb
 Locked rotor torque : 160 %
 Breakdown torque : 250 %
 Rated speed : 1450 rpm

Moment of inertia (J) : 0.0453 sq.ft.lb
 Duty cycle : Cont.(S1)
 Insulation class : F
 Service factor : 1.35
 Temperature rise : 80 K

Rev.	Changes Summary	Performed	Checked	Date
Performed by			Page 12 / 13	Revision
Checked by				
Date	11/04/2022			

VFD OPERATION CURVE

Three Phase Induction Motor - Squirrel Cage



Customer : _____

Product line : Premium Efficiency Three-Phase Product code : 12809013
 Catalog # : .3318OT3E56-S

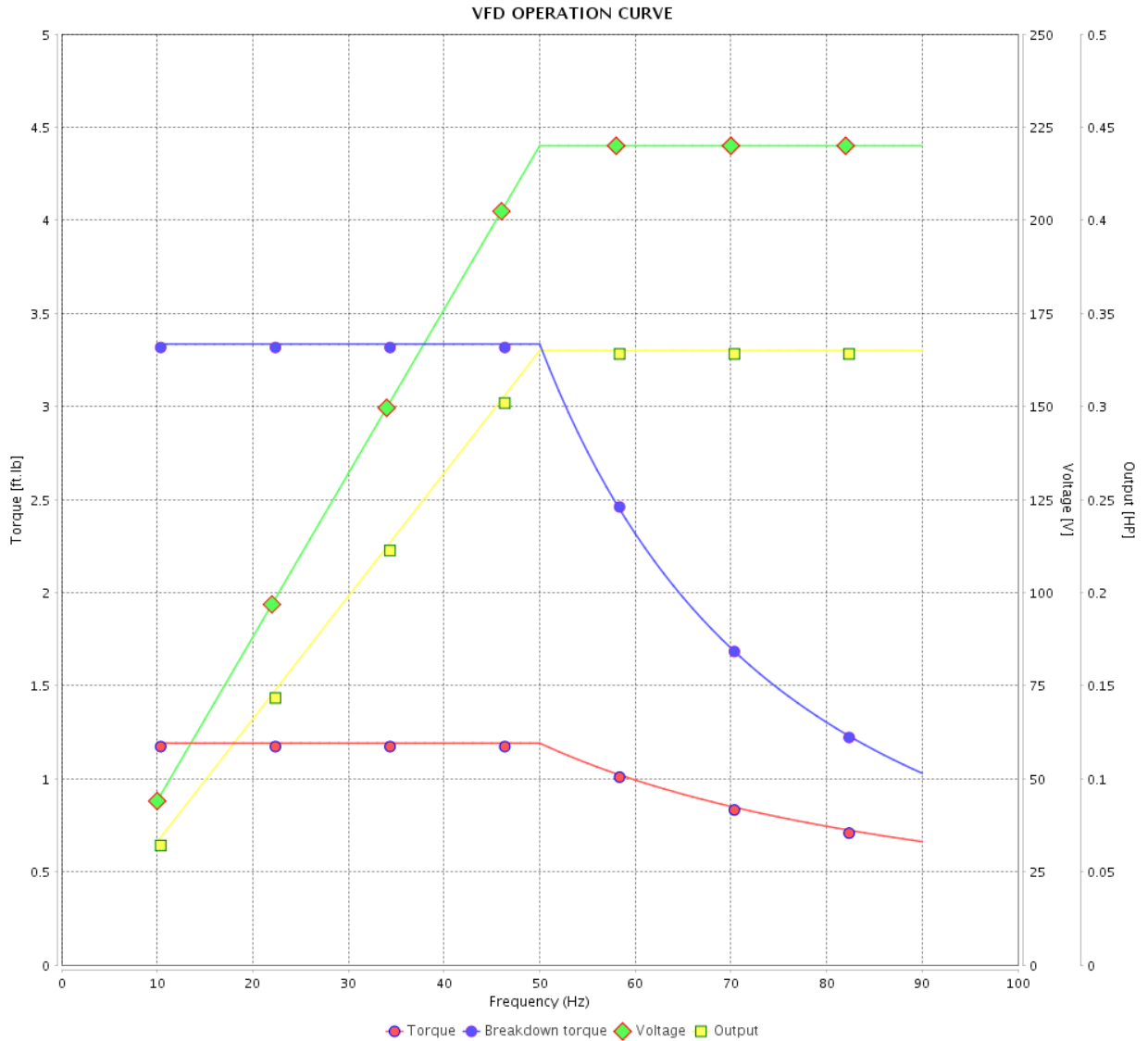

Performance : 220/415 V 50 Hz 4P

Rated current : 1.37/0.727 A
 LRC : 5.3
 Rated torque : 1.19 ft.lb
 Locked rotor torque : 180 %
 Breakdown torque : 280 %
 Rated speed : 1455 rpm

Moment of inertia (J) : 0.0453 sq.ft.lb
 Duty cycle : Cont.(S1)
 Insulation class : F
 Service factor : 1.35
 Temperature rise : 80 K

Rev.	Changes Summary	Performed	Checked	Date
Performed by				Page 13 / 13
Checked by				
Date	11/04/2022			

1 2 3 4 5 6

A

B

C

D

E

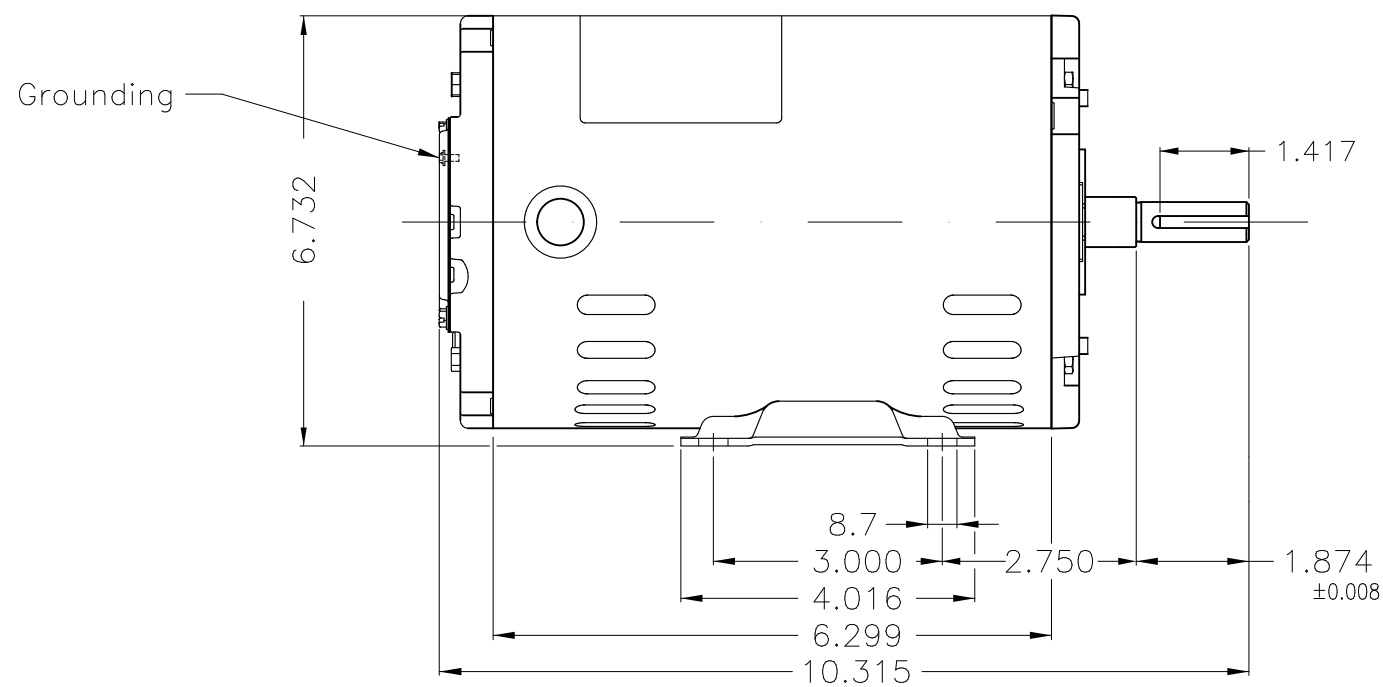
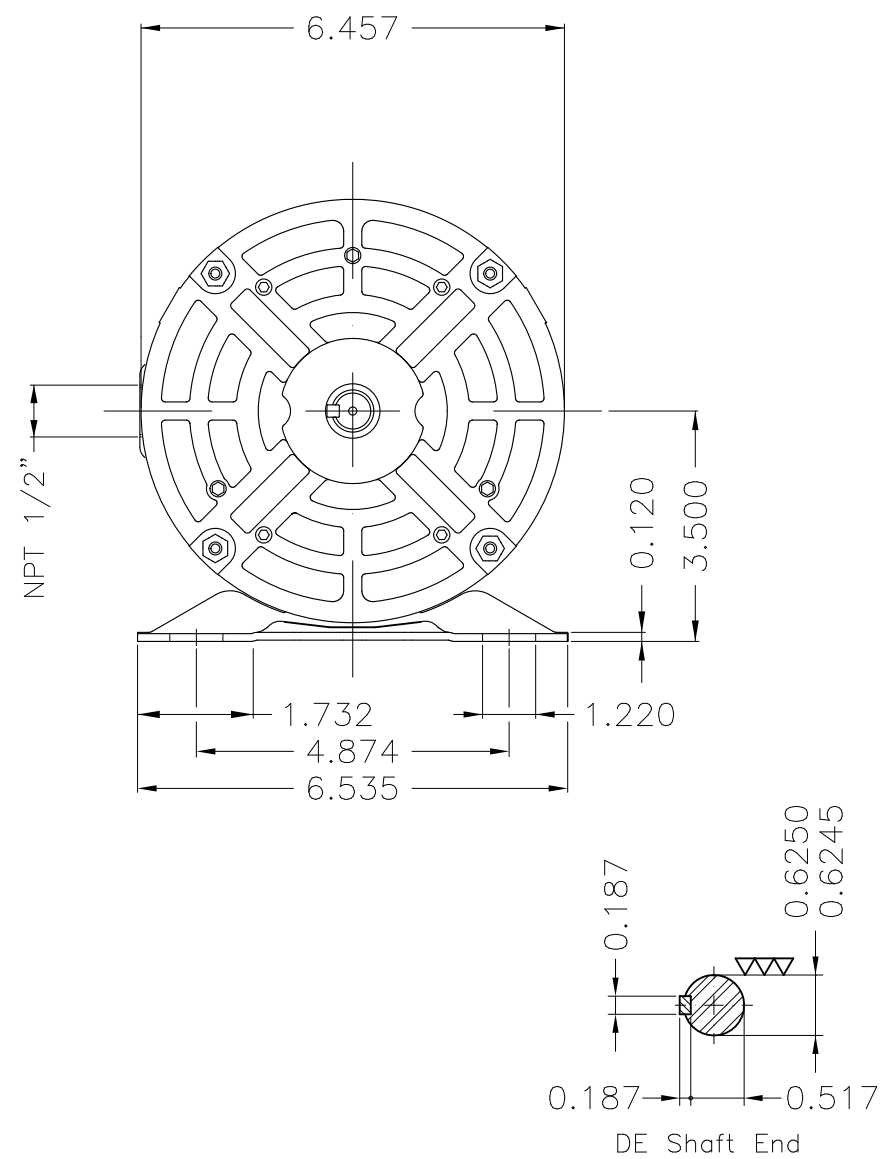

Without coating										
Mounting F-1/B3R(D)										
ECM	LOC	SUMMARY OF MODIFICATIONS				EXECUTED	CHECKED	RELEASED	DATE	VER
EXECUTED	PIRWUSER	THREE PH. MOTOR ROLLED STEEL PREM. EFF.					PREVIEW WDD			
CHECKED		FRAME 56 IP21 ODP								
RELEASED										
REL DT.		WMO	Jaragua do Sul	Product Engineering	SHEET	1 / 1				

0.33 HP 04 Poles 60 Hz

A



NEMA
Premium



3PT9



Energy Verified

MADE IN MEXICO

MAT: 12809013

W01.T00IC0X0X

MODEL 33180T3E56-S

22MAR2022 B/N:



PH 3	Hz 60	HP 0.33
FR 56		KW 0.25
DUTY CONT.		V 230/460
ALT 1000 m.a.s.l.		A 1.34/0.668
INS CL F AT 80K		SFA 1.81/0.902
AMB 40°C	DES -	SF 1.35
ENCL ODP	CODE M	PF 0.64
USABLE @ 208V 1.48A		RPM 1765
SF1.00		AVG.F.L. 73.4%

ALTERNATE RATING: 0.33HP 50Hz 190-220/380-415V SF1.35
1.44-1.40/0.718-0.740A 1450RPM EFF 71.2% (IE2) IEC 60034-1

Inverter duty motor For 80Hz use on VPWM 1000:1 VT, 5:1 CT

DE 6203-ZZ	ODE 6202-ZZ	MOBIL POLYREX EM
-------------------	--------------------	-------------------------



T1-BLU T2-WHT
 T3-ORG T4-YEL
 T5-BLK T6-GRY
 T7-PNK T8-RED
 T9-BRK RED

INTERCHANGE ANY TWO LINE WIRES TO REVERSE THE ROTATION

WARNING: Motor must be grounded in accordance with local and national electrical codes to prevent serious electrical shocks. Disconnect power source before servicing unit.



AVERTISSEMENT: Le moteur doit être mis à la terre

conformément aux codes électriques locaux et nationaux afin d'éviter tout choc électrique grave. Déconnectez l'alimentation avant l'entretien de la machine.

