

DATA SHEET

Three Phase Induction Motor - Squirrel Cage



Customer :					
Product line	: NEMA Premium Efficiency Three-Phase	Product code :	12075631		
		Catalog # :	40018ET3G449TS-W22		
Frame	: L447/9TS	Cooling method	: IC411 - TEFC		
Insulation class	: F	Mounting	: F-1		
Duty cycle	: Cont.(S1)	Rotation ¹	: Both (CW and CCW)		
Ambient temperature	: -20°C to +40°C	Starting method	: Direct On Line		
Altitude	: 1000 m.a.s.l.	Approx. weight ²	: 3177 lb		
Protection degree	: IP55	Moment of inertia (J)	: 136 sq.ft.lb		
Design	: B				
Output [HP]	400	350	350	350	
Poles	4	4	4	4	
Frequency [Hz]	60	50	50	50	
Rated voltage [V]	460	380	400	415	
Rated current [A]	445	461	448	437	
L. R. Amperes [A]	2893	2766	3002	3146	
LRC [A]	6.5x(Code G)	6.0x(Code F)	6.7x(Code G)	7.2x(Code H)	
No load current [A]	125	125	140	155	
Rated speed [RPM]	1785	1485	1485	1485	
Slip [%]	0.83	1.00	1.00	1.00	
Rated torque [ft.lb]	1180	1240	1240	1240	
Locked rotor torque [%]	250	229	250	280	
Breakdown torque [%]	260	240	270	290	
Service factor	1.15	1.15	1.15	1.15	
Temperature rise	80 K	105 K	80 K	80 K	
Locked rotor time	37s (cold) 21s (hot)	43s (cold) 24s (hot)	37s (cold) 21s (hot)	32s (cold) 18s (hot)	
Noise level ²	79.0 dB(A)	74.0 dB(A)	74.0 dB(A)	74.0 dB(A)	
Efficiency (%)	25%	94.9	95.4	94.9	94.9
	50%	95.4	95.8	95.4	95.4
	75%	95.8	95.8	95.8	95.8
	100%	96.2	96.2	96.2	96.2
Power Factor	25%	0.55	0.56	0.52	0.48
	50%	0.80	0.81	0.77	0.74
	75%	0.85	0.86	0.84	0.82
	100%	0.88	0.89	0.87	0.86
Bearing type	: Drive end : 6314 C3	Non drive end : 6314 C3	Foundation loads		
Sealing	: WSeal	WSeal	Max. traction	: 7980 lb	
Lubrication interval	: 12000 h	12000 h	Max. compression	: 11157 lb	
Lubricant amount	: 27 g	27 g			
Lubricant type	: Mobil Polyrex EM				
Notes					
This revision replaces and cancel the previous one, which must be eliminated. (1) Looking the motor from the shaft end. (2) Measured at 1m and with tolerance of +3dB(A). (3) Approximate weight subject to changes after manufacturing process. (4) At 100% of full load.			These are average values based on tests with sinusoidal power supply, subject to the tolerances stipulated in NEMA MG-1.		
Rev.	Changes Summary		Performed	Checked	Date
Performed by					
Checked by				Page	Revision
Date	13/04/2022			1 / 21	

TORQUE AND CURRENT VS SPEED CURVE

Three Phase Induction Motor - Squirrel Cage



Customer :

Product line : NEMA Premium Efficiency Three-Phase

Product code : 12075631

Catalog # : 40018ET3G449TS-W22

TORQUE AND CURRENT VS SPEED CURVE

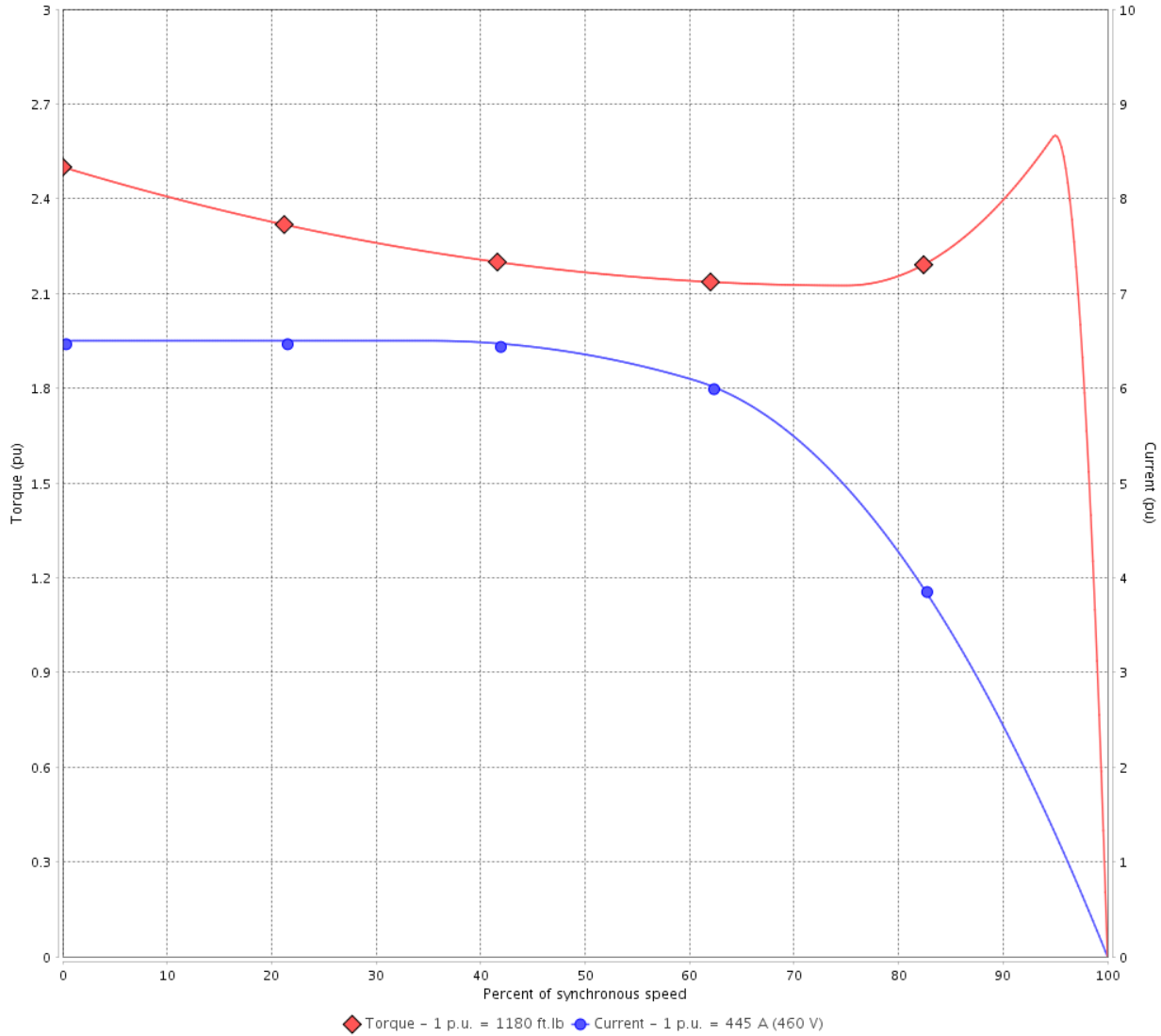

Performance : 460 V 60 Hz 4P

Rated current	: 445 A	Moment of inertia (J)	: 136 sq.ft.lb
LRC	: 6.5	Duty cycle	: Cont.(S1)
Rated torque	: 1180 ft.lb	Insulation class	: F
Locked rotor torque	: 250 %	Service factor	: 1.15
Breakdown torque	: 260 %	Temperature rise	: 80 K
Rated speed	: 1785 rpm	Design	: B

Locked rotor time : 37s (cold) 21s (hot)

Rev.	Changes Summary	Performed	Checked	Date
Performed by			Page 2 / 21	Revision
Checked by				
Date	13/04/2022			

TORQUE AND CURRENT VS SPEED CURVE



Three Phase Induction Motor - Squirrel Cage

Customer :

Product line : NEMA Premium Efficiency Three-Phase

Product code : 12075631

Catalog # : 40018ET3G449TS-W22

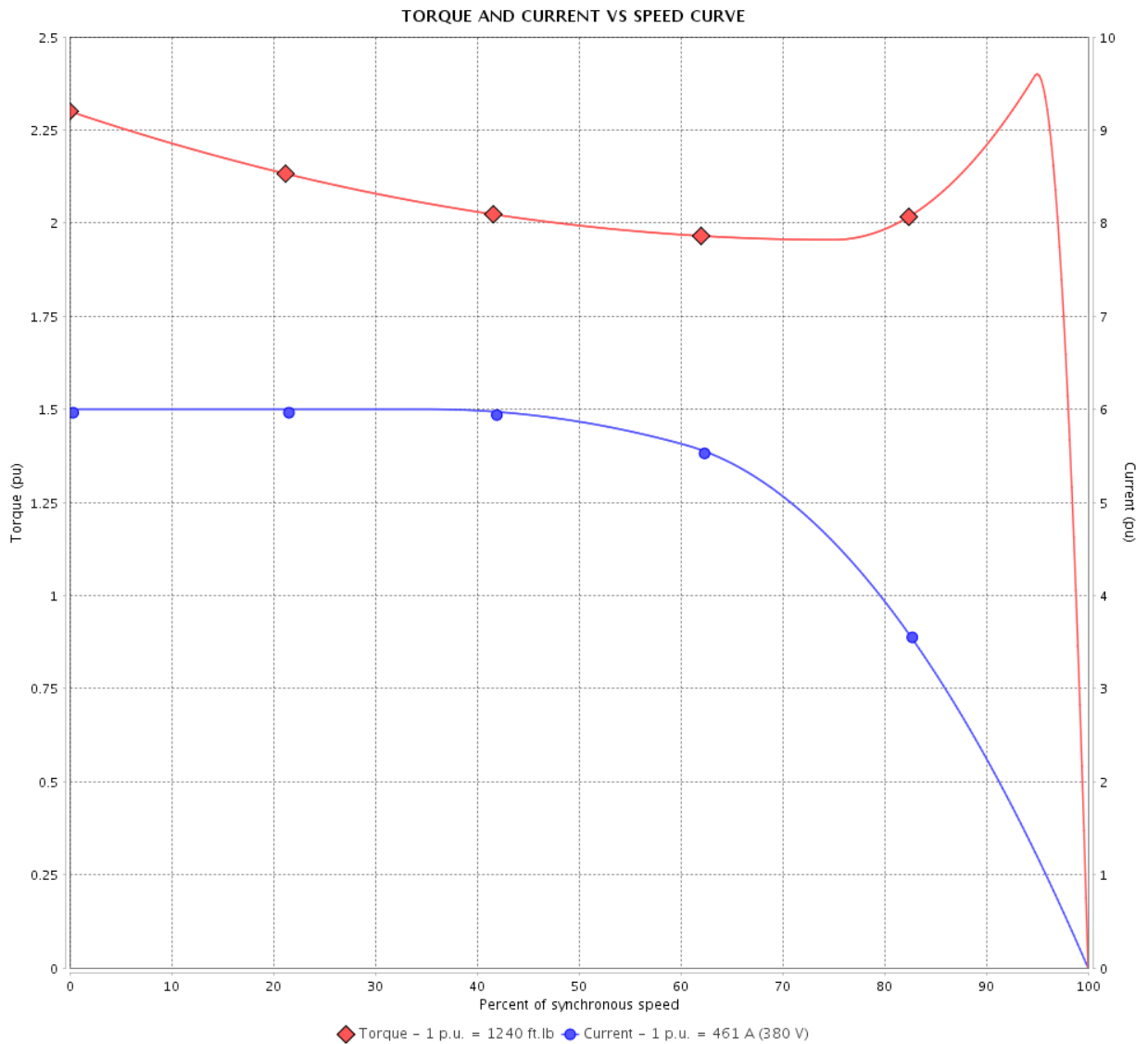

Performance : 380 V 50 Hz 4P IE3

Rated current	: 461 A	Moment of inertia (J)	: 136 sq.ft.lb
LRC	: 6.0	Duty cycle	: Cont.(S1)
Rated torque	: 1240 ft.lb	Insulation class	: F
Locked rotor torque	: 229 %	Service factor	: 1.15
Breakdown torque	: 240 %	Temperature rise	: 105 K
Rated speed	: 1485 rpm	Design	: B

Locked rotor time : 43s (cold) 24s (hot)

Rev.	Changes Summary	Performed	Checked	Date
Performed by		Page		Revision
Checked by		3 / 21		
Date	13/04/2022			

TORQUE AND CURRENT VS SPEED CURVE

Three Phase Induction Motor - Squirrel Cage



Customer :

Product line : NEMA Premium Efficiency Three-Phase

Product code : 12075631

Catalog # : 40018ET3G449TS-W22

TORQUE AND CURRENT VS SPEED CURVE

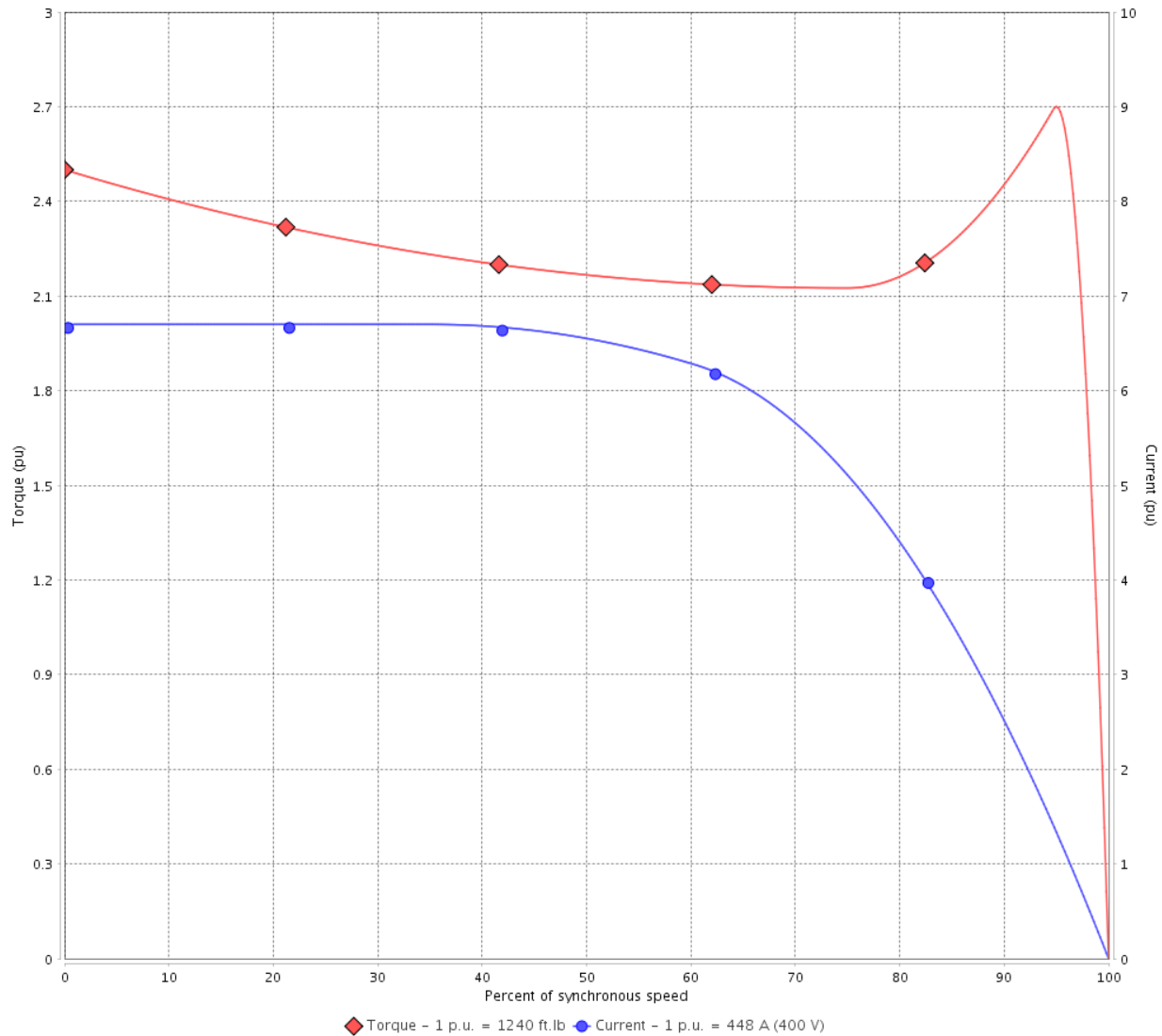

Performance : 400 V 50 Hz 4P IE3

Rated current	: 448 A	Moment of inertia (J)	: 136 sq.ft.lb
LRC	: 6.7	Duty cycle	: Cont.(S1)
Rated torque	: 1240 ft.lb	Insulation class	: F
Locked rotor torque	: 250 %	Service factor	: 1.15
Breakdown torque	: 270 %	Temperature rise	: 80 K
Rated speed	: 1485 rpm	Design	: B

Locked rotor time : 37s (cold) 21s (hot)

Rev.	Changes Summary	Performed	Checked	Date
Performed by			Page 4 / 21	Revision
Checked by				
Date	13/04/2022			

TORQUE AND CURRENT VS SPEED CURVE



Three Phase Induction Motor - Squirrel Cage

Customer :

Product line : NEMA Premium Efficiency Three-Phase

Product code : 12075631

Catalog # : 40018ET3G449TS-W22

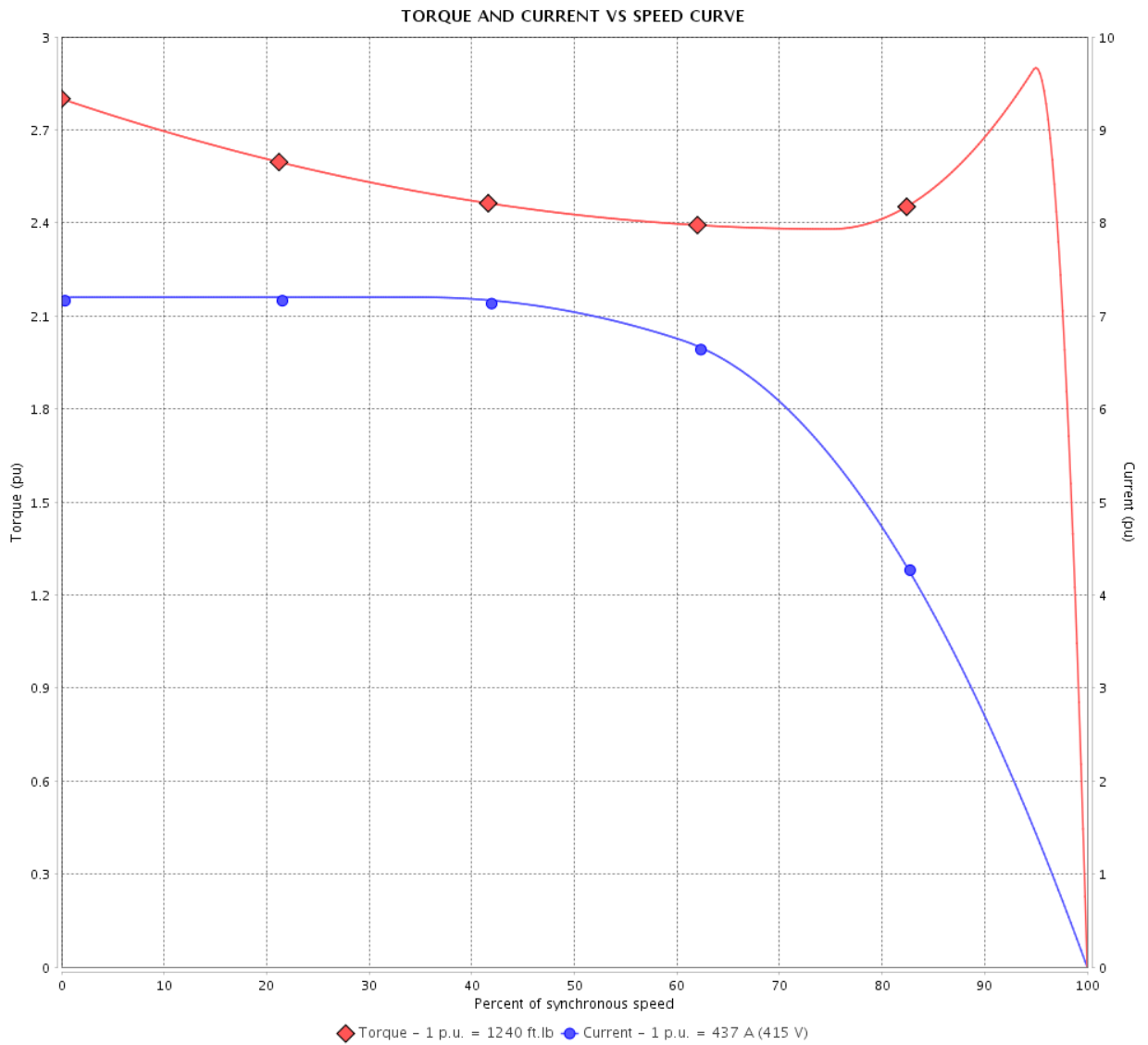

Performance : 415 V 50 Hz 4P IE3

Rated current	: 437 A	Moment of inertia (J)	: 136 sq.ft.lb
LRC	: 7.2	Duty cycle	: Cont.(S1)
Rated torque	: 1240 ft.lb	Insulation class	: F
Locked rotor torque	: 280 %	Service factor	: 1.15
Breakdown torque	: 290 %	Temperature rise	: 80 K
Rated speed	: 1485 rpm	Design	: B

Locked rotor time : 32s (cold) 18s (hot)

Rev.	Changes Summary	Performed	Checked	Date
Performed by			Page	Revision
Checked by			5 / 21	
Date	13/04/2022			

LOAD PERFORMANCE CURVE

Three Phase Induction Motor - Squirrel Cage



Customer : _____

Product line : NEMA Premium Efficiency Three-Phase

Product code : 12075631

Catalog # : 40018ET3G449TS-W22

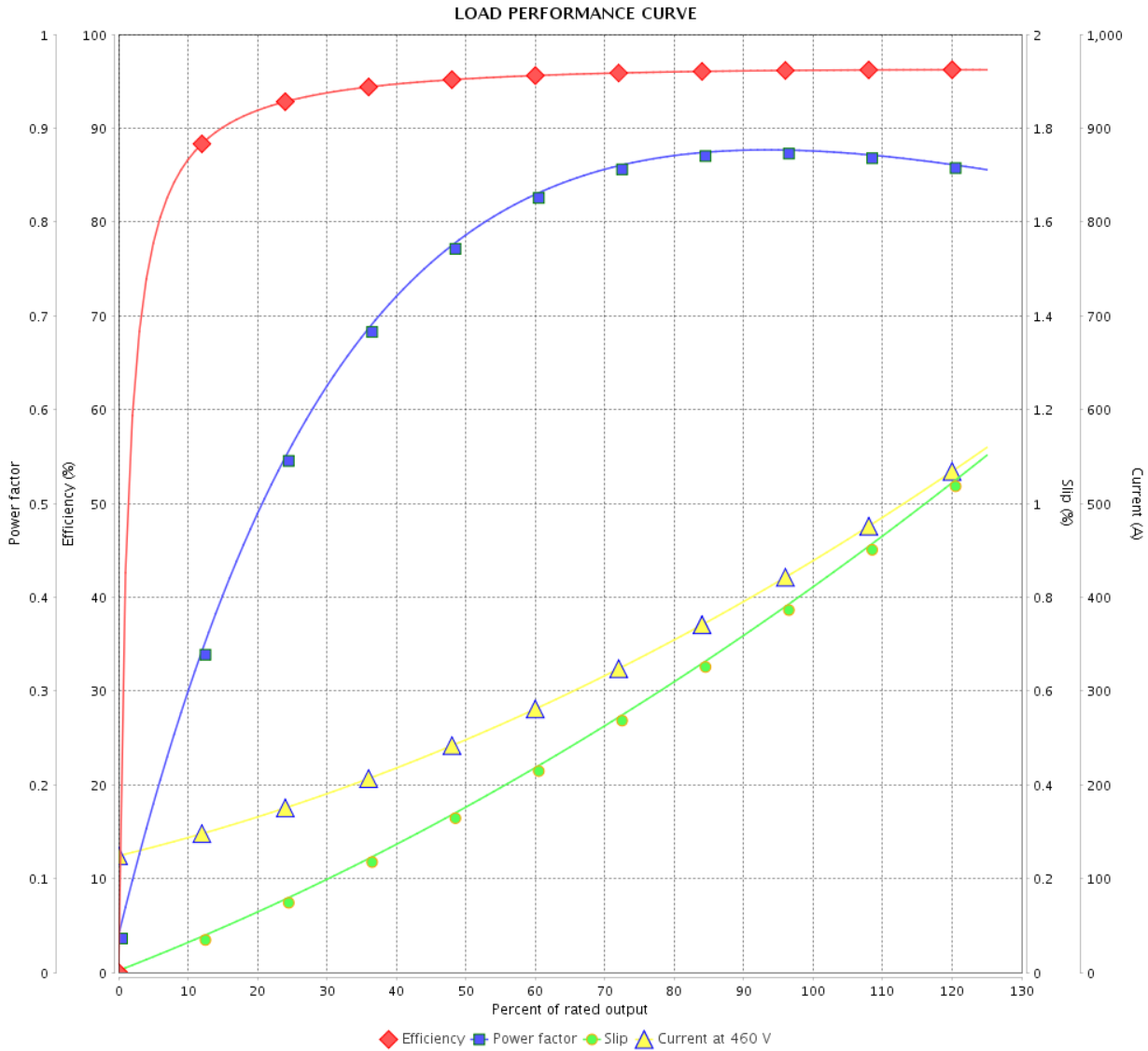

Performance : 460 V 60 Hz 4P

Rated current : 445 A
 LRC : 6.5
 Rated torque : 1180 ft.lb
 Locked rotor torque : 250 %
 Breakdown torque : 260 %
 Rated speed : 1785 rpm

Moment of inertia (J) : 136 sq.ft.lb
 Duty cycle : Cont.(S1)
 Insulation class : F
 Service factor : 1.15
 Temperature rise : 80 K
 Design : B

Rev.	Changes Summary	Performed	Checked	Date
Performed by			Page	Revision
Checked by				
Date				

LOAD PERFORMANCE CURVE

Three Phase Induction Motor - Squirrel Cage



Customer : _____

Product line : NEMA Premium Efficiency Three-Phase

Product code : 12075631

Catalog # : 40018ET3G449TS-W22

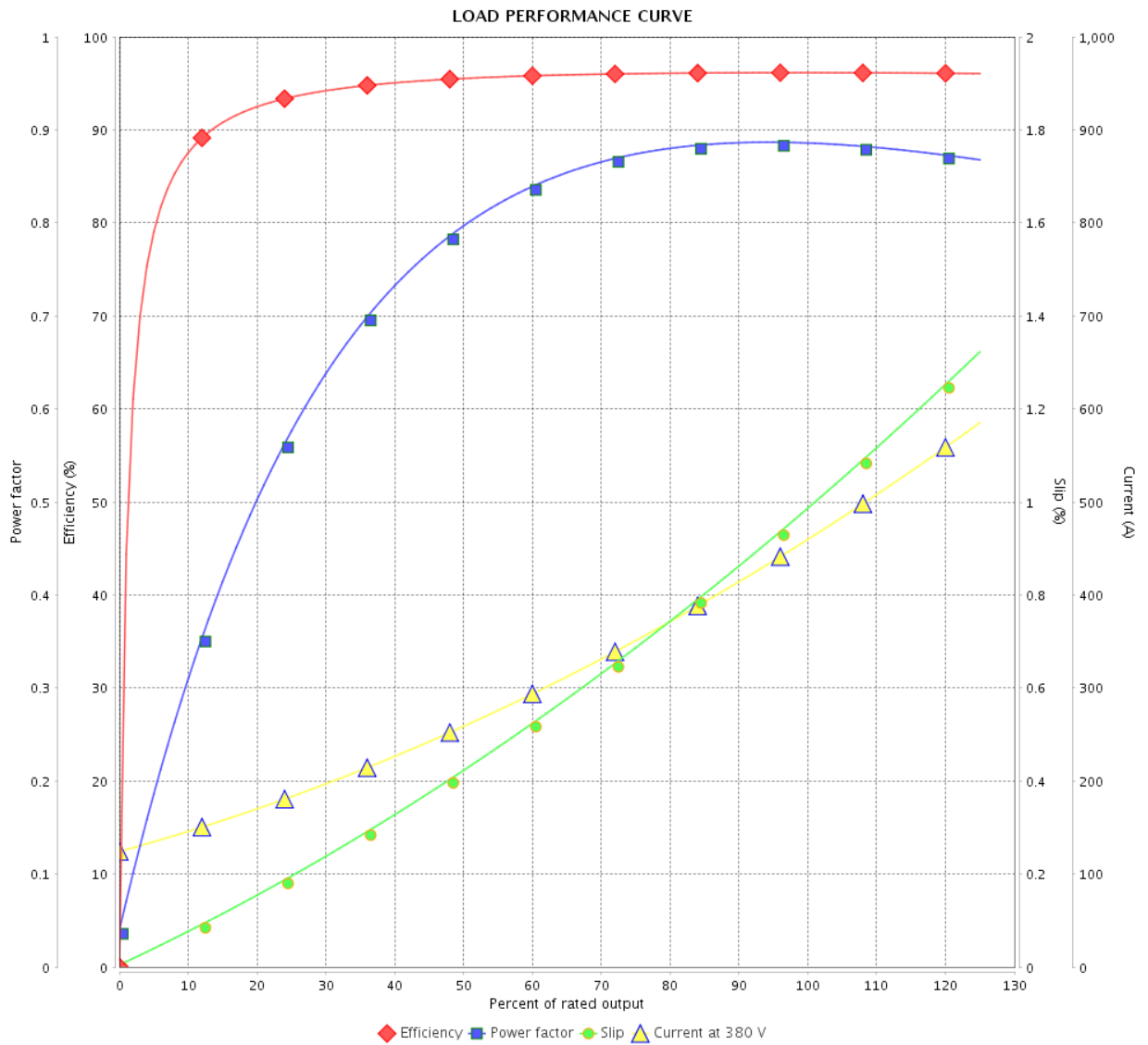

Performance : 380 V 50 Hz 4P IE3

Rated current : 461 A
 LRC : 6.0
 Rated torque : 1240 ft.lb
 Locked rotor torque : 229 %
 Breakdown torque : 240 %
 Rated speed : 1485 rpm

Moment of inertia (J) : 136 sq.ft.lb
 Duty cycle : Cont.(S1)
 Insulation class : F
 Service factor : 1.15
 Temperature rise : 105 K
 Design : B

Rev.	Changes Summary	Performed	Checked	Date
Performed by				
Checked by				
Date				
		Page	Revision	
		7 / 21		

LOAD PERFORMANCE CURVE

Three Phase Induction Motor - Squirrel Cage



Customer : _____

Product line : NEMA Premium Efficiency Three-Phase

Product code : 12075631

Catalog # : 40018ET3G449TS-W22

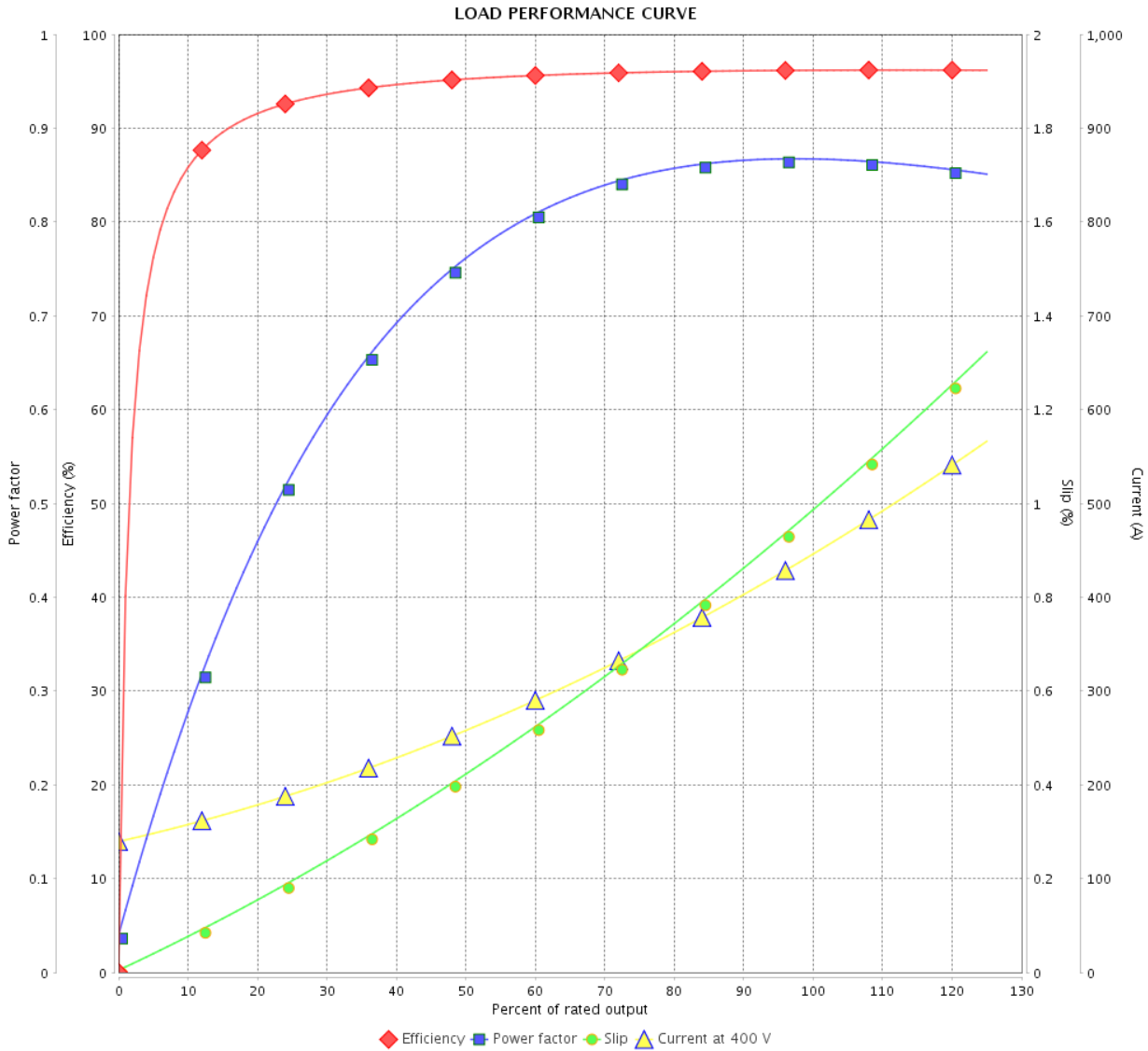

Performance : 400 V 50 Hz 4P IE3

Rated current : 448 A
 LRC : 6.7
 Rated torque : 1240 ft.lb
 Locked rotor torque : 250 %
 Breakdown torque : 270 %
 Rated speed : 1485 rpm

Moment of inertia (J) : 136 sq.ft.lb
 Duty cycle : Cont.(S1)
 Insulation class : F
 Service factor : 1.15
 Temperature rise : 80 K
 Design : B

Rev.	Changes Summary	Performed	Checked	Date
Performed by			Page 8 / 21	Revision
Checked by				
Date	13/04/2022			

LOAD PERFORMANCE CURVE

Three Phase Induction Motor - Squirrel Cage



Customer :

Product line : NEMA Premium Efficiency Three-Phase

Product code : 12075631

Catalog # : 40018ET3G449TS-W22

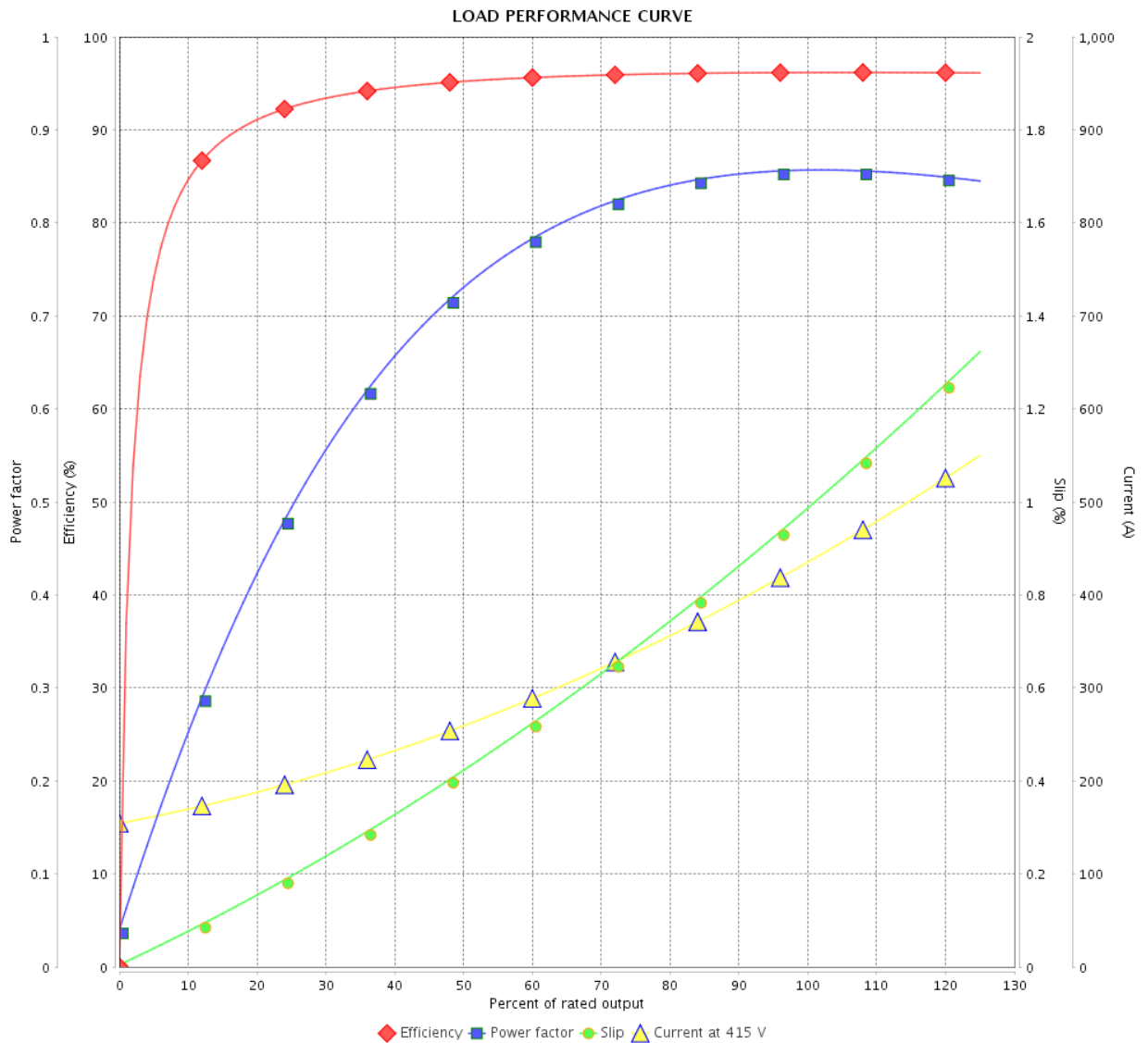

Performance : 415 V 50 Hz 4P IE3

Rated current : 437 A
 LRC : 7.2
 Rated torque : 1240 ft.lb
 Locked rotor torque : 280 %
 Breakdown torque : 290 %
 Rated speed : 1485 rpm

Moment of inertia (J) : 136 sq.ft.lb
 Duty cycle : Cont.(S1)
 Insulation class : F
 Service factor : 1.15
 Temperature rise : 80 K
 Design : B

Rev.	Changes Summary	Performed	Checked	Date
Performed by		Page		Revision
Checked by		9 / 21		
Date		13/04/2022		

THERMAL LIMIT CURVE



Three Phase Induction Motor - Squirrel Cage

Customer :

Product line : NEMA Premium Efficiency Three-Phase
Product code : 12075631
Catalog # : 40018ET3G449TS-W22

Performance : 460 V 60 Hz 4P

Rated current	: 445 A	Moment of inertia (J)	: 136 sq.ft.lb
LRC	: 6.5	Duty cycle	: Cont.(S1)
Rated torque	: 1180 ft.lb	Insulation class	: F
Locked rotor torque	: 250 %	Service factor	: 1.15
Breakdown torque	: 260 %	Temperature rise	: 80 K
Rated speed	: 1785 rpm	Design	: B

Heating constant

Cooling constant

Rev.	Changes Summary	Performed	Checked	Date
Performed by				
Checked by			Page	Revision
Date	13/04/2022		10 / 21	

THERMAL LIMIT CURVE

Three Phase Induction Motor - Squirrel Cage



Customer : _____

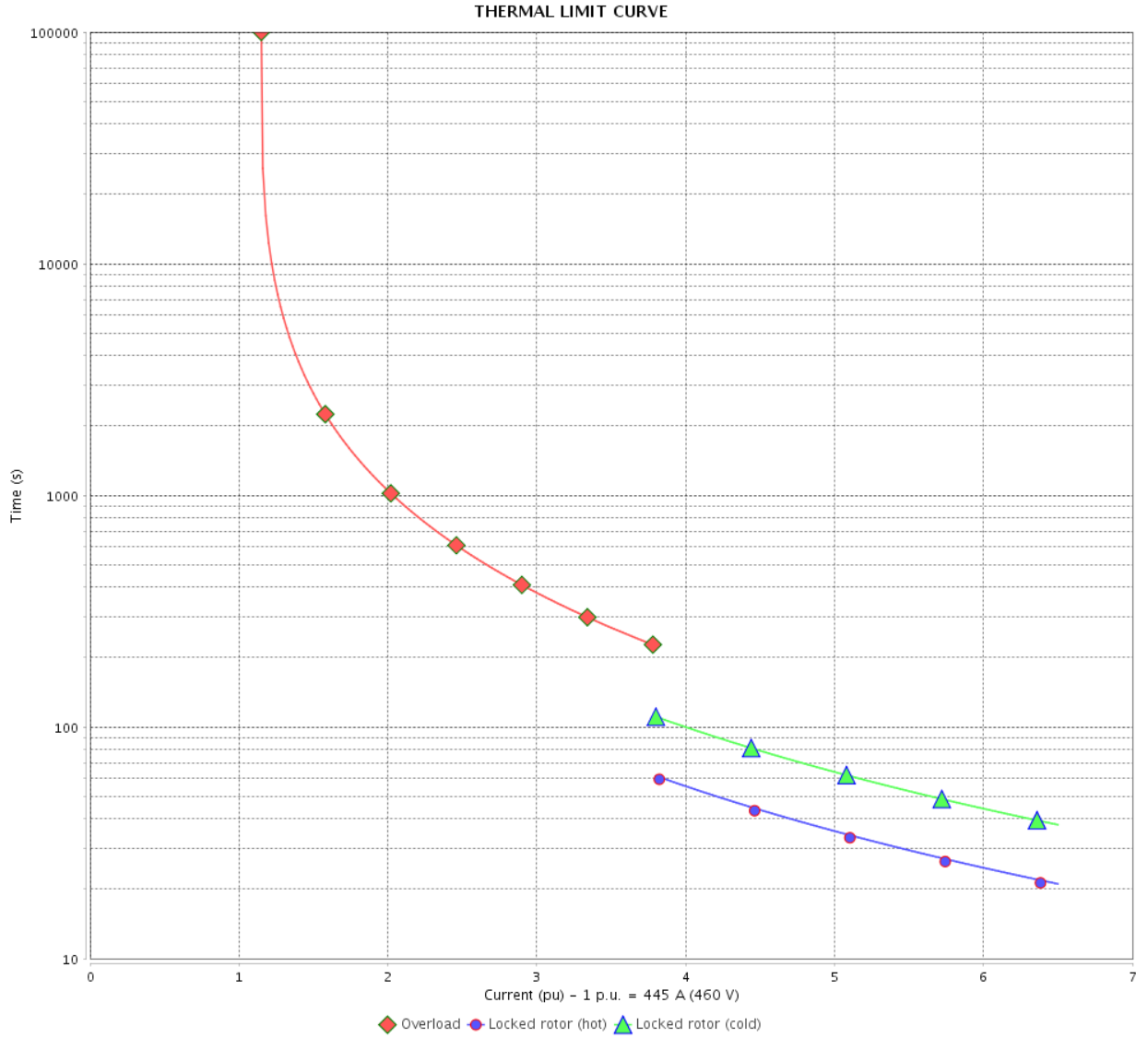

Rev.	Changes Summary	Performed	Checked	Date
Performed by		Page 11 / 21		Revision
Checked by				
Date				

THERMAL LIMIT CURVE

Three Phase Induction Motor - Squirrel Cage



Customer :

Product line : NEMA Premium Efficiency Three-Phase
Product code : 12075631
Catalog # : 40018ET3G449TS-W22

Performance : 380 V 50 Hz 4P IE3

Rated current	: 461 A	Moment of inertia (J)	: 136 sq.ft.lb
LRC	: 6.0	Duty cycle	: Cont.(S1)
Rated torque	: 1240 ft.lb	Insulation class	: F
Locked rotor torque	: 229 %	Service factor	: 1.15
Breakdown torque	: 240 %	Temperature rise	: 105 K
Rated speed	: 1485 rpm	Design	: B

Heating constant

Cooling constant

Rev.	Changes Summary	Performed	Checked	Date
Performed by				
Checked by			Page	Revision
Date	13/04/2022		12 / 21	

THERMAL LIMIT CURVE

Three Phase Induction Motor - Squirrel Cage



Customer : _____

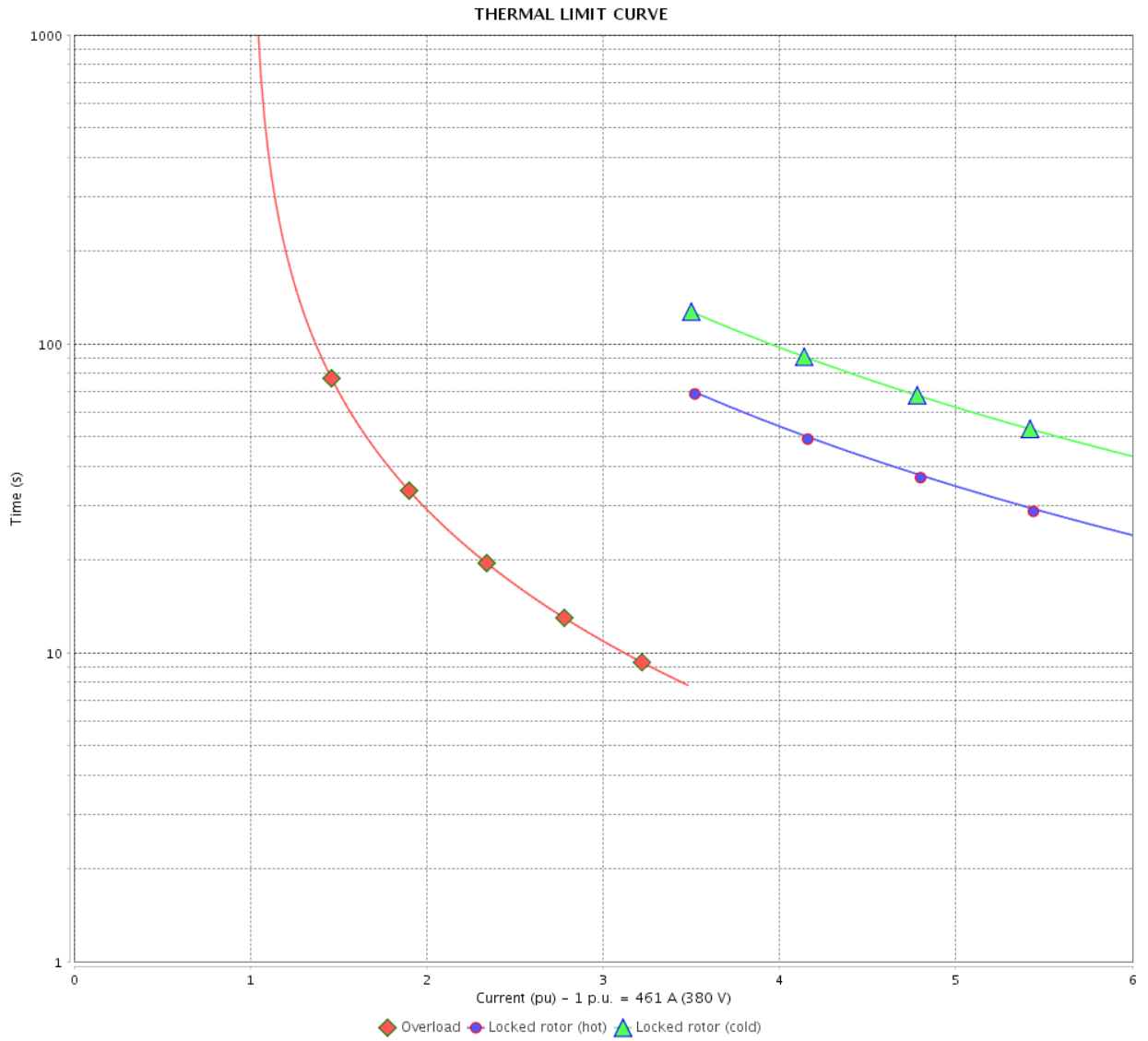

Rev.	Changes Summary	Performed	Checked	Date
Performed by		Page		Revision
Checked by		13 / 21		
Date		13/04/2022		

THERMAL LIMIT CURVE

Three Phase Induction Motor - Squirrel Cage



Customer :

Product line : NEMA Premium Efficiency Three-Phase
Product code : 12075631
Catalog # : 40018ET3G449TS-W22

Performance : 400 V 50 Hz 4P IE3

Rated current	: 448 A	Moment of inertia (J)	: 136 sq.ft.lb
LRC	: 6.7	Duty cycle	: Cont.(S1)
Rated torque	: 1240 ft.lb	Insulation class	: F
Locked rotor torque	: 250 %	Service factor	: 1.15
Breakdown torque	: 270 %	Temperature rise	: 80 K
Rated speed	: 1485 rpm	Design	: B

Heating constant

Cooling constant

Rev.	Changes Summary	Performed	Checked	Date
Performed by				
Checked by			Page	Revision
Date	13/04/2022		14 / 21	

THERMAL LIMIT CURVE

Three Phase Induction Motor - Squirrel Cage



Customer : _____

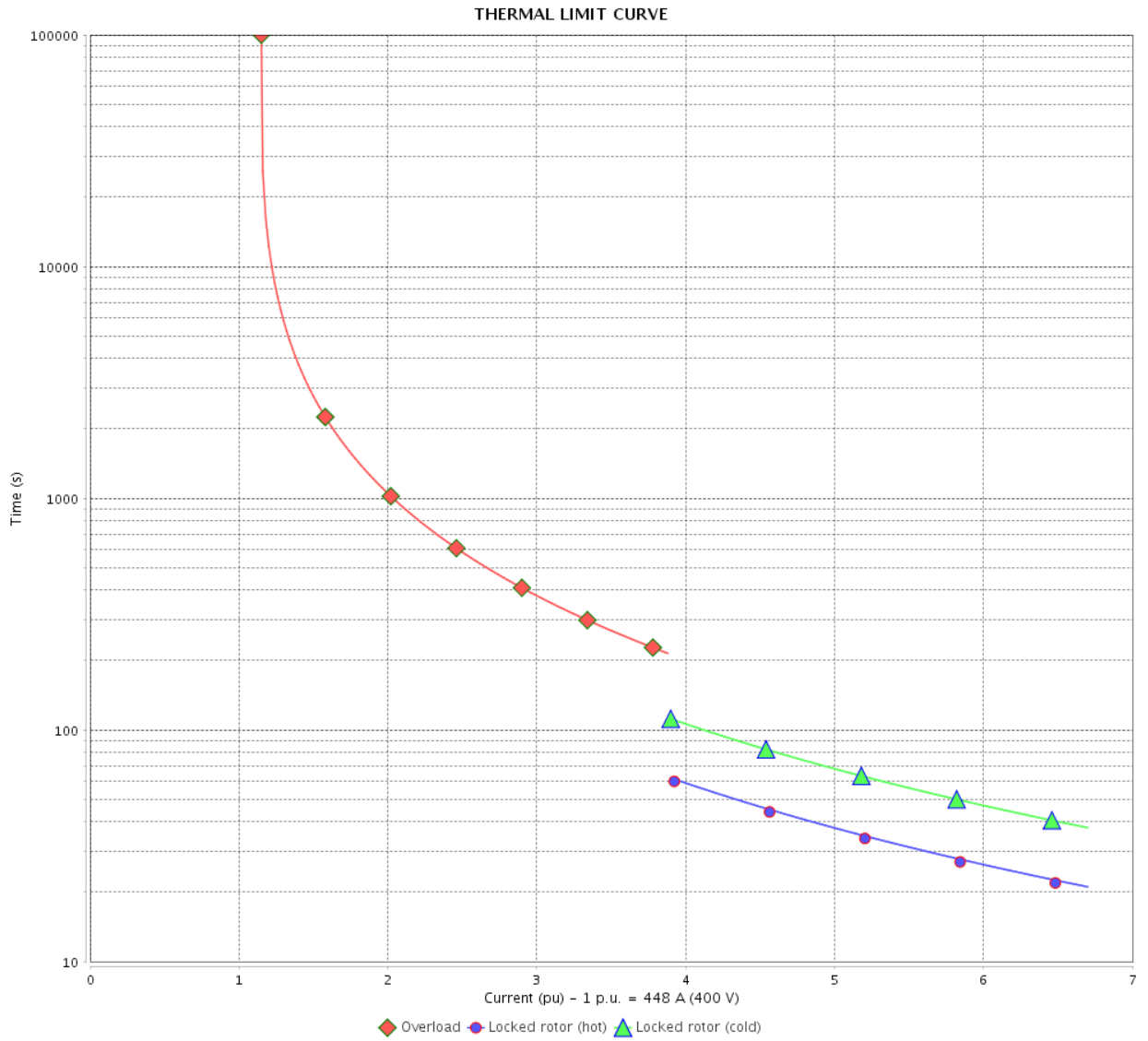

Rev.	Changes Summary	Performed	Checked	Date
Performed by		Page		Revision
Checked by		15 / 21		
Date		13/04/2022		

THERMAL LIMIT CURVE



Three Phase Induction Motor - Squirrel Cage

Customer :

Product line : NEMA Premium Efficiency Three-Phase
Product code : 12075631
Catalog # : 40018ET3G449TS-W22

Performance : 415 V 50 Hz 4P IE3

Rated current	: 437 A	Moment of inertia (J)	: 136 sq.ft.lb
LRC	: 7.2	Duty cycle	: Cont.(S1)
Rated torque	: 1240 ft.lb	Insulation class	: F
Locked rotor torque	: 280 %	Service factor	: 1.15
Breakdown torque	: 290 %	Temperature rise	: 80 K
Rated speed	: 1485 rpm	Design	: B

Heating constant

Cooling constant

Rev.	Changes Summary	Performed	Checked	Date
Performed by				
Checked by			Page	Revision
Date	13/04/2022		16 / 21	

THERMAL LIMIT CURVE

Three Phase Induction Motor - Squirrel Cage



Customer : _____

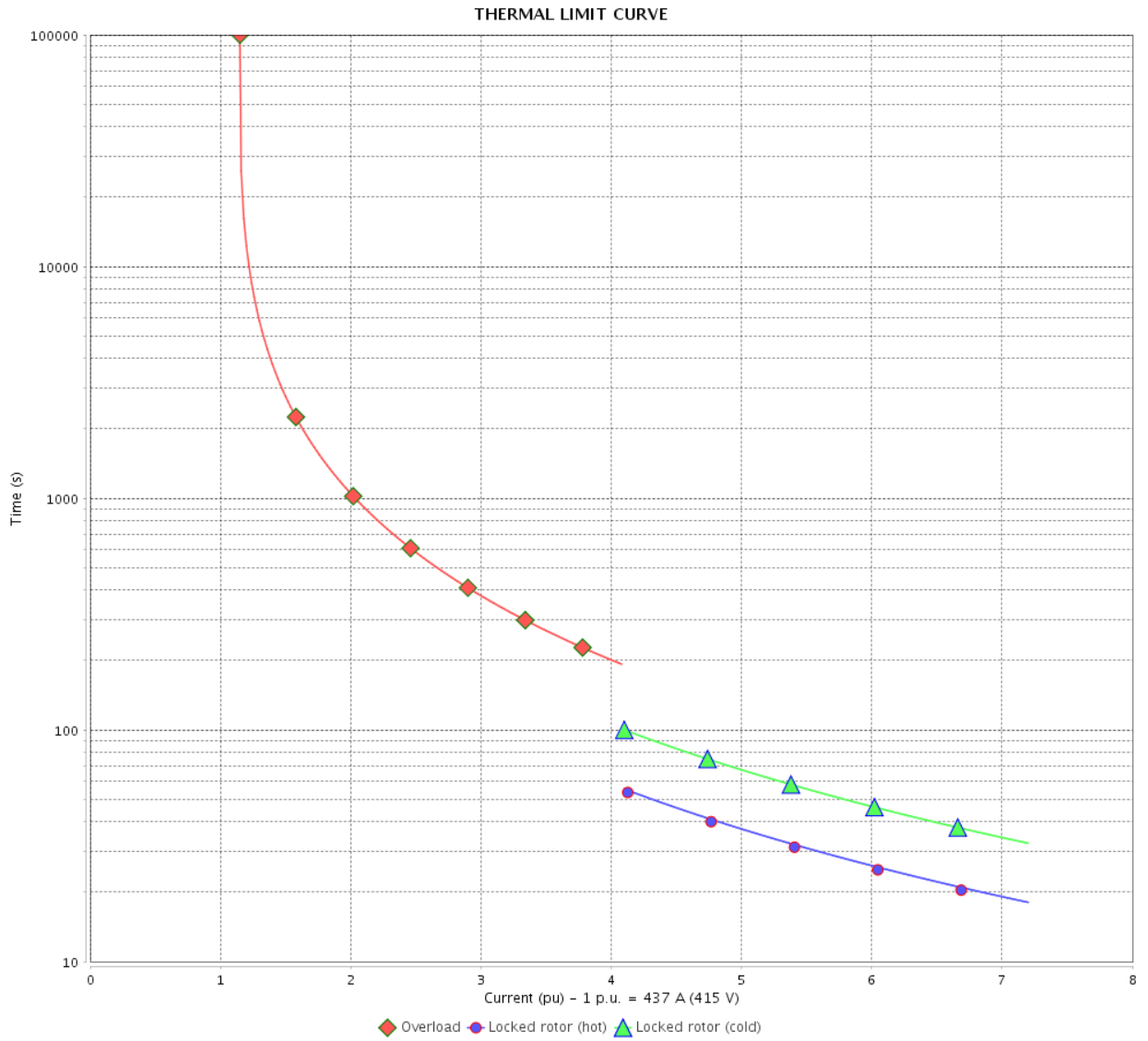

Rev.	Changes Summary	Performed	Checked	Date
Performed by		Page		Revision
Checked by		17 / 21		
Date		13/04/2022		

VFD OPERATION CURVE

Three Phase Induction Motor - Squirrel Cage



Customer :

Product line : NEMA Premium Efficiency Three-Phase

Product code : 12075631

Catalog # : 40018ET3G449TS-W22

VFD OPERATION CURVE

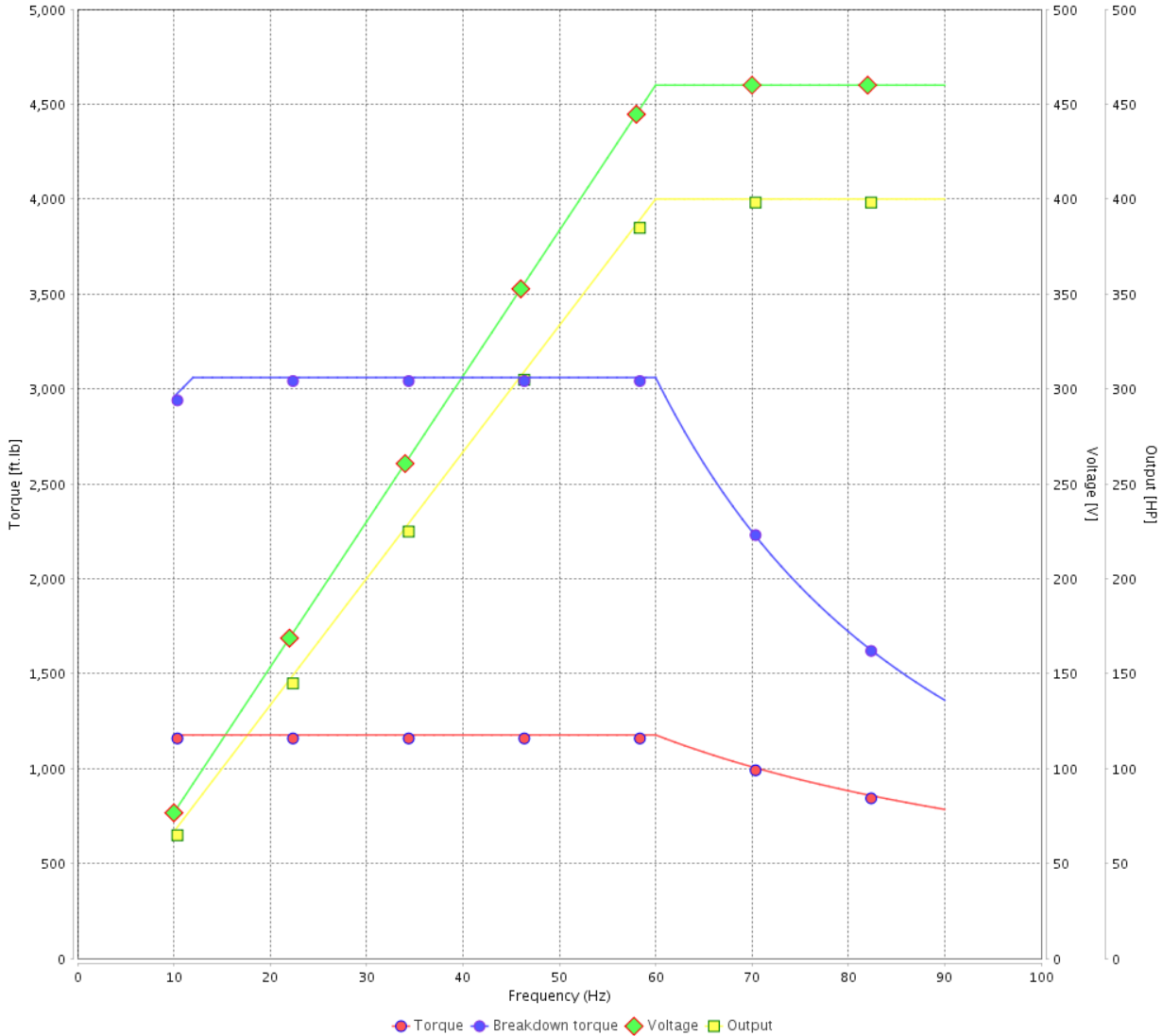

Performance : 460 V 60 Hz 4P

Rated current : 445 A
 LRC : 6.5
 Rated torque : 1180 ft.lb
 Locked rotor torque : 250 %
 Breakdown torque : 260 %
 Rated speed : 1785 rpm

Moment of inertia (J) : 136 sq.ft.lb
 Duty cycle : Cont.(S1)
 Insulation class : F
 Service factor : 1.15
 Temperature rise : 80 K
 Design : B

Rev.	Changes Summary	Performed	Checked	Date
Performed by			Page 18 / 21	Revision
Checked by				
Date	13/04/2022			

VFD OPERATION CURVE

Three Phase Induction Motor - Squirrel Cage



Customer :

Product line : NEMA Premium Efficiency Three-Phase

Product code : 12075631

Catalog # : 40018ET3G449TS-W22

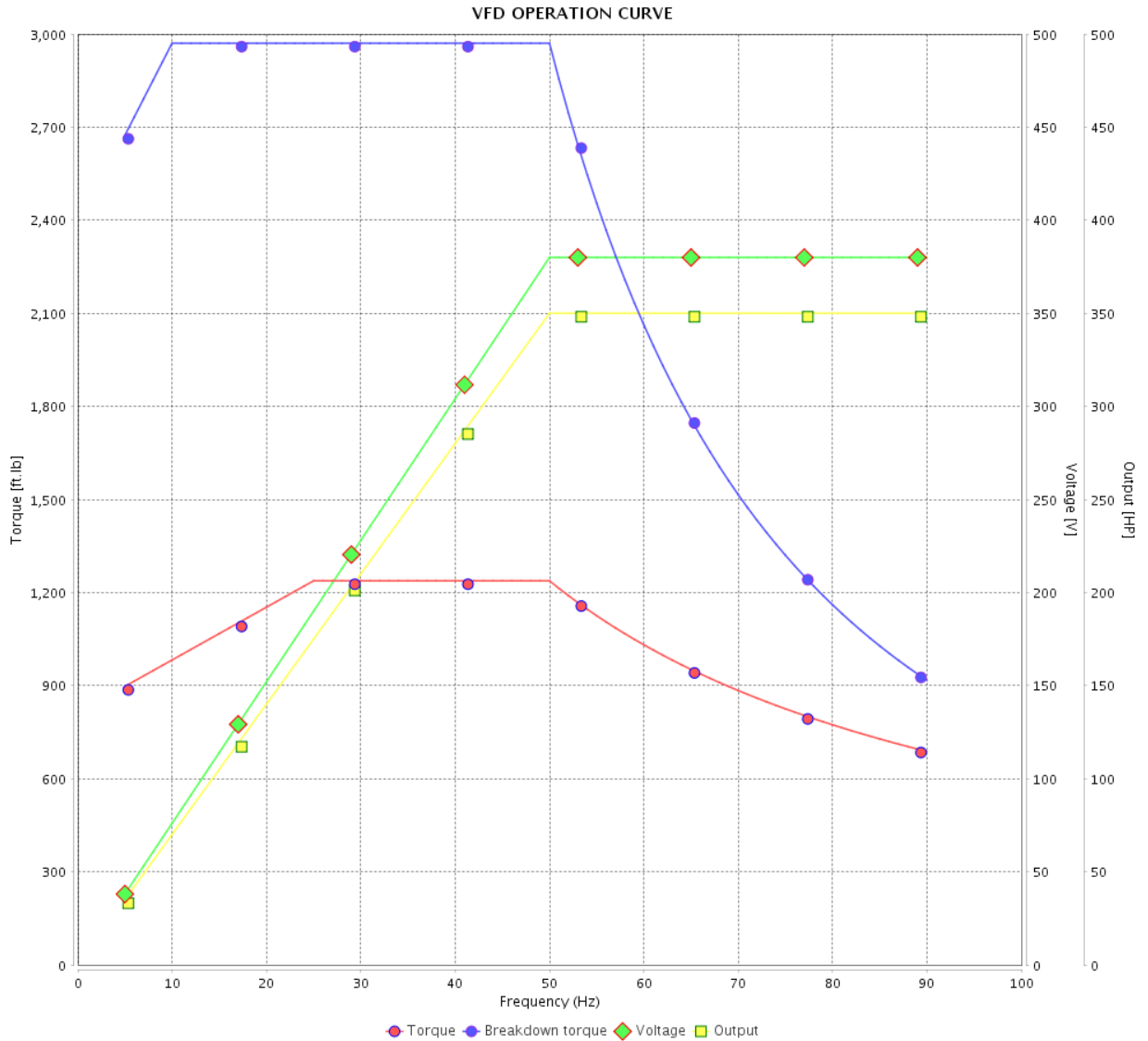

Performance : 380 V 50 Hz 4P IE3

Rated current : 461 A
 LRC : 6.0
 Rated torque : 1240 ft.lb
 Locked rotor torque : 229 %
 Breakdown torque : 240 %
 Rated speed : 1485 rpm

Moment of inertia (J) : 136 sq.ft.lb
 Duty cycle : Cont.(S1)
 Insulation class : F
 Service factor : 1.15
 Temperature rise : 105 K
 Design : B

Rev.	Changes Summary	Performed	Checked	Date
Performed by			Page 19 / 21	Revision
Checked by				
Date	13/04/2022			

VFD OPERATION CURVE

Three Phase Induction Motor - Squirrel Cage



Customer :

Product line : NEMA Premium Efficiency Three-Phase

Product code : 12075631

Catalog # : 40018ET3G449TS-W22

VFD OPERATION CURVE

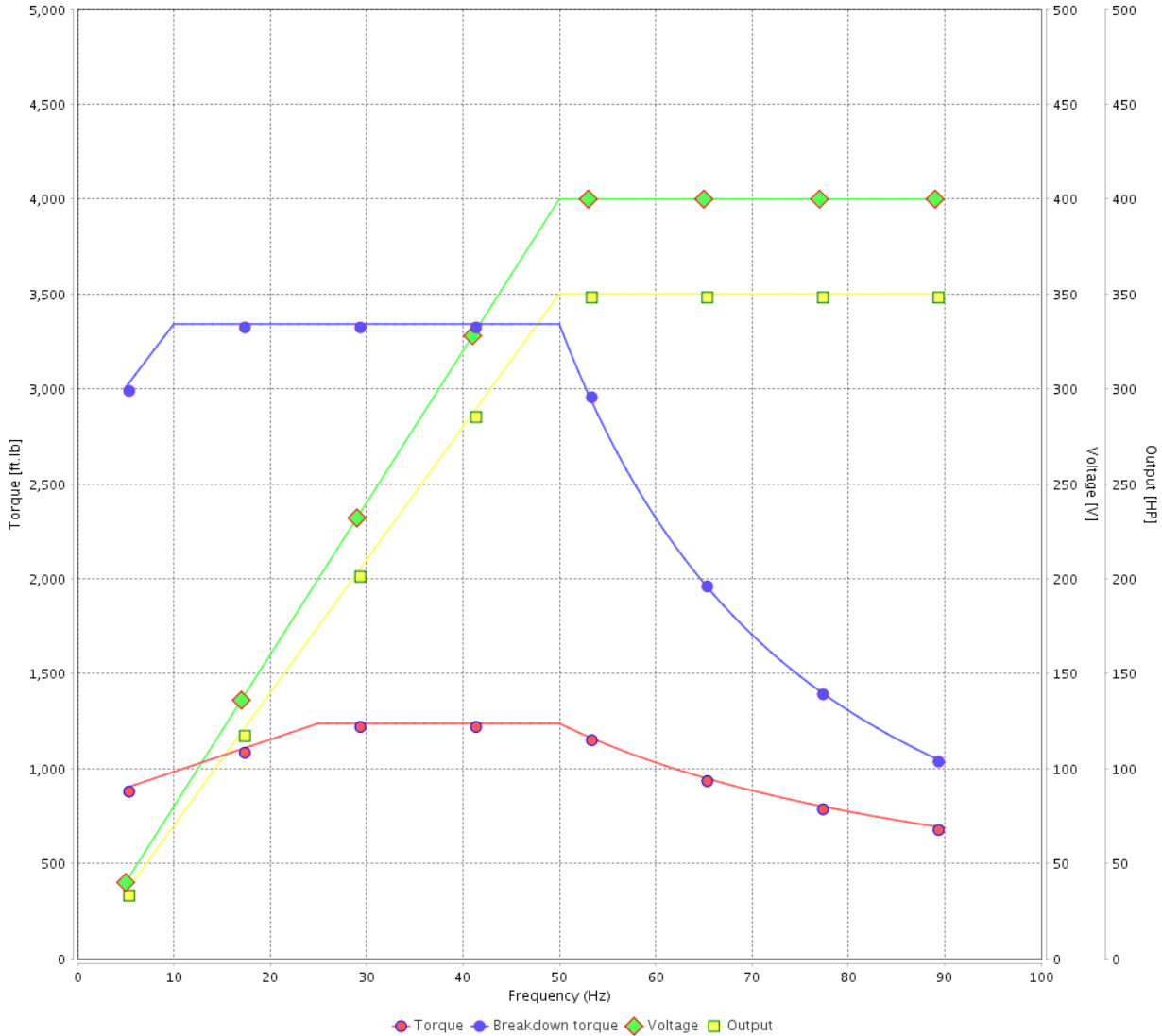

Performance : 400 V 50 Hz 4P IE3

Rated current : 448 A
 LRC : 6.7
 Rated torque : 1240 ft.lb
 Locked rotor torque : 250 %
 Breakdown torque : 270 %
 Rated speed : 1485 rpm

Moment of inertia (J) : 136 sq.ft.lb
 Duty cycle : Cont.(S1)
 Insulation class : F
 Service factor : 1.15
 Temperature rise : 80 K
 Design : B

Rev.	Changes Summary	Performed	Checked	Date
Performed by			Page 20 / 21	Revision
Checked by				
Date	13/04/2022			

VFD OPERATION CURVE

Three Phase Induction Motor - Squirrel Cage



Customer : _____

Product line : NEMA Premium Efficiency Three-Phase

Product code : 12075631

Catalog # : 40018ET3G449TS-W22

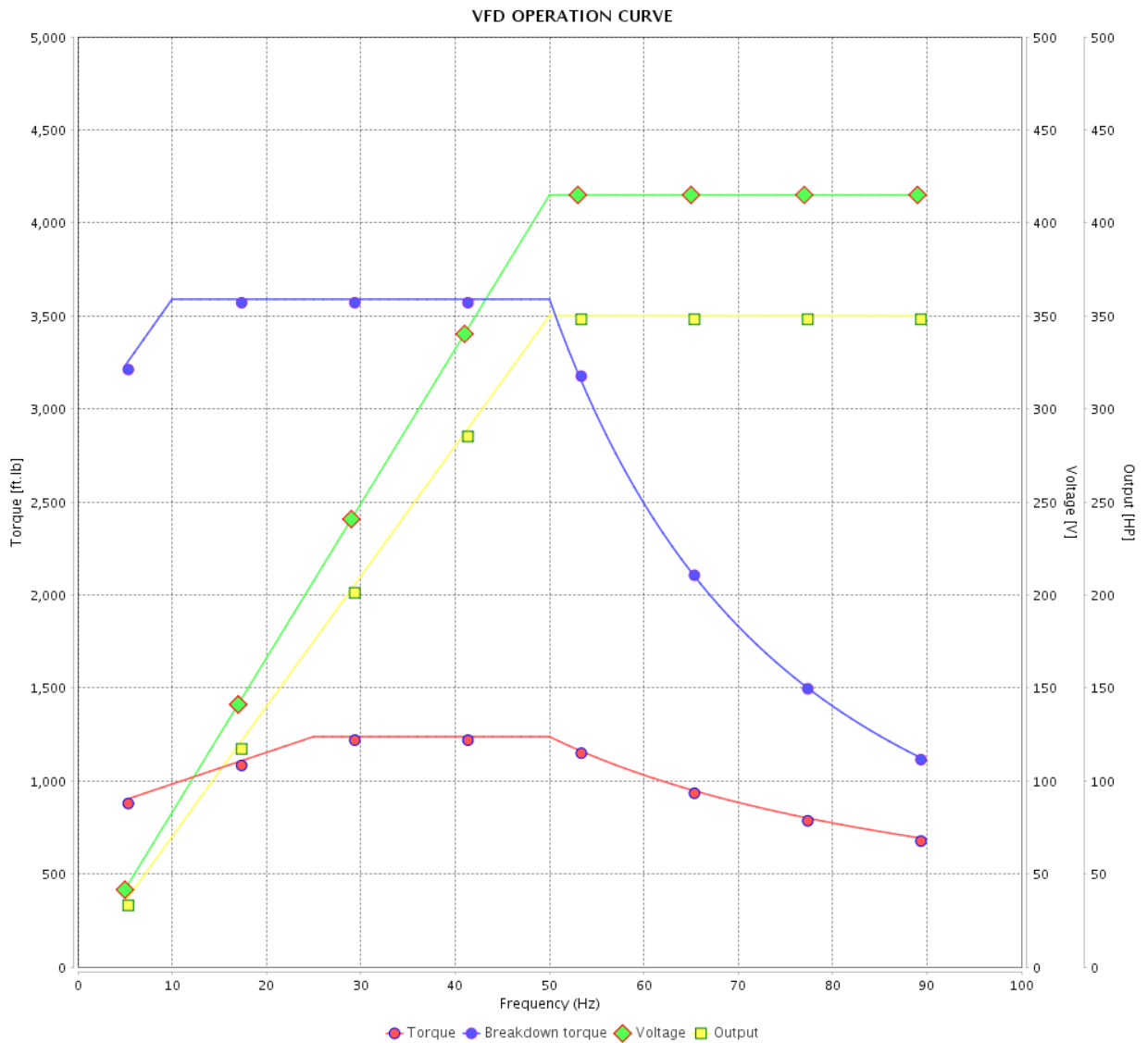

Performance : 415 V 50 Hz 4P IE3

Rated current : 437 A
 LRC : 7.2
 Rated torque : 1240 ft.lb
 Locked rotor torque : 280 %
 Breakdown torque : 290 %
 Rated speed : 1485 rpm

Moment of inertia (J) : 136 sq.ft.lb
 Duty cycle : Cont.(S1)
 Insulation class : F
 Service factor : 1.15
 Temperature rise : 80 K
 Design : B

Rev.	Changes Summary	Performed	Checked	Date
Performed by				Page 21 / 21
Checked by				
Date	13/04/2022			
				Revision

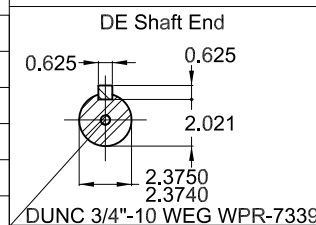
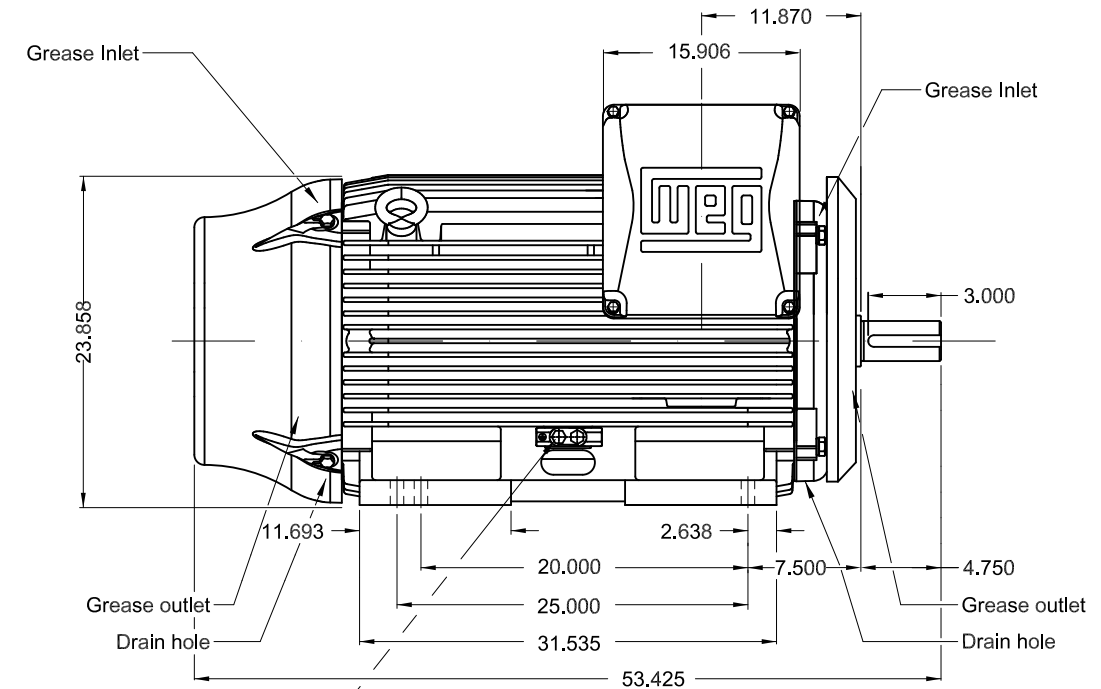
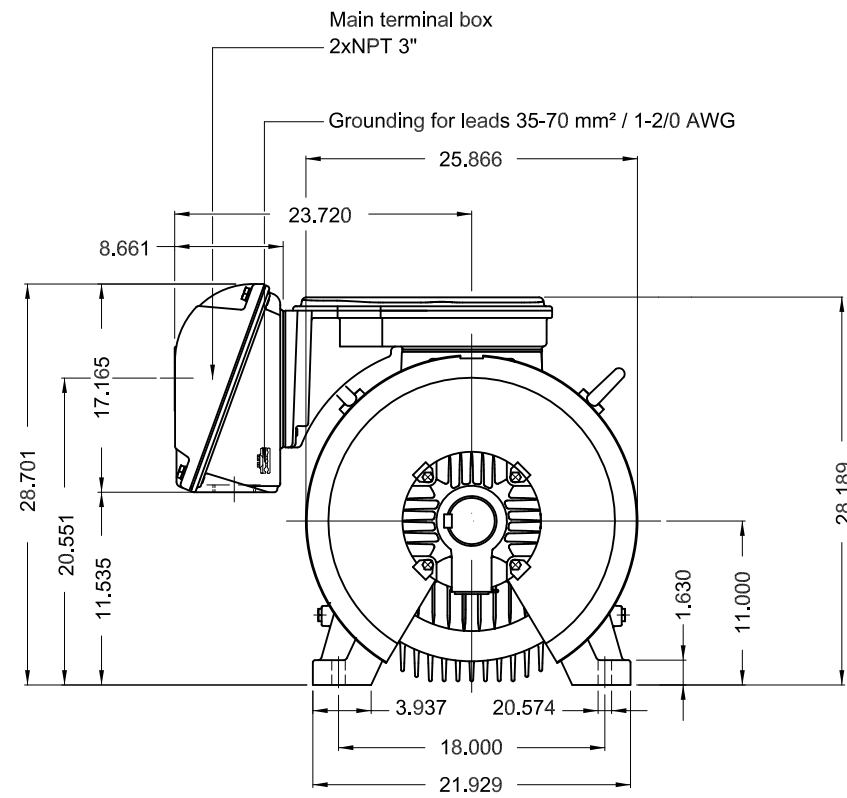

400 HP 04 Poles 60 Hz A

TS shaft end
NDE endshield with electrically insulated bearing hub
Drive-End Air Deflector
Color RAL 5009
Painting plan 203A
Mounting B3R(D)

ECM	LOC	SUMMARY OF MODIFICATIONS	EXECUTED	CHECKED	RELEASED	DATE	VER
EXECUTED	PIRWBUSER	THREE PH. MOTOR W22 PREM. EFF. FRAME L447/9TS IP55 TEFC					
CHECKED							
RELEASED							
REL DT.	WMO		Jaragua do Sul	Product Engineering	SHEET	1 / 1	

PREVIEW

WDD

Dimensions in inches XME A3

MADE IN MEXICO
12075631



FOR SAFE AREA
Mod.TE1BFOXON
CC029A



Class I, Div 2, Gr A, B, C and D - T3
Class I, Zone 2, IIC - T3
Class II, Div 2, Gr F and G - T3C
For use on PWM: Gr. A, B, C, D and F,
VT 1000:1, CT 6:1, 1.00SF - T3



MODEL 40018ET3G449TS-W22

Inverter Duty Motor
Severe Duty

PH3 60Hz Fr. L447/9TS 1000m.a.s.l. IP55 TEFC 3177lb

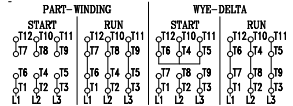
V 460	A 445	
HP 400	kW 300	
SF 1.15	SFA 512	
RPM 1785	PF 0.88	
AMB 40°C	INS cl. F DT80K	NEMA NOM EFF 96.2%
DUTY CONT.	DES B Code G	



 → 6314-C3 (27g)
 → 6314-C3 (27g)

 MOBIL POLYREX EM (12000h)

