

# DATA SHEET

## Three Phase Induction Motor - Squirrel Cage



Customer :					
Product line		: NEMA Premium Efficiency Three-Phase	Product code :	12052653	
			Catalog # :	45012ET3G586/7-W22	
Frame	: 586/7T	Cooling method	: IC411 - TEFC		
Insulation class	: F	Mounting	: F-1		
Duty cycle	: Cont.(S1)	Rotation <sup>1</sup>	: Both (CW and CCW)		
Ambient temperature	: -20°C to +40°C	Starting method	: Direct On Line		
Altitude	: 1000 m.a.s.l.	Approx. weight <sup>2</sup>	: 4663 lb		
Protection degree	: IP55	Moment of inertia (J)	: 368 sq.ft.lb		
Output [HP]	450	400	400	400	
Poles	6	6	6	6	
Frequency [Hz]	60	50	50	50	
Rated voltage [V]	460	380	400	415	
Rated current [A]	532	580	558	542	
L. R. Amperes [A]	3245	3074	3292	3415	
LRC [A]	6.1x(Code G)	5.3x(Code F)	5.9x(Code G)	6.3x(Code G)	
No load current [A]	210	208	223	235	
Rated speed [RPM]	1190	990	990	990	
Slip [%]	0.83	1.00	1.00	1.00	
Rated torque [ft.lb]	1980	2120	2120	2120	
Locked rotor torque [%]	210	180	200	220	
Breakdown torque [%]	210	190	210	229	
Service factor	1.15	1.00	1.00	1.00	
Temperature rise	80 K	105 K	105 K	105 K	
Locked rotor time	45s (cold) 25s (hot)	36s (cold) 20s (hot)	36s (cold) 20s (hot)	36s (cold) 20s (hot)	
Noise level <sup>2</sup>	77.0 dB(A)	73.0 dB(A)	73.0 dB(A)	73.0 dB(A)	
Efficiency (%)	25%	95.7	96.0	95.7	
	50%	95.8	95.8	95.8	
	75%	96.2	96.2	96.2	
	100%	96.2	95.8	96.2	
Power Factor	25%	0.43	0.45	0.39	
	50%	0.67	0.70	0.64	
	75%	0.77	0.79	0.75	
	100%	0.81	0.82	0.80	
Bearing type	: <u>Drive end</u> 6322 C3	<u>Non drive end</u> 6319 C3	Foundation loads		
Sealing	: Taconite	Taconite	Max. traction	: 7850 lb	
	Labyrinth	Labyrinth	Max. compression	: 12513 lb	
Lubrication interval	: 11000 h	13000 h			
Lubricant amount	: 60 g	45 g			
Lubricant type	: Mobil Polyrex EM				
Notes					
This revision replaces and cancel the previous one, which must be eliminated. (1) Looking the motor from the shaft end. (2) Measured at 1m and with tolerance of +3dB(A). (3) Approximate weight subject to changes after manufacturing process. (4) At 100% of full load.			These are average values based on tests with sinusoidal power supply, subject to the tolerances stipulated in NEMA MG-1.		
Rev.	Changes Summary		Performed	Checked	Date
Performed by					
Checked by				Page	Revision
Date	13/04/2022			1 / 22	

# DATA SHEET

## Three Phase Induction Motor - Squirrel Cage



Customer : \_\_\_\_\_

### Space heater information

Voltage: 200 - 240 V

Rev.	Changes Summary	Performed	Checked	Date
Performed by				
Checked by			Page	Revision
Date	13/04/2022		2 / 22	

# TORQUE AND CURRENT VS SPEED CURVE



## Three Phase Induction Motor - Squirrel Cage

Customer :

Product line : NEMA Premium Efficiency Three-Phase      Product code : 12052653  
 Catalog # : 45012ET3G586/7-W22

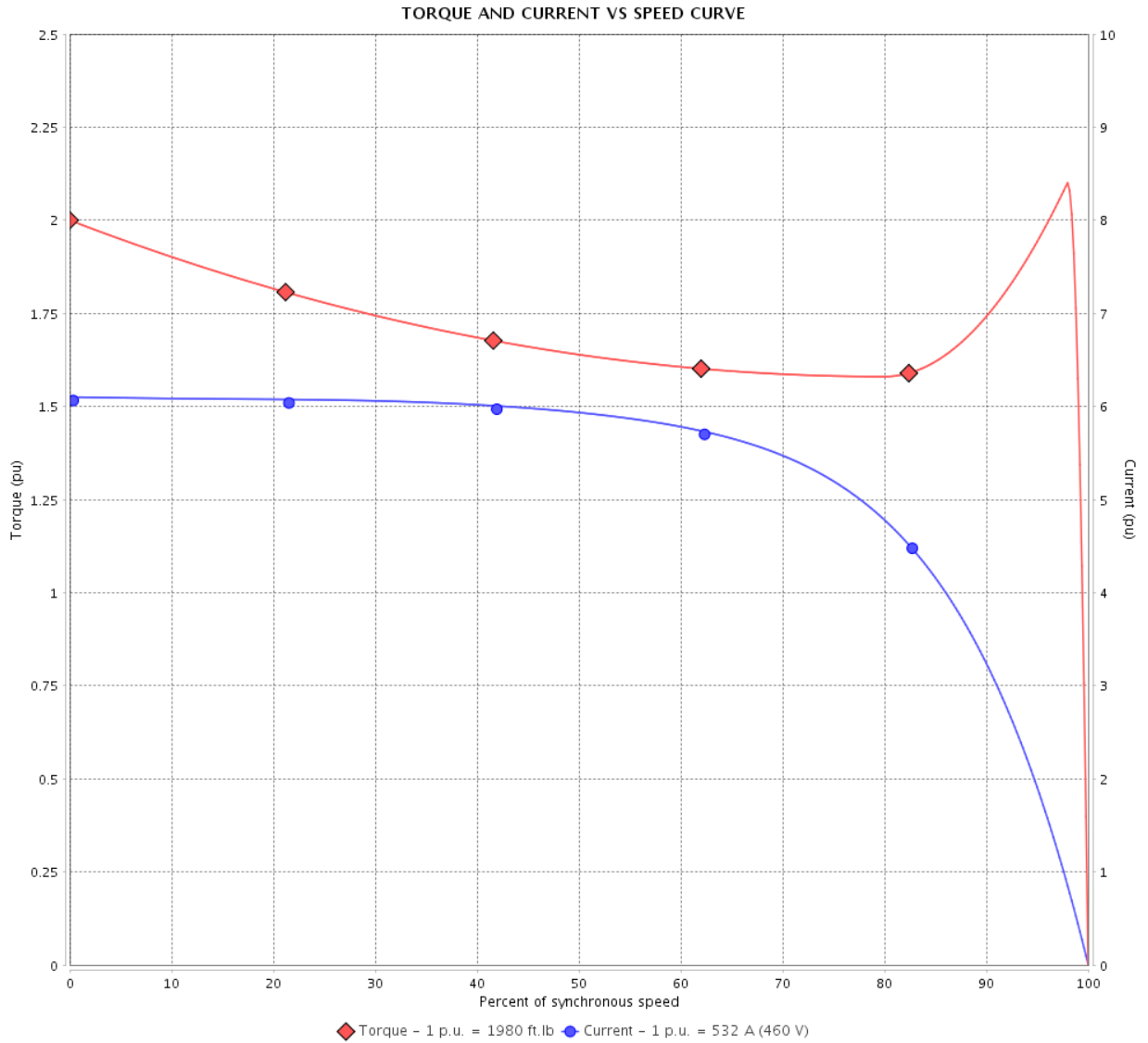

Performance : 460 V 60 Hz 6P

Rated current : 532 A	Moment of inertia (J) : 368 sq.ft.lb
LRC : 6.1	Duty cycle : Cont.(S1)
Rated torque : 1980 ft.lb	Insulation class : F
Locked rotor torque : 210 %	Service factor : 1.15
Breakdown torque : 210 %	Temperature rise : 80 K
Rated speed : 1190 rpm	

Locked rotor time : 45s (cold) 25s (hot)

Rev.	Changes Summary	Performed	Checked	Date
Performed by			Page 3 / 22	Revision
Checked by				
Date	13/04/2022			

# TORQUE AND CURRENT VS SPEED CURVE

Three Phase Induction Motor - Squirrel Cage



Customer :

Product line : NEMA Premium Efficiency Three-Phase

Product code : 12052653

Catalog # : 45012ET3G586/7-W22

TORQUE AND CURRENT VS SPEED CURVE

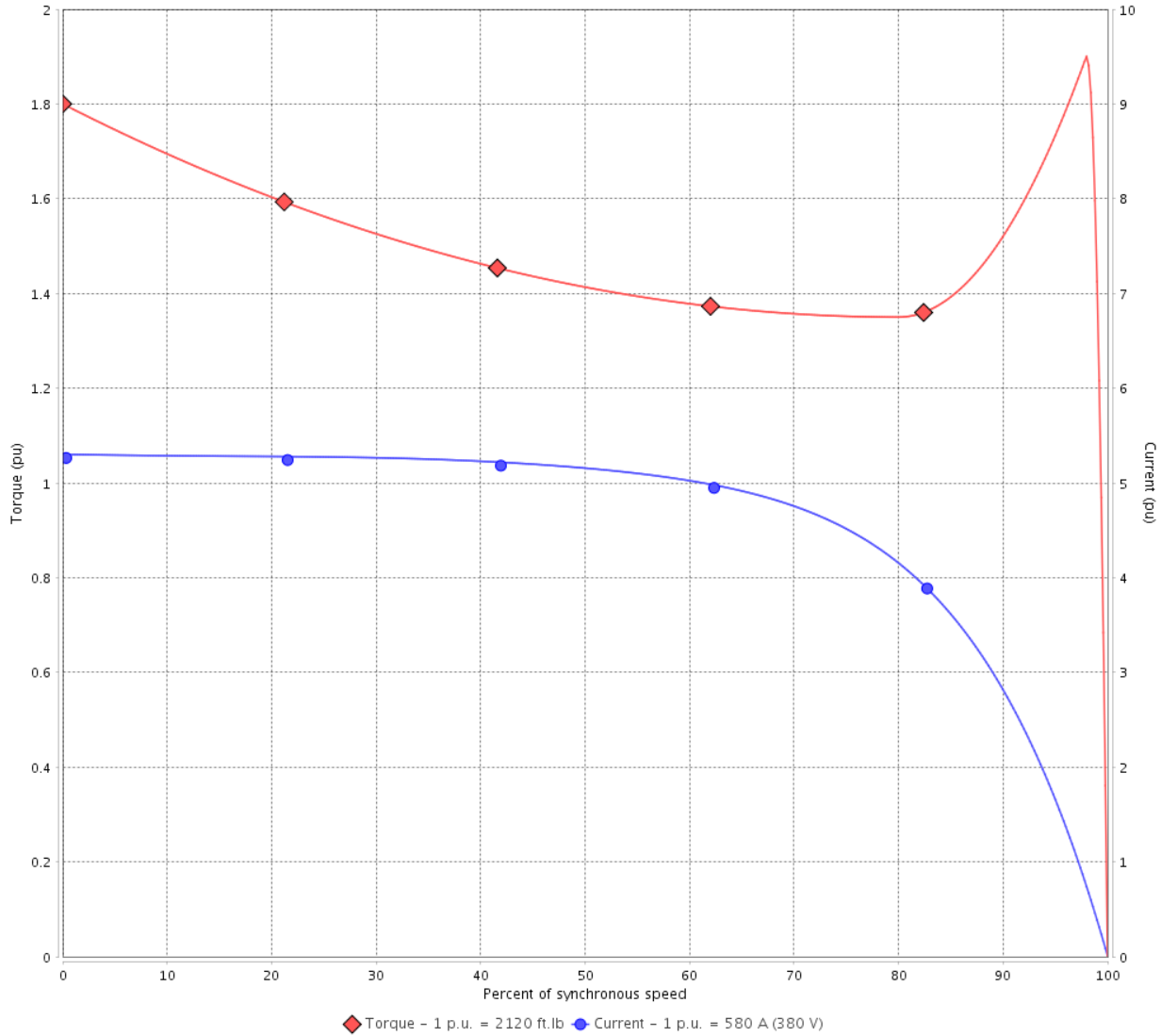

Performance : 380 V 50 Hz 6P IE3

Rated current	: 580 A	Moment of inertia (J)	: 368 sq.ft.lb
LRC	: 5.3	Duty cycle	: Cont.(S1)
Rated torque	: 2120 ft.lb	Insulation class	: F
Locked rotor torque	: 180 %	Service factor	: 1.00
Breakdown torque	: 190 %	Temperature rise	: 105 K
Rated speed	: 990 rpm		

Locked rotor time : 36s (cold) 20s (hot)

Rev.	Changes Summary	Performed	Checked	Date
Performed by			Page 4 / 22	Revision
Checked by				
Date	13/04/2022			

# TORQUE AND CURRENT VS SPEED CURVE



## Three Phase Induction Motor - Squirrel Cage

Customer :

Product line : NEMA Premium Efficiency Three-Phase

Product code : 12052653

Catalog # : 45012ET3G586/7-W22

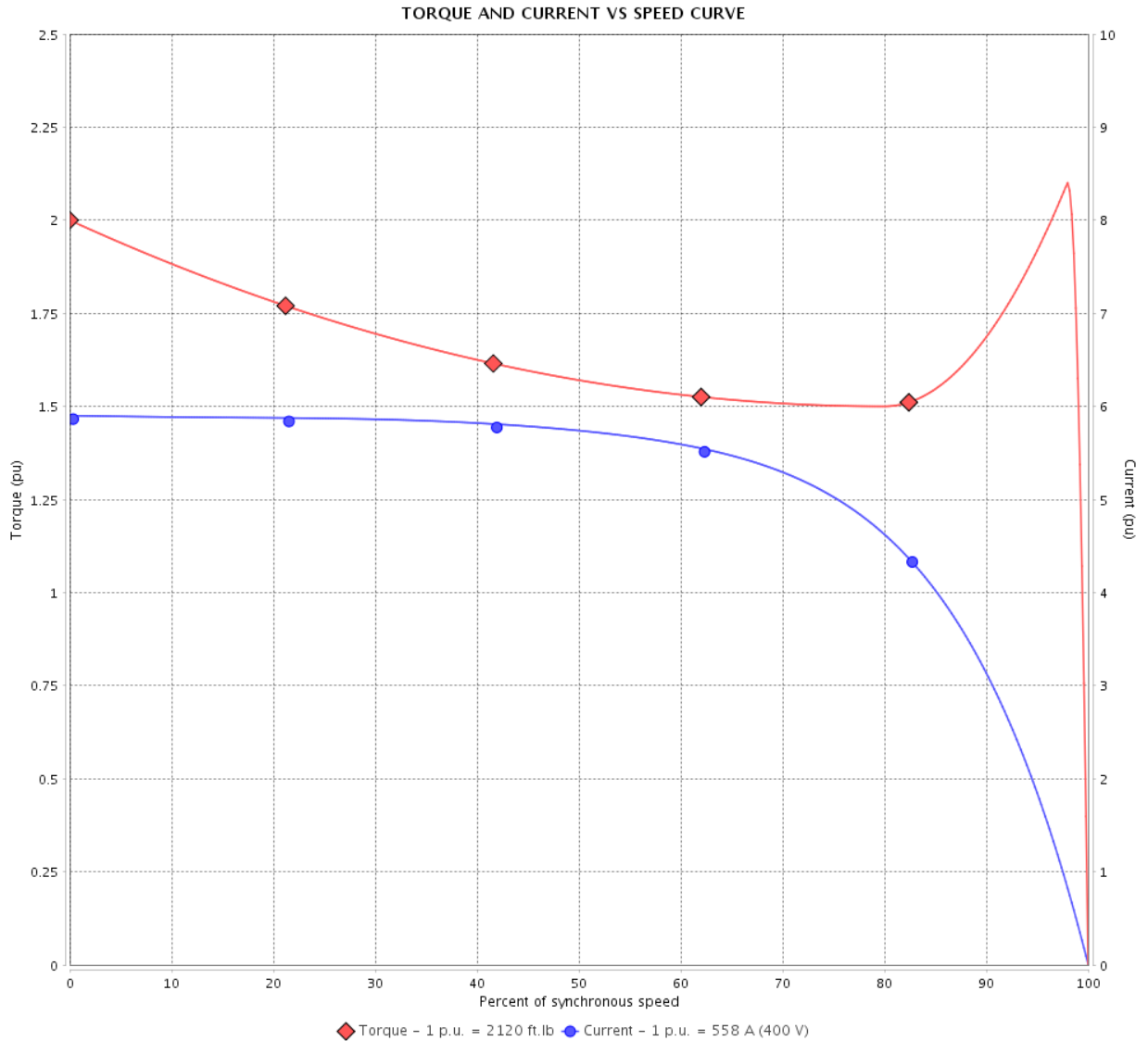

Performance : 400 V 50 Hz 6P IE3

Rated current : 558 A  
 LRC : 5.9  
 Rated torque : 2120 ft.lb  
 Locked rotor torque : 200 %  
 Breakdown torque : 210 %  
 Rated speed : 990 rpm

Moment of inertia (J) : 368 sq.ft.lb  
 Duty cycle : Cont.(S1)  
 Insulation class : F  
 Service factor : 1.00  
 Temperature rise : 105 K

Locked rotor time : 36s (cold) 20s (hot)

Rev.	Changes Summary	Performed	Checked	Date
Performed by			Page 5 / 22	Revision
Checked by				
Date	13/04/2022			

# TORQUE AND CURRENT VS SPEED CURVE

## Three Phase Induction Motor - Squirrel Cage



Customer :

Product line : NEMA Premium Efficiency Three-Phase

Product code : 12052653

Catalog # : 45012ET3G586/7-W22

TORQUE AND CURRENT VS SPEED CURVE

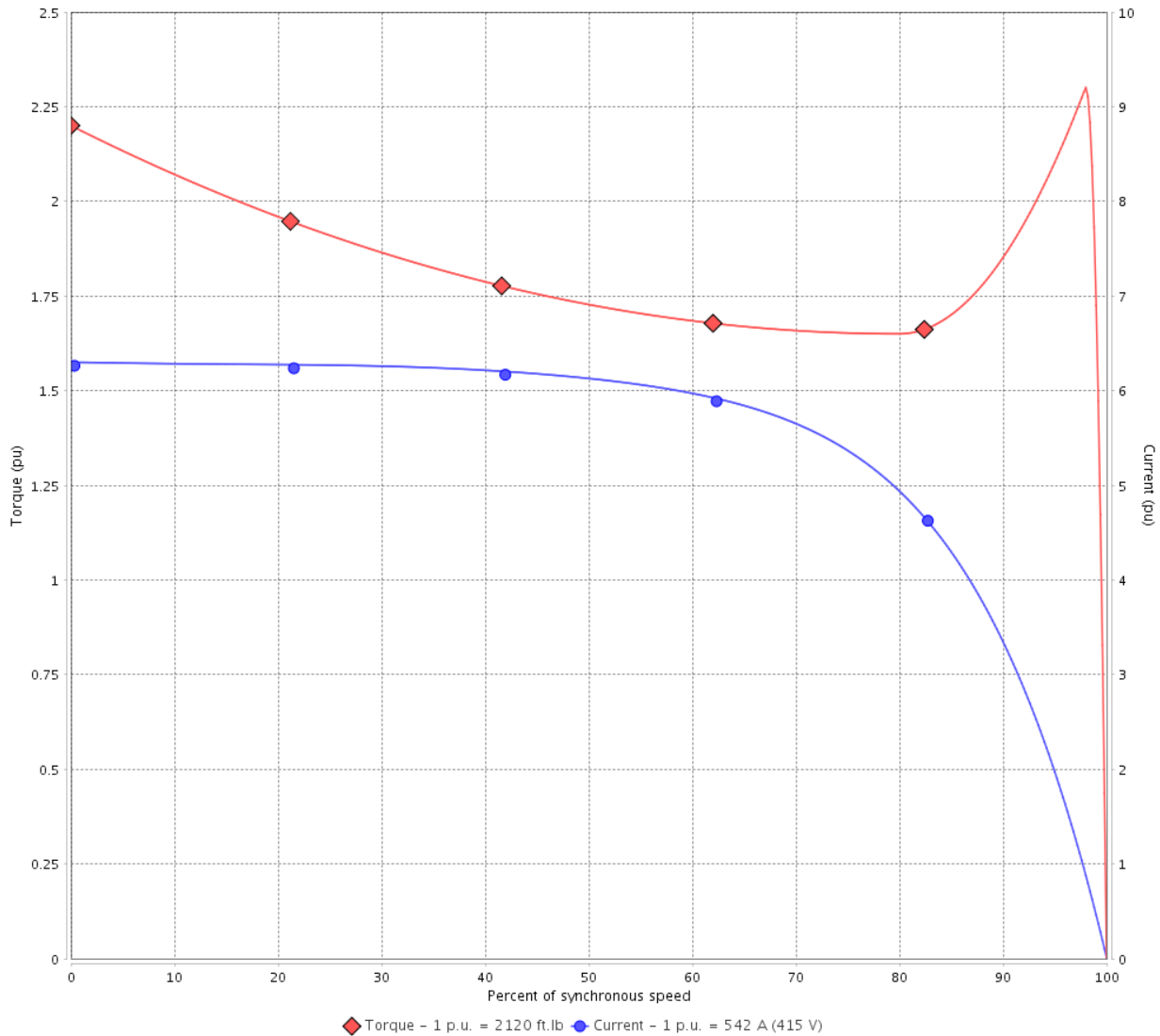

Performance : 415 V 50 Hz 6P IE3

Rated current	: 542 A	Moment of inertia (J)	: 368 sq.ft.lb
LRC	: 6.3	Duty cycle	: Cont.(S1)
Rated torque	: 2120 ft.lb	Insulation class	: F
Locked rotor torque	: 220 %	Service factor	: 1.00
Breakdown torque	: 229 %	Temperature rise	: 105 K
Rated speed	: 990 rpm		

Locked rotor time : 36s (cold) 20s (hot)

Rev.	Changes Summary	Performed	Checked	Date
Performed by			Page 6 / 22	Revision
Checked by				
Date	13/04/2022			

# LOAD PERFORMANCE CURVE

## Three Phase Induction Motor - Squirrel Cage



Customer :

Product line : NEMA Premium Efficiency Three-Phase

Product code : 12052653

Catalog # : 45012ET3G586/7-W22

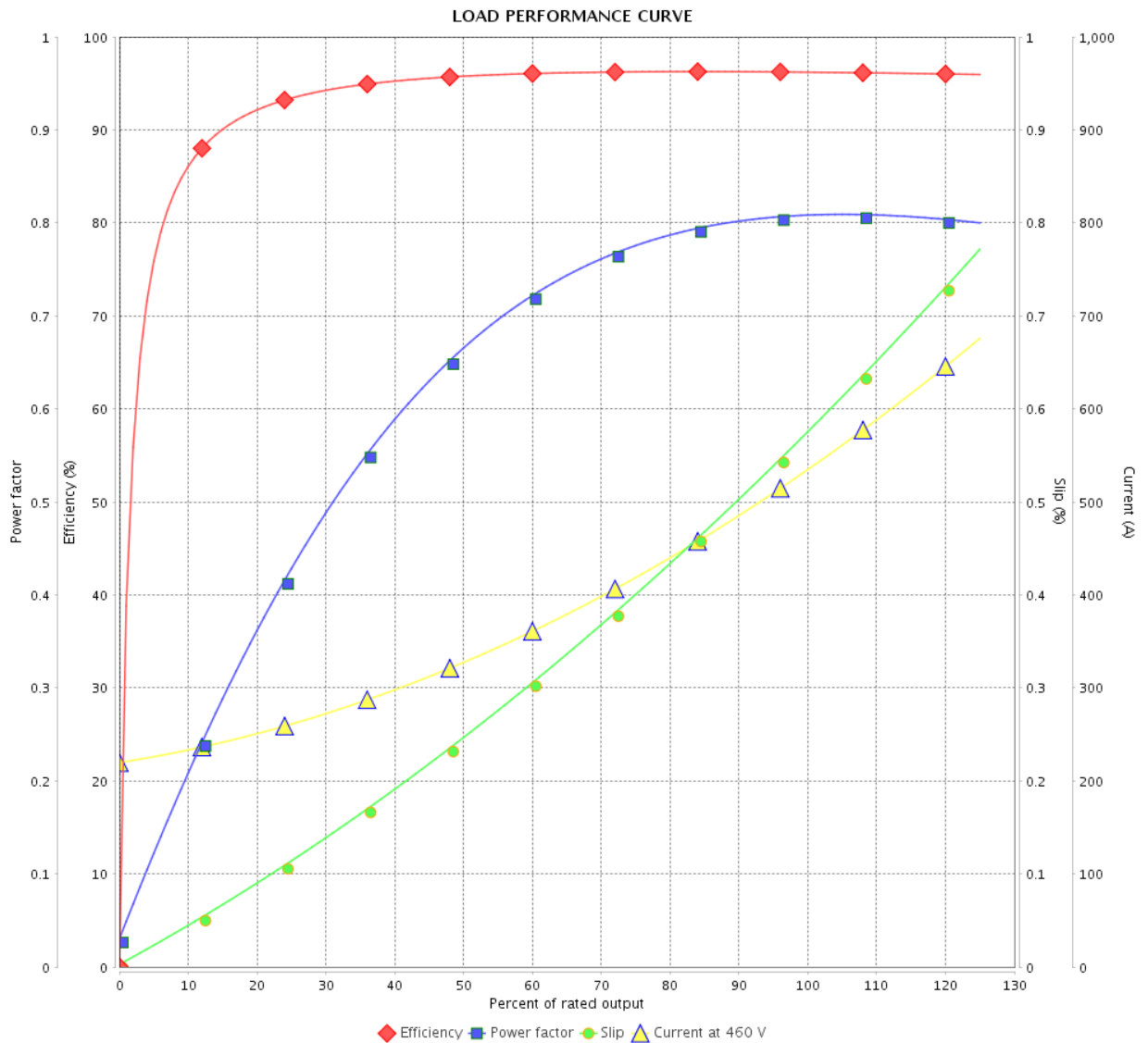

Performance : 460 V 60 Hz 6P

Rated current : 532 A  
 LRC : 6.1  
 Rated torque : 1980 ft.lb  
 Locked rotor torque : 210 %  
 Breakdown torque : 210 %  
 Rated speed : 1190 rpm

Moment of inertia (J) : 368 sq.ft.lb  
 Duty cycle : Cont.(S1)  
 Insulation class : F  
 Service factor : 1.15  
 Temperature rise : 80 K

Rev.	Changes Summary	Performed	Checked	Date
Performed by		Page		Revision
Checked by		7 / 22		
Date		13/04/2022		

# LOAD PERFORMANCE CURVE

Three Phase Induction Motor - Squirrel Cage



Customer :

Product line : NEMA Premium Efficiency Three-Phase

Product code : 12052653

Catalog # : 45012ET3G586/7-W22

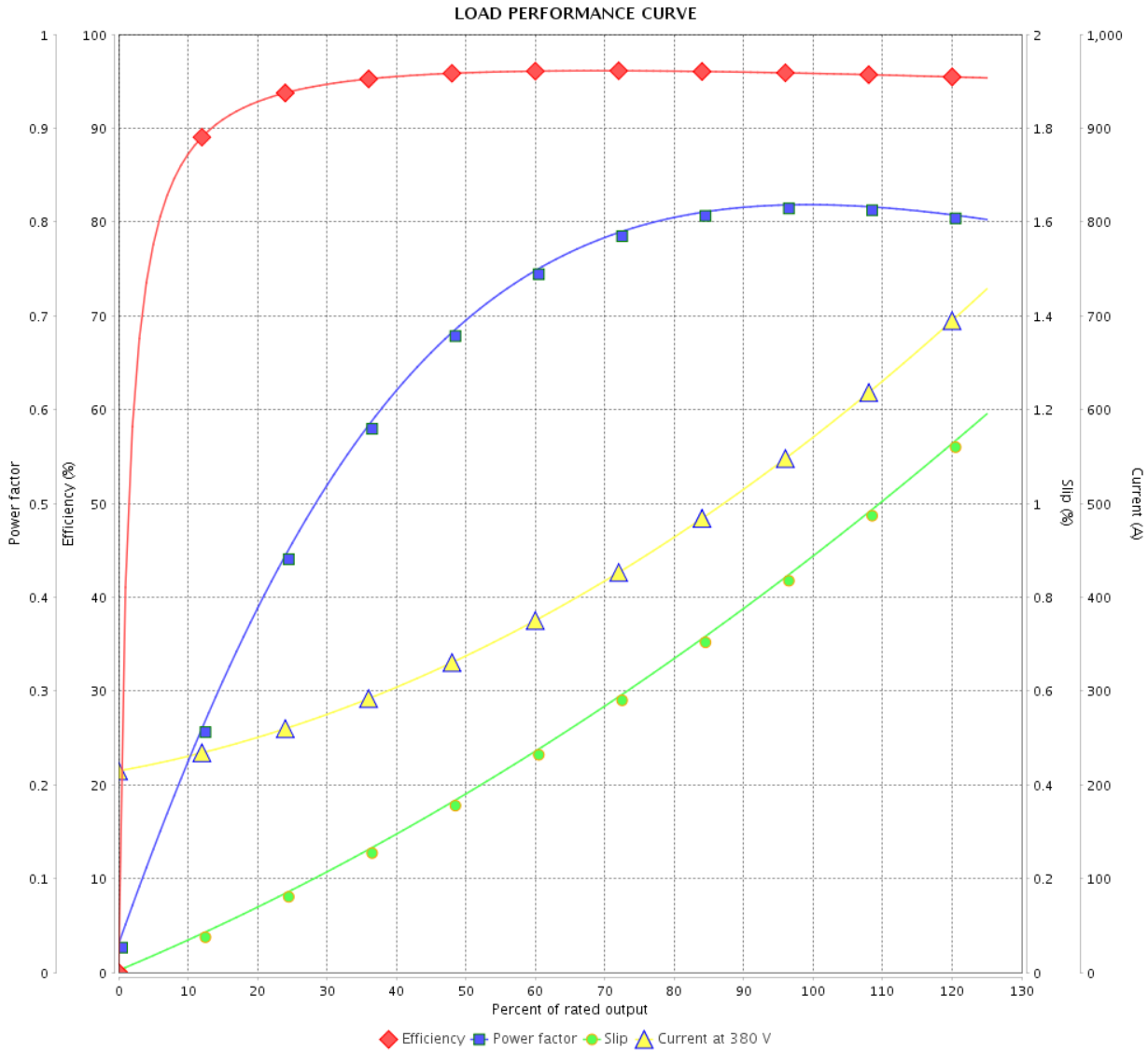

Performance : 380 V 50 Hz 6P IE3

Rated current : 580 A  
 LRC : 5.3  
 Rated torque : 2120 ft.lb  
 Locked rotor torque : 180 %  
 Breakdown torque : 190 %  
 Rated speed : 990 rpm

Moment of inertia (J) : 368 sq.ft.lb  
 Duty cycle : Cont.(S1)  
 Insulation class : F  
 Service factor : 1.00  
 Temperature rise : 105 K

Rev.	Changes Summary	Performed	Checked	Date
Performed by			Page 8 / 22	Revision
Checked by				
Date	13/04/2022			



# LOAD PERFORMANCE CURVE

## Three Phase Induction Motor - Squirrel Cage



Customer :

Product line : NEMA Premium Efficiency Three-Phase

Product code : 12052653

Catalog # : 45012ET3G586/7-W22

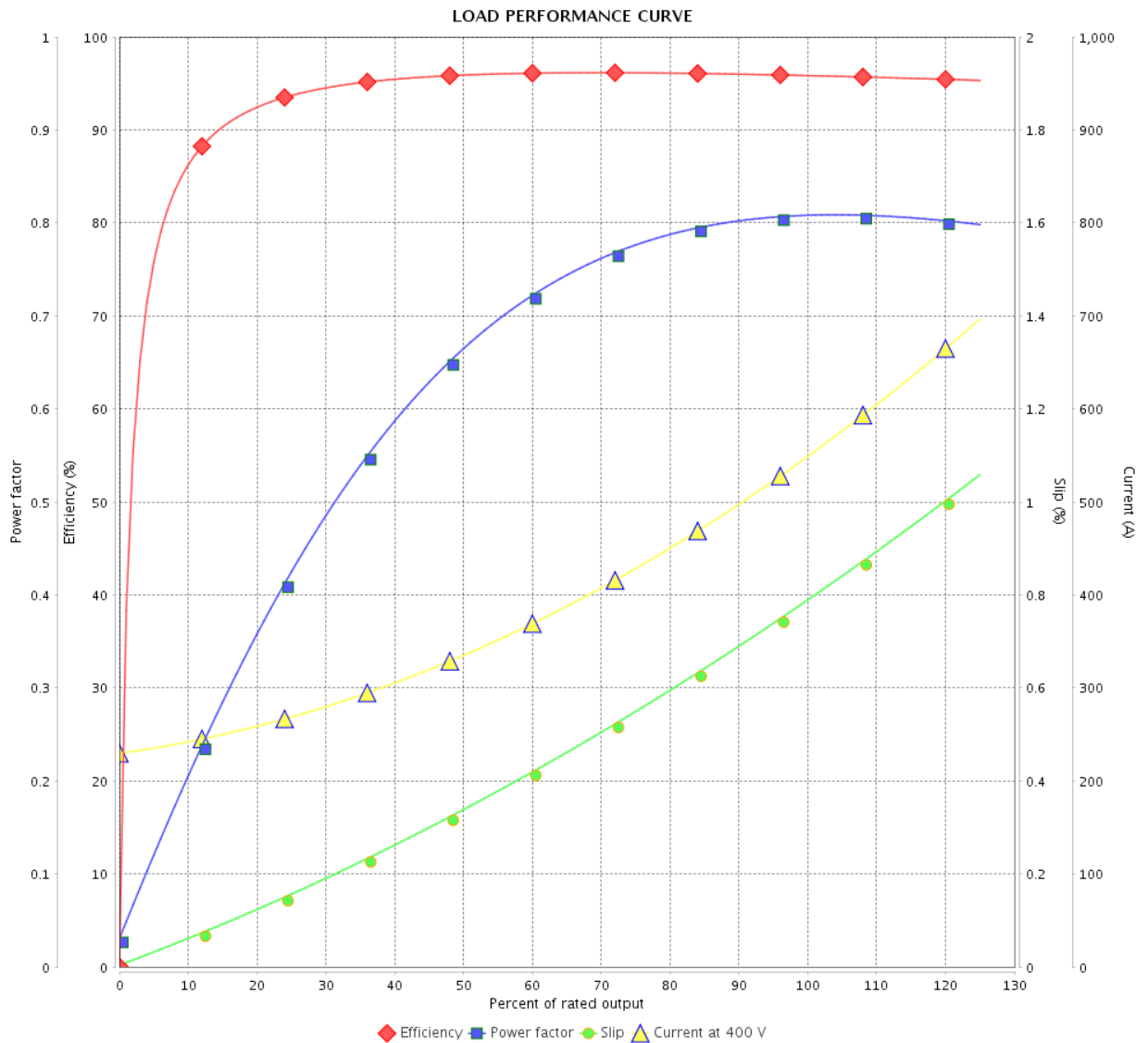

Performance : 400 V 50 Hz 6P IE3

Rated current : 558 A  
 LRC : 5.9  
 Rated torque : 2120 ft.lb  
 Locked rotor torque : 200 %  
 Breakdown torque : 210 %  
 Rated speed : 990 rpm

Moment of inertia (J) : 368 sq.ft.lb  
 Duty cycle : Cont.(S1)  
 Insulation class : F  
 Service factor : 1.00  
 Temperature rise : 105 K

Rev.	Changes Summary	Performed	Checked	Date
Performed by			Page	Revision
Checked by			9 / 22	
Date	13/04/2022			

# LOAD PERFORMANCE CURVE

Three Phase Induction Motor - Squirrel Cage



Customer : \_\_\_\_\_

Product line : NEMA Premium Efficiency Three-Phase

Product code : 12052653

Catalog # : 45012ET3G586/7-W22

LOAD PERFORMANCE CURVE

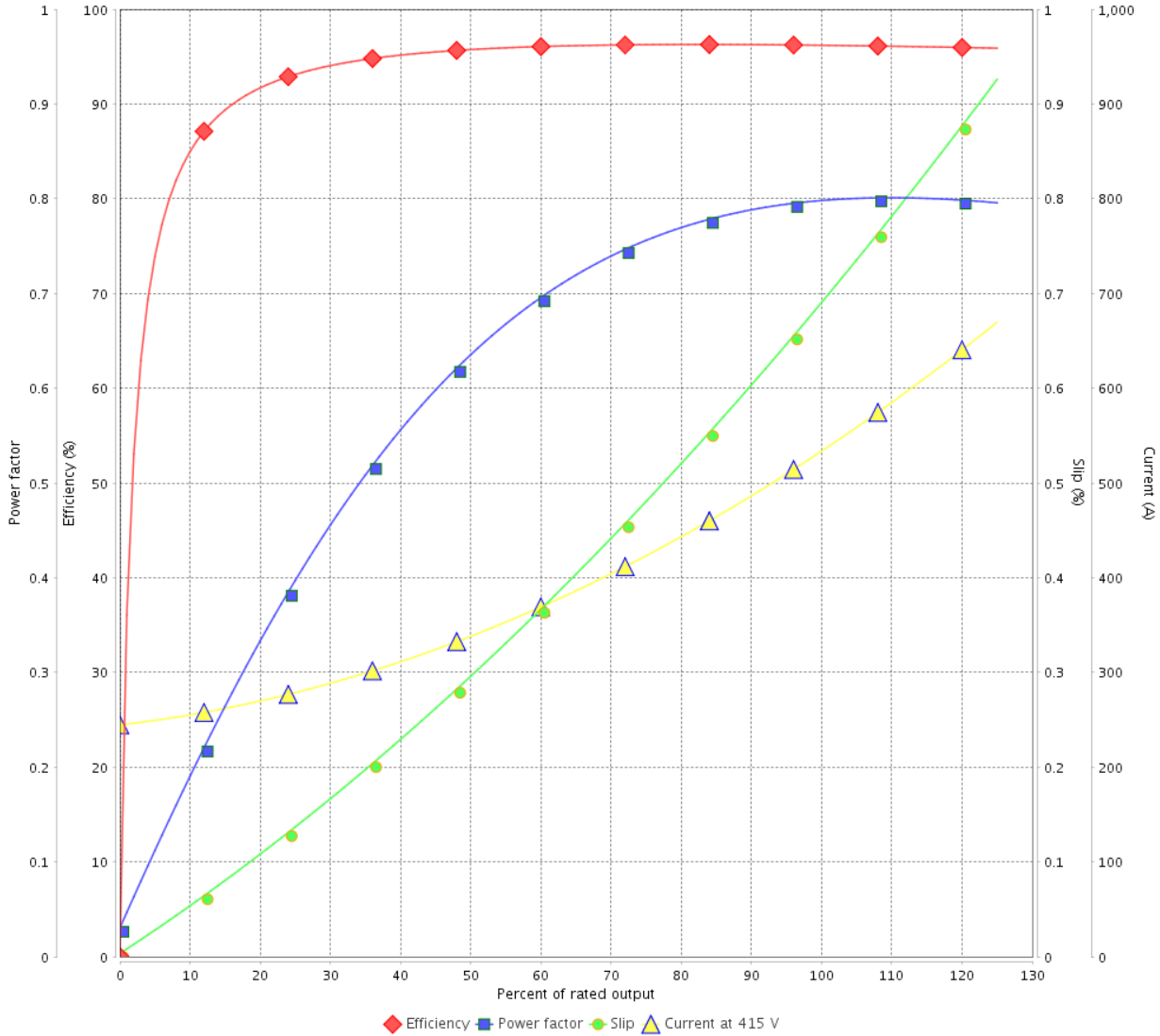

Performance : 415 V 50 Hz 6P IE3

Rated current : 542 A  
 LRC : 6.3  
 Rated torque : 2120 ft.lb  
 Locked rotor torque : 220 %  
 Breakdown torque : 229 %  
 Rated speed : 990 rpm

Moment of inertia (J) : 368 sq.ft.lb  
 Duty cycle : Cont.(S1)  
 Insulation class : F  
 Service factor : 1.00  
 Temperature rise : 105 K

Rev.	Changes Summary	Performed	Checked	Date
Performed by			Page 10 / 22	Revision
Checked by				
Date	13/04/2022			

# THERMAL LIMIT CURVE



## Three Phase Induction Motor - Squirrel Cage

Customer :

Product line : NEMA Premium Efficiency Three-Phase  
 Product code : 12052653  
 Catalog # : 45012ET3G586/7-W22

Performance : 460 V 60 Hz 6P

Rated current : 532 A	Moment of inertia (J) : 368 sq.ft.lb
LRC : 6.1	Duty cycle : Cont.(S1)
Rated torque : 1980 ft.lb	Insulation class : F
Locked rotor torque : 210 %	Service factor : 1.15
Breakdown torque : 210 %	Temperature rise : 80 K
Rated speed : 1190 rpm	

Heating constant

Cooling constant

Rev.	Changes Summary	Performed	Checked	Date
Performed by				
Checked by			Page	Revision
Date	13/04/2022		11 / 22	

# THERMAL LIMIT CURVE

Three Phase Induction Motor - Squirrel Cage



Customer : \_\_\_\_\_

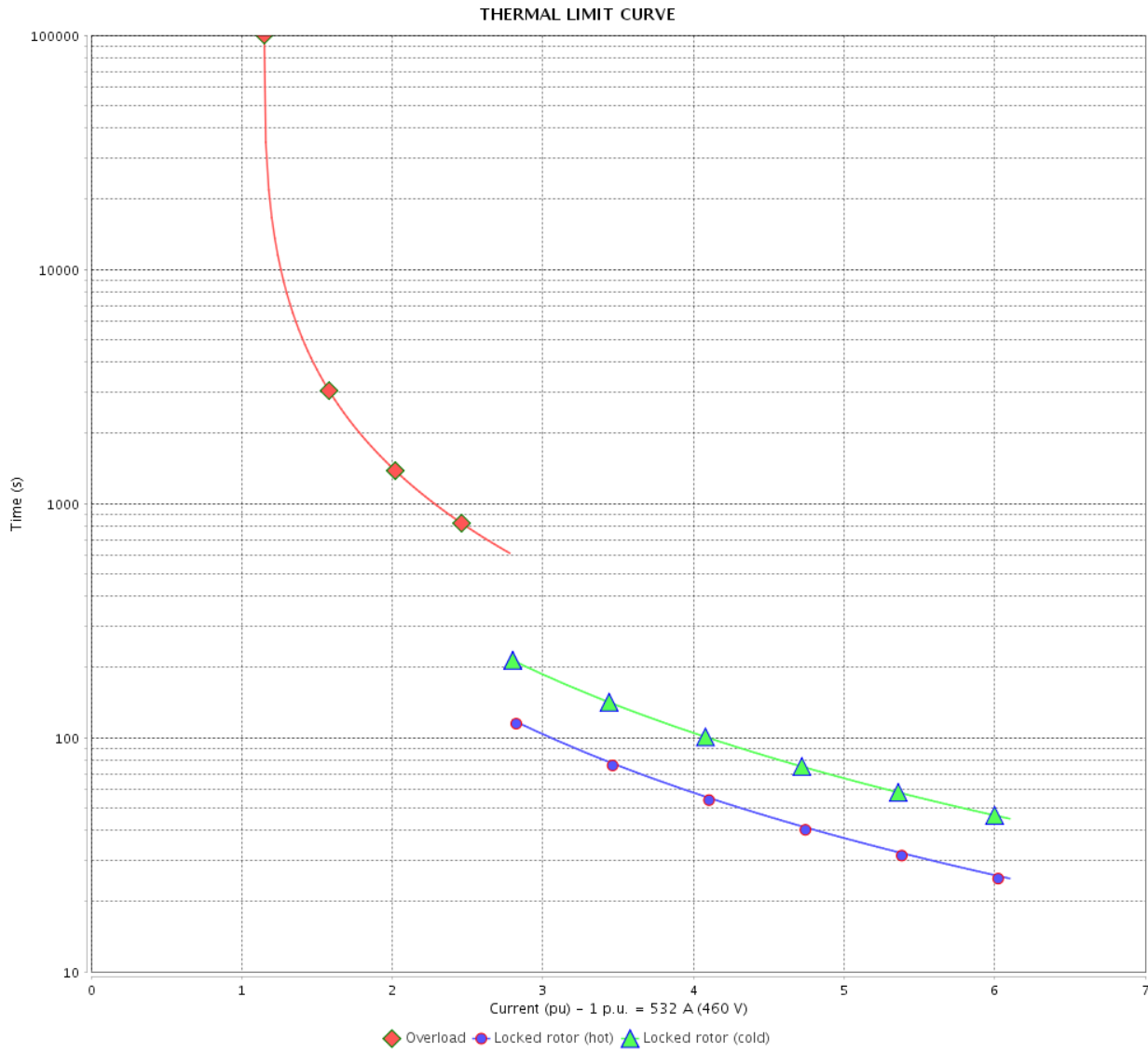

Rev.	Changes Summary	Performed	Checked	Date
Performed by		Page		Revision
Checked by		12 / 22		
Date		13/04/2022		

# THERMAL LIMIT CURVE



## Three Phase Induction Motor - Squirrel Cage

Customer :

Product line : NEMA Premium Efficiency Three-Phase  
 Product code : 12052653  
 Catalog # : 45012ET3G586/7-W22

Performance : 380 V 50 Hz 6P IE3

Rated current : 580 A	Moment of inertia (J) : 368 sq.ft.lb
LRC : 5.3	Duty cycle : Cont.(S1)
Rated torque : 2120 ft.lb	Insulation class : F
Locked rotor torque : 180 %	Service factor : 1.00
Breakdown torque : 190 %	Temperature rise : 105 K
Rated speed : 990 rpm	

Heating constant

Cooling constant

Rev.	Changes Summary	Performed	Checked	Date
Performed by				
Checked by			Page	Revision
Date	13/04/2022		13 / 22	

# THERMAL LIMIT CURVE

Three Phase Induction Motor - Squirrel Cage



Customer : \_\_\_\_\_

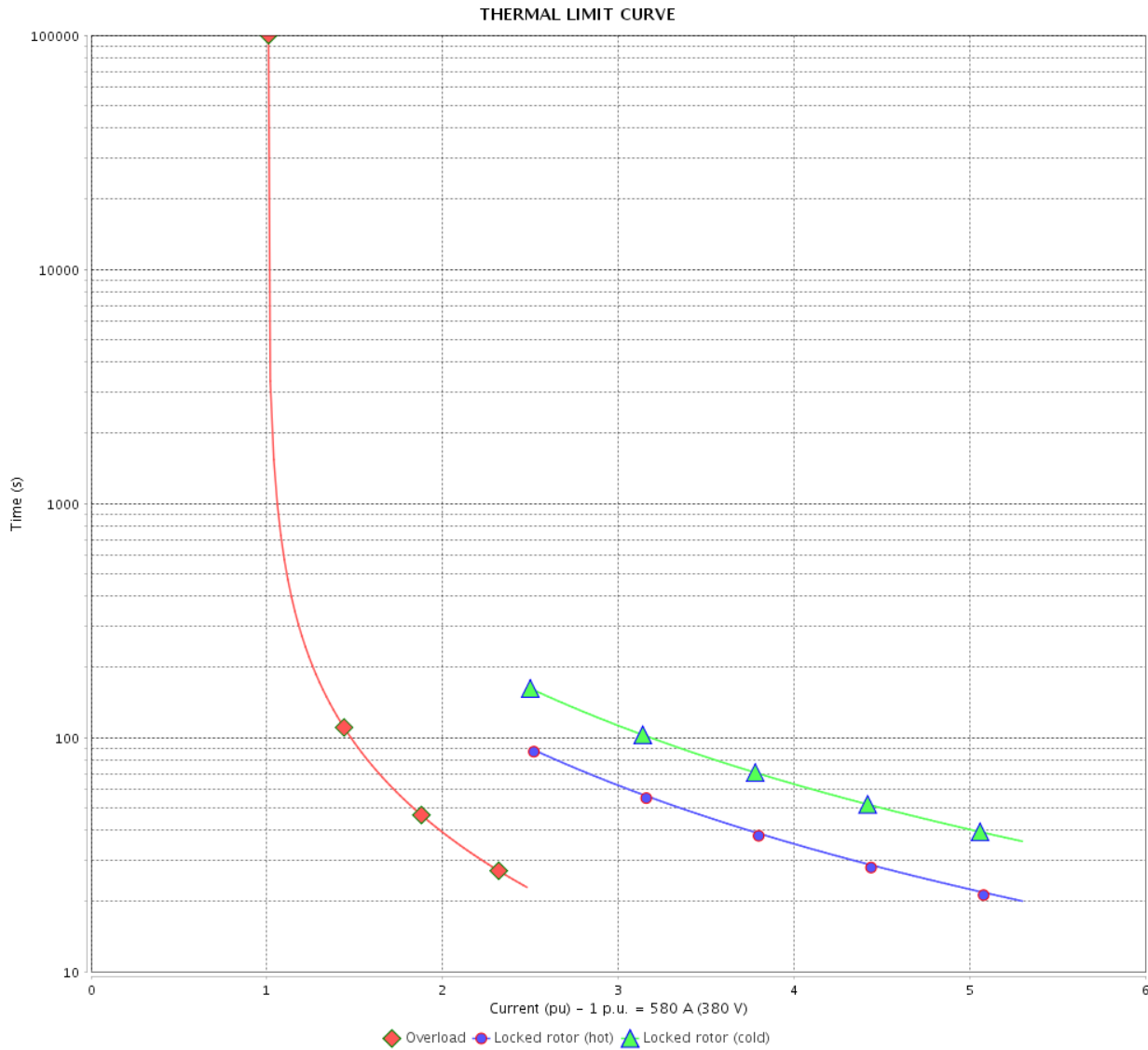

Rev.	Changes Summary	Performed	Checked	Date
Performed by		Page		Revision
Checked by		14 / 22		
Date		13/04/2022		

# THERMAL LIMIT CURVE

## Three Phase Induction Motor - Squirrel Cage



Customer :

Product line : NEMA Premium Efficiency Three-Phase  
Product code : 12052653  
Catalog # : 45012ET3G586/7-W22

Performance : 400 V 50 Hz 6P IE3

Rated current : 558 A	Moment of inertia (J) : 368 sq.ft.lb
LRC : 5.9	Duty cycle : Cont.(S1)
Rated torque : 2120 ft.lb	Insulation class : F
Locked rotor torque : 200 %	Service factor : 1.00
Breakdown torque : 210 %	Temperature rise : 105 K
Rated speed : 990 rpm	

Heating constant

Cooling constant

Rev.	Changes Summary	Performed	Checked	Date
Performed by				
Checked by			Page	Revision
Date	13/04/2022		15 / 22	

# THERMAL LIMIT CURVE

Three Phase Induction Motor - Squirrel Cage



Customer : \_\_\_\_\_

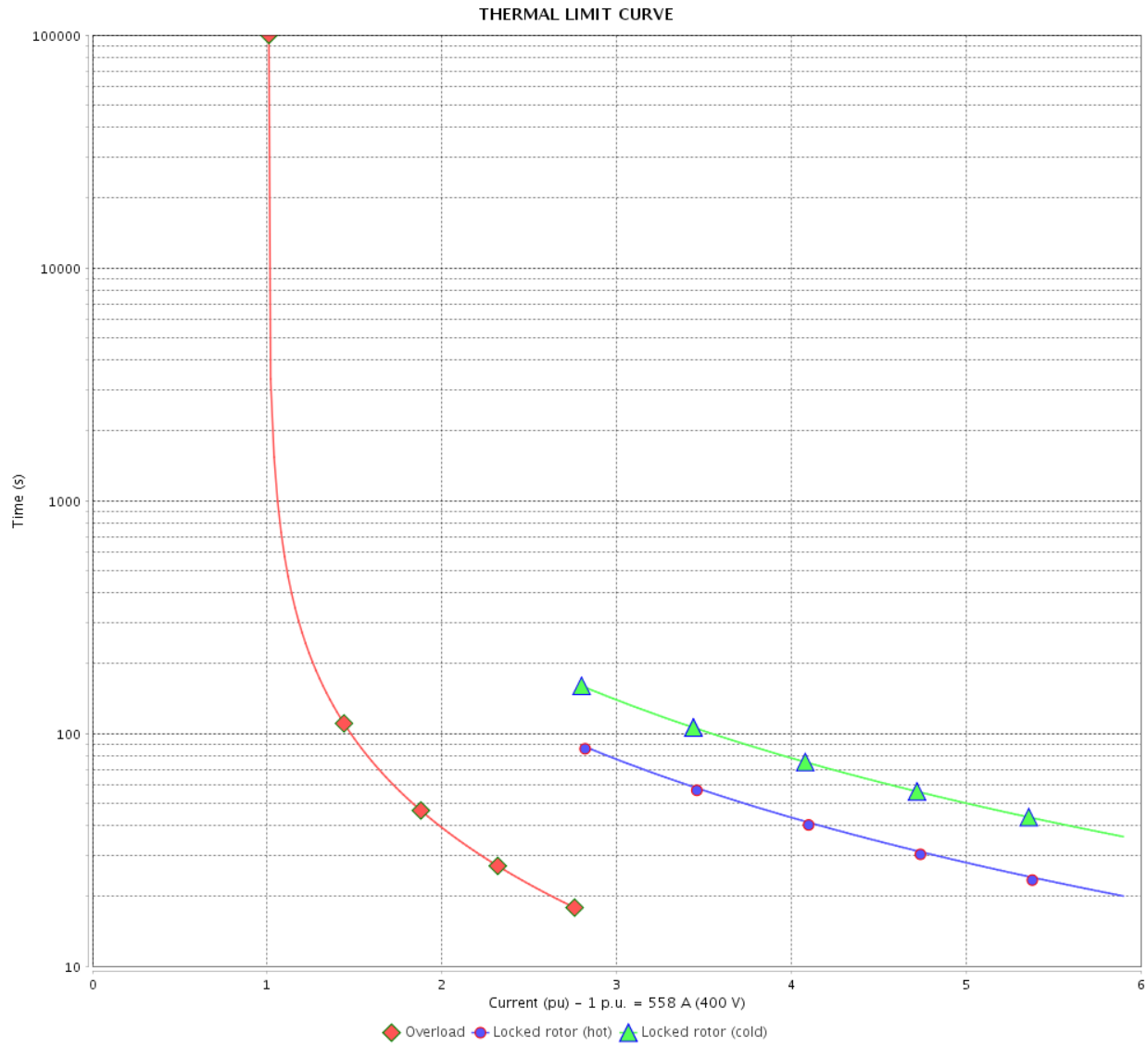

Rev.	Changes Summary	Performed	Checked	Date
Performed by		Page 16 / 22		Revision
Checked by				
Date				



# THERMAL LIMIT CURVE

## Three Phase Induction Motor - Squirrel Cage



Customer :

Product line : NEMA Premium Efficiency Three-Phase  
 Product code : 12052653  
 Catalog # : 45012ET3G586/7-W22

Performance : 415 V 50 Hz 6P IE3

Rated current : 542 A	Moment of inertia (J) : 368 sq.ft.lb
LRC : 6.3	Duty cycle : Cont.(S1)
Rated torque : 2120 ft.lb	Insulation class : F
Locked rotor torque : 220 %	Service factor : 1.00
Breakdown torque : 229 %	Temperature rise : 105 K
Rated speed : 990 rpm	

Heating constant

Cooling constant

Rev.	Changes Summary	Performed	Checked	Date
Performed by				
Checked by			Page	Revision
Date	13/04/2022		17 / 22	

# THERMAL LIMIT CURVE

Three Phase Induction Motor - Squirrel Cage



Customer : \_\_\_\_\_

THERMAL LIMIT CURVE

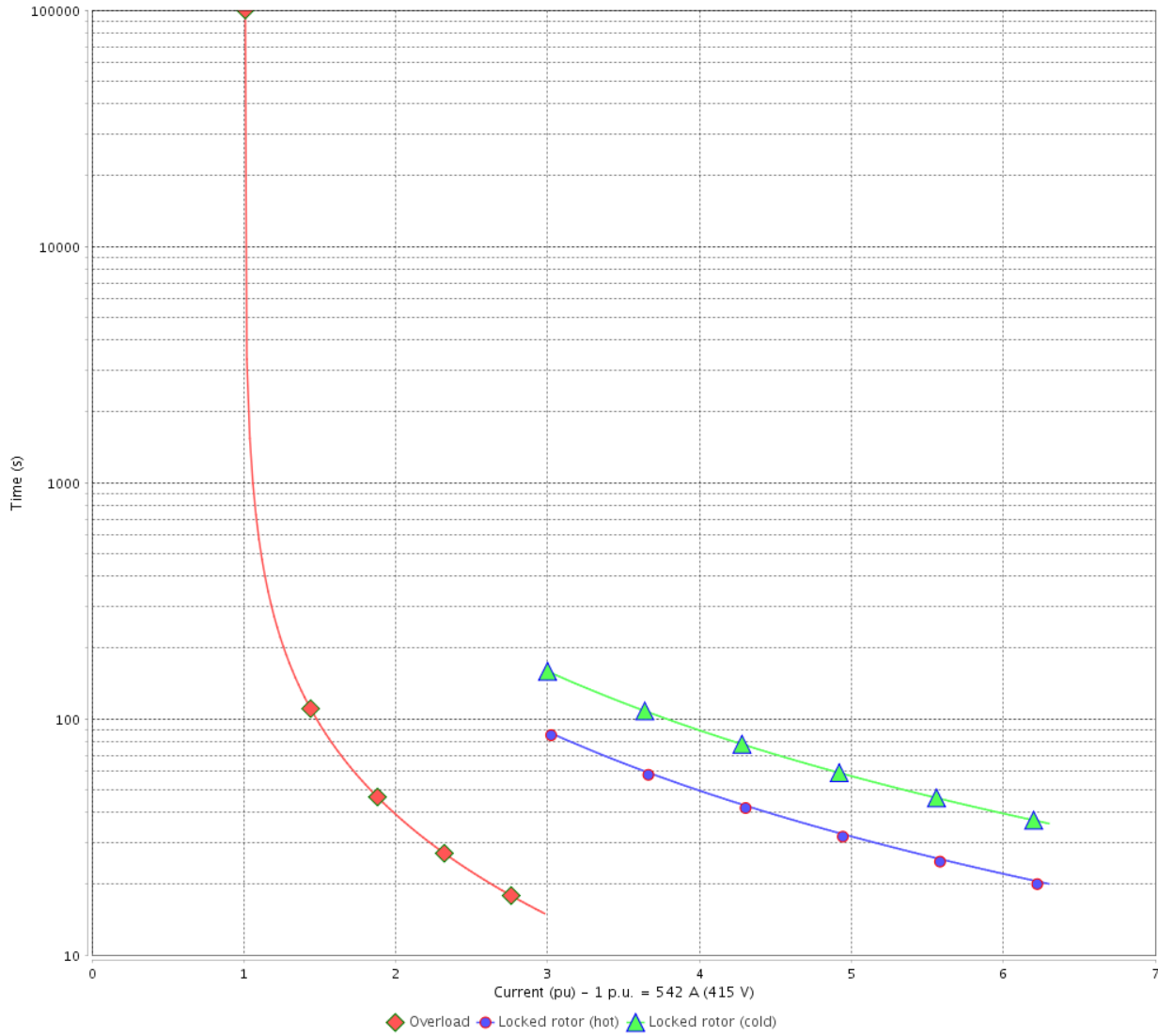

Rev.	Changes Summary	Performed	Checked	Date
Performed by			Page	Revision
Checked by				
Date				

# VFD OPERATION CURVE

## Three Phase Induction Motor - Squirrel Cage



Customer :

Product line : NEMA Premium Efficiency Three-Phase

Product code : 12052653

Catalog # : 45012ET3G586/7-W22

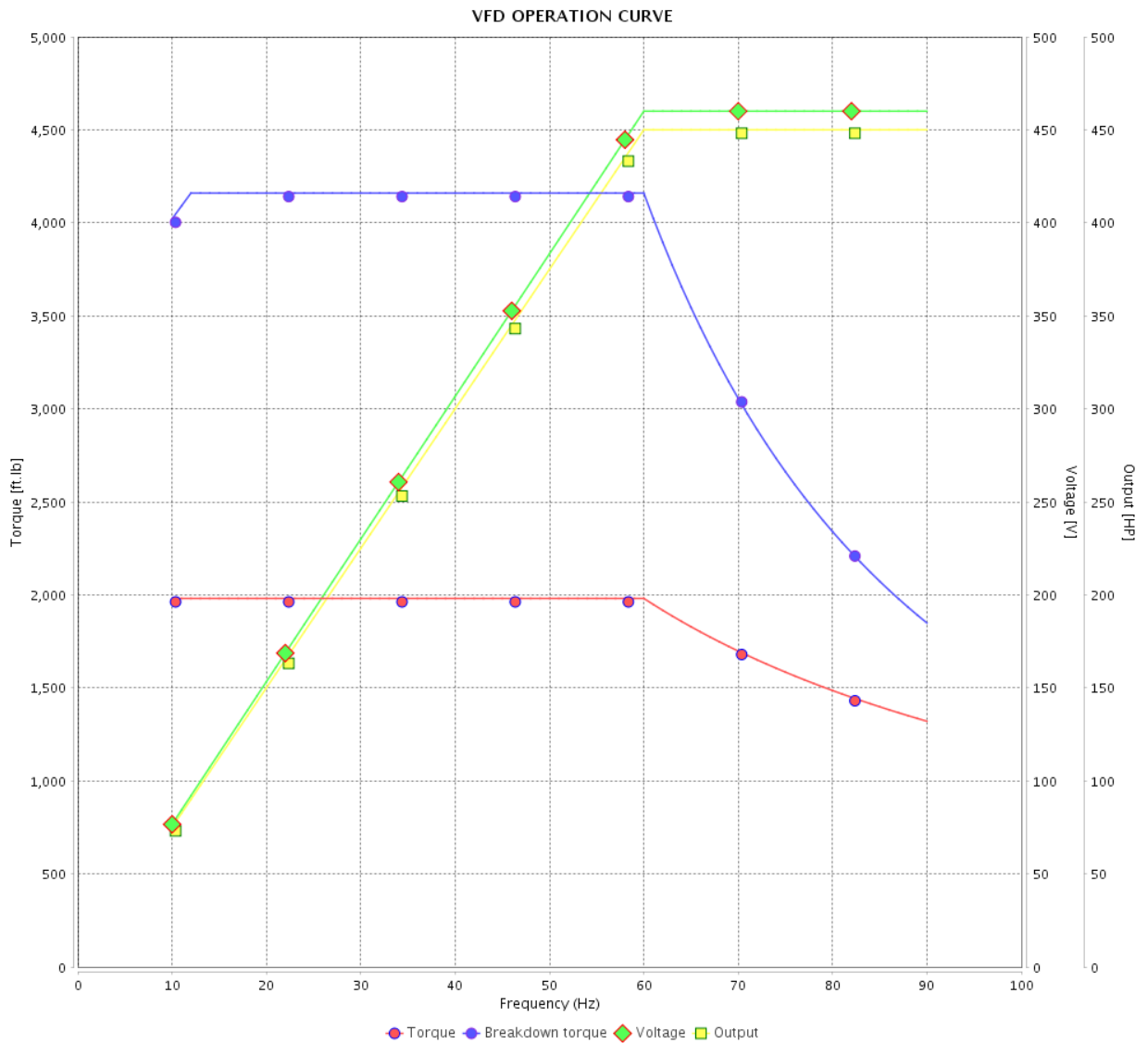

Performance : 460 V 60 Hz 6P

Rated current : 532 A  
 LRC : 6.1  
 Rated torque : 1980 ft.lb  
 Locked rotor torque : 210 %  
 Breakdown torque : 210 %  
 Rated speed : 1190 rpm

Moment of inertia (J) : 368 sq.ft.lb  
 Duty cycle : Cont.(S1)  
 Insulation class : F  
 Service factor : 1.15  
 Temperature rise : 80 K

Rev.	Changes Summary	Performed	Checked	Date
Performed by				Page 19 / 22
Checked by				
Date	13/04/2022			
				Revision

# VFD OPERATION CURVE

Three Phase Induction Motor - Squirrel Cage



Customer :

Product line : NEMA Premium Efficiency Three-Phase

Product code : 12052653

Catalog # : 45012ET3G586/7-W22

VFD OPERATION CURVE

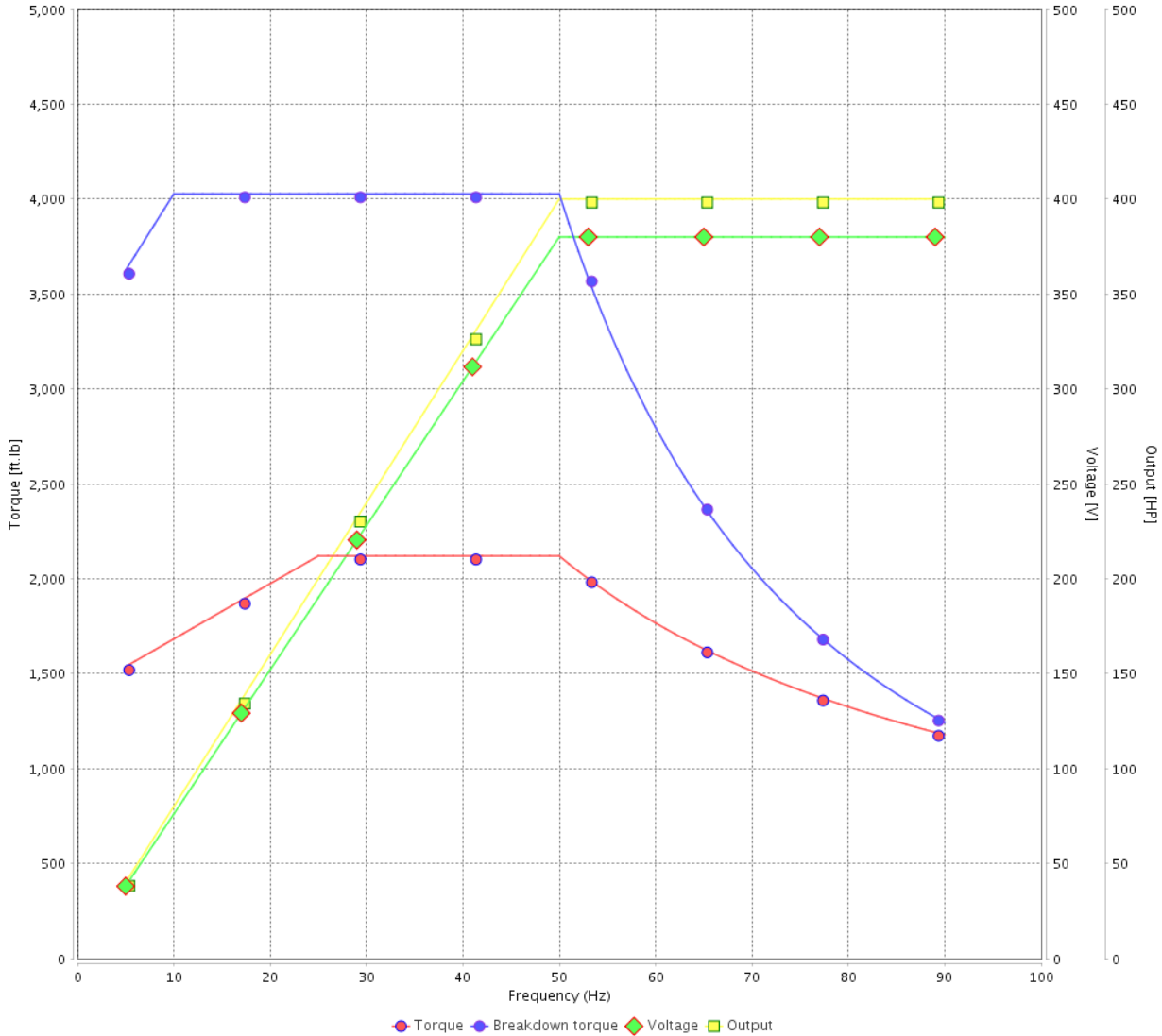

Performance : 380 V 50 Hz 6P IE3

Rated current : 580 A  
 LRC : 5.3  
 Rated torque : 2120 ft.lb  
 Locked rotor torque : 180 %  
 Breakdown torque : 190 %  
 Rated speed : 990 rpm

Moment of inertia (J) : 368 sq.ft.lb  
 Duty cycle : Cont.(S1)  
 Insulation class : F  
 Service factor : 1.00  
 Temperature rise : 105 K

Rev.	Changes Summary	Performed	Checked	Date
Performed by			Page 20 / 22	Revision
Checked by				
Date	13/04/2022			

# VFD OPERATION CURVE

Three Phase Induction Motor - Squirrel Cage



Customer :

Product line : NEMA Premium Efficiency Three-Phase

Product code : 12052653

Catalog # : 45012ET3G586/7-W22

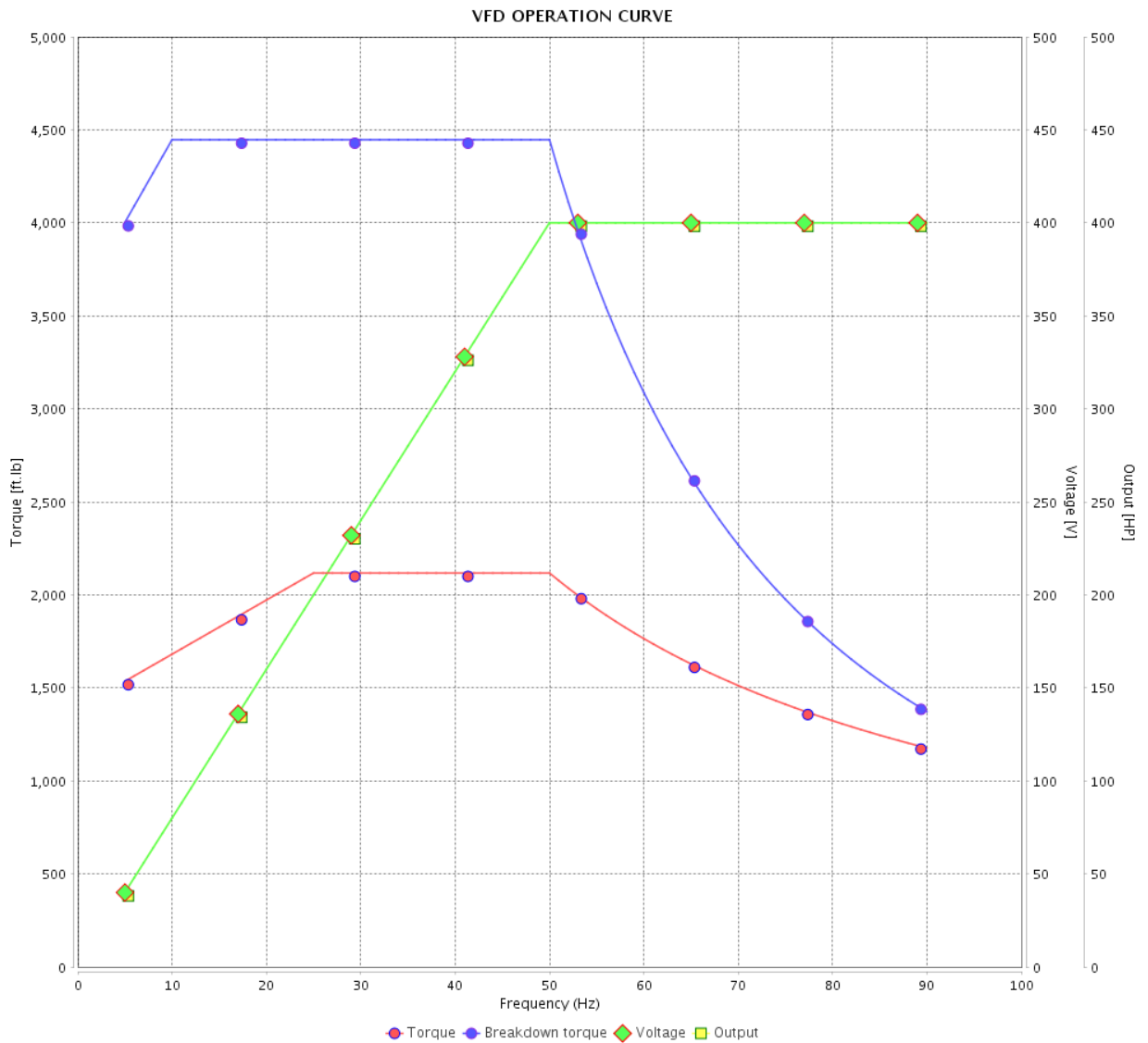

Performance : 400 V 50 Hz 6P IE3

Rated current : 558 A  
 LRC : 5.9  
 Rated torque : 2120 ft.lb  
 Locked rotor torque : 200 %  
 Breakdown torque : 210 %  
 Rated speed : 990 rpm

Moment of inertia (J) : 368 sq.ft.lb  
 Duty cycle : Cont.(S1)  
 Insulation class : F  
 Service factor : 1.00  
 Temperature rise : 105 K

Rev.	Changes Summary	Performed	Checked	Date
Performed by				Page 21 / 22
Checked by				
Date	13/04/2022			

# VFD OPERATION CURVE

Three Phase Induction Motor - Squirrel Cage



Customer :

Product line : NEMA Premium Efficiency Three-Phase

Product code : 12052653

Catalog # : 45012ET3G586/7-W22

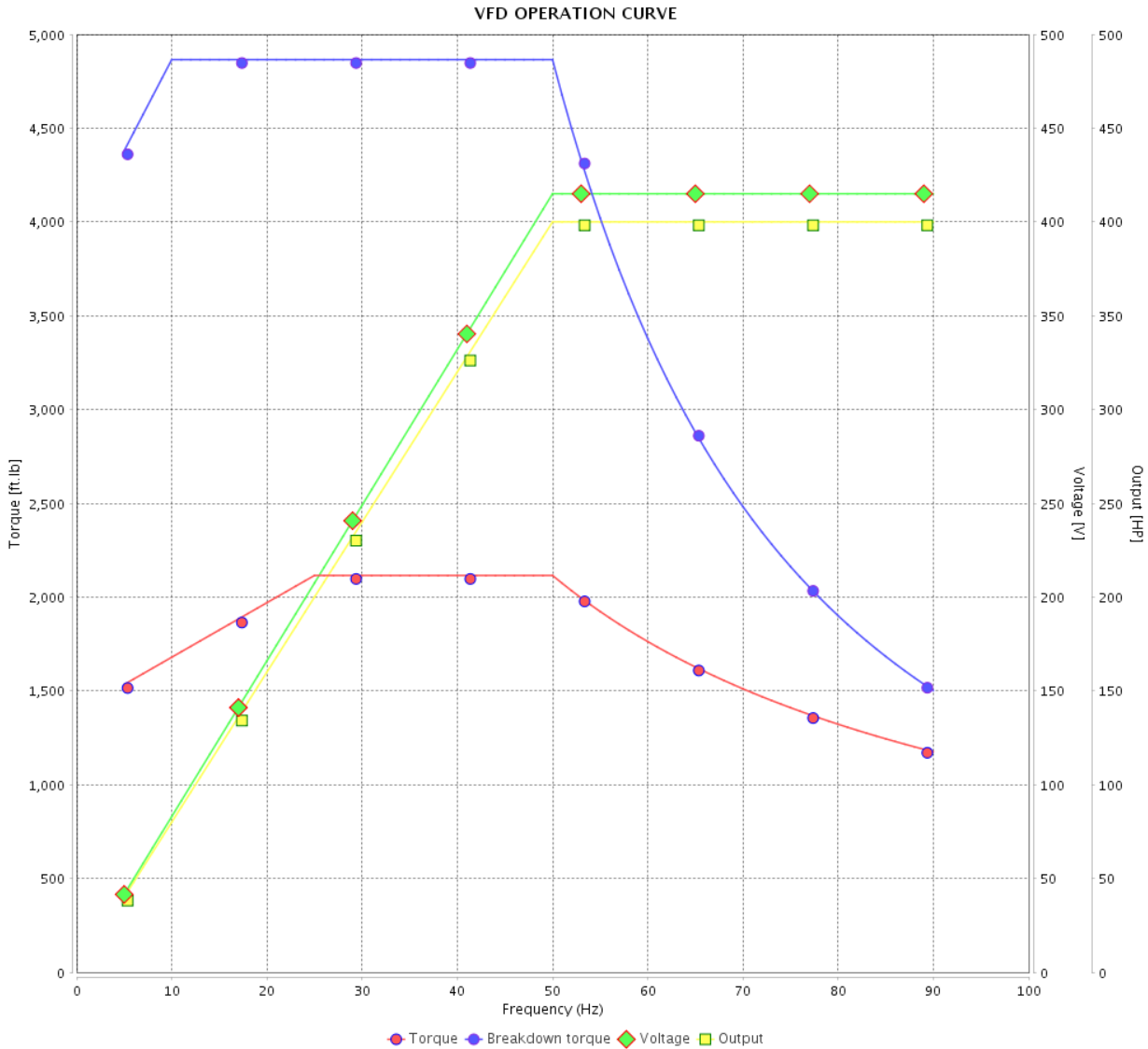

Performance : 415 V 50 Hz 6P IE3

Rated current : 542 A  
 LRC : 6.3  
 Rated torque : 2120 ft.lb  
 Locked rotor torque : 220 %  
 Breakdown torque : 229 %  
 Rated speed : 990 rpm

Moment of inertia (J) : 368 sq.ft.lb  
 Duty cycle : Cont.(S1)  
 Insulation class : F  
 Service factor : 1.00  
 Temperature rise : 105 K

Rev.	Changes Summary	Performed	Checked	Date
Performed by			Page 22 / 22	Revision
Checked by				
Date	13/04/2022			

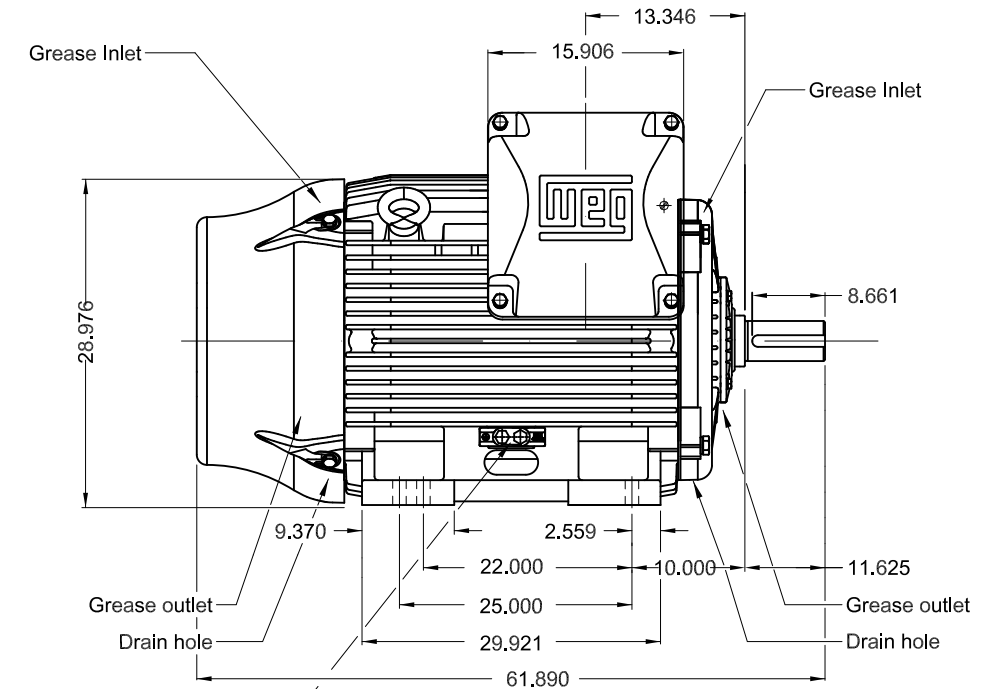
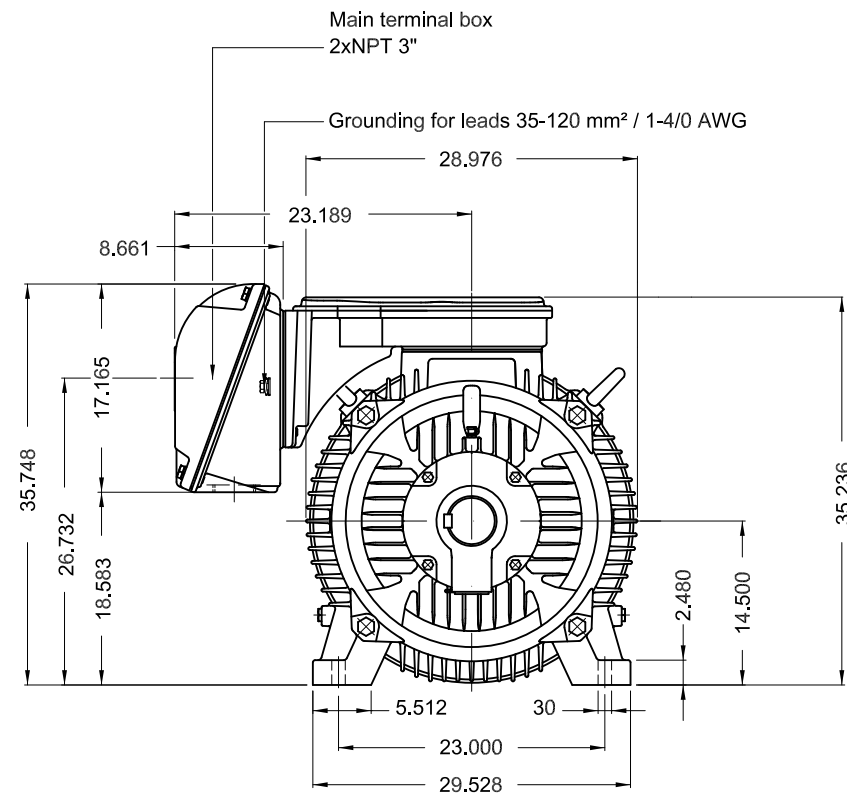

Grounding for leads 25-185 mm<sup>2</sup> / 3AWG-350MCM

NDE endshield with electrically insulated bearing hub  
 Color RAL 5009  
 Painting plan 203A  
 Mounting B3R(D)

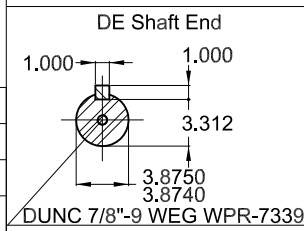

450 HP 06 Poles 60 Hz

ECM	LOC	SUMMARY OF MODIFICATIONS	EXECUTED	CHECKED	RELEASED	DATE	VER
EXECUTED	PIRWUSER	THREE PH. MOTOR W22 PREM. EFF.					
CHECKED		FRAME 586/7T IP55 TEFC					
RELEASED							
REL DT.	WMO	Jaragua do Sul	Product Engineering	SHEET	1 / 1		

PREVIEW  
WDD

