

DATA SHEET

Three Phase Induction Motor - Squirrel Cage



Customer :				
Product line	: Standard Efficiency Three-Phase	Product code :	14797716	
		Catalog # :	.7536ES3E56C-S	
Frame	: 56C	Cooling method	: IC411 - TEFC	
Insulation class	: F	Mounting	: F-1	
Duty cycle	: Cont.(S1)	Rotation ¹	: Both (CW and CCW)	
Ambient temperature	: -20°C to +40°C	Starting method	: Direct On Line	
Altitude	: 1000 m.a.s.l.	Approx. weight ²	: 21.4 lb	
Protection degree	: IP55	Moment of inertia (J)	: 0.0517 sq.ft.lb	
Output [HP]	0.75	0.75	0.75	
Poles	2	2	2	
Frequency [Hz]	60	50	50	
Rated voltage [V]	208-230/460	190/380	220/415	
Rated current [A]	2.50-2.26/1.13	2.52/1.26	2.28/1.21	
L. R. Amperes [A]	17.5-15.8/7.91	13.9/6.93	13.7/7.26	
LRC [A]	7.0x(Code K)	5.5x(Code G)	6.0x(Code H)	
No load current [A]	0.948-1.10/0.550	1.05/0.526	1.14/0.602	
Rated speed [RPM]	3475	2825	2845	
Slip [%]	3.47	5.83	5.17	
Rated torque [ft.lb]	1.13	1.39	1.38	
Locked rotor torque [%]	250	180	210	
Breakdown torque [%]	290	220	250	
Service factor		1.00	1.00	
Temperature rise	80 K	105 K	80 K	
Locked rotor time	41s (cold) 23s (hot)	52s (cold) 29s (hot)	46s (cold) 26s (hot)	
Noise level ²	68.0 dB(A)	65.0 dB(A)	65.0 dB(A)	
Efficiency (%)	25%	58.8	70.1	68.3
	50%	62.0	70.3	69.2
	75%	68.0	73.4	73.3
	100%	72.0	73.0	73.7
Power Factor	25%	0.45	0.49	0.44
	50%	0.70	0.77	0.72
	75%	0.79	0.86	0.83
	100%	0.85	0.91	0.89
Bearing type	: Drive end 6203 ZZ	Non drive end 6202 ZZ	Foundation loads	
Sealing	: V'Ring	Without Bearing Seal	Max. traction : 23 lb	
			Max. compression : 44 lb	
Lubrication interval	: -	-		
Lubricant amount	: -	-		
Lubricant type	: Mobil Polyrex EM			
Notes USABLE @208V SF 1.00				
This revision replaces and cancel the previous one, which must be eliminated. (1) Looking the motor from the shaft end. (2) Measured at 1m and with tolerance of +3dB(A). (3) Approximate weight subject to changes after manufacturing process. (4) At 100% of full load.		These are average values based on tests with sinusoidal power supply, subject to the tolerances stipulated in NEMA MG-1.		
Rev.	Changes Summary	Performed	Checked	Date
Performed by				
Checked by			Page	Revision
Date	11/04/2022		1 / 13	

TORQUE AND CURRENT VS SPEED CURVE

Three Phase Induction Motor - Squirrel Cage



Customer :

Product line : Standard Efficiency Three-Phase

Product code :

14797716

Catalog # :

.7536ES3E56C-S

TORQUE AND CURRENT VS SPEED CURVE

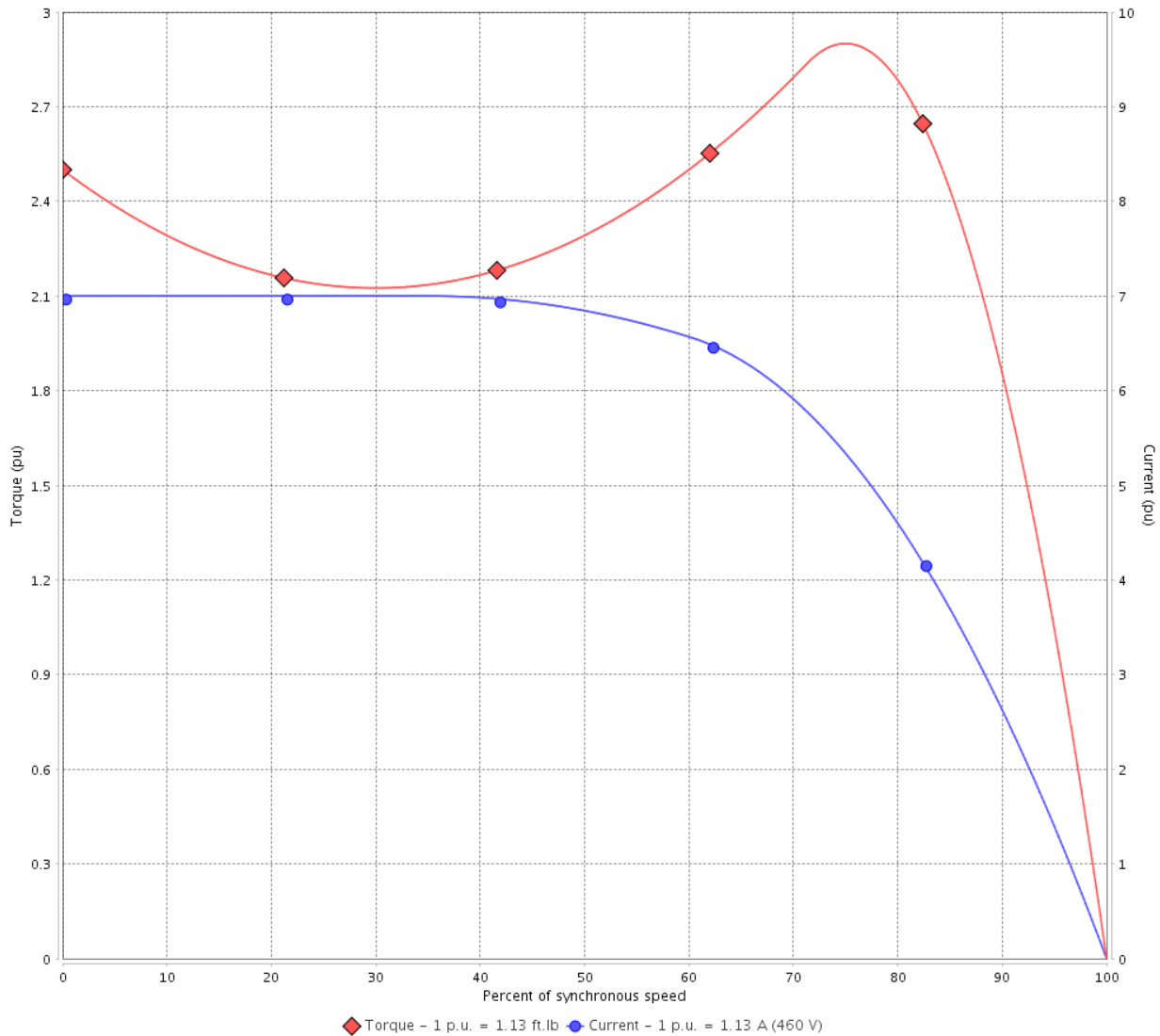

Performance : 208-230/460 V 60 Hz 2P

Rated current	: 2.50-2.26/1.13 A	Moment of inertia (J)	: 0.0517 sq.ft.lb
LRC	: 7.0	Duty cycle	: Cont.(S1)
Rated torque	: 1.13 ft.lb	Insulation class	: F
Locked rotor torque	: 250 %	Service factor	:
Breakdown torque	: 290 %	Temperature rise	: 80 K
Rated speed	: 3475 rpm		

Locked rotor time : 41s (cold) 23s (hot)

Rev.	Changes Summary	Performed	Checked	Date
Performed by			Page 2 / 13	Revision
Checked by				
Date	11/04/2022			

TORQUE AND CURRENT VS SPEED CURVE

Three Phase Induction Motor - Squirrel Cage



Customer :

Product line : Standard Efficiency Three-Phase Product code : 14797716
 Catalog # : .7536ES3E56C-S

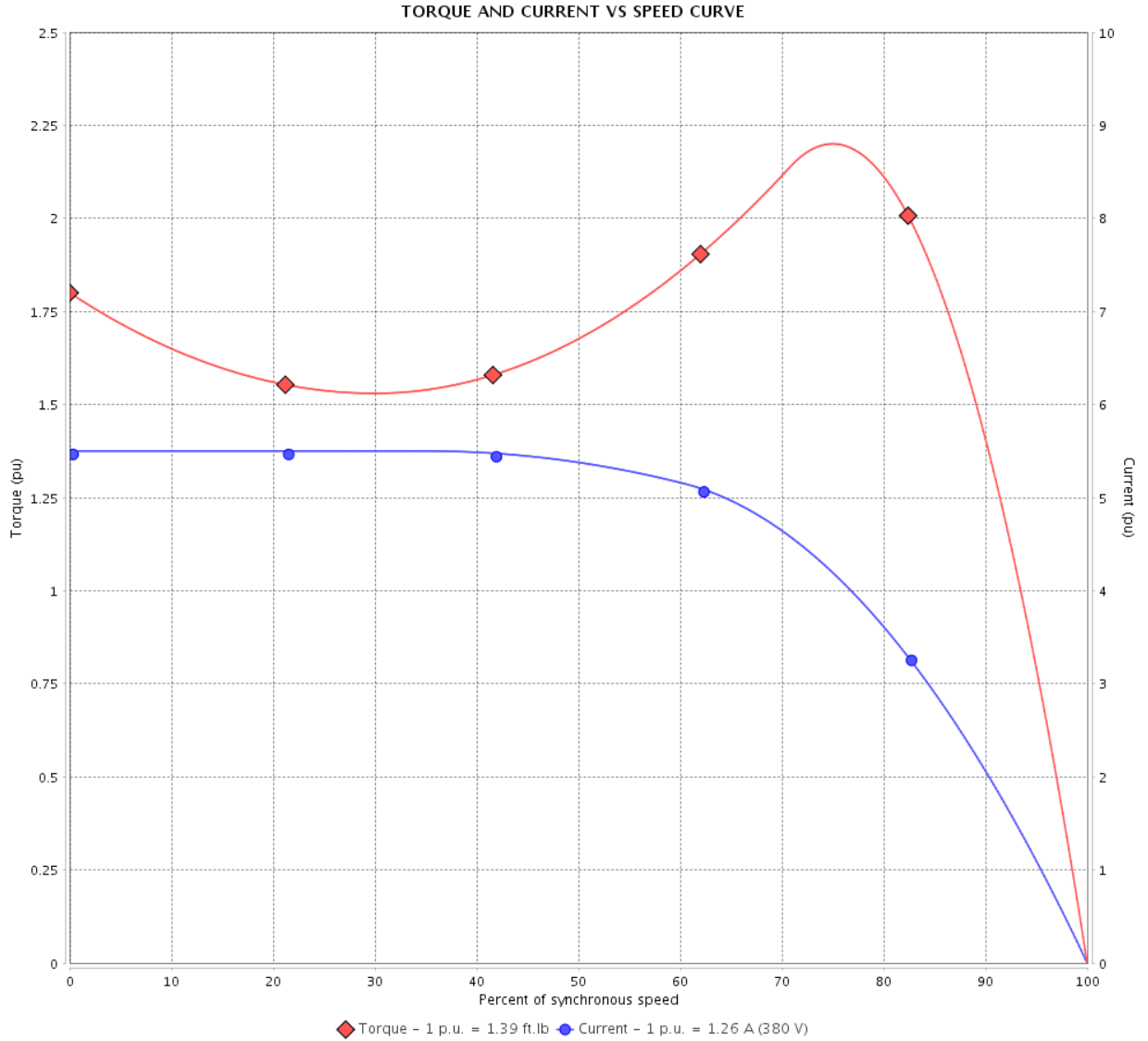

Performance : 190/380 V 50 Hz 2P

Rated current	: 2.52/1.26 A	Moment of inertia (J)	: 0.0517 sq.ft.lb
LRC	: 5.5	Duty cycle	: Cont.(S1)
Rated torque	: 1.39 ft.lb	Insulation class	: F
Locked rotor torque	: 180 %	Service factor	: 1.00
Breakdown torque	: 220 %	Temperature rise	: 105 K
Rated speed	: 2825 rpm		

Locked rotor time : 52s (cold) 29s (hot)

Rev.	Changes Summary	Performed	Checked	Date
Performed by			Page	Revision
Checked by				
Date	11/04/2022			
			3 / 13	

TORQUE AND CURRENT VS SPEED CURVE

Three Phase Induction Motor - Squirrel Cage



Customer :

Product line : Standard Efficiency Three-Phase Product code : 14797716
 Catalog # : .7536ES3E56C-S

TORQUE AND CURRENT VS SPEED CURVE

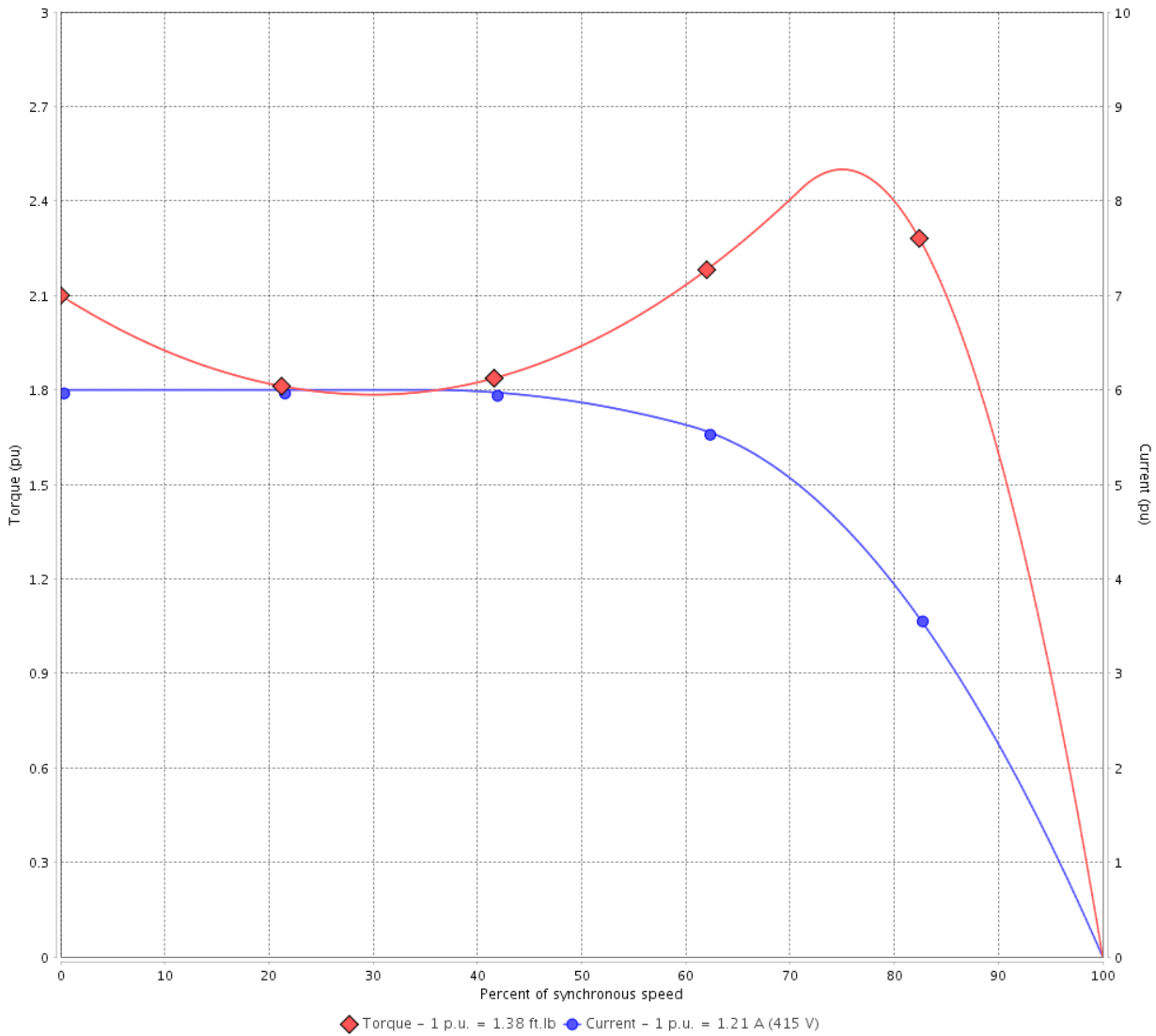

Performance : 220/415 V 50 Hz 2P

Rated current	: 2.28/1.21 A	Moment of inertia (J)	: 0.0517 sq.ft.lb
LRC	: 6.0	Duty cycle	: Cont.(S1)
Rated torque	: 1.38 ft.lb	Insulation class	: F
Locked rotor torque	: 210 %	Service factor	: 1.00
Breakdown torque	: 250 %	Temperature rise	: 80 K
Rated speed	: 2845 rpm		

Locked rotor time : 46s (cold) 26s (hot)

Rev.	Changes Summary	Performed	Checked	Date
Performed by			Page 4 / 13	Revision
Checked by				
Date	11/04/2022			

LOAD PERFORMANCE CURVE

Three Phase Induction Motor - Squirrel Cage



Customer : _____

Product line : Standard Efficiency Three-Phase

Product code :

14797716

Catalog # :

.7536ES3E56C-S

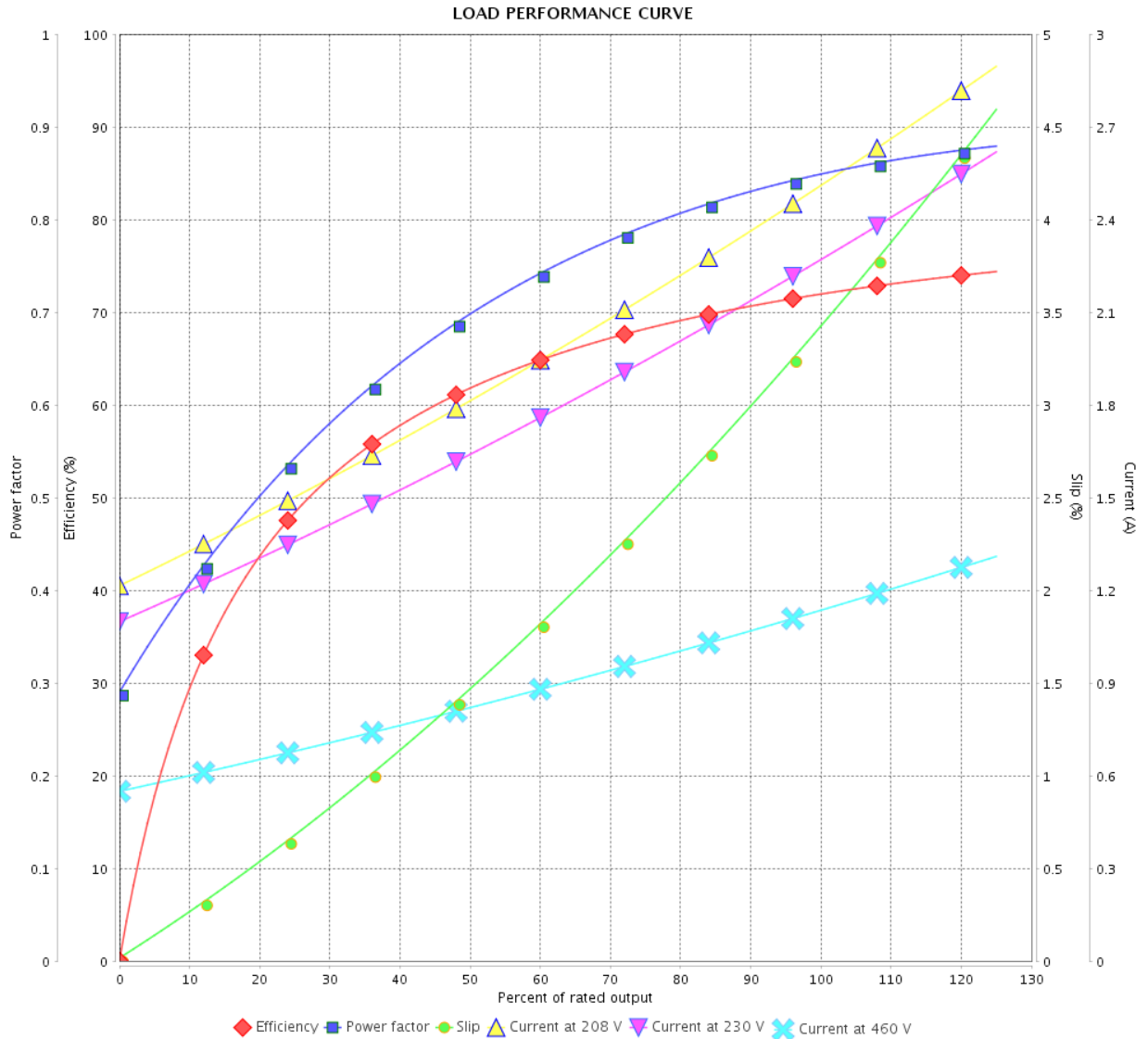

Performance : 208-230/460 V 60 Hz 2P

Rated current : 2.50-2.26/1.13 A
 LRC : 7.0
 Rated torque : 1.13 ft.lb
 Locked rotor torque : 250 %
 Breakdown torque : 290 %
 Rated speed : 3475 rpm

Moment of inertia (J) : 0.0517 sq.ft.lb
 Duty cycle : Cont.(S1)
 Insulation class : F
 Service factor :
 Temperature rise : 80 K

Rev.	Changes Summary	Performed	Checked	Date
Performed by		Page		Revision
Checked by		5 / 13		
Date		11/04/2022		

LOAD PERFORMANCE CURVE

Three Phase Induction Motor - Squirrel Cage



Customer : _____

Product line : Standard Efficiency Three-Phase Product code : 14797716
 Catalog # : .7536ES3E56C-S

LOAD PERFORMANCE CURVE

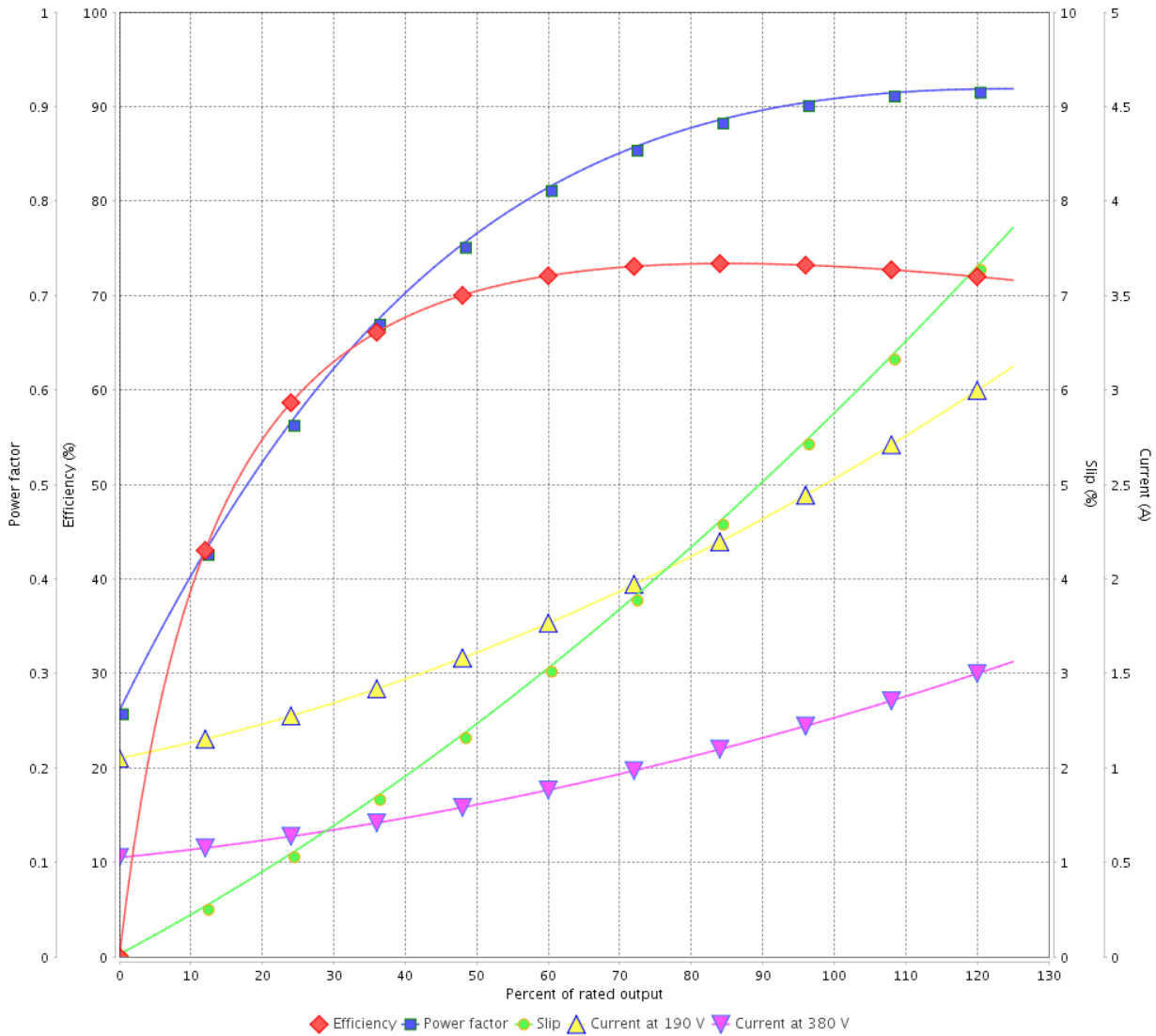

Performance : 190/380 V 50 Hz 2P

Rated current : 2.52/1.26 A
 LRC : 5.5
 Rated torque : 1.39 ft.lb
 Locked rotor torque : 180 %
 Breakdown torque : 220 %
 Rated speed : 2825 rpm

Moment of inertia (J) : 0.0517 sq.ft.lb
 Duty cycle : Cont.(S1)
 Insulation class : F
 Service factor : 1.00
 Temperature rise : 105 K

Rev.	Changes Summary	Performed	Checked	Date
Performed by			Page 6 / 13	Revision
Checked by				
Date	11/04/2022			

LOAD PERFORMANCE CURVE

Three Phase Induction Motor - Squirrel Cage



Customer :

Product line : Standard Efficiency Three-Phase

Product code :

14797716

Catalog # :

.7536ES3E56C-S

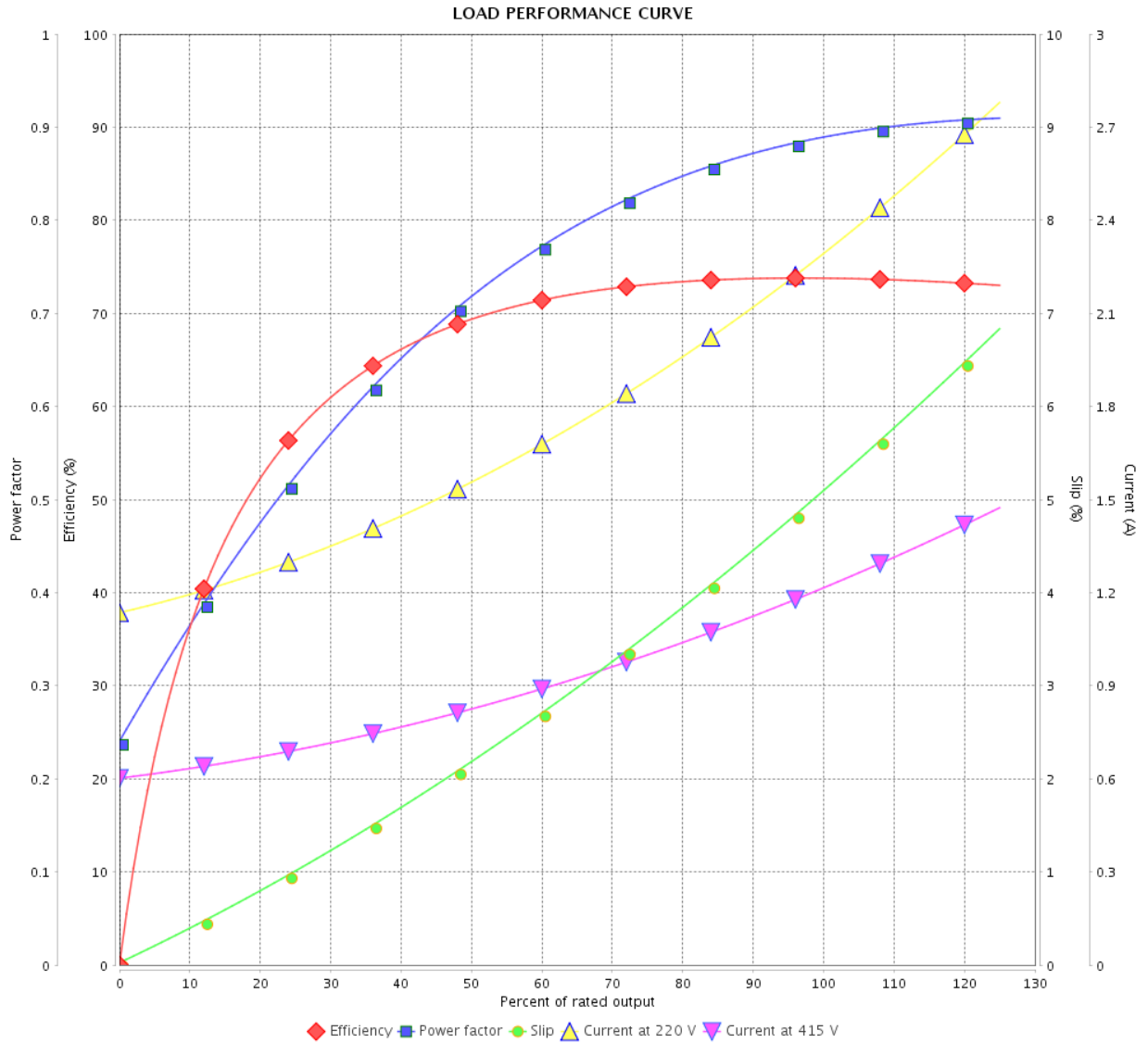

Performance : 220/415 V 50 Hz 2P

Rated current : 2.28/1.21 A
 LRC : 6.0
 Rated torque : 1.38 ft.lb
 Locked rotor torque : 210 %
 Breakdown torque : 250 %
 Rated speed : 2845 rpm

Moment of inertia (J) : 0.0517 sq.ft.lb
 Duty cycle : Cont.(S1)
 Insulation class : F
 Service factor : 1.00
 Temperature rise : 80 K

Rev.	Changes Summary	Performed	Checked	Date
Performed by		Page		Revision
Checked by		7 / 13		
Date		11/04/2022		

THERMAL LIMIT CURVE

Three Phase Induction Motor - Squirrel Cage



Customer : _____

Product line : Standard Efficiency Three-Phase

Product code :

14797716

Catalog # :

.7536ES3E56C-S

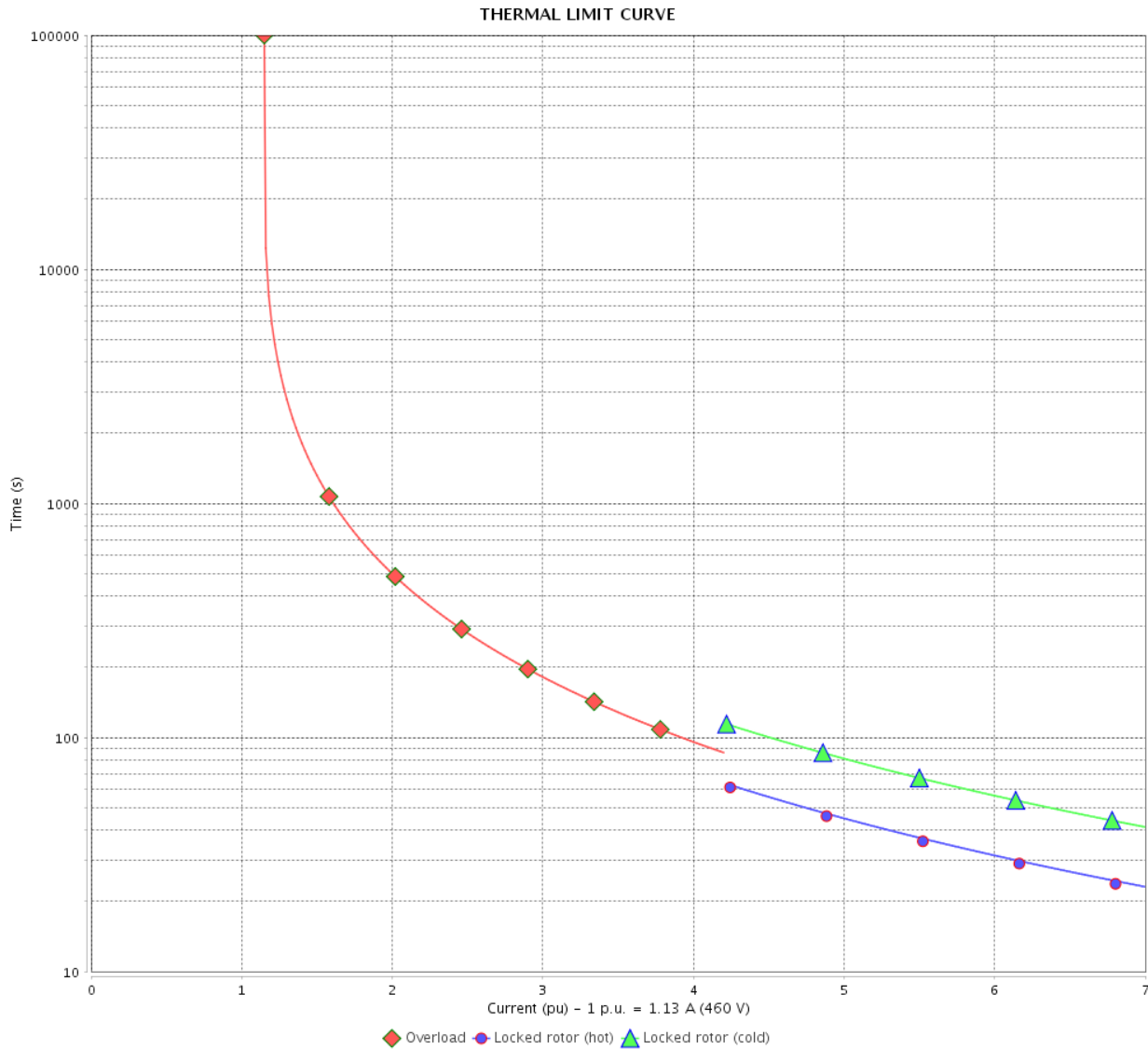

Performance : 208-230/460 V 60 Hz 2P

Rated current : 2.50-2.26/1.13 A
 LRC : 7.0
 Rated torque : 1.13 ft.lb
 Locked rotor torque : 250 %
 Breakdown torque : 290 %
 Rated speed : 3475 rpm

Moment of inertia (J) : 0.0517 sq.ft.lb
 Duty cycle : Cont.(S1)
 Insulation class : F
 Service factor :
 Temperature rise : 80 K

Heating constant

Cooling constant

Rev.	Changes Summary	Performed	Checked	Date
Performed by		Page		Revision
Checked by				
Date				

THERMAL LIMIT CURVE

Three Phase Induction Motor - Squirrel Cage



Customer : _____

Product line : Standard Efficiency Three-Phase

Product code :

14797716

Catalog # :

.7536ES3E56C-S

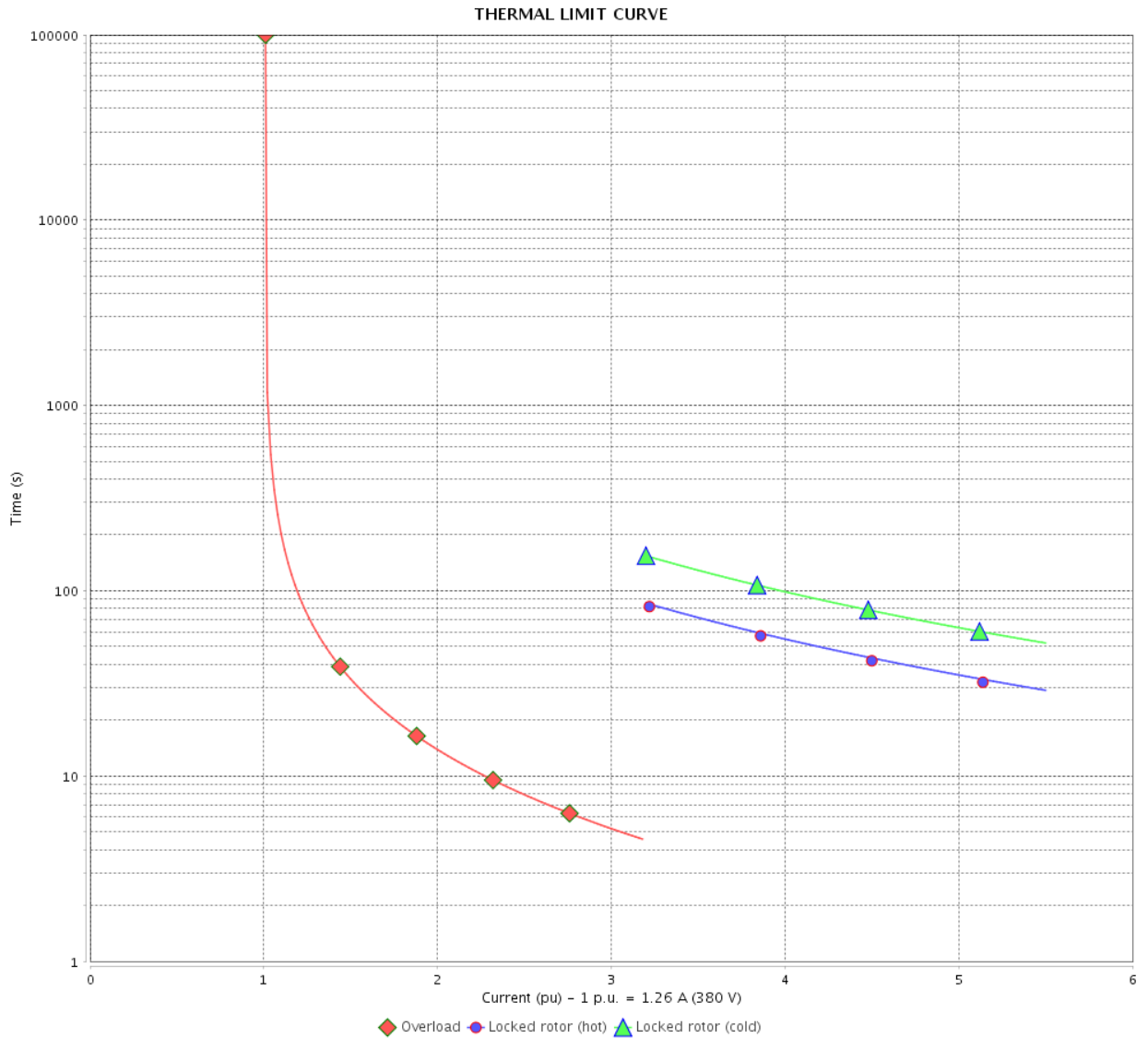

Performance : 190/380 V 50 Hz 2P

Rated current : 2.52/1.26 A
 LRC : 5.5
 Rated torque : 1.39 ft.lb
 Locked rotor torque : 180 %
 Breakdown torque : 220 %
 Rated speed : 2825 rpm

Moment of inertia (J) : 0.0517 sq.ft.lb
 Duty cycle : Cont.(S1)
 Insulation class : F
 Service factor : 1.00
 Temperature rise : 105 K

Heating constant

Cooling constant

Rev.	Changes Summary	Performed	Checked	Date
Performed by				
Checked by				
Date				
		Page	Revision	
		9 / 13		

THERMAL LIMIT CURVE

Three Phase Induction Motor - Squirrel Cage



Customer : _____

Product line : Standard Efficiency Three-Phase

Product code :

14797716

Catalog # :

.7536ES3E56C-S

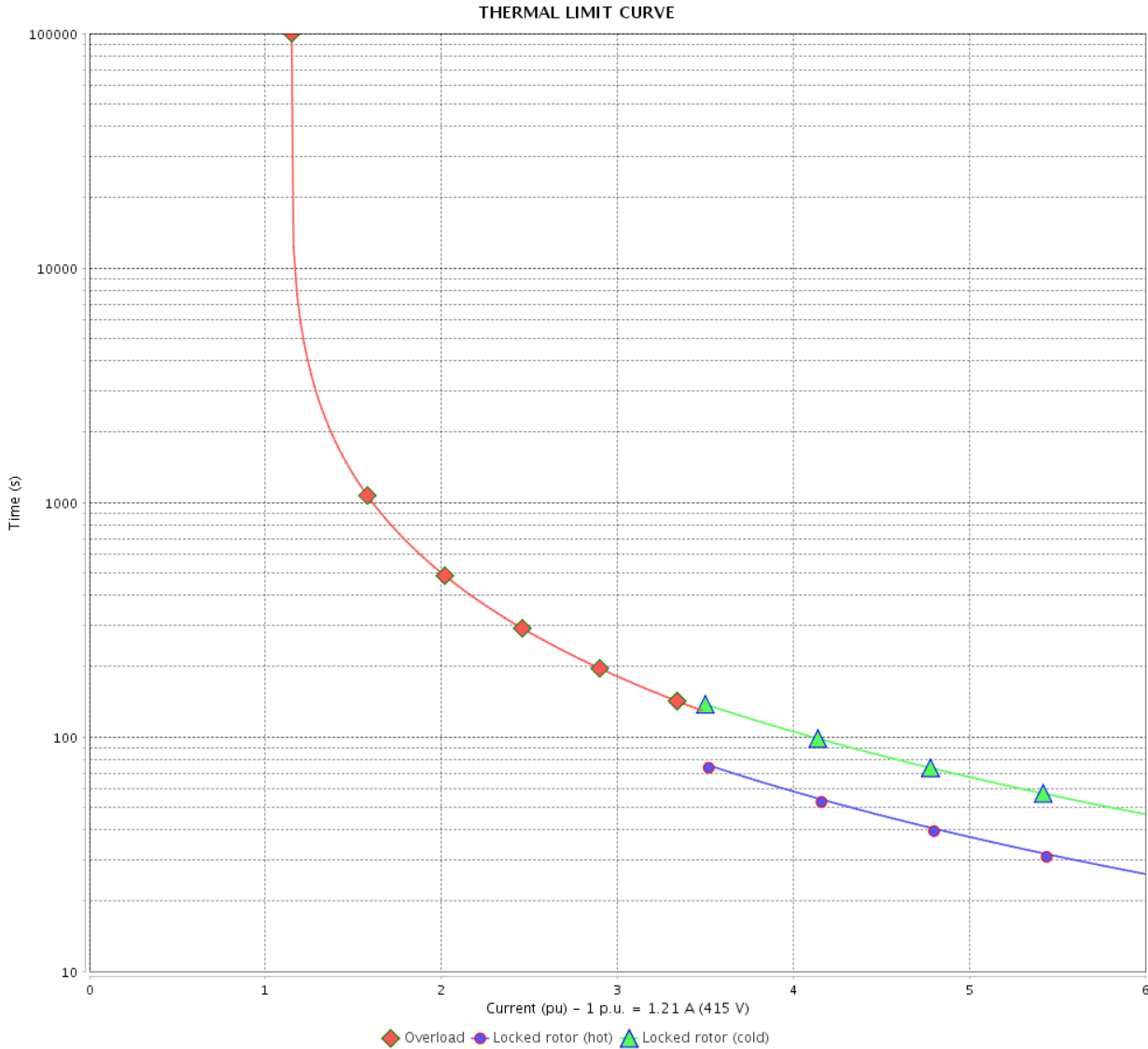

Performance : 220/415 V 50 Hz 2P

Rated current : 2.28/1.21 A
 LRC : 6.0
 Rated torque : 1.38 ft.lb
 Locked rotor torque : 210 %
 Breakdown torque : 250 %
 Rated speed : 2845 rpm

Moment of inertia (J) : 0.0517 sq.ft.lb
 Duty cycle : Cont.(S1)
 Insulation class : F
 Service factor : 1.00
 Temperature rise : 80 K

Heating constant

Cooling constant

Rev.	Changes Summary	Performed	Checked	Date
Performed by	11/04/2022	Page		Revision
Checked by		10 / 13		
Date				

VFD OPERATION CURVE

Three Phase Induction Motor - Squirrel Cage



Customer :

Product line : Standard Efficiency Three-Phase Product code : 14797716
 Catalog # : .7536ES3E56C-S

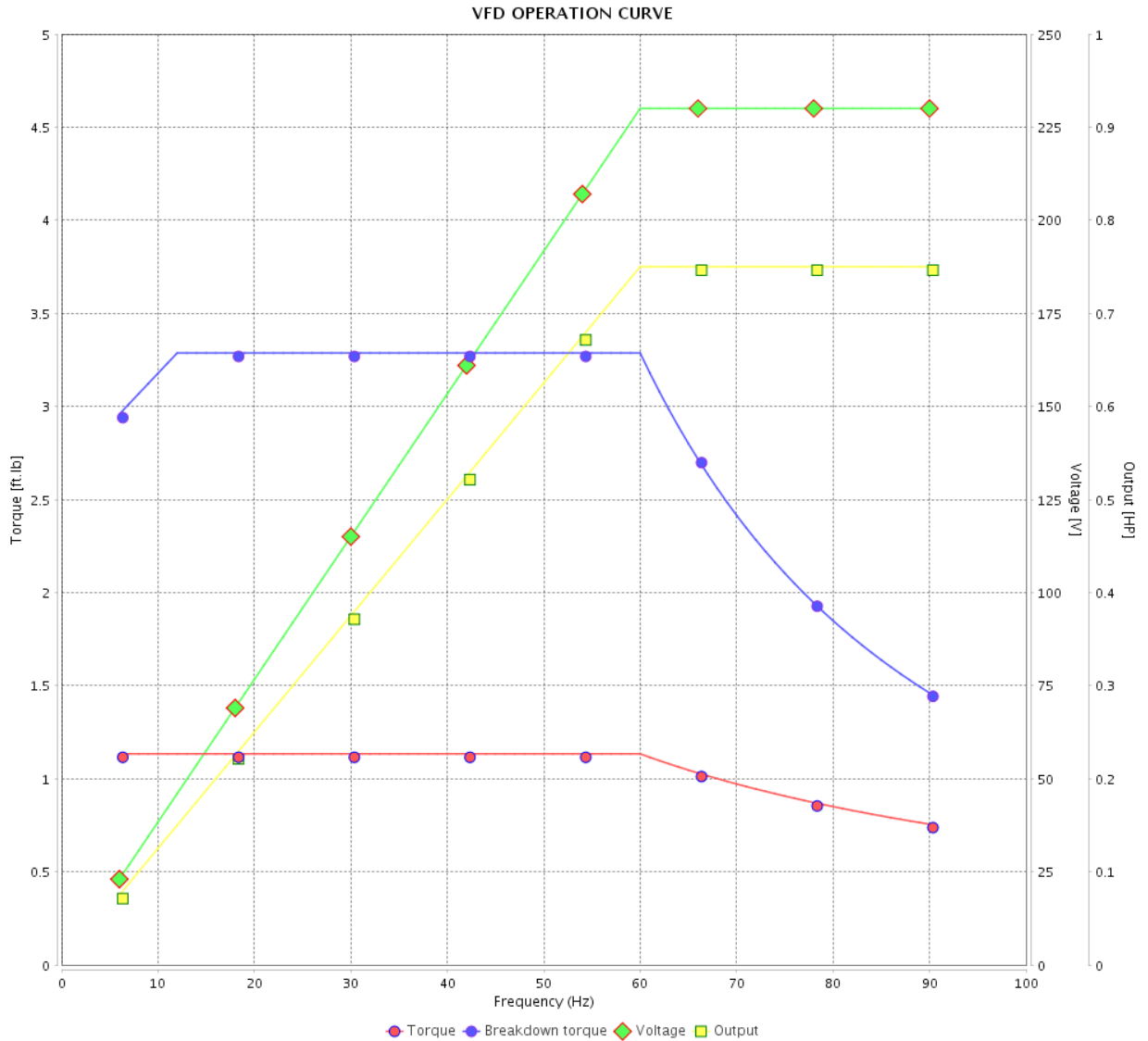

Performance : 208-230/460 V 60 Hz 2P

Rated current : 2.50-2.26/1.13 A
 LRC : 7.0
 Rated torque : 1.13 ft.lb
 Locked rotor torque : 250 %
 Breakdown torque : 290 %
 Rated speed : 3475 rpm

Moment of inertia (J) : 0.0517 sq.ft.lb
 Duty cycle : Cont.(S1)
 Insulation class : F
 Service factor :
 Temperature rise : 80 K

Rev.	Changes Summary	Performed	Checked	Date
Performed by			Page 11 / 13	Revision
Checked by				
Date	11/04/2022			

VFD OPERATION CURVE

Three Phase Induction Motor - Squirrel Cage



Customer :

Product line : Standard Efficiency Three-Phase Product code : 14797716
 Catalog # : .7536ES3E56C-S

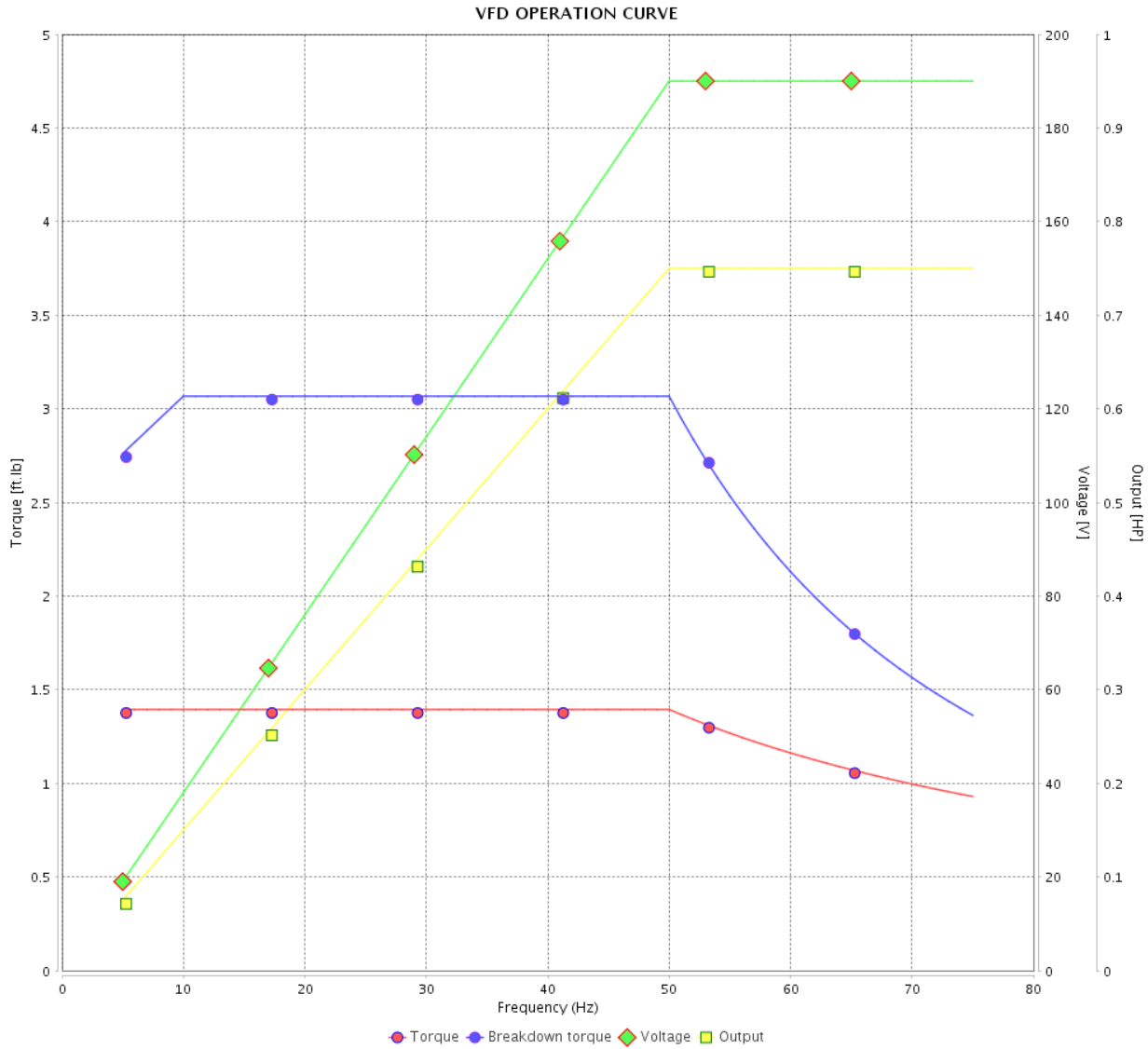

Performance : 190/380 V 50 Hz 2P

Rated current : 2.52/1.26 A
 LRC : 5.5
 Rated torque : 1.39 ft.lb
 Locked rotor torque : 180 %
 Breakdown torque : 220 %
 Rated speed : 2825 rpm

Moment of inertia (J) : 0.0517 sq.ft.lb
 Duty cycle : Cont.(S1)
 Insulation class : F
 Service factor : 1.00
 Temperature rise : 105 K

Rev.	Changes Summary	Performed	Checked	Date
Performed by		Page		Revision
Checked by		12 / 13		
Date	11/04/2022			

VFD OPERATION CURVE

Three Phase Induction Motor - Squirrel Cage



Customer : _____

Product line : Standard Efficiency Three-Phase Product code : 14797716
 Catalog # : .7536ES3E56C-S

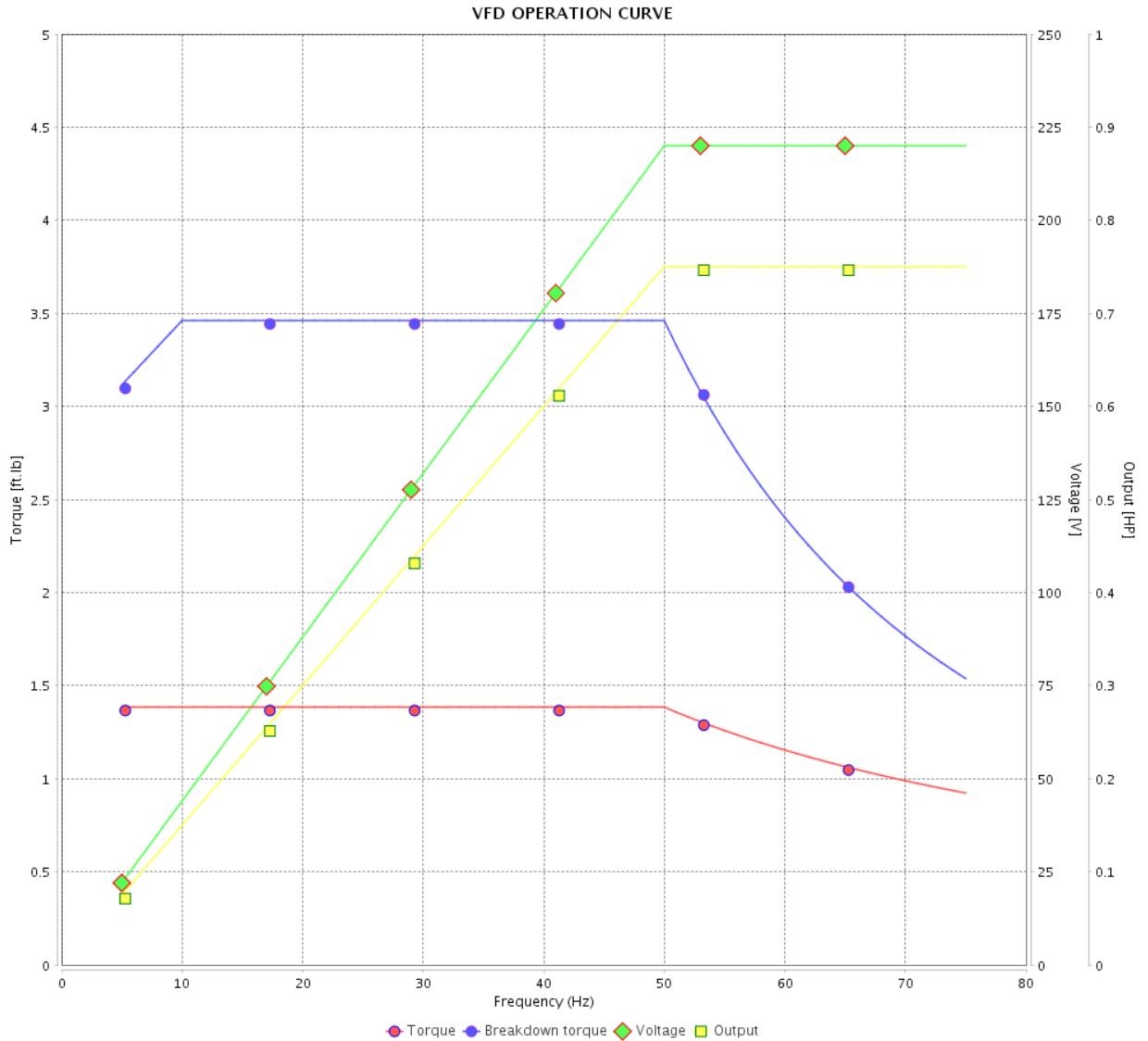

Performance : 220/415 V 50 Hz 2P

Rated current : 2.28/1.21 A
 LRC : 6.0
 Rated torque : 1.38 ft.lb
 Locked rotor torque : 210 %
 Breakdown torque : 250 %
 Rated speed : 2845 rpm

Moment of inertia (J) : 0.0517 sq.ft.lb
 Duty cycle : Cont.(S1)
 Insulation class : F
 Service factor : 1.00
 Temperature rise : 80 K

Rev.	Changes Summary	Performed	Checked	Date
Performed by			Page 13 / 13	Revision
Checked by				
Date	11/04/2022			

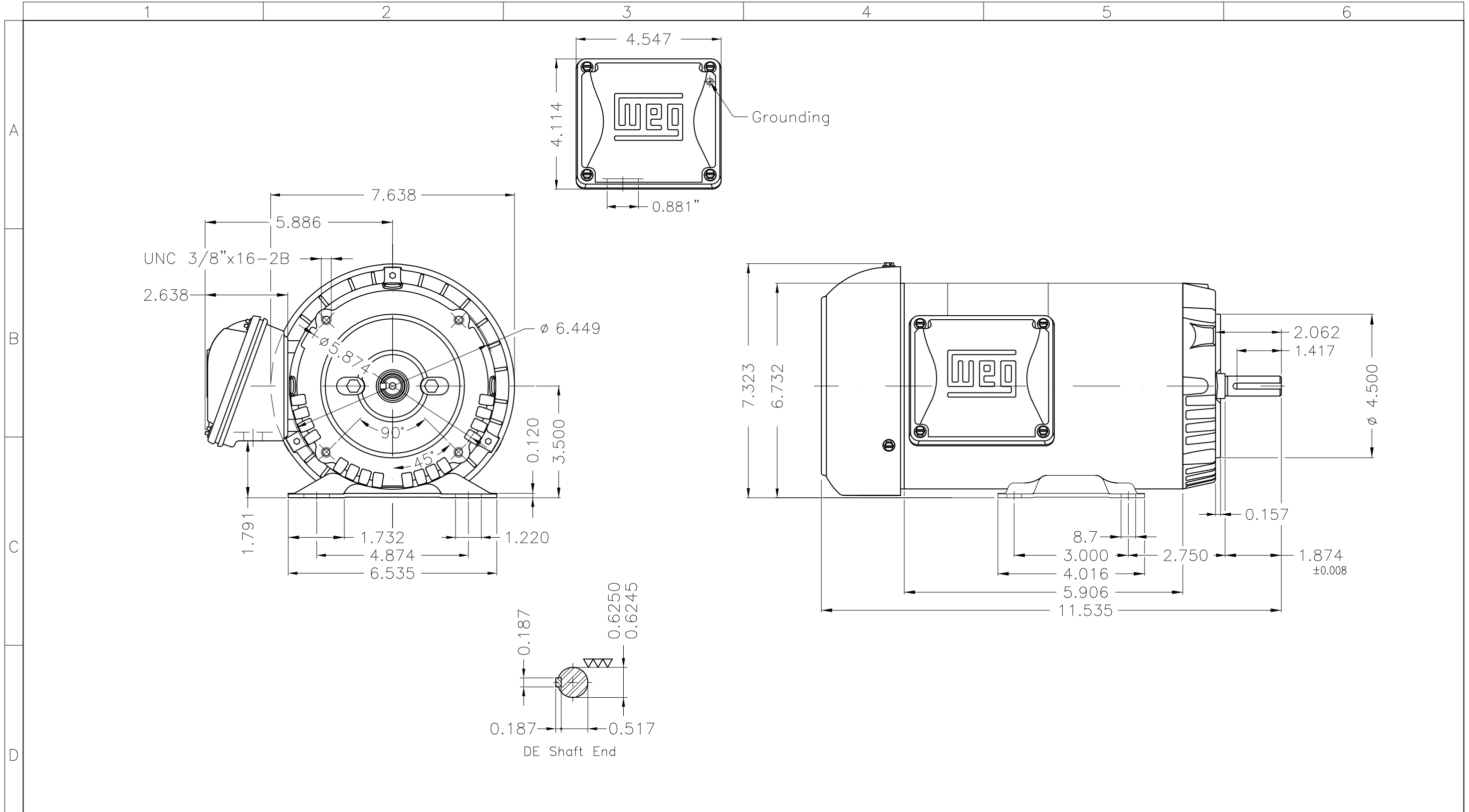

Fan cover - steel plate
 Color Munsell N 1 matte black
 Painting plan 207N
 Mounting F-1/B34R(D)

ECM	LOC	SUMMARY OF MODIFICATIONS	EXECUTED	CHECKED	RELEASED	DATE	VER
EXECUTED	PIRWUSER	THREE PH. MOTOR ROLLED STEEL					
CHECKED		FRAME 56C IP55 TEFC					
RELEASED							
REL DT.	WMO	Jaragua do Sul	Product Engineering	PREVIEW	WDD		
			SHEET		1 / 1		

0.75 HP 02 Poles 60 Hz



MADE IN BRAZIL

MAT: 14797716

W01.TE0IC0X0X

MODEL 7536ES3E56C-S

08APR2022 B/N:

**For 60Hz: Class I, Zone 2, IIC
Class I, Div.2, Gr. A,B,C,D - T3
Div 2 Inverter Duty (SF1.00)**

CT 2:1/VT 1000:1

PH 3	Hz 60	HP 0.75
FR 56C		KW 0.55
DUTY CONT.		V 208-230/460
ALT 1000 m.a.s.l.		A 2.50-2.26/1.13
INS CL F AT 80K	IP55	SFA 2.50-2.60/1.30
AMB 40°C	DES -	SF 1.15
ENCL TEFC	CODE K	PF 0.85
USABLE @ 208V SF1.00		RPM 3475
		NEMA NOM. EFF 72.0%

ALTERNATE RATING: 0.75HP 50Hz 190-220/380-415V SF1.00
2.52-2.26/1.28-1.20A 2825RPM EFF 73.0% (IE1) IEC 60034-1

For safe area-Inverter duty motor For 60Hz use on VPWM 1000:1 VT, 10:1 CT

DE 6203-ZZ	ODE 6202-ZZ	MOBIL POLYREX EM
------------	-------------	------------------



T1-BLU T2-WHT
T3-ORG T4-YEL
T5-BLK T6-GRY
T7-PNK T8-RED
T9-BRK RED

INTERCHANGE ANY TWO LINE WIRES TO REVERSE THE ROTATION

WARNING: Motor must be grounded in accordance with local and national electrical codes to prevent serious electrical shocks. Disconnect power source before servicing unit.



AVERTISSEMENT: Le moteur doit être mis à la terre conformément aux codes électriques locaux et nationaux afin d'éviter tout choc électrique grave. Déconnectez l'alimentation avant l'entretien de la machine.

