

BALDOR • RELIANCE

Customer information packet

XM36462T

40HP, 1190RPM, 3PH, 60HZ, 364T, TEFC, F1

Class - CLI GP D; CLII GP F,G

Division - Division I

Specifications

Enclosure	TEFC
Frame	364T
Frame Material	Iron
Frequency	60.00 Hz
Motor Letter Type	Three Phase
Output @ Frequency	40.000 HP @ 60 HZ
Phase	3
Synchronous Speed @ Frequency	1200 RPM @ 60 HZ
Voltage @ Frequency	230.0 V @ 60 HZ
	460.0 V @ 60 HZ
XP Class and Group	CLI GP D; CLII GP F,G
XP Division	Division I
Agency Approvals	CCSA US
	CSA
	CSA EEV
	UL
Ambient Temperature	40 °C
Auxillary Box	No Auxillary Box
Base Indicator	Rigid
Bearing Grease Type	Polyrex EM (-20F +300F)
Constant Torque Speed Range	6-60
Current @ Voltage	99.600 A @ 230.0 V
	49.800 A @ 460.0 V
Design Code	B
Drip Cover	No Drip Cover
Duty Rating	CONT
Efficiency @ 100% Load	94.1 %
Feedback Device	NO FEEDBACK
Heater Indicator	No Heater
High Voltage Full Load Amps	49.8 a
Insulation Class	F
Inverter Code	Inverter Ready

Part detail

Revision	-
Type	AC
Mech. spec.	
Base	
Status	PRD/A
Elec. spec.	A36WG1194
Layout	611742-987
Eff. date	02-26-2020
CD Diagram	416820-002
Poles	06
Leads	3#4,6#6
Proprietary	False
Created date	11-15-2019

IP Rating	NONE
KVA Code	G
Lifting Lugs	Standard Lifting Lugs
Max Speed	3000 rpm
Motor Lead Quantity/Wire Size	3 @ 4 AWG
Motor Standards	NEMA
Motor Type	A36062M
Mounting Arrangement	F1
Number of Poles	6
Overall Length	33.48 IN
Power Factor	80
Product Family	General Industrial
Pulley End Bearing Type	Ball
Pulley Face Code	Standard
Service Factor	1.00
Shaft Diameter	2.374 IN
Shaft Ground Indicator	No Shaft Grounding
Shaft Rotation	Reversible
Shaft Slinger Indicator	Shaft Slinger
Speed	1190 rpm
Speed Code	Single Speed
Starting Method	Direct on line
Thermal Device - Bearing	None
Thermal Device - Winding	Normally Closed Thermostat
XP Temp Code	T3C

Nameplate

NP2496L	
MOBIL POLYREX EM	

000613006PC

CLASS I GROUP D X X **NO.****CLASS II GROUP** F G X**OPERATING TEMP CODE** T3C

NP4017L

SPEC NO.	A36-7824-1194		CAT.NO.	XM36462T		FRAME SIZE	364T
HP	40	VOLTS	230/460		PHASE	3	DESIGN B
RPM	1190	AMPS	99.6/49.8		HZ	60	AMB 40
DRIVE END BEARING	65BC03J30X		DUTY	CONT		INSUL CLASS	F
OPP D.E. BEARING	65BC03J30X		ENCL	TEFC		CODE	G
SINE WAVE SF	1.15	WK2	20.223	MAG CUR	18.5		MAX RPM 3000
CT HZ	6-60	VT HZ	0-60	CHP HZ	60-90		NOM.EFF. 94.1
	IP54						
SER.NO.			MOTOR WEIGHT	915			

Parts list

Part number	Description	Quantity
SA379403	SA A36-7824-1194	1.000 ea
RA369400	RA A36-7824-1194	1.000 ea
421948032	LABEL, MYLAR	1.000 ea
NP2496L	MOTOR LUBE NAMEPLATE	1.000 ea
000692000VD	LABEL WARNING	1.000 ea
LB1073	ALUM XP CAUTION LABEL	1.000 ea
000613006PC	N/P U/L (REL QTY 500)	1.000 ea
NP4017L	INVERTER DUTY, SS, CC, CSA-C US, CSA EEV	1.000 ea
087793060BB	BRKT 360 087793050WCB	1.000 ea
415072001B	CLAMP	1.000 ea
415030051AX	BUSH - 360	1.000 ea
078559001A	+FANCV - 360	1.000 ea
034180012DA	KEY 1X4X1/4X1-1/2 L	1.000 ea
078550001M	FAN KB 60/30 (30) 360	1.000 ea
004824015A	GREASE POLYREX EM	0.540 lb
032018008AK	HHCS 1/4-20X1 PLATED	4.000 ea
032018018CK	HHCS 3/8-16X2-1/4 PLTD.	2.000 ea
415096002A	CPLG 1/8 HEX TYPE	1.000 ea
604923009R	SLGR - 360	1.000 ea
410700004F	WSHR	1.000 ea
034017016AB	LCKW 1/2" PLATED	4.000 ea
034017012AB	LCKW 1/4 STD. PLATED 034017012AF	4.000 ea
032130020DB	HSHCS 1/2-13X2-1/2 PLTD.	4.000 ea
034017014AB	LCKW 3/8 STD. PLATED	2.000 ea
034530056AC	P/NIP 1/8X7L GALV-365	1.000 ea
032620012HD	HSSS 8-32X3/8 304S.S.	2.000 ea
034690001AB	1/8" NPT SQHDPLG	1.000 ea
034690002AB	PPLG 1/4" PLTD.	1.000 ea
034690001AB	1/8" NPT SQHDPLG	1.000 ea
034690002AB	PPLG 1/4" PLTD.	1.000 ea
087793060BA	BRKT 360 087793050WCB	1.000 ea

032018018CK	HHCS 3/8-16X2-1/4 PLTD.	2.000 ea
604923009R	SLGR - 360	1.000 ea
034017016AB	LCKW 1/2" PLATED	4.000 ea
034017014AB	LCKW 3/8 STD. PLATED	2.000 ea
032620012HD	HSSS 8-32X3/8 304S.S.	2.000 ea
415030051AX	BUSH - 360	1.000 ea
032130020DB	HSHCS 1/2-13X2-1/2 PLTD.	4.000 ea
14CB1000A01	CONDUIT BOX, BOLT-ON, MACH, XP 360 & 400	1.000 ea
14CB1500A01	CONDUIT BOX LID MACH	1.000 ea
034017014AB	LCKW 3/8 STD. PLATED	6.000 ea
034017014AB	LCKW 3/8 STD. PLATED	4.000 ea
032130012CB	HSHCS 3/8X1-1/2 PLTD-320	6.000 ea
415000103D	T/LUG #4AWG-1/0AWG W/HOLE FOR .250 BOLT	1.000 ea
406099000A	PLUG - FAN COVER 320-440	1.000 ea
032018004AK	HHCS 1/4-20X1/2 PLATED	1.000 ea
034017012AB	LCKW 1/4 STD. PLATED 034017012AF	1.000 ea
032130012CB	HSHCS 3/8X1-1/2 PLTD-320	4.000 ea
MG1025G29	WILKOFAS, 789.229, DARK CHARCOAL GRAY	0.250 ga
033775004EA	DRSCR #6-1/4 304 S.S.	8.000 ea
034180034HA	KEY 5/8X5/8X4-1/4 L	1.000 ea
14PA1000	PACKAGING 314 GROUP COMBINED PRINT	1.000 ea
HW1000A32	5/16 FL WASHER WIDE, ID=.344, OD=1.125	3.000 ea
032509020C	CARRIAGE BOLT - 360	3.000 ea

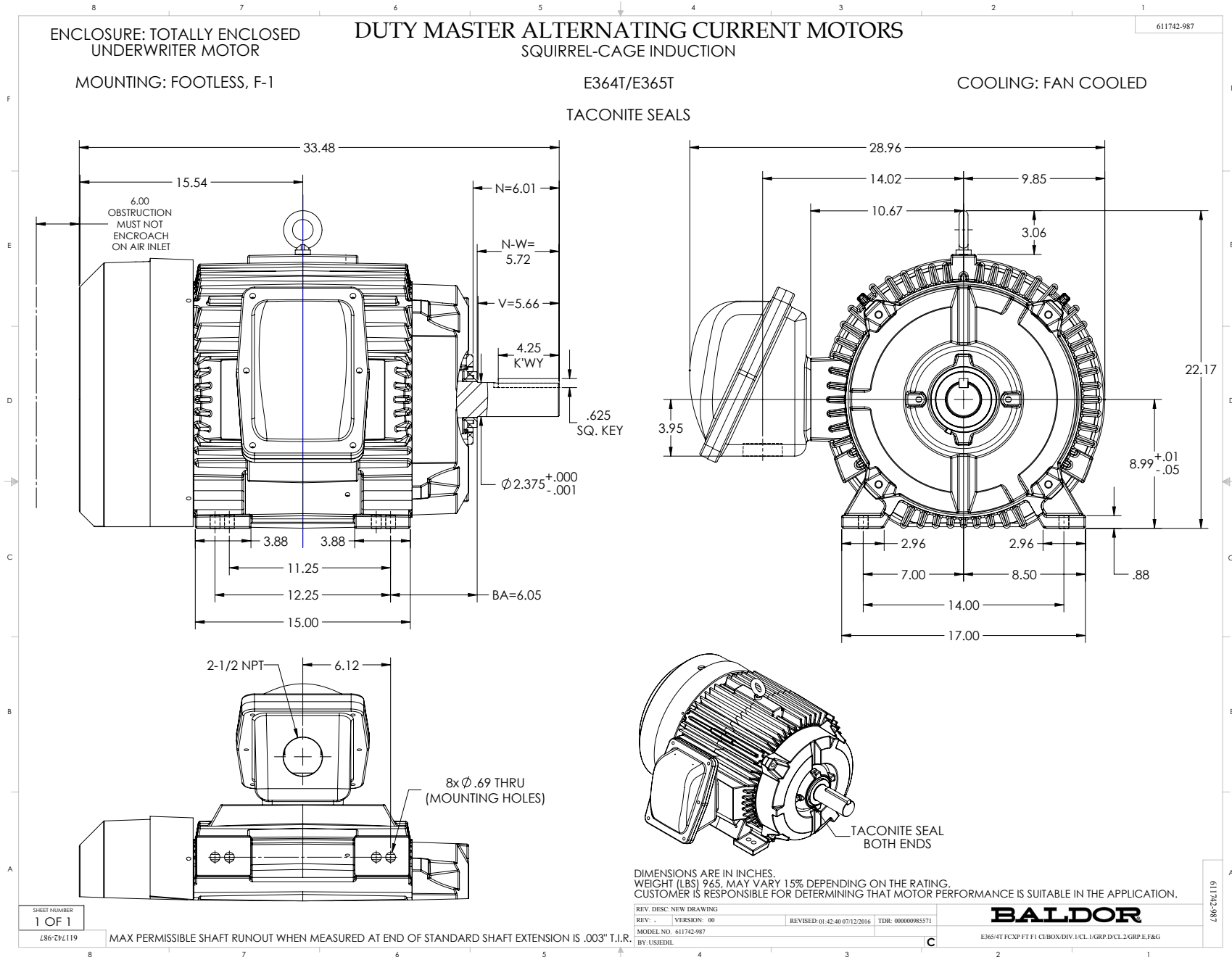

CONNECTION DIAGRAM ACCESSORIES

MOTOR WINDING THERMOSTATS	
CONTACTS _____ @ _____ °C	
FIGURE NUMBER _____	
CONTACT RATING	
VOLTS	CONTINUOUS AMPERES
110-120	3.0
220-240	1.5
440-480	0.75
550-600	0.60
	INRUSH AMPERES
	30
	15
	7.5
	6.0

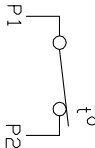
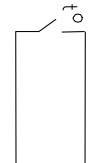
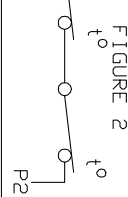
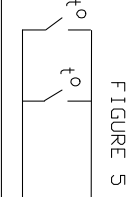
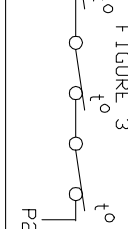
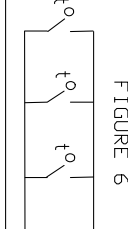
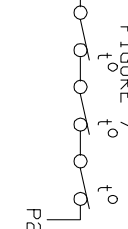
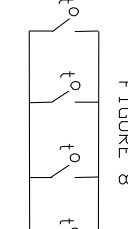
NORMALLY CLOSED	THERMOSTATS	NORMALLY OPEN
 <p>FIGURE 1</p>		 <p>FIGURE 4</p>
 <p>FIGURE 2</p>		 <p>FIGURE 5</p>
 <p>FIGURE 3</p>		 <p>FIGURE 6</p>
 <p>FIGURE 7</p>		 <p>FIGURE 8</p>

CUSTOMER _____

CUSTOMER
ORDER NO. _____

S.O. NO. _____

418174-006

418174-006

REV. DESC: LOADED TO BUS		
REV. LTR: A	VERSION: 01	TDR: 000000570390
FILE: \RAG\00013\849	REVISED: 10:16:21 12/07/2010	BY: RAGDRF
MTL: -		

BALDOR

A-C MOTOR CONNECTION ACCESSORIES

SH 1 of 1

416820-002

A-C MOTOR
 CONNECTION DIAGRAM
 STANDARD 9 LEAD DELTA-CONNECTED

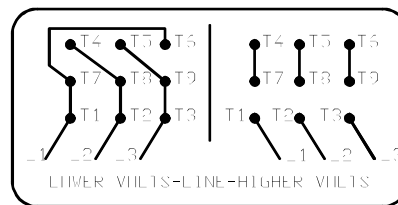
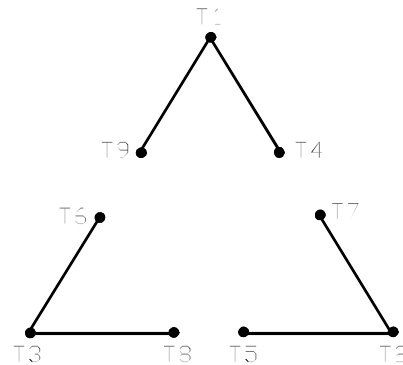

(N.P. 1575-B)

416820-002

REV. DESC: FONT CHANGE FOR PDF SEARCHABLE		
REV. LTR: A	VERSION: 01	TDR: 000001009382
FILE: \MGA\00000\661	REVISED: 02:46:19 02/13/2020	BY: MGHMTT
MTL: -		© □

BALDOR - RELIANCE®

CONN DIAG - STANDARD 9 LEAD, DELTA-CONNECTED

SH 1 of 1